



UNIVERSITY OF LEEDS

This is a repository copy of *Influence of ambient temperature on cold-start emissions for a Euro 1 SI car using in-vehicle emissions measurement in an urban traffic jam test cycle*.

White Rose Research Online URL for this paper:
<http://eprints.whiterose.ac.uk/2042/>

Book Section:

Andrews, Gordon E., Li, Hu, Wylie, James A. et al. (3 more authors) (2005) Influence of ambient temperature on cold-start emissions for a Euro 1 SI car using in-vehicle emissions measurement in an urban traffic jam test cycle. In: General Emissions 2005. Society of Automotive Engineers , USA , pp. 133-154. ISBN 0-7680-1589-8

SAE Paper # 2005-01-1617

Reuse

See Attached

Takedown

If you consider content in White Rose Research Online to be in breach of UK law, please notify us by emailing eprints@whiterose.ac.uk including the URL of the record and the reason for the withdrawal request.



eprints@whiterose.ac.uk
<https://eprints.whiterose.ac.uk/>



Leading Our World In Motion

**SAE TECHNICAL
PAPER SERIES**

2005-01-1617

Influence of Ambient Temperature on Cold-start Emissions for a Euro 1 SI Car Using In-vehicle Emissions Measurement in an Urban Traffic Jam Test Cycle

Gordon E. Andrews, Hu Li, J. A. Wylie and Grant Zhu

Energy and Resources Research Institute
School of Process, Environmental and Materials Engineering
The University of Leeds

Margaret Bell and James Tate

Institute for Transport Studies
The University of Leeds

Reprinted From: **General Emissions 2005
(SP-1944)**

ISBN 0-7680-1635-5



9 780768 016352

SAE *International*[™]

**2005 SAE World Congress
Detroit, Michigan
April 11-14, 2005**

The Engineering Meetings Board has approved this paper for publication. It has successfully completed SAE's peer review process under the supervision of the session organizer. This process requires a minimum of three (3) reviews by industry experts.

All rights reserved. No part of this publication may be reproduced, stored in a retrieval system, or transmitted, in any form or by any means, electronic, mechanical, photocopying, recording, or otherwise, without the prior written permission of SAE.

For permission and licensing requests contact:

SAE Permissions
400 Commonwealth Drive
Warrendale, PA 15096-0001-USA
Email: permissions@sae.org
Tel: 724-772-4028
Fax: 724-772-4891



For multiple print copies contact:

SAE Customer Service
Tel: 877-606-7323 (inside USA and Canada)
Tel: 724-776-4970 (outside USA)
Fax: 724-776-1615
Email: CustomerService@sae.org

ISSN 0148-7191
Copyright © 2005 SAE International

Positions and opinions advanced in this paper are those of the author(s) and not necessarily those of SAE. The author is solely responsible for the content of the paper. A process is available by which discussions will be printed with the paper if it is published in SAE Transactions.

Persons wishing to submit papers to be considered for presentation or publication by SAE should send the manuscript or a 300 word abstract to Secretary, Engineering Meetings Board, SAE.

Printed in USA

Influence of Ambient Temperature on Cold-start Emissions for a Euro 1 SI Car Using In-vehicle Emissions Measurement in an Urban Traffic Jam Test Cycle

Gordon E. Andrews, Hu Li, J. A. Wylie and Grant Zhu

Energy and Resources Research Institute
School of Process, Environmental and Materials Engineering
The University of Leeds

Margaret Bell and James Tate

Institute for Transport Studies
The University of Leeds

Copyright © 2005 SAE International

ABSTRACT

The influence of ambient temperature on exhaust emissions for an instrumented Euro 1 SI car was determined for urban congested traffic conditions. In UK cities cold-starting vehicles directly into congested traffic conditions is a common occurrence that is not currently taken into account when modeling urban traffic pollution. In-vehicle emission samples were taken directly from the exhaust, upstream and downstream of the catalyst, using the bag sampling technique. The first bag was for the cold start emissions and approximately the first 1.1 km of travel. The following three bags were with a hotter catalyst. The cold start tests were conducted over a year, with ambient temperatures ranging from 2°C to 30°C. The results showed that CO emissions for the cold start were reduced by 70% downstream of the catalyst when the ambient temperature rose from 2°C to 30°C. The corresponding hydrocarbon emissions were reduced by 41% and NO_x emissions were increased by 90%. The influence of ambient temperature was less when the catalyst was fully warmed up. The results showed that ambient temperature had a greater influence on cold start emission under traffic jam conditions than in previous work with real world driving closer to the ECE passenger car drive cycle.

INTRODUCTION

In Europe, the USA and Japan passenger car emission regulations are for a cold start. However, this is defined at a summer's day temperature of 25°C and much lower temperatures are experienced in winter in many areas of the world. The impact on air quality of these lower cold start temperatures has led to the introduction of a -7°C cold start emissions test in Europe and the USA. In Europe all cities have to meet defined European air quality standards and must declare air quality management areas (AQMA) if they exceed these air quality standards. In an AQMA the city has to take action to determine the cause of the exceedence and has the power to introduce measures to reduce the emissions. In the UK nearly all cases where an AQMA has been declared has involved traffic pollution as the cause of the exceedence.

Currently traffic pollution is modeled using the emission factors from the legislated tests using the ECE passenger car test cycle. By knowing the number of cars traveling in a city of Euro 0, 1, 2, 3 and 4 emissions class an estimate of the total mass emissions for each road can be made. The traffic density is recorded on the major roads into most large European cities. This data is then fed into a dispersion model, with the computation of the major secondary pollutant ozone. These models are

then used to predict how particular traffic management procedures would influence emissions.

However, the current procedures rely on the regulated emissions data for vehicles being representative of vehicle movement in particular cities. This is rarely the case and most cities have congested traffic conditions that result in higher emissions than the ECE test cycle and a greater sensitivity to cold start effects. In densely populated European cities houses are located alongside major commuter roads into cities. Every morning each house has at least one vehicle cold start directly into congested traffic. In the evening there is a second cold start back into congested traffic on the return trip home. In many cases the journey of a few kilometers is undertaken entirely under congested traffic conditions. This is the situation investigated in the present work. For emissions where cold start is of significance the ambient temperature is also a factor and this was an important variable in this work. The aim was to provide more relevant data on traffic emissions so that cities could more realistically model the air quality consequence of particular traffic management schemes.

This project is part of a major study of real world emissions and the traffic control and road system impacts on real world vehicle emissions. In the present work the important influence of ambient temperature on urban passenger SI car emissions is investigated, as current data for legislated emission tests is all at 25°C, which is rarely seen in the UK. The present work uses a high traffic density city street drive cycle to estimate emissions for a Euro 1 vehicle.

EURO 1 emission regulations come into effect from 1992 and set limits for petrol passenger cars as 0.97 g/km for HC plus NO_x and 2.72g/km for CO emissions. A Euro 1 petrol car was used as there are still significant proportions of the UK vehicle fleet and hence major contributors to air pollution in cities. Future work will investigate Euro 2, 3 and 4 vehicles. It takes about 16 years for 90% of vehicles sold in any one year to be no longer in use (1) and this period are becoming longer for modern vehicles. Thus the work on Euro 1 vehicles has significance in terms of their current use in city driving and hence their impact on air quality. It will be at least 2013 before 90% of Euro 1 vehicles are not a significant proportion of city traffic.

It is well known that a SI engine in cold condition has much higher exhaust emissions than one in fully warmed up condition. Extensive researches have been carried out worldwide on engine cold start and transient emissions. The new European test cycle conditions have since 2000 included the initial idle period for the ECE driving cycle in the cold-start. This was excluded for Euro 1 and Euro 2 vehicles, but these emissions are released into urban air in every cold start each morning and evening in commuter traffic. In the present work emissions are sampled from the first start of the engine for Euro 1 vehicles.

The cold start characteristics of SI engines are strongly dependent upon ambient temperature. The extensive research had been done in the past to investigate the influence of ambient temperature on exhaust emissions (1-15). It is reported that exhaust emissions could be increased tremendously at cold ambient conditions. For instance, the hydrocarbon emissions could be increased by 650% at -20 °C and carbon monoxide emissions could be increased by 800% at -20 °C, compared to standard certification values at +25 °C (8, 9). A good start is very difficult to achieve at sub-zero ambient temperature conditions, especially when the vehicle is soaked in cold atmosphere such as parked outdoors overnight in winter.

The authors (7) have investigated the influence of ambient temperature on real-world emissions for the present Euro 1 vehicle for road conditions that were relatively free moving. The real-world test cycle that was used was similar to the ECE cycle, but had more accelerations and decelerations. It was based on a 1.45 km rectangular route that was repeated four times, with the first lap being the main cold start. This was very similar to the four repeats of the three phases of the ECE drive cycle. In this work the comparison of 30°C and -2°C cold start emissions showed a factor of 6 increases in CO and a factor of 3.5 increases in HC emission at the lower temperature compared with the 30°C and virtually all of this increase occurred below 15°C. The influence of cold temperatures on NO_x was much lower and more complex as cold temperatures increase engine heat losses and cool the flame, thus reducing engine out NO_x. This partially offset the slower catalyst light off.

The low ambient temperature can reduce lubricating oil pumpability and increase viscosity of lubricating oil and thus results in higher mechanical losses for engine's cold start. The performance of battery would be affected by low ambient temperature. The air and fuel mixture can be affected due to the poor volatility of fuel at low ambient temperature and therefore cause deterioration of combustion quality. The lower the ambient temperature, the richer the air fuel mixture required for a start up. Incomplete combustion with excess fuel results in increased carbon monoxide and hydrocarbon emissions. The low ambient temperature can also delay the light-off of the catalyst, which is one of the most important reasons accounted for high emissions at cold start.

The most convenient way to investigate impact of the cold start and ambient temperature on exhaust emissions is to use dynamometer on standard test procedures under specialized facilities. However, there are some limits for this sort of test as they can not represent the whole vehicle response to cold start, including gearbox and cold tire effects. Although the legislated CVS test procedure can be included in a cold chamber, the cost of these is high and they are generally fully utilized for legislated test cycle work. Therefore

attention has been directed in this work on real world on road test in winter to complement dynamometer test (8). This work uses the variation of ambient temperature throughout the year to enable real world emissions for the same urban traffic jam drive cycle to be determined as a function of ambient temperature.

This work is part of a major research project RETEMM (REal-world Traffic Emissions Measurement and Modeling), which is part of the LANTERN research program (Leeds health Air quality, Noise, Traffic, Emissions Research Network). One of the purposes of the RETEMM project is to investigate the emission characteristics under real world driving conditions, including the influence of ambient temperatures, driving cycles, traffic conditions, and vehicle emissions control technologies.

EXPERIMENTAL

TEST VEHICLE – A Ford Orion petrol car was used fitted with a port fuel injected 1.8 liter Zetec spark ignition engine with DOHC 4 cylinders 16 valves. The car was instrumented with 27 thermocouples, which measured the air inlet, engine cooling and lubricating oil temperatures. In addition the exhaust metal, gas and catalyst temperatures as well as the ambient temperature were also measured. All temperature measurements used grounded junction mineral insulated Type K thermocouples.

Table 1 identifies the thermocouples by number location and function. These numbers are used in the graphical presentation of the warm-up temperature results in real-world driving. Figure 1 shows the schematic view of the thermocouple locations on the test car and Figure 2 shows the outline of the data logging system that was used. The total scan number was 480 during the 16 minutes of each test period, which was equivalent to one scan every two seconds. A Brantz International 2S Speed and Trip meter was used to measure vehicle's travel speed and distance, which was connected to a Daqbook/200 data logger along with all 28 thermocouples. The data logger was then connected to a Toshiba notebook PC.

Table 1 Thermocouple locations and functions

The number of thermocouple	The measuring target
1,2,3,4	Engine out gas temperatures from each cylinder.
5M,6M,7M,8M	Metal temperatures at four different locations on the manifold to monitor overall thermal profile on manifold
9, 10	Coolant water in and out from the engine
11W,12W,13W	Upstream TWC face temp. on left, right and centre positions.
14G,15G,16G	Gas temperature at the upstream (14), between the two catalyst bricks (15) and downstream of the TWC (16).
17W,18W,19W	Downstream TWC face temp. on left, right and centre positions
20,21	Engine oil in sump bottom (20) and dipstick top layer (21)
22M,23M,24M	Metal temperatures along the down-pipe
25G,26G,27G	Gas temperatures along the down-pipe
28 (not shown in graph)	Ambient temperature

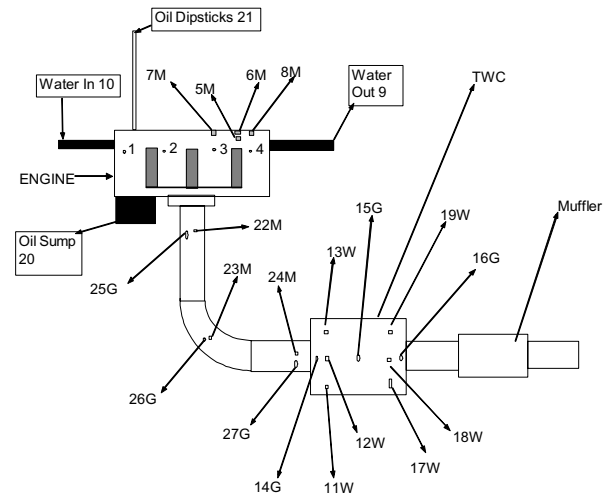

Figure 1 Schematic view of thermocouple locations

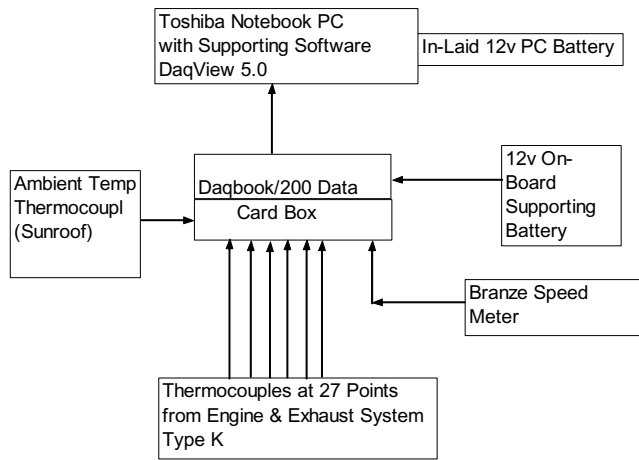

Figure 2 On board data logging system

EXHAUST SAMPLING SYSTEM – Direct exhaust pipe samples were taken through unheated stainless steel tubes inserted just upstream and downstream of the TWC (Three Way Catalyst). The layout of the gas sampling system is shown in Figure 3.

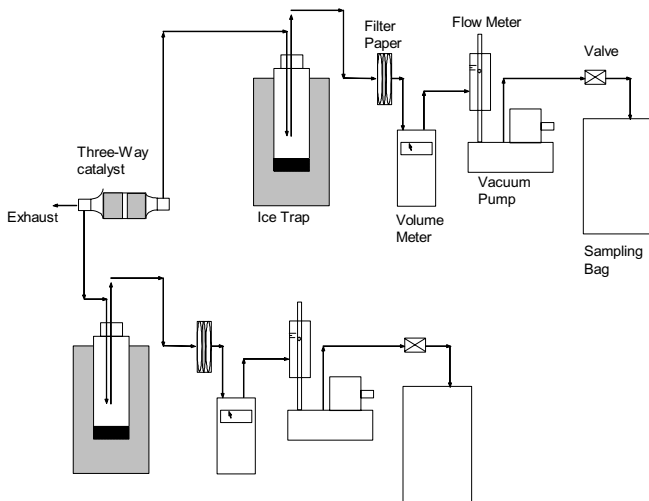

Figure 3 Schematic view of exhaust sampling system

Exhaust gas samples were taken simultaneously from both gas sample points and the samples were fed through the floor of the vehicle and through an ice trap for water and unburnt liquid fuel condensation. The condensate could be used to separate the ‘liquid’ unburnt hydrocarbons from the gaseous unburnt hydrocarbons that passed through to the bag sample. The sum of the two hydrocarbon measurements added together gives the total hydrocarbons. The analysis of this condensate is not reported here, but its detailed GC and GC-MS analysis will be reported separately. This condensate allows a 200+ speciation of the VOCs that are condensable at the ice bath temperature. This work showed that the gaseous bag sample contained typically 70% by mass of the total unburnt hydrocarbons. GC analysis of the bags was used to show that typically 10% of the bag hydrocarbons were methane.

After the ice bath water and hydrocarbon trap a particulate filter paper was mounted. This was used to provide a clean sample into the sample bags and also for particulate mass measurement and subsequent particulate analysis. The particulate analysis results using this system will be reported separately. Ahmad and Andrews (17) have already used a similar system for SI particulate analysis on a Zetec engine on a dynamometer test bed.

After the particulate filter the dry clean exhaust sample was passed through a dry gas meter and then through a diaphragm pump to a 60 liter Tedlar (inert surface and light free) sample bag, where a gaseous sample for the whole sample period was collected. The dry gas meter was required to quantify the filter paper mass in units of g/m^3 . Each bag was flushed out with nitrogen for about an hour. Test analysis showed that this procedure resulted in no residual gases that could be detected on the standard bag gas analysis equipment. The removal of water and condensable hydrocarbons in the ice bath condenser ensured that the high molecular weight hydrocarbons that often are difficult to remove from sample bags, did not reach the bags.

For each section of the traffic jam test journey, a separate sample bag was collected upstream and downstream of the catalyst. For each cold start test there were eight 60 liter gas sample bags, these were immediately taken after the test to the gas analysis system for conventional exhaust gas analysis.

It was a requirement of the present work that the impact of ambient temperature on the cold start phase of the emissions was resolved and this required that the emissions for the first stage of the cold start journey were determined in a separate bag. The gas analysis system required a sample flow rate of 20 liters per minute and it took a minute for all the analyzers to stabilize. The bag gases were then taken as the average of the gas analyzer outputs over the next minute. This resulted in a minimum requirement for a reliable bag gas analysis of 40 liters.

It would be preferable if the bag sample could be collected by exhaust flow driven by the back pressure from the exhaust, as this would be proportionate exhaust gas sampling. Andrews and Hu Li et al (18, 19) have shown that reliable results can be obtained for longer bus and truck journeys using the exhaust back pressure sampling method with no pump in the sample circuit. However, this was for journey times of typically 30 minutes and the desired sample period in the present work was about four minutes for each bag.

The use of the constant flow gas sample pump in the present work was to ensure that sufficient gas sample were collected in a short time, which was not possible using the back pressure gas sample technique. The bag constant sample flow rate was 9-10 l/min and the exhaust mass flow rate was varying throughout the test

period. The bag sample was thus biased, with more samples from the low exhaust mass flow parts of the test cycle (low power) and less samples from the high exhaust mass flow parts of the test cycle. However, in city driving in speed limited street areas, only a small part of the engine power range was used and hence this sample bias was not as large as for journeys that would use a greater proportion of the engine power range. The net effect of the non-proportionate sampling was to increase the CO and HC emissions and decrease the NO_x emissions as these are generated more at low and high powers respectively. However, the results show that the HC, CO and NO_x emissions are as expected for a Euro 1 vehicle at 25°C cold start conditions. This indicates that the sample bias in this work did not have a major impact on the measurement of the ambient temperature effect under real world urban cold start driving.

At the time that this work was undertaken there were no commercially available reliable in-vehicle emissions analysis systems available. Such systems have recently been developed and two of these are currently in use in this research group. Also in-vehicle emissions analysis systems have to be combined with an in-vehicle exhaust mass flow measurement system and these have only recently become available.

GAS ANALYSIS SYSTEM – The exhaust gas sample from the sample bags was analyzed using a conventional heated engine exhaust emissions analysis system using heated pumps and a heated FID at 180 °C for total hydrocarbon analysis. A Chemiluminescence analyzer was used for NO and NO₂ analysis, a Servomex Paramagnetic analyzer for Oxygen analysis and a Hartman & Braun Uras 10E for CO, CO₂, CH₄ and N₂O analysis. As the bag sample was after a water and UC ice trap, all the samples were on a dry gas basis. All the concentrations were converted to a wet gas basis before conversion into mass emissions. The sample bag mean air/fuel ratio was also determined from the bag exhaust gas analysis by the carbon balance method.

MASS EMISSIONS – The sample bag emissions analysis was on a volumetric basis and this was converted into a mass basis using the conventional method for the computation of emission index (EI -g/kg fuel).

$$EI = K \times C \times (1 + A/F) \times 1000 \text{ g/kg fuel}$$

Where K is conversion coefficient, which is the ratio of molecular weight for a certain emissions component to the whole emission sample gases.

C is the concentration of a certain component of the emissions on a volumetric basis.

A/F is the bag mean air/fuel ratio determined by carbon balance method based on wet gas analysis composition.

The gas concentrations were converted from a dry to wet basis prior to the calculation of the EI. If the concentration C was measured in ppm or % then the above equation has to be multiplied by 10⁻⁶ or 10⁻² respectively. The molecular weight of the sample gases is close to that of air and does not vary by more than 1% for gasoline as the fuel, irrespective of the A/F. Thus for each emission component, K is a constant and is 0.555 for methane (HC measured as methane equivalent), 0.971 for CO, 1.595 for NO₂ (all NO_x counted as NO₂), 1.526 for N₂O and 1.526 for CO₂.

The EI could be converted into emission units of g/km if the fuel consumption during the sample period was known. The accurate fuel consumption was not determined in this work for each bag sample, but the total fuel consumption over the whole test circuit was determined by adding fuel to the tank to return it to the level at the start of the tests. All the test results are therefore presented in terms of an EI, as this was the measured mass emissions parameter.

TEST ROUTE – An urban congested traffic driving cycle was designed and coded as LU-TJTC: the Leeds University Traffic Jam Test Cycle. Figure 4 shows the route of the test cycle. Leeds has a high urban population density of around 1,300/km² and there are quite a few main roads with heavy traffic flow daily. The route in Figure 4 is one of the typical congested main urban commuter roads streets in Leeds. The journey from the University to West Park Roundabout is outgoing from the city and the tests were conducted in the evening rush hours. The returning journey from the West Park Roundabout to the University forms another test cycle, which represents incoming to city journey. The car was started from cold after at least an 8 hour cold soak period in the open at ambient conditions. The cold soak position at the University was about 150m from the congested urban road and effectively this was a cold start into congested traffic. The distance traveled was 4.4 km. It passed 5 crossroads with traffic lights, 6 pedestrian lights and 9 give way junctions.

The cold start bag sample was started at the same time as the car by switching the sample pump on, immediately after successful ignition of the engine had been achieved. The cranking phase of the cold start was not sampled. This is as close as possible to the new Euro 3 test procedures as could be achieved in real world cold start driving.

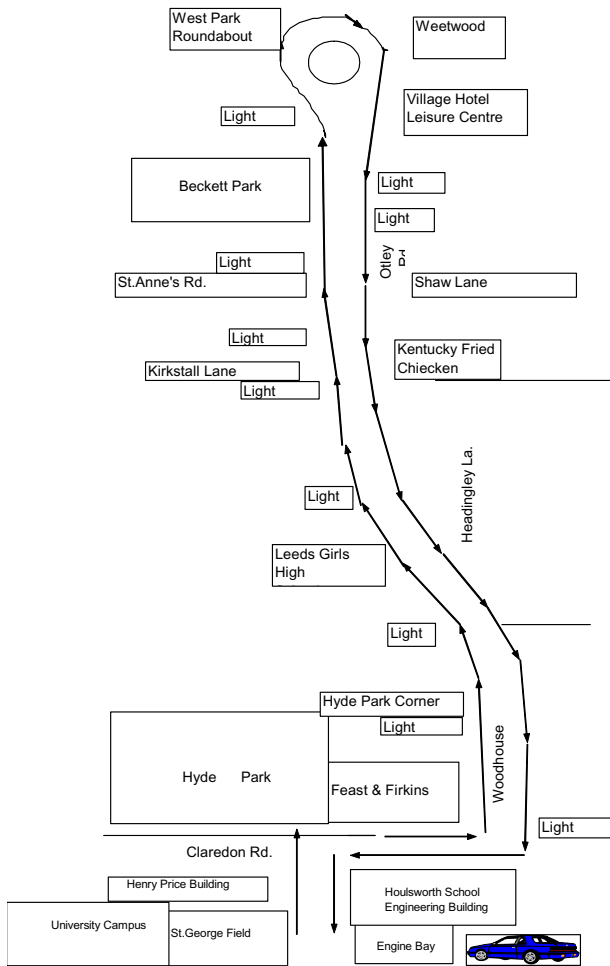

Figure 4 Test route of LU-TJTC

The 4.4 km LU-TJTC cycle was a generally uphill route and involved 10~12 idles, 12~14 times of very low speed slow down at about 5 mile/h, 10~14 times of low speed driving at about 15 mile/hr and a couple of normal speed driving at around 20~30 mile/h. The journey was split into four roughly equal stages of about 1.1 km and each stage had a separate exhaust emissions bag sample taken upstream and downstream of the catalyst. At each bag change over the vehicle was brought to a halt and then restarted in the traffic with the new bag sampling. It took about a half minute to change over both bags. Under traffic jam conditions there were many stop/start maneuvers and these stops to change the bags were not a major departure from the normal traffic movement conditions.

Figure 5 shows the two typical profiles of driving modes of LU-TJTC cycle. From start to point D it involved low speed moving and stops with many accelerations and decelerations, which reflected the traffic queuing condition. After the point D, the traffic load was lighter and the driving was smoother with less accelerations and decelerations. The car cruised by a speed of 20~30 km/h.

Table 2 represents the statistical analysis of LU-TJTC with a comparison with the ECE 15 (Urban Driving Cycle) and the previously tested real world cycle (7) the Leeds University Urban Driving Test Cycle (LU-UDTC). It shows that the LU-TJTC had the lowest average speed and lowest maximum speed. For all three cycles the average acceleration and deceleration were at a similar level. However, the maximum acceleration and deceleration were much higher for the two real world cycles, compared to the ECE urban driving cycle. Figure 6 shows the comparison of acceleration and deceleration of the LU-TJTC and ECE 15 cycles. This shows that LU-TJTC had more frequent and sharp accelerations and decelerations.

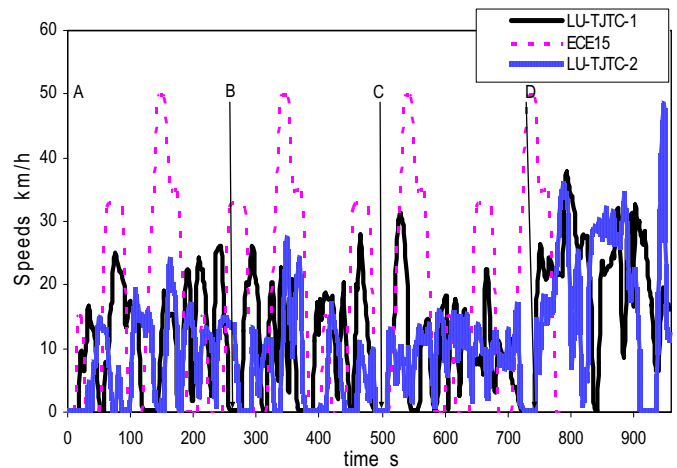

Figure 5 Typical profiles for LU-TJTC driving mode

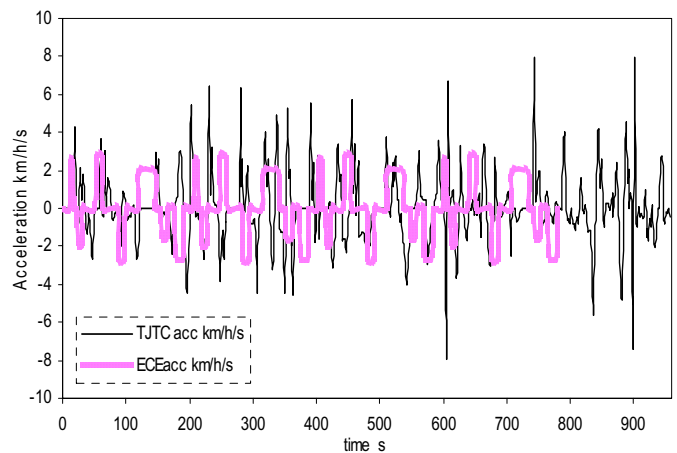

Figure 6 Typical profiles for acceleration of LU-TJTC

Table 2 Statistical analysis of test cycles

	LU-TJTC	LU-UDTC	ECE 15 (UDC)
Total distance km	4.35	5.8	3.75
Duration s	960	832	784
Average speed km/h	16.31	25.05	17.22
Max. speed	37.8	48	49.6
Average acceleration km/h/s	2.0	2.27	2.32
Max. acceleration km/h/s	7.97	6.	2.67
Average deceleration km/h/s	-1.44	-2.19	-2.17
Max. deceleration km/h/s	-7.73	-8.16	-2.67
Idle time %	16.0	10.1	28.6
Cruise time %	18.8	13.7	26.6
Acceleration time %	27.8	38.2	22.4
Deceleration time %	37.4	38	22.4

WARM-UP OF THE ENGINE AND EXHAUST SYSTEM

The engine out cold start influence on emissions is mainly due to the thermal inertia of the engine and the water and lubricating oil systems (10–15). The cold start influence on the catalyst performance is mainly due to the thermal inertia of the exhaust manifold, the downpipe and the underfloor catalyst. It was therefore important in this real world urban driving study of the influence of ambient temperature on cold start emissions, that the temperatures of the key engine and exhaust temperatures were recorded.

Two sets of typical results are presented below to show the comparison of engine and exhaust system between

winter and summer. The coldest (2°C) and hottest (30°C) ambient temperature test results are compared.

WARM UP OF COOLANT WATER AND ENGINE OIL – Figures 7 and 8 show the comparison of the warm up rate between winter and summer for the coolant water and engine lubricating oil. The results show that for LU-TJTC cycle in summer time the coolant water temperature reached the fully warmed-up value, when the thermostatic control valve opened, after nine minutes. This was about two and half minutes earlier than that in winter. The lubricating oil temperature reached the full warmed-up value in sixteen minutes in summer, two minutes earlier than that in winter. The full warm up of the water was taken as when the temperature of the water outlet from the engine reached 88°C and the thermostatic valve opened. This caused the temperature to decrease as the cold water in the radiator was added to the cooling water circulation.

The warm up period of the lubricating oil was taken as when the lubricating oil reached 80°C. Two lubricating oil temperatures were measured (T20 and T21), one close to the surface of the lubricating oil (dipstick, T21) and one close to the bottom of the sump (T20). The top temperature is higher than the bottom as the oil from its circuit around the engine is heated and hence accumulates on the top of the sump oil level. The oil pump picks up cold oil from the bottom of the sump. Hence the true lube oil warm-up temperature is that for the bottom of the sump (T20).

The difference in these temperatures is shown in Figures 8 and 9, which shows a much longer warm-up period for the oil at the bottom of the sump and a much greater difference in this temperature between winter and summer, than for the corresponding difference for the top of the sump oil temperature (T21). The comparison in Figure 8 is for the top of the sump temperature (T21). This temperature difference between the top and bottom of the oil sump was also found in engine dynamometer warm-up tests (10-15).

These results show that in summer the water is not warm until the middle of the test cycle (after about 2.2 km) and in winter this occurs in the two thirds of the test cycle (after about 3.3 km). For lubricating oil in summer the bottom of the sump oil warmed-up at the end of the test cycle and in winter it is not fully warmed-up by the end of the test cycle. For the short urban journeys that are common in cities these results show that the slow warm-up of the water and lubricating oil is a significant factor in the higher engine out emissions and fuel consumption under cold start, which are detailed below. Normally, the lube oil is unlikely to warm up in any short urban journey and this has a major impact on the higher fuel consumption in urban driving.

These water and oil warm-up times are greater than those reported previously (7) for the urban real world drive cycle LU-UDTC, which is closer to the ECE urban

test cycle. Also, there was a smaller influence of ambient temperature than in the previous work (7). The reason for this is the lower average power used in congested traffic-jam conditions. The thermal heat rejected into the cooling water and lubricating oil is thus lower and hence the water takes longer to warm-up. The very slow lubricating oil warm-up of 18 minutes has a very significant influence on the engine fuel consumption, through higher friction losses. In many urban commuter journeys the journey would be over before the lubricating oil was warm.

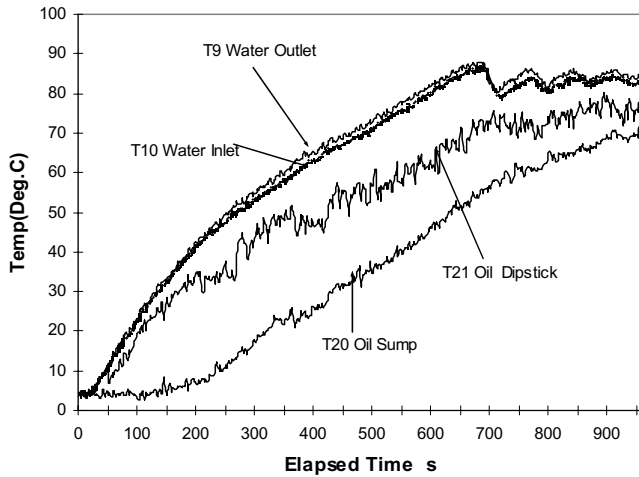

Figure 7 Warm up of coolant water and lube oil at ambient 2 °C

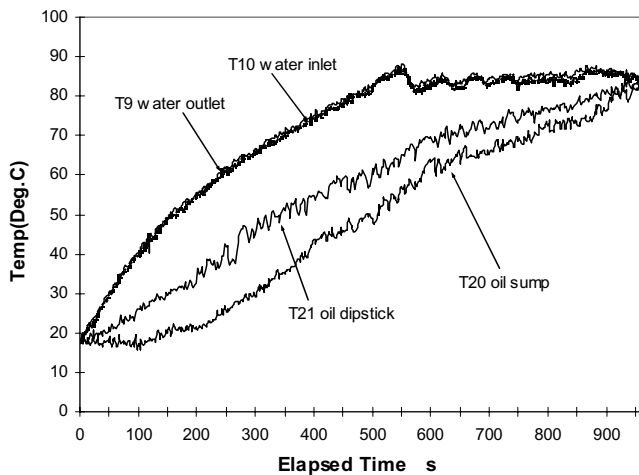

Figure 8 Warm up of coolant water and lube oil at ambient 30 °C

CATALYST INLET AND FACE TEMPERATURES AND LIGHT OFF – Figures 9 and 10 show for winter and summer conditions, the front face and rear face catalyst substrate temperatures on the center line and left hand side. The two temperatures were very similar for each face, although at the rear face when the catalyst was lit off one of the thermocouples was 50°C higher than the

other, indicating a spatial non-uniformity in the activity of the catalyst. This occurred in the winter and summer tests. When the catalyst is active the heat release from the oxidation of hydrocarbons and CO increases the gas and substrate temperatures.

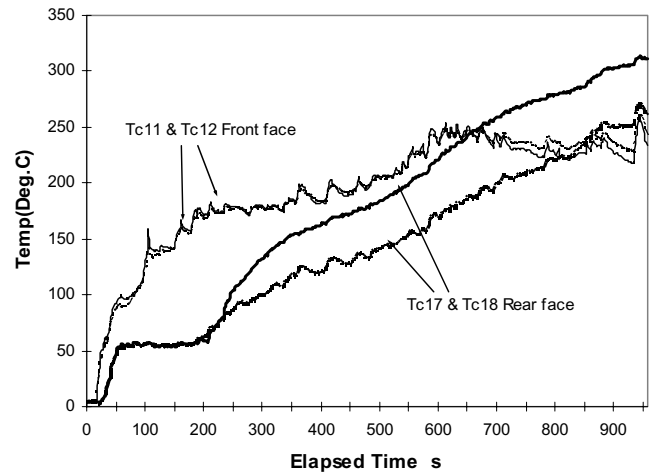

Figure 9 Front and rear face temperature of TWC substrate at ambient 2 °C

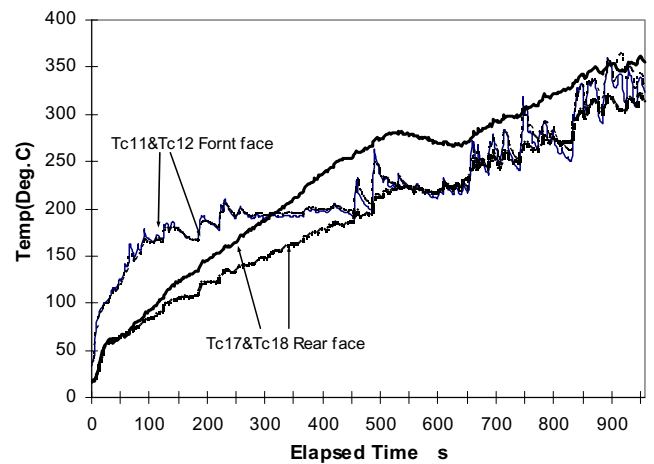

Figure 10 Front and rear face temperature of TWC substrate at ambient 30 °C

One method of determining the catalyst light off temperature is when the downstream catalyst substrate face temperature is greater than the front face temperature and reaches 250°C since this is the minimum temperature for the catalyst to be active. Figures 9 and 10 show that the time this occurs is 9 minutes for the summer and 14 minutes for winter test conditions. Many journeys in urban areas are short distance travels and experience congested low speed driving, and under these conditions Euro 1 vehicles have little catalytic exhaust emissions clean up. These catalyst substrate light off times are approximately twice those found in the previous work (7) for a more freely moving traffic conditions (LU-UDTC). This was because the engine powers required were lower and exhaust temperatures were lower at low powers. Thus there was less exhaust energy to heat the catalyst.

The gas temperatures were measured at the catalyst inlet (Tg14), between the two catalyst bricks (Tg15) and downstream of the catalyst (Tg16). The advantage of using these temperatures to determine the catalyst light off is that under cold start only the first catalyst brick is normally active, due to the lower exhaust mass flow rates at the low powers of the cold start urban cycles. Thus it is normally only the first brick that is heated in the first light off phase and hence the second brick acts as a thermal heat sink. This means that the downstream catalyst brick face may not be the best location to determine the catalyst light off. The centre thermocouple located between the two bricks is likely to be the best place to determine the catalyst light off using the temperature rise from catalytic activity.

The catalyst gas temperatures Tg14, 15 and 16 are shown in Figures 11 and 12 for winter and summer conditions. These results confirm that the central temperature between the two bricks rises to the highest temperature and demonstrates a clear catalyst light off, when compared with the inlet gas temperature. This central temperature is higher than the downstream temperature for most of the test period, indicating the effect of the thermal inertia of the downstream brick.

The catalyst light off temperature was also determined as the time at which the central gas temperature thermocouple Tg15 became hotter than the inlet gas temperature and was over 250 °C. The summer and winter light off times are therefore determined as 8.5 and 10.5 minutes in figures 11 and 12. Compared with Figures 9 and 10, the light off times determined by gas temperature show shorter light off times. Also, there is a smaller difference between summer and winter using the central gas thermocouple. These light off times are much greater than previously found (7) for the LU-UDTC, which were 2.7 and 2.0 minutes in winter and summer respectively. Again this much longer light off time was due to the lower exhaust temperatures at the lower engine powers of the TJTC.

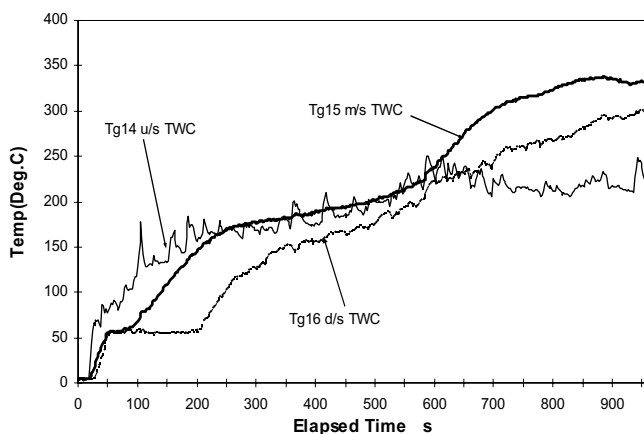

Figure 11 Exhaust gas temperatures across TWC at ambient 2 °C

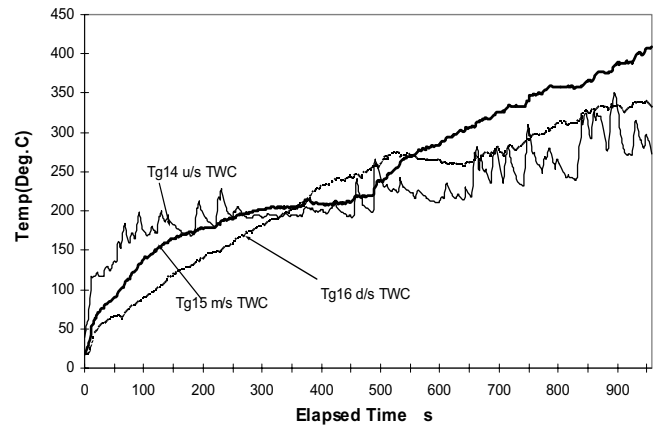

Figure 12 Exhaust gas temperatures across TWC at ambient 30 °C

COMPARISON OF EMISSIONS BETWEEN HIGH, MEDIUM AND LOW AMBIENT TEMPERATURE FOR THE FOUR STAGES OF THE TRAFFIC JAM TEST CYCLE

Each section of the Leeds traffic jam test cycle had an exhaust sample taken into a pair of bags. The composition of this represented the average emissions for that road journey. The detailed sampling procedures and their limitations have been discussed above. The emissions results are presented in the following graphs as a function of the number of the test sections, from the cold start bag 1 through bags 2 and 3 to the last bag 4, which is normally representative of the emissions with a fully warmed up engine and catalyst. The simultaneous measurement of the engine and catalyst out emissions also enabled the catalyst efficiency to be determined for each section of the traffic jam test cycle stages.

Three sets of test results were chosen to represent the typical emission characteristics at different ambient temperatures 2, 17 and 30 °C for winter; spring and summer under traffic jam driving conditions. The comparison of emissions between different ambient temperatures has been carried out.

HYDROCARBON EMISSIONS – Figures 13 and 14 show the comparison of HC emissions for upstream and downstream of the TWC. Figures 13a and 14a show the fractions of each bag HC emissions to total HC emissions for the whole cycle and accumulative fractions.

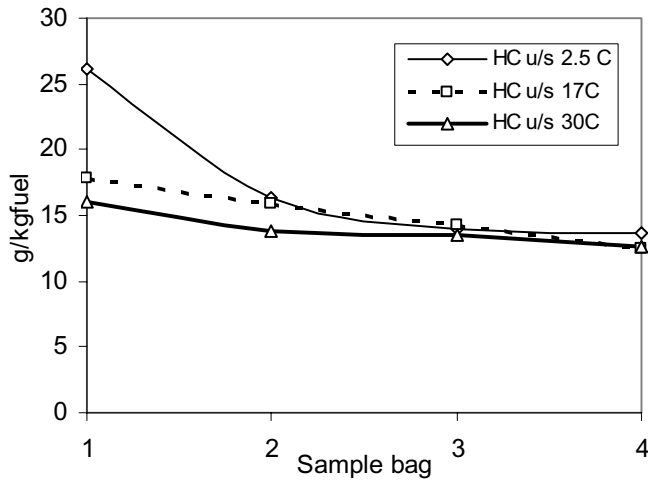

Figure 13 HC emissions (u/s) for each bag at different ambient temperature for LU-TJTC test

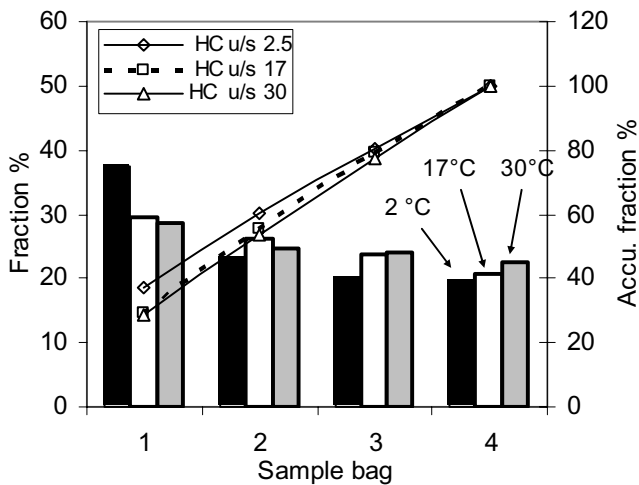

Figure 13a Fractions of each bag HC emissions (u/s) at different ambient temperature

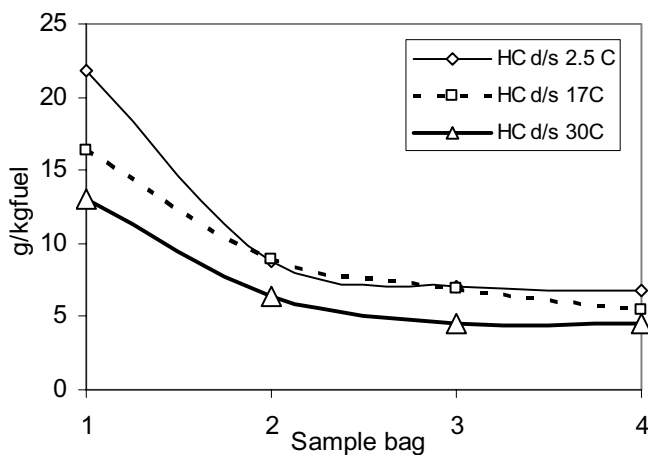

Figure 14 HC emissions (d/s) for each bag at different ambient temperature

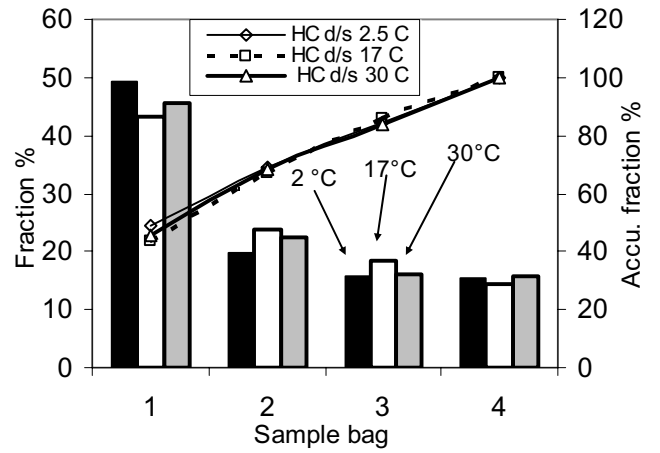

Figure 14a Fractions of each bag HC emissions (d/s) at different ambient temperature

Figure 13 shows that under winter conditions there was a 38% (9.87 g/kgfuel) reduction in the engine out HC emissions between the cold-start first section (A-B, bag1) and the emissions during the second section (B-C, bag2). This indicates the importance of engine water and lubricating oil warm up on the engine out cold-start emissions. A further reduction of 2.3 g/kgfuel in HC emissions occurred from the second phase to third phase of the test. For the medium and hot ambient temperature tests, the HC emissions reduced by 14% and 11% for the first section, showing a much lower influence of ambient temperature and engine warm up. Figure 14a shows that engine out HC emissions in the first phase took 30~40% of cycle total HC emissions, particularly high under winter condition.

Downstream of the TWC, there was a much stronger influence of the warm-up on HC emissions compared with that of the upstream emissions for all three ambient temperature results. This was because of the additional influence of the catalyst activity increasing with the warm-up time. Figure 14 shows that the HC emissions decreased by 60%, 55% and 50% for 2, 17 and 30°C respectively for the first phase of the test. A further reduction of 1.7 g/kgfuel in HC emissions occurred for the phase two of the test for all three ambient conditions. Figure 15a shows that the contribution of the first phase cold start HC emissions to total HC emissions was 40~50%, 10~15% higher than that upstream of TWC.

The catalyst conversion efficiencies for each phase of the Leeds traffic jam drive cycle were evaluated from the simultaneously sampled bag samples. The results of HC conversion efficiency, shown in Figure 15, shows the very poor conversion efficiencies during the first cold start phase (10~20%). The conversion efficiencies were increased to 40~50% during the second phase and there were small increases afterwards. The highest conversion efficiency only reached 65% in summer at 30 °C from the third phase onwards, which was about 12 minutes after start. For warm spring and cold winter

tests, the conversion efficiencies were only reached 50~55% from the third phase onwards.

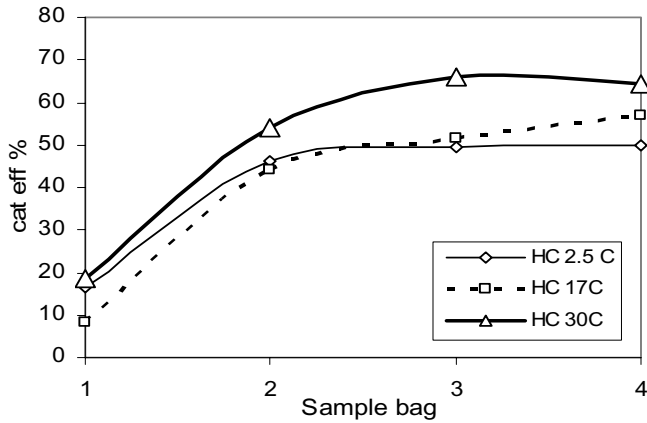

Figure 15 HC conversion efficiency of TWC at different ambient temperature for LU-TJTC test

CO EMISSIONS – Figure 16 shows the engine out CO emissions for the Leeds traffic jam test cycle under winter, spring and summer conditions. There was a large decrease in CO emissions for winter test. CO emissions decreased from 536 g/kg fuel for the first cold start phase to 200 g/kg fuel for the second phase, a reduction of 63% in the engine out CO emissions. A further reduction of 91 g/kgfuel (45%) occurred from the second phase to the third phase of the test. For the spring test result, smaller changes in CO emissions were found. The reductions in engine out CO emissions were 28% for the first phase of the test. For summer test, CO emissions reduced by 54% from phase one to phase two, which is close to the winter test and yet the mass reduction in the summer was much smaller than that in winter (100 g/kgfuel for summer and 236 g/kgfuel for winter). There were no further reductions in engine out CO emissions from the third phase onwards. Engine out CO emissions at 30°C were constantly lower than that at 17 and 2°C, showing ambient temperature effect on CO engine out emissions throughout the whole test cycle.

The fraction analysis (Figure 16a) shows that the cold start phase produced large percentages of total CO engine out emissions, showing the significant influence of cold start on the combustion process.

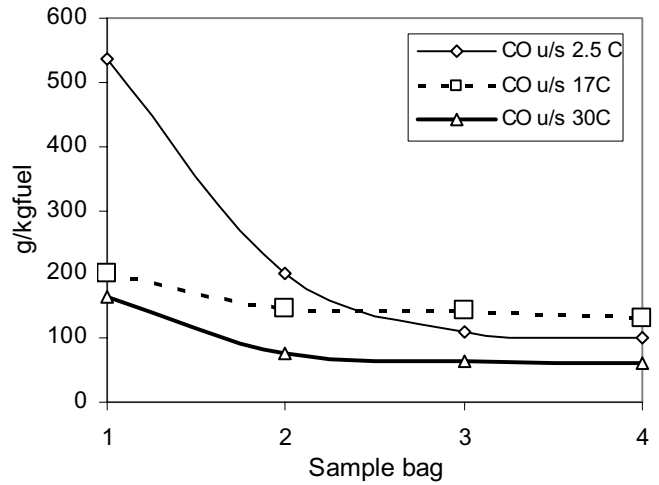

Figure 16 CO emissions (u/s) at different ambient temperature for LU-TJTC test

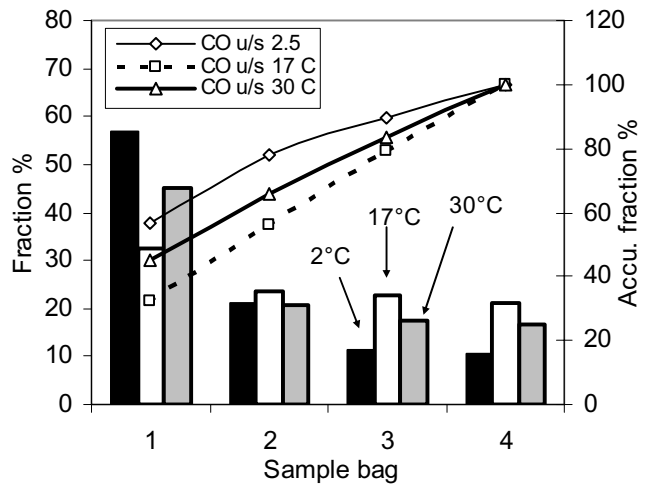

Figure 16a Fractions of each bag CO emissions (u/s) at different ambient temperature

Figure 17 shows the CO emissions downstream of the TWC at different ambient temperatures. For winter test, CO emissions decreased continuously from the first phase to the third phase. The reductions were 366 g/kgfuel or 73% from the cold start phase one to phase two and a further reduction of 94 g/kg fuel or 70% from phase two to phase three. For spring and summer tests, CO emissions reduced by about 80% from cold start to phase two and there were little reductions after phase two. Figure 17 demonstrates that the cold winter test had a longer warm up period for the catalyst.

Figure 17a presents the fraction analysis of each bag samples for downstream CO emissions. The results show that 60~70% of total CO emissions after the catalyst for the whole cycle was produced by cold start phase. The second, third and fourth phase only contributed less than 20% respectively. This is quite different from HC emissions and indicates the greater influence of cold start phase on catalytic conversions and CO emissions. This is mainly due to the fuel

enrichment used under cold start and high acceleration, which causes large increases in engine out CO, with the catalyst not active for CO in very rich periods.

Comparison with the real world urban drive cycle results (7) shows similar CO emissions for the first bag downstream of the catalyst for similar winter and summer temperatures. However by the third phase there was no influence of ambient temperature and CO emissions were below 10 g/kg. Figure 17 shows for the traffic jam cycle that there was still an ambient temperature effect with emissions of 20 g/kg under winter conditions and 10 g/kg in summer.

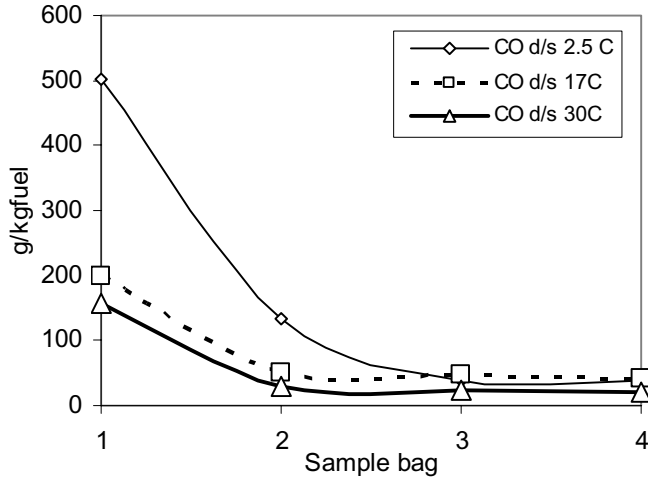

Figure 17 CO emissions (d/s) for each bag at different ambient temperature for LU-TJTC test

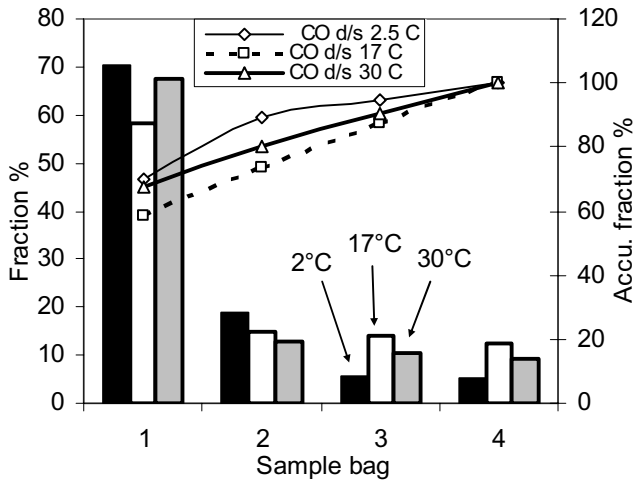

Figure 17a Fractions of each bag CO emissions (d/s) at different ambient temperature for LU-TJTC test

Figure 18 shows the catalyst CO conversion efficiency determined from the simultaneously sampled upstream and downstream bag samples. The conversion efficiency reaches the balance level (65%) from the second phase onward for spring and summer tests and takes longer period to reach the same level for winter test. The final conversion efficiency for all three tests under three different ambient temperatures is about

60~70%. The low conversion efficiency reflects slow catalyst warm up process for the Leeds traffic jam test cycle. Comparison with the freely moving Leeds urban test cycle (7) shows that the catalyst efficiency for bags 3 and 4 for LU-UDTC reaches 85% at -2°C and 80% at 31°C . The higher CO conversion efficiency for LU-UDTC is a reflection of that LU-UDTC is a more favorable test cycle for relatively freely moving real-world urban test cycle.

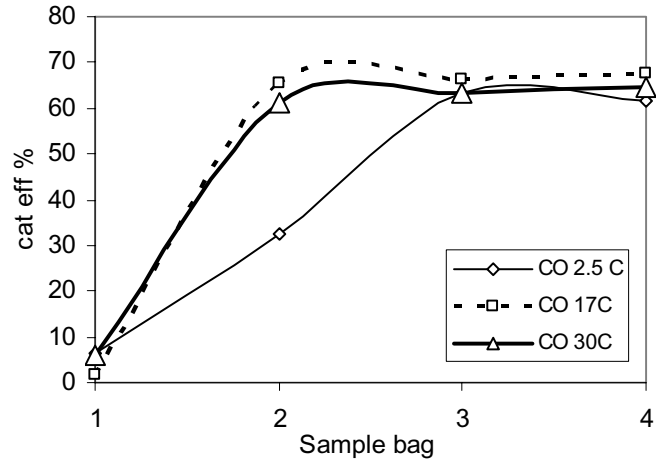

Figure 18 CO conversion efficiency of TWC at different ambient temperature for LU-TJTC test

ENGINE OUT COMBUSTION INEFFICIENCY – Under cold start the engine out HC and CO emissions contain significant energy content and hence make a significant contribution to the fuel economy deterioration under cold start conditions. The CO and HC emissions have been converted from an emission index (g/kg fuel) into the equivalent energy content and then divided by the fuel energy input to generate the combustion inefficiency. This is the combination of HC and CO mass emissions in energy terms. The results are shown as a comparison between winter, spring and summer conditions in Figure 19.

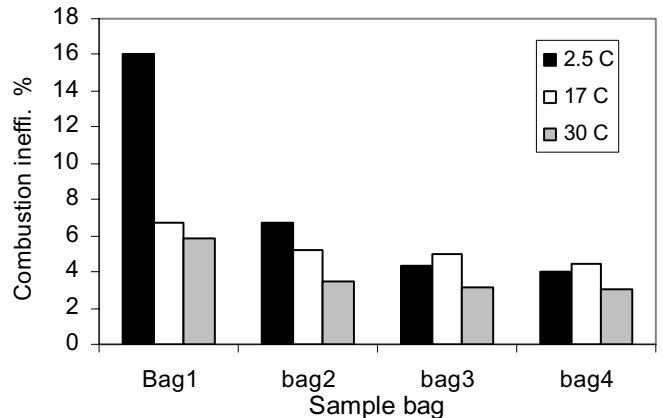

Figure 19 Combustion inefficiency at different ambient temperatures for LU-TJTC test

Figure 19 shows a major influence of the ambient temperature on the combustion inefficiency. 16% of the energy in the fuel is not released in the engine at 2°C cold start for the first section of the Leeds traffic jam cycle. In spring and summer this is down to 6~7%. Most of this inefficiency is due to the cold engine water, lubricating oil and piston temperatures during the first cold start. As shown above, in winter the water is hot by the end of phase 2 and the combustion inefficiency results show no further reduction for phase 3 and 4. In spring and summer the water is hot from phase 2 onwards. The combustion efficiency is higher in summer even on the fourth phase, indicating the impact of the ambient temperature on fuel economy through the whole Leeds traffic jam cycle. Very similar results were found (7) for the Leeds urban drive cycle and this is a reflection of relative insensitivity of the engine out emissions to the test cycle under low power conditions, with a greater sensitivity of the catalyst performance.

NOx EMISSIONS – Figure 20 shows the comparison of engine out NOx emissions for winter, spring and summer tests. The results show that engine out NOx emissions are reduced by cold starts. The lower air inlet temperatures and greater heat losses to cold surfaces both reduce the NOx emissions as they reduced the peak combustion temperatures. Thus the engine-out NOx emissions increase as the engine warms up. The increase was much greater in winter than in summer. NOx emissions increased by a factor of 4 from phase 1 to phase 3 in winter. There were no increases in NOx emissions until phase 3 in spring and summer tests. It is considered that to overcome the higher engine friction with the colder lubricating oil, the throttle had to be further open and this would increase the NOx emissions relative to those under spring and summer conditions.

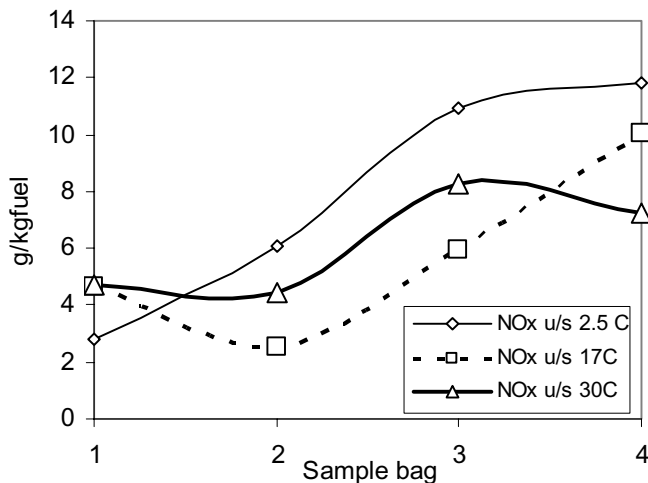

Figure 20 NOx emissions (u/s) for each bag at different ambient temperature for LU-TJTC test

Figure 20a presents the fractions of each sample bag to total upstream NOx emissions. The results show a low contribution of cold start and increasing fractions with increasing warm up, a reverse trend compared to HC

and CO trends. As the water warms up in the engine less heat is extracted from the combustion process, the flame temperature increases and this increases NOx.

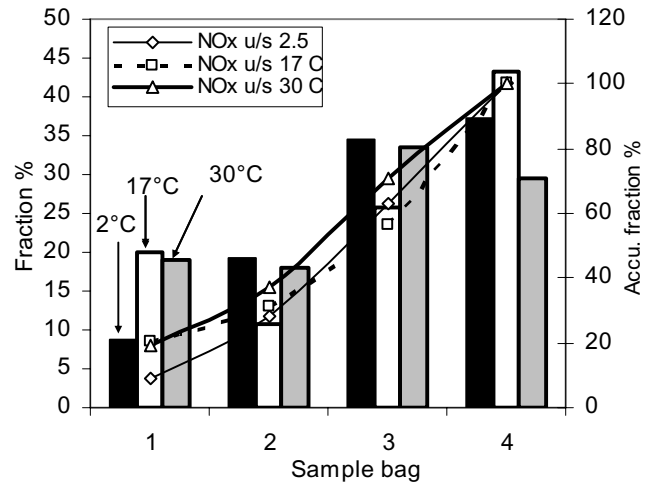

Figure 20a Fractions of NOx emissions (u/s)

Downstream of the TWC, NOx emissions were reduced significantly from the first cold start phase to the second phase for the spring and summer tests, indicating the start of catalytic activities, as shown in figure 21. This reduction in engine out emissions as the catalyst warmed up was much less than for HC and CO due to the opposite trend of engine out emissions with warm-up. The engine out NOx emissions were low when the catalyst was not working in the first cold start phase. The NOx emissions become stabilized from the third phase onwards for spring and summer tests. For winter test, there were no apparent reductions in NOx emissions throughout the test cycle and actually there was an increase in NOx in the third phase, which was due to the increase of engine out NOx emissions. The NOx emissions were at 1.5~2.0 g/kgfuel finally at the end of all three tests.

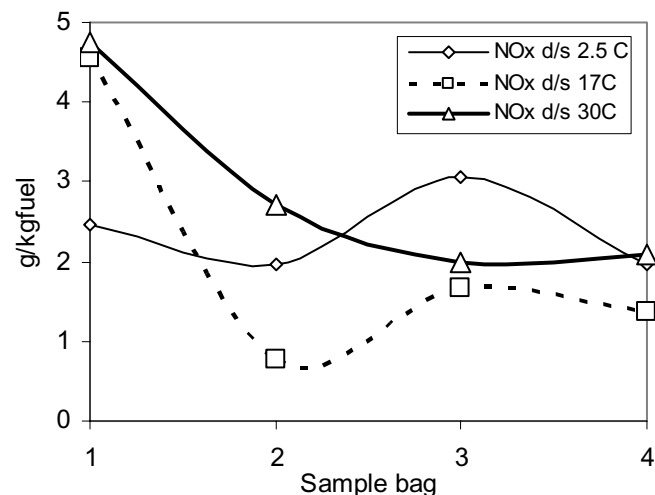

Figure 21 NOx emissions (d/s) for each bag at different ambient temperature for LU-TJTC test

Figure 21a shows the fraction analysis of downstream NOx emissions. The majority of NOx emissions are coming from the cold start phase for spring and summer tests, but not for winter. The low downstream NOx emissions for the first cold start phase in winter were due to low engine out NOx emissions in winter.

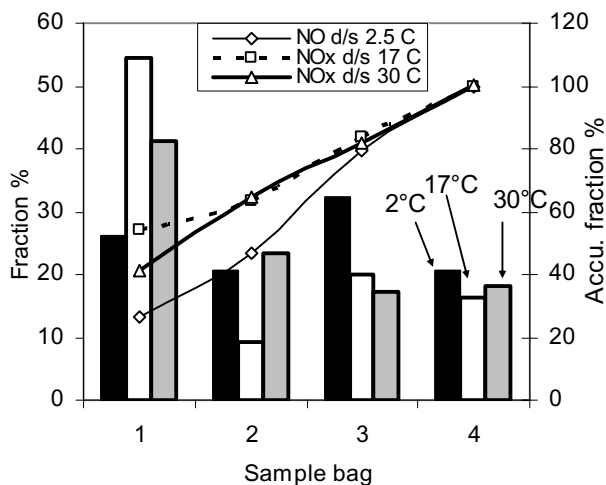

Figure 21a Fractions of each bag NOx emissions (d/s)

The catalyst efficiencies, shown in Figure 22, are very low for the cold start under all ambient temperature conditions. This is because the low speed traffic jam cycle did not produce enough heat to warm up the catalyst and thus give rise to very low catalytic activities on NOx emissions. The catalytic efficiency on NOx emissions was increased to 70% from the second phase onwards for spring and summer results and third phase onwards for winter result, showing the impact of ambient temperature on catalyst efficiencies.

Comparison with the previous work for freely moving urban traffic (7) shows higher engine out NOx emissions for LU-UDTC in winter than that for the traffic jam cycle, due to the higher average speeds and engine powers used in LU-UDTC. In summer the NOx emissions for LU-UDTC were lower out of the engine, as in this work for the same reasons. After the catalyst the NOx trends for LU-UDTC were similar to the present work. The faster catalyst light off and hotter catalyst for phases 3 and 4 for LU-UDTC result in a higher conversion efficiency (80%) from phases 2-4 at both ambient temperatures. Overall the test cycles have a much lower influence on NOx emissions than for CO and HC emissions.

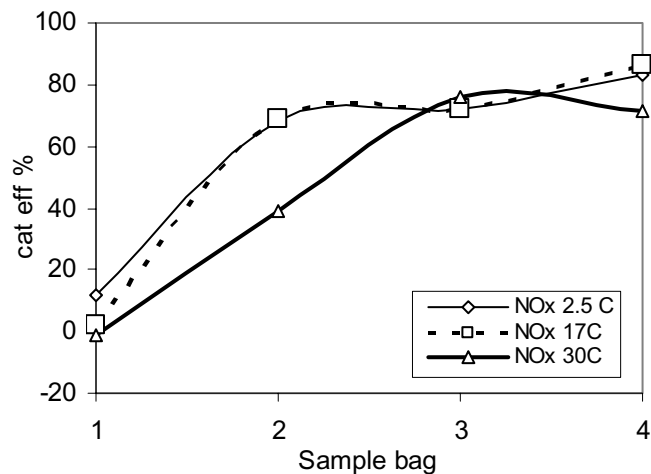

Figure 22 NOx conversion efficiency of TWC at different ambient temperature for LU-TJTC test

N₂O EMISSIONS – N₂O emissions are not currently regulated but they are a powerful greenhouse gas that is of the order of 200 times stronger in its effect than CO₂ for the same concentration. TWC catalysts are known to convert NOx into N₂O during the warm-up phase and this conversion is strong in the temperature region of 250 – 350°C (7).

Figure 23 shows the results of nitrous oxide (N₂O) emissions for the engine out samples under summer, spring and winter conditions. N₂O emissions fluctuated around 0.6–0.8 g/kg fuel. These were very similar to those for the freely moving urban test cycle results (7), which were 0.4 – 0.5 g/kg for all phases of the test cycle.

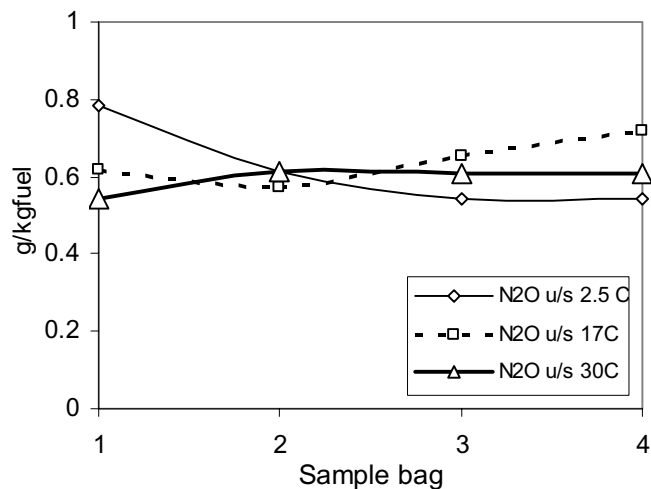

Figure 23 N₂O emissions (u/s) at different ambient temperature for LU-TJTC test

Downstream of the TWC, N₂O emissions (Figure 24) had no change across the TWC in the cold start phase for winter and spring tests and yet trebled for summer test. This is due to that the higher ambient temperature in summer accelerated the rapid temperature rise of the TWC in the first phase and the TWC was at the optimum

temperature for N₂O formation. The sudden increase in the phase two in winter test was due to the catalyst being at the optimum temperature for N₂O formation. The decrease of N₂O afterwards was due to the increase of temperature of TWC, which was over 350 °C. It should be noted that the mass of N₂O after the catalyst is significant and of the same order as the fully warmed up NO_x emissions after the catalyst.

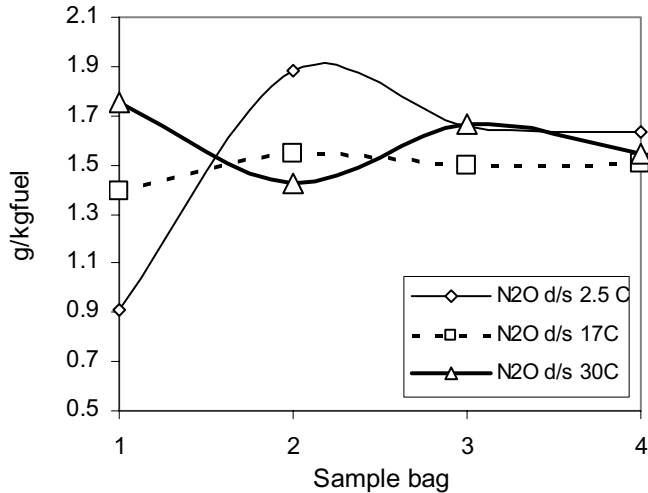

Figure 24 N₂O emissions (d/s) for each bag at different ambient temperature for LU-TJTC test

The formation of N₂O by the catalyst is seen as negative conversion efficiency when the results are expressed in terms of conventional conversion efficiency. These negative conversion efficiencies are shown in Figure 25. The greatest impact of ambient temperature on N₂O formation was found in the first cold start phase. The N₂O formation remained significant throughout the test period, especially for winter test. This is because the low travel speed and frequent stop start prevented the catalyst temperature from continuing to rise to above 350°C.

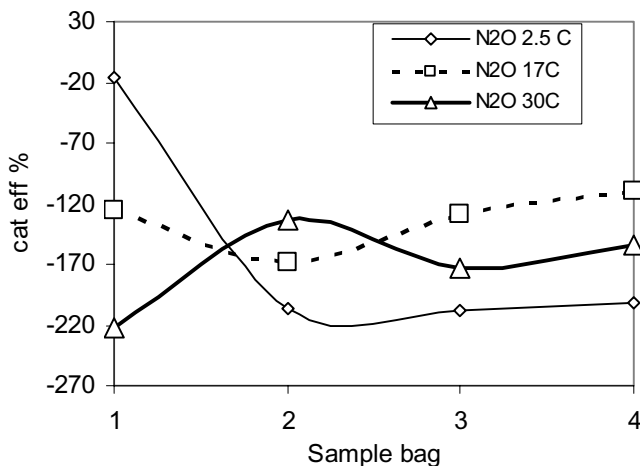

Figure 25 N₂O conversion efficiency of TWC at different ambient temperature for LU-TJTC test

COLD START AND SECOND PHASE EMISSIONS AS A FUNCTION OF AMBIENT TEMPERATURE

The first cold start section of the Leeds traffic jam test cycle had the highest catalyst out emissions for HC and CO, as discussed above. The HC and CO emissions in the second phase were also notably high. The first and second phase emissions were investigated as a function of ambient temperature.

HC EMISSIONS – Figures 26 and 26 show the hydrocarbon emissions as a function of ambient temperature for the first cold start phase and the second phase of the Leeds traffic jam test cycle. The results show a clear trend of hydrocarbon emissions in inverse proportion to ambient temperature over the temperature range from 30 to 2°C both upstream and downstream of the TWC. The HC emissions in the first cold start phase were more dependent on ambient temperature than that in the second phase due to the more advanced engine and catalyst warm-up. As the catalytic activity was low, the trends are controlled by the engine out emissions and the factors that influence water and lubricating oil warm up. Figure 26 also shows the comparison with the equivalent results for the urban drive cycle (dotted line)(7), which shows lower emissions than for the traffic jam test cycle for temperatures above 7°C. Below this temperature the catalyst is not hot enough to have any effectiveness in the cold start phase of both test cycles.

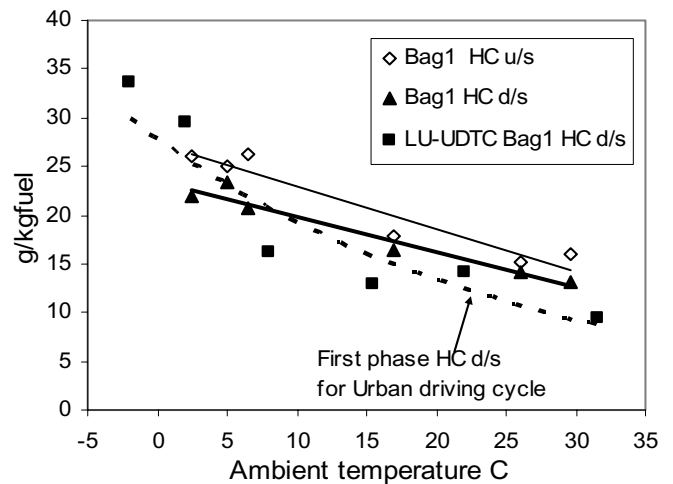

Figure 26 HC emissions Vs ambient temperature for bag 1 samples

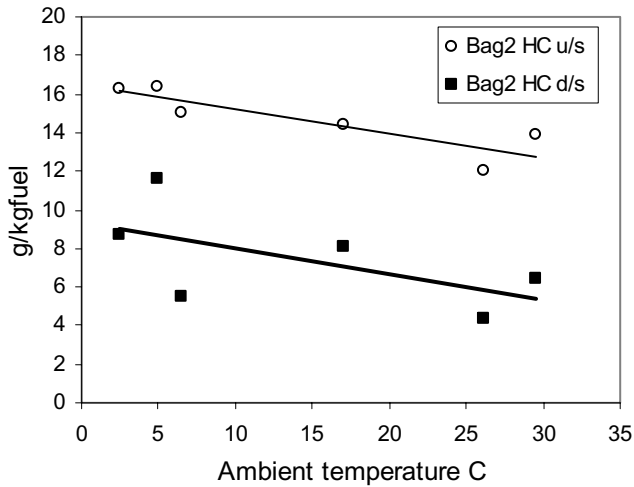

Figure 27 HC emissions Vs ambient temperature for bag 2 samples

Figure 28 shows the conversion efficiency of the TWC on HC emissions in the first cold start and second phase of the Leeds traffic jam test cycle as a function of ambient temperature. The conversion efficiency in the cold start phase was very poor (<20%) and not affected by the variation of ambient temperature. In the second phase the conversion efficiency was increased to 40~60% and shows an increasing trend with the increasing ambient temperature. This indicates that the ambient temperature starts to have impact on catalyst conversion efficiency and boost catalytic efficiency from the second phase of the test.

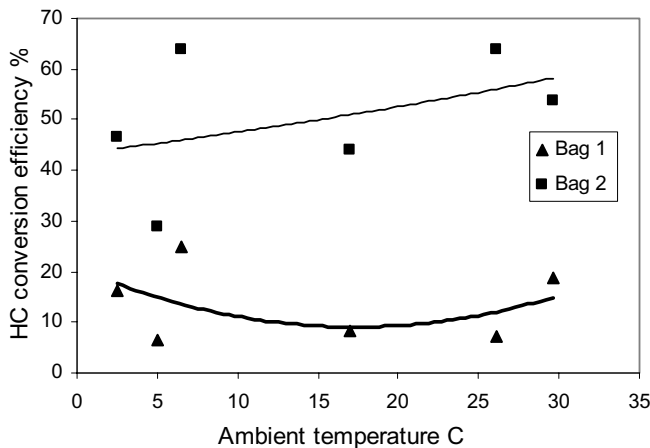

Figure 28 HC conversion efficiency of TWC Vs ambient temperature for bag 1 and 2 samples

CO EMISSIONS – The first cold start phase and second phase CO emissions show a clear correlation with ambient temperature for upstream and downstream of the TWC, as shown in Figures 29 and 30. The influence of ambient temperature on CO emissions was greater in the first phase than that in the second phase due to fuel enrichment under cold start as well as the influence of cold metal, water and oil. The effect of ambient temperature on CO emissions was greater than that on

HC emissions, which was due to the nature of combustion process in SI engines. CO is an equilibrium combustion product for rich mixtures and rich mixtures are used under cold start conditions in Euro 1 SI engines. Equilibrium CO emissions can be as high a 10% for mixtures that are 50% rich. The extent of the cold start over fuelling usually increases as the ambient temperature decreases. These equilibrium effects are in addition to any combustion inefficiency sources of CO emissions, which are related to the sources of HC emissions.

Figure 29 also shows the equivalent results for the urban test cycle downstream of the catalyst (7). The first phase cold start CO emissions for LU-UDTC had a similar trend with temperature as for the traffic jam cycle. The CO emissions for urban driving cycle were slightly lower, due to the higher catalyst temperatures. However, the differences between the two cycles was relatively small at low temperatures, but was proportionately greater at summer temperatures due to the faster catalyst light off under the urban driving conditions.

Figure 31 shows the conversion efficiency of TWC on CO for the first and second phase of the Leeds traffic jam test cycle. The catalytic efficiency of CO was only about 10% for the first cold start phase of the test. The ambient temperature had no impact on catalytic efficiency for the first cold start phase. The efficiency was increased significantly for the second phase of the test and the increasing ambient temperature boosted the catalytic efficiency.

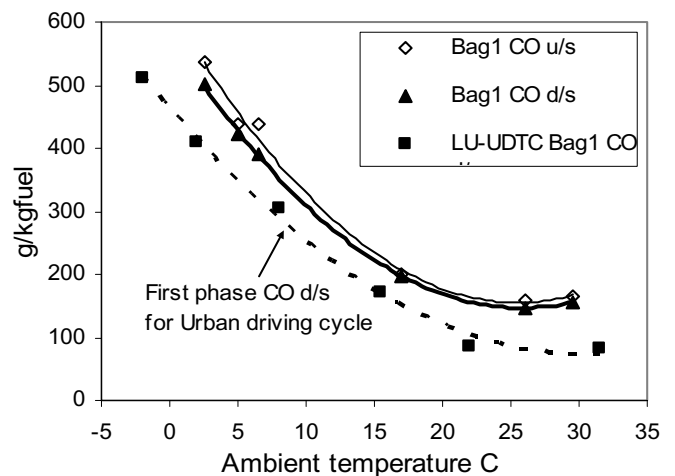

Figure 29 CO emissions Vs ambient temperature for bag 1 samples

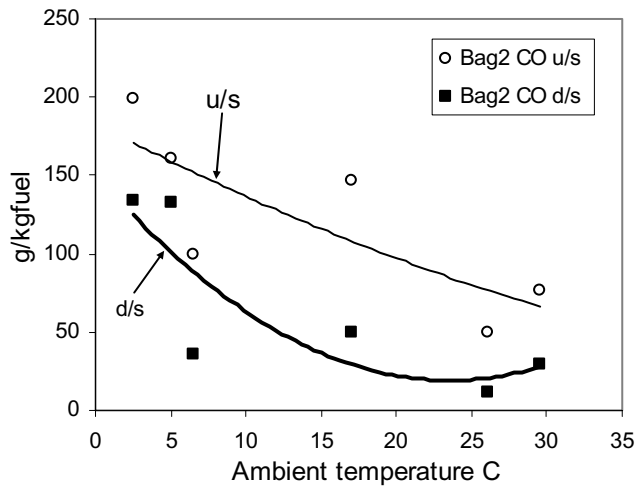

Figure 30 CO emissions Vs ambient temperature for bag 2 samples

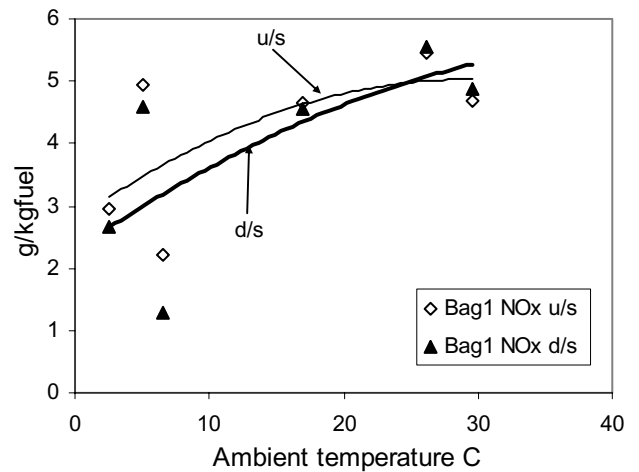

Figure 32 NOx emissions Vs ambient temperature for bag 1 samples

The catalyst conversion efficiency for HC and CO in the first cold start phase was very low and not influenced by ambient temperature, as shown in figures 28 and 31. This indicates that even in the hot summer, the heat up of the catalyst was very slow for Leeds traffic jam test cycle due to low speed, frequent stop starts.

The NOx emissions in the second phase of the test do not have a clear correlation with the ambient temperature, as shown in figure 33. This is because at low temperatures the engine out NOx is low in the period when the catalyst efficiency is still low. At higher temperatures the catalyst is active, just as the engine out emissions increase.

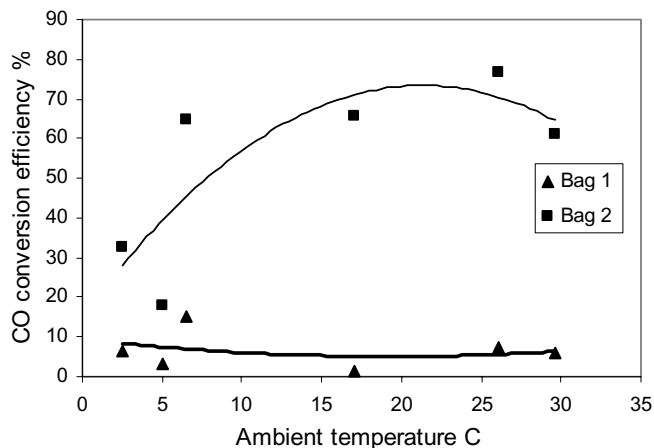

Figure 31 CO conversion efficiency of TWC Vs ambient temperature for bag 1 and 2 samples

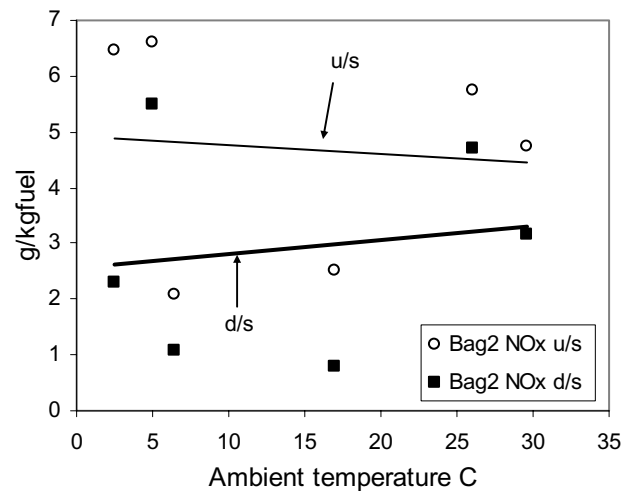

Figure 33 NOx emissions Vs ambient temperature for bag 2 samples

NOx EMISSIONS – Figures 32 and 33 show the NOx emissions as a function of ambient temperature for the first cold start phase and second phase of Leeds traffic jam test cycle. NOx emissions for the first phase are similar both upstream and downstream of TWC, indicating that the NOx emissions was determined by engine out NOx emissions. The curve fit shows clear trends that the NOx emissions increase with the rising ambient temperature, which is due to the faster cooling water warm-up that results in higher flame temperatures and higher NOx emissions.

Figure 34 shows the NOx conversion efficiency of TWC for the first cold start phase and second phase of the test. The conversion efficiency is less than 20% for the first phase and increase to ~40% for the second phase. The efficiency is decreased slightly with increasing ambient temperature, which is due to increased engine out NOx emissions, and also engine management operates engine at richer condition at low ambient temperatures, which favors NOx conversion.

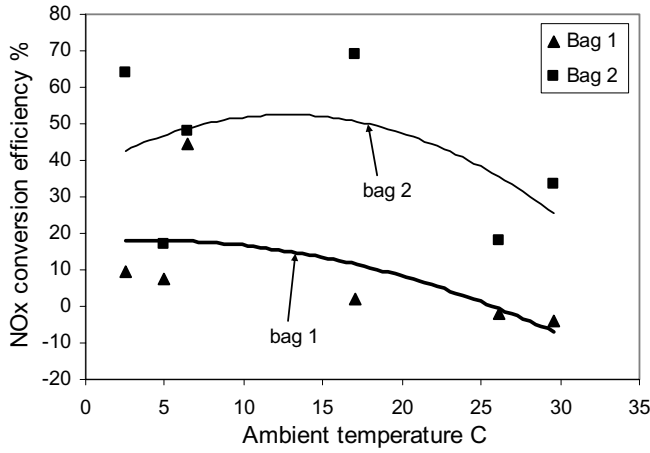

Figure 34 NOx conversion efficiency of TWC Vs ambient temperature for bag 1 and 2 samples

N₂O EMISSIONS – Figures 35 and 36 show N₂O emissions as a function of ambient temperature for phase 1 and 2 of the test. There were almost no changes for upstream N₂O emissions for phase 1 and 2. Downstream of the TWC, curve fits for N₂O show a small increase with ambient temperature for the first cold start phase. This was because the catalyst was not in the N₂O formation temperature zone (250-350°C). The N₂O emissions for the second phase of the test did not show a good correlation with ambient temperature. The N₂O catalyst conversion efficiencies in figure 37 show little N₂O formation in the first cold start phase, where the catalyst is too cold for N₂O production. Under summer temperatures N₂O starts to be formed as the catalyst is hotter.

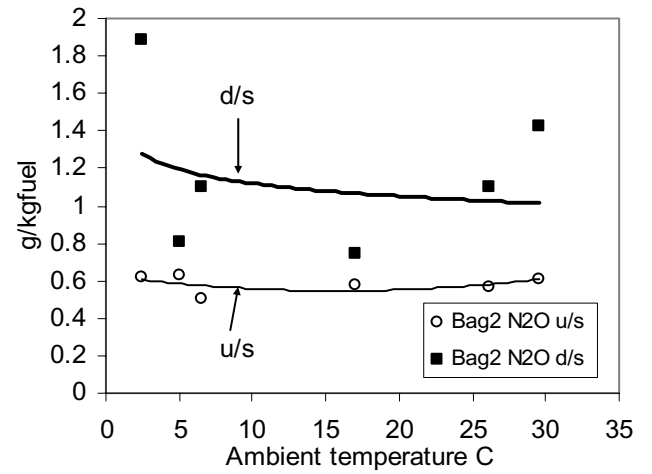

Figure 36 N₂O emissions Vs ambient temperature for bag 2 samples

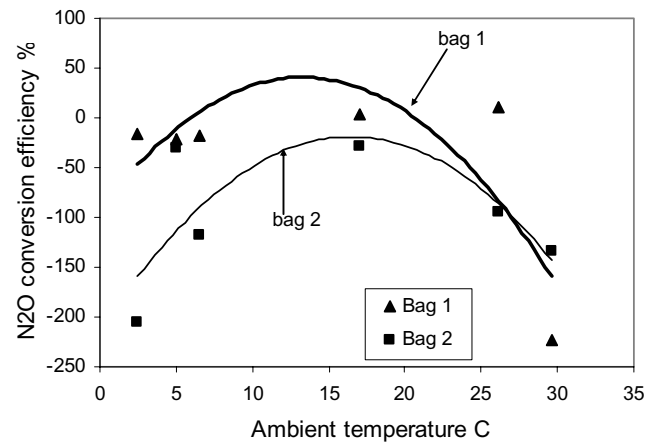

Figure 37 N₂O conversion efficiency of TWC for bag 1 and 2 samples

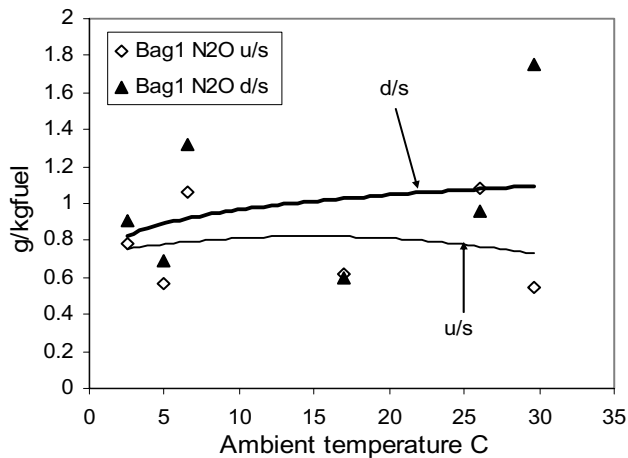

Figure 35 N₂O emissions Vs ambient temperature for bag 1 samples

COMPARISON OF COLD HC AND CO EMISSIONS WITH LU-UDTC AND PREDICTION OF EMISSIONS -

The Leeds urban driving test cycle LU-UDTC, conducted by authors in the same vehicle, had higher average speed than present study - traffic jam test cycle LU-TJTC and was similar to ECE 15 cycle(7). The results for the urban driving cycle LU-UDTC were compared with this traffic jam cycle research and listed in table 3.

Table 3 Comparison of HC and CO emissions for the cold start phase (bag 1) between LU-TJTC and LU-UDTC

Test cycle	First phase emissions at ambient 2 °C g/kgfuel		First phase emissions at ambient 30 °C g/kgfuel	
	LU-TJTC	LU-UDTC	LU-TJTC	LU-UDTC
HC	23	28	14	10
CO	500	410	156	80

The results in table 3 show that the greater influence of ambient temperature on HC emissions for Leeds urban driving cycle than that for Leeds traffic jam driving cycle and similar impact on CO emissions for both cycles. The big difference in emissions between two cycles lies in hot summer tests. The HC and CO emissions for Leeds urban driving cycle are 29% and 49% less than that for Leeds traffic jam driving cycle. This indicates that the increasing ambient temperature can have a greater effect on boosting the catalytic conversions during the engine cold start for urban driving cycle than that for traffic jam driving cycle due to that the Leeds urban driving cycle is to simulate the ECE 15 and has higher average speed, thus faster engine warm up.

The CO and HC emissions for the first phase of Leeds traffic jam cycle were normalized to the values at 25 °C as a function of ambient temperature so as to predict the CO and HC emissions to lower temperatures and other engines. The normalized results with polynomial fits are shown in Figure 38. Assuming that the influence of ambient temperature on emissions is the same relative effect as found in this work the emissions for any vehicle could be predicted at lower ambient temperatures for the similar driving patterns. The predicted HC emissions at -7 °C are rising by a factor of two for LU-TJTC, five for LU-UDTC, compared to that at 25 °C. The predicted CO emissions at -7 °C are rising by a factor of six for LU-TJTC, nearly nine for LU-UDTC, compared to values at 25 °C (7). It can be clearly seen that the greater influence of ambient temperature on cold HC and CO emissions for Leeds urban driving cycle than that for the traffic jam cycle.

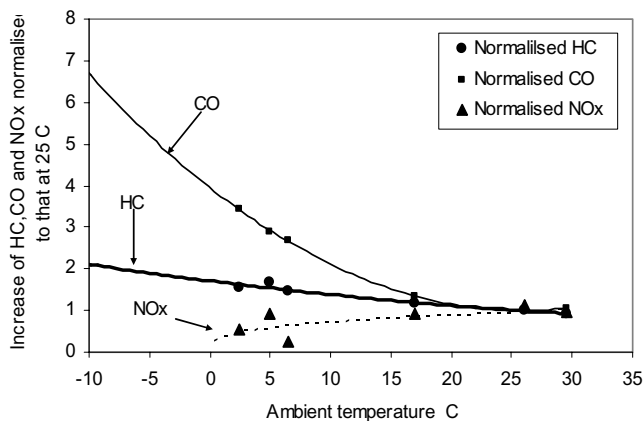

Figure 38 Relative increases of HC, CO and NOx for the first phase of the LU-TJTC test, normalized to the values at 25 °C

CONCLUSION

The Leeds traffic jam test cycle represented real world driving patterns in the major roads of congested cities. The tests were carried out in a range of ambient temperature 2~30°C. The exhaust gas samples were

taken simultaneously from upstream and downstream of TWC and analyzed for HC, CO, NOx and N₂O.

The results have shown:

1. The engine needed at least 9 minutes after cold start to reach full warmed up condition in terms of coolant temperature and 16 minutes in terms of engine oil. The decrease in the ambient temperature increased this period significantly.
2. TWC needed at least 8.5 minutes to be lighted off in summer and 10.5 minutes in winter in terms of catalyst gas temperature.
3. Comparison of emissions at three different ambient temperatures shows that the first bag of gas samples (taken in the first 4 minutes) had the highest emissions as the catalyst was not effectively functioning. The influence of ambient temperature on emissions was mainly depending on engine out emissions.
4. After the first cold start phase the catalyst started to be active. However, the results show that a cold start into traffic jam conditions results in very slow catalyst warm-up compared with that under legislated emissions test cycles. For Euro 1 vehicles with typical commuter journeys in traffic jams, the catalyst will not light off until the journey is nearly complete, particularly in winter. The environmental impact of these higher emissions needs to be taken into account in city air quality models.
5. The main effect of the traffic jam test cycle was on CO and hydrocarbon emissions, which were much higher than for more freely moving urban driving. The temperature effect was very strong, particularly for CO emissions, where there was a fourfold increase between 25°C and 2°C.
6. The NOx emissions were doubled during the first cold start phase when ambient temperature increased from 2 to 30 C. This effect was dominated by engine out emissions effect. Once the catalyst became active there was little influence of ambient temperature on NOx. This was because the catalyst efficiency increased with ambient temperature which counteracted the increase in engine out NOx.
7. N₂O emissions downstream of TWC increased significantly during the catalyst warm-up and contributed 5% of the greenhouse gas emissions during the journey.

REFERENCES

1. Hans Peter and Christian Cozzarini: Emissions and Air Quality. SAE Reference book R-237.2000.
2. J.Laurikko, L. Erlandsson and R.Arbrahimsson; Exhaust in Cold Ambient Conditions: Considerations for a European Test Procedure. SAE Paper 95923.
3. J.Laurikko and P.Aakko: The Effect of Ambient Temperature on the Emissions of Some Nitrogen Compounds: A Comparative Study on Low-Medium and High Mileage Three-Way Catalyst Vehicles. SAE Paper 950933.
4. M.D.Gurney and J.R.Allsup: Predictability of Emissions from In-Use Vehicles at Low-Ambient Temperature and Alternate Driving Cycle Based on Standard Tests. SAE Paper 890625.
5. R.E.Larson: Vehicles Emissions Characteristics under Cold Ambient Condition. SAE Paper 890021.
6. G.W.R.Taylor and S Stewart: Cold Start Impact on Vehicle Energy Use. SAE Paper 2001-01-0221.
7. G.E.Andrews, G. Zhu, H Li, A Simpson, J.A.Wylie, M.Bell and J.Tate: The Effect of Ambient Temperature on Cold Start Urban Traffic Emissions for a Real World SI Car. SAE Paper 2004-01-2903.
8. J.Laurikko and N.Nylund: Regulated and Unregulated Emissions from Catalyst Vehicles at Low Ambient Temperature. SAE Paper 930946.
9. D.H.Jason and M.D.Checkel: Quantifying Vehicle Emission Factors for Various Ambient Conditions using an On-Road, Real-Time Emissions system. SAE Paper 2003-01-0301
10. G.E.Andrews, J.R.Harris and A.Ounzain: Transient Heating and Emissions of an SI Engine during the Warm-up period. SAE Paper 880264.
11. G.E.Andrews, J.R.Harris and A.Ounzain: SI Engine Warm-Up: Water and Lubricating Oil Temperature Influences. SAE Paper 892103.
12. G.E.Andrews, J.R.Harris and A.Ounzain: The Role of Cooling Water and Lubricating Oil Temperature on Transient Emissions during SI Engine Warm-up. I.Mech.E. 1989.
13. G.E.Andrews, J.R.Harris and A.Ounzain: Experimental Methods for Investigating the Transient Heating and Emissions of an SI Engine during the Warm-up Period. I.Mech.E. 1988.
14. G.E.Andrews, A.Ounzain, A.D.Al-fawaz, M.Ghazhikhani and P.H.Dyke: Catalyst Performance during the Warm-up period. 2nd British-Italian conference in Engine
15. G.E.Andrews, J.R.Harris and A.Ounzain: The Influence of External Heat Losses on the Transient SFC and Emissions during the Warm-up period of an SI Engine. IMechE 1990
16. B.Piotr and M. Jerzy: Cold Start Emissions Investigation at Different Temperature Conditions. SAE Paper 980401.
17. G.E.Andrews and F.M.Ahmad: The Composition of Spark Ignition Engine Steady State Particulate Emissions. SAE Paper 1999-01-1143.
18. G.E.Andrews, Hu Li, J.Hall, A.A.Rahman and P.Mawson: The Influence of an Oil Recycler on Emissions with Oil Age for a Refuse Truck in Service testing. SAE Paper 2001-01-0623.
19. G.E.Andrews, Hu Li, J.Hall, A.A.Rahman and P.Mawson: Impacts of an on Line Bypass Oil Recycler on Emissions with Oil Age for a Bus in Service testing. SAE Paper 2001-01-3677.
20. G.G.Zhu: Engine and Exhaust System Warm-up, Emissions and Catalyst Temperature Control. PhD thesis, Dept. of Fuel and Energy, The University of Leeds, 1999.
21. J.A.Wylie: Spark Ignition Engine Emissions during Cold Start under Real World Driving Conditions. MSc thesis. The University of Leeds, 2001.
22. Automotive Test Drive Cycles for Emission Measurement and Real-World Emission levels – A Review. Journal of Automobile Engineering, Vol.216, No.D7. Institution of Mechanical Engineers. London, 2002
23. Y.Ohyama: Mixture Formation during Cold Starting and Warm-up in Spark Ignition Engines. SAE Paper 960065.
24. P.Bielaczyc and J.Merkisz: Euro III/Euro IV Emissions – A Study of Cold Start and Warm Up Phases with a SI Engine. SAE Paper 1999-01-1073.
25. P.Bielaczyc and J.Merkisz: Exhaust Emission from Passenger Cars during Engine Cold Start and Warm-up. SAE Paper 970740.
26. P.Bielaczyc, J.Merkisz and J.Pielecha: Exhaust Emissions from Diesel Engine during Cold Start in Ambient Temperature Conditions. Paper presented at 2000 FISITA World Automotive Congress~Automotive Innovation for the New Millennium. Seoul, Korea, 2000
27. Spark Ignition Engine Emissions. Short course. Leeds University. 2003.

ABBREVIATIONS

CO: Carbon monoxide.

CO₂: Carbon dioxide.

HC: Hydrocarbons.

LU-UDTC: Leeds University Urban Driving Test Cycle.

LU-TJTC: Leeds University Traffic Jam Test Cycle.

N₂O: Nitrous oxide.

SI: Spark Ignition.

TWC: Three Way Catalyst.

d/s: Downstream of the catalyst.

u/s: Upstream of the catalyst.

ECE: Economic Commission for Europe.