



VCU

Virginia Commonwealth University
VCU Scholars Compass

Theses and Dissertations

Graduate School

2006

Influence of Anti-CD44 on Murine B Cell Activation

Tiana L. Wyant

Virginia Commonwealth University

Follow this and additional works at: <https://scholarscompass.vcu.edu/etd>



Part of the [Medicine and Health Sciences Commons](#)

© The Author

Downloaded from

<https://scholarscompass.vcu.edu/etd/1004>

This Dissertation is brought to you for free and open access by the Graduate School at VCU Scholars Compass. It has been accepted for inclusion in Theses and Dissertations by an authorized administrator of VCU Scholars Compass. For more information, please contact libcompass@vcu.edu.

Influence of Anti-CD44 on Murine B Cell Activation

A dissertation in partial fulfillment of the requirements for the degree of Doctor of
Philosophy at the Medical College of Virginia, Virginia Commonwealth University

By

Tiana Lynn Wyant

B.S., Eastern Mennonite University, 1999
A.A. & S., Blue Ridge Community College, 1999

Director: Daniel H. Conrad, Ph.D.
Professor
Department of Microbiology and Immunology

Virginia Commonwealth University
Richmond, VA
February, 2006

Dedication

This dissertation is dedicated to my family and to God. My parents have supported me in this tremendous task and have given me love, patience, and encouragement. My husband has been a constant source of encouragement and steady support. Jesus has given me the daily strength (Psalm 28:7) needed for these years in my life.

Acknowledgements

I would like to thank Dr. Daniel H. Conrad, my advisor, for his leadership and his patience over the last six years. He is a wonderful scientist, patient teacher, kind mentor, and good friend. He continues to challenge me in my scientific thinking and has encouraged me immensely during my time in his laboratory.

I would like to thank Dr. Robert F. Jochen, of Blue Ridge Community College, who was my first mentor and the man who changed my scientific life. Thanks for your support, your encouragement, and your guidance. You are like a father to me.

I would also like to thank my Committee members, Dr. Suzanne Barbour, Dr. William Grogan, Dr. Kathy McCoy, and Dr. Darrell Peterson, for patiently working with me.

A big “Thank you” to my Lab members, buddies, and friends, both past and present. You’ve been there when I needed you! Jill Ford, thank you for being an awesome friend and being such an encouragement to me. Thanks also to Bing-Hung Chen, Anne Shelburne, Michelle Freeman, Dr. Check Ma, Yee Chan-Li, Timothy Caven, Dr. Steve Becker, Jun Sato, Jerry Schlomer, and Jamie Sturgill. You all have been good friends and lab-mates.

Special thanks to my husband, Philip Wyant, who has been a fountain of support, encouragement, and love as I’ve worked at earning my degree. Special thanks also to my parents, Stephen and Caren Urgolites, for their encouragement and support through all my University degrees, and to my brother, Joshua Urgolites.

TABLE OF CONTENTS

	Page
LIST OF TABLES	viii
LIST OF FIGURES	ix
LIST OF ABBREVIATIONS	xii
ABSTRACT	xix
INTRODUCTION	1
I. CD44: Adhesion Receptor.....	1
A. Structure.....	1
B. Expression.....	8
C. Function.....	10
II. B lymphocytes in the Immune System.....	16
A. Introduction.....	16
B. CD44 and B cells.....	19
C. Pathways of B cell Activation.....	19
1. CD40 and its ligand CD40L (CD154).....	20
2. B cell Receptor (BCR).....	23
3. LPS – the “innate” activator.....	28
4. Interleukin-4 (IL-4).....	32
D. Immunoglobulin E.....	34
E. Class Switch Recombination.....	35
F. Plasma Cell Differentiation.....	36

III.	CD23 (FcεRII), the low affinity IgE receptor.....	40
	A. Introduction to CD23.....	40
	B. Structure.....	41
	C. Function.....	47
	D. CD23b Expression.....	50
IV.	Research Objectives.....	57
	A. Effects of anti-CD44 on B cell growth and differentiation....	57
	B. CD23b promoter defect: To B or Not to B.....	58
	MATERIALS AND METHODS.....	59
I.	Anti-CD44 Project	
	a. Animals and Media.....	59
	b. B cell Isolation and Growth Conditions.....	59
	c. B cell proliferation.....	60
	d. ELISA.....	60
	e. Elispot.....	60
	f. FACS.....	61
	g. Steptavidin-microbeads cross-linking experiments.....	61
	h. <i>In vivo</i> RK3G9 experiment.....	62
II.	CD23b Promoter Project	
	a. Cell lines.....	62
	b. Plasmids.....	62
	i. pGL3-CD23bProm-TATA construct.....	63

ii. CD23a and CD23b full-length clones.....	67
1. CD23a.....	66
2. CD23b.....	67
iii. Other CD23b constructs.....	68
c. Transfection of cell lines.....	68
i. Electroporation.....	68
ii. FuGene Transfection.....	71
d. Luciferase Assay.....	71
e. RT-PCR for CD23b in IEC4.1 cells.....	71
RESULTS.....	72
I. Results of investigation of effects of anti-CD44 on B cell activation and differentiation.....	72
a. Immobilized anti-CD44 Abs inhibit B cell proliferation.....	72
b. Ig production is inhibited by CD44 cross-linking on B cells.....	75
c. Cross-linking does not increase the ability of soluble RK3G9 to inhibit B cell proliferation or IgE production.....	83
d. CD44 knockout mice confirm RK3G9 specificity.....	86
e. Fc γ RII is not involved in the inhibition seen during B cell CD44 cross-linking.....	93
f. The “Missing Factor” Hypothesis.....	93
g. The effects of CD44 cross-linking on B cells are dependent on the type of B cell activator used.....	102

h.	The CD44 cross-linking effects are limited to the initiation of B cell Activation.....	102
i.	Activation of the B cells is dependent on both anti-CD44 signals and the interplay between different activation pathways.....	105
j.	<i>In vivo</i> experiment with RK3G9.....	113
k.	CD138 ⁺ B cells are decreased with RK3G9-treated cells.....	113
II.	Investigation of CD23b promoter region.....	121
a.	Efforts to “fix” the “defect” in the transcription initiation region of the CD23b promoter.....	121
b.	Creation of an antibody specific for the CD23a or CD23b isoform.....	124
c.	Analysis of murine intestinal epithelial cells for expression of the CD23b isoform.....	129
	DISCUSSION	130
I.	Anti-CD44 studies on B cell activation.....	130
II.	CD23b studies.....	148
	REFERENCES	152
	CV	185

LIST OF TABLES

Table	Page
I. Oligos used in construction of CD23b constructs.....	64
II. B cell ability to respond to anti-CD44 signals is absent by day 4 of stimulation....	99

LIST OF FIGURES

Figure	Page
1. Structure of the CD44 glycoprotein.....	2
2. Gene structure of CD44.....	4
3. General overview of B cell development.....	17
4. CD40 signaling.....	21
5. BCR signaling.....	25
6. TLR4 pathway.....	29
7. Plasma cell differentiation.....	37
8. Model for associated trimeric CD23.....	42
9. The murine CD23a and CD23b promoter sequences.....	45
10. Pictorial view of the murine CD23 isoforms and isoform variants.....	48
11. The schematic of the CD23b coding regions from the four pCR3.1-CD23b constructs provided by Dr. Alexandre Benmerah.....	69
12. B cell proliferation is greatly reduced due to CD44 cross-linking by immobilized anti-CD44 antibody.....	73
13. CD44 crosslinking on T cells via anti-CD44 antibodies causes no decrease in their ability to proliferate.....	76
14. CD44 crosslinking via anti-CD44 antibodies on B cells causes a decrease in their ability to produce immunoglobulins.....	78
15. Soluble RK3G9 added to B cell cultures had no effect on B cell IgE production...81	81
16. MAR18-RK3G9 is not as effective as RK3G9 alone.....	84

17. Proliferation by B cells grown with RK3G9 plus biotinylated MAR18 plus streptavidin.....	87
18. IgE production by B cells grown with RK3G9 plus cross-linking agents.....	89
19. The CD44 ^{-/-} mice can not respond to RK3G9-mediated B cell inhibition of proliferation.....	91
20. The inhibitory gamma receptor is not involved in the inhibition of IgE production by B cells whose CD44 is crosslinked by an anti-CD44 antibody.....	94
21. Addition of Cloning Factor.....	97
22. Mouse B cells grown with additive supernatants still respond to anti-CD44.....	100
23. B cell activation/differentiation is affected by CD44 cross-linking under a variety of growth conditions.....	103
24. B cell activation inhibition by CD44 cross-linking is dependent on the type and amount of stimulation.....	109
25. B cell activation inhibition by CD44 cross-linking is dependent on the type and amount of stimulation.....	111
26. IgE levels were unchanged by injection of RK3G9 <i>in vivo</i>	114
27. Fewer CD138 ⁺ cells are present with RK3G9-treated cells.....	117
28. Elispot analysis showed that fewer plasma cells formed in the B cell cultures grown on anti-CD44.....	119
29. Activity of the CD23b promoter vs. CD23b-TATA vs. CD23a promoter.....	122
30. Activity of the human and mouse CD23b promoters.....	125
31. RT-PCR for CD23b in the IEC4.1 cells.....	127

32. Model for RK3G9 (anti-CD44)-mediated B cell antigen-specific activation.....145

LIST OF ABBREVIATIONS

-/-	homozygous deletion of a gene (knockout (KO) mouse)
2H10	rat anti-mouse FcεRII
4PS	IL-4 phosphorylation substrate (IRS2)
a.a	amino acid
Ab	antibody
ADAM	A Disintegrin And Metalloprotease
Ag	antigen
AID	Activation-Induced cytidine Deaminase
AP-1	Activator Protein 1
APE-1/Ref1	Apurinic/aPyrimidinic Endonuclease 1/Redox factor 1
ATF2	Activating Transcription Factor 2
B1E3	Rat anti-mouse IgE antibody
β ₂ -AR	beta-2 Adrenergic Receptor
BACH2	BTB and CNC homology 1, basic leucine-zipper transcription factor 2
BAD	BCL2-antagonist of cell death
BCAP	B-cell receptor-associated protein
BCL6	B-cell CLL/lymphoma 6
BCR	B Cell Receptor
BLIMP-1	B lymphocyte-induced Maturation Protein 1
BLNK	B-cell linker

BMP-7	Bone Morphogenetic Protein (osteogenic protein 1)
CBP	p300/CREB-Binding Protein
CCP	Clathrin-Coated Pit
CD40LT	CD40 Ligand Trimer (also CD154)
c-Jun	helps to form AP-1 (transcription factor)
c-Met	cell surface receptor with tyrosine kinase activity
Csk	c-src tyrosine kinase
CSR	Class Switch Recombination
DAG	Diacylglycerol
DNA	deoxyribonucleic acid
EGF	epidermal growth factor
ELISA	Enzyme-Linked ImmunoSorbant Assay
ELISpot	Enzyme-linked Immunospots Assay
EMSA	electrophoretic mobility shift assay
ErbB	receptor tyrosine kinase
ERK	Extracellular Regulated Kinase
FACS	Fluorescence Activated Cell Sorting
FAK	PTK2 protein tyrosine kinase 2
FBS	fetal bovine serum
FcεRI	high affinity IgE receptor
FcεRII	low affinity IgE receptor
FcγRIIb	low affinity IgG receptor; only IgG receptor on mouse B cells

FDC	Follicular Dendritic Cell
FGF-R1	Fibroblast Growth Factor Receptor 1
FITC	fluorescein isothiocyanate
FKHR	forkhead box O1A
GAG	Glycosaminoglycan
GC	Germinal Center
GI	Gastrointestinal
GLT	Germline Transcript
GPI	glycosyl-phosphatidylinositol
^3H	Tritium
HA	Hyaluronic Acid
hCD23	human CD23
HRP	Horseradish Peroxidase
ICD	Intracellular Domain
IFN α or IFN β	Interferon alpha or beta
Ig	Immunoglobulin
IL-1, 4, 6, 8, 10, 12	Interleukins-1, 4, 6, 8, 10, 12
IL-4R	Interleukin-4 Receptor
IP $_3$	inositol 1,4,5-trisphosphate
IRAK	interleukin-1 receptor-associated kinase
IRE1 α	endoplasmic reticulum (ER) to nucleus signalling 1
IRF3	interferon regulatory factor 3

IRF4	interferon regulatory factor 4
IRG	immunoresponsive gene
IRS	Insulin Receptor Substrate
ITAM	Immunoreceptor Tyrosine-based Activation Motif
ITIM	Immunoreceptor Tyrosine-based Inhibitory Motif
JAK	Janus Kinase
JNK	c-Jun NH2-terminal Kinase
kDa	kiloDalton
LZ-CD23	Leucine zipper-CD23
LPS	Lipopolysaccharide
mAb	Monoclonal Antibody
MAPK	Mitogen-Activated Protein Kinase
mCD23	mouse CD23
MEK	mitogen-activated protein kinase kinase
mIG	membrane (surface) Ig
MITF	microphthalmia-associated transcription factor
MMP	Matrix Metalloprotease
mRNA	Messenger RNA (ribonucleic acid)
MTA3	metastasis associated 1 family, member 3
MTI-MMP	matrix metalloproteinase 14
MyD88	Myeloid Differentiation Factor 88
NFAT	Nuclear Factor of Activated T Cells

NFκB	Nuclear Factor kappa B
N-linked	Asparagine-linked
NO	Nitric Oxide
OBF1	octamer-binding transcription factor (OCT)-binding factor 1
O-linked	serine or threonine-linked
PAMPs	Pathogen-Associated Molecular Patterns
PAX5 (BSAP)	paired box gene 5 (B-cell lineage specific activator)
PBL	peripheral blood lymphocytes
PBS	phosphate buffered saline
PCR	Polymerase Chain Reaction
PI-3 KINASE (PI3K)	phosphatidylinositol 3-kinase
PIP ₂	Phosphatidylinositol (4,5)-bisphosphate
PIP ₃	Phosphatidylinositol (3,4,5)-trisphosphate
PLCγ	phospholipase C gamma
PTB	Phosphotyrosine binding
PTK	Protein Tyrosine Kinase
Rac	ras-related C3 botulinum toxin substrate (rho family, small GTP binding protein)
RANTES	chemokine (C-C motif) ligand 5 (CCL5)
RT-PCR	Reverse transcriptase polymerase chain reaction
Rho	member of the Ras GTPase family
sCD23	soluble CD23

TCR	T Cell Receptor
T _H 2	T helper cell, type 2
TF	Transcription Factor
TGFβ	Transforming Growth Factor beta
TGFβR1	Transforming Growth Factor beta Receptor I
TI	T cell Independent
TIR	Toll/IL-1 Receptor
TIRAP	Toll-interleukin 1 receptor (TIR) domain-containing adapter
TLR	Toll-like Receptor
TM	Transmembrane
TNFα	Tumor Necrosis Factor alpha
TNFR	Tumor Necrosis Factor Receptor
TRAF	TNF receptor-associated factor
TRAM	TRIF-related adapter molecule
TRIF	Toll/IL-1 receptor resistance (TIR) domain-containing adapter inducing IFN-β
TSG-6	tumor necrosis factor, alpha-induced protein 6
SH2	Src Homology 2
Src	sarcoma (tyrosine kinase discovered in sarcoma originally)
STAT	Signal Transducer and Activator of Transcription
VCAM-1	vascular cell adhesion molecule 1

V(D)J	The recombination event that occurs at the variable-diversity joining regions during Ig biosynthesis
XBP-1	X-Box Binding Protein
ZAP-70	zeta-chain (TCR) associated protein kinase 70kDa

ABSTRACT: Influence of anti-CD44 on B cell activation

Tiana Lynn Wyant

Lymphocyte activation and trafficking are indispensable to the immune system. CD44, an adhesion molecule, plays important roles in T cell activation, lymphocyte homing/trafficking, and tumor metastasis. Although the functions of CD44 have been shown in T cells and other leukocytes, little is known about its role in B cells. The effects of CD44 cross-linking on murine B cell activation via CD40L/IL-4 was explored using the anti-CD44 mAbs RK3G9 and IM7. Immobilized RK3G9 and IM7 could strongly inhibit B cell proliferation and Ig production, with IgE inhibition being prominent. Soluble anti-CD44 had no effect. The inhibitory effect of RK3G9 was not influenced by addition of anti-Fc γ RII, indicating no role for the inhibitory receptor. The effects of delayed addition of immobilized anti-CD44 mAbs were studied, and the results indicated no inhibition after 96 hrs of culture. B cells were also activated by either LPS or anti-IgM F(ab')₂. While LPS-induced B cell activation was inhibited by immobilized anti-CD44 mAbs, anti-IgM activation was refractory. Interestingly, addition of both anti-IgM and CD40L or LPS resulted in some modulation of the inhibitory activity. Additionally, FACS and Elispot revealed that RK3G9-treated cells had reduced numbers of plasma cells. Taken together, these results suggest that CD44 cross-linking could control polyclonal B cell activation by CD40L, but allow sIgM/CD40L activation to continue.

INTRODUCTION

I. CD44: Adhesion Receptor.

A. Structure. CD44 is a single pass, highly polymorphic type II cell surface glycoprotein ranging in size from 80 to 250 kDa and is a member of the hyaladherin or link protein superfamily.^{1,2} This adhesion receptor has four major domains: the distal extracellular, membrane-proximal extracellular, transmembrane, and cytoplasmic domain (Fig. 1). The distal extracellular domain is responsible for the binding of ligand. The membrane proximal extracellular domain contains the site where additional “variant” exons – which encode additions to the CD44 protein – may be spliced into the CD44 mRNA transcript to generate multiple variant isoforms of the CD44 molecule. The transmembrane domain is typical of single-pass proteins, but studies using site-directed mutagenesis have generated data which suggests that lipids or accessory membrane proteins may interact with the transmembrane domain of CD44 to modulate ligand binding. The 70-amino-acid (a.a.) cytoplasmic tail is present in most isoforms of CD44 and data indicates that it functions to interact with cytoskeletal components and also is involved in intracellular signaling. It can also influence the binding of ligand to CD44.³⁻⁵

CD44 is a single gene with a total of 20 exons and is located on the short arm of chromosome 11 in the human. Exons 1-5, 16-18, and 20 comprise the most often expressed form of CD44, called CD44s (CD44 standard) or CD44H (because this is the predominant form expressed on hematopoietic cells). CD44s, then, is expressed when direct splicing of exon 5 to exon 16 occurs (see Fig. 2), skipping the variant exons (exons 6-15 = v1-v10). CD44s is 363 amino acids long. Exon 19 encodes the short tail (three

Figure 1. Structure of the CD44 glycoprotein. CD44 has four domains – the membrane-distal extracellular domain (ligand-binding domain), the membrane-proximal extracellular domain (where variant exons may be inserted), transmembrane region, and cytoplasmic tail. When the CD44 tail is phosphorylated due to ligand binding, contact with actin and other cytoskeletal components occurs, leading to cytoskeletal rearrangement and a change in the phenotype of the cell. *(Schematic is from “The Hyaluronan Receptor, CD44” by Warren Knudson and Cheryl Knudson, <http://www.glycoforum.gr.jp/science/hyaluronan/HA10/HA10E.html>. Reprinted with permission from Editors at Glycoforum.com and Warren Knudson, author)*

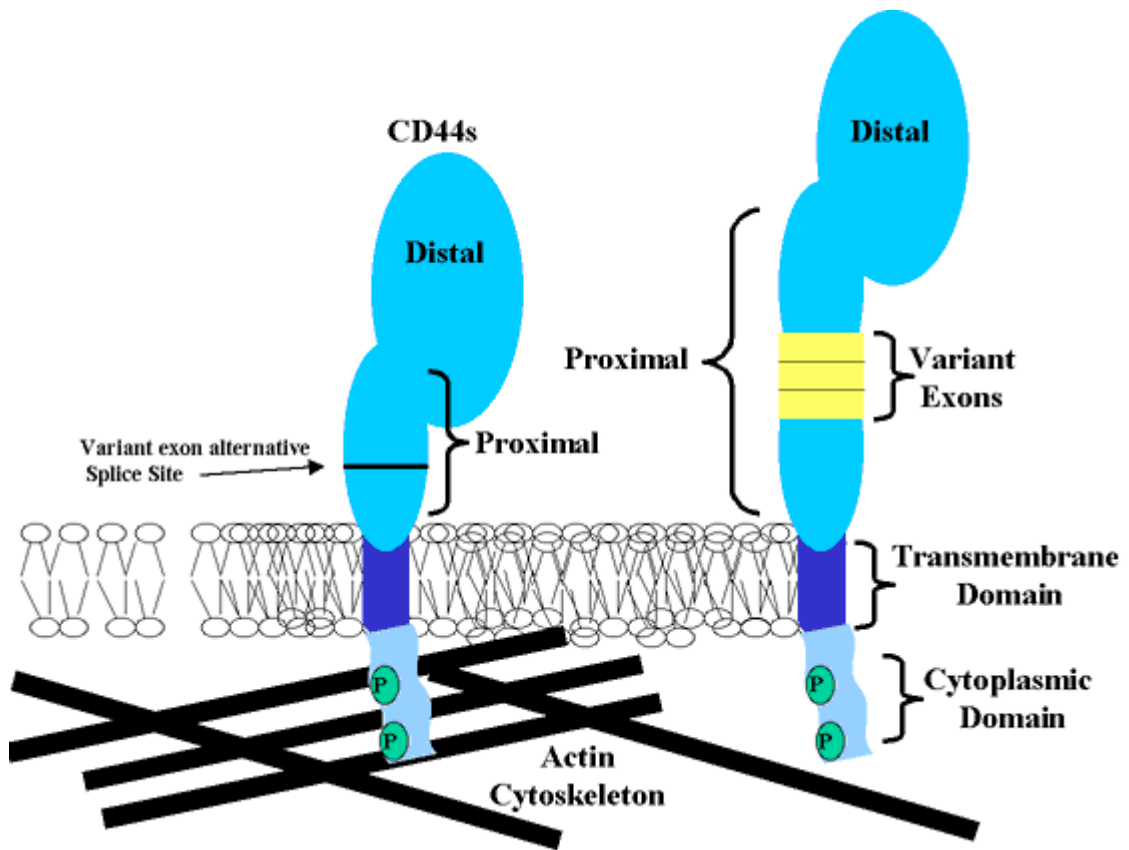
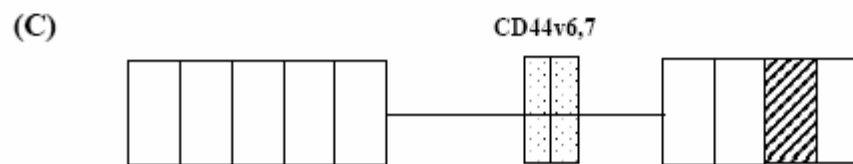
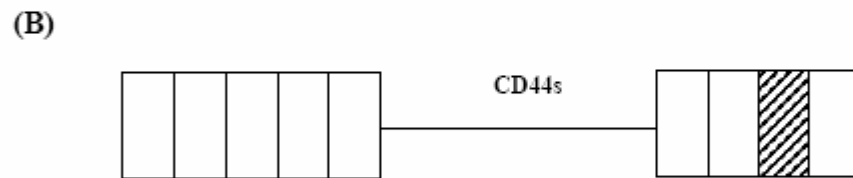
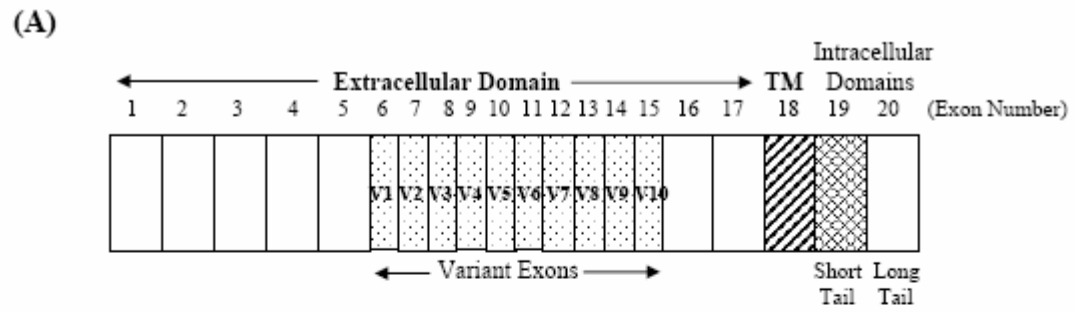


Figure 2. Gene Structure of CD44. CD44 has 20 exons total, but only nine (1-5, 16-18, 20) are expressed in the standard isoform (CD44s). The variant exons (6-15, also called v1-v10) are alternatively spliced into the mRNA to create, theoretically, hundreds of different isoforms. Note that exon 19 is the short tailed version of CD44 and is rarely employed in any isoform. *(Schematic is drawn with inspiration from “The Hyaluronan Receptor, CD44” by Warren Knudson and Cheryl Knudson, on the web site www.glycoforum.gr.jp)*

[<http://www.glycoforum.gr.jp/science/hyaluronan/HA10/HA10E.html>]



amino acids) of CD44 and is rarely used. Studies have suggested that this nearly “tailless” CD44 isoform negatively regulates CD44-mediated uptake of hyaluronic acid (ligand). When transfected into a chondrocyte, this truncated tail isoform acts as a dominant negative receptor, causing a loss of the capacity to either bind or internalize hyaluronan^{6,7} and a loss of Smad signaling.⁸ The 10 variant exons are numbered 6 through 15 and are utilized by alternative mRNA splicing. The isoform nomenclature, when a variant exon is added to the standard CD44 protein, is “CD44v1” to refer to “CD44s plus exon 6” (the first variant exon, v1), and so on, up to v10. A CD44 molecule containing variant exons 2 and 5-7 is named CD44v2,v5-7. Theoretically, any number and combination of variant exons may be added to the CD44 protein to generate hundreds of different isoforms; thus far, about 30 have been identified. Recently, it has been found that certain cell types can use intronic sequence as part of the coding sequence. For example, synovial cells isolated from the joints of individuals suffering from rheumatoid arthritis (RA) express a CD44v3-10 mRNA transcript that includes an extra trinucleotide between variant exons 4 and 5. This merely adds an alanine and does not interfere with the reading frame. Investigators found that cells transfected with this variant isoform of CD44v3-10 (named CD44vRA) can bind more soluble Fibroblast Growth Factor Receptor-1 (FGFR1) than could CD44v3-10-expressing cells, suggesting that these CD44vRA-expressing cells in RA patients have enhanced FGF-R1 activation,⁹ which indicates increased disease susceptibility. Another example of intronic sequence use is with a group of alternatively spliced CD44 isoforms termed “soluble CD44”. In mouse embryonic muscle and cartilage tissues, CD44v8-10 was found to have additional coding

sequence derived from intronic sequence between v9 and v10. Of the four transcripts found, two contained extensions of v9 and two had a “new exon”; the common feature these four transcripts share is a stop codon, which results in a protein truncated within the membrane-proximal extracellular domain.¹⁰

Individual cells can repeatedly change the splicing of their CD44 pre-mRNA, consistent with the responses that need to be made in reference to the extracellular and intracellular microenvironment. The CD44s protein is approximately 37 kDa prior to glycosylation; after addition of the appropriate N-linked and O-linked oligosaccharides, the final molecular mass is 80-100 kDa. There are at least five conserved N-glycosylation sites in the N-terminal domain and two chondroitin sulphate attachment sites on the exon 5 product.¹¹ There are also several possible O-linked glycosylation sites in the membrane proximal region and consensus attachment sites for heparin sulphate, keratin sulphate, and sialic acid on the standard extracellular domain. As noted before, hyaluronic acid (HA) is the major ligand for CD44. The structure of HA, a glycosaminoglycan, is characterized as a linear polymer. There are three places on the CD44 molecule that contact HA and form the binding sites; these binding sites are basic amino acid clusters, with specific and critical arginine residues.¹¹

The addition of variant exons can introduce new glycosylation sites, including serine/threonine-rich regions for O-glycosylation,¹² glycosaminoglycan attachment consensus SGXG motifs,¹³ and tyrosine sulfation.¹⁴ The molecular mass may reach up to 250 kDa. Different CD44 isoforms can have specific patterns of glycosylation and these

additions have repercussions on the ability of CD44 to bind ligand.¹⁵ Interestingly, the mouse has 10 variant exons, but the human has nine.^{3,4,16,17}

B. Expression. CD44s is expressed ubiquitously on mesenchymal and hematopoietic cell types.³ It has been also found on cells of the central nervous system, lung, liver, pancreas, and epidermis. CD44v has a more restricted expression profile: it is expressed on activated lymphocytes, macrophages, selected epithelial cells, and keratinocytes;¹⁷⁻¹⁹ the level of expression, as well as the particular CD44 isoform, varies according to cell type and activation state.^{16,20} The primary ligand for CD44 is hyaluronate,^{19,21} a major component of the extracellular matrix, although there are other ligands, including fibronectin,²² collagen,²³ laminin, chondroitin sulfate, L and E selectins, and the MHC class II invariant chain,^{24,25} among others. The hyaluronan (hyaluronic acid, HA) binding domain is highly conserved in all CD44 isoforms and contains two clusters of positively charged amino acids, and these bind a six-sugar sequence of HA.^{5,26} The ligand specificity of CD44 is markedly influenced by post-translational modifications, primarily glycosylation,²⁷ as well as the extensive alternative mRNA splicing³ that leads to the generation of variant isoforms. Glycosylation has been shown to have an additive effect on CD44 ligand binding; glycosaminoglycans (long chains of repeating disaccharides) such as chondroitin sulfate or heparin sulfate have highly charged sulfate and carboxylate groups. These contribute to a negatively charged environment, which naturally attracts positive ions, and so create an osmotic potential. This can then influence CD44 ligand binding. The data suggests that CD44v isoforms have a reduced ability to bind hyaluronate and that it is due to the degree of glycosylation.¹² Binding studies have found

that CD44v can bind HA as efficiently as CD44s if the O-linked glycosylation is removed prior to binding,¹² and N-linked glycosylation has been shown to inhibit HA binding as well.^{28,29} Phosphorylation of serine in the cytoplasmic portion of CD44 also increases its capacity to bind HA, as well as increasing the binding of ankyrin to the cytoplasmic tail of CD44.^{4,30} This has been implicated in downstream events which lead to cell migration. Other factors influencing HA binding are the distribution of CD44 on the cell surface (ie, within a lipid raft or not) and the ability of the CD44 present to cluster once HA is bound (which promotes tighter binding).³¹

CD44 is transcriptionally upregulated by proinflammatory cytokines such as interleukin-1 (IL-1) and growth factors (TGF- β , EGF, BMP-7).^{17,32-34} These can have an impact on CD44 splicing.

CD44 can be found in three states of activation on cells: active, inducible, and inactive. The “state of activation” simply refers to its functional ability to bind hyaluronan. The “active state” CD44 constitutively binds hyaluronan, whereas the “inducible state” CD44 binds HA weakly or not at all, unless it is activated by inducing mAbs, cytokines, or growth factors. The inactive CD44 simply does not bind HA, even in the presence of inducing agents. It has been suggested that this is a mechanism to prevent unnecessary engagement of the receptor, as both CD44 and its principal ligand are ubiquitously expressed.³ These three states of activation can be directly correlated with the level of glycosylation on individual CD44 proteins; low glycosylation is found on active state CD44, while intermediate and high glycosylation levels are found on inducible and inactive state CD44, respectively.^{19,24,35}

C. Function. There are multiple known functions for CD44. It acts as a co-receptor, functions in cell-cell aggregation, anchors pericellular matrix, acts as a docking protein for matrix metalloproteinases (MMPs), functions in cell-matrix and matrix-cell signaling, mediates cell migration, and ligation can result in receptor-mediated internalization/degradation of hyaluronan.^{4,59} One example is CD44v3, which bears a heparin-sulfate proteoglycan chain; it can bind basic growth factors such as fibroblast growth factors (FGFs), which are essential to proper development of the limb bud.

More specific to the immune system, CD44 is involved with cellular adhesion (migration and aggregation), lymphocyte activation,^{36,37} angiogenesis, and release of cytokines.¹⁷ A recent paper by Bradl, *et al*, reported that CD44 is dispensable for B cell lymphopoiesis, and that CD44-deficient B cells, activated by stimuli such as IL-4/CD40, IL-4/anti-IgM HC, and LPS, are normal in their responses.³⁸ Another report on CD44^{-/-} mice agrees that the mice develop normally but also shows that lymphocyte homing to the thymus and lymph nodes is impaired.³⁹ A separate report by Stoop, *et al*, investigating the responses of CD44^{-/-} leukocytes to acute or chronic inflammation, suggests that CD44 can actually interfere with homing to lymphoid tissues under inflammatory conditions.⁴⁰ That is, there is increased homing to inflamed tissues in the presence of CD44. This is based on work done in mice with induced acute or chronic inflammatory conditions and showed that CD44^{-/-} lymphocytes transferred from mice with collagen-induced arthritis into wild-type mice with arthritis preferentially homed to lymph nodes and were slower to enter inflamed synovial joints than the wild type lymphocytes.

CD44 has no inherent receptor kinase or phosphatase activity; however, it is coupled to classical signaling molecules such as c-Met, members of the ErbB family receptor tyrosine kinases, and TGF- β RI.⁴¹⁻⁴⁶ In T cells, CD44 has been shown to be physically and functionally associated with p56^{lck47} as well as with Fyn.⁴⁸ The cytoplasmic domain of CD44 does not seem to contain any Src family sequence motif, but CD44 signaling may be thought of as being similar to that of integrins: an indirect transfer of information about the state of the extracellular matrix via “linker” proteins that become associated with the CD44 cytoplasmic domain after the “activation event” has occurred. A precise definition of the “CD44 signaling complex activation event” has not yet been defined. However, what is known is that there are two ways to “activate” CD44, depending on the context in which the CD44-bearing cell lives: in blood-borne cells, as well as migrating embryonic, endothelial, or malignant cells, unoccupied CD44 receptors undergo “activation” when they are bound by hyaluronan. The other scenario is tissues where hyaluronan is ubiquitous: here, multivalent hyaluronan bound by clustered CD44 is the normal resting state of the cells, and the “activation event” is begun when there is disruption of the CD44-hyaluronan interactions (by a variety of events detailed below).

When CD44 on blood-borne or migrating cells binds high molecular weight hyaluronan, CD44 clusters and this results in multiple intracellular events. The kinases c-Src, FAK, Rho, and Rac are activated,^{6,8,49} leading to closer CD44-actin cytoskeleton associations and the recruitment and activation of other signaling molecules which are involved in cell migration. CD44 also co-immunoprecipitates with Lyn, Fyn, Lck, and Hck, and in v-Src-transformed cells, CD44-HA interactions increase the phosphorylation of

Akt and MAP kinase.⁵⁰ RANTES typically signals via a G-protein coupled chemokine receptor, but can also signal via CD44 by binding to the glycosaminoglycan chains of certain CD44 variants which bear these chains and activate p44/p42 MAP kinase. Additionally, when CD44 is cross-linked by monoclonal antibodies, Lck is activated, ZAP-70 is tyrosine phosphorylated, and Pyk2 is phosphorylated in T lymphocytes.⁵¹

In tissues such as cartilage, where the quiescent state of CD44-HA interaction is multivalent binding (stable cell-matrix interactions), disruption of this binding by degradation of hyaluronan,^{52,53} cleavage of the extracellular domain of CD44,^{54,55} soluble CD44 competing for HA,⁵⁶ or the presence (and thus competition) of small molecular weight hyaluronan oligosaccharides,⁵⁷⁻⁵⁹ can cause CD44 signaling events. The major effect of this release of extracellular restraints imposed by CD44-multivalent HA binding is that the cell's sensitivity to apoptosis may increase substantially. Nitric oxide (NO) is released when HA oligosaccharides are added to many cells, including chondrocytes, and NO can downregulate PI-3 kinase and induce apoptosis in chondrocytes.^{60,61} In addition, hyaluronan can reduce anti-Fas-mediated apoptosis in chondrocytes. The pervading hypothesis, then, is that disruption of stable HA-CD44 interactions results in release of both CD44 and CD95 clustering, causing the cell surface to be more susceptible to Fas ligand and its consequent activation of apoptosis.

Apoptosis due to oligosaccharides was also observed in mammary and lung carcinoma cell lines and in glioma cells.^{57,62} Initiation of apoptosis was found to be due to inhibition of PI-3 kinase leading to an inhibition of Akt, BAD, and FKHR

phosphorylation. The sum effect was that Bcl-2 and caspase-3 activation was inhibited.⁵⁷ A similar inhibition of PI-3 kinase was observed with the use of anti-CD44 antibodies.⁶³

Other work done on signaling via CD44 has been researched in the context of tumor progression and dissemination. CD44 is coupled to the tyrosine kinases p185^{HER2} and c-Src kinase; it is actually linked via disulphide bonds to the former and has a high affinity binding site to the other. HA binding results in activation of CD44-associated p185^{HER2} and increased tumor growth. The CD44-HA interaction also leads to c-Src stimulation, and this induces increased phosphorylation of the cytoskeletal protein cortactin, which in turn attenuates its interaction with filamentous actin. This may lead to cytoskeleton-regulated tumor cell migration.⁶⁴ Additionally, CD44 can interact with Rho GTPases (such as RhoA and Rac1, which have roles in cytoskeletal movement and migration of the cell) and in breast tumor cells, CD44v3,v8-10 is noncovalently linked to RhoA.⁶⁵ Rac1 signaling regulates a pathway known to be involved in membrane ruffling, cellular projections, cell motility, and cell transformation.^{66,67} The first nineteen residues of the cytoplasmic domain of CD44 interact with the cytoskeleton via the ezrin/radixin/moesin (ERM) membrane linker proteins, which contain the phosphatidylinositol 4,5-biphosphate (PIP₂) binding motif.^{66,68} The CD44 cytoplasmic domain has a 15-amino acid ankyrin binding domain; biochemical analysis (competition studies) and *in vitro* mutagenesis, as well as deletion analysis, indicate that the ankyrin-binding domain is required for CD44-mediated "outside-in" and "inside-out" cell activation events. In addition, CD44-cytoskeleton interaction is known to be coupled with signal transducing molecules (such as p185^{HER2} and Src kinases) during tumor cell

signaling. Overall, the data suggests that this CD44-ankyrin association is pivotal for promotion of oncogenic signaling and tumor cell transformation.⁶⁹

Recently, there have been several reports which support a new mechanism for direct signaling by CD44: it is a 2-step process whereby the CD44 ectodomain is cleaved, followed by cleavage of the transmembrane (TM) domain; this releases a CD44 intracellular domain (ICD) which can translocate to the nucleus and act as a transcription factor.^{54,70,71} It should be noted that this mirrors the mechanism for the Notch receptor.⁷² Cleavage of the extracellular domain can occur by membrane-associated metalloproteinases (MMPs)⁷³ (specifically MT1-MMP⁷⁴) or ADAM10.⁷⁵ Release of the CD44 ICD is accomplished by γ -secretase cleavage of the TM domain and the CD44 ICD potentiates activation with the p300/CREB-binding protein (CBP) to activate transcription of target genes, including the CD44 gene.⁵⁴ This dual cleavage pathway is thought to modulate the role of CD44 as a docking protein and co-receptor, and may regulate cell detachment from hyaluronan during tumor cell migration/invasion.⁶³

Two of the major functions of CD44 within the context of the immune system are organ-specific homing (particularly lymph node^{19,21,76,77}), and lymphocyte activation. Lymph node (and Peyer's Patch) homing occurs via cell-surface CD44 binding to a protein called mucosal addressin, which is present on the high endothelial venules (HEV). This binding occurs via the membrane proximal domain of CD44. The variant CD44v6, which has been shown to be required for activation of T and B lymphocytes, has a crucial role in the movement and homing of antigen-activated lymphocytes in lymph nodes.^{17,78} CD44 and membrane HA is a fairly weak interaction (in comparison to

integrins and cadherins), and can indeed be an advantage in certain situations involving lymphocyte-to-lymphocyte exchange of chemical signals. This could account for the ability of CD44 to mediate T lymphocyte activation and B lymphocyte maturation.^{79,80} CD44v isoforms have been implicated in conferring both increased growth and metastatic properties on tumor cells, particularly CD44v6/7.^{81,82}

It has been reported that rolling lymphocytes may sometimes exploit epithelial cell-surface CD44 glycoprotein instead of selectin for the tethering and rolling process (the first step in extravasation), using their own cell-surface HA as a countermolecule.^{3,83,84} This data was shown in experiments tracking leukocyte entry into infected tissues through inflamed capillaries, as well as in lymphoma migration into lymph nodes. Other investigators have shown that cell-surface CD44v4-10 (not CD44s) mediates the rolling of mouse (tumor) cells on HA substrate.⁸⁴ In addition, studies have shown that CD44 can mediate leukocyte rolling under physiological flow conditions,⁸⁵ and Estess, *et al*, showed that CD44 on T cells can interact with endothelial HA to mediate rolling under shear stress, with a secondary firm adhesion occurring via VLA-4.⁸⁶ Clark, *et al*, demonstrated that the rolling of tonsillar lymphocytes on cultured tonsillar stromal cells was dependent on CD44-HA binding by inhibiting lymphocyte rolling via addition of anti-CD44 antibodies, soluble HA, and hyaluronidase treatment.²¹

Lymphocyte CD44-dermal endothelial HA interactions can result in lymphocyte homing to sites of inflammation.⁸⁷ Pro-inflammatory cytokines such as TNF α and IL-1 enhance endothelial presentation of HA, thus presenting an immobilized HA surface

conducive to lymphocyte rolling. This HA is resistant to fluid shear forces as it is anchored to endothelial CD44⁸⁸. TNF α also induces TSG-6, another HA-binding protein, which can present HA to the lymphocytes and facilitates enhanced lymphocyte rolling and adhesion (over HA without TSG-6).⁸⁹ It has been shown that CD44-HA interactions play a key role in mediating lymphocyte rolling to enhance leukocyte adhesion at sites of inflammation,⁶³ and it has been hypothesized that the inflammatory cascade might also be affected by the affinity of the appropriate CD44 variant expression on the circulating lymphocyte, though this has not yet been proven directly.

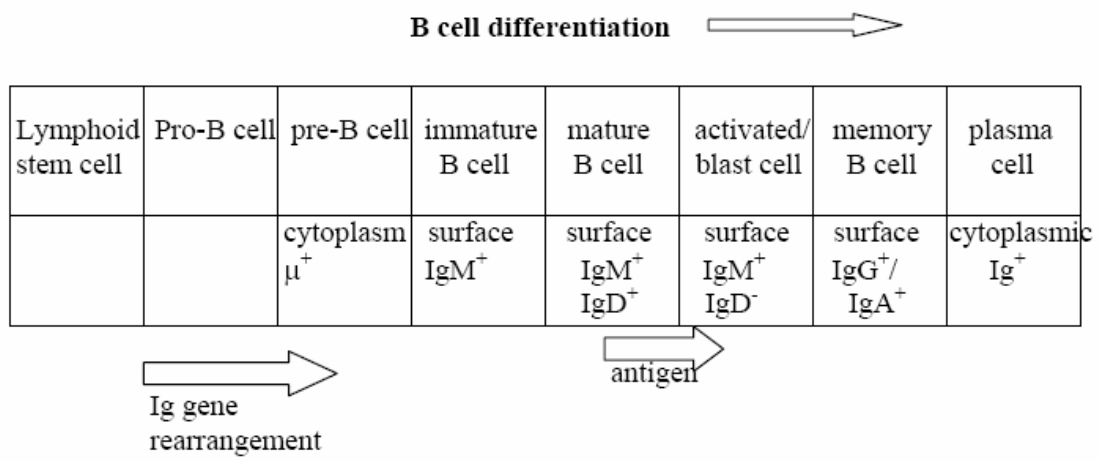
Ligation of CD44 by anti-CD44 Ab can trigger effector functions in T lymphocytes, activate monocytes, and enhance natural killer cell-mediated cytotoxicity.^{36,37,90-95} Interaction between hyaluronate and CD44, as well as between anti-CD44 mAbs and CD44, results in murine B cell activation and a phenotype closely resembling a germinal center B cell.^{96,97}

II. B lymphocytes in the Immune System.

A. Introduction. B lymphocytes are members of the adaptive immune system and arise from lymphoid progenitor stem cells in the bone marrow (see Figure 3 for an overview of B cell development). They progress through stages – pro-B, pre-B, immature B, and mature B cell – with the identity of the individual B cell depending on the genes expressed at each stage and on productive rearrangements of the genes which produce the B cell receptor Ig (immunoglobulin). As a pro-B cell, there is VDJ rearrangement of the heavy chain genes; the pre-B cell expresses a “pre-B receptor” (μ chain) combined with a surrogate light chain; light chain VJ gene rearrangement results in an immature B cell

Figure 3. This shows a very general overview of B cell development and differentiation.

(Schematic is drawn with inspiration from Immunology, 4/e, by Roitt, Brostoff, and Male, 1996 Times Mirror International Publishers Unlimited)



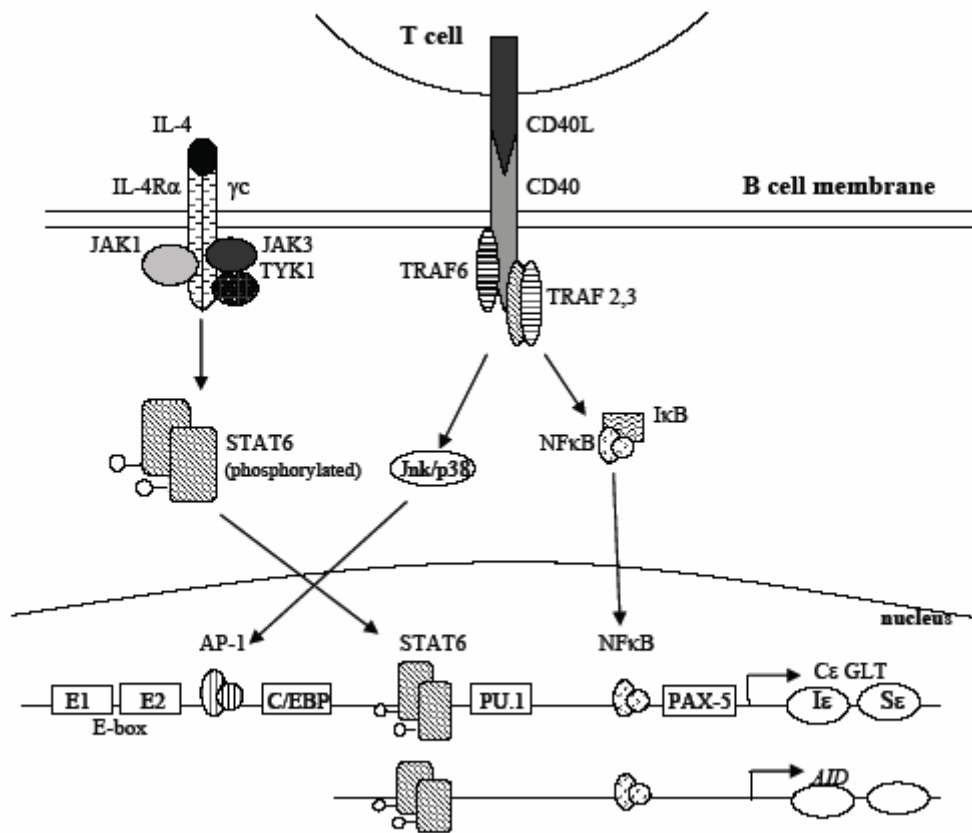
expressing a full-size B cell receptor (membrane IgM); the mature B cell expresses IgD and IgM. This mature B cell is considered functionally naïve because it has not yet seen antigen.

B. CD44 and B cells. B cell activation and differentiation are regulated by components in the surrounding microenvironment.⁹⁸ During the differentiation of a mature naïve B cell into an activated B cell, cell-cell interactions, as well as soluble molecules, mediate phenotypical changes. The involvement of cell-matrix interactions is still uncharacterized, but may represent a novel mechanism for regulation of lymphocyte activation. It is known that different adhesion molecules and homing receptors, including selectins, integrins, and members of the Ig superfamily, can influence the cellular response, and CD44 is a representative adhesion molecule that is capable of affecting B cell responses.⁹⁷ The functional role of CD44 on B cells is relatively unknown, although the protein has been implicated in B cell differentiation and activation in several previous studies⁹⁹⁻¹⁰³. These studies showed that CD44 expression on B cells is rapidly induced via interaction of CD40-CD40L,¹⁰⁴ as well as by IL-5.¹⁰⁵ B cells upregulate CD44 upon activation,^{20,78,106} and mature mouse B cells can be activated *in vivo* by interaction of hyaluronate and CD44.⁹⁶ During the germinal center reaction, however, CD44 is downregulated.¹⁰⁷⁻¹⁰⁹ CD44 ligation in human B cells also results in upregulation of the genes for IL-6, IL-1 α , and β_2 -adrenergic receptor (β_2 -AR) – indicating a role in immunomodulation and inflammation.¹¹⁰

C. Pathways of B cell Activation.

C1. CD40 and its ligand CD40L (CD154). CD40, a 45-kD transmembrane glycoprotein, is a member of the tumor necrosis factor receptor (TNFR) family and is expressed on B lymphocytes, monocytes, and dendritic cells, as well as endothelial and epithelial cells. Its ligand, CD40L, is expressed primarily on activated CD4⁺ T cells. CD40 signaling (Fig. 4) has important roles in the following functions: 1) promotion of the activation and differentiation of B cells by T-cell-dependent antigens; 2) germinal center formation 3) Ig class switching 4) affinity maturation (of Ig on B cells) and 5) the development of plasma cells and memory B cells.¹¹¹⁻¹¹³ Binding of CD40L to CD40 causes the CD40 monomer to cluster in lipid rafts in order to propagate the signal; the cytoplasmic tail of CD40 has binding sites for TRAF (TNF receptor-associated factor) proteins, which act as adaptor proteins to couple CD40 to the phosphoinositide-3 kinase (PI3K), phospholipase C γ (PLC- γ), mitogen-activated protein kinase (MAPK-ERK, p38, and JNK), and nuclear factor κ B (NF κ B) signaling pathways. The primary pathway of interest for this discussion is the NF κ B pathway; the others are involved in the inhibition of genes involved in cell cycle arrest and promotion of genes related to cell cycle progression. The intracellular domain of CD40 both associates with and signals through TRAF2, TRAF3, TRAF4, and TRAF6, although recent research has shown that TRAF6 is dispensable; upon oligomerization of CD40, TRAF2, TRAF5, and TRAF6 encourage the dissociation of NF κ B from its inhibitor, I κ B. NF κ B can then translocate from the cytoplasm to the nucleus and synergizes with Signal Transducer and Activator of Transcription-6 (STAT6) to activate the I ϵ promoter, the first step in class switching by inducing production of C ϵ GLTs.^{111,113,114} Additionally, CD40 can activate signal

Figure 4. CD40 signaling. The CD40 signaling pathway is shown here. It is a primary B cell signaling pathway utilized as a costimulatory pathway to induce B cell activation and, in vivo, germinal center initiation. The IL-4 pathway is also shown. (*Schematic is drawn with inspiration from Geha, et al¹¹¹*)



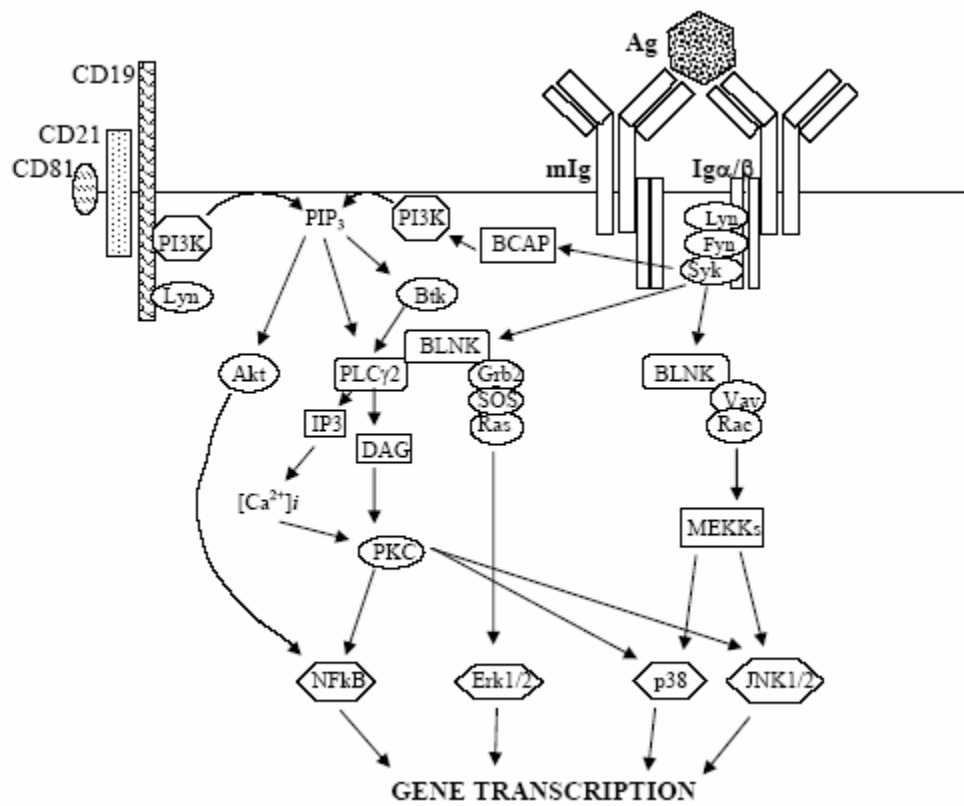
transducer and activator of transcription 6 (STAT6) and the Janus kinase 3/STAT3 pathway independently of the TRAFs.

CD40-CD40L ligation also synergizes with IL-4 to induce expression of activation-induced cytidine deaminase (AID), which is crucial for class switch recombination (CSR) and also is important for somatic hypermutation. For example, when B cells switch to IgE, IL-4 signaling leads to STAT6 homodimerization and its subsequent binding to a response element in the AID gene; CD40 ligation causes a signaling cascade that leads to NF κ B binding to two sites in the AID gene. This synergy is important - STAT6-deficient mice or NF κ B p50-deficient mice have impaired ability to induce AID expression. This “two signal” requirement – IL-4-induced STAT6 and CD40-induced NF κ B working together to initiate AID expression – seems to be required to overcome a potential threshold level of AID expression so that CSR to IgE can occur.^{111,113,115} Two signals are required for the induction of AID and the eventual expression of other immunoglobulin isotypes also.

C2. B Cell Receptor (BCR). The B cell antigen receptor (BCR) plays a crucial role in the development and survival of B lymphocytes as well as the response to antigen. The BCR is a multiprotein structure composed of membrane Ig (mIg) and Ig α (CD79a) plus Ig β (CD79b) chains, which are noncovalently attached. The mIg is produced from the rearrangement of VDJ segments for the heavy and light chain genes and functions to bind antigen, while each Ig α and Ig β chain contains a single ITAM (Immunoreceptor Tyrosine-based Activation Motif). These ITAM motifs contain two tyrosines precisely spaced, along with a specific amino acid sequence, to provide a binding site for src-

homology-2(SH2)-domain-containing proteins and thus functions to begin the signal transduction pathway (Fig 5). CD19 is a B cell coreceptor that lowers the signaling threshold, thereby augmenting the signals received through the BCR; however, it is not crucial to B cell development prior to the mature B cell stage. When antigen becomes bound to mIg and receptor aggregation is induced, the two ITAM sites on Ig α / β are phosphorylated by Src family protein tyrosine kinases (PTK) such as Lyn, Fyn and Blk. Lyn can have both positive and negative effects on BCR signaling – it is, indeed, vital to negative regulation of the BCR, as it can phosphorylate ITIMs (Immunoreceptor Tyrosine-based Inhibition Motif) on Fc γ RIIb and CD22, both of which play a role in inhibition of the BCR response. Once src-family PTKs have become active, progressive amplification of the ITAM phosphorylation occurs and additional effector proteins/lipids are recruited. Another src-family PTK, Syk, binds to the ITAM with appreciable affinity via its SH2 domains only once the ITAM is doubly phosphorylated, which facilitates further Ig α / β phosphorylation and subsequent initiation of downstream signaling events. There is a check and balance system “in the house”. B220 (also known as CD45) is a transmembrane tyrosine phosphatase that modulates BCR signaling by ensuring that a small population of the src-family PTKs, such as Lyn, are in a “positive” state of phosphorylation so that they are in readiness for a response to BCR aggregation. The C-terminal src tyrosine kinase (Csk) counters this by keeping some src PTKs “repressed” via phosphorylation of their C-terminal inhibitory tyrosine.¹¹⁶⁻¹¹⁸ BCR ligation leads to activation of phosphatidylinositol-3-kinase (PI3K), which phosphorylates phosphatidylinositol-4,5-biphosphate, which creates phosphatidylinositol-3,4,5-

Figure 5. BCR signaling. This diagram shows the relationship of the multiprotein complex called the BCR and various signaling molecules which mediate and amplify the signals received; the cascade that is initiated determines the B cell response in development and survival or to antigen recognition. (*Schematic is drawn with inspiration from Gauld, et al, and Dal Porto, et al^{116,117}*)



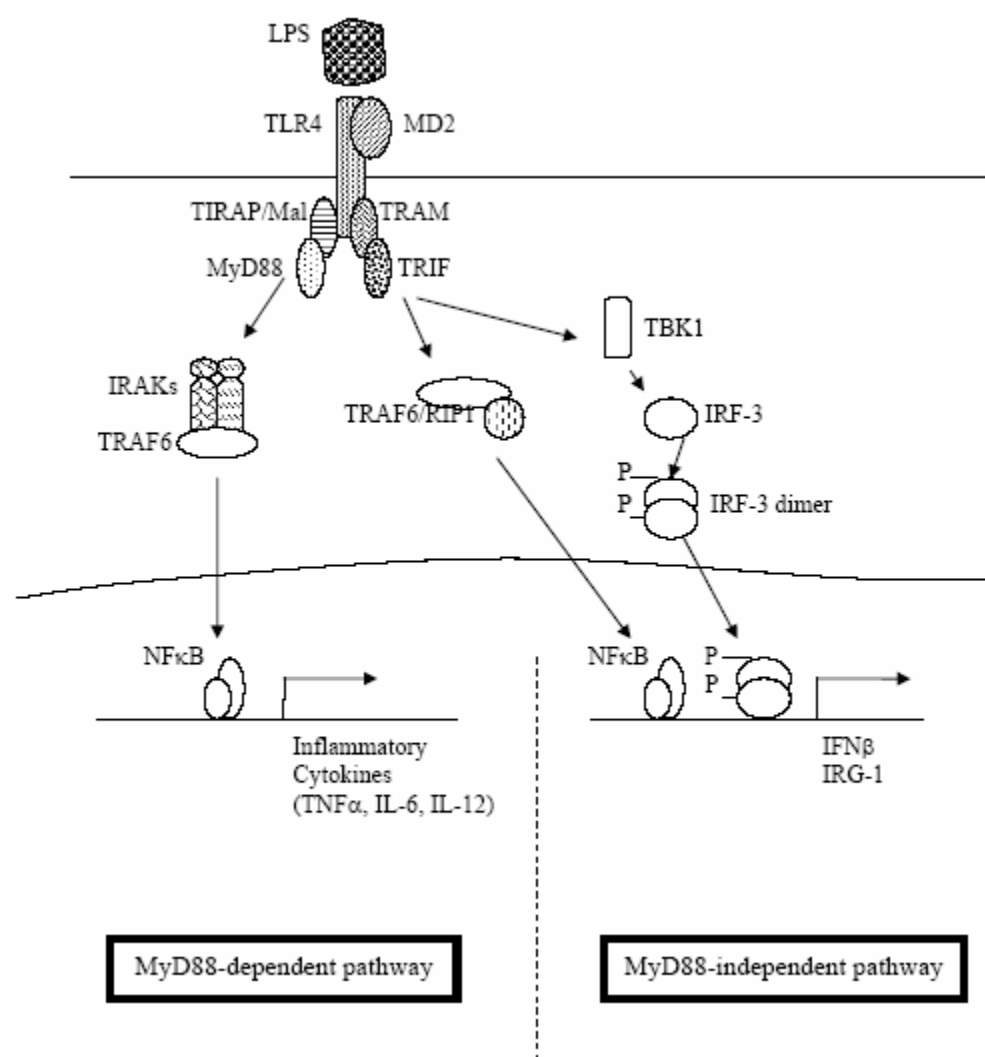
triphosphate [PI(3,4,5)P₃], also called simply PIP₃. This phospholipid then recruits PH-domain containing proteins like the Tec-family kinase Btk or the serine-threonine kinase Akt, putting them into close proximity to membrane-associated substrates and other phospholipid-binding pleckstrin homology (PH)-domain containing molecules, and any or all of these may serve a function in the ongoing signal propagation. CD19, the BCR co-receptor briefly mentioned earlier, is an integral transmembrane glycoprotein which associates with CD21 (complement receptor 2, CR2) and CD81 in a tri-molecular complex; this complex also associates with the BCR via CD21 binding to complement bound to the antigen. Once BCR ligation has occurred, the tyrosines in the cytoplasmic tail of CD19 are phosphorylated by Lyn; this creates binding sites for the p85 adaptor subunit of PI3K, as well as for other SH2-domain containing proteins. The adaptor/scaffold protein BCAP can also be tyrosine phosphorylated and attract PI3K. This binding localizes PI3K close to its lipid substrates and increases its catalytic activity.¹¹⁶⁻¹¹⁸

Once Lyn, Syk, and Btk have been activated, the adaptor molecule B cell LiNKer protein (BLNK), which is quickly phosphorylated by Syk following BCR aggregation, helps to recruit PLC γ 2 (via the SH2 domain of PLC γ 2), associates with the SH2 domains of Btk, and functions to couple BCR signaling to [Ca²⁺]_i influx. BLNK acts as a major platform for the assembly of effector molecules and this is also where the signaling pathways diverge. PLC γ 2 cleaves PI(4,5)P₂ into the second messengers inositol 1,4,5-trisphosphate (also called IP₃) and diacylglycerol (DAG). Creation of IP₃ causes increased [Ca²⁺]_i, which is necessary for the activation of numerous transcription factors,

among them NF κ B and N-FAT. DAG activates protein tyrosine kinases (PKCs), and these regulate the mitogen-activated protein kinase (MAPK) family proteins. Three of the most important MAPK family proteins, which phosphorylate different sets of transcription factors, are extracellular signal-regulated kinase (ERK), c-Jun N-terminal kinase (JNK), and p38 MAPK; ERK activates Elk-1 and c-Myc, JNK activates C-Jun and ATF-2, and p38 MAPK activates ATF-2 and MAX. Akt and PKC activation both eventually terminate in NF κ B activation and translocation into the nucleus where it activates the transcription factors Bfl-1 and Oct-2. In summary, these events, illustrated in Fig. 5 and discussed above, lead to B cell activation and maturation.^{116,117}

C3. LPS – the “innate” activator. Toll-like Receptors (TLR) (Fig. 6) are Type I integral membrane glycoproteins which act as a “bridge” between the innate and adaptive systems, since these receptors are found on macrophages, dendritic cells, T cells, and B cells. Interestingly, they have significant target specificity; TLR proteins recognize a diverse array of ligands on bacteria, fungi, viruses, and parasites. The ligands are known as pathogen-associated molecular patterns (PAMPs), and examples are Gram-negative bacterial lipopolysaccharide (LPS), Gram-positive bacterial peptidoglycan, bacterial flagellin, DNA, and RNA. The TLR family of proteins has a cytoplasmic tail containing a toll/IL-1 receptor (TIR) domain, so named because of its similarity to the IL-1 receptor. This TIR domain is the active motif that initiates signaling when ligand is bound.¹¹⁹⁻¹²² Significant expression of TLRs on human B cells is seen only for TLR1 and TLR6-10; these are upregulated in response to antigen-BCR or CD40 ligation. However, murine B cells express TLR4 in response to LPS exposure (Fig. 6), and the cells proliferate and

Figure 6. TLR4 pathway. LPS bound to the TLR4/MD2 proteins initiates a signal cascade resulting in NF κ B activation and the subsequent expression of inflammatory cytokines and interferons. (*Schematic is drawn with inspiration from Fitzgerald, et al¹¹⁹*)



differentiate into plasma cells *in vitro*. When LPS is present, it will be bound first by LPS-binding protein (LBP), which is present in serum, and this opsonic activity enhances the detection of LPS in the blood (by about 300-fold).¹¹⁹ This complex of LBP/LPS will be bound by CD14, a GPI-linked protein^{123,124} that has no intrinsic signaling capacity. LBP is also found as a soluble protein which enhances LPS binding by 1000-fold for leukocytes that do not express CD14.^{123,124} TLR4 is expressed on the B cell surface in complex with MD-2, and this heterodimer participates in recognition of CD14/LPS and initiates intracellular signaling via two pathways. One is the MyD88-TIRAP (Myeloid Differentiation factor 88-TIR-domain-containing adaptor protein) pathway, which regulates the activation of NFκB (which heterodimerizes with AP-1) and related inflammatory cytokine production; the second is the TRIF-TRAM (TIR domain-containing adaptor Inducing IFNβ-TRIF-related Adaptor Molecule) pathway (also called the MyD88-independent pathway), which controls the activation of the transcription factor interferon regulatory factor-3 (IRF-3) (with STAT1) and the induction of Type I interferons and costimulatory molecules.¹¹⁹⁻¹²²

The MyD88-dependent pathway operates as follows: upon stimulation, MyD88 – which possesses both a TIR domain and a death domain – recruits a serine-threonine kinase called IL-1-receptor-associated kinase (IRAK) via the death domains of each molecule, and IRAK then becomes activated and associates with TRAF6. TRAF6 activation leads to NFκB activation and transcription of genes related to the inflammatory process, such as TNFα, IL-6, and IL-12. TIRAP is also associated with MyD88 and in

the case of a deficiency of either MyD88 or TIRAP, NF κ B activation is delayed but still occurs.¹¹⁹⁻¹²²

The MyD88-independent pathway also utilizes TIRAP. Activation and homodimerization of IRF-3 occurs via TIRAP after LPS stimulation, and it translocates into the nucleus to switch on genes for IFN β and other IRGs (interferon regulatory genes). A third protein involved in LPS signaling is TRIF; it activates IRF-3 and is a very potent activator of the IFN β promoter. TRAM, about which less is known, does associate with TIRAP and TRIF, but not with MyD88. According to TRAM-knockout mouse studies, TRAM is essential to MyD88-independent LPS signaling via the TLR4 pathway.¹¹⁹⁻¹²²

C4. Interleukin-4. IL-4 is a pleiotropic Type 1 cytokine produced by CD4⁺ T cells (T_H2), mast cells, basophils, and NK T cells (these express NK1.1); it has also been reported to be produced by $\gamma\delta$ T cells and eosinophils. T helper (T_H) cells are a functional subclass of T cells – T_H1 cells help to generate cytotoxic T cells and T_H2 cooperate with B cells in the generation of antibody-mediated responses. Two major functions of IL-4 include differentiation of antigen-stimulated T cells (into T_H2 type cells) and control of the specificity of B cell immunoglobulin class switching (in mouse, to IgE and IgG₁). IL-4 also has a number of other functions in hematopoietic cells, including upregulation of expression of MHC class II in B cells, upregulation of CD23, upregulation of the IL-4 receptor (IL-4R), and can act as a mitogen for B cell growth. In inflammation, it can also act with TNF to induce expression of VCAM-1 (vascular adhesion molecule-1) on

vascular endothelial cells and downregulates their expression of E-selectin (this is thought to favor recruitment of T cells and eosinophils rather than granulocytes).¹²⁵

The IL-4 receptor complex is made up of an α chain (IL-4R α) and a γ c chain; the IL-4R α binds IL-4 and the γ c chain initiates clustering of the IL-4 receptors. The γ c chain is responsible for the initiation of the signaling pathway (Figure 4). IL-4 engagement (crosslinking) of the IL-4R causes tyrosine phosphorylation of Jak (Janus family tyrosine kinase) proteins, which then phosphorylate the IL-4R α chain. Jak-1 associates with the IL-4R α chain, while Jak-3 associates with the γ c chain. Once the IL-4R α chain is phosphorylated, sites for SH2- or PTB-domain-containing adaptor proteins become available. There are three main signaling pathways: the IRS1/2 pathway, the Shc pathway, and the STAT6 activation pathway.

The IL-4 phosphorylation substrate (4PS), also called IRS2 due to its high homology with IRS1 (insulin receptor substrate), interacts with PI3K to initiate pathways that lead to PKC and Akt activation and subsequent cell growth and survival. IL-4R α chain interaction with SH2-containing collagen-related protein (Shc) can lead to activation of Grb2, Sos, and Ras/MAPK pathways, culminating in cell growth and differentiation.

STAT6 activated by IL-4 is crucial for activation or enhanced expression of many IL-4-responsive genes such as MHC class II, CD23, germline immunoglobulin ϵ (see Fig. 3) and γ 1, and IL-4R α chain. Upon IL-4 engagement, the IL-4R α chain is phosphorylated by the Jaks and STAT6 docks to the receptor via its SH2-domain. The receptor-associated kinases phosphorylate STAT6, which then disengages from the receptor,

proceeds to form homodimers with other STAT6 proteins via their same SH2 domains, and translocates to the nucleus. In the nucleus, STAT6 homodimers bind to consensus STAT6 binding sites in IL-4-responsive genes to activate/enhance transcription.¹²¹

D. Immunoglobulin E. Immunoglobulin E (IgE) is one of five classes of antibodies. It is involved in protective immunity only in cases of parasite invasion; worms and other parasites are opsonized by IgE and IgG, leading to the further activation and recruitment of eosinophils, macrophages, neutrophils, platelets, and the activation of complement. In developed countries where national hygiene is promoted, there is little problem with parasites. However, IgE can be produced in response to innocuous particles – an unfortunate and exaggerated reaction called an allergic response. Normal individuals have very small amounts (ng/ml) of IgE, as compared to IgG ($\mu\text{g/ml}$ to mg/ml), and IgE is elevated (particularly Ag-specific IgE) in allergic individuals. Both genetic and environmental factors also play a role in any individual's predisposition to allergic disease. The most common allergic diseases include asthma, allergic rhinitis (hay fever), atopic dermatitis, and food allergies. The most dangerous of the allergic reactions is systemic anaphylaxis, which can be induced by any one of a number of antigens – such as an insect sting. Allergies affect up to $\frac{1}{3}$ of the population, and are therefore an important disease state to be studied.

The IgE molecule is a member of the immunoglobulin family and is composed of two light chains and two heavy chains. The light chains, either λ or κ , each contain a constant and a variable domain, and the identical heavy chains (ϵ chain) have four constant region domains and one variable domain. The antigen-binding specificity lies in

the variable domains of the heavy and light chains, while the effector function and isotype specificity are dictated by the heavy chain constant region.

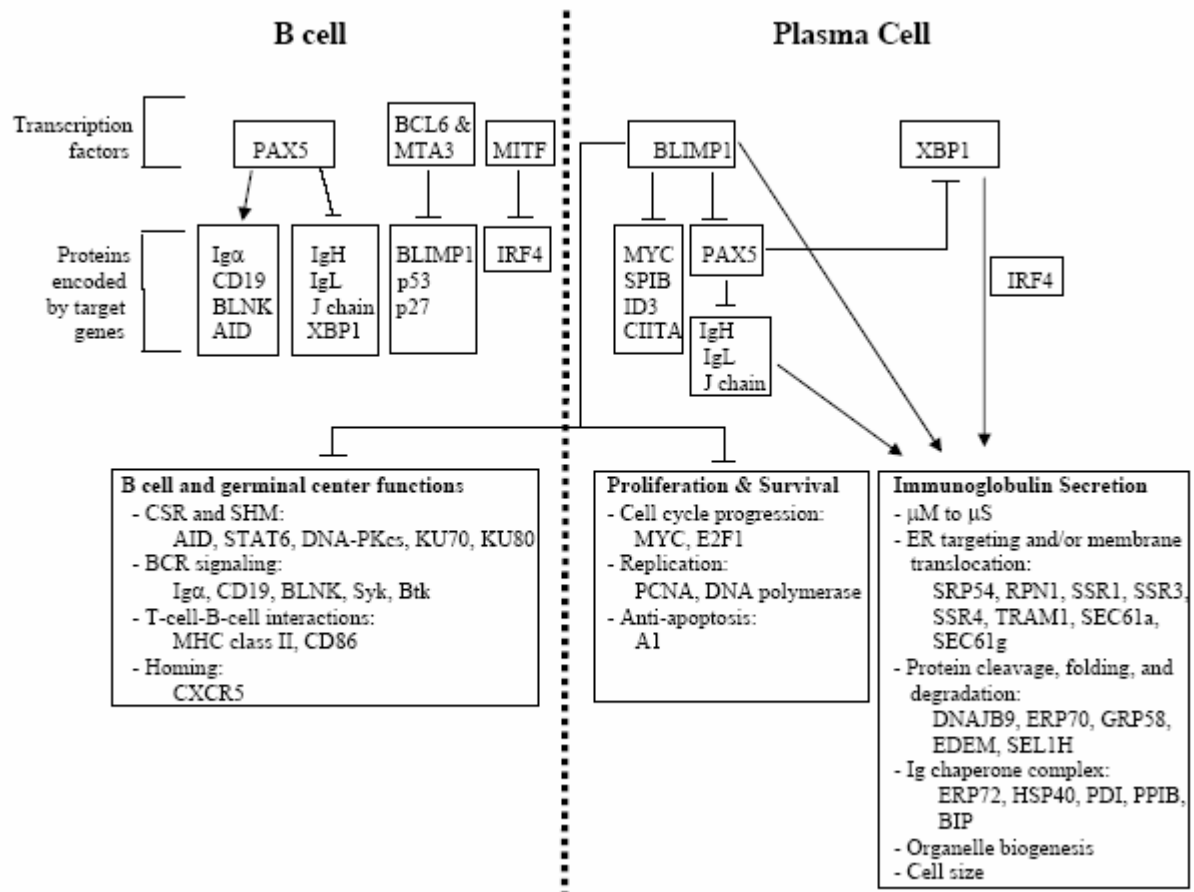
E. Class Switch Recombination. When B cells class-switch (from IgM) to express IgE, the first step is to synthesize germline Ig RNAs. These germline transcripts ($I\epsilon$ in this case) are “sterile” because they do not code for proteins due to stop codons. However, they do serve to initiate isotype switching. A recombination event (i.e., isotype switching or class switching) then occurs wherein a downstream constant heavy-chain (CH) gene is juxtaposed to the expressed V(D)J genes. V (variable), D (diversity), and J (joining) regions make up the variable region of the heavy chain, and when the new CH gene joins the V(D)J, the intervening sequences are deleted. The S (switch) region, which flanks each CH gene, is the recognition sequence for the joining process during switch recombination.¹²⁶ These molecular events take place when the B cell has been activated and is in secondary lymphoid tissue.

Regulation of isotype switching to IgE is dependent on cytokines and cell surface molecules. Interleukin-4 (IL-4) and/or interleukin-13 (IL-13, human only), cytokines secreted by T cells, mast cells, and basophils, are necessary but not sufficient for induction of class switching; a second signal is required to switch to any isotype. This second signal is CD40L, which is expressed by activated T cells responding to antigen. This binds to CD40 on B cells and, together with IL-4, causes a signaling cascade that results in ϵ germline RNA synthesis. Other cytokines and cell surface molecules have been shown to affect IgE synthesis. Downregulation of IgE *in vitro* has been attributed to interferon- α (IFN α), IFN γ , IL-8, IL-10, IL-12, and transforming growth factor β (TGF β).

Also, the interactions between sCD23-CD21 and CD28-B7 have been shown to increase IgE production. The molecular regulation and modulation of IgE production are reviewed in detail in ¹²⁶. IL-4 directs class switching to both IgG₁ and IgE, but the second signal can be a T-I (thymus-independent) antigen such as LPS or cell-contact-dependent signals through cell-surface proteins such as the TCR (T Cell Receptor).

F. Plasma Cell Differentiation. After a B cell is mature (although naïve), it can encounter its cognate antigen, usually within the context of the spleen or lymph node. This interaction, along with CD4⁺ T cell help and follicular dendritic cells, leads to germinal center formation, affinity maturation, and class switch recombination. The B cells now differentiate into plasma cells and migrate to the bone marrow. The gene expression profile of an activated germinal center B cell is significantly different than that of the plasma cell (see Fig. 7). PAX5 (PAired box Protein 5; formerly called BSAP), which can act as either a transcriptional activator or repressor, is required to maintain B cell identity. PAX5 activates Activation-Induced cytidine Deaminase (AID), which plays a vital role in class switch recombination, and represses the expression of X-box-binding protein 1 (XBP1), the IgH, the IgL, and the J (joining) chain, all of which are important for plasma cell development. While PAX5 must be repressed to induce plasma cell formation, experiments have shown that loss of PAX5 is not sufficient to induce expression of BLIMP1 (discussed below) or to induce plasma cell differentiation.¹²⁷ A key intermediate in CD40-mediated B cell activation is to apurinic/apyrimidinic endonuclease 1 (APE-1) redox factor 1 (Ref-1). CD40 ligation leads to APE/Ref-1

Figure 7. Plasma cell differentiation. The gene expression profile of a B cell characterizes its identity: activated B cell or plasma cell. The key proteins and transcription factors as well as the important known target genes are shown below. In the text boxes, the gene expression programs are summarized. These transcription factors regulate these genes either directly or indirectly. The transcription factors BCL-6, MTA3, MITF, and PAX5 all repress plasma cell formation by repressing BLIMP1, XBP1, and IRF4. When B cells begin the plasma cell development pathway, BLIMP1 represses the B cell gene expression program. Mutual repression prevents activated B cells from spontaneously progressing to the plasma cell stage and prevent plasma cells from reverting to activated B cells. (*Schematic is drawn with inspiration from Shapira-Shelef, et al¹²⁷*)



translocation from the cytoplasm to the nucleus, where it modulates PAX5 and early B cell factor; importantly, this protein is crucial to CD40-mediated PAX5 activation.¹¹⁴

Microphthalmia-associated transcription factor (MITF) also inhibits plasma cell formation by repression of interferon-regulatory factor 4 (IRF4) expression; loss of MITF results in loss of the mature resting state and initiation of the plasma cell program.¹²⁷

Another transcription factor, B-cell lymphoma 6 (BCL-6), is crucial to germinal center formation, as it represses the expression of B lymphocyte-induced maturation protein 1 (BLIMP1). BCL-6 performs this function by interfering with AP-1 transcriptional activators and also by binding a site within the BLIMP1 gene. MTA3 (metastasis-associated 1 family, member 3) interacts directly with BCL6 to repress BLIMP1; loss of MTA3 leads to spontaneous expression of BLIMP1. Another important repressor of plasma cell differentiation is BACH2 (BTB and CNC homology 1, basic leucine-zipper transcription factor 2), although its mechanism of action has yet to be defined.¹²⁷

Plasma cell differentiation is driven by expression of several different transcription factors. BLIMP-1, a transcriptional repressor, is required for plasma cell formation and immunoglobulin secretion; it represses genes involved in cell cycle progression and genes involved in maintenance of the identity of a mature GC B cell (such as PAX5 and BCL-6), while inducing genes related to immunoglobulin secretion pathways, such as IRF4. Repression of PAX5 leads to derepression of the IgH, IgL, J chain, and XBP1 gene expression.¹²⁷

XBP1 is critical to plasma cell differentiation and acts downstream of BLIMP1 as a regulator of the secretory phenotype in plasma cells. IRF4 is a transcriptional activator whose role is not yet clearly delineated, but evidence indicates that it gives the “go ahead” to the B cell for transition to plasma cell development by inducing the proliferation necessary to do so. The exact mechanisms regulating the transition from germinal center B cell to plasma cell are not known; generally, some factors must be released from repression, and others must be downregulated or repressed.¹²⁷ What is known is briefly outlined above.

Immunoglobulin secretion is regulated by BLIMP1 and XBP1. BLIMP1 acts by repressing PAX5 and thereby derepressing the transcription of IgH, IgL, and the J chain; it also induces expression of IRF4 and OBF1 (octamer-binding transcription factor (OCT)-binding factor 1), which function to activate various enhancers and promoters of genes that encode proteins of the Ig chains. XBP1, whose mRNA is induced by activating transcription factor 6 (ATF6) and is processed by inositol-requiring 1 α (IRE1 α), is critical to the secretory program in plasma cells. It induces genes whose products are involved in ER targeting and translocation, protein folding, protein degradation, glycosylation of proteins, ER-to-Golgi trafficking, and targeting of Golgi vesicles to the membrane. XBP1 also is involved in cell size and in increasing the size of the ER.^{127,128}

For an overall picture of the events outlined above, please see Figure 6.

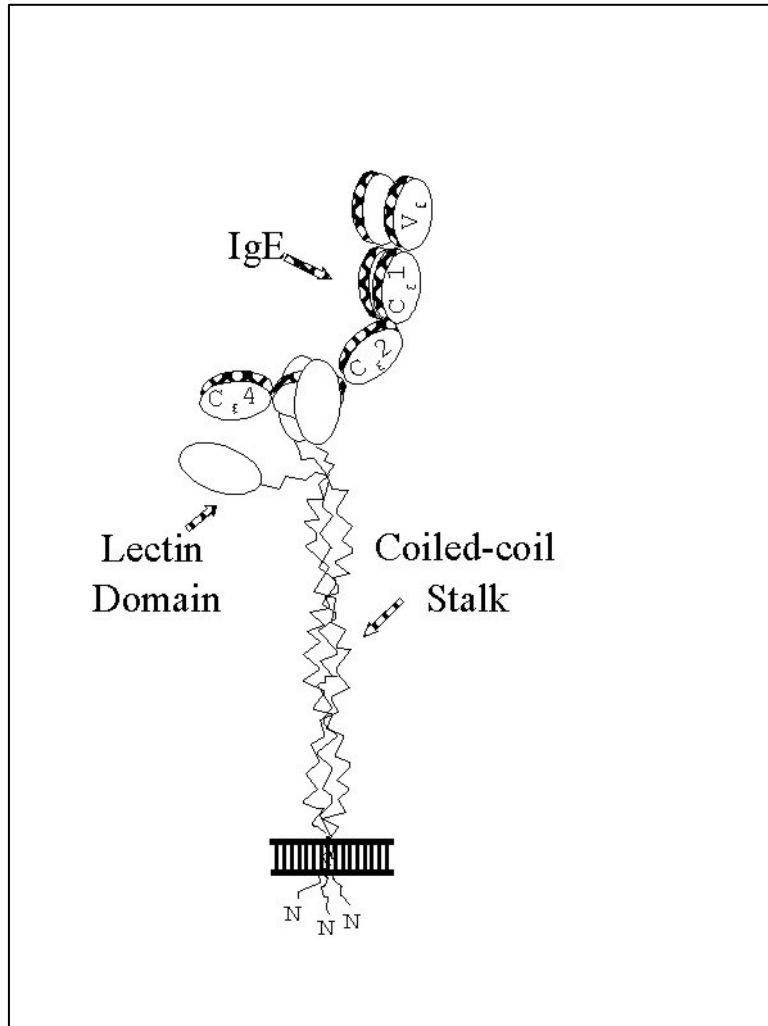
III. CD23 (Fc ϵ RII), the low affinity IgE receptor.

A. Introduction to CD23. The two types of Fc receptors for IgE are called Fc ϵ RI and Fc ϵ RII. Fc ϵ RI is a high affinity receptor that is involved in allergic mediator release. The

other, FcεRII (CD23), is a low affinity receptor for IgE. CD23, first described by Lawrence *et al.*,¹²⁹ is a natural regulator of IgE production.

B. Structure. FcεRII (CD23) (Fig. 8) is a member of the calcium-dependent (C-type) lectin family,¹³⁰ which require calcium for ligand (IgE) binding.¹³¹ Other proteins contain this lectin “cassette”, including cell adhesion proteins (selectins).¹³² CD23 does not, however, bind to IgE via a carbohydrate epitope¹³³ like other members of this family, such as the asialoglycoprotein receptor;¹³⁴ instead, the lectin homology region contacts the IgE. CD23 is a Type II integral membrane protein with an extracellular carboxyl terminus. A series of repeat regions (3 in humans, 4 in mouse), composed of 21 amino acids each, extend from the cell membrane to the lectin domain - the “stalk” region. General differences between the human and mouse CD23 include a shorter C-terminal region in mouse CD23 with loss of the inverted RGD sequence; mouse CD23 also has an additional repeat region and an additional N-linked glycosylation site, both of which are used.¹³⁵ Gould *et al.*¹³⁶ found that the region of homologous repeats had a repetitive heptad pattern similar to that of tropomyosin; this kind of pattern has a periodicity of seven in the distribution of hydrophobic and hydrophilic residues. These structures are predicted to form α -helical coiled-coils with two or three individual molecules interacting with each other.¹³⁷ This lab has obtained considerable evidence to support this model, and the data indicates that receptor-receptor association is critical for ligand binding. Crosslinking studies confirm that the stalk domains form oligomers and suggest that the trimer is formed and binds IgE in a divalent manner involving two of the lectin heads interacting with either symmetrical or non-symmetrical sites on IgE.

Figure 8. *Model for associated trimeric CD23. The stalk of the CD23 molecule forms a coiled-coil structure. This would allow the lectin heads to interact in a divalent (or trivalent) manner with IgE (published in Conrad, DH, et al. ¹³⁸).*



CD23 breakdown can occur at the cell surface¹³⁹ via cleavage by an uncharacterized membrane-associated metalloprotease to release a monomeric 38Kd (mouse) or 37Kd (human) molecule consisting of the carboxy-terminal portion of CD23 (soluble CD23 or sCD23). Further breakdown usually occurs due to the first fragment remaining quite labile.^{135,140,141} In man, both fragments (37 and 25 Kd) have IgE-binding capacity and the IgE interaction has been mapped to the lectin homology region of CD23.¹⁴¹⁻¹⁴³ The IgE-binding capacity of murine sCD23 is known to be a matter of affinity and is related to the capacity of the receptor to self-associate. It is noteworthy that mice transgenic for sCD23 displayed no changes in IgE responses, suggesting that the associated form of CD23 is required for the regulation of IgE.

Cellular CD23 levels are known to be regulated by two different mechanisms. On B cells, CD23 is protected from degradation while present on the cell surface; IgE does not cause an increase in CD23 biosynthesis.¹⁴⁴ The second mechanism is cytokine-specific upregulation. IL-4/STAT6 are very important in CD23 regulation, as seen in the IL-4¹⁴⁵ and STAT6^{146,147} knockouts – which had very low CD23 expression. IL-4, however, has no effect on surface CD23, unlike IgE; rather, it increases the expression of CD23 by increasing the levels of mRNA and protein.¹⁴⁸

The genetic structure of the human and mouse CD23 is similar. A second isoform of CD23 was discovered in man,¹⁴⁹ and the two forms are called CD23a and CD23b (Fig 9). The second isoform (CD23b) is caused by an alternative transcription initiation site, but the actual difference between the two isoforms is only the 6 amino-terminal amino

Figure 9. The murine CD23a and CD23b promoter sequences. This details their transcription factor binding sites and the placement of exons.

CD23a

CAGATTCAGTCCACCACAGGTTTGATTTCAGATCCAGGTTGTGTCATTTCTTCCTTCTGCATTTTCAAGAGTTCTGA

TTGGCATCGCTGACTCTCCAACAGTTTGCTTAC **C/EBP motif 1** **STAT6 site** **NFκB1 site**
CTGAGAAATA AAGGTAATAATAGCCCGGACTTCCCCAGGTTCTA
C/EBP motif 2

NFκB2 site **TATA box**
 GGGAGCACCAAAAAAGGCCTTGTGTGTGCTGTGGCCACCCAGGCGGTGAGCCCATAATTAGGTC TATA AAAATAGAA

Transcription start site **Exon 1**
 GCCATTAATGAAGTCTC ACAGAA GACTACTGTCTTCAACACACTAGCCTGAGCTACCTTATCCAAGTGCTCCACAT

ATTCCAGAAGGAGAAGGACAGACTTCAAGTTCAA GTGAGTTTGTATTTATATGGGGCGNGGNNNNAGANGGGGGCA

ACGGTATGGACAGAATCAAGAGGCATATGGGTCTCAGCTTCGGTCCTAAG

CD23b

Exon 2

AGGTAGTGCACGCCTCATCACTGAAAGGATCCAAACAAGACTGCCATGGAAGAAAATGAATACTCAGGTAGGAAGAT

NFκB site
 TCCCAGGTGCCAATGCTGGCACTCATTTTGCTCAGGAGAGGGGGCGGCTCTTCAGTCCCTCTTTACCCAAGAGGGTG

STAT6 site
 AATTCCCAAGAAGGGCCAGGAGGTAGAGTAGAGTGGGGGTTGAGCACTGACTGGCACCCGTGGCACACAGCCAGGTG

AAACAGGGAAATTCAAGGCCCTCCTTTCTGTGACTCAACACCTTCC TAACAAAA **CTCAGCTCCAGCTGGACAGTTG**

Mouse CD23b-specific exon **Exon 1b**
GGAGTCAGATAGAGTTGAAAGCCAATTTGAAACGGGA ACTTGGAATTCA GAATGAATTCTCAAACCAGG GGTAA GGAA

GAACTGGGAACCTGCA

TA = missing 19 base pairs here, as compared to the human CD23b promoter

GA = missing 9 base pairs here, as compared to the human CD23b promoter

GA = missing 3 base pairs here, as compared to the human CD23b promoter

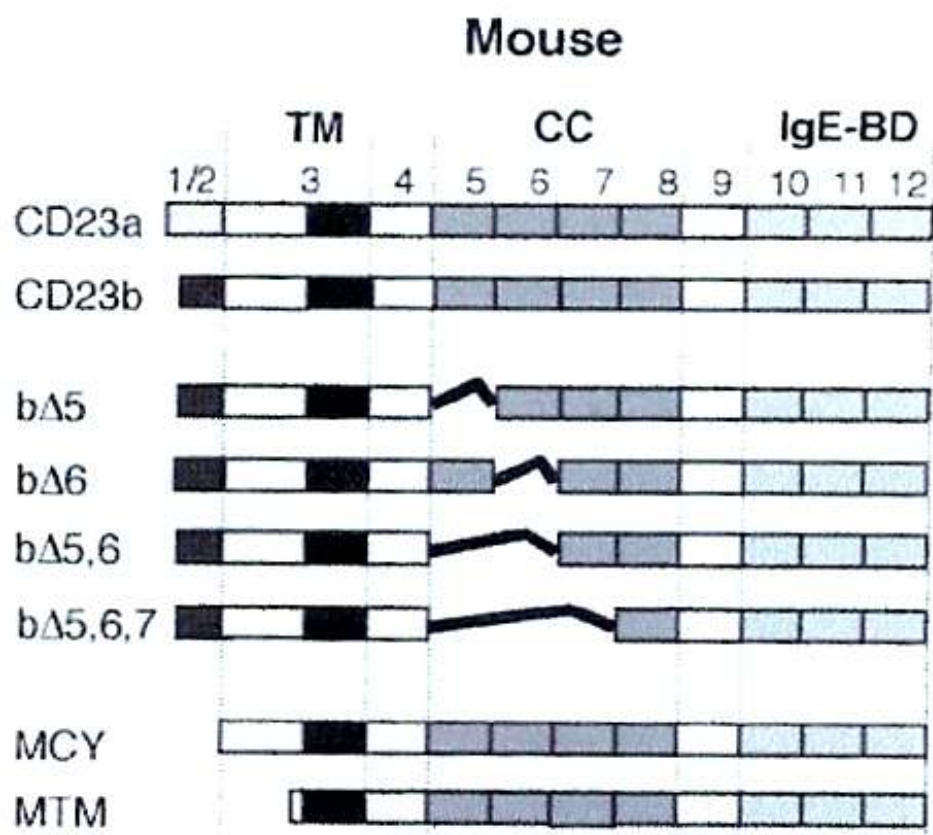
GG = missing 1 base pair here, as compared to the human CD23b promoter

acids. CD23a is found on B cells and follicular dendritic cells. CD23b is widely expressed on hematopoietic cells, including CD5⁺ B cells, T cells, monocytes, eosinophils, platelets, Langerhan's cells, and bone-marrow-derived mast cells.¹⁴⁹ Both human and mouse B cells constitutively express CD23a and it is upregulated by IL-4, whereas CD23b (human) on any cell type requires IL-4 for expression.¹⁴⁹⁻¹⁵¹ Until recently, it was thought that only CD23a is found in the mouse;¹⁵² CD23b has lately been found to be expressed and upregulated on murine intestinal epithelium in conditions of food allergy.¹⁵³ In addition, there are several CD23b isoform variants found in the mouse, as depicted in Fig. 10; the Δ sign followed by a number indicates the lack of that exon. These CD23b variant isoforms will be discussed in further detail in Part D (CD23b Expression) in this section.

C. Function. CD23 plays a role in the regulation of IgE synthesis. Development of transgenic mice in which the CD23 gene was deleted¹⁵⁴⁻¹⁵⁶ or animals that overexpress CD23¹⁵⁷ allowed examination of the role of CD23 in IgE production. One group reported that CD23 knockouts had an enhanced IgE response,¹⁵⁶ while other groups did not find considerable differences in IgE responses to either parasite or antigen/alum regimens;^{154,155} this lab also (data not shown) found IgE responses to be similar in knockout and control mice. However, CD23 transgenic animals have a greatly reduced IgE response in both parasite and antigen/alum regimens.

One finding with the use of anti-IgE is that basophils have a lower level of Fc ϵ RI expression as a result of the lower serum levels of IgE,¹⁵⁸ and this relates to the efficacy of this treatment. CD23 is also a candidate for this type of therapy, and either the

Figure 10. Pictorial view of the murine CD23 isoforms and isoform variants. This shows the functional organization of the exons of the CD23 gene and the domains encoded by the exons are noted along the top: TM = transmembrane domain, CC = coiled-coil stalk domain, and IgE-BD = IgE-binding domain. As seen in the figure, CD23b Δ 5 lacks exon 5, CD23b Δ 6 lacks exon 6, CD23b Δ 5,6 lack both exon 5 and 6, and CD23b Δ 5,6,7 lacks exons 5-7. This occurs via mRNA splicing and affects the function of CD23b. The last two gene constructs in this schematic are MCY and MTM, which are CD23 constructs created for the purposes of research; MCY is full-length CD23 lacking the sequence encoding the five N-terminal amino acids, while MTM is full-length CD23 minus the entire intracellular sequence *except* the last five amino acids. (*Figure Schematic reprinted from Montagnac, et al*¹⁶⁰)



membrane form or an engineered soluble form with full IgE-binding capacity may be used. It is a self component and therefore no immune response could occur; in addition, the close proximity of the interaction sites of CD23 and FcεRI¹⁵⁹ also indicates that CD23 could not cause an anaphylactic reaction.

IgE production has been shown to be inhibited by anti-CD23 monoclonal antibodies using both PBL (peripheral blood lymphocytes) from allergic patients and the IgE-producing cell line U266.^{161,162} Anti-CD23 mediates suppression¹⁶³ of mRNA for secreted, but not membrane, IgE. With regard to sCD23, there was a modest potentiation of IL-4-induced IgE production in the human *in vitro* system,^{164,165} but this lab was unable to alter IgE synthesis using native sCD23 in mice. This lab has achieved IgE modulation with intact CD23 *in vitro* and *in vivo*, using transgenic mice,¹⁶⁶ culture in the presence of CD23-transfected cells,¹⁶⁷ and culture in the presence of LZ-CD23 (a trimeric soluble CD23, created in this lab). A second function of CD23, due to endocytosed IgE-antigen complexes, is enhanced antigen presentation in both humans and mice.^{168,169} This lab has explored this area further using anti-CD23-antigen complexes and found increased immunogenicity of these complexes.¹⁶⁹

D. CD23b expression. As indicated earlier, the two isoforms are expressed on different cell types, leading to a wide expression of the CD23b isoform in humans but none in mouse (or so it was thought at the time that this project was begun). There were hypotheses regarding the lack of murine CD23b expression; one was that there was a defect in the transcription start site; the second was that perhaps murine lymphocytes

simply do not express the CD23b isoform, while it was yet possible that other murine cell types (other leukocytes or other cells) may express it under specific conditions.

Examination of the mouse CD23b sequence led to several observations. Kohler *et al.*¹⁷⁰ used a luciferase reporter gene system to isolate the IL-4RE in the human CD23b gene and went on to confirm by EMSA that an IL-4 induced protein did bind the sequence. This lab conducted a computer-assisted homology search to find the comparable sequence in mouse. EMSA analysis showed that the STAT6 site in the mouse CD23b gene was fully functional. However, there was still little expression seen. Kondo *et al.*¹⁷¹ showed by RT-PCR that the b isoform is produced, although at very low levels. The conclusion was that the CD23b isoform was intact but still obviously unresponsive to IL-4 stimulation. To examine the CD23b promoter in isolation, it was cloned into a luciferase vector and evaluated *in vitro* for upregulation by IL-4. The murine CD23b promoter region has a (functional) STAT6 site that allows for IL-4 inducibility; there is also an NFκB site 38 bp upstream of the STAT6 site. This same orientation occurs in the human CD23b promoter, and the two sites are 36 bp apart. However, the human and mouse CD23a promoters have their transcription factor (TF) binding sites in opposite orientation, with only 18 bp between them.

Initially, studies in this lab analyzed the mouse CD23b promoter (murine CD23b: 283 bp, from -239 to +44) as compared to the human CD23b (hCD23b) promoter, and the murine version of the promoter had three regions "deleted" (see Figure 8). None of the deletions correspond to any known TF binding sites when compared to the human CD23b promoter region; namely, STAT 6 and NFκB.

The mouse CD23b (mCD23b) promoter was corrected for two of the defects, alone and in combination. The reporter (luciferase) plasmids were transfected into M12.4.5 cells (a murine B cell line) and cultured in the presence and absence of IL-4. Replacement of the 19-bp deletion or restoration of the NF κ B site to consensus alone or in combination had no effect on the efficiency of the CD23b promoter. Also note that isolation of the CD23b promoter from any possible negatively influencing sequences had no effect upon its inducibility by IL-4.

Since the mCD23b promoter seemed to be intact, this same reporter vector containing the murine CD23b promoter was transfected into the RPMI 8866 human B cell line; this was to determine if the mouse was simply lacking a factor required for CD23b expression. There was no increase in luciferase production by these cells when they were induced by human IL-4. Two other human cell lines were also transiently transfected with similar results. Reciprocal experiments were also performed; the human CD23b promoter in a luciferase vector was transiently transfected into the M12.4.5 murine B cell line. No luciferase expression was observed.

This led to the “faulty transcription initiation hypothesis”, in which the defect in the mCD23b promoter is in transcription initiation. This is supported by the fact that neither replacement of the 19-bp deletion at +6 nor consensus matching of the NF κ B site can explain the lack of mCD23b expression. Additionally, in the mCD23b promoter region, there is a cluster of putative TF binding sites for several proteins; these may inhibit transcription initiation efficiency by blocking the interaction of RNA polymerase with the DNA. It is also not known if CD23a can “sequester” transcription factors away

from CD23b. This cluster is not found in the hCD23b promoter region. Also, mouse CD23b does not upregulate in either mouse or human cell lines – further evidence that transcription cannot be initiated from the CD23b promoter.

Since the work described above was done, Ewart, *et al*,¹⁷² showed that the CD23a promoter is only sensitive to IL-4 when the STAT6 site most distal to the transcription initiation site is available; and that the CD23b promoter is responsive to IL-4, CD40L, and is variably responsive to anti- μ stimulation.¹⁷²

The second hypothesis for the lack of CD23b expression was that mice just may not express high levels of CD23b in their lymphocytes, which are the cells in which we would expect to find the protein. Lymphocyte cell lines have typically been chosen for experiments based on that assumption. Instead, murine CD23b (mCD23b) has been found to be expressed in intestinal epithelial cells.¹⁵³ This alone suggests that the regulation of murine CD23b may be very different from the human system.

A collaborator found mCD23b expression¹⁵³ on intestinal epithelial cells when the individual had food allergies. Briefly, after ingestion of food antigen, local GI symptoms develop, such as vomiting, nausea, and diarrhea; extraintestinal symptoms may occur in the skin and airways.¹⁷³ In severe cases, systemic anaphylaxis may occur.¹⁷³⁻¹⁷⁵ It is interesting to note that increased levels of CD23 have been found in individuals with food allergy, inflammatory bowel disease,¹⁷⁶ and in the airways of asthmatics.¹⁷⁷ CD23 appears to be expressed constitutively at extremely low levels on the apical membrane of murine intestinal epithelial cells,¹⁵³ and is dramatically upregulated in sensitized mice.¹⁵³

An understanding of the physiology of food allergy is crucial to understanding the role of CD23 in this disease. Mast cells, the effectors of the symptoms of an allergic reaction, are beneath the lamina propria of the gut and should therefore be masked from antigen contact.¹⁷⁸ There are two phases of antigen penetration in hypersensitivity reactions. In phase I, most ingested proteins are digested by enzymes anchored in the enterocyte microvillus membrane prior to transcytosis, but a few proteins are taken up into endosomes and transported across the cells. Most of these fuse with lysosomes and are digested before reaching the basal epithelial cell membrane and gaining access to the lamina propria and the circulatory system. This process is relatively slow, usually taking 20-30 minutes.¹⁷⁹ However, a food antigen is specifically and rapidly taken up by the intestinal epithelial cells as intact protein. Uptake of the food antigen and transepithelial protein transport occurs within 3 minutes after exposure to antigen in the sensitized animal, as has been shown in rats sensitized to HRP.^{180,181} Phase I was shown to be IgE-dependent (intestinal epithelial cell dependent) but mast cell independent and is specific for the sensitizing antigen.¹⁸⁰⁻¹⁸² In phase II, mast cells are activated >30 min. later via IgE-ag complexes cross-linking the FcεRI and degranulation occurs. GI symptoms, such as altered intestinal epithelial cell ion transport, which can result in diarrhea and other unpleasant GI tract effects, ensue following mast cell degranulation.

It has been shown that CD23 and IgE can enhance intestinal transepithelial antigen transport in sensitive rats.¹⁸¹ Antigen uptake at the level of the intestinal epithelium was found to be specific; HRP-sensitive rats had allergic reactions to HRP but not ovalbumin.¹⁸⁰ IgE is required for sensitization: whole serum, but not IgE-depleted

serum, could transfer sensitivity into naive rats and, additionally, the sensitization was specific.¹⁸³ Enhanced expression of CD23 in sensitized rats was shown to be present on the apical surface of the intestinal epithelial cell membrane by immunogold labeling; 3 min. after challenge, these same cells had a sharp decrease in membrane-expressed CD23 but a concurrent increase in CD23 in the endosomes of these cells.¹⁵³ The involvement of CD23 in the state of sensitization of the animal was further supported by the inhibition of antigen transport and the hypersensitivity reaction in CD23^{-/-} mice.¹⁸³

There is evidence¹⁵³ that CD23b is the protein isoform involved in the sensitized murine system. Yu, *et al.* examined the role of CD23 in enterocyte (intestinal epithelial cell) uptake and transport. Gut epithelial CD23, shown by immunohistochemical staining and immunogold labeling to be present on the apical membrane of the jejunal epithelial cells, is involved in the uptake and transport of antigen in sensitized IL-4^{+/+} mice but not in sensitized IL-4^{-/-} mice, suggesting that IL-4 is involved in the regulation of CD23 expression in intestinal epithelial cells.¹⁸³ Importantly, CD23^{-/-} mice were found to lack antigen transport.^{183,184} In addition, cultured intestinal epithelial cells (IEC4.1 cells) were shown by RT-PCR (Reverse-Transcriptase PCR) to be expressing only CD23b transcript.¹⁵³ Yu *et al.*¹⁵³ also showed that intestinal epithelium can and does express CD23b transcript; indeed, as shown in a couple more recent reports, there are several different splice forms of CD23b (Fig. 10) that can be found in intestinal epithelium. Classical CD23b is the predominant form expressed, but CD23b Δ 5 is the next most prevalent, while CD23b Δ 6, Δ 5,6 and Δ 5,6,7 are found only in very tiny amounts.¹⁸⁵

CD23b Δ 5 was found to bind to IgE with the typical biphasic affinity as the classical CD23b form, whereas CD23b Δ 6 did not bind IgE at all¹⁸⁵ – apparently the coiled-coil stalk is necessary for optimal IgE binding. CD23b Δ 5 is induced *in vitro* by IL-4 and *in vivo* by sensitization to a food allergen.^{153,186} This CD23b-derived splice form is constitutively internalized¹⁵³ and is the form which mediates the apical to basolateral transport of free IgE and IgE/allergen complexes. Classical CD23b can only bind IgE/allergen complexes, but not free IgE, for transcytoplasmic transport. The physiological function of free IgE binding by CD23b Δ 5 may be the recycling/clearance of luminal IgE. In both cases, the IgE or IgE/allergen complex was “protected” from degradation during CD23-dependent transport across the cell in sensitized mice.¹⁸⁵ However, a related problem, that of basolateral-to-apical transport of IgE to the lumen of the intestine, has yet to be observed and the mechanism remains elusive.

Interestingly, in the human, both CD23a and CD23b are co-expressed in intestinal epithelial cells.¹⁶⁰ CD23a is found in the basolateral surface and CD23b is found at the apical surface. This is quite opposite the situation in mouse, where CD23b is the exclusive isoform. mRNA for human intestinal epithelial CD23 was also cloned and tested for the presence of a b Δ 5-like product, but none was found. Only full-length stalk region was found in all clones tested.¹⁶⁰ CD23a is effectively internalized by CCPs and bears a cytoplasmic tyrosine-6 (encoded in the CD23a-specific exon) which is found to be in the classical consensus sequence for a tyrosine-based, clathrin-dependent signal for internalization.

The internalization mechanism of CD23b and its splice forms was discovered to be CCPs (clathrin-coated pits), and the absence of exon 5 in CD23b Δ 5 caused this variant to be constitutively internalized. Data from anti-CD23/transferrin-internalization co-localization experiments with the CD23b Δ 5, Δ 6, Δ 5,6 and Δ 5,6,7 indicates that endocytosis of CD23 isoforms is strongly related to the stalk region of CD23 (less stalk = more efficient endocytosis).¹⁶⁰ Montagnac, *et al*,¹⁶⁰ suggests first that the CD23b-specific exon negatively regulates the endocytosis signal and, further, that the modulatory function of the CD23b-specific exon is under control of the stalk region. Evidence comes from the CD23b Δ 5, wherein a deletion of the stalk allows for constitutive internalization, which has CD23b-type intracytoplasmic region. This is very different from the scenario in human CD23, and as more data is gathered, underscores the suggestion that human and mouse CD23 (and its isoforms) is regulated very differently.

IV. Research Objectives.

A. Effects of anti-CD44 on B cell Growth and Differentiation. Prior to the beginning of this project, an anti-CD44 mAb created in this lab (and named RK3G9) was found to inhibit IgE production by murine B cells when coated on a culture plate. The present study focused on the effects of CD44 cross-linking on murine B cell activation and differentiation *in vitro*, to begin to elucidate the role of CD44 in B cell maturation. This study demonstrates that CD44 cross-linking via anti-CD44 mAb inhibits B cell proliferation and affects antibody production. Following CD44 cross-linking, B cells acquire a fibroblast-like morphology and do not cluster. In addition, CD44 cross-linking

inhibits B cells stimulated via the CD40L or LPS signaling pathways, but not by BCR stimulation. This indicates that the CD44 cross-linking effects have some specificity and suggests that CD44 cross-linking could control polyclonal B cell activation by CD40L, but allow sIgM/CD40L activation to continue. In addition, the formation of plasma cells is decreased.

B. CD23b Promoter Defect: to B or not to B. This project was begun – and finished - prior to much of the information just given in the Introduction Section. However, in the early stages of this project, the main objective was to correct the CD23b promoter “defect” by various combinations of the mouse CD23a and CD23b promoters. Human CD23b was also compared to mouse CD23b and these promoters were also to be combined. Human CD23b is known to be expressed on a wide variety of hematopoietic cells and these studies would allow determination of whether the two species regulate this important molecule in entirely different or very similar manners. With the discovery of CD23b on enterocytes, this project objective changed: to discover what regulates CD23b expression – as it differs considerably from that of CD23a – in the murine system. The elucidation of the regulatory apparatus would no doubt be an important step in the fight to eradicate food allergy.

MATERIALS AND METHODS

I. Anti-CD44 project.

A. Animals and Media. Female Balb/c mice were purchased from The Jackson Laboratory (Bar Harbor, ME) and were housed in accredited animal facilities. All mice used in experiments were between 6 and 14 weeks of age. The medium used consisted of RPMI 1640 supplemented with 10% heat-inactivated FBS (Hyclone, Logan, UT), 2 mM glutamine, 1 mM sodium pyruvate, 0.1 mM non-essential amino acids, 100 U/ml penicillin, 100 U/ml streptomycin (all from Life Technologies, Rockville, MD), 10 mM HEPES buffer, and 5×10^{-5} M 2-mercaptoethanol (Sigma, St Louis, MO), referred to as “B cell medium”.

B. B cell isolation and growth conditions. B220⁺ B cells (>95%) were isolated from disrupted spleens by staining with PE-anti-B220 (Becton Dickinson, Los Angeles, CA) or FITC-anti-B220 and sorting using a MoFlo cytometer (Dako-cytomation, Ft Collins, CO). B cells were plated at various concentrations in 96-well plates (Costar, Cambridge, MA) in a volume of 200 μ l of B cell medium and stimulated with 50,000 U/ml interleukin-4 (IL-4), 5 ng/ml IL-5, 0.01 μ g/ml CD40 ligand trimer (CD40LT), and 0.1 μ g/ml mouse IgG₁ anti-trimer (M15), collectively referred to as “Activation Cocktail”, at 37°C in a 5% CO₂ incubator. These activation conditions have previously been shown to be optimal for IgE production.¹⁶⁷ Plates were coated with 50 μ l of 10 μ g/ml of RK3G9 (anti-CD44, rat IgG_{2a}¹⁸⁷), IM7 (anti-CD44, Pharmingen, San Diego, CA), or C0H2 (rat IgG_{2a} isotype control) and blocked with 2% FBS in PBS, prior to plating cells.

C. B cell proliferation. On day 3 post-culture, the B cells were pulsed using 1 μ Ci [³H]thymidine (ICN Biomedicals, Costa Mesa, CA)/well for 6 hrs. Cells were then harvested onto a Unifilter 96 plate (Packard Instruments, Meriden, CT) using a Filtermate 196 plate harvester (Packard), and the incorporation of [³H]thymidine into DNA was measured by reading the plate in a model 9902 TopCount (Packard).

D. ELISAs. On day 8 post-culture, levels of IgE, IgG₁, IgM, or IgG_{2a} in supernatants were determined by ELISA as described previously¹⁶⁶. Briefly, a pair of rat anti-mouse IgE monoclonals, B1E3 (5 μ g/ml) and biotinylated R1E4, were used as the capture and biotinylated secondary antibody, respectively. Biotin was then recognized by streptavidin coupled to alkaline phosphatase (Southern Biotechnology Associates, Birmingham, AL). Total IgG₁ was determined by using an unlabeled primary goat anti-mouse Ab at 5 μ g/ml and detected with goat anti-mouse class-specific Ab coupled to alkaline phosphatase (all Abs are from Southern Biotechnology Associates). Total IgM and IgG_{2a} were determined similarly; the primary Ab was unlabeled goat anti-mouse IgG_{2a} or IgM, and the detection Ab was alkaline-phosphatase-coupled goat anti-mouse IgG_{2a} or IgM.

E. Elispot. On the appropriate day, B cells were removed from 96-well plates via Trypsin-EDTA (due to the RK3G9-mediated spreading and binding to the plates), counted, and plated (in 150 μ l) onto a PVDF-membrane Elispot plate (Multiscreen-HTS, from Millipore, Bedford, MA) at a concentration of 50K in the 1st well, with dilutions of 1:2 all the way through well 11. The plates were pre-coated with B1E3 (see details in ELISA section) or anti-IgG₁ at 10 μ g/ml in 100 μ l/well overnight at 4°C prior to B cell plating. The cells were then allowed 16-20 hours to bind to the plate at 37°C (+ 5% CO₂).

After incubation, the Elispot plate is washed with filtered PBS + 0.1% Tween 20 five times, with two of the washes having a 5-minute soak at room temperature. The primary antibody, biotinylated R1E4 (in the case of an IgE Elispot), is added (at a 1:500 dilution in 100 μ l/well) to the plates in PBS and incubated for 1 hour at 37°C. The plate is then washed as described above and streptavidin-AP (at a 1:250 dilution in 100 μ l/well) (or IgG₁-AP in the case of an IgG₁ elispot) is added to the plates for 1 hour at 37°C. The plate is washed as described previously and substrate (AMP buffer + 1 mg/ml BCIP) is added for 5 minutes at room temperature in the dark. The plate is then washed with DI water on both sides and allowed to dry before counting. Counting was done on a stereo microscope.

F. FACS. Cells were washed and stained with PE-conjugated anti-CD38 in PBS/1% FBS on ice for 30 minutes. They were then washed once more prior to reading in the FC500 flow cytometer (Beckman-Coulter, Fullerton, CA).

G. Streptavidin-microbeads cross-linking experiments. For the cross-linking of biotinylated RK3G9: 100 μ l streptavidin microbeads (Miltenyi Biotec, Auburn, CA) were pre-mixed with 100 μ g of biotinylated RK3G9 and incubated on ice for 30 min., washed in PBS three times, resuspended in media, and added to the cell cultures. For the cross-linking of unlabeled RK3G9 with biotinylated MAR18: 100 μ l streptavidin beads were pre-mixed with 200 μ g biotinylated MAR18, incubated on ice for 30 min., washed in PBS three times, resuspended in media, and added to the cell cultures in conjunction with 1 or 10 μ g of RK3G9.

H. *In vivo* RK3G9 experiment. Male Balbc/J mice were purchased from The Jackson Laboratory (Bar Harbor, ME) and were housed in accredited animal facilities. These mice were 6 weeks of age. Alum-Ag injections consisted of 4 mg/mouse Alum (Pierce, Rockford, IL) + 100 µg/mouse KLH-DNP (San Diego, CA) + PBS. Each mouse was injected with 200µl Alum-Ag intraperitoneally (i.p.) on days 0 and 7. The RK3G9 injection consisted of 1 mg/mouse in PBS and was given subcutaneously (s.c.) on days -2, 0, and 7.

The blood was taken by a capillary tube held to a tail vein nick. 200-400 µl of blood was collected from each mouse. This blood was then put on ice for one hour and then centrifuged at 10,000 rpm for 5 min. The supernatant (serum minus blood cells) was collected and used in an IgE ELISA, which was performed as described above.

II. CD23b Promoter Project.

A. Cell Lines. Cell lines used were the M12.4.5 (mouse B cell, ATCC), HEK293 (human epithelial kidney cells, ATCC) and IEC4.1 (mouse intestinal epithelial cells, courtesy of Mary Perdue, Intestinal Disease Research Programme, McMaster University, Hamilton, Ontario, Canada).

B. Plasmids. The firefly luciferase vectors pGL3-Basic, pGL3-promoter, and pRL-TK (Renilla luciferase) were purchased from Promega (Madison, WI). The luciferase vector pLUC+ and the construct pLUC+CD23b were generously provided by Ioana Visan and Christian Kneitz (Medizinische Poliklinik, University of Würzburg, Würzburg, Germany). The TA cloning vectors pCR2.1 and pCR3.1-Uni were purchased from

Invitrogen (Carlsbad, CA). The four pCR3.1 CD23b constructs were generously provided by Alexandre Benmerah (Institut National de la Santé et de la Recherche Médicale).

1. pGL3-CD23bProm-TATA construct. Previous work in this lab had been done with the CD23a and CD23b promoters in the pGL3 vector. To begin the process, the pCR2.1-CD23bProm construct was used, described as follows: first, an NcoI site was added to the CD23b promoter region (5'-AAAGCCAATTTGAACCC**ATGGCCG**AATTCTGCAG-3', NcoI site in bold, underlined A to be deleted, underlined G to be mutated to A) via Quikchange Site-Directed Mutagenesis (Stratagene, La Jolla, CA) by PCR. The oligo sequences are listed in Table 1, primer set #1. After the Quikchange, the resulting product was transformed into XL1-Blue Supercompetent Cells and the plasmid DNA was isolated by miniprep (Promega). The mutation was confirmed by restriction enzyme digest (MscI). The CD23bProm fragment was amplified by PCR (Table 1, primer set #2) and cut to fit its vector by MscI and Acc65 I. The PCR protocol was 35 cycles of the following: 94°C for 1 min., 55°C for 1 min., 72°C for 2 min. This was followed by a final cycle at 72° for 6 min. Meanwhile, the pGL3 vector containing CD23a (pGL3-CD23a) was digested by restriction enzymes (MscI and Acc65 I) to remove the entire CD23a promoter except for its TATA box. The CD23bProm insert was then ligated into the pGL3 vector containing the CD23a promoter TATA box, creating a construct comprised of CD23b promoter plus CD23a TATA box, called pGL3-CD23bProm-TATA. Ligation was confirmed by digest with Ava I. This was subsequently confirmed to be in the correct orientation by sequencing (VCU DNA Core Lab) with the Promega primers RVPrimer3

Table 1. This table lists the oligos used in the construction of various CD23 plasmids.

Table I. Oligos used in construction of CD23b constructs

1. pCR2.1-CD23bProm – added NcoI site	<i>sense</i> : GAA AGC CAA TTT GAA CCC TGG CCA AAT TCT GCA GAT ATC <i>antisense</i> : GAT ATC TGC AGA ATT TGG CCA GGG TTC AAA TTG GCT TTC
2. Primers used to amplify the ~300bp CD23bProm	<i>sense</i> : AGG GTA CCG AGC TCG GAT CCA CTA G (covers Acc65 I site) <i>antisense</i> : AGG GTG GCC AGG GTT CAA ATT GGC (covers MscI site)
3. Promega primers	<i>RVPrimer3</i> : CTA GCA AAA TAG GCT GTC CC <i>GLPrimer2</i> : CTT TAT GTT TTT GGC GTC TTC CA
4. CD23 full-length primer	<i>End-1</i> : GCA GAA CTG GTA CGT ATG GAA GAT CC <i>End-2</i> : CGA GAT CCA TTG TGA GCA GAA GTT TG (used in conjunction with either the α or β primer, in row #5)
5. CD23 isoform specific primers	α : CCT CAT CAC TGA AAG GAT CCA AAC AAG β : GAA AGC CAA TTT GAA CGG GAA CTT GG ϵ : GGA GCC CTT GCC AAA ATA GTA GCA C
6. Dr. Benmerah's Full-length CD23 oligos	<i>Oligo B</i> : ATG AAT TCT CAA AAC CAG GGA <i>Oligo F</i> : TCA GGG TTC ACT TTT TGG G

and GLPrimer2 (Table 1, #3), which are specifically created for sequencing pGL3 and pLUC+ luciferase vectors.

2. CD23a and CD23b full-length clones to test serum potentially containing specific anti-CD23a or anti-CD23b antibodies. The cell line used for RNA in these experiments was M12.4.5 cells. These were stimulated with IL-4 and grown for 48 hrs. RNA was extracted using Trizol (Invitrogen, Carlsbad, CA). The primers used in RT-PCR are detailed in Table 1, #4. The RT-PCR kit used was Perkin Elmer Gene Amp PCR system 2400 (Applied Biosystems, Foster City, CA). The RT (reverse transcriptase) step consisted of the addition of 19 μ l of a “MasterMix” (10x PCR buffer, DEPC dH₂O, 25 mM MgCl₂, 1 mM of each dNTP, 2.5 μ M random hexamer primers (in the case of CD23b) or “End-2” oligo (in the case of CD23a) (Table 1, Row #4), 20 U RNase inhibitor, and 50 U muLVRT) to 1 μ g of sample RNA. The cycling parameters were as follows: 25°C for 10 min., 42°C for 15 min., and 95°C for 5 min.

a) CD23a: The cell line used was M12.4.5 cells. The PCR portion consisted of 20 μ l RT product, 25 mM MgCl₂, 10x PCR buffer, 0.5 μ l DNA polymerase, and the remaining volume up to 100 μ l is DEPC dH₂O. The PCR cycling parameters were 94°C for 1 min., 55°C for 1 min., and 72°C for 1 min. 30 sec. This was repeated 49 times and finished with 72°C for 8 minutes. Primers used in PCR were the “End-1” and the α oligo. The PCR product was run on a 1% TBE gel to verify size, then the PCR reaction was ligated directly into pCR2.1 plasmid. This was transformed into XL1-Blue supercompetent cells (Stratagene), and the presence of the 612 base-pair CD23a clone was confirmed by EcoRI restriction enzyme digestion. This was sent to the VCU DNA

Core Lab for sequencing (T7 primers) and was shown to be both the correct sequence and in the correct orientation. This plasmid was called pCR2.1-CD23a- $\alpha 2\epsilon$ (full-length CD23a).

b) CD23b: The PCR portion consisted of 20 μ l RT product, 25 mM MgCl₂, 10x PCR buffer, 0.5 μ l DNA polymerase, and the remaining volume up to 100 μ l is DEPC dH₂O. The PCR cycling parameters were 94°C for 3 min. (only once), then 94° for 30 sec., 58°C for 30 sec., and 72°C for 30 sec, done in all a for a total of 35 cycles, followed by 72°C for 5 min. Oligos used were “Oligo B” (with phosphate added) and “Oligo F”. The ~1 Kb product was then cloned into pCR3.1-Uni (where the added phosphate on the Oligo B caused the CD23b DNA to insert in the correct orientation) and transformed into XL1-Blue supercompetent cells (Stratagene). The presence of the CD23b clone was confirmed by EcoRI and HindIII restriction enzyme digestion. The sequence was confirmed by sequencing (VCU DNA Core Lab). The plasmid was called pCR3.1-CD23bFL (FL = Full Length).

The pCR3.1-CD23bFL was also put into the pEF4 vector. The CD23bFL was cut from pCR3.1-CD23bFL by sequential Nhe I and Not I digestion; the CD23bFL fragment was blunt-ended by the Klenow procedure prior to the second enzyme digestion. The pEF4 vector was cut by sequential digestion with EcoRV and Not I. The appropriate fragments were ligated, transformed into XL-1 Blue cells as usual, plasmid DNA isolated, and ligation was confirmed by digestion with BamHI. This product (pEF4-CD23bFL) was sequenced at the VCU DNA Core Lab and found to be correct.

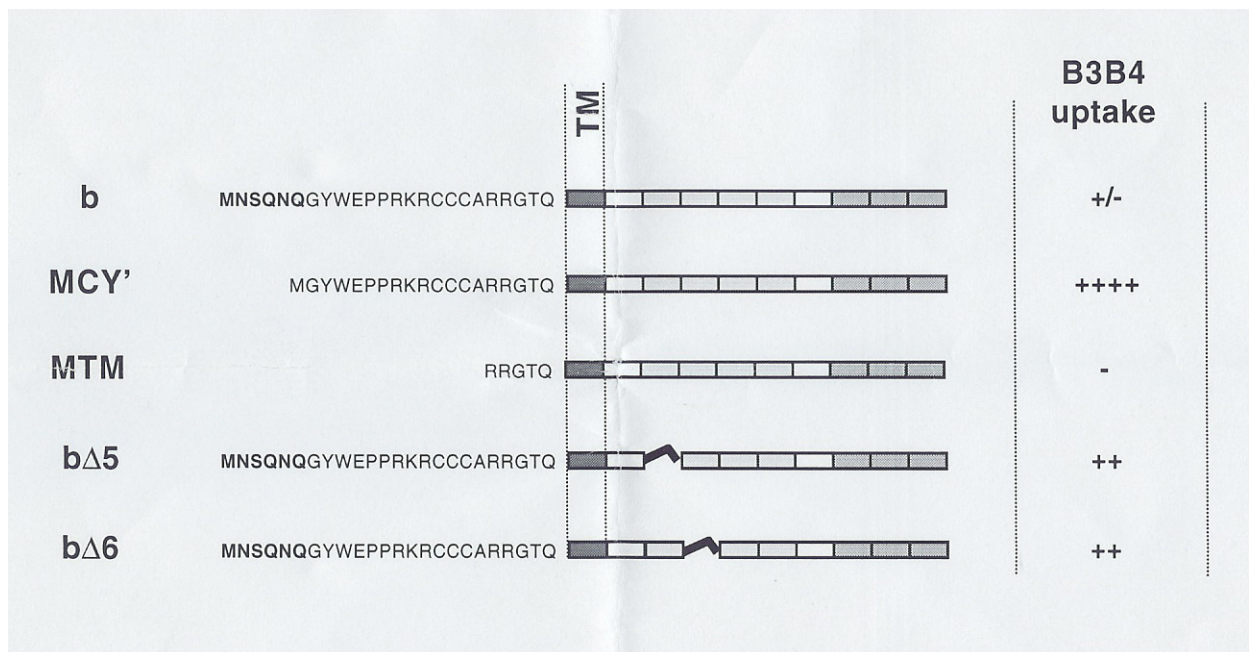
3. Other CD23b constructs. Four CD23b constructs were very generously provided by Dr. Alexandre Benmerah. These were pCR3.1-CD23b Δ 5, pCR3.1-CD23b Δ 6, pCR3.1-CD23b-MCY', and pCR3.1-CD23b-MTM. These plasmids (see Figure 11) are defined as follows:

- a) pCR3.1-CD23b Δ 5: full-length CD23, minus exon 5
- b) pCR3.1-CD23b Δ 6: full-length CD23, minus exon 6
- c) pCR3.1-CD23b-MCY': full-length CD23, but lacks the sequence encoding the five N-terminal amino acids
- d) pCR3.1-CD23b-MTM: full-length CD23, but lacks the entire intracellular sequence EXCEPT for the sequence encoding the five N-terminal amino acids

C. Transfection of cell lines.

1. Electroporation. Log phase cells were washed in PBS, resuspended in EB (Electroporation Buffer, composed of appropriate media for cells + 10% FBS + 10mM HEPES), and brought to a concentration of 4×10^7 cells/ml. Added to each 0.4mm electroporation cuvette was 200 μ l of cells and either 20 μ g of the "test" DNA or the control plasmid at a 1:50 ratio. When the Dual Luciferase Assay was performed, an additional control plasmid (pRL-TK) was added at either a 1:50 or 1:100 ratio. Electroporation parameters were 250 V, 950 F, with only 1 pulse; electroporation constants were recorded. Pulsed cells were incubated on ice for 10 min. prior to being added to 60mm cell culture dishes (50 μ l/dish) containing 10 ml of appropriate media or EB +/- stimulation. Cells were grown for 48 hrs at 37°C, 5% CO₂.

Figure 11. The schematic of the CD23b coding regions from the four pCR3.1-CD23b constructs provided by Dr. Alexandre Benmerah.



2. FuGene Transfection. Fugene 6 Transfection Reagent (Roche Molecular Biochemicals, Indianapolis, IN) is a multi-component lipid-based transfection reagent that complexes with and transports DNA into the cell during transfection. The basic protocol is to add FuGene reagent + DNA to log phase cells. For more detailed information, go to <http://biochem.roche.com\pack-insert\1814443a.pdf>.

D. Luciferase Assay Protocol. At the appropriate time-point, harvest cells and wash with PBS 2x. Resuspend pelleted cells in 250 μ l Cell Lysis Buffer to lyse cells (provided with the Promega Luciferase Assay kit) for 15 min. at room temperature. Lysates may be frozen down at -70°C or read immediately. These lysates were analyzed in a Monolight 2010 luminometer (Analytical Luminescence Laboratory, San Diego, CA).

E. RT-PCR for CD23b in IEC4.1 cells. RT-PCR was used to confirm the presence of CD23b mRNA in the IEC4.1 cells. The RT (reverse transcriptase) step consisted of the addition of 19 μ l of a “MasterMix” (10x PCR buffer, DEPC dH₂O, 25 mM MgCl₂, 1 mM of each dNTP, 2.5 μ M random hexamer primers, 20 U RNase inhibitor, and 50 U muLVRT) to 1 μ g of sample RNA. The RT cycling parameters were as follows: 25 $^{\circ}\text{C}$ for 10 min., 42 $^{\circ}\text{C}$ for 15 min., and 95 $^{\circ}\text{C}$ for 5 min. The PCR portion of the IEC4.1 CD23b experiment consisted of 20 μ l RT product, 25 mM MgCl₂, 10x PCR buffer, 0.5 μ l DNA polymerase, and the remaining volume up to 100 μ l is DEPC dH₂O. The PCR cycling parameters were 94 $^{\circ}\text{C}$ for 3 min., followed by 94 $^{\circ}\text{C}$ for 1 min. 30 sec., 60 $^{\circ}\text{C}$ for 2 min., and 72 $^{\circ}\text{C}$ for 3 min. Steps 2-4 were repeated 34 times and finished with 72 $^{\circ}\text{C}$ for 7 minutes. The RT-PCR results were analyzed by DNA electrophoresis on a 1% TBE gel.

RESULTS

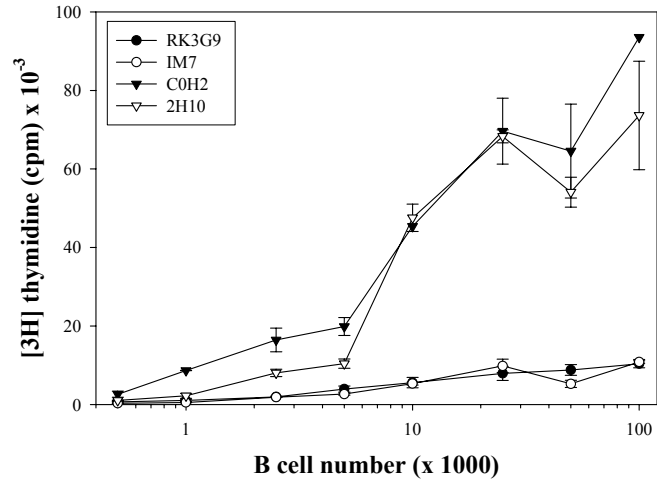
I. Results of investigation of effects of anti-CD44 on B cell activation and differentiation.

A. Immobilized anti-CD44 Abs inhibit B cell proliferation. The goal of this study was to examine the role of CD44 cross-linking via immobilized anti-CD44 antibody in B cell activation and/or differentiation. The cell culture plates used were chosen for high protein-binding capacity (Costar #3370). Both RK3G9 and IM7 are anti-CD44 antibodies. The monoclonal anti-CD44 (RK3G9) was made in this lab; IM7 is a commercially available mAb. 2H10 is a mAb directed against CD23, and is used in this context as a specific control. C0H2 is a non-specific rat IgG antibody used as a non-specific isotype control. 96-well Costar plates were coated with RK3G9, IM7, 2H10, or C0H2. The stimulation used was Il-4, CD40LT, M15, and IL-5 (as detailed in the Material & Methods section). Freshly isolated B cells (>94% B220⁺) were then grown for three days on these immobilized anti-CD44 or control Abs and were assayed for proliferation by [³H]-thymidine incorporation. The proliferation of the cells grown on both anti-CD44 Abs was significantly reduced, as compared to the two controls, across the entire range of B cell concentrations used (Figure 12A). Having established that C0H2 and 2H10 both have no effect on the B cells, C0H2 was chosen as a single control for the remainder of the experiments.

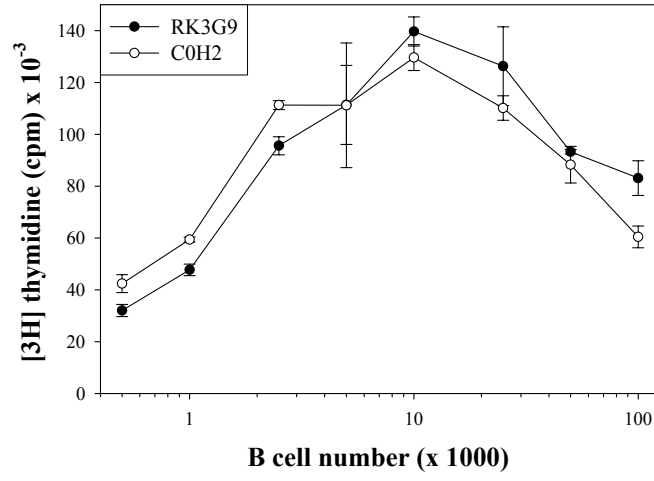
It is interesting that the RK3G9-treated cells displayed a spread phenotype (Fig 12C, panel B), while C0H2-treated cells had a round cell shape and clustering (Fig 12C, Panel A), which is normal for B cell cultures. However, this spread phenotype has been

Figure 12. B cell proliferation is greatly reduced due to CD44 cross-linking by immobilized anti-CD44 antibody. *A*, Immobilized anti-CD44 (RK3G9 or IM7) causes greatly reduced proliferation, as compared to control antibodies 2H10 or C0H2, of B cells grown for 3 days in culture. *B*, Soluble RK3G9 or C0H2, at a concentration of 100 mg/ml, was added to B cell cultures. Proliferation was not affected by soluble RK3G9. These data are representative of at least three separate experiments.

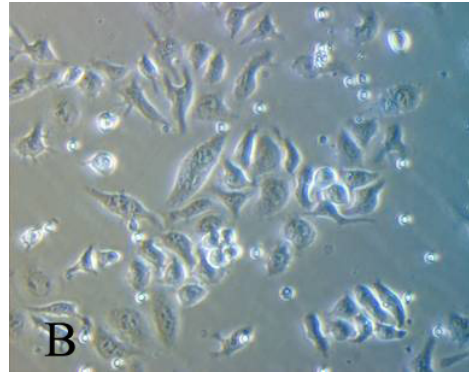
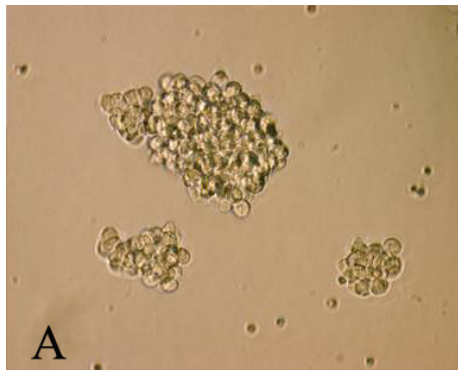
A.



B.



C.



In order to determine whether immobilization of the anti-CD44 antibody is critical to its ability to inhibit proliferation, soluble RK3G9 or C0H2 antibody was added to B cell cultures. The results showed that soluble RK3G9 had no effect on the proliferation of the B cells, as compared to control cells (Fig. 12B). Reduction of B cell proliferation could be attributed to increased apoptosis, as it is known that signaling via CD44 can promote apoptosis.^{19,24,25,31} However, CD44 cross-linking did not promote increased B cell apoptosis, as measured by the TUNEL assay (data not shown).

The possibility that RK3G9 could also cause inhibition of T cell responses was tested, since T cells have been shown to interact with many anti-CD44 antibodies. The T cells were tested with a non-specific activator (Concavalin A) or a specific activator (anti-CD3). Examination of the proliferation of the T cells revealed that, in both cases, there was no reduction in growth due to the presence of the anti-CD44 antibody RK3G9 (Fig. 13).

B. Ig production is inhibited by CD44 cross-linking on B cells. We next examined Ig production to further assess the inhibitory activity of immobilized RK3G9. In view of the fact that IgE production *in vitro* is known to require a high cell division level,^{115,188} we chose to examine the ability of the B cells to produce IgE when cultured on immobilized anti-CD44. We have also shown that the amount of IgE produced is higher when relatively low numbers of B cells are cultured using our protocol,¹⁸⁹ again due to increased B cell proliferation.^{115,188} Plates were coated with RK3G9, IM7, or C0H2, and purified B cells were grown for 8 days in the presence of the Activation Cocktail (see Materials & Methods). Secreted IgE was assayed by ELISA on day 8. B cells incubated

Figure 13. CD44 crosslinking on T cells via anti-CD44 antibodies causes no decrease in their ability to proliferate. *A*, T cells grown on immobilized RK3G9 or control had similar levels of proliferation. These were stimulated with the mitogen ConcavalinA. *B*, The T cells had no decrease in proliferation capacity, as evidenced by ³H-thymidine incorporation, when grown on RK3G9 or control when specifically stimulated by the anti-CD3 antibody 2C11. 2C11 was coated onto the plate concomitantly with RK3G9 or C0H2, or plated alone as a positive control; RK3G9 and C0H2 were also coated alone as negative (no stimulation) controls. There was no difference between any of the cultures which had contact with the anti-CD3, regardless of anti-CD44 presence or not.

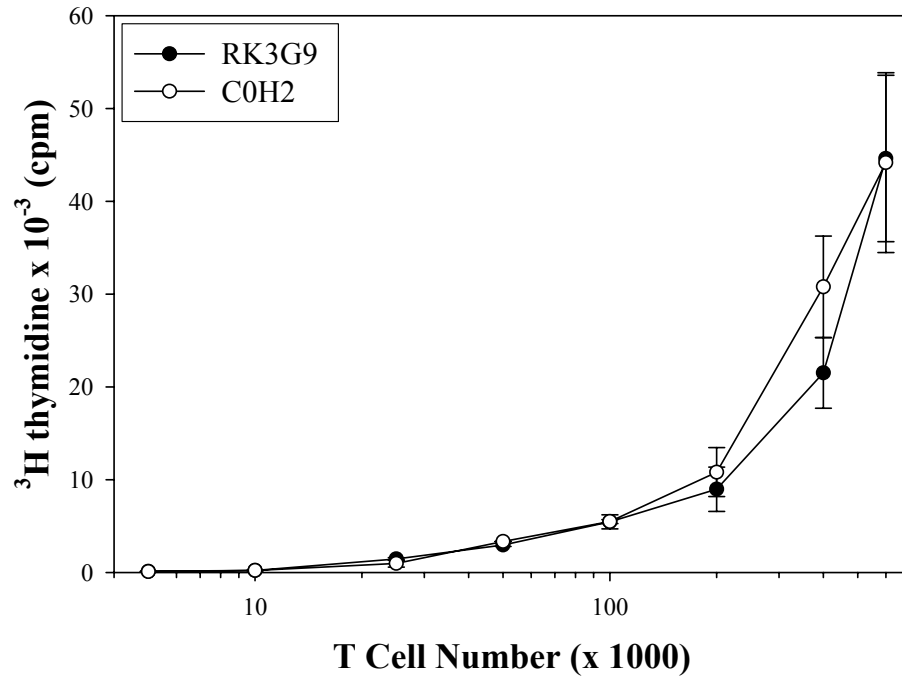
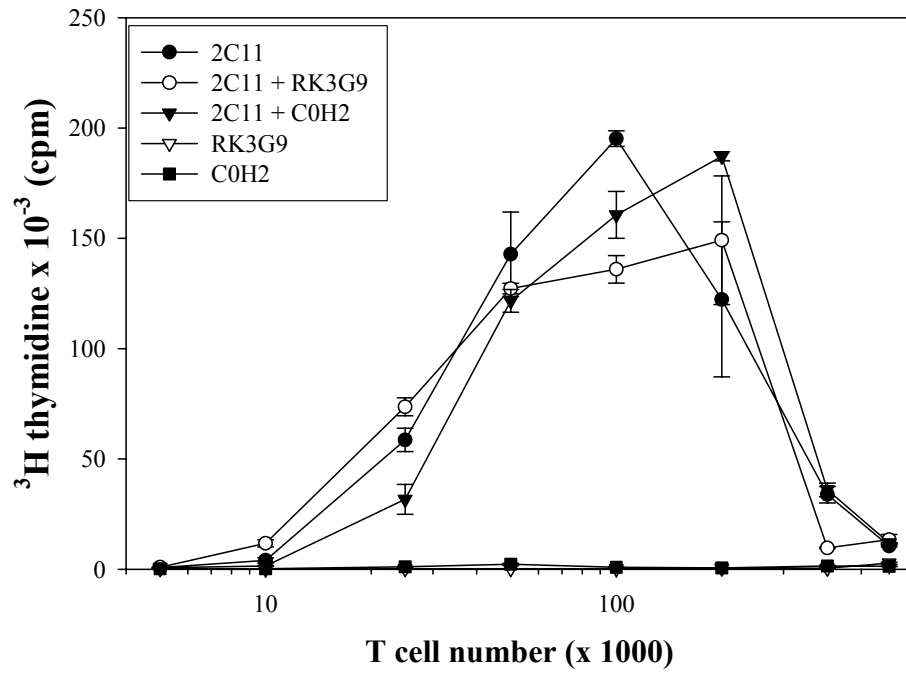
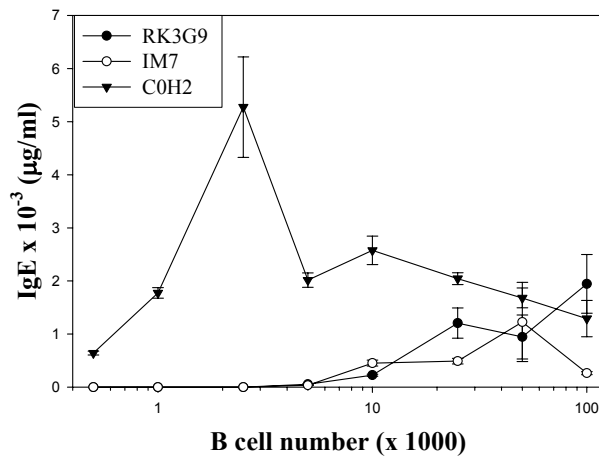
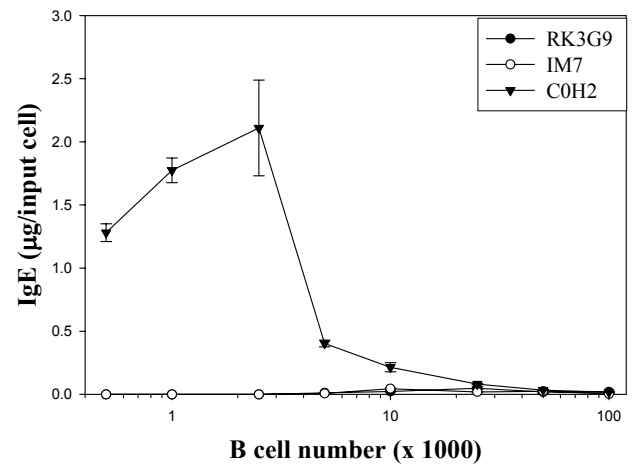
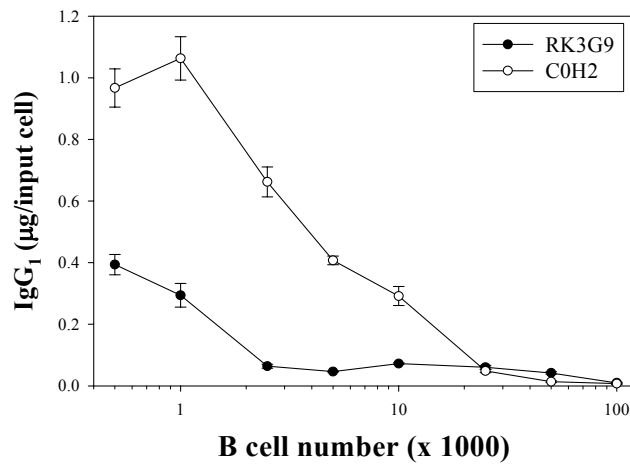
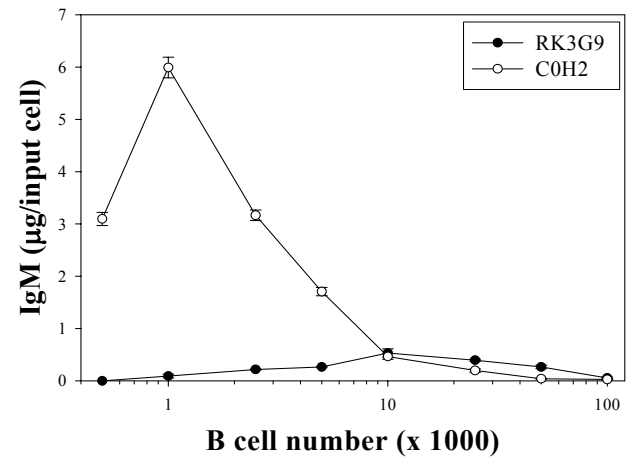
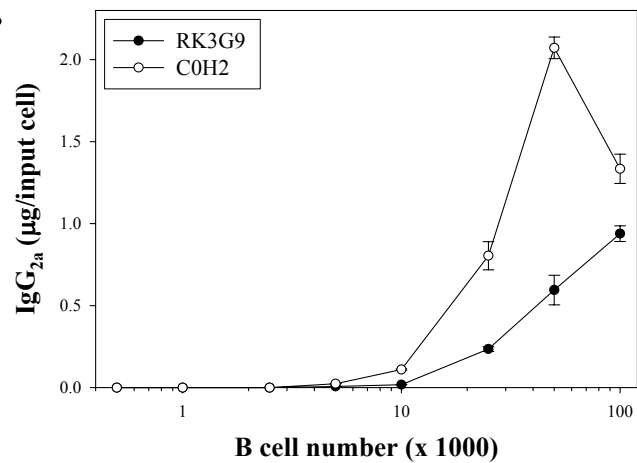
A.**B.**

Figure 14. CD44 crosslinking via anti-CD44 antibodies on B cells causes a decrease in their ability to produce immunoglobulins. *A*, B cells grown on immobilized RK3G9 or IM7 produced dramatically reduced quantities of IgE, in comparison to the control (C0H2). *B*, When the IgE production is plotted as IgE produced per input B cell, the IgE production is shown to be incredibly inhibited. *C*, IgG₁ production ($\mu\text{g}/\text{input cell}$) is significantly inhibited by immobilized anti-CD44. *D*, IgM production is massively inhibited by immobilized anti-CD44, shown as $\mu\text{g IgM}/\text{input cell}$. *E*, B cell cultures were also stimulated with LPS (25 $\mu\text{g}/\text{ml}$) + IFN- γ (10 ng/ml) and grown on RK3G9. The anti-CD44-treated cells had decreased IgG_{2a} production, compared to control. These data are representative of at least two separate experiments.

A.**B.****C.****D.****E.**

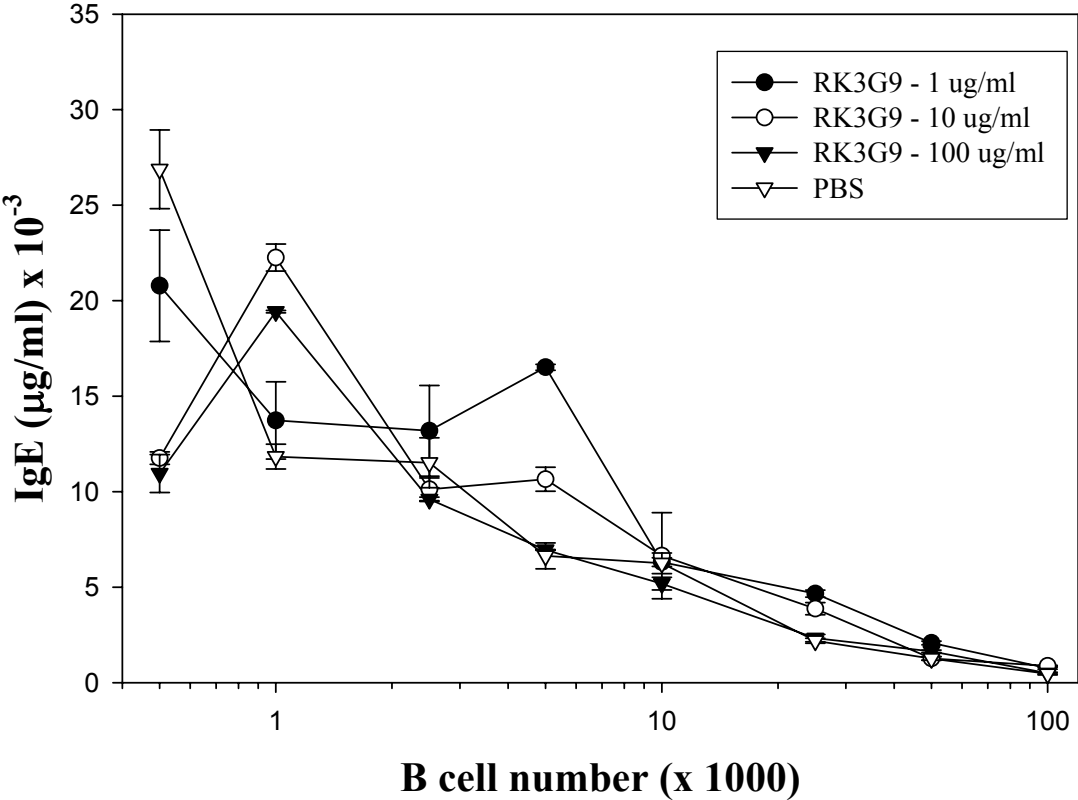
on immobilized RK3G9 or IM7 produced significantly less IgE, compared to control cells, particularly at low cell concentrations (Fig. 14A). Indeed, when the data is expressed as the amount of IgE produced per B cell, inhibition at all B cell concentrations was seen in the anti-CD44-treated cells (Fig. 14B).

Isotype switching to IgG₁ generally requires fewer cell divisions than switching to IgE. IgM production requires no isotype switching. In order to determine whether RK3G9 was inhibiting switching (IgG) or if it was simply preventing Ig secretion (IgM), the supernatants were assayed for IgG₁ and IgM. The production of both isotypes was inhibited at all cell concentrations tested (Fig. 14C, D). This result suggests that Ig secretion is inhibited under these conditions.

Finally, the B cells were also stimulated with LPS (25 µg/ml) + IFN-γ (10 ng/ml). This promotes class switching to IgG_{2a}; also note that IL-4, which could potentially be aiding the RK3G9 in its effects, is absent. These cultures were assayed for IgG_{2a} production (Fig. 14E). The cells cultured in the presence of immobilized anti-CD44 Abs exhibited a decreased proliferation (data not shown) as well as IgG_{2a} production (Fig. 14E), both indicating that the inhibitory activity of RK3G9 was not dependent on the presence of IL-4 and that other isotypes could be inhibited. Consistent with the proliferation studies, when soluble RK3G9 antibody (1, 10, and 100 µg/ml) was added to B cell cultures, it had no effect on the IgE production by B cells, as compared to control cells (Fig. 15).

Interestingly, the anti-CD44-mediated inhibition was somewhat less at higher cell numbers. It was therefore hypothesized that if a greater number of anti-CD44 antibodies

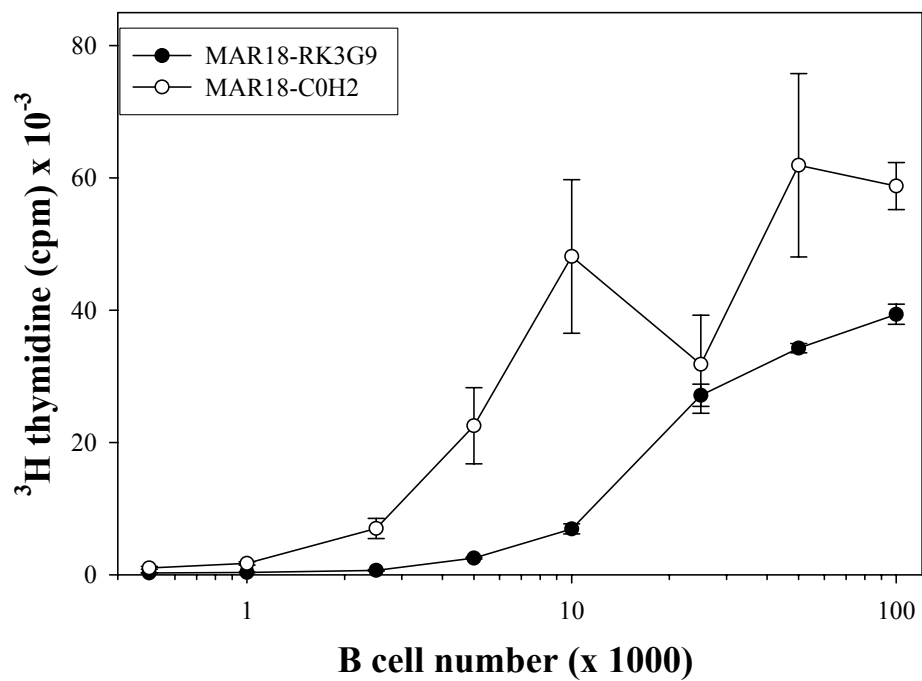
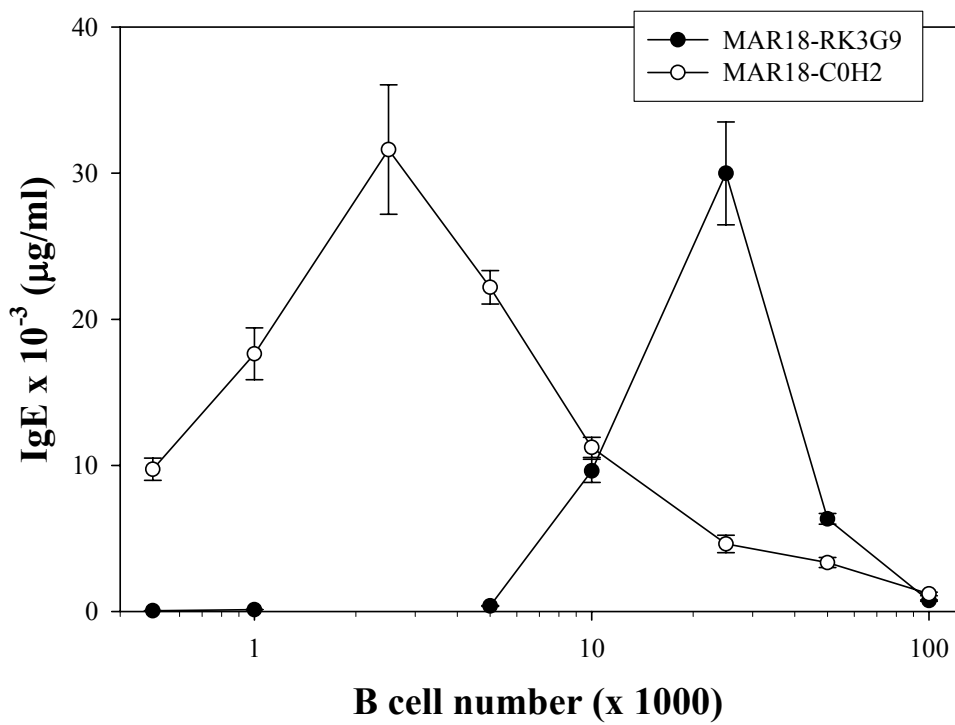
Figure 15. Soluble RK3G9, even up to 100 $\mu\text{g/ml}$, was added to B cell cultures and had no effect on B cell IgE production.



were presented to the B cells, then perhaps inhibition would be seen at higher B cell concentrations. A MAR18 (mouse anti-rat) antibody could be coated onto the plate and in theory could “present” two secondary antibody molecules to the cells being cultured. Hence, MAR18 (10 µg/ml) was coated onto the 96-well plates prior to a secondary antibody coating of RK3G9 or C0H2. B cells were cultured as described in the Methods section and grown for 3 or 8 days. The spread phenotype was observed in the MAR18-RK3G9 cultures but not the MAR18-C0H2 cultures. Proliferation, measured via ³H-thymidine incorporation, of the B cells grown on MAR18-RK3G9 was less than that of MAR18-C0H2 (Fig. 16A). However, the degree of inhibition was significantly less than that of B cells cultured on RK3G9 alone. A likely explanation for this is the on-off rate for the MAR18-RK3G9 interaction; it could mean that the B cell CD44 does not undergo as much crosslinking as it does when immobilized anti-CD44 is present alone.

C. Cross-linking does not increase the ability of soluble RK3G9 to inhibit B cell proliferation or IgE production. In reference to the lack of anti-CD44 ability to inhibit proliferation when added to the cultures in solution, a hypothesis was formed and tested. It was thought that if the RK3G9 could be “bound” (cross-linked) in solution rather than on a plate – as clustering of CD44 on the cell surface is a prerequisite to causing activation/signaling⁶³ – then perhaps the soluble “cross-linked” RK3G9 could act as a scaffold and mimic the plate-bound version of anti-CD44 presentation. Hence, an experiment was set up wherein soluble RK3G9 (1 or 10 µg/ml) was combined with biotinylated MAR18 and streptavidin in an effort to promote the hypothesized “soluble scaffold”, and this combination was added to the cell cultures. Control cells were grown

Figure 16. Mouse anti-rat (MAR18) antibody was coated as a primary antibody onto plates, followed by a secondary antibody - RK3G9 or C0H2. The B cell cultures grown on anti-CD44 exhibited some degree of inhibition as compared to the control, but it was much smaller effect than what is seen without the primary MAR18 antibody. *A*, proliferation of the B cells; *B*, IgE production.

A.**B.**

with no antibody (PBS). Analysis of the proliferative capacity (Fig. 17A) and the IgE-producing ability (Fig 17B) of the B cells incubated with the RK3G9 + biotinylated MAR18 + streptavidin showed that there was a small anti-CD44 inhibitory effect on these cells (30-50% inhibition).

Because it was thought that a soluble form of the anti-CD44 was more physiologically relevant, a second type of crosslinking experiment was considered. There were two ways to crosslink RK3G9 with micro-beads to make a physical “scaffold” in solution: 1) add biotinylated RK3G9 to the cultures in conjunction with streptavidin-linked microbeads and 2) add unlabeled RK3G9 + biotinylated MAR18 + streptavidin microbeads. Both options, plus controls, were used. IgE levels were tested after 8 days. RK3G9 (10 $\mu\text{g/ml}$), when cross-linked to the beads via biotinylated MAR18, inhibited IgE production (Fig. 18) by about 60% at lower cell concentrations. Hence, even cross-linking RK3G9 to make a sort of “physical scaffold” in solution did not fully mimic the plate-bound environment.

D. CD44 knockout mice confirm RK3G9 specificity. RK3G9 was confirmed to bind to only CD44 by using CD44 knockout mice. These CD44^{-/-} B cells were harvested, isolated, and cultured on RK3G9 or control for 3 days. A proliferation experiment showed no inhibition of proliferation in the CD44^{-/-} mouse B cells grown on RK3G9 (Fig. 19A). This showed that RK3G9 is not simply having a cross-effect on some other molecule on the mouse B cell surface and is specific for CD44. Additionally, CD44v7 knockout mice were available, so the B cells from these were also cultured and tested as above. These did respond to the anti-CD44-mediated inhibition (Fig. 19B), and we

Figure 17. Proliferation by B cells grown with RK3G9 plus biotinylated MAR18 plus streptavidin. PBS is the control in this initial experiment. *A*, Proliferation was not inhibited by addition of RK3G9 + biotinylated MAR18 + streptavidin. *B*, Addition of the “scaffold” materials did inhibit IgE production, but to a much smaller degree than plate-bound RK3G9.

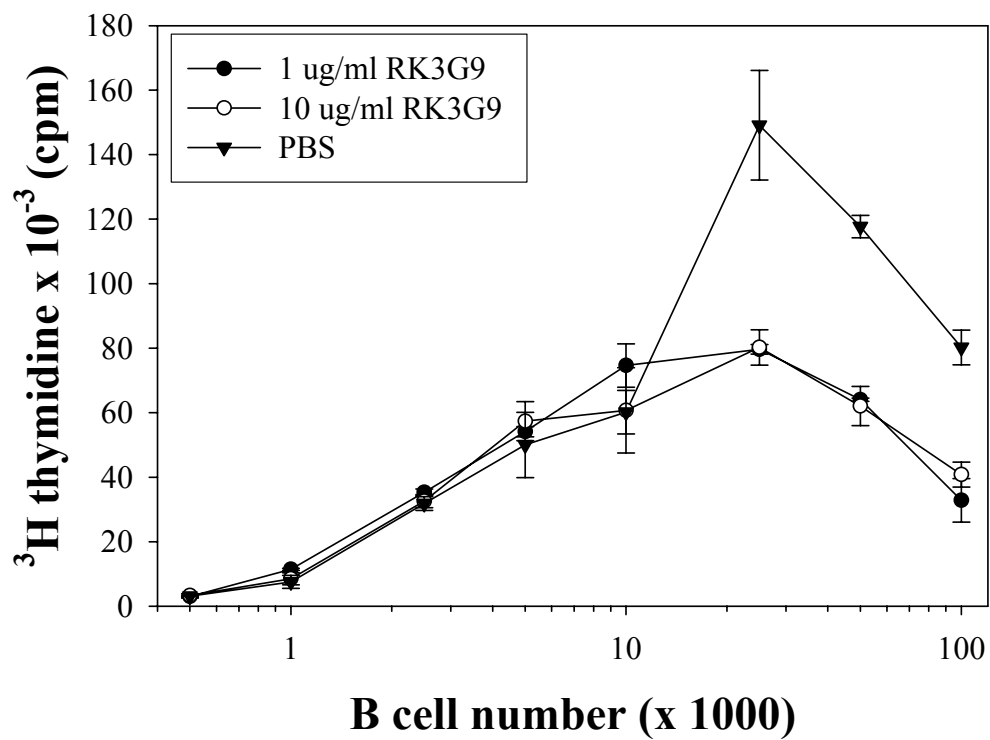
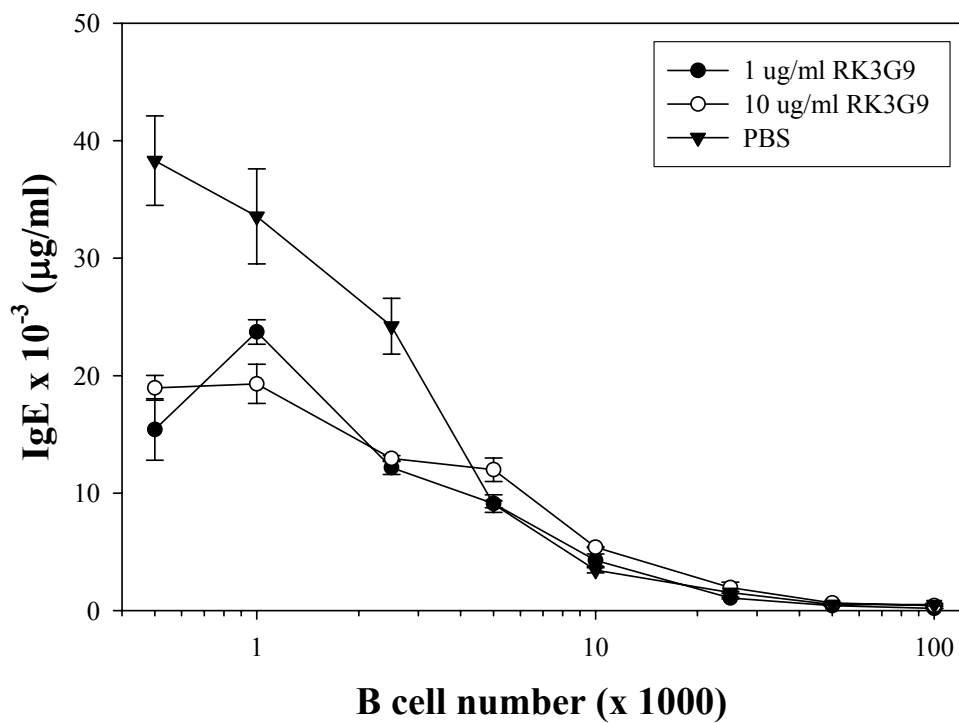
A.**B.**

Figure 18. IgE production by B cells grown with RK3G9 plus cross-linking agents. Biotinylated RK3G9 + streptavidin microbeads and biotinylated MAR18 + streptavidin microbeads + 1 or 10 μ g RK3G9 inhibited IgE production by about 50% at lower cell concentrations, as compared to the control.

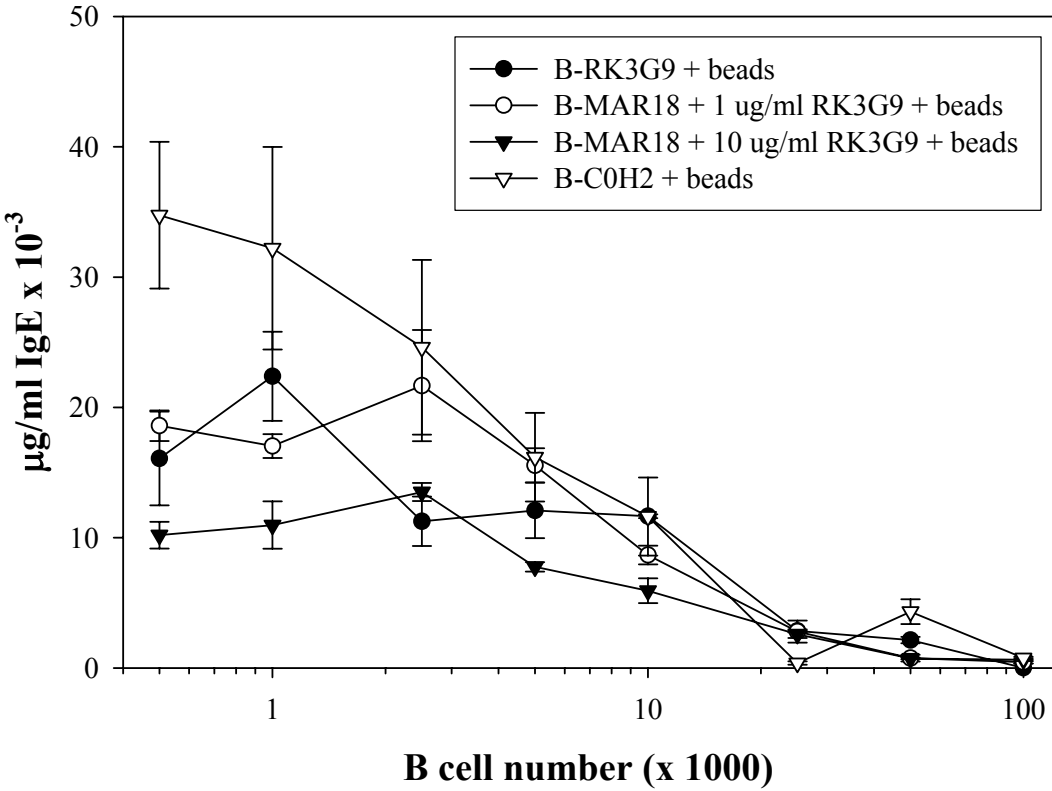
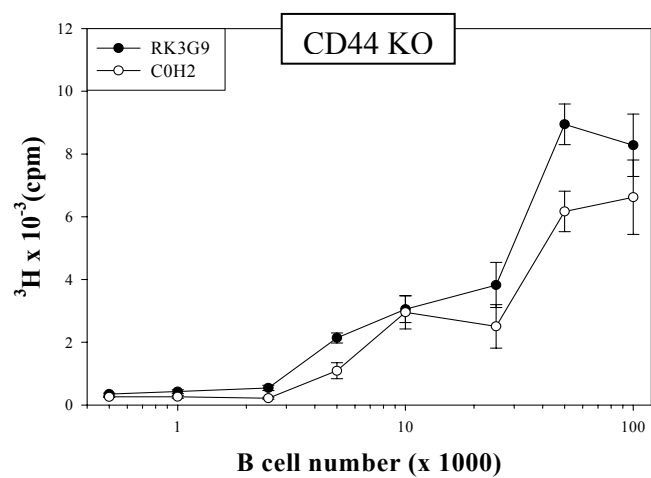
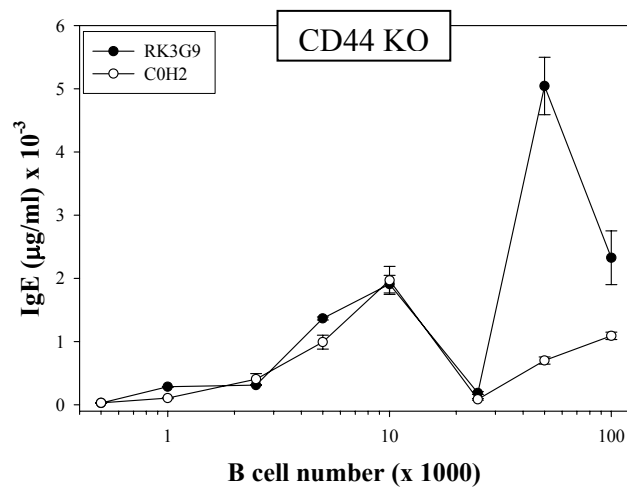
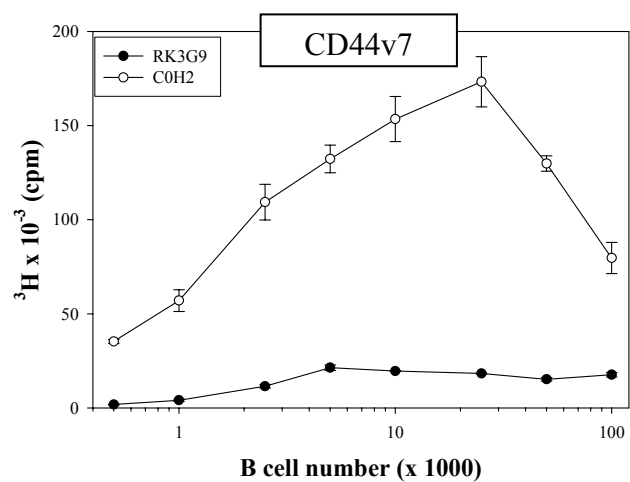
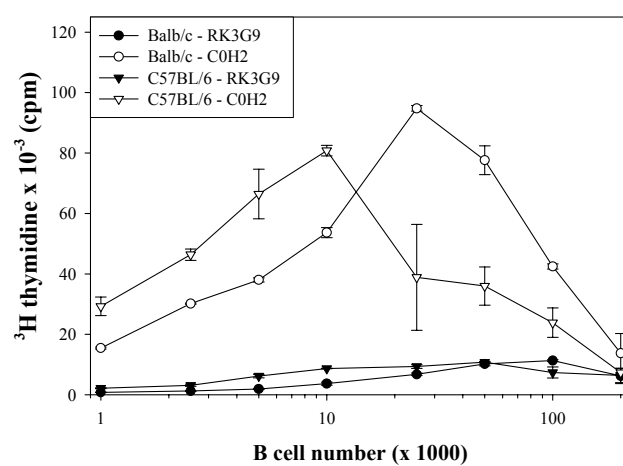


Figure 19. The CD44^{-/-} mice can not respond to RK3G9-mediated B cell inhibition of proliferation. *A*, CD44^{-/-} B cells proliferate normally when cultured with either anti-CD44 or control antibody (C0H2), and the IgE production shows no difference (*B*). *C*, CD44v7 KO B cells respond to the RK3G9-mediated inhibition, as shown by the IgE inhibition in the RK3G9-treated cells. *C*, Splenocytes from C57BL/6 and Balb/cJ mice had identical reactions to RK3G9, thereby confirming that the CD44 knockout data was valid.

A.**B.****C.****D.**

conclude that RK3G9 does not bind to CD44v7. It is also possible that normal, activated B cells do not express CD44v7.

The CD44 knockout mice were bred on the C57BL/6 background, and normal C57 splenocytes were isolated and grown as discussed above. Comparison was made to Balb/c splenocytes, as Balb/c is the strain used throughout these experiments. The proliferative capacity of the Balb/c and C57 cells was equal, and equally inhibited by the presence of plate-bound CD44 (Fig 19C).

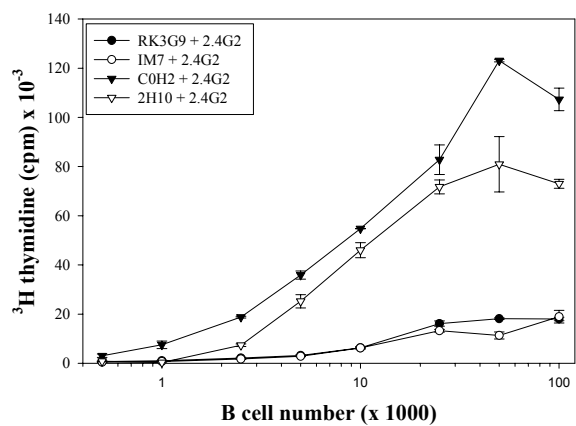
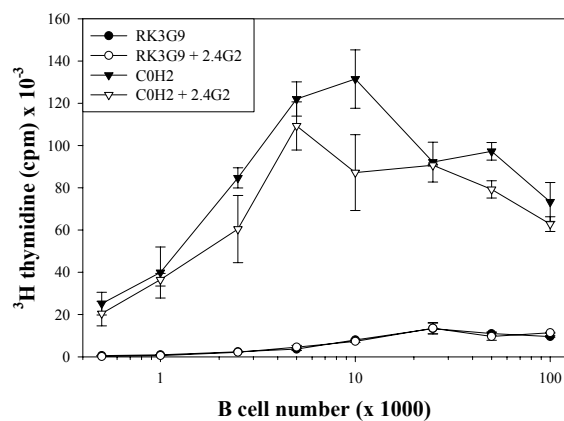
E. Fc γ RIIb is not involved in the inhibition seen during B cell CD44 cross-linking.

Fc γ RIIb, the inhibitory gamma receptor found on murine B cells, can inhibit B cell activation once it is bound and cross-linked. It was possible that the mechanism of B cell inhibition by RK3G9 was due to Fc γ RIIb binding the Fc portion of the anti-CD44. To rule this out, the effect of addition of an anti-Fc γ RIIb (2.4G2) Ab on the proliferation and IgE production of B cells was examined. The B cells were pre-incubated with 2.4G2 for 40 min. on ice prior to culture in “IgE cocktail”. The data showed that, with the inclusion of 2.4G2, the decrease in B cell proliferation (Fig. 20A) and IgE production (Fig. 20B) caused by immobilized anti-CD44 Abs was identical to that seen in Figs 12A and 12B. These data suggested that the inhibitory effect of plate-bound anti-CD44 Ab is a result of specific interaction with CD44 expressed on B cells, rather than a non-specific effect mediated by Fc γ RIIb.

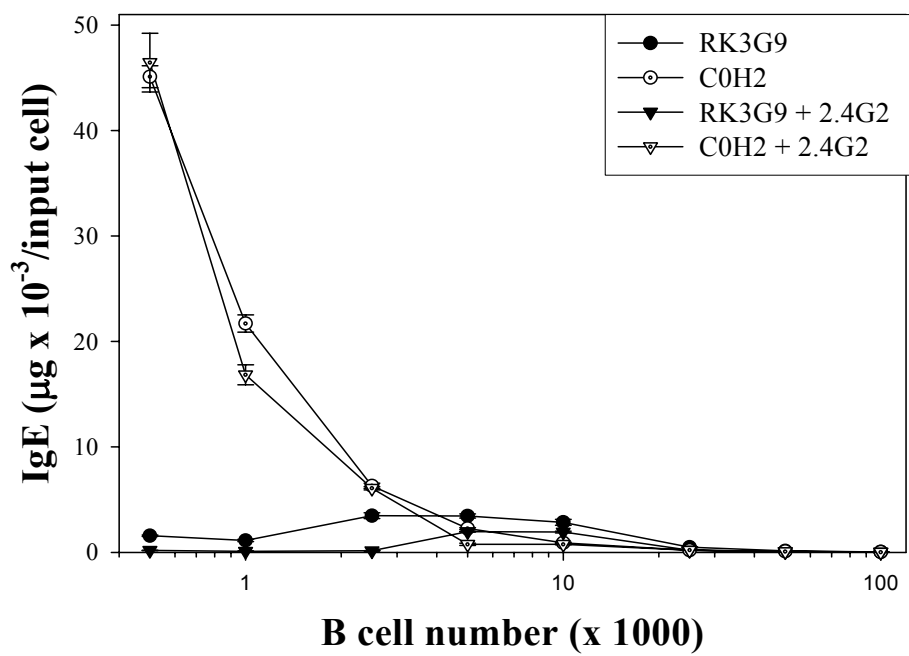
F. The “Missing Factor” Hypothesis. It was hypothesized that the B cells could be missing some important factor due to the RK3G9 effect on them; the proliferation and even later IgE production was inhibited. They could make some factor under normal

Figure 20. The inhibitory gamma receptor is not involved in the inhibition of IgE production by B cells whose CD44 is crosslinked by an anti-CD44 antibody. *A*, Cultures of B cells grown on immobilized RK3G9 or C0H2, regardless of addition of 2.4G2 addition or not, were significantly inhibited in their ability to proliferate (*A*) or produce IgE (*B*). In the right-hand graph in *A*, 2.4G2 was added to cultures grown on RK3G9, IM7, C0H2, or 2H10 (anti-CD23 control). Anti-FcγRIIb addition had no effect on the RK3G9- or IM7-mediated inhibition of proliferation of these cells. Control cultures provide the normal standard. These data are representative of at least two separate experiments.

A.



B.

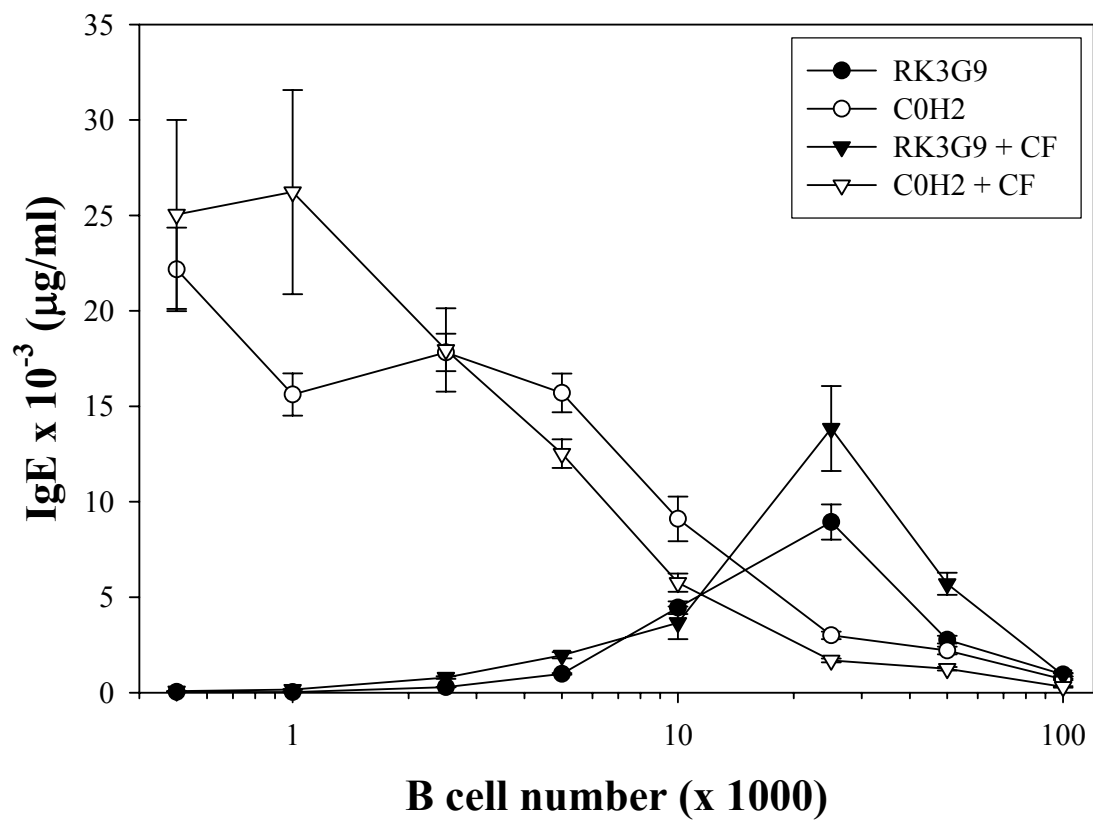


conditions that helps them grow – perhaps a contact-dependent factor (as B cells normally grow in clumps in culture) – and when cultured on anti-CD44 they could be unable to make the necessary connections. Two different experiments were conducted; in one, Cloning Factor was added, and in the other, supernatants from B cells grown in normal conditions from days 3 and 8 were added back to the RK3G9-treated cultures.

Cloning Factor is normally used as a supplement to “feed” hybridoma cells – ensuring that they get all the possible factors needed for growth. It is derived from a conditioned culture supernatant from a murine macrophage-like cell line. This was added at a 10% concentration to the RK3G9- or C0H2-treated murine B cells. Fig. 21 shows that addition of Cloning Factor (CF) did not ameliorate the inhibition seen by culture on RK3G9. This experiment was done prior to the regular FACS purification of the B cells, and when the cells were only partially pure (~85% by Percoll gradient isolation), they regularly partially overcame the RK3G9-mediated inhibition at the higher cell concentrations (25,000/well). This may be noteworthy and will be discussed further in the Discussion section.

Further testing of this “missing factor” hypothesis followed. It was possible that B cells grown in culture produced a contact-dependent or –independent factor which helped them to grow under normal conditions. The potential that receptors for these factors were or were not expressed was an issue that could not be addressed at this point. An experiment was set up to test this idea. Normal B cell cultures were grown for three or eight days and supernatants were collected. New B cell cultures were set up and grown

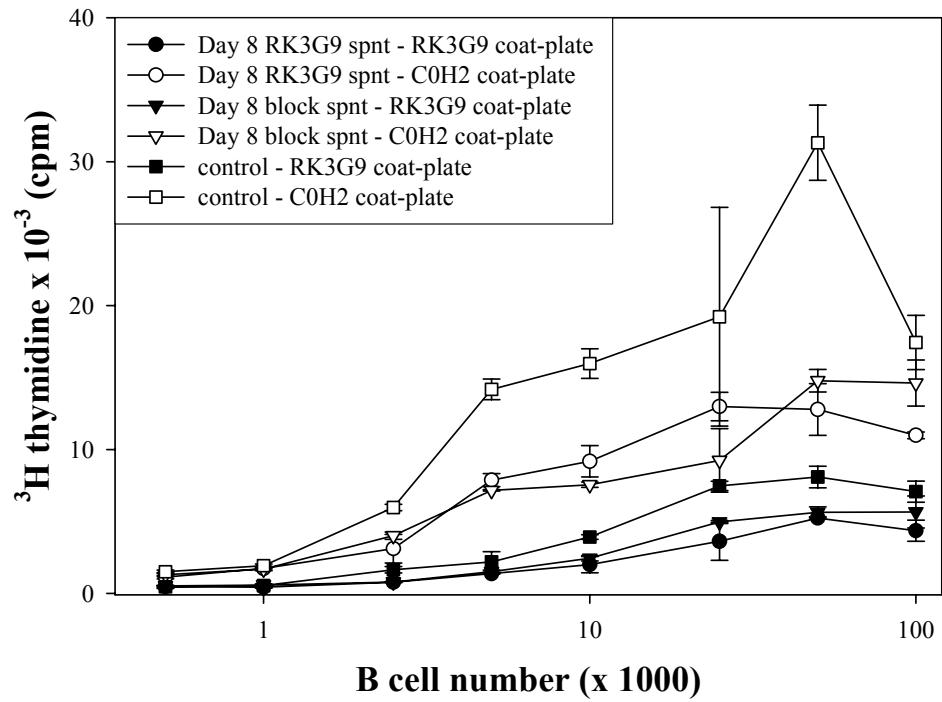
Figure 21. Addition of Cloning Factor to the cells did not cause a release of the inhibition seen in the RK3G9-treated cultures. B cells grown on RK3G9 with the addition of CF (Cloning Factor) were not released from the anti-CD44-mediated inhibition, as compared to B cells grown on RK3G9 alone.



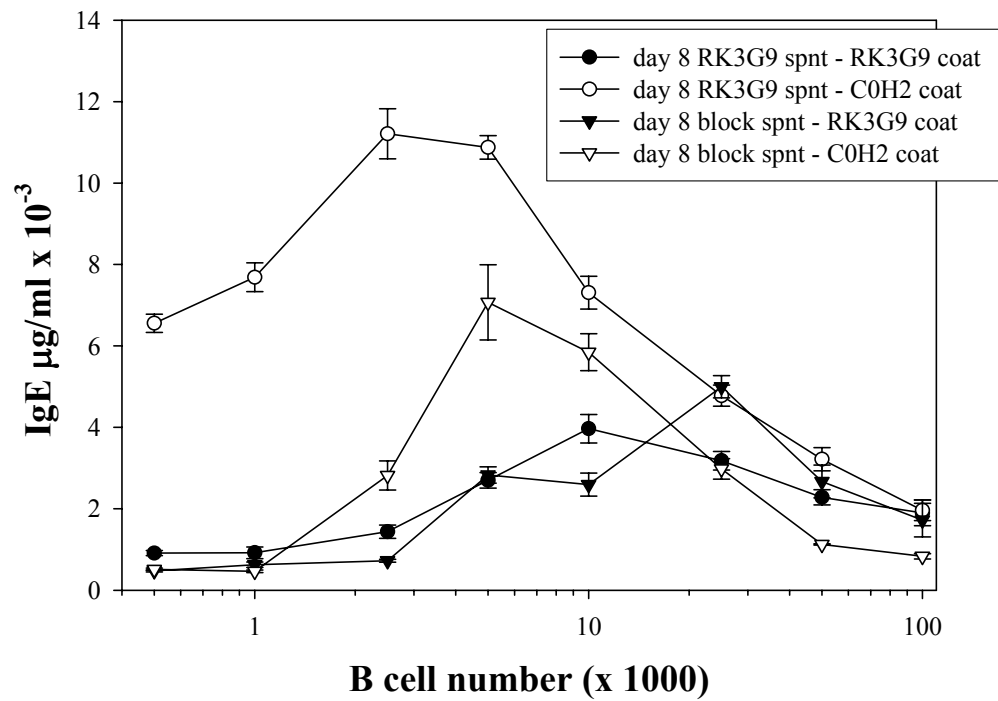
on RK3G9 or control, with the media consisting of 25% supernatant from either the 3-day or 8-day timepoints, with 75% new media. The results from the “day 3 supernatant addition” experiment were unclear, but Figure 22A shows that for the experiment involving Day 8 supernatants there was no effect of the “normal” B cell supernatant on the proliferation of B cells grown on RK3G9. In fact, regardless of the type (RK3G9 or C0H2) of supernatant added to the cultures, the B cells still responded to the anti-CD44 or control with similar proliferation. This suggests that the normal B cells do not produce a “factor” and also suggests that RK3G9- treated cells are producing any “factors” similarly to the normal B cells (as shown by the C0H2 B cells grown with 25% RK3G9 supernatant). The B cells incubated with Day 8 RK3G9 or “block” supernatant and grown on RK3G9 or C0H2 all have lower proliferative values than the B cells grown with 100% fresh media on either RK3G9 or C0H2; this is most likely a media effect. The IgE results showed that RK3G9-treated cells were not relieved of the anti-CD44-mediated inhibition by addition of either RK3G9 or C0H2 supernatants. The C0H2 culture grown in C0H2 supernatant had lower IgE-producing ability than its counterpart grown in RK3G9 supernatant. This is likely due to media depletion; the C0H2 supernatants would have fewer nutrients left and more cellular waste product buildup in the culture well after eight days than would the RK3G9 supernatant. This makes sense - control cells grow very quickly and use up the media, while RK3G9-treated cells grow very slowly (see Fig 12A). Another factor to be considered is that there may be contaminating IgE in the supernatants from day 8, as the supernatants were not filtered prior to addition back into fresh cultures. However, all things considered, there does not

Figure 22. Mouse B cells grown with additive supernatants still respond to anti-CD44. *A*, Proliferation of the cells grown for three days and incubated with day 8 RK3G9 or Day 8 “block” supernatants. The cells grown with RK3G9 or block supernatant and incubated on RK3G9 showed slightly greater inhibition with reference to the normal (100% fresh media) RK3G9-treated cells. As discussed in the text, this could be a media depletion effect. *B*, Addition of C0H2 supernatant did not relieve the inhibition seen in the RK3G9-treated cells. Again, the C0H2 control cultures differed somewhat and this is due to a media depletion effect.

A.



B.

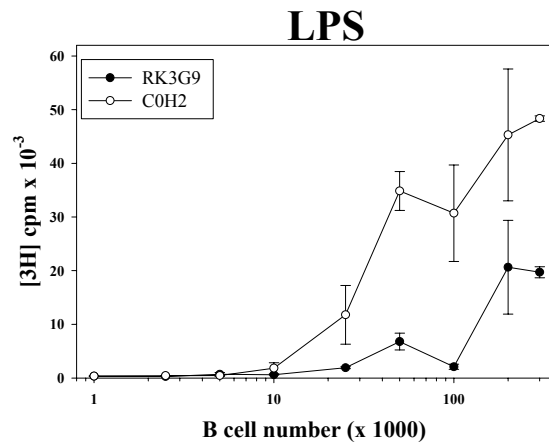
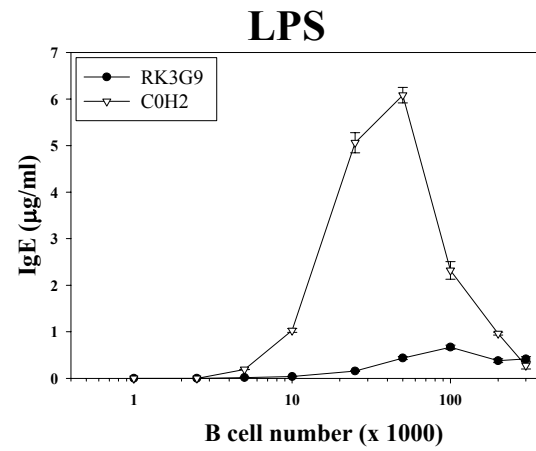
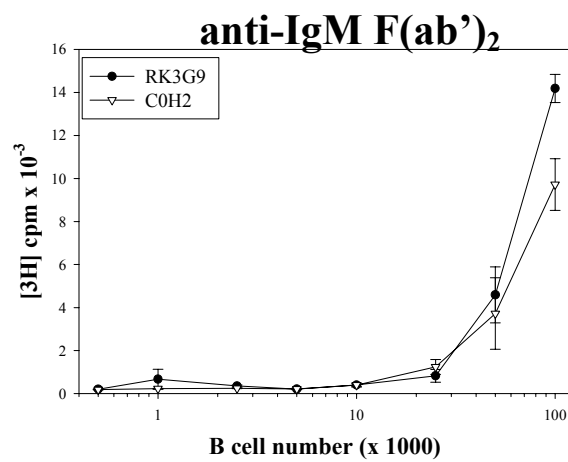
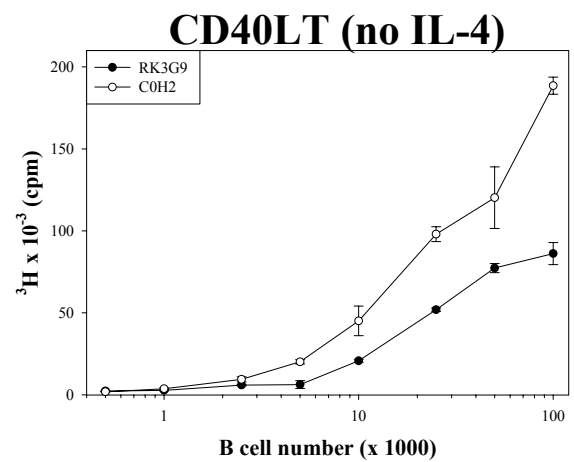


seem to be a “factor” in the supernatants that will provide relief from the anti-CD44 inhibition.

G. The effects of CD44 cross-linking on B cells are dependent on the type of B cell activator used. In order to further explore the activation conditions in which CD44 cross-linking inhibited B cell activation, B cell cultures were stimulated with IL-4 + LPS (25 $\mu\text{g}/\text{ml}$) and cultured on immobilized RK3G9 or C0H2. Under these conditions, B cells grown on immobilized RK3G9 were significantly inhibited in comparison to control cells, when proliferation (Fig. 23A) was examined. IgE production was similarly inhibited (Fig. 23B). B cell cultures were also stimulated with just CD40LT + M15 + IL-5 (no IL-4); the IFN γ experiment had indicated that IL-4 is not involved in the RK3G9-mediated inhibitory effect. However, the inhibition of proliferation by RK3G9 in this case was greatly decreased (Fig 23C). In addition, B cell cultures that were stimulated with IL-4 + anti-IgM F(ab') $_2$ (10 $\mu\text{g}/\text{ml}$) on immobilized RK3G9 or C0H2 for 3 days showed no effect due to CD44 cross-linking (Fig. 23D) in comparison to control cells. This suggests that CD44 cross-linking has no effect on the B cells when they are stimulated through the B cell receptor (BCR). Taken together, these data suggested that B cell activation and/or differentiation is affected by cross-linking CD44 when the cells are receiving their activation stimulus within the context of CD40LT or LPS; however, a stimulus promoting BCR activation is not subject to RK3G9 modulation.

H. The CD44 cross-linking effects are limited to the initiation of B cell activation. In order to explore the possibility that the effects of cross-linking CD44 on B cells were dependent upon how soon after activation that the B cells encountered the anti-CD44

Figure 23. B cell activation/differentiation is affected by CD44 cross-linking under a variety of growth conditions. *A*, Effect of IL-4 + LPS stimulation on proliferation of the naïve B cells. Immobilized RK3G9 significantly reduced the proliferation of the B cells. *B*, CD44 cross-linking due to RK3G9 resulted in a decrease of IgE production, when stimulated with LPS + IL-4. *C*, B cell cultures grown on RK3G9 and stimulated with IL-4 + anti-IgM F(ab')₂ (10 µg/ml) were identical in proliferation to control cells. *D*, B cell growth when stimulated by only CD40LT + M15 + IL-5 (no IL-4). The RK3G9 inhibitory effect is less than when IL-4 is included (see Fig. 12A). These data are representative of at least two separate experiments.

A.**B.****C.****D.**

antibody, B cells were stimulated with “IgE cocktail” and subsequently transferred, on four successive days, onto RK3G9-coated plates. The supernatants were assayed for IgE after 8 days in culture. Although cell numbers increased daily, the relative amount of IgE made by the cells cultured on RK3G9, up to a Day 3 transfer, was significantly lower than that made by cells cultured on control Ab. Day 4 transfer to RK3G9 or control resulted in similar amounts of IgE production. Table 2 shows the relative amounts of IgE ($\mu\text{g/ml}$) production by B cells either transferred to RK3G9 or C0H2, on successive days. The IgE produced by all concentrations of cells transferred to RK3G9 was averaged and is compared to that of cells transferred to control. The table clearly shows that B cells which are exposed to activating stimuli for 3 days or less, prior to transfer, are still subject to RK3G9-mediated inhibition. B cells which are activated for 4 days prior to transfer to immobilized anti-CD44 Ab almost completely lose the ability to respond to CD44 cross-linking. CD44 is known to be upregulated at the time of activation of a B cell but also is downregulated by Day 4-5, when the cell begins to display a germinal-center phenotype. This data suggests that there may be a link between time of activation and the ability to respond to CD44 cross-linking.

I. Activation of the B cells is dependent on both anti-CD44 signals and the interplay between different activation pathways. It is well known that there are three major B cell pathways of activation: through the CD40 receptor, through the B cell receptor (BCR), and through the Toll-like receptor (TLR). It has been shown here that B cells, when stimulated by IL-4 + CD40LT or IL-4 + LPS, – activating the B cells through an

Table 2. *B cell ability to respond to anti-CD44 signals is absent by day 4 of stimulation.* B cells were first grown in culture with stimulation and then added to RK3G9-coated plates after the specified number of days (left-hand column). The middle column shows the amounts of IgE (ng/ml) production by B cells transferred to RK3G9 and the right-hand column shows the amounts of IgE produced by cells transferred to C0H2. The IgE produced by all concentrations of cells transferred to RK3G9 or C0H2 was averaged and these are compared to each other. Parentheses indicate the standard error of the mean. By Day 4, cells transferred to RK3G9 lost their ability to respond to CD44-mediated inhibition and produced almost as much IgE as the control cells. These data are representative of at least two separate experiments.

TABLE II. B cell IgE response to anti-CD44 after X number of days growth

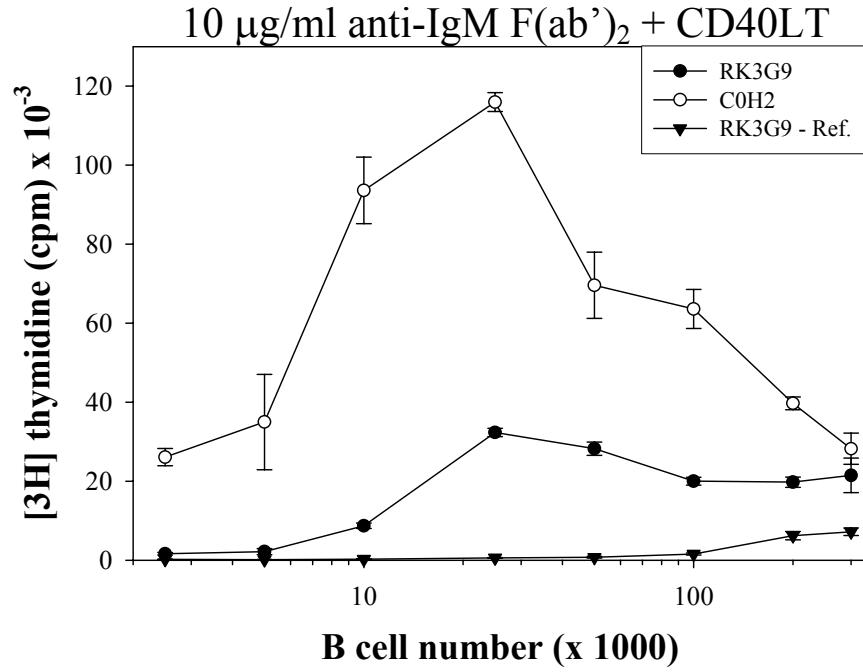
Day of B cell transfer C0H2	Cells on RK3G9	Cells on
Day 0	413.8 (101.3)	1371.1 (154.9)
Day 1	629.4 (188.5)	2257.6 (624.9)
Day 2	907.3 (333.4)	2850.1 (946.4)
Day 3	913.5 (275.8)	2714.8 (522.6)
Day 4	2160.4 (321.9)	2781.2 (567.1)

The numbers are average nanograms of IgE produced by these cultures as a whole; the cultures were grown at a variety of concentrations from 500 cells/well up to 100,000 cells/well. The numbers in parentheses are the standard error of the mean.

antigen-non-specific pathway – can be inhibited in their activation if CD44 cross-linking has occurred. In addition, B cell activation is not inhibited by CD44 cross-linking if the activation stimulus is anti-IgM F(ab')₂. Experiments were performed to examine the possibility that one of the pathways activated by the stimuli could be downregulated by BCR ligation during CD44 cross-linking. To address this question, purified B cells were incubated with IL-4 + CD40LT + anti-IgM F(ab')₂ (10 µg/ml) (Fig. 24A) or IL-4 + LPS + anti-IgM F(ab')₂ (10 µg/ml) (Fig. 25A) and they were grown for 3 days on RK3G9-coated or COH2-coated plates. The results were, in each case, that CD44 cross-linking could still inhibit proliferation of the B cells (Fig. 24A and 25A), albeit less so with the inclusion of BCR stimulation. B cells were then stimulated with IL-4 + anti-IgM F(ab')₂ – at increased concentrations of 25, 50, and 100 µg/ml – plus either CD40LT or LPS. Again, they were grown on immobilized anti-CD44 for 3 days. Data for the 25 and 50 µg/ml anti-IgM are not shown, but at 100 µg/ml anti-IgM F(ab')₂, +/- CD40LT (Fig. 24B) or LPS (Fig. 25B), growth inhibition was no longer observed. While increased stimulation of the BCR will stimulate a greater number of cells, so also will this increased anti-IgM presence cause a phenomenon termed “receptor blockade” – which is what occurs when receptors are downregulated in response to overwhelming stimulation, i.e., the stimulation itself becomes inhibitory. One explanation for the data in Figs. 24B or 25B is that the receptors are downregulated and the BCR-stimulated culture did not proliferate as well as it did at lower stimulation, thus creating a false impression that the RK3G9-treated cultures were able to overcome the anti-CD44 crosslinking. However, while this may be a factor, the relative differences between the cultures on RK3G9 and

Figure 24. B cell activation inhibition by CD44 cross-linking is dependent on the type and amount of stimulation. *A*, Using 10 $\mu\text{g/ml}$ anti-IgM F(ab')_2 + CD40LT + IL-4 as the stimulus, B cells grown on RK3G9 are inhibited in their ability to proliferate. The “RK3G9 – Ref.” is put in as a reference line (in 24A-B and 25A-B) and the data is seen originally in Figure 12A with “IgE Cocktail”-stimulated cells. This line illustrates maximal inhibition. *B*, Using an increased concentration of anti-IgM, - 100 $\mu\text{g/ml}$ anti-IgM F(ab')_2 + CD40LT + IL-4 as the stimulus – B cells grown on RK3G9 are no longer inhibited in their ability to proliferate. These data are representative of at least two separate experiments.

A.



B.

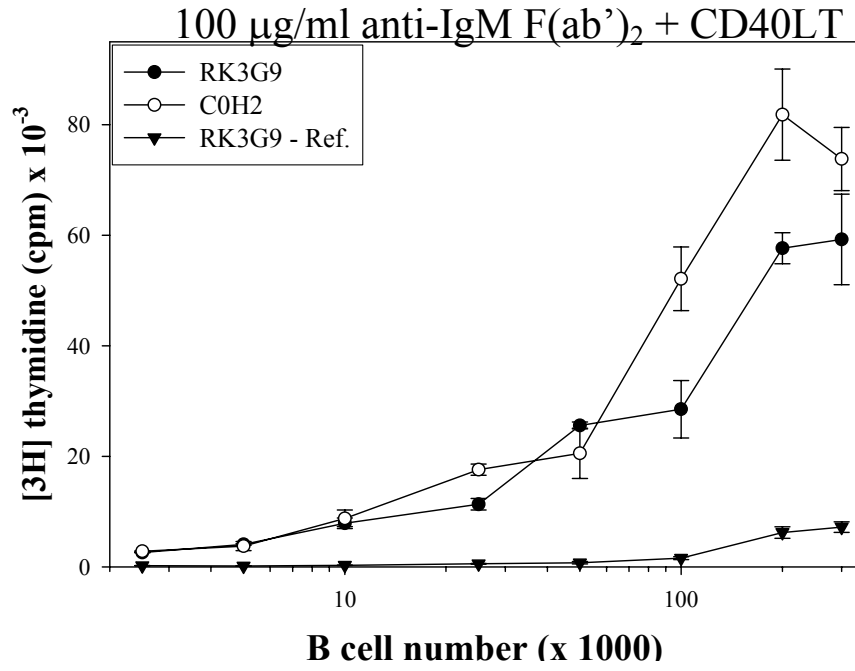
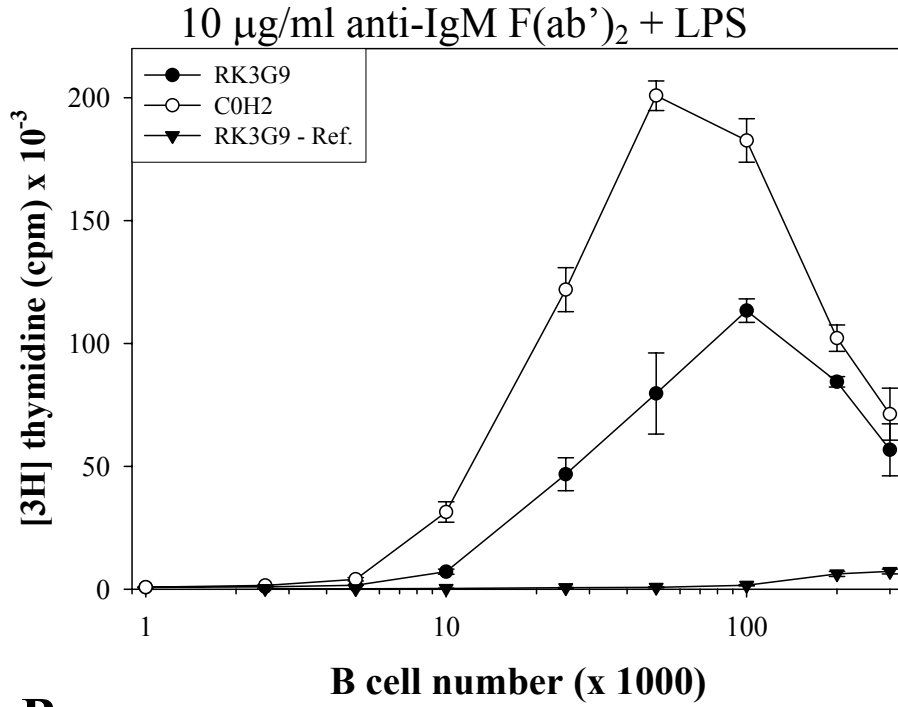
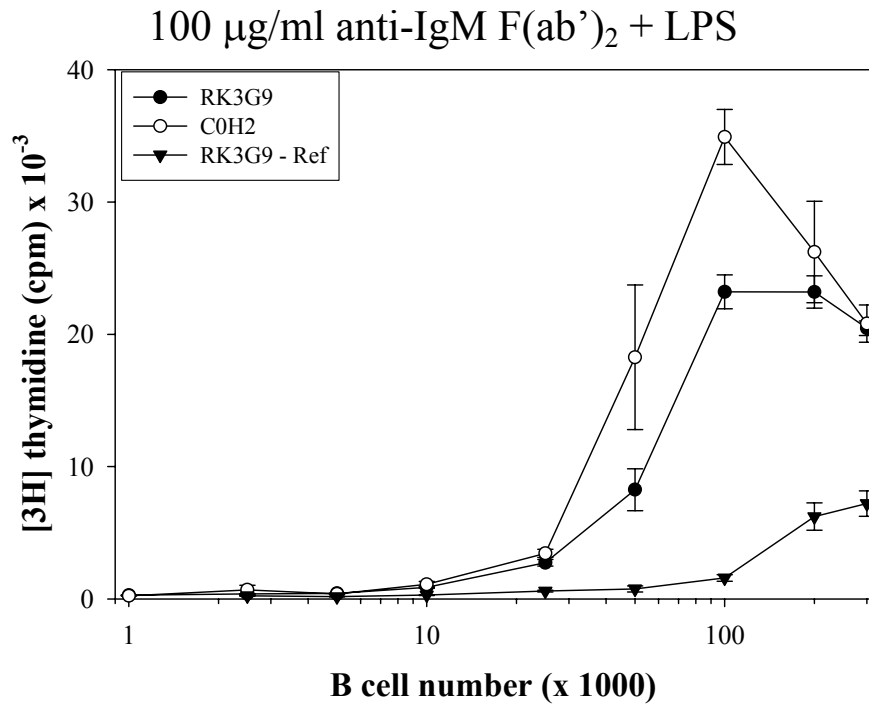


Figure 25. *A*, Similarly, with 10 $\mu\text{g/ml}$ anti-IgM F(ab')_2 + LPS + IL-4 as the stimulus, B cells proliferation is again inhibited when they are grown on RK3G9, though with less potency. *B*, B cells stimulated by 100 $\mu\text{g/ml}$ anti-IgM F(ab')_2 + LPS + IL-4 did not respond with reduced proliferation to CD44 cross-linking. B cells grown on RK3G9 proliferated similarly to those grown on the control antibody. These data are representative of at least two separate experiments.

A.



B.

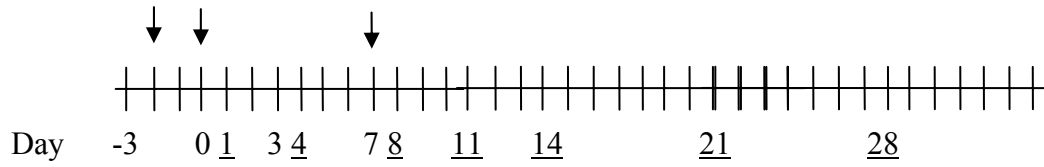
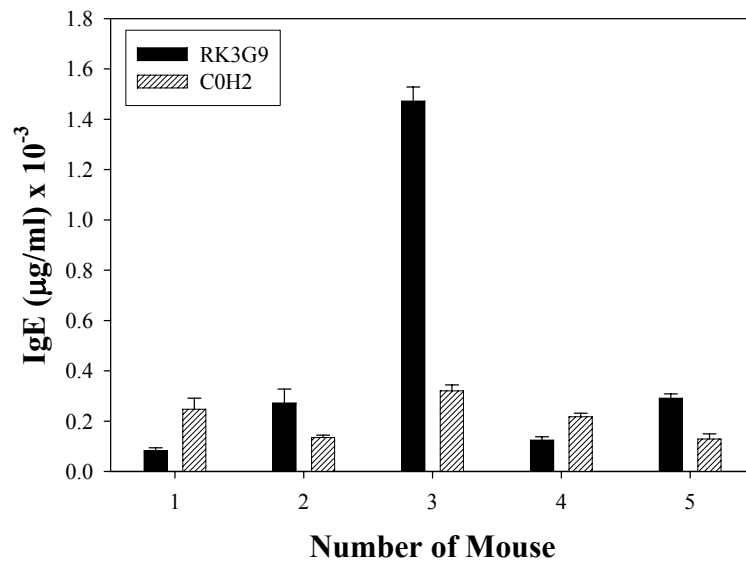
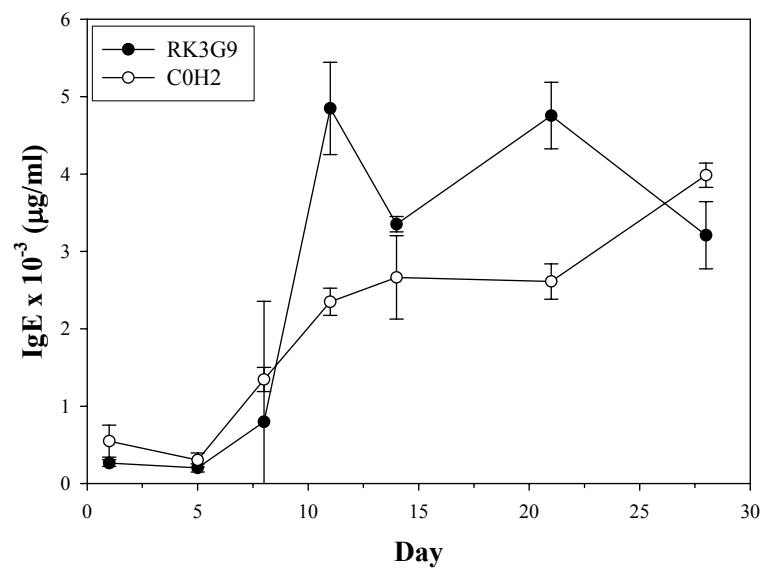


C0H2 when stimulated with combinations including 10 or 100 $\mu\text{g/ml}$ are still valid: increasing amounts of anti-IgM in combination with CD40LT or LPS will overcome the RK3G9-mediated effect.

J. *In vivo* experiment with RK3G9. The purpose of this experiment was to discover if soluble anti-CD44 could cause an inhibition of B cell responses *in vivo*, as measured by IgE production. IgE was chosen because it is very low prior to antigen exposure and because that is the one immunoglobulin which was repeatedly seen to be inhibited to the greatest degree in the *in vitro* experiments. Fig. 26A shows the setup for the experiment. The mouse strain used was Balbc/J and the nine mice were given three subcutaneous injections of RK3G9 – on days -2, 0, and 7. Alum-Ag (KLH-DNP) was also injected on days 0 and 7. The mice were bled on days -3, 1, 4, 8, 11, 14, 21, and 28. The day -3 bleed is a pre-bleed to ensure that the IgE levels in these mice was low (naïve). Fig. 26B shows the IgE pre-bleed levels. Mouse #3 in the RK3G9 group had very high ($\sim 1.5 \mu\text{g}$) IgE and was not used for the remainder of the experiment. There were five mice in the C0H2 (control) group and four in the RK3G9 group. The IgE levels over the course of the 28-day experiment are shown in Fig. 26C.

K. CD138⁺ B cells are decreased with RK3G9-treated cells. CD138 is known to be a marker of plasmacytic differentiation in B cells. If the striking decrease in IgE production was due to some “anti-CD44-induced defect” in becoming plasma cells, there should be fewer CD138⁺ cells. B cells were isolated and grown with “IgE cocktail” on RK3G9 and 6B2 (anti-B220) antibodies at 10,000 (10K) cells per well – a concentration wherein the immunoglobulin production was affected by the presence of RK3G9 and simultaneously

Figure 26. IgE levels were unchanged by injection of RK3G9 *in vivo*. *A*, Schematic of the time-course of the injections and bleeds for the mice. The mice were given three subcutaneous injections of RK3G9 – on days -2, 0, and 7. Alum-Ag (KLH-DNP) was also injected on days 0 and 7. The mice were bled on days -3, 1, 4, 8, 11, 14, 21, and 28. *B*, IgE levels in the mice prior to injection. Mouse #3 in the RK3G9 group had very high initial IgE levels and was not used in this experiment. *C*, IgE levels in the mice treated with RK3G9 or C0H2. Pre-bleed IgE levels were not subtracted from the final results.

A.**B.****C.**

where enough cells could be collected for FACS and Elispot analysis. The 6B2 antibody was chosen as a control for this and remaining experiments due to its lack of signaling properties under the conditions used to stimulate the cells, as well as its being a pan-B cell marker. It also was chosen because it would flatten the cells onto the plate and act as a control for the use of trypsin-EDTA (to get the cells off the plate and into a FACS tube). It has been shown in this lab previously that 6B2 can be used as a control and has no effect on proliferation or IgE production (data not shown).

For FACS analysis, cells were collected at day 6 and stained with CD138. Day 6 was chosen because most of the mouse B cells in culture are dead by day 8. While there were greater overall numbers of cells recovered from the C0H2 cultures, the percentage of live vs. dead cells was similar (FACS data, not shown). Figure 27 shows that cells grown on control (6B2) were 30.71% positive for the plasma cell marker CD138, while RK3G9-treated cells were 7.62% positive. The decrease in CD138 positivity in the RK3G9-treated cells was not as great as the decrease in Ig production, but it was still significant.

To confirm the data (above) suggesting that the anti-CD44-mediated inhibition was at least partially due to formation of fewer plasma cells, Elispot analysis was performed for the presence of IgG₁- and IgE-bearing plasma cells. Again, the cells were grown as stated above and collected at day 6. Elispot spot counts by light microscope revealed that B cells grown on immobilized RK3G9 had formed fewer IgE⁺ plasma cells than the control cells grown on 6B2 (Fig 28A). IgG₁⁺ plasma cells (Fig. 28B) were also counted and similar results were obtained.

Figure 27. Fewer CD138⁺ cells are present with RK3G9-treated cells. This graph depicts the FACS analysis of the CD138⁺ cells present after growth on RK3G9 or 6B2 for 6 days. RK3G9-treated cells are only 7.62% CD138⁺, while the 6B2-treated cells are 30.71% CD138⁺. This experiment is representative of four separate experiments.

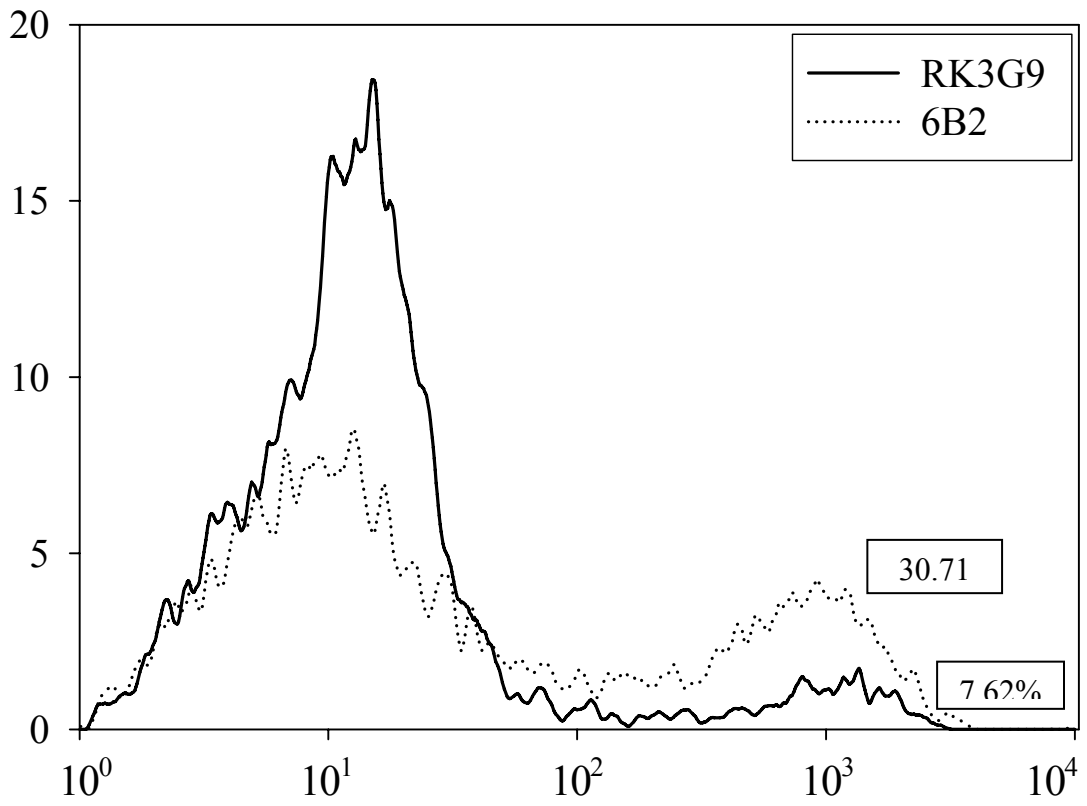
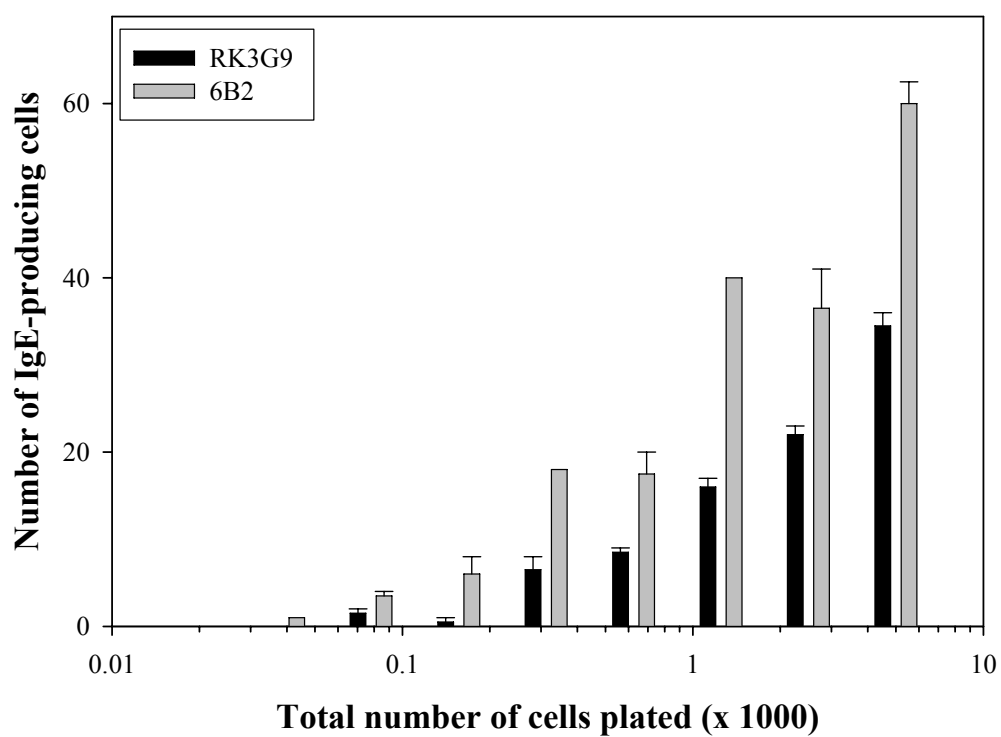
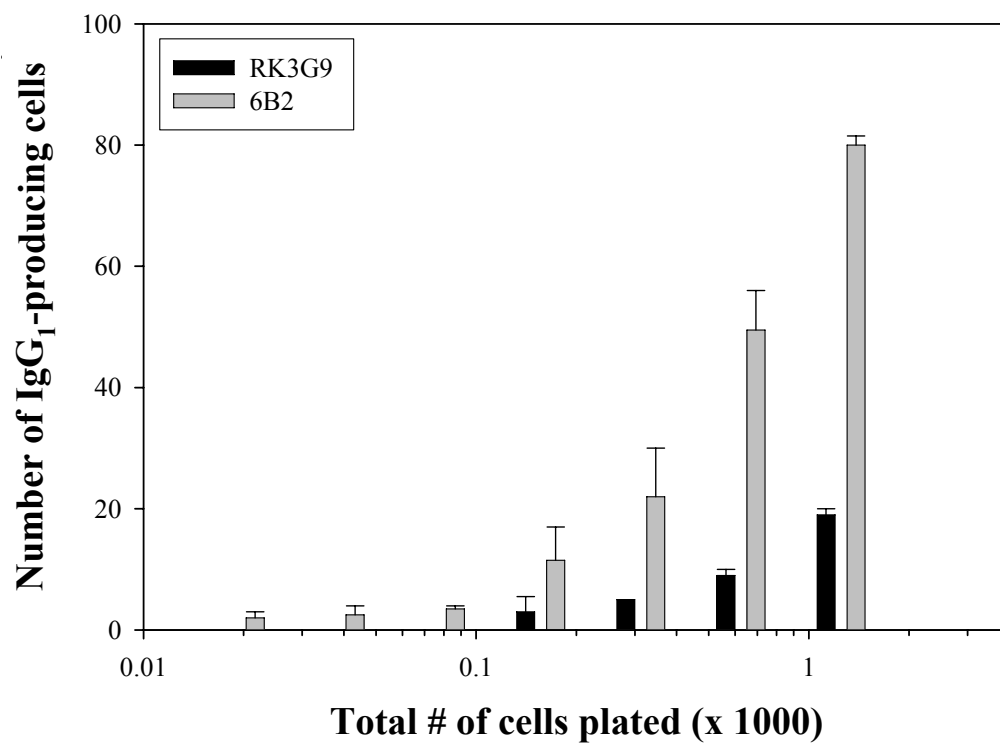


Figure 28. Elispot analysis showed that fewer plasma cells formed in the B cell cultures grown on anti-CD44 (black bars), as opposed to those grown on 6B2 control antibody (white bars). *A*, Elispot for IgE-forming cells; *B*, Elispot for IgG₁-forming cells.

A.



B.



These experiments, taken together and added to the immunoglobulin inhibition data, strongly suggest that anti-CD44 is inhibiting plasma cell formation under these experimental conditions.

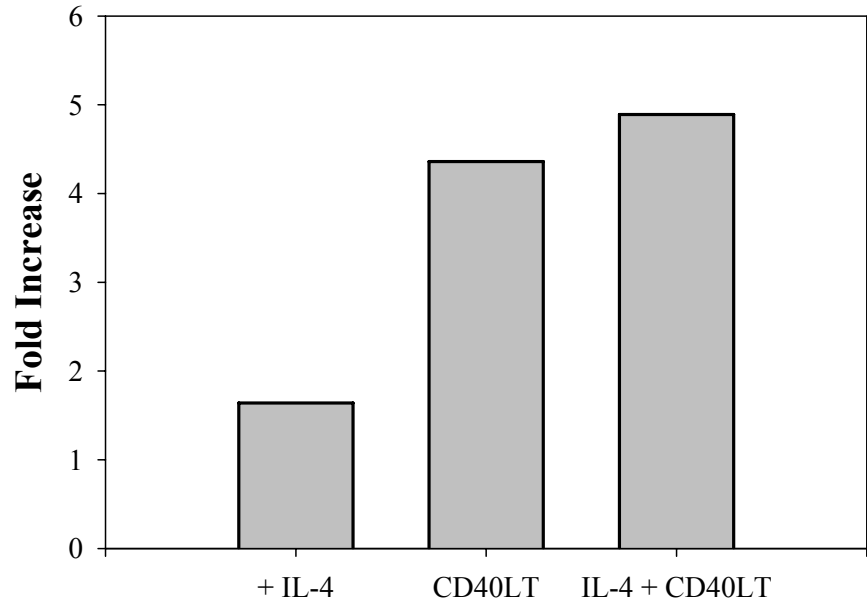
II. Investigation of CD23b promoter region.

A. Efforts to “fix” the “defect” in the transcription initiation region of the CD23b promoter. The relative similarities, as well as the lack thereof, between the CD23a and CD23b promoters was discussed in the Introduction. The CD23a promoter has a TATA box in the transcription initiation site; hence the first step was to put a TATA box into the transcription initiation site in the CD23b promoter. The TATA box was added by cloning the CD23b promoter into a pGL3 vector containing the TATA box used by CD23a. The TATA box was cloned in to enhance the likelihood of RNA polymerase binding, so that transcription could be initiated and mCD23b protein could be expressed. An initial luciferase assay showed an almost 5-fold increase of CD23b promoter activity (with stimulation by IL-4 + CD40L) over the basal level (no stimulation) and very little increase with IL-4 alone, indicating that IL-4 is not the sole regulator of CD23b (Figure 29A). However, a second experiment measuring total luciferase activity of CD23b with or without the added TATA box was still far below that seen with CD23a (Fig 29B).

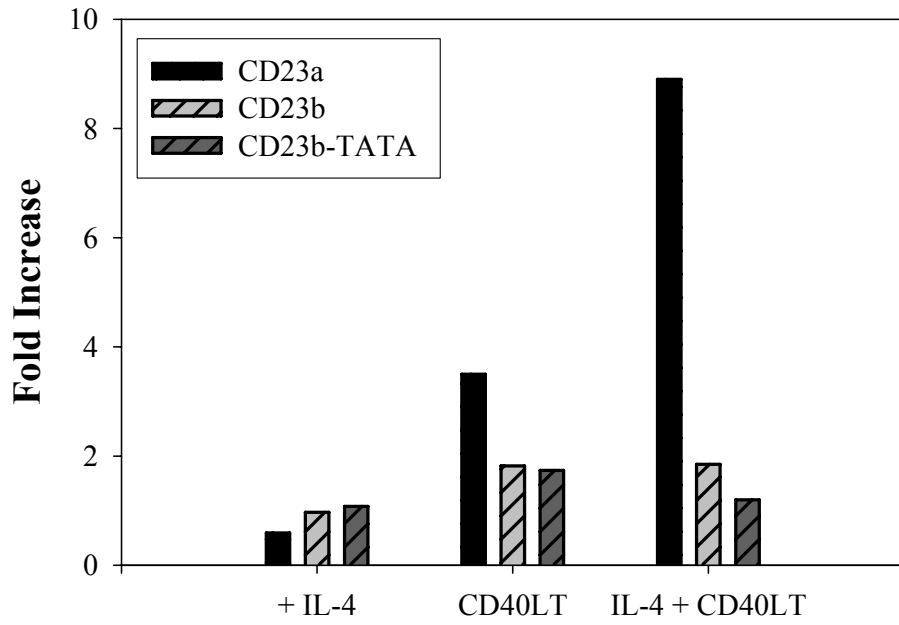
The mCD23b promoter was also compared to the human CD23b (huCD23b) promoter in luciferase vector constructs; used in this set of experiments were the human CD23b promoter (pLUC+CD23BP) and the murine CD23b promoter with and without the CD23a TATA box (pGL3-CD23b and pGL3-CD23b-TATA). These were transiently

Figure 29. Activity of the CD23b promoter vs. CD23b-TATA vs. CD23a promoter. The RLU20(relative light units) are a measure of the fluorescence of the luciferase, which correlates with the activity of the promoter. *A*, The CD23b-TATA had a ~5-fold increase in luciferase activity when stimulated with both IL-4 and CD40LT. *B*, Two additional experiments revealed that CD23b-TATA had essentially equal activity to CD23b promoter, and neither was as active as the CD23a promoter.

A.



B.

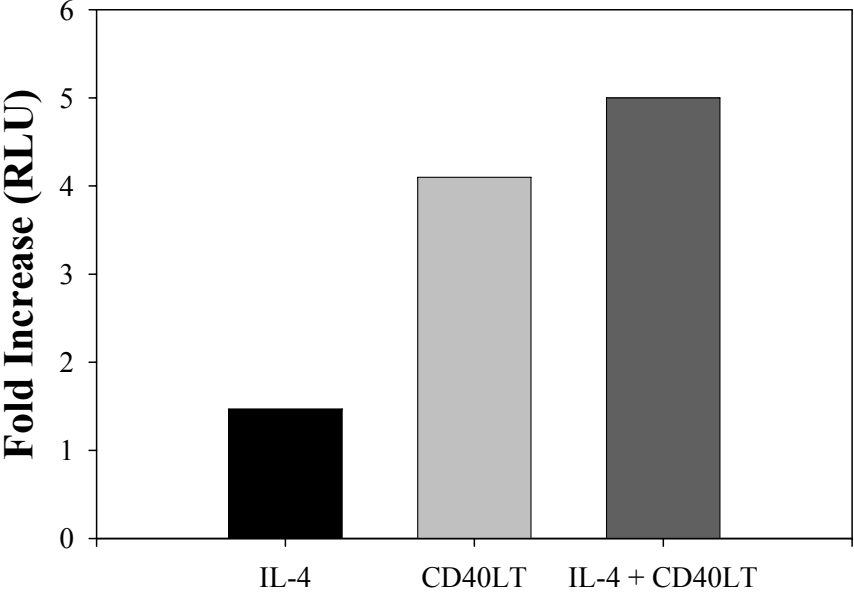


transfected into either M12.4.5 cells or HEK293 cells. An initial luciferase assay confirmed that the pLUC+CD23BP construct did work in the M12.4.5 cell line (Fig. 30A), suggesting that the mouse B cells do not appear to be lacking any proteins that would inhibit CD23b expression. Additional experiments in either M12.4.5 cells or in HEK293 cells (Fig. 30B) showed that both murine and human CD23b promoters had some activity. Figure 30B shows the activity of the pLUC+CD23BP when stimulated with various concentrations of huIL-4 vs. pGL3-CD23bProm with the previously determined optimal IL-4 stimulation. pGL3-CD23bProm-TATA was also assayed in a separate experiment & its activity was similar to that of pGL3-CD23bProm.

B. Creation of an antibody specific for the CD23a or CD23b isoform. Oligos for use in RT-PCR were created to encompass full-length CD23a or CD23b, for the purpose of cloning each isoform and transforming it into CD23^{-/-} competent cells (see Materials & Methods). Simultaneously, CD23a and CD23b peptides (using sequence from the intracellular portion) were created and used to immunize rabbits (both services from Open Biosystems, Huntsville, AL) in order to get a CD23 isoform-specific antibody. The full-length CD23 protein would be harvested and used to test the rabbit serum containing the isoform-specific antibody. The isoform-specific antibody would be used to confirm the presence of CD23b in apical intestinal cells and to look for its surface expression also in lymphocytes. Experiments by intracellular FACS staining and Western blot, using IEC4.1 and 293 cells, showed that there was no isoform-specific antibody activity in the rabbit serum for either CD23a or CD23b.

Figure 30. Activity of the human and mouse CD23b promoters. The RLU (relative light units) are a measure of the fluorescence of the luciferase, which correlates with the activity of the promoter. *A*, The pLUC+CD23BP had a measurable luciferase activity – approximately a 5-fold increase when stimulated with both IL-4 and CD40LT. *B*, Luciferase vectors containing huCD23b or mCD23b were transiently transfected into HEK293 cells. The human CD23b is shown in the left three bars and is stimulated with various amounts of IL-4. It is compared to the mCD23b stimulated by a standardized amount (see Materials & Methods) of rmIL-4, shown on the right. The greatest amount of luciferase was produced when the human CD23b promoter was stimulated with 2000 U/ml of rhuIL-4, a non-physiological amount. The 20 U and 200 U of IL-4, which are closer to physiological proportions, show that the human and mouse CD23b have similar responses to IL-4 stimulation.

A.



B.

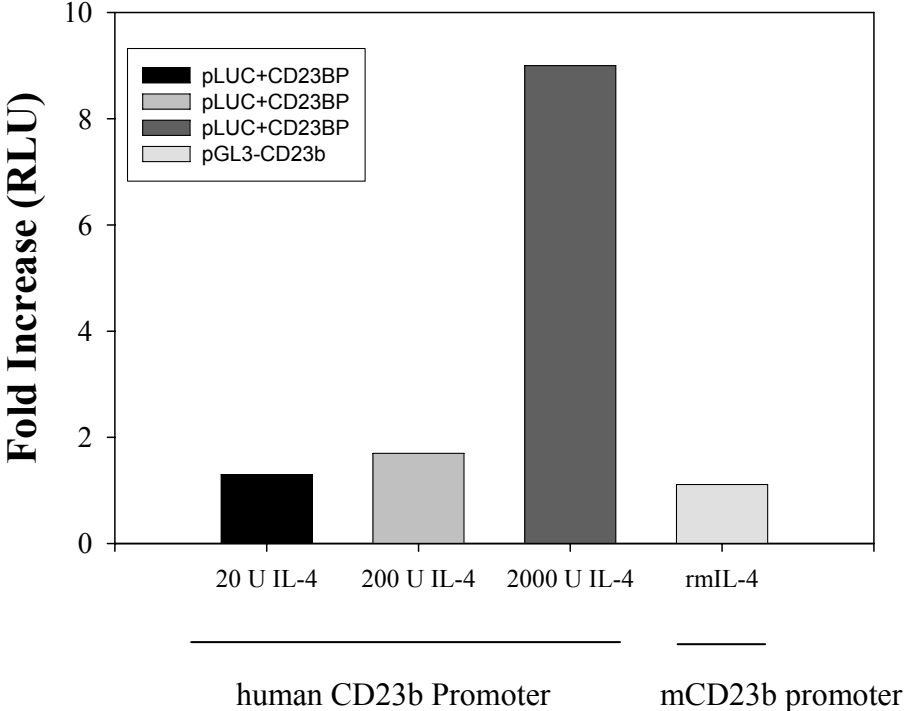
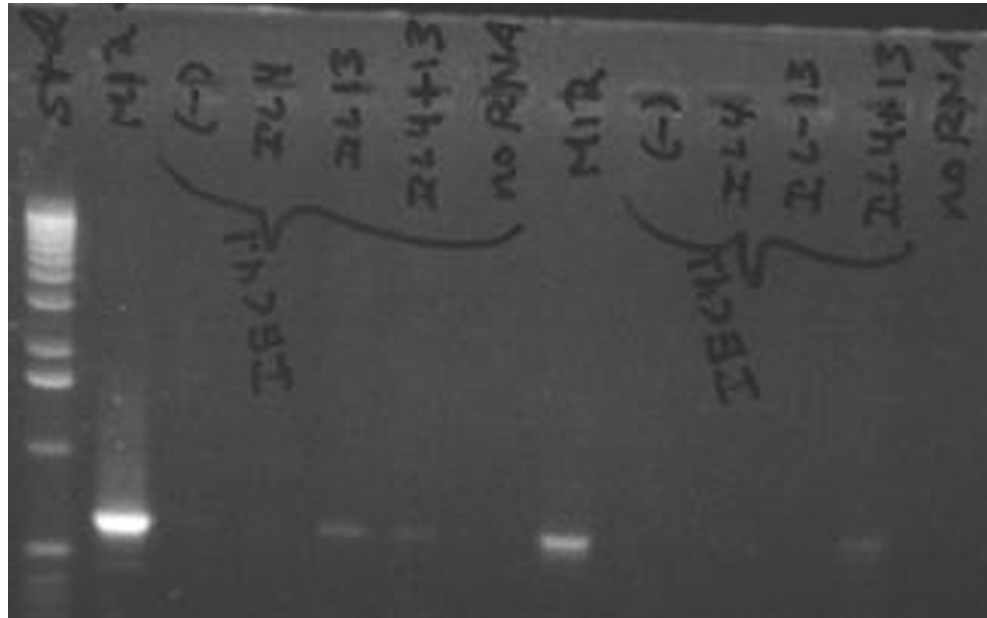
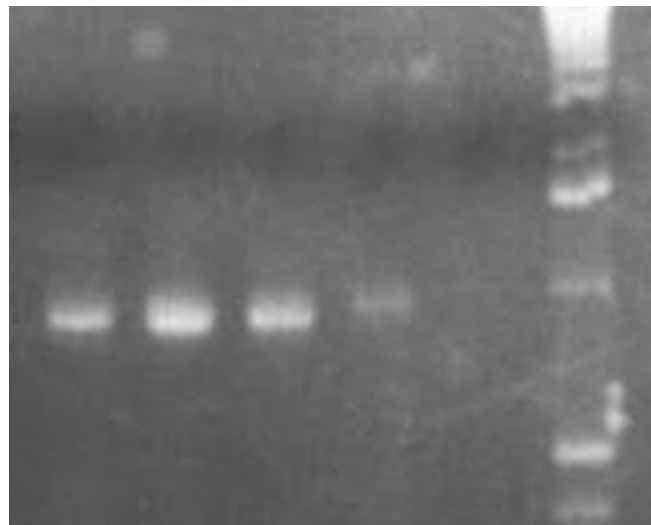


Figure 31. RT-PCR for CD23b in the IEC4.1 cells. *A*, The first lane is the DNA ladder; Lanes 1-5 are for CD23a; Lanes 6-10 are for CD23b. Lanes 1 and 7 are M12.4.5 cell RNA; Lanes 2 and 8 are unstimulated IEC4.1 RNA; Lanes 3 and 9 are IL-4-treated IEC4.1 RNA; Lanes 4 and 10 are IL-13-treated IEC4.1 RNA; Lanes 5 and 11 are IL-4+IL-13-treated IEC4.1 RNA; and Lanes 6 and 12 are control reactions with no RNA added. The M12 RNA is a positive control for CD23a and CD23b. IL-4+IL-13 combination treatment caused the most CD23b expression in the IEC4.1 cells. *B*, A separate RT-PCR for CD23b in IEC4.1 cells. Lane 1 is unstimulated IEC4.1, Lane 2 is IL-4 stimulated IEC4.1, Lane 3 is IL-13 stimulated IEC4.1, Lane 4 is unstimulated M12 RNA, and Lane 5 is the no RNA control. Lane 6 is the DNA Ladder standard.

A. 1 2 3 4 5 6 7 8 9 10 11 12



B. 1 2 3 4 5 6



C. Analysis of murine intestinal epithelial cells for expression of the CD23b isoform.

With the exciting possibility that the CD23b isoform could be expressed in intestinal epithelial cells, this angle was pursued and experiments involving IEC4.1 cells (a Balb/cJ-derived intestinal epithelial cell line) were begun. Initially, reverse-transcriptase polymerase chain reaction (RT-PCR) confirmed the presence of CD23b in these cells (Fig. 31); however, a band corresponding to CD23a was also seen – and CD23a is not expressed in these cells.¹⁵³ As mentioned above, the proposed “isoform-specific antibody” was tested on these cells as well as HEK293 cells transfected with full-length CD23a or CD23b. After multiple tests by Western Blot and FACS, the results were negative for CD23 and there was no “isoform-specific antibody” activity.

DISCUSSION

I. Anti-CD44 studies on B cell activation.

The current study describes the effects of the immobilized anti-CD44 mAb RK3G9 on the activation of purified murine B cells. When cultured in anti-CD44-coated plates, proliferation was inhibited to a significant degree at all cell concentrations tested, and immunoglobulin production was decreased. There was neither inhibition nor enhancement of T cell growth when cultured on RK3G9. Soluble RK3G9 had no effect, inhibitory or stimulatory, on the B cells, at any cell concentration or antibody concentration tested. The inhibitory IgG Fc receptor, Fc γ RIIb, was not involved in this anti-CD44-mediated inhibition, as demonstrated by the absence of any reversal of the B cell inhibition when 2.4G2 was added to the cultures. Addition of microbeads to make a soluble “scaffold” and mimic the plate-bound RK3G9 was only minimally successful. Addition of B cell supernatants or Cloning Factor could not provide relief to the B cells grown on RK3G9. When the B cells were stimulated and allowed to grow for 4 days prior to exposure to immobilized anti-CD44 antibody, the effects of CD44 cross-linking were lost. B cell responses to CD44 co-ligation by immobilized anti-CD44 Abs were dependent upon the specific stimuli used to activate the B cells. Immobilized anti-CD44 in combination with CD40L or LPS stimulation resulted in inhibition of B cell activation, whereas CD44 cross-linking had no effect on anti-IgM F(ab')₂-stimulated cells. Combined addition of the activating cocktails indicated that BCR signaling could completely reverse the inhibition seen. The plasma cell marker CD138 was decreased in

the RK3G9-treated cells and Elispot analysis confirmed the anti-CD44-mediated decrease in plasma cell numbers. Overall, the data in this dissertation suggests an important regulatory role for CD44 cross-linking with respect to B cell activation and differentiation. To my knowledge, this is the first report that immobilized anti-CD44 antibody is capable of inhibiting B cell function with the concurrent dependence of such on the activating stimuli.

Immobilized mAbs to CD44 typically initiate a spreading type of morphology.^{190,191} This morphologic phenotype has plasticity and requires rearrangements of the intracellular actin, tubulin, and vimentin, suggesting that B cells are prepared to interact with other cells or the extracellular matrix (ECM).¹⁹² This is proposed to regulate the activation status or the migration of activated B cells.¹⁹² Santos-Argumedo, *et al*, examined the effect of immobilized anti-CD44 mAbs on murine B cells.¹⁹¹ This report detailed the spreading of activated B cells on immobilized anti-CD44, using various immobilized mAbs. The activation stimuli were either IL-4 + anti-IgM or IL-4 + anti-CD38 and the cell concentration used was 10^6 /ml. Resting (unactivated) B cells were unable to spread on anti-CD44, but activated B cells spread and formed dendritic-type processes with polymerized actin as a major component. The functional parameters of B cell activation, however, such as proliferation or Ig production, were not examined in the report. This spreading on immobilized anti-CD44, due to multivalent cross-linking and increased affinity,¹⁰¹ could perhaps be similar to the integrin-mediated form of cell adhesion.¹⁰¹ Inasmuch as anti-CD44 mAbs, as an “artificial ligand”, can initiate clustering of CD44 molecules on the cell surface,^{193,194} - and this is a higher

affinity pairing than CD44-HA – the signal given to the B cell via CD44 cross-linking (by mAb) may be significantly stronger.

Soluble anti-CD44 antibodies have been shown to influence cell activation in various cell types, including increasing binding to hyaluronic acid,^{195,196} triggering hemopoiesis via cytokine release from bone marrow macrophages,¹⁹⁷ activating T cells,⁹⁵ and inducing cytokine/chemokine release from monocytes.¹⁹⁸ A report by Rafi, *et al*,⁹⁶ demonstrated that soluble anti-CD44 (KM201), as well as HA itself, triggered the proliferation and differentiation of murine B cells. The parameters measured included cell surface markers CD44 (upregulated) and CD45R (downregulated), and IgM production. The results reported by this group contrast with the present study in that they found soluble anti-CD44 Ab able to induce B cell activation. This can be explained by the fact that, in the Rafi, *et al*, study, a different antibody was used and the cells were cultured at six-fold higher density. Also of note in the previous study is the important fact that the effect of anti-CD44 Abs or HA was studied on naïve B cells that had not been previously activated, unlike the current study wherein the B cells were activated with a variety of agents at the time of CD44 ligation. Additionally, this report deals with B cells whose CD44 has been cross-linked by a specific immobilized antibody and which likely have upregulated CD44 splice forms (unidentified at present).

Ingvarsson, *et al*, showed that naïve human tonsillar B cells, in response to stimulation by soluble anti-CD44 (BU52) plus anti-CD40, would begin to display a phenotype similar to that of a germinal center cell (upregulated CD10, CD95, and CD38; also downregulation of CD24 and CD39).⁹⁷ These naïve B cells also were stimulated

with both anti-IgM + anti-CD40 plus or minus anti-CD44. The B cells that had the anti-CD44 proliferated to levels 4x that of the cells without anti-CD44. One parameter not tested in this experiment was the B cells' ability to produce Ig. However, a separate study by Hogerkorp, *et al*, shed some light on the genes that were being activated in naïve human tonsillar B cells when they were stimulated with a combination of anti-IgM, anti-CD40, and (soluble) anti-CD44 (BU52).¹¹⁰ The genes induced by anti-CD44 included IL-1 α , IL-6, and β_2 -adrenergic receptor (β_2 -AR), among many others; and the pattern of genes upregulated by anti-CD44 suggested that CD44 may play a role in immunomodulation and inflammation. In this report, soluble anti-CD44, up to 100 μ g/ml, in combination with IL-4 and CD40LT, had no effect either on the growth of murine B cells or on their ability to produce IgE. It is not known whether this is an RK3G9-specific effect or if this is due to an as yet uncharacterized difference between murine and human CD44 or between the way that CD44 functions on a mouse B cell vs the human.

While the B cell CD44 crosslinking resulted in less proliferation and Ig production, there was no increase in apoptosis. However, senescence is also a possibility and proposed experiments include activated cyclin identification.

A single gene expression experiment was performed for the RK3G9-treated cells. Freshly isolated B cells were grown at a concentration of 25,000 cells/well (96-well plate) on RK3G9 or C0H2 for 48 hours and RNA was extracted. The Virginia Commonwealth University's DNA Core Facility provided the service of microarray analysis (Affymetrix, Mouse 430A 2.0). A number of genes were upregulated or downregulated in these cells, but only the most important are recorded here. Upregulated

genes included actin binding proteins, Btg1 and Btg2 (B cell translocation genes, antiproliferative), Ltbr (lymphotoxin B receptor), cyclin G1 and G2, BAX (pro-apoptotic protein), Ikbke (Inhibitor of kappaB kinase epsilon), several members of the MAPK family, actin, Rel, several members of the TNFR family, cyclin-dependent kinase inhibitor 1a, SMAD7, Bcl-2 binding component 3, Abcg1 (ATP-binding and involved in ATPase activity coupled to transmembrane movement of substances), Itpr5 (inositol 1,4,5-triphosphate receptor 5, involved in ion channels), Alcam (activated leukocyte adhesion molecule), CD80, several members of the Ras family, and Pias3 (protein inhibitor of activated STAT3). Downregulated genes included Cyclin B1, Napa (N-ethylmaleimide sensitive fusion protein attachment protein alpha, involved in intracellular transporter activity in endoplasmic reticulum (ER) and Golgi), Sec61 (protein translocase activity, ER), various transcription factors (no known pathways), CD22, AID (activation-induced cytidine deaminase, involved in mRNA processing), members of the MAPK family, members of the TNF family, caspase 3 (pro-apoptotic), immunoglobulin lambda and kappa chains (variable 1), CD48, karyopherin (importin) beta 1 (protein-nucleus transport), syntaxin 6 (intracellular transport), Bid (BH3 interacting death domain agonist, regulation of apoptosis), CD36 (involved in transport and cell adhesion), various adaptor and docking proteins (again, no known pathways), various proteins involved in intracellular transport, and CD23. At a glance, these up- or down-regulated genes simply confirm what was already known – that proliferation is inhibited and that Ig levels are decreased. This data does suggest that 1) there is an actual decrease in Ig gene transcription and this may lead to less Ig production at the protein level, and 2) the

decrease in mRNA expression of proteins involved in intracellular transport, especially in the ER and/or Golgi apparatus to the membrane, may be part of the backdrop for the decreased Ig secretion (Fig. 14) and the decreased numbers of surface Ig-bearing cells as shown by Elispot (Fig. 28) seen on RK3G9-treated cells. Further gene chip experiments are necessary to determine the reproducibility of the RK3G9 gene chip study and ultimately elucidate the most important genes involved in the RK3G9-mediated inhibition of B cell activation.

The inhibitory activities of the anti-CD44 Ab RK3G9 are most prominent at lower cell concentrations, relative to the number of cells which are activated by the specific stimulus used. The relationship between the B cell concentration and the functional inhibition may be explained by the amount of CD44 “ligand” (RK3G9) that is bound to the plate, relative to the amount of CD44 present on the cell surface. Obviously the latter relates both to cell concentrations and to the CD44 upregulation achieved by activation of the cells. Larger cell numbers would thus be anticipated to reduce the inhibitory activities of the anti-CD44, which is the effect we observed. In addition, activation for a period of time prior to culturing on immobilized anti-CD44 would cause an upregulation⁷⁸ of CD44 on the B cell surface; hence, the limited amount of immobilized anti-CD44 has little to no functional effect on these cells once they have increased in number as well as in their surface CD44 expression. Here is an example: in the first stages of this project, the B cells were purified by Percoll gradient, and the yield was 80-90% B220⁺ B cells as measured by FACS. When these cells were grown on immobilized anti-CD44, the higher cell concentrations (25,000 per well up to 100,000 per well) would invariably overcome

the RK3G9-mediated inhibition and produce levels of IgE that were similar to the levels produced by cells grown on control antibody. However, the control cells produced IgE best at lower (less than 25,000 cells per well) concentrations of cells. It was hypothesized that at higher cell concentrations that there was less anti-CD44 available for the greater number of cells and the RK3G9-treated cells began to act like the control cells (at the control cell low cell number). Interestingly, later in the project, the B cells were isolated to 96-98% purity by FACS and this increase in IgE production by the RK3G9-treated cells (at the higher cell numbers) disappeared. For the remainder of the project the cells were isolated by FACS since their behavior on immobilized RK3G9 was more reliable – they always reacted the same way at the same cell concentrations, and there was no sudden increase in IgE production when the cell numbers were too high. The reason why B cells at a lower purity should not respond in the same manner as B cells of higher purity is still a mystery. During Percoll-isolation of splenic B cells, the T cells are lysed using a combination of antibodies specific for T cell markers and guinea pig complement. The Percoll gradient itself does, in theory, separate out the B cells from the other cells (follicular dendritic cells, monocytes, eosinophils, etc) based on their density and rate of migration during centrifugation. The only cells that could potentially contaminate the Percoll-isolated B cells are the monocytes, FDCs, and NK cells. FACS for CD3-bearing T cells showed only 1-3% T cells in the Percoll-isolated B cell populations (which were, on average, 85% pure). Perhaps it is possible that another CD44-bearing cell type (any leukocyte) was influencing the RK3G9-mediated inhibition.

The IgE results in Fig. 16B showed some inhibition of IgE production by the MAR18-RK3G9-treated cultures, but again the degree of inhibition was less than that of cells grown on RK3G9 alone. This may be due to the “on-off rate” between plate-bound MAR18 and the RK3G9; potentially, less anti-CD44 was presented to the B cells as is usually found on an RK3G9-coated plate. The results suggested that this was true – that there was less CD44 crosslinking and thus the IgE inhibition was ameliorated.

Interestingly, although RK3G9 had a profound effect on the B cells, it did not have any effect on T cell proliferation. It has been shown repeatedly in the literature that anti-CD44 can induce T cell proliferation and secretion of IL-2^{36,37,91-93,199} and stimulation of cytotoxic effector functions in CTL and neutrophils.^{90,92,200} Hyaluronan binding to T cell CD44 is stimulatory,^{201,202} and the HA-binding function of T cells is activated during an *in vivo* immune response.²⁰³ Although this report shows no inhibition of T cell proliferation, the data also shows that there is no increase in proliferation, although an increase might have been expected. Because B cells responded identically to RK3G9 and the commercially available IM7, it is assumed that RK3G9 is similar to other anti-CD44 antibodies and that cells that respond to anti-CD44 stimulation would respond positively to RK3G9. However, the only parameter measured in this report's T cell experiments was proliferation. There may have been an effect on T cell IL-2 production or some other parameter of T cell activation status, but none of them were tested.

Although, in other reports, B cells responded to soluble anti-CD44,^{96,97,110} the B cells in this report did not; there was no increase in proliferation or IgE, nor was there the decrease seen with immobilized RK3G9. Figures 17 and 18 illustrate the attempts made

in this report to cross-link the anti-CD44 and make a “scaffold” in solution. This was purported to mimic the plate-bound RK3G9. The results showed that the B cells could respond to the “scaffolded” anti-CD44 to a certain extent (up to 60% inhibition), but the >90% inhibition seen with immobilized RK3G9 was not evident.

Another explanation for the RK3G9 effect on B cells – a very simple one, in fact – could be that the inhibitory Fc gamma receptor (FcγRIIb) was binding to the Fc portion of the RK3G9 immobilized on the plate. The FcγRIIb, only found on B cells, has a cytoplasmic immunoreceptor tyrosine-based inhibitory motif^{204,205} (ITIM) and has been shown to inhibit the proliferation²⁰⁶⁻²⁰⁸ and Ca⁺ mobilization of B cells.²⁰⁹⁻²¹¹ This occurs when FcγRIIb binds ligand, clusters, and is phosphorylated by Lyn, a Src-family kinase.²¹²⁻²¹⁴ This provides a docking site for an SH2-domain-containing phosphatase such as the inositol phosphatase SHIP (SH2-containing inositol polyphosphate 5-phosphatase).^{210,215} Recruitment of SHIP leads to abrogation of BCR activation signaling via hydrolysis of PIP₃, leading to a blockage of the Ca⁺ signal.²⁰⁹⁻²¹¹ FcγRIIb activation can also arrest BCR-triggered proliferation by inhibiting the activation of MAP kinases and by inhibiting the recruitment of the anti-apoptotic protein kinase Akt.^{216,217} The data in Figure 20 shows that activation of the FcγRIIb is not the reason that proliferation and Ig production are so dramatically decreased. In this experiment, the cells were incubated with 10 μg/ml 2.4G2 (anti-FcγRIIb) for 40 minutes on ice prior to culture on immobilized RK3G9, and these cells were not released from the inhibition imposed by CD44-RK3G9 ligation. Although it was unlikely that an anti-rat antibody should affect mouse B cells, the possibility existed and had to be invalidated.

The experiments involving the CD44^{-/-} mice were interesting in that they confirmed that RK3G9 does bind to CD44 and not a similar protein on the B cell surface. Also of interest is the data showing the Balb/cJ vs the C57BL/6 mice. RK3G9 interacted with the B cells from the C57 mice in an identical manner to those from Balb/c mice, suggesting additionally that RK3G9 is not interacting with a particular mutation in Balb/c CD44. Unpublished data in this lab suggests that other molecules (ie, CD23) can have strain-specific mutations which allow recognition only by antibodies which recognize certain epitopes.

The possibility that there was a “missing factor” was intriguing. The B cells were spread out on the plate and not allowed to “clump” and interact with the other cells, so the most viable hypothesis was that there was a contact-dependent secreted factor – or perhaps a physical signal was given between cells when they clump (binding protein & ligand). The latter idea was supported by the data showing that higher cell numbers tended to ameliorate the RK3G9-mediated inhibition, at least when the cells were at a lower purity. The former idea was more easily tested and Fig. 22 shows that when normal B cell supernatants (at 25% of the total media volume) were added to RK3G9-treated cultures, there was no relief from the anti-CD44-mediated inhibition by addition of the C0H2 supernatants. Another media supplement which is used to “feed” cells is Cloning Factor (Fig. 21) – this was added to the media and also had no effect on the RK3G9-mediated inhibition. The data from these experiments suggests that there is no “missing factor” but further experimentation is needed. Another possibility is that there could be a needed receptor for this “missing factor” which is itself not present. Another route for

this “missing factor”, in the case of Percoll-purified B cells, could be that it comes in the form of help from another cell type, such as NK cells or monocytes. This is a likely possibility, since Percoll-purified cells are typically 80-90% B220⁺ and 1-3% CD3⁺ (T cells). The remainder would be NK, monocytes, dendritic cells, and other leukocytes. Since CD44 is expressed on all leukocytes, the immobilized anti-CD44 could “activate” some of these non-B cells, which could then provide “help” to the B cells by way of cytokines or other factors.

The data from the *in vivo* experiment suggested that the *in vitro* RK3G9 effects are not physiologically relevant. However, the only parameter measured in this experiment was IgE; this immunoglobulin was chosen because in the *in vitro* work, it was the most affected by immobilized RK3G9. Other reports of *in vivo* (murine) anti-CD44 use are usually treating specific experimentally-induced diseases involving conditions such as vascular disease,²¹⁸ arthritis,^{103,219} experimental autoimmune encephalomyelitis,²²⁰ and autoimmune diabetes.²²¹ The mice in the experiment in this report were healthy and were simply being “vaccinated” in order to achieve upregulation of immunoglobulin production. It was hoped that anti-CD44 treatment would decrease the antibody response since the *in vitro* work suggested that the major parameter to be affected was antibody (particularly IgE) production. In fact, this experiment proved very little either way. If it did have an effect on IgE production, it likely would have been on antigen-specific IgE, but total IgE was the parameter measured. Also, antigen-specific IgM and IgG levels could also be telling. Another very important point to note is that immune responses are typically localized and, physiologically, CD44-ligand interactions

would be expected to be involved only in a very tiny area and number of cells. Hence, it would be quite difficult to pinpoint any effect from the systemic injection of anti-CD44 antibodies.

The data in Table 2 suggests that RK3G9 ligation will elicit a response from the B cells only if they have not been stimulated for very long. In other words, after the B cell has been activated, signaling events occur and the cellular machinery begins to set the B cells on the path indicated by the type of activation stimulus. At a certain point on this path, the B cells are “committed”, and anti-CD44, which normally inhibits (or slows) this pathway, cannot influence the B cells at this point. The data indicates that the B cells are committed by day four, as the ratio of IgE produced by the RK3G9-treated cells vs C0H2-treated cells remains at 1:3 until day four. It should also be noted that germinal-center phenotypic markers have been shown to appear on or about day 4 and that the surface CD44 expression drops on these activated cells.⁹³

It is interesting that different types of stimuli, which of course activate different signaling pathways, can modulate the effects of CD44 ligation by mAb (ie, RK3G9). As shown in Fig. 14E, stimulation of the B cell cultures with LPS and IFN γ (minus IL-4) modulated the anti-CD44 inhibition slightly, as IgE production was decreased but not as dramatically as with CD40/IL-4 stimulation (Fig. 14B). This suggested that IL-4 was not involved in the downregulation, but stimulation by CD40LT (no IL-4) only had decreased IgE production by about 30-50%, which seemed to indicate that IL-4 could be involved. However, the “best” way to signal a B cell to make IgE is to use IL-4, especially in combination with CD40L (the “two signal” requirement), so it is possible

that in its absence the control cultures also did not produce as much IgE as might have been expected, leading to a false impression that IL-4 is involved in the RK3G9 inhibition of IgE.

RK3G9 was still able to inhibit B cell proliferation and production of IgE with other stimuli such as LPS + IL-4. However, anti- μ stimulation resulted in complete inhibition of the RK3G9 effect; that is, RK3G9 could not inhibit B cell proliferation when they were being stimulated by anti-IgM. Interestingly, as Hathcock,²²² *et al*, reported, it is not simply the amount of CD44 expressed by a B cell that determines how well it will bind to its ligand, but the type of stimulation can influence the CD44-HA binding ability. This could be due to the CD44 isoforms induced by the type of activation stimuli or the glycosylation of the CD44. Mouse B cells were tested for the expression of CD44 variant isoforms using reverse-transcriptase polymerase chain reaction (RT-PCR), but the results were unclear. It may also be that the anti- μ and anti-CD44 pathways do not cross, or that the anti- μ signaling extinguishes the signaling initiated by RK3G9.

Three major signaling pathways are activated in the three types of stimulation mentioned above. In the CD40-CD40L or the LPS-TLR interaction, the primary commonality is the involvement of NF κ B transcription factor.^{112,223} BCR signaling involves ITAM-mediated activation of Ras, IP₃, and DAG, with less involvement of NF κ B.^{116,117} Also, CD44 is known to be associated with some signaling molecules, such as the src-related kinases lck and fyn.^{47,48} It is interesting that the B cells respond differently to RK3G9 when they are activated by different types of stimulation. The experiment in which combination of the activation signals resulted in the “rescue” of the

LPS-activated cells suggests that the BCR signal can modulate the inhibitory capacity of anti-CD44. Given this result, one could hypothesize that high level CD44 cross-linking would restrict polyclonal B cell activation, but allow antigen-specific activation. Further experiments will be required to determine if natural ligands of CD44 will result in the same activities and if a similar regulation occurs *in vivo*.

If there was less IgE being produced under the influence of RK3G9, then the logical hypotheses would be that: 1) isotype switching was not occurring or was being slowed; 2) the “pathway” to plasma cell formation had been slowed and the cell died before it could achieve plasma cell status (murine B cells only live 7-8 days in culture and must undergo a certain minimum number of cell divisions before switching and maturing to a plasma cell); 3) there was a “stop” signal given to the machinery during the production of the IgE and it was not being secreted; or 4) there were fewer cells becoming plasma cells. The data in Fig. 14 suggests that isotype switching is not being inhibited, as all immunoglobulins are inhibited by RK3G9 treatment to a nearly equal extent. FACS analysis for CD138⁺ cells – which are plasma cells – showed that the presence of immobilized RK3G9 in B cell cultures decreased the number of plasma cells by 75%. In addition, Elispot analysis for IgE and IgG₁ confirmed that there were fewer plasma cells in the RK3G9-treated cell cultures.

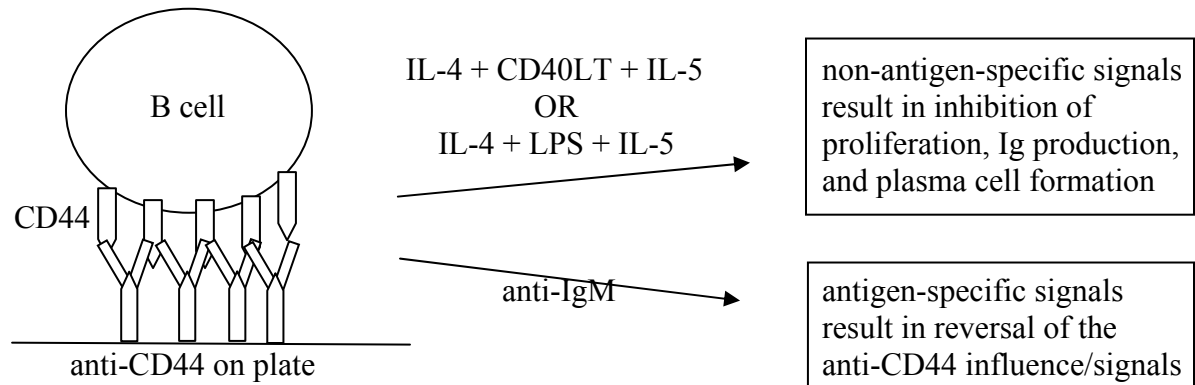
Overall, this set of experiments shows a profound effect of CD44 ligation on B cell division, activation, and end-state plasma cell formation. Local inflammation, wherein CD44 ligand would be upregulated on epithelial cells, does occur *in vivo*. This new data involving CD44 ligation and the effects of different stimuli on the activation

state of the cells suggests that ligation of CD44 inhibits non-antigen-specific reactions and may enhance antigen-specific B cell responses. If this is true, then CD44-ligand interactions may play a role in the activation of the localized B cell *in vivo* to promote antigen-specific activation. In addition, activated B cells in the germinal center, expressing upregulated CD44, could bind HA (or other ligand) on other leukocytes (also expressing high levels of CD44 and potentially “presenting” a CD44 ligand). CD44 interactions between leukocytes can lead to activation of the cells involved and these interactions may play a role in determining antigen-specific activation. Figure 32 diagrams an outline of this idea. This data is highly relevant to the study of B cell biology and activation. Knowledge of each piece of the puzzle, particularly with regard to the immune response to a “danger signal”, is an essential addition to our understanding of the intricacies of B cell activation.

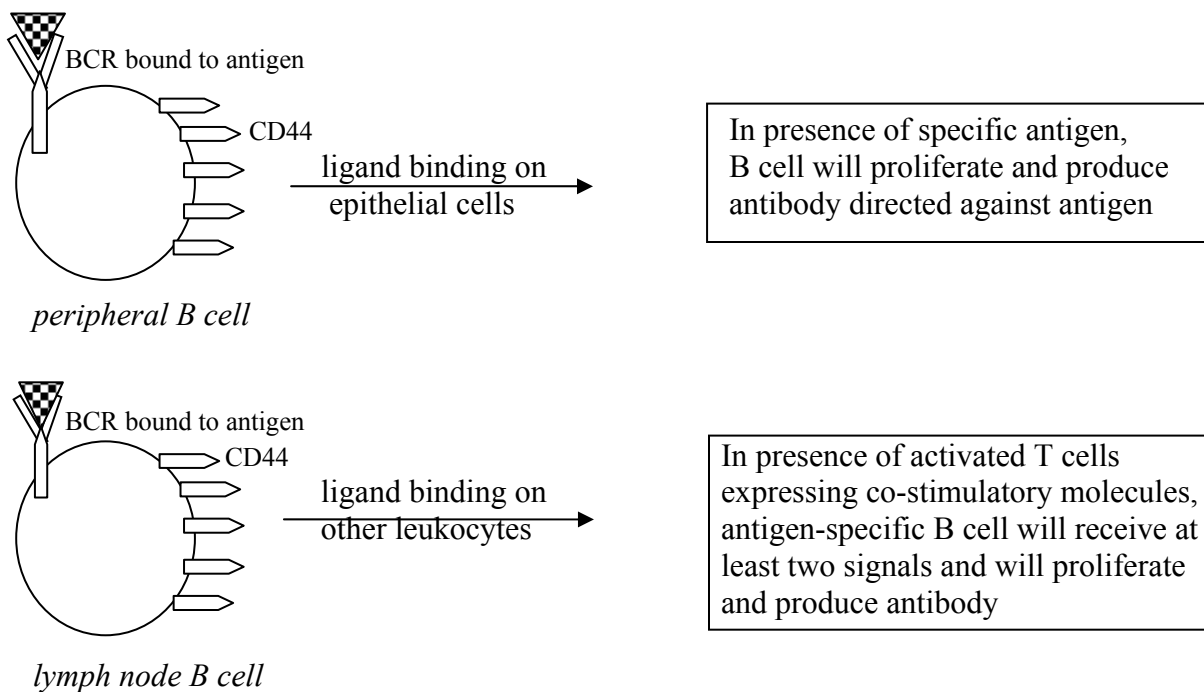
The mechanism for this decrease in plasma cell numbers is not known. It could be intimately related to the slowing of proliferation and the probable subsequent decrease in cell division. It could also be a decrease in plasma cell formation due to a specific signal or simply a slowing of the process or impairment of immunoglobulin secretion. Further experiments are needed to elucidate the mechanism(s) at work here. Levels of the transcription factors XBP-1 and BLIMP1 would reveal whether the majority of the RK3G9-treated B cell cultures were plasma-cell-committed, even if the immunoglobulin secretion was inhibited. If so, then the rates of plasma cell formation could be elucidated by a time course of RNA analysis for the levels of germinal-center-type transcription factors such as PAX5 and BCL-6 vs the plasma-cell-type transcription factors BLIMP1

Figure 32. Model for RK3G9 (anti-CD44)-mediated B cell antigen-specific activation. The top panel depicts the *in vitro* model, in which immobilized anti-CD44 acts in concert with anti-IgM to promote antigen-specific activation of the B cell, but inhibits non-antigen-specific activation. The bottom panel shows two possible scenarios *in vivo*: in the peripheral B cell, CD44-ligand interaction (ligand on activated epithelial cells during inflammation) could promote antigen-specific activation while inhibiting non-antigen-specific activation; similarly, in the B cell in the lymph node, CD44-ligand interactions could regulate leukocyte interactions and activation and limit activation to only those B cells that are antigen-specific.

CD44 crosslinking via anti-CD44 antibody immobilized on plate:



Potential mechanism for CD44 regulation of B cell activation at work *in vivo*:



The work detailed in this report answered a few questions but has brought up many more. Another thing that would be interesting to investigate further is the CD44 shedding/signaling aspect. Shi, *et al*, reports that anti-CD44 antibodies can induce CD44 shedding.²²⁴ Additionally, Okamoto, *et al*, and Murakami, *et al*, report the identification of a new mechanism for direct signaling by CD44: a 2-step process wherein the CD44 ectodomain is cleaved by MT1-MMP,^{73,74} followed by cleavage of the transmembrane (TM) domain by presenilin-dependent γ -secretase. This releases the CD44 intracellular domain (ICD), which then translocates to the nucleus and act as a transcription factor^{54,70,71} to potentiate activation of target genes (including CD44 itself⁵⁴) in conjunction with the p300/CREB-binding protein (CBP). The levels of surface CD44 on the RK3G9-treated B cells were not determined in this report due to the difficulty of getting the lower cell numbers off the bottom of the well in a 96-well plate – which would also be the most important to find out as this is where the greatest inhibition was seen. The levels of soluble CD44 – an indication of shedding – should have been determined but were not. It would be most interesting to see if CD44 ICD is at work in these cells and it can be hypothesized that it may affect a step in the pathway to becoming a fully functional plasma cell. There is an antibody available (in the Hideyuki Saya laboratory) called anti-CD44cyto which is directed against the CD44-ICD, so the hypothesis could be tested. A great deal of work needs to be done before this hypothesis could be substantiated, but it does propose a most intriguing mechanism for RK3G9-mediated effects on mouse B cells.

II. CD23b studies.

Expression of murine CD23b protein has long been difficult to pinpoint. Suter *et al.*,²²⁵ examined the human CD23b and found that IL-4 stimulation of transiently transfected B cell lines yielded a 2-4-fold increase in CD23b expression in chloramphenicol acetyl transferase (CAT) assays. The comparable region in mouse was analyzed here, both with and without a CD23a-like TATA box added; using luciferase reporter assays, a similar induction was observed, as shown in Fig. 29. Both CD23b and CD23b-TATA were equally stimulated. The increase in promoter activity was shown to be additive depending on the stimulation: IL-4 alone caused a ~1.5-fold increase, CD40LT alone caused a ~4-fold increase, and IL-4+CD40LT showed a ~5-fold increase. However, the reporter activity of the CD23a promoter was significantly greater (~9-fold). Ewart, *et al.*, showed that the murine CD23a promoter is sensitive to only IL-4 and that the STAT6 site most distal to the transcription initiation site was crucial for reporter activity.¹⁷² The second STAT6 site, proximal to the transcription initiation site, which is adjacent to an NFκB site, could not support IL-4-driven reporter gene expression when the STAT6 site distal to the transcription initiation site was removed. The NFκB site was unresponsive to stimulation by anti-CD40 and the data suggests that this region of the CD23a promoter is silent with regard to cell surface receptor-initiated signals. CD23b was far more responsive to signals initiated by extracellular stimuli. Both STAT6 sites were physiologically competent and both had to be deleted before there was a loss of IL-4-mediated reporter activity. In fact, one STAT6 site is sufficient for maximal activity. The NFκB site was necessary for CD40-driven reporter expression. Anti-μ stimulation

caused variable reporter expression, and activity was lost only after both of the putative AP1 sites were deleted. This data suggests that AP1 family proteins may play a role in the regulation of CD23b expression.¹⁶⁸.

In this study, it was shown that human CD23b (pLUC-CD23BP) could be expressed in a mouse B cell line and that its activity, as measured by luciferase production, was similar to that of mCD23b and mCD23b-TATA activity. As will be discussed in greater detail below, the human and murine systems may regulate their CD23a and CD23b proteins very differently.

With regard to the experiments involving the “CD23 isoform-specific antibody”, it was possible that the rabbits’ serum would contain an antibody that would be specific and high affinity for both CD23a and CD23b. Peptides consisting of the CD23a or CD23b intracellular tail sequence were used to immunize rabbits but these have a difference of only the N-terminal 6 amino acids. Western blots were performed on both the CD23b-expressing IEC4.1 cells and the CD23a or CD23b full-length-transfected 293 cells, with no positive results. Intracellular FACS was also performed with these same cells as outlined above. The “CD23 isoform-specific antibody” reacted with its cognate peptide, but had no activity with the intact protein, suggesting that the CD23 folding “hid” the epitope to which it was directed. The failure of the anti-CD23 peptide reagent to recognize CD23b means that detection of CD23 isoforms remains limited to RNA methodologies.

The IEC4.1 cell line was created from Balbc/J mouse intestinal epithelial cells, and these cells express CD23b. As discussed in the Introduction in detail, Yu, *et al*,

showed that CD23b expression could be found in sensitized (food allergic) mouse intestinal cells, as well as these cells. CD23b lacking (Δ) exon 5 or 6 was also found, but only classical CD23b or CD23b Δ 5 were shown to have the ability to bind IgE/allergen complexes and were internalized in a sensitized animal.¹⁵³ In later reports, Montagnac, *et al*, showed that classical CD23b is most efficient in mediating the transepithelial transport of IgE/allergen complexes, whereas CD23b Δ 5 was shown to bind free IgE as well as IgE/allergen complexes and may play a role in luminal IgE recycling.¹⁸⁵ Additionally, regulation of the intracellular trafficking of CD23a and CD23b was shown to be quite different. While CD23a exhibits constitutive clathrin-dependent internalization, CD23b is stable on the cell membrane. The internalization of all murine CD23 splice forms was due to a positive signal located in the cytoplasmic region of the protein; however, this positive signal was negated by the presence of the CD23b-specific exon. In addition to this, CD23b splice forms with a lack of exon 5, 6, 5 and 6, or 5, 6, and 7, were constitutively internalized, which suggested that this region can negatively regulate internalization. The human CD23a internalization signal was found to be present in the CD23a-specific exon and human intestinal epithelial cell lines express both CD23a and CD23b.¹⁶⁰

In the present study, IEC4.1 cells were grown at the concentration and level of stimulation as suggested by Yu, *et al*, and RNA was isolated for RT-PCR. M12.4.5 (Murine B cell line) RNA was used as a positive control for CD23a and FDC RNA was used as a positive control for CD23b. However, while only rarely did the IEC4.1 cells have a band indicating the presence of CD23b, they almost always had a band indicating

CD23a. The PCR was done repeatedly with the utmost care but the CD23a presence was unvarying, suggesting that either the IEC4.1 cells do indeed express CD23a, or there was repeated contamination of either the cell line or the RNA derived from it.

There are more interesting aspects of CD23 – especially CD23b – yet to be discovered. In particular, the question of the regulation of CD23a vs CD23b promoters in human vs mouse – how are the two regulated and what makes them different? Then the expression of the CD23a vs CD23b protein - is it entirely due to the inherent structure of the protein itself or is it also partially due to the regulation of the promoters and the cell type, as well as the species? Why are the CD23a and CD23b different between species – does the answer lie in the promoter or in the protein itself or in the cell type(s) that expresses the protein? The answers to these questions are potentially very important with respect to the further elucidation of the role that CD23 isoforms and splice forms play in allergic disease.

Reference List

1. Flanagan, B. F., R. Dalchau, A. K. Allen, A. S. Daar, and J. W. Fabre. 1989. Chemical composition and tissue distribution of the human CDw44 glycoprotein. *Immunology* 67:167.
2. Haynes, B. F., M. J. Telen, L. P. Hale, and S. M. Denning. 1989. CD44--a molecule involved in leukocyte adherence and T-cell activation. *Immunol. Today* 10:423.
3. Naor, D., and S. Nedvetzki. 2003. CD44 in rheumatoid arthritis. *Arthritis Res. Ther.* 5:105.
4. Knudson, W., and Knudson C.B. 1999. The Hyaluronan Receptor, CD44. <http://www.glycoforum.gr.jp/index.html>, Glycoforum, pp. 1.
5. Yang, B., B. L. Yang, R. C. Savani, and E. A. Turley. 1994. Identification of a common hyaluronan binding motif in the hyaluronan binding proteins RHAMM, CD44 and link protein. *EMBO J* 13:286.
6. Embry, J. J., and W. Knudson. 2003. G1 domain of aggrecan cointernalizes with hyaluronan via a CD44-mediated mechanism in bovine articular chondrocytes. *Arthritis Rheum.* 48:3431.
7. Jiang, H., R. S. Peterson, W. Wang, E. Bartnik, C. B. Knudson, and W. Knudson. 2002. A requirement for the CD44 cytoplasmic domain for hyaluronan binding, pericellular matrix assembly, and receptor-mediated endocytosis in COS-7 cells. *J Biol. Chem.* 277:10531.

8. Peterson, R. S., R. A. Andhare, K. T. Rousche, W. Knudson, W. Wang, J. B. Grossfield, R. O. Thomas, R. E. Hollingsworth, and C. B. Knudson. 2004. CD44 modulates Smad1 activation in the BMP-7 signaling pathway. *J Cell Biol.* 166:1081.
9. Nedvetzki, S., I. Golan, N. Assayag, E. Gonen, D. Caspi, M. Gladnikoff, A. Yayon, and D. Naor. 2003. A mutation in a CD44 variant of inflammatory cells enhances the mitogenic interaction of FGF with its receptor. *J Clin. Invest.* 111:1211.
10. Yu, Q., and B. P. Toole. 1996. A new alternatively spliced exon between v9 and v10 provides a molecular basis for synthesis of soluble CD44. *J Biol. Chem.* 271:20603.
11. Goodison, S., V. Urquidi, and D. Tarin. 1999. CD44 cell adhesion molecules. *Mol. Pathol.* 52:189.
12. Bennett, K. L., B. Modrell, B. Greenfield, A. Bartolazzi, I. Stamenkovic, R. Peach, D. G. Jackson, F. Spring, and A. Aruffo. 1995. Regulation of CD44 binding to hyaluronan by glycosylation of variably spliced exons. *J Cell Biol.* 131:1623.
13. Jackson, D. G., J. I. Bell, R. Dickinson, J. Timans, J. Shields, and N. Whittle. 1995. Proteoglycan forms of the lymphocyte homing receptor CD44 are alternatively spliced variants containing the v3 exon. *J Cell Biol.* 128:673.
14. Sleeman, J. P., U. Rahmsdorf, A. Steffen, H. Ponta, and P. Herrlich. 1998. CD44 variant exon v5 encodes a tyrosine that is sulphated. *Eur. J. Biochem.* 255:74.

15. He, Q., J. Lesley, R. Hyman, K. Ishihara, and P. W. Kincade. 1992. Molecular isoforms of murine CD44 and evidence that the membrane proximal domain is not critical for hyaluronate recognition. *J. Cell Biol.* 119:1711.
16. Isacke, C. M., and H. Yarwood. 2002. The hyaluronan receptor, CD44. *Int. J. Biochem. Cell Biol.* 34:718.
17. Sneath, R. J., and D. C. Mangham. 1998. The normal structure and function of CD44 and its role in neoplasia. *Mol. Pathol.* 51:191.
18. Lazaar A.L., and Pure E. 1995. CD44: a model for regulated adhesion function., p. 19.
19. Lesley, J., R. Hyman, and P. W. Kincade. 1993. CD44 and its interaction with extracellular matrix. *Adv. Immunol.* 54:271-335.:271.
20. Camp, R. L., T. A. Kraus, M. L. Birkeland, and E. Pure. 1991. High levels of CD44 expression distinguish virgin from antigen-primed B cells. *J. Exp. Med.* 173:763.
21. Clark, R. A., R. Alon, and T. A. Springer. 1996. CD44 and hyaluronan-dependent rolling interactions of lymphocytes on tonsillar stroma. *J. Cell Biol.* 134:1075.
22. Carter, W. G. 1982. The cooperative role of the transformation-sensitive glycoproteins, GP140 and fibronectin, in cell attachment and spreading. *J. Biol. Chem.* 257:3249.
23. Carter, W. G., and E. A. Wayner. 1988. Characterization of the class III collagen receptor, a phosphorylated, transmembrane glycoprotein expressed in nucleated human cells. *J. Biol. Chem.* 263:4193.

24. Naor, D., R. V. Sionov, and D. Ish-Shalom. 1997. CD44: structure, function, and association with the malignant process. *Adv. Cancer Res.* 71:241-319.:241.
25. Naor, D., S. Nedvetzki, I. Golan, L. Melnik, and Y. Faitelson. 2002. CD44 in cancer. *Crit Rev. Clin. Lab Sci.* 39:527.
26. Peach, R. J., D. Hollenbaugh, I. Stamenkovic, and A. Aruffo. 1993. Identification of hyaluronic acid binding sites in the extracellular domain of CD44. *J Cell Biol.* 122:257.
27. Kincade, P. W., Z. Zheng, S. Katoh, and L. Hanson. 1997. The importance of cellular environment to function of the CD44 matrix receptor. *Curr. Opin. Cell Biol.* 9:635.
28. Katoh, S., Z. Zheng, K. Oritani, T. Shimosato, and P. W. Kincade. 1995. Glycosylation of CD44 negatively regulates its recognition of hyaluronan. *J. Exp. Med.* 182:419.
29. Lesley, J., and R. Hyman. 1992. CD44 can be activated to function as an hyaluronic acid receptor in normal murine T cells. *Eur. J Immunol* 22:2719.
30. Fujita, Y., M. Kitagawa, S. Nakamura, K. Azuma, G. Ishii, M. Higashi, H. Kishi, T. Hiwasa, K. Koda, N. Nakajima, and K. Harigaya. 2002. CD44 signaling through focal adhesion kinase and its anti-apoptotic effect. *FEBS Lett.* 528:101.
31. Lesley, J., and R. Hyman. 1998. CD44 structure and function. *Front Biosci.* 3:d616-30.:d616-d630.
32. Koyama, T., M. Yashiro, T. Inoue, S. Nishimura, and C. K. Hirakawa-YS. 2000. TGF-beta1 secreted by gastric fibroblasts up-regulates CD44H expression and

- stimulates the peritoneal metastatic ability of scirrhous gastric cancer cells. *Int. J. Oncol.* 16:355.
33. Zhang, M., M. H. Wang, R. K. Singh, A. Wells, and G. P. Siegal. 1997. Epidermal growth factor induces CD44 gene expression through a novel regulatory element in mouse fibroblasts. *J. Biol. Chem.* 272:14139.
34. Foster, L. C., B. M. Arkonac, N. E. Sibinga, C. Shi, M. A. Perrella, and E. Haber. 1998. Regulation of CD44 gene expression by the proinflammatory cytokine interleukin-1beta in vascular smooth muscle cells. *J. Biol. Chem.* 273:20341.
35. Lesley, J., N. English, A. Perschl, J. Gregoroff, and R. Hyman. 1995. Variant cell lines selected for alterations in the function of the hyaluronan receptor CD44 show differences in glycosylation. *J. Exp. Med.* 182:431.
36. Huet, S., H. Groux, B. Caillou, H. Valentin, A. M. Prieur, and A. Bernard. 1989. CD44 contributes to T cell activation. *J. Immunol.* 143:798.
37. Shimizu, Y., G. A. Van Seventer, R. Siraganian, L. Wahl, and S. Shaw. 1989. Dual role of the CD44 molecule in T cell adhesion and activation. *J. Immunol.* 143:2457.
38. Bradl, H., W. Schuh, and H. M. Jack. 2004. CD44 is dispensable for B lymphopoiesis. *Immunol Lett.* 95:71.
39. Protin, U., T. Schweighoffer, W. Jochum, and F. Hilberg. 1999. CD44-deficient mice develop normally with changes in subpopulations and recirculation of lymphocyte subsets. *J. Immunol.* 163:4917.

40. Stoop, R., I. Gal, T. T. Glant, J. D. McNeish, and K. Mikecz. 2002. Trafficking of CD44-deficient murine lymphocytes under normal and inflammatory conditions. *Eur. J. Immunol.* 32:2532.
41. Bourguignon, L. Y., H. Zhu, A. Chu, N. Iida, L. Zhang, and M. C. Hung. 1997. Interaction between the adhesion receptor, CD44, and the oncogene product, p185HER2, promotes human ovarian tumor cell activation. *J Biol. Chem.* 272:27913.
42. Bourguignon, L. Y., P. A. Singleton, H. Zhu, and B. Zhou. 2002. Hyaluronan promotes signaling interaction between CD44 and the transforming growth factor beta receptor I in metastatic breast tumor cells. *J Biol. Chem.* 277:39703.
43. Ito, T., J. D. Williams, D. Fraser, and A. O. Phillips. 2004. Hyaluronan attenuates transforming growth factor-beta1-mediated signaling in renal proximal tubular epithelial cells. *Am. J Pathol.* 164:1979.
44. Ito, T., J. D. Williams, D. J. Fraser, and A. O. Phillips. 2004. Hyaluronan regulates transforming growth factor-beta1 receptor compartmentalization. *J Biol. Chem.* 279:25326.
45. Orian-Rousseau, V., L. Chen, J. P. Sleeman, P. Herrlich, and H. Ponta. 2002. CD44 is required for two consecutive steps in HGF/c-Met signaling. *Genes Dev.* 16:3074.
46. Yu, W. H., J. F. Woessner, Jr., J. D. McNeish, and I. Stamenkovic. 2002. CD44 anchors the assembly of matrilysin/MMP-7 with heparin-binding epidermal

- growth factor precursor and ErbB4 and regulates female reproductive organ remodeling. *Genes Dev.* 16:307.
47. Taher, T. E., L. Smit, A. W. Griffioen, E. J. Schilder-Tol, J. Borst, and S. T. Pals. 1996. Signaling through CD44 is mediated by tyrosine kinases. Association with p56lck in T lymphocytes. *J. Biol. Chem.* 271:2863.
48. Ilangumaran, S., A. Briol, and D. C. Hoessli. 1998. CD44 selectively associates with active Src family protein tyrosine kinases Lck and Fyn in glycosphingolipid-rich plasma membrane domains of human peripheral blood lymphocytes. *Blood* 91:3901.
49. Bourguignon, L. Y., H. Zhu, L. Shao, and Y. W. Chen. 2001. CD44 interaction with c-Src kinase promotes cortactin-mediated cytoskeleton function and hyaluronic acid-dependent ovarian tumor cell migration. *J Biol. Chem.* 276:7327.
50. Sohara, Y., N. Ishiguro, K. Machida, H. Kurata, A. A. Thant, T. Senga, S. Matsuda, K. Kimata, H. Iwata, and M. Hamaguchi. 2001. Hyaluronan activates cell motility of v-Src-transformed cells via Ras-mitogen-activated protein kinase and phosphoinositide 3-kinase-Akt in a tumor-specific manner. *Mol. Biol. Cell* 12:1859.
51. Li, R., N. Wong, M. D. Jabali, and P. Johnson. 2001. CD44-initiated cell spreading induces Pyk2 phosphorylation, is mediated by Src family kinases, and is negatively regulated by CD45. *J. Biol. Chem.* 276:28767.

52. Nishida, N., Knudson C.B., and W. Knudson. 2003. Extracellular matrix recovery by human articular chondrocytes after treatment with hyaluronan hexasaccharides or Streptomyces hyaluronidase., pp. 62.
53. Ohno-Nakahara, M., K. Honda, K. Tanimoto, N. Tanaka, T. Doi, A. Suzuki, K. Yoneno, Y. Nakatani, M. Ueki, S. Ohno, W. Knudson, C. B. Knudson, and K. Tanne. 2004. Induction of CD44 and MMP expression by hyaluronidase treatment of articular chondrocytes. *J Biochem. (Tokyo)*. 135:567.
54. Okamoto, I., Y. Kawano, D. Murakami, T. Sasayama, N. Araki, T. Miki, A. J. Wong, and H. Saya. 2001. Proteolytic release of CD44 intracellular domain and its role in the CD44 signaling pathway. *J Cell Biol.* 155:755.
55. Sugahara, K. N., T. Murai, H. Nishinakamura, H. Kawashima, H. Saya, and M. Miyasaka. 2003. Hyaluronan oligosaccharides induce CD44 cleavage and promote cell migration in CD44-expressing tumor cells. *J. Biol. Chem.* 278:32259.
56. Peterson, R. M., Q. Yu, I. Stamenkovic, and B. P. Toole. 2000. Perturbation of hyaluronan interactions by soluble CD44 inhibits growth of murine mammary carcinoma cells in ascites. *Am. J Pathol.* 156:2159.
57. Ghatak, S., S. Misra, and B. P. Toole. 2002. Hyaluronan oligosaccharides inhibit anchorage-independent growth of tumor cells by suppressing the phosphoinositide 3-kinase/Akt cell survival pathway. *J Biol. Chem.* 277:38013.

58. Knudson, W., B. Casey, Y. Nishida, W. Eger, K. E. Kuettner, and C. B. Knudson. 2000. Hyaluronan oligosaccharides perturb cartilage matrix homeostasis and induce chondrocytic chondrolysis. *Arthritis Rheum.* 43:1165.
59. Noble, P. W., C. M. McKee, M. Cowman, and H. S. Shin. 1996. Hyaluronan fragments activate an NF-kappa B/I-kappa B alpha autoregulatory loop in murine macrophages. *J. Exp. Med.* 183:2373.
60. Knudson, C. B., and W. Knudson. 2004. Hyaluronan and CD44: modulators of chondrocyte metabolism. *Clin. Orthop. Relat Res.* S152-S162.
61. Oh, C. D., and J. S. Chun. 2003. Signaling mechanisms leading to the regulation of differentiation and apoptosis of articular chondrocytes by insulin-like growth factor-1. *J Biol. Chem.* 278:36563.
62. Ward, J. A., L. Huang, H. Guo, S. Ghatak, and B. P. Toole. 2003. Perturbation of hyaluronan interactions inhibits malignant properties of glioma cells. *Am. J Pathol.* 162:1403.
63. Knudson, W., and C. B. Knudson. 2005. The Hyaluronan Receptor, CD44 - An UPDATE.
<http://www.glycoforum.gr.jp/science/hyaluronan/HA10a/HA10aE.html>
64. Turley, E. A., P. W. Noble, and L. Y. Bourguignon. 2002. Signaling properties of hyaluronan receptors. *J. Biol. Chem.* 277:4589.
65. Oliferenko, S., I. Kaverina, J. V. Small, and L. A. Huber. 2000. Hyaluronic acid (HA) binding to CD44 activates Rac1 and induces lamellipodia outgrowth. *J. Cell Biol.* 20:148:1159.

66. Bourguignon, L. Y., H. Zhu, L. Shao, and Y. W. Chen. 2000. Ankyrin-Tiam1 interaction promotes Rac1 signaling and metastatic breast tumor cell invasion and migration. *J Cell Biol.* 150:177.
67. Bretscher, A. 1999. Regulation of cortical structure by the ezrin-radixin-moesin protein family. *Curr. Opin. Cell Biol.* 11:109.
68. Barret, C., C. Roy, P. Montcourrier, P. Mangeat, and V. Niggli. 2000. Mutagenesis of the phosphatidylinositol 4,5-bisphosphate (PIP(2)) binding site in the NH(2)-terminal domain of ezrin correlates with its altered cellular distribution. *J Cell Biol.* 151:1067.
69. Bourguignon, L. Y., D. Zhu, and H. Zhu. 1998. CD44 isoform-cytoskeleton interaction in oncogenic signaling and tumor progression. *Front Biosci.* 3:d637-49.:d637-d649.
70. Lammich, S., M. Okochi, M. Takeda, C. Kaether, A. Capell, A. K. Zimmer, D. Edbauer, J. Walter, H. Steiner, and C. Haass. 2002. Presenilin-dependent intramembrane proteolysis of CD44 leads to the liberation of its intracellular domain and the secretion of an Abeta-like peptide. *J Biol. Chem.* 277:44754.
71. Murakami, D., I. Okamoto, O. Nagano, Y. Kawano, T. Tomita, T. Iwatsubo, S. B. De, E. Yumoto, and H. Saya. 2003. Presenilin-dependent gamma-secretase activity mediates the intramembraneous cleavage of CD44. *Oncogene.* 22:1511.
72. De, S. B., W. Annaert, P. Cupers, P. Saftig, K. Craessaerts, J. S. Mumm, E. H. Schroeter, V. Schrijvers, M. S. Wolfe, W. J. Ray, A. Goate, and R. Kopan.

1999. A presenilin-1-dependent gamma-secretase-like protease mediates release of Notch intracellular domain. *Nature*. 398:518.
73. Okamoto, I., Y. Kawano, H. Tsuiki, J. Sasaki, M. Nakao, M. Matsumoto, M. Suga, M. Ando, M. Nakajima, and H. Saya. 1999. CD44 cleavage induced by a membrane-associated metalloprotease plays a critical role in tumor cell migration. *Oncogene*. 18:1435.
74. Kajita, M., Y. Itoh, T. Chiba, H. Mori, A. Okada, H. Kinoh, and M. Seiki. 2001. Membrane-type 1 matrix metalloproteinase cleaves CD44 and promotes cell migration. *J Cell Biol*. 153:893.
75. Murai, T., Y. Miyazaki, H. Nishinakamura, K. N. Sugahara, T. Miyauchi, Y. Sako, T. Yanagida, and M. Miyasaka. 2004. Engagement of CD44 promotes Rac activation and CD44 cleavage during tumor cell migration. *J. Biol. Chem*. 279:4541.
76. Guo, Y. J., J. H. Wong, S. C. Lin, A. Aruffo, I. Stamenkovic, and M. S. Sy. 1994. Disruption of T lymphocyte reappearance in anti-Thy-1-treated animals in vivo with soluble CD44 and L-selectin molecules. *Cell Immunol*. 154:202.
77. Picker, L. J., T. J. De los, M. J. Telen, B. F. Haynes, and E. C. Butcher. 1989. Monoclonal antibodies against the CD44 [In(Lu)-related p80], and Pgp-1 antigens in man recognize the Hermes class of lymphocyte homing receptors. *J. Immunol*. 142:2046.

78. Arch, R., K. Wirth, M. Hofmann, H. Ponta, S. Matzku, P. Herrlich, and M. Zoller. 1992. Participation in normal immune responses of a metastasis-inducing splice variant of CD44. *Science* 257:682.
79. Miyake, K., K. L. Medina, S. Hayashi, S. Ono, T. Hamaoka, and P. W. Kincade. 1990. Monoclonal antibodies to Pgp-1/CD44 block lympho-hemopoiesis in long-term bone marrow cultures. *J. Exp. Med.* 171:477.
80. Underhill, C. 1992. CD44: the hyaluronan receptor. *J Cell Sci.* 103:293.
81. Drillenburg, P., and S. T. Pals. 2000. Cell adhesion receptors in lymphoma dissemination. *Blood.* 95:1900.
82. Zoller, M. 1995. CD44: physiological expression of distinct isoforms as evidence for organ-specific metastasis formation. *J Mol. Med.* 73:425.
83. DeGrendele, H. C., P. Estess, and M. H. Siegelman. 1997. Requirement for CD44 in activated T cell extravasation into an inflammatory site. *Science* 278:672.
84. Wallach-Dayana, S. B., V. Grabovsky, J. Moll, J. Sleeman, P. Herrlich, R. Alon, and D. Naor. 2001. CD44-dependent lymphoma cell dissemination: a cell surface CD44 variant, rather than standard CD44, supports in vitro lymphoma cell rolling on hyaluronic acid substrate and its in vivo accumulation in the peripheral lymph nodes. *J Cell Sci.* 114:3463.
85. Murai, T., N. Sougawa, H. Kawashima, K. Yamaguchi, and M. Miyasaka. 2004. CD44-chondroitin sulfate interactions mediate leukocyte rolling under physiological flow conditions. *Immunol. Lett.* 93:163.

86. Siegelman, M. H., D. Stanescu, and P. Estess. 2000. The CD44-initiated pathway of T-cell extravasation uses VLA-4 but not LFA-1 for firm adhesion. *J. Clin. Invest* 105:683.
87. Pessac, B., and V. Defendi. 1972. Cell aggregation: role of acid mucopolysaccharides. *Science*. 175:898.
88. Nandi, A., P. Estess, and M. H. Siegelman. 2000. Hyaluronan anchoring and regulation on the surface of vascular endothelial cells is mediated through the functionally active form of CD44. *J Biol. Chem.* %19;275:14939.
89. Lesley, J., I. Gal, D. J. Mahoney, M. R. Cordell, M. S. Rugg, R. Hyman, A. J. Day, and K. Mikecz. 2004. TSG-6 modulates the interaction between hyaluronan and cell surface CD44. *J. Biol. Chem.* 279:25745.
90. Seth, A., L. Gote, M. Nagarkatti, and P. S. Nagarkatti. 1991. T-cell-receptor-independent activation of cytolytic activity of cytotoxic T lymphocytes mediated through CD44 and gp90MEL-14. *Proc. Natl. Acad. Sci. U. S. A* 88:7877.
91. Denning, S. M., P. T. Le, K. H. Singer, and B. F. Haynes. 1990. Antibodies against the CD44 p80, lymphocyte homing receptor molecule augment human peripheral blood T cell activation. *J. Immunol.* 144:7.
92. Galandrini, R., N. Albi, G. Tripodi, D. Zarcone, A. Terenzi, A. Moretta, C. E. Grossi, and A. Velardi. 1993. Antibodies to CD44 trigger effector functions of human T cell clones. *J. Immunol.* 150:4225.

93. Pierres, A., C. Lipcey, C. Mawas, and D. Olive. 1992. A unique CD44 monoclonal antibody identifies a new T cell activation pathway. *Eur. J. Immunol.* 22:413.
94. Tan, P. H., E. B. Santos, H. C. Rossbach, and B. M. Sandmaier. 1993. Enhancement of natural killer activity by an antibody to CD44. *J. Immunol.* 150:812.
95. Webb, D. S., Y. Shimizu, G. A. Van Seventer, S. Shaw, and T. L. Gerrard. 1990. LFA-3, CD44, and CD45: physiologic triggers of human monocyte TNF and IL-1 release. *Science* 249:1295.
96. Rafi, A., M. Nagarkatti, and P. S. Nagarkatti. 1997. Hyaluronate-CD44 interactions can induce murine B-cell activation. *Blood* 89:2901.
97. Ingvarsson, S., K. Dahlenborg, R. Carlsson, and C. A. Borrebaeck. 1999. Co-ligation of CD44 on naive human tonsillar B cells induces progression towards a germinal center phenotype. *Int. Immunol.* 11:739.
98. Butcher, E. C., and L. J. Picker. 1996. Lymphocyte homing and homeostasis. *Science* 272:60.
99. Aarvak, T., and J. B. Natvig. 2001. Cell-cell interactions in synovitis: antigen presenting cells and T cell interaction in rheumatoid arthritis. *Arthritis Res.* 3:13.
100. Haynes, B. F., L. P. Hale, K. L. Patton, M. E. Martin, and R. M. McCallum. 1991. Measurement of an adhesion molecule as an indicator of inflammatory disease

- activity. Up-regulation of the receptor for hyaluronate (CD44) in rheumatoid arthritis. *Arthritis Rheum.* 34:1434.
101. Kim, J. H., T. T. Glant, J. Lesley, R. Hyman, and K. Mikecz. 2000. Adhesion of lymphoid cells to CD44-specific substrata: the consequences of attachment depend on the ligand. *Exp. Cell Res.* 256:445.
102. Lindhout, E., M. van Eijk, M. van Pel, J. Lindeman, H. J. Dinant, and C. de Groot. 1999. Fibroblast-like synoviocytes from rheumatoid arthritis patients have intrinsic properties of follicular dendritic cells. *J. Immunol.* 162:5949.
103. Mikecz, K., K. Dennis, M. Shi, and J. H. Kim. 1999. Modulation of hyaluronan receptor (CD44) function in vivo in a murine model of rheumatoid arthritis. *Arthritis Rheum.* 42:659.
104. Schadt, E. E., C. Li, C. Su, and W. H. Wong. 2000. Analyzing high-density oligonucleotide gene expression array data. *J. Cell Biochem.* 80:192.
105. Murakami, S., K. Miyake, C. H. June, P. W. Kincade, and R. J. Hodes. 1990. IL-5 induces a Pgp-1 (CD44) bright B cell subpopulation that is highly enriched in proliferative and Ig secretory activity and binds to hyaluronate. *J. Immunol.* 145:3618.
106. Guo, Y., Y. Wu, S. Shinde, M. S. Sy, A. Aruffo, and Y. Liu. 1996. Identification of a costimulatory molecule rapidly induced by CD40L as CD44H. *J. Exp. Med.* 184:955.

107. Dahlenborg, K., J. D. Pound, J. Gordon, C. A. Borrebaeck, and R. Carlsson. 1997. Terminal differentiation of human germinal center B cells in vitro. *Cell Immunol.* 175:141.
108. Feuillard, J., D. Taylor, M. Casamayor-Palleja, G. D. Johnson, and I. C. MacLennan. 1995. Isolation and characteristics of tonsil centroblasts with reference to Ig class switching. *Int. Immunol.* 7:121.
109. Kremmidiotis, G., and H. Zola. 1995. Changes in CD44 expression during B cell differentiation in the human tonsil. *Cell Immunol.* 161:147.
110. Hogerkorp, C. M., S. Bilke, T. Breslin, S. Ingvarsson, and C. A. Borrebaeck. 2003. CD44-stimulated human B cells express transcripts specifically involved in immunomodulation and inflammation as analyzed by DNA microarrays. *Blood* 101:2307.
111. Geha, R. S., H. H. Jabara, and S. R. Brodeur. 2003. The regulation of immunoglobulin E class-switch recombination. *Nat. Rev. Immunol* 3:721.
112. Harnett, M. M. 2004. CD40: a growing cytoplasmic tale. *Sci. STKE.* 2004:e25.
113. Ferrari, S., and A. Plebani. 2002. Cross-talk between CD40 and CD40L: lessons from primary immune deficiencies. *Curr. Opin. Allergy Clin. Immunol* 2:489.
114. Lougaris, V., R. Badolato, S. Ferrari, and A. Plebani. 2005. Hyper immunoglobulin M syndrome due to CD40 deficiency: clinical, molecular, and immunological features. *Immunol Rev.* 203:48-66.:48.

115. Hasbold, J., A. B. Lyons, M. R. Kehry, and P. D. Hodgkin. 1998. Cell division number regulates IgG1 and IgE switching of B cells following stimulation by CD40 ligand and IL-4. *Eur. J. Immunol.* 28:1040.
116. Dal Porto, J. M., S. B. Gauld, K. T. Merrell, D. Mills, A. E. Pugh-Bernard, and J. Cambier. 2004. B cell antigen receptor signaling 101. *Mol. Immunol.* 41:599.
117. Gauld, S. B., J. M. Dal Porto, and J. C. Cambier. 2002. B cell antigen receptor signaling: roles in cell development and disease. *Science* 296:1641.
118. Oettgen, H. C. 2000. Regulation of the IgE isotype switch: new insights on cytokine signals and the functions of epsilon germline transcripts. *Curr. Opin. Immunol* 12:618.
119. Fitzgerald, K. A., D. C. Rowe, and D. T. Golenbock. 2004. Endotoxin recognition and signal transduction by the TLR4/MD2-complex. *Microbes. Infect.* 6:1361.
120. Peng, S. L. 2005. Signaling in B cells via Toll-like receptors. *Curr. Opin. Immunol* 17:230.
121. Yamamoto, M., K. Takeda, and S. Akira. 2004. TIR domain-containing adaptors define the specificity of TLR signaling. *Mol. Immunol* 40:861.
122. Takeda, K. 2005. Evolution and integration of innate immune recognition systems: the Toll-like receptors. *J Endotoxin. Res.* 11:51.
123. Moore, K. J., L. P. Andersson, R. R. Ingalls, B. G. Monks, R. Li, M. A. Arnaout, D. T. Golenbock, and M. W. Freeman. 2000. Divergent response to LPS and bacteria in CD14-deficient murine macrophages. *J Immunol* 165:4272.

124. Haziot, A., E. Ferrero, F. Kontgen, N. Hijiya, S. Yamamoto, J. Silver, C. L. Stewart, and S. M. Goyert. 1996. Resistance to endotoxin shock and reduced dissemination of gram-negative bacteria in CD14-deficient mice. *Immunity*. 4:407.
125. Nelms, K., A. D. Keegan, J. Zamorano, J. J. Ryan, and W. E. Paul. 1999. The IL-4 receptor: signaling mechanisms and biologic functions. *Annu. Rev. Immunol* 17:701-38.:701.
126. Worm, M., and B. M. Henz. 1997. Molecular regulation of human IgE synthesis. *J Mol. Med.* 75:440.
127. Shapiro-Shelef, M., and K. Calame. 2005. Regulation of plasma-cell development. *Nat. Rev. Immunol* 5:230.
128. Shaffer, A. L., M. Shapiro-Shelef, N. N. Iwakoshi, A. H. Lee, S. B. Qian, H. Zhao, X. Yu, L. Yang, B. K. Tan, A. Rosenwald, E. M. Hurt, E. Petroulakis, N. Sonenberg, J. W. Yewdell, K. Calame, L. H. Glimcher, and L. M. Staudt. 2004. XBP1, downstream of Blimp-1, expands the secretory apparatus and other organelles, and increases protein synthesis in plasma cell differentiation. *Immunity*. 21:81.
129. Lawrence, D. A., W. O. Weigle, and H. L. Spiegelberg. 1975. Immunoglobulins cytophilic for human lymphocytes, monocytes, and neutrophils. *J Clin Invest* 55:368.
130. Kikutani, H., S. Inui, R. Sato, E. L. Barsumian, H. Owaki, K. Yamasaki, T. Kaisho, N. Uchibayashi, R. R. Hardy, T. Hirano, S. Tsumasawa, F. Sakiyama,

- M. Suemura, and T. Kishimoto. 1986. Molecular Structure of Human Lymphocyte Receptor for immunoglobulin E. *C* 47:657.
131. Richards, M. L., and D. H. Katz. 1990. The binding of IgE to murine Fc ϵ RII is calcium-dependent but not inhibited by carbohydrate. *J* 144:2638.
132. Bevilacqua, M., E. Butcher, B. Furie, M. Gallatin, M. Gimbrone, J. Harlan, K. Kishimoto, L. Lasky, R. McEver, J. Paulson, S. Rosen, B. Seed, M. Siegelman, T. Springer, L. Stoolman, T. Tedder, A. Varki, D. Wagner, I. Weissman, and G. Zimmerman. 1991. Selectins: A family of adhesion receptors. *C* 67:233.
133. Vercelli, D., B. Helm, P. Marsh, E. Padlan, R. S. Geha, and H. Gould. 1989. The B-cell binding site on human immunoglobulin E. *Nature* 338:649.
134. Drickamer, K. 1991. Clearing up glycoprotein hormones. *C* 67:1029.
135. Keegan, A. D., and D. H. Conrad. 1987. The Murine Lymphocyte Receptor for IgE V. Biosynthesis, Transport, and Maturation of the B Cell Fc ϵ Receptor. *J. Immunol.* 139:1199.
136. Gould, H., B. Sutton, R. Edmeades, and A. Bevil. 1991. CD23/Fc ϵ RII: C-type lectin membrane protein with a split personality. L. A. Hanson and F. Shakib, eds. Karger, Basel, pp. 28.
137. Bevil, A. J., R. L. Edmeades, H. J. Gould, and B. J. Sutton. 1992. α -Helical coiled-coil stalks in the low-affinity receptor for IgE (Fc ϵ RII/CD23) and related C-type lectins. *Proc. Natl. Acad. Sci. USA* 89:753.
138. Conrad, D. H. 1990. Fc ϵ RII/CD23: The low affinity receptor for IgE. *Ann. Rev. Immunol.* 8:623.

139. Conrad, D. H. 1994. FcεRI, εBP, and FcεRII -- Structure and involvement in allergic diseases.
140. Lee, B. W., C. F. Simmons, T. Wileman, and R. S. Geha. 1989. Intracellular cleavage of newly synthesized low affinity Fcε receptor (FcεRII) provides a second pathway for the generation of the 28-kDa soluble FcεRII fragment. *J. Immunol.* 142:1614.
141. Letellier, M., M. Sarfati, and G. Delespesse. 1989. Mechanisms of formation of IgE-binding factors (soluble CD23)--I. FcεR II bearing B cells generate IgE-binding factors of different molecular weights. *Mol. Immunol.* 26:1105.
142. Bettler, B., R. Maier, D. Ruegg, and H. Hofstetter. 1989. Binding site for IgE of the human lymphocyte low-affinity Fc epsilon receptor (Fc epsilon RII/CD23) is confined to the domain homologous with animal lectins. *Proc. Natl. Acad. Sci. U. S. A* 86:7118.
143. Bettler, B., G. Texido, S. Raggini, D. Rüegg, and H. Hofstetter. 1992. Immunoglobulin E-binding site in Fcε receptor (FcεRII/CD23) identified by homolog-scanning mutagenesis. *J. Biol. Chem.* 267:185.
144. Lee, W. T., M. Rao, and D. H. Conrad. 1987. The murine lymphocyte receptor for IgE. IV. The mechanism of ligand- specific receptor upregulation on B cells. *J Immunol* 139:1191.
145. Kuhn, R., K. Rajewsky, and W. Muller. 1991. Generation and analysis of interleukin-4 deficient mice. *Science* 254:707.

146. Shimoda, K., J. van Deursen, M. Y. Sangster, S. R. Sarawar, R. T. Carson, R. A. Tripp, C. Chu, F. W. Quelle, T. Nosaka, D. A. A. Vignali, P. C. Doherty, G. Grosveld, W. E. Paul, and J. N. Ihle. 1996. Lack of IL-4-induced Th2 response and IgE class switching in mice with disrupted *Stat6* gene. *Nature* 380:630.
147. Takeda, K., T. Tanaka, W. Shi, M. Matsumoto, M. Minami, S. Kashiwamura, K. Nakanishi, N. Yoshida, T. Kishimoto, and S. Akira. 1996. Essential role of Stat6 in IL-4 signalling. *Nature* 380:627.
148. Hudak, S. A., S. O. Gollnick, D. H. Conrad, and M. R. Kehry. 1987. Murine B-cell stimulatory factor 1 (interleukin 4) increases expression of the Fc receptor for IgE on mouse B cells. *Proc Natl Acad Sci U S A* 84:4606.
149. Yokota, A., H. Kikutani, T. Tanaka, R. Sato, E. L. Barsumian, M. Suemura, and T. Kishimoto. 1988. Two species of human Fcε receptor II (FcεRII/CD23): Tissue-specific and IL-4-specific regulation of gene expression. *C* 55:611.
150. Fournier, S., I. D. Tran, U. Suter, G. Biron, G. Delespesse, and M. Sarfati. 1991. The in vivo expression of type B CD23 mRNA in B-chronic lymphocytic leukemic cells is associated with an abnormally low CD23 upregulation by IL-4: comparison with their normal cellular counterparts. *Leuk. Res.* 15:609.
151. Vercelli, D., H. H. Jabara, B. W. Lee, N. Woodland, and R. S. Geha. 1988. Human recombinant interleukin-4 induces FcεR2/CD23 on normal human monocytes. *J. Exp. Med.* 167:1406.

152. Conrad, D. H., C. A. Kozak, J. Vernachio, C. M. Squire, M. Rao, and E. M. Eicher. 1993. Chromosomal location and isoform analysis of mouse FcεRII/CD23. *Mol. Immunol.* 30:27.
153. Yu, L. C., G. Montagnac, P. C. Yang, D. H. Conrad, A. Benmerah, and M. H. Perdue. 2003. Intestinal epithelial CD23 mediates enhanced antigen transport in allergy: evidence for novel splice forms. *Am. J Physiol Gastrointest. Liver Physiol.* 285:G223-G234.
154. Fujiwara, H., H. Kikutani, S. Suematsu, T. Naka, K. Yoshida, T. Tanaka, M. Suemura, N. Matsumoto, S. Kojima, T. Kishimoto, and N. Yoshida. 1994. The absence of IgE antibody-mediated augmentation of immune responses in CD23-deficient mice. *Proc. Natl. Acad. Sci. USA* 91:6835.
155. Stief, A., G. Texido, G. Sansig, H. Eibel, G. Le Gros, and H. Van der Putten. 1994. Mice deficient in CD23 reveal its modulatory role in IgE production but no role in T and B cell development. *J. Immunol.* 152:3378.
156. Yu, P., M. Kosco-Vilbois, M. Richards, G. Köhler, M. C. Lamers, and G. Kohler. 1994. Negative feedback regulation of IgE synthesis by murine CD23. *Nature* 369:753.
157. Texido, G., H. Eibel, G. Le Gros, and H. Van der Putten. 1994. Transgene CD23 expression on lymphoid cells modulates IgE and IgG1 responses. *J. Immunol.* 153:3028.

158. MacGlashan, D. W., Jr., B. S. Bochner, D. C. Adelman, P. M. Jardieu, A. Togias, and L. M. Lichtenstein. 1997. Serum IgE level drives basophil and mast cell IgE receptor display. *Int. Arch. Allergy Immunol.* 113:45.
159. Keegan, A. D., C. Fratazzi, B. Shopes, B. Baird, and D. H. Conrad. 1991. Characterization of new rat anti-mouse IgE monoclonals and their use along with chimeric IgE to further define the site that interacts with Fc_εRII and Fc_εRI. *Mol. Immunol.* 28:1149.
160. Montagnac, G., A. Molla-Herman, J. Bouchet, L. C. Yu, D. H. Conrad, M. H. Perdue, and A. Benmerah. 2005. Intracellular trafficking of CD23: differential regulation in humans and mice by both extracellular and intracellular exons. *J Immunol.* 174:5562.
161. Sarfati, M., and G. Delespesse. 1988. Possible role of human lymphocyte receptor for IgE (CD23) or its soluble fragments in the in vitro synthesis of human IgE. *J. Immunol.* 141:2195.
162. Sherr, E., E. Macy, H. Kimata, M. Gilly, and A. Saxon. 1989. Binding the low affinity Fc_εR on B cells suppresses ongoing human IgE synthesis. *J. Immunol.* 142:481.
163. Saxon, A., M. Kurbe-Leamer, K. Behle, E. E. Max, and K. Zhang. 1991. Inhibition of human IgE production via Fc_εR-II stimulation results from a decrease in the mRNA for secreted but not membrane ϵ H chains. *J. Immunol.* 147:4000.

164. Pene, J., I. Chretein, F. Rousset, F. Briere, J.-Y. Bonnefoy, and J. DeVries. 1989. Modulation of IL-4-induced human IgE production in vitro by IFN- τ and IL-5: the role of soluble CD23 (sCD23). *J. Cell. Biochem.* 39:253.
165. Saxon, A., Z. Ke, L. Bahati, and R. H. Stevens. 1990. Soluble CD23 containing B cell supernatants induce IgE from peripheral blood B-lymphocytes and costimulate with interleukin- 4 in induction of IgE. *J. Allergy Clin. Immunol.* 86:333.
166. Payet, M. E., E. C. Woodward, and D. H. Conrad. 1999. Humoral response suppression observed with CD23 transgenics. *J. Immunol.* 163:217.
167. Cho, S. W., M. A. Kilmon, E. J. Studer, P. H. van der, and D. H. Conrad. 1997. B cell activation and Ig, especially IgE, production is inhibited by high CD23 levels in vivo and in vitro. *Cell Immunol.* 180:36.
168. Pirron, U., T. Schlunck, J. C. Prinz, and E. P. Rieber. 1990. IgE-dependent antigen focusing by human B lymphocytes is mediated by the low-affinity receptor for IgE. *Eur. J. Immunol.* 20:1547.
169. Squire, C. M., E. J. Studer, A. Lees, F. D. Finkelman, and D. H. Conrad. 1994. Antigen presentation is enhanced by targeting antigen to the Fc epsilon RII by antigen-anti-Fc epsilon RII conjugates. *J. Immunol.* 152:4388.
170. Kohler, I., and E. P. Rieber. 1993. Allergy-associated I epsilon and Ec epsilon receptor II (CD23b) genes activated via binding of an interleukin-4-induced transcription factor to a novel responsive element. *Eur. J. Immunol.* 23:3066.

171. Kondo, H., Y. Ichikawa, K. Nakamura, and S. Tsuchiya. 1994. Cloning of cDNAs for new subtypes of murine low-affinity Fc receptor for IgE (Fc epsilon RII/CD23). *Int. Arch. Allergy Immunol* 105:38.
172. Ewart, M. A., B. W. Ozanne, and W. Cushley. 2002. The CD23a and CD23b proximal promoters display different sensitivities to exogenous stimuli in B lymphocytes. *Genes Immun.* 3:158.
173. Lessof, M. H., D. G. Wraith, J. Merrett, and P. D. Buisseret. 1980. Food allergy and intolerance in 100 patients: local and systemic effects. *Q. J. Med.* 49:259.
174. Amlot, P. L., D. M. Kemeny, C. Zachary, P. Parkes, and M. H. Lessof. 1987. Oral allergy syndrome (OAS): symptoms of IgE-mediated hypersensitivity to foods. *Clin. Allergy* 17:33.
175. Crowe, S. E., P. Sestini, and M. H. Perdue. 1990. Allergic reactions of rat jejunal mucosa. Ion transport responses to luminal antigen and inflammatory mediators. *Gastroenterology* 99:74.
176. Kaiserlian, D., A. Lachaux, I. Grosjean, P. Graber, and J. Y. Bonnefoy. 1993. Intestinal epithelial cells express the CD23/Fc epsilon RII molecule: enhanced expression in enteropathies. *Immunology* 80:90.
177. Belleau, J. T., R. K. Gandhi, H. M. McPherson, and D. B. Lew. 2005. Research upregulation of CD23 (FcepsilonRII) expression in human airway smooth muscle cells (huASMC) in response to IL-4, GM-CSF, and IL-4/GM-CSF. *Clin. Mol. Allergy* 3:6.

178. Yu, L. C., and M. H. Perdue. 2001. Role of mast cells in intestinal mucosal function: studies in models of hypersensitivity and stress. *Immunol. Rev.* 179:61.
179. Keljo, D. J., and J. R. Hamilton. 1983. Quantitative determination of macromolecular transport rate across intestinal Peyer's patches. *Am. J. Physiol* 244:G637-G644.
180. Berin, M. C., A. J. Kiliaan, P. C. Yang, J. A. Groot, J. A. Taminiou, and M. H. Perdue. 1997. Rapid transepithelial antigen transport in rat jejunum: impact of sensitization and the hypersensitivity reaction. *Gastroenterology* 113:856.
181. Yang, P. C., M. C. Berin, L. C. Yu, D. H. Conrad, and M. H. Perdue. 2000. Enhanced intestinal transepithelial antigen transport in allergic rats is mediated by IgE and CD23 (FcepsilonRII). *J. Clin. Invest* 106:879.
182. Berin, M. C., A. J. Kiliaan, P. C. Yang, J. A. Groot, Y. Kitamura, and M. H. Perdue. 1998. The influence of mast cells on pathways of transepithelial antigen transport in rat intestine. *J. Immunol.* 161:2561.
183. Yu, L. C., P. C. Yang, M. C. Berin, L. Di, V, D. H. Conrad, D. M. McKay, A. R. Satoskar, and M. H. Perdue. 2001. Enhanced transepithelial antigen transport in intestine of allergic mice is mediated by IgE/CD23 and regulated by interleukin-4. *Gastroenterology* 121:370.
184. Yu, L. C., P. C. Yang, M. C. Berin, L. Di, V, D. H. Conrad, D. M. McKay, A. R. Satoskar, and M. H. Perdue. 2001. Enhanced transepithelial antigen transport in

- intestine of allergic mice is mediated by IgE/CD23 and regulated by interleukin-4. *Gastro.* 121:370.
185. Montagnac, G., L. C. Yu, C. Bevilacqua, M. Heyman, D. H. Conrad, M. H. Perdue, and A. Benmerah. 2005. Differential role for CD23 splice forms in apical to basolateral transcytosis of IgE/allergen complexes. *Traffic.* 6:230.
186. Conrad, D. H., A. D. Keegan, K. R. Kalli, D. R. Van, M. Rao, and A. D. Levine. 1988. Superinduction of low affinity IgE receptors on murine B lymphocytes by lipopolysaccharide and IL-4. *J Immunol.* 141:1091.
187. Rao, M., R. Knox, and D. H. Conrad. 1991. Characterization of Pgp-1 antigen on murine B lymphocytes using a new anti-Pgp-1 monoclonal antibody. *Hybridoma* 10:281.
188. Tangye, S. G., and P. D. Hodgkin. 2004. Divide and conquer: the importance of cell division in regulating B-cell responses. *Immunology* 112:509.
189. Rabah, D., and D. H. Conrad. 2002. Effect of cell density on in vitro mouse immunoglobulin E production. *Immunology* 106:503.
190. Kelleher, D., A. Murphy, C. Feighery, and E. B. Casey. 1995. Leukocyte function-associated antigen 1 (LFA-1) and CD44 are signalling molecules for cytoskeleton-dependent morphological changes in activated T cells. *J. Leukoc. Biol.* 58:539.
191. Santos-Argumedo, L., P. W. Kincade, S. Partida-Sanchez, and R. M. Parkhouse. 1997. CD44-stimulated dendrite formation ('spreading') in activated B cells. *Immunology* 90:147.

192. Sumoza-Toledo, A., and L. Santos-Argumedo. 2004. The spreading of B lymphocytes induced by CD44 cross-linking requires actin, tubulin, and vimentin rearrangements. *J. Leukoc. Biol.* 75:233.
193. Oliferenko, S., K. Paiha, T. Harder, V. Gerke, C. Schwarzler, H. Schwarz, H. Beug, U. Gunthert, and L. A. Huber. 1999. Analysis of CD44-containing lipid rafts: Recruitment of annexin II and stabilization by the actin cytoskeleton. *J. Cell Biol.* 146:843.
194. Sleeman, J., W. Rudy, M. Hofmann, J. Moll, P. Herrlich, and H. Ponta. 1996. Regulated clustering of variant CD44 proteins increases their hyaluronate binding capacity. *J. Cell Biol.* 135:1139.
195. Lesley, J., Q. He, K. Miyake, A. Hamann, R. Hyman, and P. W. Kincade. 1992. Requirements for hyaluronic acid binding by CD44: a role for the cytoplasmic domain and activation by antibody. *J. Exp. Med.* 175:257.
196. Zheng, Z., S. Katoh, Q. He, K. Oritani, K. Miyake, J. Lesley, R. Hyman, A. Hamik, R. M. Parkhouse, A. G. Farr, and . 1995. Monoclonal antibodies to CD44 and their influence on hyaluronan recognition. *J. Cell Biol.* 130:485.
197. Khaldoyanidi, S., J. Moll, S. Karakhanova, P. Herrlich, and H. Ponta. 1999. Hyaluronate-enhanced hematopoiesis: two different receptors trigger the release of interleukin-1beta and interleukin-6 from bone marrow macrophages. *Blood* 94:940.
198. McKee, C. M., M. B. Penno, M. Cowman, M. D. Burdick, R. M. Strieter, C. Bao, and P. W. Noble. 1996. Hyaluronan (HA) fragments induce chemokine gene

- expression in alveolar macrophages. The role of HA size and CD44. *J. Clin. Invest* 98:2403.
199. Conrad, P., B. L. Rothman, K. A. Kelley, and M. L. Blue. 1992. Mechanism of peripheral T cell activation by coengagement of CD44 and CD2. *J. Immunol.* 149:1833.
200. Pericle, F., G. Sconocchia, J. A. Titus, and D. M. Segal. 1996. CD44 is a cytotoxic triggering molecule on human polymorphonuclear cells. *J. Immunol.* 157:4657.
201. Bourguignon, L. Y., V. B. Lokeshwar, X. Chen, and W. G. Kerrick. 1993. Hyaluronic acid-induced lymphocyte signal transduction and HA receptor (GP85/CD44)-cytoskeleton interaction. *J. Immunol.* 151:6634.
202. Galandrini, R., E. Galluzzo, N. Albi, C. E. Grossi, and A. Velardi. 1994. Hyaluronate is costimulatory for human T cell effector functions and binds to CD44 on activated T cells. *J. Immunol.* 153:21.
203. Lesley, J., N. Howes, A. Perschl, and R. Hyman. 1994. Hyaluronan binding function of CD44 is transiently activated on T cells during an in vivo immune response. *J. Exp. Med.* 180:383.
204. Bolland, S., and J. V. Ravetch. 1999. Inhibitory pathways triggered by ITIM-containing receptors. *Adv. Immunol.* 72:149.
205. Vely, F., and E. Vivier. 1997. Conservation of structural features reveals the existence of a large family of inhibitory cell surface receptors and noninhibitory/activatory counterparts. *J. Immunol.* 159:2075.

206. Tamir, I., J. C. Stolpa, C. D. Helgason, K. Nakamura, P. Bruhns, M. Daeron, and J. C. Cambier. 2000. The RasGAP-binding protein p62dok is a mediator of inhibitory Fc γ RIIB signals in B cells. *Immunity*. 12:347.
207. Yamanashi, Y., T. Tamura, T. Kanamori, H. Yamane, H. Nariuchi, T. Yamamoto, and D. Baltimore. 2000. Role of the rasGAP-associated docking protein p62(dok) in negative regulation of B cell receptor-mediated signaling. *Genes Dev*. 14:11.
208. Ono, M., S. Bolland, P. Tempst, and J. V. Ravetch. 1996. Role of the inositol phosphatase SHIP in negative regulation of the immune system by the receptor Fc γ RIIB. *Nature* 383:263.
209. Bolland, S., R. N. Pearse, T. Kurosaki, and J. V. Ravetch. 1998. SHIP modulates immune receptor responses by regulating membrane association of Btk. *Immunity*. 8:509.
210. Rohrschneider, L. R., J. F. Fuller, I. Wolf, Y. Liu, and D. M. Lucas. 2000. Structure, function, and biology of SHIP proteins. *Genes Dev*. 14:505.
211. Scharenberg, A. M., O. El-Hillal, D. A. Fruman, L. O. Beitz, Z. Li, S. Lin, I. Gout, L. C. Cantley, D. J. Rawlings, and J. P. Kinet. 1998. Phosphatidylinositol-3,4,5-trisphosphate (PtdIns-3,4,5-P₃)/Tec kinase-dependent calcium signaling pathway: a target for SHIP-mediated inhibitory signals. *EMBO J*. 17:1961.

212. Maeda, A., A. M. Scharenberg, S. Tsukada, J. B. Bolen, J. P. Kinet, and T. Kurosaki. 1999. Paired immunoglobulin-like receptor B (PIR-B) inhibits BCR-induced activation of Syk and Btk by SHP-1. *Oncogene* 18:2291.
213. Malbec, O., D. C. Fong, M. Turner, V. L. Tybulewicz, J. C. Cambier, W. H. Fridman, and M. Daeron. 1998. Fc epsilon receptor I-associated lyn-dependent phosphorylation of Fc gamma receptor IIB during negative regulation of mast cell activation. *J. Immunol.* 160:1647.
214. Smith, K. G., D. M. Tarlinton, G. M. Doody, M. L. Hibbs, and D. T. Fearon. 1998. Inhibition of the B cell by CD22: a requirement for Lyn. *J. Exp. Med.* 187:807.
215. Tamir, I., J. M. Dal Porto, and J. C. Cambier. 2000. Cytoplasmic protein tyrosine phosphatases SHP-1 and SHP-2: regulators of B cell signal transduction. *Curr. Opin. Immunol.* 12:307.
216. Aman, M. J., T. D. Lamkin, H. Okada, T. Kurosaki, and K. S. Ravichandran. 1998. The inositol phosphatase SHIP inhibits Akt/PKB activation in B cells. *J. Biol. Chem.* 273:33922.
217. Liu, Q., T. Sasaki, I. Kozieradzki, A. Wakeham, A. Itie, D. J. Dumont, and J. M. Penninger. 1999. SHIP is a negative regulator of growth factor receptor-mediated PKB/Akt activation and myeloid cell survival. *Genes Dev.* 13:786.
218. Mustafa, A., R. J. McKallip, M. Fisher, R. Duncan, P. S. Nagarkatti, and M. Nagarkatti. 2002. Regulation of interleukin-2-induced vascular leak syndrome

- by targeting CD44 using hyaluronic acid and anti-CD44 antibodies. *J. Immunother.* 25:476.
219. Mikecz, K., F. R. Brennan, J. H. Kim, and T. T. Glant. 1995. Anti-CD44 treatment abrogates tissue oedema and leukocyte infiltration in murine arthritis. *Nat. Med.* 1:558.
220. Brocke, S., C. Piercy, L. Steinman, I. L. Weissman, and T. Veromaa. 1999. Antibodies to CD44 and integrin alpha4, but not L-selectin, prevent central nervous system inflammation and experimental encephalomyelitis by blocking secondary leukocyte recruitment. *Proc. Natl. Acad. Sci. U. S. A* 96:6896.
221. Weiss, L., S. Slavin, S. Reich, P. Cohen, S. Shuster, R. Stern, E. Kaganovsky, E. Okon, A. M. Rubinstein, and D. Naor. 2000. Induction of resistance to diabetes in non-obese diabetic mice by targeting CD44 with a specific monoclonal antibody. *Proc. Natl. Acad. Sci. U. S. A* 97:285.
222. Hathcock, K. S., H. Hirano, S. Murakami, and R. J. Hodes. 1993. CD44 expression on activated B cells. Differential capacity for CD44-dependent binding to hyaluronic acid. *J. Immunol.* 151:6712.
223. Akira, S., and K. Takeda. 2004. Toll-like receptor signalling. *Nat. Rev. Immunol.* 4:499.
224. Shi, M., K. Dennis, J. J. Peschon, R. Chandrasekaran, and K. Mikecz. 2001. Antibody-induced shedding of CD44 from adherent cells is linked to the assembly of the cytoskeleton. *J. Immunol.* 167:123.

225. Suter, U., G. Texido, and H. Hofstetter. 1989. Expression of Human Lymphocyte IgE Receptor (FcεRII/CD23) Identification of FcεRIIa Promoter and its Functional Analysis in B lymphocytes. *J. Immunol.* 143:3087.

Curriculum Vitae

Wyant TL, Fisher MT, McKallip RJ, Nagarkatti PS, Nagarkatti M, Conrad DH.; **Mouse B cell activation is inhibited by CD44 cross-linking.** *Immunological Investigations*, 2005;34(4):399-416

American Heart Association Research Grant, 2001-2003.