

**Insights on the mechanisms of arsenic-selenium interactions and associated toxicity  
in plants, animals, and humans: A critical review**

Waqar Ali <sup>a,b</sup>, Hua Zhang <sup>a\*</sup>, Muhammad Junaid <sup>c</sup>, Kang Mao <sup>a</sup>, Nan Xu <sup>c</sup>, Chuanyu Chang <sup>a,b</sup>, Atta Rasool <sup>e</sup>, Muhammad Wajahat Aslam <sup>a,b</sup>, Jamshed Ali <sup>a,b</sup>, Zhugen Yang <sup>d</sup>

<sup>a</sup> State Key Laboratory of Environmental Geochemistry, Institute of Geochemistry, Chinese Academy of Sciences, Guiyang 550081, China.

<sup>b</sup> University of Chinese Academy of Sciences, Beijing 100049, China.

<sup>c</sup> Key Laboratory for Heavy Metal Pollution Control and Reutilization, School of Environment and Energy, Peking University Shenzhen Graduate School, Shenzhen 518055, China.

<sup>d</sup> Cranfield Water Science Institute, Cranfield University, Cranfield, MK43 0AL, United Kingdom.

<sup>e</sup> Department of Environmental Sciences COMSATS University, Islamabad (CUI), Vehari 61100. Pakistan.

**\*Corresponding author**

Prof. Hua Zhang

Email: [zhanghua@mail.gyig.ac.cn](mailto:zhanghua@mail.gyig.ac.cn)

## Contents

1. Introduction .....	1
2. Arsenic and selenium fate in the environment and associated effects .....	4
3. Arsenic and selenium uptake, translocation, accumulation, and toxicity in plants.....	7
3.1. Arsenic .....	7
3.2. Selenium.....	10
4. Arsenic and selenium metabolic processes in animals and humans.....	13
4.1. Arsenic metabolic processes.....	13
4.2. Selenium metabolic processes.....	15
5. Arsenic and selenium epidemiological effects, cytotoxicity, and genotoxicity in animals and humans.....	16
5.1. Epidemiological effects.....	17
5.2. Cytotoxicity.....	19
5.3. Genotoxicity.....	20
6. Antagonistic and synergetic interactions between As and Se, and associated toxicity in animals and humans.....	21
6.1. Antagonistic.....	22
6.2. Synergetic.....	23
7. Arsenic and selenium effects on zinc finger proteins/nucleases (ZFNs) and cellular functions .....	24
8. Arsenic and selenium remediation/phytoremediation and handling of harvested biomass...	27
9. Conclusion and future research perspective.....	29
10. Acknowledgments .....	31
11. Conflict of Interest.....	31
12. References.....	31

**Abstract**

Arsenic (As) is toxic for humans, animals, and plants, whereas selenium (Se) is considered as an essential trace element and can cause toxicity during episodic elevated exposure. Interaction between As and Se is a critical factor for a detailed systematic understanding of the transportation, environmental fate, and associated toxicological effects of these metalloids in biological systems. Arsenic and Se induce cytotoxicity and genotoxicity through the generation of reactive oxidation species (ROS). Compared to arsenite ( $\text{As}^{\text{III}}$ ), the methylated arsenicals, including methylarsonous acid ( $\text{MAs}^{\text{III}}$ ) and dimethylarsinous acids ( $\text{DMAs}^{\text{III}}$ ) exhibit more cytotoxic and genotoxic potentials to inhibit more potent enzymes and activate AP-1 protein, which is a critical marker for genetic stability. Methylated  $\text{As}^{\text{III}}$  and associated metabolites are well-known potential carcinogens that induce toxicity by blocking Se metabolism pathway. Low concentrations of Se compounds under reducing conditions inhibit the DNA repairing process and constraint the binding of zinc finger protein to DNA and ultimately cause the release of zinc from the motif of the zinc finger. Imbalance of Se compounds can lead to the generation of ROS, which can inhibit or decrease genomic stability. Arsenic and Se nexus also affect cellular signaling through activation of the transcription factors such as  $\text{NF}\kappa\text{B}$  and AP-1. In a nutshell, this review highlights As and Se sources in the environment, their uptake in soil-plant system, interactions between these metals and associated toxicity in major biological compartments, which may assist in addressing the hazardous impacts associated with As and Se contamination. Last but not the least, this review also summarizes the available remedial measures and future research directions to cope with this critical issue.

**Keywords:** Arsenic-selenium; Complex interactions; Toxicity; Plants; Animals; Humans

## 1. Introduction

Previous cutting-edge studies have suggested that the understanding of mechanistic interactions between As and Se is critical to unveil their environmental fate and health-related consequences in animals and humans. Arsenic is the 20<sup>th</sup> most abundant element in the earth's crust and well known human carcinogen and exhibits only one isotope in nature (Ali, Aslam, Feng, Junaid, Ali, Li, Chen, Yu, Rasool and Zhang 2019). Two main species of As exist in the terrestrial environment, including arsenate ( $\text{As}^{\text{V}}$ ) and arsenite ( $\text{As}^{\text{III}}$ ), which are mainly dominant under oxidizing and reducing environmental conditions, respectively (Sun, Rathinasabapathi, Wu, Luo, Pu and Ma 2014). Different As species have different modes of toxicity in biological systems. For instance, the final product of As metabolites, monomethylarsonic acid ( $\text{MMA}^{\text{V}}$ ) and dimethylarsinic acid ( $\text{DMA}^{\text{V}}$ ) moderately less toxic than inorganic As, albeit the toxicity of intermediate metabolites, monomethylarsonous acid ( $\text{MMA}^{\text{III}}$ ) and dimethylarsinous acid ( $\text{DMA}^{\text{III}}$ ) considerably higher than inorganic  $\text{As}^{\text{V}}$  such as  $\text{MMA}^{\text{V}}$ ,  $\text{DMA}^{\text{V}}$ , and  $\text{As}^{\text{III}}$ . In major biological systems (plants, animals, and humans), the toxicity behavior of different As species increases in the order of  $\text{As}^{\text{V}} < \text{MMA}^{\text{V}} < \text{DMA}^{\text{V}} < \text{As}^{\text{III}} < \text{MMA}^{\text{III}} \approx \text{DMA}^{\text{III}}$  (Sun, Rathinasabapathi, Wu, Luo, Pu and Ma 2014, Bastías and Beldarrain 2016).

Selenium is a metalloid, first discovered in 1817 by Swedish chemist Jons Jacob Berzelius and exists in the earth's crust at the level of 50 to 90  $\mu\text{g}/\text{kg}$  (Shahid, Niazi, Khalid, Murtaza, Bibi and Rashid 2018, Sneddon 2012). Selenium has various valance states, including selenide ( $\text{Se}^{\text{II}}$ ), selenium ( $\text{Se}^{\text{0}}$ ), thioselenate ( $\text{SSeO}_3^{2-}$ ), selenite ( $\text{Se}^{\text{IV}}$ ), and selenate ( $\text{Se}^{\text{VI}}$ ) (Schiavon and Pilon-Smits 2017, Chauhan, Awasthi, Srivastava, Dwivedi, Pilon-Smits, Dhankher and Tripathi 2019). Alike As, where  $\text{As}^{\text{V}}$  is less toxic than  $\text{As}^{\text{III}}$ ,  $\text{Se}^{\text{VI}}$  is less toxic than  $\text{Se}^{\text{IV}}$  in both eukaryotes and prokaryotes (Sun, Rathinasabapathi, Wu, Luo, Pu and Ma 2014). However, different studies suggested  $\text{Se}^{\text{IV}}$  and  $\text{Se}^{\text{VI}}$  as the only and most abundant form of Se available for plant uptake (Shahid, Niazi, Khalid, Murtaza, Bibi and Rashid 2018). Abbreviations used in the current review are listed in (Table 1).

Selenium also brought under the type of essential element for microbes, animals, and humans at a certain level. For example, Se recommended dietary allowance (RDA) limit is 55  $\mu\text{g}/\text{day}$  for adults (Sun, Rathinasabapathi, Wu, Luo, Pu and Ma 2014, Zwolak and

Zaporowska 2012, Zeng, Uthus and Combs 2005). Selenium acts as a critical component in different selenoproteins, including glutathione peroxidases (GPx), a family of antioxidant enzymes in animals and humans (Savitha 2014). Selenium occurs in numerous oxidation states that permit to produce organoselenium and selenoamino acid complexes (Tinggi 2003). In plant-system, Se is also considered as a beneficial element and acts as an antioxidant at low and acceptable doses and protects plants from various types of abiotic stresses. However, an excessive amount of Se in plant-system behaves like a pro-oxidant and causes toxicity (Shahid, Niazi, Khalid, Murtaza, Bibi and Rashid 2018).

Selenite commonly used as a feed additive in different commercial animal diets with a recognized Se dose of 0.5 mg/kg of the whole feed (Zwolak 2019). Whereas, in humans, Se intake varies across various countries. Overall, Se consumption for adults ranged from 93 to 134  $\mu\text{g/day}$  in North America; optimal Se consumption ranged from 52 to 64  $\mu\text{g/day}$  in Western Europe and low levels of Se consumption ranged from 30 to 40  $\mu\text{g/day}$  in Eastern Europe (Zwolak 2019). This metalloid is also known as cancer chemopreventive compound, which is indispensable for cells to function properly (Zeng, Uthus and Combs 2005). Several mechanisms have been reported about the chemoprotective effects of Se such as antioxidant protection, reduction in carcinogen metabolism effects, enhance immune surveillance system, and inhibition of the angiogenesis process and cell cycle (Lu and Jiang 2001, Zeng 2009).

Several mechanisms are proposed to elucidate the interaction between As and Se. However, the biological interactions between As and Se depend on specific biochemical forms for the reason that As and Se are metalloids with similar chemical properties have intensely alike and unlike biological effects (Sun, Rathinasabapathi, Wu, Luo, Pu and Ma 2014). However, the antagonistic effects or natural detoxification between As and Se have been confirmed in several animal species, as well as in humans (Zwolak and Zaporowska 2012). Due to chemical similarity, As and Se both, play dual roles concerning cancer. Arsenic is known for its carcinogenicity; so far, it is also used in treating certain cancers. Likewise, Se is known as an anticarcinogen and nonetheless, but it also causes cancer. So far, substantial research was done to elucidate insights into their carcinogenic mechanisms and interaction between their double roles, such as carcinogen and anticarcinogen (Sun, Rathinasabapathi, Wu, Luo, Pu and Ma 2014).

Historically, the Mexican first time in 1938 introduced and used As as a treatment to reduce the toxicity of Se in animals (Rosen and Liu 2009). Elevated concentrations of both As and Se in animals and humans cause a release, relocation, and removal of the essential or non-essential metals *via* biliary, urinary, and expiratory pathways (Gaxiola-Robles, Labrada-Martagón, Acosta-Vargas, Méndez-Rodríguez and Zenteno-Savín 2014). Several recent studies elucidated the insights protective competence of Se from Se<sup>IV</sup> contrast to As<sup>III</sup>, tempted renal toxicities, immunotoxicity, and or cardiovascular injuries in animals and humans (Zwolak 2019). Mechanistic interactions between As and Se, signifies the protective effects of Se on As methylation efficiency such as the elevated concentration of urinary Se mainly related with increased percentage of the DMA<sup>V</sup> and reduced percentage of inorganic As in the urine of As exposed pregnant women in Chile and Taiwan (Hsueh, Ko, Huang, Chen, Chiou, Huang, Yang and Chen 2003, Christian, Hopenhayn, Centeno and Todorov 2006). While, findings from another study on As exposed adults suggested that the plasma Se level inversely related with the percentage of total As concentration in blood and urine and the percentage of the MMA<sup>V</sup> utterly related with the percentage of DMA<sup>V</sup> in blood and at the same time, the plasma Se did not affect the As metabolites in the urine of studied population (Pilsner, Hall, Liu, Ahsan, Ilievski, Slavkovich, Levy, Factor-Litvak, Graziano and Gamble 2010).

Recently, a study on unexposed preschool children in Taiwan confirmed the elevated concentration of Se in plasma was related to a decreased percentage of MMA<sup>V</sup> and an increased percentage of DMA<sup>V</sup> (Su, Hsieh, Chung, Huang, Lin, Ao, Shiue, Chen, Huang and Lin 2019). However, contrary results reported by Skröder Löveborn et al. who revealed a positive interaction between increasing erythrocyte levels of Se and increasing percentages of As and MMA<sup>V</sup> in urine samples (collected from children), implying that Se contributed in the methylation of As in children (Skröder Löveborn, Kippler, Lu, Ahmed, Kuehnelt, Raqib and Vahter 2016). Furthermore, Styblo and Thomas (2001) reported that the Se<sup>IV</sup> at 2 µM dose could inhibit the As<sup>III</sup> methylation process increased the cellular retention of As-induced toxicity mediated by MMA<sup>III</sup>, DMA<sup>III</sup>, and As<sup>III</sup> in rat hepatocytes (Styblo and Thomas 2001). So far, the contrary results have been stated in the reviewed literature as both antagonistic and synergistic interactions, and toxicity exists between As and Se (Sun, Rathinasabapathi, Wu, Luo, Pu and Ma 2014).

Considering all this background information on the significance of As and Se in biological systems and most importantly their interaction (which is currently scarce at large), this review aims at highlighting the following three main objectives: 1) to explain possible mechanisms of As and Se uptake in the soil-plant system and plant toxicity, 2) the As and Se interactions in animals and humans, and 3) physiological significance with metabolic process of Se to understand the toxicity and exposure routes of As.

**Table 1**

## **2. Arsenic and selenium fate in the environment and associated effects**

Anthropogenic sources of As and Se include mining, smelting, metal ores processing, coal combustion, municipal, industrial and domestic waste disposal, while natural sources comprise of volcanic eruption and rock weathering (Figure 1) (Wen and Carignan 2007, Ali, Aslam, Feng, Junaid, Ali, Li, Chen, Yu, Rasool and Zhang 2019, Zeng, Wu, Liang, Guo, Huang, Xu, Liu, Yuan, He and He 2015). In the past, As and arsenical compounds are widely used for the preparation of insecticides, pesticides, herbicides, and fungicides (Ali, Mushtaq, Javed, Zhang, Ali, Rasool and Farooqi 2019).

Arsenic naturally occurs in over 200 numerous forms of minerals, of which about 60% are arsenates, 20% sulfides, sulfosalts, and 20% are oxides, arsenide, arsenite, silicates, and elemental As (Ali, Aslam, Feng, Junaid, Ali, Li, Chen, Yu, Rasool and Zhang 2019b). Naturally, there are four processes, i.e., reductive dissolution, sulfide oxidation, alkali desorption, and geothermal activities that usually are involved in releasing As in different environmental compartments such as air, soil, and groundwater (Bhattacharya, Mukherjee, Bundschuh, Zevenhoven and Loeppert 2007). Arsenic can also derive from natural, presumably detrital chlorite (Hering, Burris, Reisinger and O'Day 2008). The oxidation-reduction potential (Eh) and pH are two primary significant factors that control As speciation and solubility, both in soil and groundwater (Frohne, Rinklebe, Diaz-Bone and Du Laing 2011). At neutral and slightly acidic pH, the As<sup>III</sup> compounds exist as non-dissociated salts while at pH > 8, they exist as anionic species (Ali, Aslam, Feng, Junaid, Ali, Li, Chen, Yu, Rasool and Zhang 2019).

Moreover, microbial activities influence As behavior in the soil environment and increase As availability in the soil-plant system (Liu, Yin, Zhang, Tsang, Wei, Zhou, Xiao, Wang, Dong and Sun 2019, Khalid, Shahid, Niazi, Rafiq, Bakhat, Imran, Abbas, Bibi and

Dumat 2017). Arsenic mainly adsorbed to iron oxyhydroxides in sediments from where it released in soil, air, and groundwater by microbial degradation (Brammer and Ravenscroft 2009). Microbes primarily degraded the organic matter and reduced ferric-iron to soluble form ferrous-iron and consequently As released into the soil system (Huang 2014). Various microbes such as *Bacillus arsenicoselenatis*, *Crysiogenes arsenates*, *Geospirillum arsenophilus*, etc., play a significant role in redox transformation of As<sup>V</sup> to As<sup>III</sup> through reduction by using As<sup>V</sup> as a terminal electron acceptor (Khalid, Shahid, Niazi, Rafiq, Bakhat, Imran, Abbas, Bibi and Dumat 2017). However, As methylation also takes place under oxidizing or reducing environmental conditions by a variety of microbes. During the As microbial methylation process, As<sup>V</sup> is converted to As<sup>III</sup> followed by several steps and form several organic As compounds, such as MMA<sup>V</sup>, DMA<sup>V</sup>, and trimethyl arsine (TMA) (Khalid, Shahid, Niazi, Rafiq, Bakhat, Imran, Abbas, Bibi and Dumat 2017, Rahman, Hogan, Duncan, Doyle, Krassoi, Rahman, Naidu, Lim, Maher and Hassler 2014).

Arsenite is sixty times more poisonous and cancer-causing to humans compared with As<sup>V</sup> (Hughes, Beck, Chen, Lewis and Thomas 2011). Arsenite can bind with tissues for an extended period through specific groups of proteins that distressed the ATP synthesis (Brown and Ross 2002, Chandrakar, Pandey and Keshavkant 2018). Long-lasting As exposure damages human cardiovascular, dermal, neurological, hepatic, respiratory, and reproductive systems (Ali, Mushtaq, Javed, Zhang, Ali, Rasool and Farooqi 2019).

Selenium is also a well known toxic element, Se and Se-compounds widely used as feed additives (Navarro-Alarcon and Cabrera-Vique 2008), which exhibit adverse effects on the environment and food chain that has been discussed comprehensively during the recent past (Chauhan, Awasthi, Srivastava, Dwivedi, Pilon-Smits, Dhankher and Tripathi 2019). Similar to As, Se can also biologically transformed through redox methylation reactions mediated by a variety of microbes. In soil-system, microbes can reduce Se<sup>VI</sup> and Se<sup>IV</sup> to the elemental Se directly or through changing the pH and Eh, which makes Se<sup>IV</sup> comparatively more available to plants than Se. However, this transformation process also can occur in both oxidizing and reducing soil conditions (Saha, Fayiga and Sonon 2017). Microbes can make use of both Se<sup>VI</sup> and Se<sup>IV</sup> as terminal electron acceptors during respiration under reducing soil conditions (Saha, Fayiga and Sonon 2017). Whereas, both organic and inorganic forms of Se actively transformed into volatile methylated organic



complexes such as dimethyl selenide (DMSe) and dimethyl diselenide (DMDS<sub>2</sub>) by fungi, bacteria and plants roots (Winkel, Vriens, Jones, Schneider, Pilon-Smits and Bañuelos 2015a). Though DMSe is a critical compound, produced through respiration by plants and microbes (Stolz, Basu, Santini and Oremland 2006).

Selenium plays a vital role in the foraging and regulation of free radicals (Hartikainen 2005). At physiological pH, Se complexes (selenol) readily dissociate and participate in catalytic reactions (Tinggi 2003). In human body, excessive Se changed to selenocysteine (SeCys) which is known as the 21<sup>st</sup> proteogenic amino acid, an essential component of 25 various selenoproteins (Chauhan, Awasthi, Srivastava, Dwivedi, Pilon-Smits, Dhankher and Tripathi 2019, Constantinescu-Aruxandei, Frîncu, Capră and Oancea 2018). Integration of SeCys instead of cysteine at the active sites of enzymes such as methionine-R-sulfoxide reductase can change their catalytic activity and electron donor specificity, which is considered as Se toxicity in humans (Gromer, Eubel, Lee and Jacob 2005, Stadtman 2005). The occurrence of SeCys in the active sites of antioxidant enzymes produces maximum catalytic activity because of the stronger nucleophilic influence of SeCys in contrast to cysteine (Cys) (Snider, Ruggles, Khan and Hondal 2013). This caused an alteration in SeCys biosynthesis or precise integration into Se-requiring proteins, which can lead to cause neurological and several other disorders (Chauhan, Awasthi, Srivastava, Dwivedi, Pilon-Smits, Dhankher and Tripathi 2019).

Around 0.5 to 1 billion people worldwide suffering from Se deficiency (Jones, Droz, Greve, Gottschalk, Poffet, McGrath, Seneviratne, Smith and Winkel 2017), which makes them prone to several diseases such as white muscle and Keshan disease (Shahid, Niazi, Khalid, Murtaza, Bibi and Rashid 2018). Selenium deficiency occurs in humans when Se intake is < 40 µg/d (Navarro-Alarcon and Cabrera-Vique 2008, Winkel, Johnson, Lenz, Grundl, Leupin, Amini and Charlet 2011), which can cause reduced bone metabolism, growth obstruction, irregularities in thyroid function, reduced fertility, weaken immune system, and even induce cancer (Navarro-Alarcon and Cabrera-Vique 2008, Gupta and Gupta 2017, Chang, Yin, Wang, Shao, Chen and Zhang 2019). Inorganic Se is 40 times more toxic than organic Se (Vinceti, Maraldi, Bergomi and Malagoli 2009). However, a higher intake of Se > 400 µg/d (Winkel, Johnson, Lenz, Grundl, Leupin, Amini and Charlet 2011) can lead to severe toxicological effects in humans such as skin lesions, nail, hair loss,

cancer, nervous disorders, amyotrophic lateral sclerosis diabetes, and paralytic symptoms (Chauhan, Awasthi, Srivastava, Dwivedi, Pilon-Smits, Dhankher and Tripathi 2019, Fordyce 2013).

### Figure 1

## 3. Arsenic and selenium uptake, translocation, accumulation, and toxicity in plants system

### 3.1. Arsenic

Arsenic uptake, translocation, accumulation, and toxicity in plants and food crops depend on environmental conditions, plant species, and bioavailability of As species (Bhattacharya, Gupta, Debnath, Ghosh, Chattopadhyay and Mukhopadhyay 2012). Arsenate is a major As species in aerobic soil system because  $As^V$  has a strong affinity to bind with iron-oxide or hydrolysis; therefore, the  $As^V$  level ranged from  $< 2.3$  to  $53 \mu M$  in uncontaminated or moderately to highly contaminated soil solutions, respectively (Wilson, Lockwood, Ashley and Tighe 2010, Zhao, Ma, Meharg and McGrath 2009). Whereas  $As^{III}$  observed dominantly in reducing environmental conditions such as in flooded paddy soil (Zhao, Ma, Meharg and McGrath 2009). Thermodynamically, the reduction of  $As^V$  to  $As^{III}$  takes place in-between redox potential leads to the mobilization of  $As^{III}$  into the soil solution, which causes an increase As availability to plants (Chen, Han, Cao, Zhu, Rathinasabapathi and Ma 2017). In paddy flooded soil, the concentration of  $As^{III}$  ranged from  $0.01$  to  $3 \mu M$ , the concentration much higher as compare to  $As^V$  contaminated soils (Zhao, Ma, Meharg and McGrath 2009).

In plants, various protein transporters assist the uptake of As in its inorganic form, and this process usually depends on As concentration gradient between source and sink (Abbas, Murtaza, Bibi, Shahid, Niazi, Khan, Amjad and Hussain 2018). Arsenic uptake in plant cells depends on As species such as  $As^V$ , uses different phosphate (Pi) transporter that belongs to the PHT1 family for the reason that the phosphate is chemically similar to  $As^V$  (Moreno-Jiménez, Esteban and Peñalosa 2012). Whereas,  $As^{III}$  uses silicon (Si) transporters due to its resemblance to  $As^{III}$  and Si (Bastías and Beldarrain 2016). Arsenite is fascinated by the aqua glycoprotein nodulin-like essential proteins (NIPs) (Bastías and Beldarrain 2016). Under Si deficiency, the expression of influx Si transporters (Lsi1 & Lsi2) increases (Ma and Yamaji 2008). Accumulation of Si in plant cells controlled by the Lsi1

and Lsi2 transporters, which contained at proximal or distal flanks of epidermal and endodermal cells, which help in transportation of As across the plant's cells and tissues (Abbas, Murtaza, Bibi, Shahid, Niazi, Khan, Amjad and Hussain 2018). However, the traces of methylated As species well known as MMA and DMA are also found in some As contaminated soils (Zhao, Ma, Meharg and McGrath 2009).

Monomethylarsenic acid and DMA mainly originated from past use of arsenicals compounds such as herbicides or insecticides or also may be synthesized by algae or soil micro-organisms (Zhao, Ma, Meharg and McGrath 2009). Monomethylarsenic acid and DMA absorbed by the aquaporins using the same uptake mechanisms as glycerol in plant cells (Bastías and Beldarrain 2016). Once the As species mobilize from soil to plant roots cell (Fig. 2), the  $As^V$  mainly reduced by As-reductase (AR) to  $As^{III}$ , which can cause the transformation of GSH to its oxidized form GSSG (Abbas, Murtaza, Bibi, Shahid, Niazi, Khan, Amjad and Hussain 2018b). Arsenite transformed into trimethyl arsenic oxide ( $TMAO^V$ ) or the trimethyl arsine oxide ( $TMAO^{III}$ ), the end product of As methylation releases into the environment (Bastías and Beldarrain 2016). The alternative route of As detoxification happens by phytochelatin (PCs) synthesis due to condensation of amino acids such as glutamate (Glu), glycine (Gly), and cysteine (Gupta and Khan 2015). Within the vacuole, the appropriation of  $As^{III}$ -PCs compounds occurs through the activation of different unknown transporters (Awasthi, Chauhan, Srivastava and Tripathi 2017). While  $As^{III}$  causes more toxicity as compare to  $As^V$  and can bind with various proteins or peptides, which contain thiol groups known as metallothionein, glutathione, and phytochelatin, makes them inactive compounds which leads to protect cells components from As induced toxicity (Bastías and Beldarrain 2016, Ali, Isayenkov, Zhao and Maathuis 2009).

Previous studies suggested that the reduction of As occurs mainly in root cells before transport to xylem and remaining parts of the plants (Zhao, Ma, Meharg and McGrath 2009). Arsenite and  $As^V$  are predominant As species primarily found in the xylem sap of plants (Finnegan and Chen 2012). A small concentration of total As absorbed through the plant root, only minute quantity is sequestered in the leaves, shoots, and grains vacuole due to As reduction and sequestration mechanisms are almost similar to those of the roots (Bastías and Beldarrain 2016). Hence, the occurrence of  $As^{III}$  and  $As^V$  in the phloem is a requirement for its distribution in other parts of the plant (Chen, Han, Cao, Zhu,

Rathinasabapathi and Ma 2017). Elevated As concentration in the soil causes disruption of plant normal function and metabolism, leading to plant stunted growth as well as low productivity (Moreno-Jiménez, Esteban and Peñalosa 2012).

Arsenic disrupts plant biochemical and metabolic pathways such as delayed nutrient absorption, effects on plant photosynthetic system, interruption in plant water uptake status, interaction with different functional groups of plant enzymes, and exchanges essential ions from ATP in plant growing in As polluted soils (Abbas, Murtaza, Bibi, Shahid, Niazi, Khan, Amjad and Hussain 2018). Once As absorbed by plants, the plant light-harvesting system might be affected with decrease in chlorophyll level and photosynthetic activity-II (Sharma 2012). A notable decrease in chlorophyll content and pigment synthesis was described due to deficiency in the adaptive adjustment of plants photosystem -I and -II due to elevated As (Garg and Singla 2011). Correspondingly, reduction in chlorophyll synthesis was observed in different plants such as *Trifolium pratense* L. *Zea mays* and *Lactuca sativa*, respectively (Abbas, Murtaza, Bibi, Shahid, Niazi, Khan, Amjad and Hussain 2018a).

Arsenic causes severe damage to the chloroplast membrane, which leads to disturbing the function of essential plant photosynthetic processes such as rate of carbon dioxide (CO<sub>2</sub>) fixation and significantly reduces the functionality of PS-II (Garg and Singla 2011, Asati, Pichhode and Nikhil 2016, Stoeva and Bineva 2003). Arsenic affects photochemical proficiency and plant heat dissipation competence, which is responsible for the exchange rate of gases as well as plant fluoresces releases (Chandrakar, Naithani and Keshavkant 2016). Arsenic also causes a reduction in both leaves and roots growth, which leads to the wilting and bluish-purple coloring of leaves (Chandrakar, Pandey and Keshavkant 2018). The elevated concentration of As in plant growing soil may also inhibit plant metabolism system, effects on plants micro and macronutrient uptake, and compete with essential plant nutrients such as phosphate uptake (Finnegan and Chen 2012). Plants membranes are susceptible targets of As-stress induced toxicity cause cellular damage that leads to reduced plant stomatal conductance, unstable and reduced nutrient uptake and disrupt plant transpiration process (Kofroňová, Mašková and Lipavská 2018).

Whereas, As induces molecular and biochemical effects in plants system by two ways, 1) the direct inactivation of essential enzymes through sulfhydryl groups interaction or replacement of compulsory ions from the enzyme active sites, and 2) the indirect spurt of

ROS consequently in a cascade of irretrievable damages in plants (Chandrakar, Naithani and Keshavkant 2016). Reactive oxygen species chemically reactive, highly unbalanced molecules, contains unpaired valence electrons with short survival time (Balakhnina and Nadezhkina 2017, Yang, Cao and Rui 2017). Different metabolic pathways are functioning in different cellular compartments, such as mitochondria, chloroplast, and peroxisome, through continuously generating ROS as a byproduct in the typical plant metabolism process (Das and Roychoudhury 2014). The imbalance generation of ROS are well known to cause oxidation of non-specific proteins, carbohydrates, lipids, cell membrane leakage, DNA damages, and essential enzymes' inactivation in plants (Hasanuzzaman, Nahar and Fujita 2013).

### **3.2. Selenium**

Selenium uptake, translocation, accumulation, and toxicity depends on plant species, plant development phases, Se level, the activity of membrane transporters, translocation mechanisms of plant, and soil physiological conditions (pH & salinity) (Gupta and Gupta 2017, Chang, Yin, Wang, Shao, Chen and Zhang 2019). Compared with  $\text{Se}^{\text{IV}}$ , the  $\text{Se}^{\text{VI}}$  is more frequently bioavailable and water-soluble in agriculture soils (Fernández-Martínez and Charlet 2009). Selenium translocation in plant shoots, leaves, and grains depends on the rate of transpiration and the rate of xylem loading (Gupta and Gupta 2017, Renkema, Koopmans, Kersbergen, Kikkert, Hale and Berkelaar 2012). In soil, the occurrence of contending ions, mainly sulfate and phosphate, might be affected by Se uptake in plants (Gupta and Gupta 2017, Golob, Gadžo, Stibilj, Djikić, Gavrić, Kreft and Germ 2016). Due to chemical similarities between Se and sulfate, both elements share common metabolic pathways in plants throughout the translocation process. Selenite and  $\text{Se}^{\text{VI}}$  are available forms of Se, which vigorously compete with sulfur, sulfite, thiosulfate, and sulfate in plant systems (Shahid, Niazi, Khalid, Murtaza, Bibi and Rashid 2018).

Selenium uptake in plant systems is facilitated by transporters, whereas  $\text{Se}^{\text{IV}}$  and  $\text{Se}^{\text{VI}}$  transported through sulfate and phosphate channels, respectively (Shahid, Niazi, Khalid, Murtaza, Bibi and Rashid 2018). Selenate enters the plasma membrane of plant root cells by sulfate transporters (Lin, Zhou, Dai, Cao, Zhang and Wu 2012). It is well examined that the addition of sulfate into acidic soil can decrease Se uptake by plants (De Temmerman, Waegeneers, Thiry, Du Laing, Tack and Ruttens 2014); however, the effects are reversed

in alkaline soil (Huang, Hu and Liu 2007). Selenate and phosphate compete and enter into the plasma membrane of plant root cells through phosphate-transporters (Winkel, Vriens, Jones, Schneider, Pilon-Smits and Bañuelos 2015a). The presence of phosphate raises the Se bioavailability most possibly through the exchange of Se in sorption sites, therefore increasing Se mobility and uptake in the plants (Shahid, Niazi, Khalid, Murtaza, Bibi and Rashid 2018). Usually, younger plant leaves contain higher Se concentration compared with older ones through the seeding growth phase (Cappa, Cappa, El Mehdawi, McAleer, Simmons and Pilon-Smits 2014).

Selenium naturally accumulates in plant cell vacuoles and effluxes through sulfate transporters existing in tonoplast (Mazej, Osvald and Stibilj 2008, Hawkesford and De Kok 2006). Based on Se accumulation inside plant cells, plants classified as non-accumulator, secondary accumulators, and hyperaccumulators (Schiavon, Pilon, Malagoli and Pilon-Smits 2015). Hyper-accumulator plants can accumulate a higher amount of Se > 1000 mg/kg DW in plant cells. The methylated form of Se, such as SeMet and SeCys, which deliberate Se tolerance in hyper-accumulator plants and further vaporized to DMDS<sub>2</sub>. Whereas, the secondary and non-accumulator plant can accumulate Se 100 to 1000 and < 100 mg/kg DW, respectively shows there is no sign of toxic effects on plants (Gupta and Gupta 2017). Selenium after entrance into the plant cell with help of sulfate transporter, translocated in other parts of the plant, *i.e.*, shoots, leaves, and grain cells (Bitterli, Bañuelos and Schulin 2010) and metabolized in plastids through sulfate integration pathway to SeMet or SeCys, while the sulfur chemically analog with Se could be more methylated and evaporated into atmosphere in non-toxic form (Pilon-Smits and Quinn 2010).

The first step of Se metabolism inside the plant leaves or shoot cell, initiated with sulfate integrating enzymes through the conversion of Se to Se<sup>IV</sup> *via* two enzymes, *i.e.*, ATP sulfurylase (APS) and APS reductase (APR) (Shahid, Niazi, Khalid, Murtaza, Bibi and Rashid 2018, Gupta and Gupta 2017). Sulfurylase catalyzes hydrolysis of ATP to couples ATP and Se<sup>VI</sup> and form adenosine phosphoselenate (APSe), which is further reduced to Se<sup>IV</sup> by APR enzyme (Fig.2) (Shahid, Niazi, Khalid, Murtaza, Bibi and Rashid 2018, Pilon-Smits and Quinn 2010). In a nutshell, Se<sup>IV</sup> is changed to Se<sup>II-</sup> by sulfite reductase enzyme, and this metabolic step may also reduce through glutaredoxins (Grxs) or GSH (Wallenberg,

Olm, Hebert, Björnstedt and Fernandes 2010). The reduction of  $\text{Se}^{\text{VI}}$  to APSe can increase plant tolerance to  $\text{Se}^{\text{IV}}$  induced stress (Shahid, Niazi, Khalid, Murtaza, Bibi and Rashid 2018). In the next metabolic step,  $\text{Se}^{\text{II}^-}$  transformed to SeCys through coupling with O-acetyl serine (OAS) in the presence of cysteine synthase (CS) enzyme. The CS enzyme has more attraction for  $\text{Se}^{\text{II}^-}$  as compared to sulfide ( $\text{S}^{\text{II}^-}$ ), which depends on environmental conditions and plant species (Pilon-Smits and Quinn 2010).

The SeCys transformed to Se in the presence of SeCys-lyase enzyme or might be methylated to Me-SeCys through selenocysteine methyltransferase (SMT), or can be changed to selenomethionine (SeMet) through a sequence of enzymes (Shahid, Niazi, Khalid, Murtaza, Bibi and Rashid 2018, Gupta and Gupta 2017). The imbalanced incorporation of SeMet/SeCys in plant proteins can cause damage to the structure and function of the protein, which leads to Se toxicity in plant (Gupta and Gupta 2017, Pilon-Smits and Quinn 2010). Whereas, SeMet can further methylate to methyl-SeMet. The Me-SeCys or Me-SeMet volatilized to the atmosphere as non-toxic dimethyl selenide (DMSe) or dimethyl diselenide (DMDS<sub>e</sub>) in non-accumulator and hyper-accumulator plants, respectively (Shahid, Niazi, Khalid, Murtaza, Bibi and Rashid 2018, Pilon-Smits and Quinn 2010).

Selenium toxicity or selenosis ensues in plants by two mechanisms; 1) malformed selenoprotein induced toxicity, and 2) oxidative stress-induced Se toxicity. Malformed selenoprotein toxicity in plants occurs in the protein chain by replacement of SeCys or SeMet with Cys or Met (Gupta and Gupta 2017). In-plant protein chain, the Cys residues perform an essential role in the synthesis of protein structure and function, as well as aids in the synthesis of metal-binding sites, metal catalysis, and disulfide linkage. Hence, Cys replacement with SeCys causes damage to protein structure and function because of SeCys have the more exceptional reactive ability that can be quickly deprotonated compared with Cys (Gupta and Gupta 2017, Hondal, Marino and Gladyshev 2013). The replacement of Cys with SeCys dysfunctions methionine sulfoxide reductase because of more considerable diselenide linkage and altered redox potential which disrupts the plant enzyme kinetics (Hondal, Marino and Gladyshev 2013, Châtelain, Satour, Laugier, Vu, Payet, Rey and Montrichard 2013). Selenium induced toxicity is caused due to disturbance and disparity between production scavenging of ROS (Shahid, Niazi, Khalid, Murtaza, Bibi and Rashid

2018). At elevated dose, the Se stress cause to decrease the level of glutathione and Se behave as pro-oxidant and produced ROS, which may cause oxidative stress in plants (Feng, Wei and Tu 2013, Hugouvieux, Dutilleul, Jourdain, Reynaud, Lopez and Bourguignon 2009).

Additionally, several nanoparticles (NPs) released into environmental compartments from different manufacturing and commercial sectors that can induce toxicity to plants (Yang, Cao and Rui 2017, Rai, Kumar, Lee, Raza, Kim, Ok and Tsang 2018). Arsenic and Se based NPs also caused the imbalance generation of ROS, induced oxidative stress, and posed severe toxic effects on photosynthesis and growth in plants, which even can lead to plant death (Yang, Cao and Rui 2017, Sarkar, Bhattacharjee, Daware, Tribedi, Krishnani and Minhas 2015). However, several studies have made some consensus on the environmental behavior, interactions, ecological effects, and toxicity of As and Se based NPs in plant systems, but still a lot of controversies and problems that need to be further studied.

## Figure 2

### 4. Arsenic and selenium metabolic processes in human and animals

#### 4.1. Arsenic metabolic processes

Arsenite has an analogous structure to glycerol and transported in cells through aquaglyceroporins, minute proteins moving minimal organic compounds similar to urea and glycerol (Liu, Shen, Carbrey, Mukhopadhyay, Agre and Rosen 2002). Nevertheless,  $As^V$  uses diverse pathways both in animals and human cells with the physiological phosphate similarity with the following analogous detachment constants (pKa of As-acid: 2.26, 6.76 and 11.3 and pKa of phosphoric acid: 2.16, 7.21, and 12.3) (Villa-Bellosta and Sorribas 2008). Arsenite ( $LD_{50}$  of the  $NaAsO_2$ :41mg/Kg) is considered more toxic, carcinogenic than that of  $As^V$ , more toxic than organic As species dimethylarsinic acid (DMA) and monomethylarsonic acid (MMA) (Harper, Antony and Bayse 2014, Jain and Ali 2000). Total As analogous to phosphate,  $As^V$  oxyanion present in solution such as  $H_2AsO_4$  and  $HAsO_4^{2-}$  at pH ranging from 5 to 7 due to the chemical similarity, to compete and entry by phosphate transporters (Plant, Kinniburgh, Smedley, Fordyce and Klinck 2004). In humans, inorganic As once entering the body, then it is heavily methylated before excretion in the urine. Consumed inorganic As methylated into MMA and DMA. The



MMA has more significant toxicity, compared to inorganic As, and MMA can increase the risk of the carcinogenic potential of As (Burgess, Kurzius-Spencer, Poplin, Littau, Kopplin, Stürup, Boitano and Lantz 2014).

After entering humans or animal cells,  $\text{As}^{\text{V}}$  rapidly reduced to  $\text{As}^{\text{III}}$ . After that,  $\text{As}^{\text{III}}$  undergoes to multi-steps based methylation through  $\text{As}^{\text{III}}$  methyltransferase ( $\text{As}^{\text{III}}\text{MT}$ ) by using S-adenosylmethionine (SAM) methyl donor and produces several As-methylated compounds  $\text{MMA}^{\text{III}}$ ,  $\text{DMA}^{\text{III}}$ ,  $\text{MMA}^{\text{V}}$ , and  $\text{DMA}^{\text{V}}$  (Kojima, Ramirez, Tokar, Himeno, Drobná, Stýblo, Mason and Waalkes 2009). Challenger in 1945 was first to introduce Arsenic-methylation in *Scopulariopsis brevicauli*, the classical pathway of methylation (Fig. 3a), and suggested that the As-methylation process included a series of oxidation and reduction processes (Challenger 1945). Another process suggested that the  $\text{As}^{\text{III}}$  can also undergo a non-enzymatic methylation process in rat liver (Fig. 3b) in the presence of methylcobalamin and GSH (Zakharyan and Aposhian 1999). After that, Hayakawa et al. (2005) found that enzymes played a crucial role in As-methylation and proposed a new enzymatic metabolic pathway (Fig. 3c). In As-methylation enzymatic metabolic pathway and the -OH group of  $\text{As}(\text{OH})_3$  are substituted by glutathionyl moieties and forming GSH conjugates  $\text{As}(\text{GS})_2\text{-OH}$  and As-triglutathione  $\text{As}(\text{GS})_3$  (Hayakawa, Kobayashi, Cui and Hirano 2005). After a critical substrate,  $\text{As}^{\text{III}}\text{MT}$  and arsenite-glutathione ( $\text{As}^{\text{III}}\text{GSH}$ ) further methylated to monomethylarsonic-diglutathione ( $\text{MMA}(\text{GS})_2$ ) and then to dimethylarsinic-glutathione ( $\text{DMA}(\text{GS})$ ) (Sun, Rathinasabapathi, Wu, Luo, Pu and Ma 2014).

Another metabolic pathway of As was investigated by (Naranmandura, Suzuki and Suzuki 2006) *via* intravenous injection of As in the rats that metabolized into metabolites of As in renal and hepatic regions (Fig.3d). Further, As metabolites such as the trivalent (inorganic) and pentavalent (organic) arsenicals were detected in the As spiked human urine samples, as well as in *in vitro* cell lysate, and cell culture medium after chronic exposure to As (Devesa, Del Razo, Adair, Drobná, Waters, Hughes, Stýblo and Thomas 2004). Recently another insight on As metabolic pathway was reported in wild-type rat by (Wang, Thomas and Naranmandura 2015), and this study identified the novel As metabolites, the arsenicals (As-S bond) are structurally very similar of oxo-arsenicals (As-O bond), in which oxygen atoms bind with As atoms that substitute with sulfur atoms. However,

thioarsenate (OH)<sub>3</sub>-As(=S), arsenate (OH)<sub>3</sub>-As(=O), which are thioarsenicals-oxoarsenical, are analogs. The study further considered origin and process that convert inorganic As into the methylated oxoarsenicals species and further process converted oxoarsenicals into the thioarsenicals (Fig.3e).

Inorganic As<sup>III</sup> is absorbed from the intestinal lumen and then enzymatically changed into MMA<sup>III</sup> after that compound further changed into diglutathione complex MMA(GS)<sub>2</sub> that secreted in bile. In intestinal lumen, MMA(GS)<sub>2</sub> further converted to monomethyl-monothioarsenic (MMMTA<sup>V</sup>) through microbiota, MMMTA<sup>V</sup> further absorbed across the intestinal wall, then symmetrically dispersed and converted to another thiolate metabolite to the monomethyl-dithioarsenic (MMDTA<sup>V</sup>) (Wang, Thomas and Naranmandura 2015).

### Figure 3

#### 4.2. Selenium metabolic processes

The two-major species of inorganic Se, Se<sup>IV</sup>, and Se<sup>VI</sup> are significant in biological and biochemical cycles of Se; nevertheless, Se species exhibit different biochemical properties such as their energy consumption and differences in their toxicity during uptake and metabolism (Sun, Rathinasabapathi, Wu, Luo, Pu and Ma 2014). The sodium-sulfate cotransporters are primarily responsible for transporting Se<sup>VI</sup> (Bergeron, Cl  men  on, Hediger and Markovich 2013). However, Se<sup>IV</sup> is primarily absorbed into cells through passive diffusion (Skalickova, Milosavljevic, Cihalova, Horkey, Richtera and Adam 2017). Different studies verified that both organic and inorganic Se could exchange their roles in the intracellular environment through a series of reactions (Fig. 4a). Organic Se metabolism processes in animals and human cells through different pathways in the form of Se<sup>II-</sup> (Shini, Sultan and Bryden 2015). The inorganic Se<sup>VI</sup> with high redox potential entering in human or animal cells first underwent the enzymatic reduction changed to Se<sup>IV</sup> and then rapidly reduced enzymatically to Se<sup>II-</sup> through GSH (Ogra and Anan 2009).

Selenate intracellularly reduced to Se<sup>II-</sup> through different pathways, and Se<sup>VI</sup> reacted with reduced GSH form selenodiglutathione (Se(GS)<sub>2</sub>). Further, Se(GS)<sub>2</sub> converted to seleno persulfide (GSSeH), and then GSSeH decayed spontaneously or enzymatically under anaerobic conditions and converted into hydrogen selenide (H<sub>2</sub>Se) (Weiller, Latta, Kresse, Lucas and Wendel 2004). More, a typical intermediate of Se<sup>II-</sup> used either for the selenoprotein biosynthesis, biomethylation to methylselenol (CH<sub>3</sub>SeH), or dimethyl

selenide  $(\text{CH}_3)_2\text{Se}$ , and or trimethyl selenonium cation  $(\text{CH}_3)_3\text{Se}^+$ . Subsequently, they extruded from extracellular spaces with  $(\text{CH}_3)_2\text{Se}$  released through breath and  $(\text{CH}_3)_3\text{Se}^+$  urine (Gailer 2002, Gailer 2007). Thiol reduction of  $\text{Se}^{\text{IV}}$  defined by Harper et al. (2014) and reported that  $\text{Se}^{\text{IV}}$  reacted with four glutathione (thiol, RSH) or with another thiol (Fig. 4b) produced selenotrisulfide (RSSeSR). The RSSeSR can further reduce  $\text{Se}^{\text{II-}}$  through thiols, such as thioredoxin or GSH reductase (Harper, Antony and Bayse 2014, Björnstedt, Kumar and Holmgren 1992, Jörnstedt, Kumar and Holmgren 1995).

Several seleno compounds were metabolized into  $\text{Se}^{\text{II-}}$  by different metabolic pathways, such as the C-Se bond in the seleno amino acid, one of the leading organic Se compounds that cleaved and transformed into  $\text{Se}^{\text{II-}}$  over lyase reactions (Schrauzer 2000, Suzuki, Kurasaki and Suzuki 2007). Selenocysteine transformed and formed the  $\text{Se}^{\text{II-}}$  through  $\beta$ -lyase reaction, and Se-Met transformed into  $\text{Se}^{\text{II-}}$  by  $\beta$ -lyase reaction after complete trans-selenation reaction to SeCys or *via*  $\gamma$ -lyase reaction (Suzuki, Kurasaki and Suzuki 2007). The product of Se methyl metabolism is methyl selenide further demethylated and form  $\text{Se}^{\text{II-}}$  (Ohta and Suzuki 2008).

#### Figure 4

### 5. Arsenic and selenium epidemiological effects, cytotoxicity, and genotoxicity

Arsenic is a well-known carcinogen causing liver, bladder, lung, and skin cancers (Ali, Aslam, Feng, Junaid, Ali, Li, Chen, Yu, Rasool and Zhang 2019). Arsenic exposure produces excess ROS that can cause diverse types of malformations, including both lethal and non-lethal (Sun, Rathinasabapathi, Wu, Luo, Pu and Ma 2014). The acute and chronic minimal lethal dose of As in adults has estimated ranges from 100 to 300 mg/kg/day and 0.05 to 0.1 mg/kg/day, respectively (ATSDR 2007, Ratnaike 2003). Moreover, As exposure causes arsenicosis, Blackfoot disease, skin lesions, and peripheral vascular disease (Naujokas, Anderson, Ahsan, Aposhian, Graziano, Thompson and Suk 2013), while Se exposure is concerned, various studies reported that the low Se level is useful and act as an anticarcinogen. Whereas the high level of Se exposure induced carcinogenesis epidemical effects, cytotoxicity (Fig.5) and genotoxicity (Sun, Rathinasabapathi, Wu, Luo, Pu and Ma 2014, Valdiglesias, Pásaro, Méndez and Laffon 2010).

Several recent studies suggested that As and Se can induce similar toxicity in animals and humans through diverse pathways (Sun, Rathinasabapathi, Wu, Luo, Pu and Ma 2014).

Therefore, for this review, we focus on common mechanisms of As and Se interactions and associated toxicity in animals and humans.

### **5.1. Epidemiological effects**

Different studies demonstrated that As interferes with the series of genes associated with cellular proliferation process, DNA repair and damage, and cell cycle differentiation (Maiti 2015). Arsenic may also alter cell signals transduction pathways such as 53 protein signaling pathways, MAPK pathway, and Nrf2 cell signal pathway (Ghosh and Sil 2015). Reactive oxygen species activating cancer and methylated metabolites of As are known as potential carcinogens such as DMA carcinogen causing cancer in the urinary bladder of rat (Salnikow and Zhitkovich 2007, Shi, Hudson, Ding, Wang, Cooper, Liu, Chen, Shi and Liu 2004). Arsenic caused non-carcinogen diseases, including hypertension, diabetes mellitus, cardiovascular diseases, and dermal diseases (Shakir, Azizullah, Murad, Daud, Nabeela, Rahman, ur Rehman and Häder 2016). Trivalent arsenicals As<sup>III</sup>, MMA<sup>III</sup>, and DMA<sup>III</sup> induced diabetes through disrupting glucose metabolism as investigated on intact pancreatic islets from the mice (Douillet, Currier, Saunders, Bodnar, Matoušek and Stýblo 2013). Arsenite induced inhibition of pyruvate and  $\alpha$ -ketoglutarate dehydrogenases are among the leading causes of diabetes (Navas-Acien, Silbergeld, Streeter, Clark, Burke and Guallar 2006). Most cardiovascular diseases are closely related to hypertension, and so far, different pathways have been investigated for As induced hypertension that increased inflammation activity, endothelial dysfunction, and altering the vascular tone in blood vessels (Flora 2011, Abhyankar, Jones, Guallar and Navas-Acien 2011). Arsenic induces ROS species to inhibit cell signaling, takes part in pathogenesis, increases cytokine production and leads to inflammation that causes further enhanced ROS generation and mutagenesis (Jomova, Jenisova, Feszterova, Baros, Liska, Hudecova, Rhodes and Valko 2011).

Selenium is an essential nutrient that plays a vital role, such as an antioxidant in humans; however, Se deficiency in humans and animals can induce many diseases (Surai 2006). Daily recommended dietary intake for a healthy adult is 30 to 50  $\mu\text{g}/\text{d}$  in the USA, while the Chinese Nutrition Society (CNS) and Europe set recommended dietary intake for a healthy adult is 50 to 250  $\mu\text{g}/\text{d}$  (Whanger 2004). Daily intake of Se ranged from 100 to

200 µg/d can induce genetic and cellular damage; however, excessive dosage Se  $\geq$  400 µg/d can cause cancer in humans (Zeng and Combs Jr 2008, Brigelius-Flohé 2008).

Long-lasting Se exposure-induced disease such as amyotrophic lateral, cardiovascular disease, and sclerosis. However, in human the elevated level Se can cause diabetes because Se activate critical cellular metabolic enzymes which control the insulin signal transduction pathways, albeit regulating various metabolic processes and pathways (pentose pathways, fatty acid synthesis gluconeogenesis, and glycolysis pathways) (Vinceti, Maraldi, Bergomi and Malagoli 2009, Bleys, Navas-Acien, Laclaustra, Pastor-Barriuso, Menke, Ordovas, Stranges and Guallar 2009).

In the 1980s, intensive research investigations failed to realize that there is any correlation between Se and cardiovascular diseases (Rayman 2000). However, recent scientific studies and observations verified that a possible U-shaped strong correlation exists between Se level and cardiovascular disease (Rees, Hartley, Day, Flowers, Clarke and Stranges 2013, Joseph and Loscalzo 2013). Selenium induced neurodegenerative effects by damaging motor neurons and activated protein 38 to 53 that induce amyotrophic lateral sclerosis (Chen, Wang, Xiong, Zou and Liu 2010, Vinceti, Solovyev, Mandrioli, Crespi, Bonvicini, Arcolin, Georgouloupoulou and Michalke 2013). Different studies suggested that oxidative stress-induced Se toxicity like impaired synthesis of thyroid hormones, growth hormones, and disruption of endocrine function (Valdiglesias, Pásaro, Méndez and Laffon 2010, Letavayova, Vlčková and Brozmanova 2006, Maritim, Sanders and Watkins 2003). Reactive oxygen species play a significant role in the epidemiological outcomes of both As and Se mediated toxicity in humans as well as in mammals (Sun, Rathinasabapathi, Wu, Luo, Pu and Ma 2014). Excessive Se produces excessive ROS, and this can affect similar pathways that induce cancer in As exposure cases (Klaunig and Kamendulis 2004, Valko, Rhodes, Moncol, Izakovic and Mazur 2006). Imbalanced generation of ROS act as an inner mechanism for As and Se associated adverse effects in mammals; however, associated adverse outcome pathways (AOPs) for cancer and cardiovascular defects are not explained yet. Therefore, more attention should be paid to conduct studies for a mechanistic understanding of As and Se associated cancer causes and epidemiological effects.

## 5.2. Cytotoxicity

The abnormality within the cell caused by toxic contaminants known as cytotoxicity. Several studies reported As and Se both induced ROS that can cause cytotoxicity within the cells by different pathways (Selvaraj, Tomblin, Armistead and Murray 2013, Park, Kim, Chi, Kim, Chang, Moon, Nam, Kim, Yoo and Choi 2012). Cells exposed against high doses of As and Se led to elevated levels of ROS. While As produced, ROS through inducing NADPH oxidase and Se produced when  $\text{Se}^{\text{II}^+}$  reacted with thiols (Chou, Jie, Kenedy, Jones, Trush and Dang 2004). Reactive oxygen species not only destruct proteins and lipids functions but also activated mitochondrial damage through inducing oxidative stress on mitochondrial-dependent apoptotic pathways (Kim, Sohn, Kwon, Kim, Kim, Lee and Choi 2007, Kim, Jeong, Yun and Kim 2002, Fleury, Mignotte and Vayssière 2002). Further, ROS produce cytotoxicity *via* activation of JNK protein, which is one of the relevant subgroups of the mitogen-activated protein kinases that mediated critical cellular functions such as cell apoptosis, differentiation, and proliferation (Shen and Liu 2006), and also stimulated JNK tumor necrosis factor (Ventura, Cogswell, Flavell, Baldwin and Davis 2004).

Arsenic and Se-induced cytotoxicity by different pathways, and As affecting tumor suppressor protein 53 causing cytotoxicity. While protein 53 plays an essential role during cellular functions through cell growth regulation, cell cycle control, repair, DNA synthesis differentiation, and apoptosis (Andrew, Burgess, Meza, Demidenko, Waugh, Hamilton and Karagas 2006). In human fibroblasts cells, As induced protein 53 accumulation, which may cause cell apoptosis through facilitating Bax translocation from cytosol towards mitochondria, and release cytochrome activating caspase-9 by Apaf-1 and apoptosome (Kircelli, Akay and Gazitt 2007, Shankar and Shanker 2014). Protein 53 induces cell cycle arrest at the G<sub>2</sub>/M phase through transcriptional activation of protein 21 inhibit the cyclin-dependent kinase and also induced autophagy in damage-regulated autophagy modulator (DRAM) dependent manner (Akay, Thomas III and Gazitt 2004, Vogelstein, Lane and Levine 2000, Crighton, Wilkinson, O'Prey, Syed, Smith, Harrison, Gasco, Garrone, Crook and Ryan 2006, Lozano and Elledge 2000).

Selenium is a component of selenoprotein that exhibit close relationship with redox reaction. Nevertheless, thioredoxin reductase (TrxR) enzyme along with thioredoxin (Trx)

produced an active di-thiol-di-sulfide and oxidoreductase complex, which further increases cytotoxicity (Sun, Rathinasabapathi, Wu, Luo, Pu and Ma 2014, McKenzie, Arthur and Beckett 2002). System control cells growth through binding to cells signal molecules like thioredoxin-ininteractin protein and apoptosis signal-regulating kinase-1 are significantly essential compounds responsible for cell growth and cell survival (Wallenberg, Olm, Hebert, Björnstedt and Fernandes 2010, Yoshioka, Schreiter and Lee 2006). Selenium controls or modulates cell signaling pathways *via* thiol redox mechanism, and takes part in cytotoxicity *via* reducing intracellular Cys. Arsenic and Se not only generate cytotoxicity through ROS but also affect on corresponding genes and proteins (Whanger 2004, Hettick, Canas-Carrell, French and Klein 2015, Carlin, Naujokas, Bradham, Cowden, Heacock, Henry, Lee, Thomas, Thompson and Tokar 2015).

### **5.3. Genotoxicity**

The genotoxicity defines as change or damage in genetic information that can cause mutation in cellular information (Valdiglesias, Pásaro, Méndez and Laffon 2010). Arsenic and Se are inducing genotoxicity same as cytotoxicity, through generating ROS. Higher ROS concentrations inside cells affected the cellular components of DNA resulting from the base lesion and strand break that is inducing genotoxicity. The higher level of ROS is dangerous for gene stability, affecting DNA repairing, DNA oxidizes, and gene regulation (Deavall, Martin, Horner and Roberts 2012). However, As and Se both interact with the DNA repair proteins which contains functional zinc finger motifs and these involved essential functions reported as in DNA transcriptional factor, DNA-protein, protein-protein and DNA-repair proteins (Zeng, Uthus and Combs 2005, Hartwig 2001, Zhou, Sun, Cooper, Wang, Liu and Hudson 2011). Selenium reacts with metallothionein and releasing Zn that damages DNA-binding capacity and genomic stability (Zeng, Uthus and Combs 2005, Blessing, Kraus, Heindl, Bal and Hartwig 2004, Larabee, Hocker and Hanas 2009). Arsenic-induced genotoxicity by directly impacting the DNA repairing capacity resulted in a downregulated expression of ERCC1, which is an essential member of repair and nucleotide excision repair pathway (Andrew, Karagas and Hamilton 2003, Andrew, Burgess, Meza, Demidenko, Waugh, Hamilton and Karagas 2006). Long-term exposure of As to cell can induce genotoxicity by SAM depletion in the cell, DNA hypomethylation causing genomic instability, and the global loss of the DNA methylation

(Ren, McHale, Skibola, Smith, Smith and Zhang 2010, Bhattacharjee, Banerjee and Giri 2013). Arsenic and trivalent methylated As compounds efficiently interact with synthesis pathways of enzyme SAM (Vahter 2007, Tseng 2009).

Several researchers confirmed that As<sup>III</sup> and its metabolites also change the activity of DNA methyltransferase resulting in the inhibition or stimulation of SAM enzyme synthesis pathways (Reichard and Puga 2010, Hughes 2002, Zhong and Mass 2001). Interestingly, As induces genotoxicity through affecting the status of protein 53, while similar mechanisms have been reported for the cytotoxicity induction (Shankar and Shanker 2014, Chowdhury, Chowdhury, Roychoudhury, Mandal and Chaudhuri 2009). Nevertheless, Se induced genotoxicity through generating ROS and interacting with the thiol group (Letavayova, Vlčková and Brozmanova 2006, Valko, Rhodes, Moncol, Izakovic and Mazur 2006, Ramoutar and Brumaghim 2007). Selenium can also induce genotoxicity by inhibiting cellular DNA repairing ability, directly affecting protein 53 and ataxia-telangiectasia mutation (ATM) (Abul-Hassan, Lehnert, Guant and Walmsley 2004, Wei, Cao, Ou, Lu, Xing and Zheng 2001, Zhou, Xiao, Li, Nur-E-Kamal and Liu 2003, Zeng and Combs 2008). Arsenic and Se genotoxicity induced mechanisms yet not been clarified; however, most studies attributed to their capability to induce oxidative stress (Sun, Rathinasabapathi, Wu, Luo, Pu and Ma 2014).

### Figure 5

#### **6. Antagonistic and synergetic interactions between As and Se, and associated toxicity in animals and humans**

Researchers had started taking a keen interest in the interaction between As and Se after the findings reported that chronic and acute toxicities of Se might be minimized through the administration of As<sup>III</sup> and some arsenicals compounds (Zeng, Uthus and Combs Jr 2005). Arsenic increased the elimination of Se *via* the gastrointestinal tract when As<sup>III</sup> and Se<sup>IV</sup> were mutually injected at the subacute amount (Zeng, Uthus and Combs Jr 2005). Besides, in various experiments, it was observed that As also promoted the removal of Se from the gut (Sun, Rathinasabapathi, Wu, Luo, Pu and Ma 2014). Likewise, As can decrease Se level in the carcass, blood, and exhaled breath, however, the administration of massive dose of organic arsenical sodium arsanilate can further decrease the removal of Se from the gastrointestinal contents and increased the Se level into the exhaled breath, and



the combined effect caused a small decrease in Se level that retained in the carcass (Sun, Rathinasabapathi, Wu, Luo, Pu and Ma 2014). As stimulated the excretion of Se into the gastrointestinal tract, while  $\text{Se}^{\text{IV}}$  can stimulate the excretion of As. Previous studies demonstrated that As increases, the level of Se excreted into the rat bile and interacted in the liver to form conjugates and then excreted into the bile (Gailer 2007).

### 6.1. Antagonistic

Several *in vivo* studies are existing that suggested the antagonistic relation between As and Se, associated toxicity effects on animals and humans. Once As and Se enter the human body, then they transport to the liver (principal detoxification organ) and rapidly reduced there (Rosen and Liu 2009). Under elevated concentration of GSH in the intracellular hepatocyte, the -OH group of  $\text{As}(\text{OH})_3$  sometimes replaced *via* glutathionyl moieties to form  $(\text{GS})_2\text{AsOH}$  and  $\text{Se}^{\text{IV}}$  underwent a spontaneous reaction with GSH to make  $\text{HSe}^-$  (Rosen and Liu 2009, La Porte 2011). In rats and mice, concentrations of As and Se decreased during antagonistic toxicity of As and Se (Weiller, Latta, Kresse, Lucas and Wendel 2004, Messarah, Klibet, Boumendjel, Abdennour, Bouzerna, Boulakoud and El Feki 2012).

Antagonistic interaction between  $\text{As}^{\text{III}}$  and  $\text{Se}^{\text{IV}}$  resulted in inhibition of gastrointestinal absorption of  $\text{Se}^{\text{IV}}$  through  $\text{As}^{\text{III}}$  (Zwolak and Zaporowska 2012, Rosen and Liu 2009). Immediate administration of  $\text{As}^{\text{III}}$ , along with the  $\text{Se}^{\text{IV}}$ , inhibited the excretion of pulmonary  $(\text{CH}_3)_2\text{Se}$  in rats and hamsters (Rosen and Liu 2009). Arsenite also affects the distribution of Se in internal body organs and transport Se as  $\text{Se}^{\text{IV}}$  towards the liver through the bloodstream (Gailer 2007). Acute  $\text{As}^{\text{III}}$  exposure (3-24 hours) decreased the retention of Se in rat's liver (Naranmandura, Suzuki and Suzuki 2006). However, chronic  $\text{As}^{\text{III}}$  exposure (2-18months) did not decrease the Se level in rat's liver (Zwolak and Zaporowska 2012). In *in vivo* antagonistic interaction between  $\text{As}^{\text{III}}$  and  $\text{Se}^{\text{IV}}$  at the molecular level, that resulted in the generation of As and Se novel compounds, such as seleno-bis (S-glutathionyl) and arsinium ions  $(\text{GS})_2\text{AsSe}$ , which then excreted in the bile (Gailer, George, Pickering, Prince, Younis and Winzerling 2002, Gailer, Ruprecht, Reitmeir, Benker and Schramel 2004). This study further found that As and Se first enter the cell and then simultaneously react with hydrogen  $\text{Se}^{\text{II-}}$  to form  $(\text{GS})_2\text{AsSe}$  (Gailer, George, Pickering, Prince, Younis and Winzerling 2002) (Eq.1).

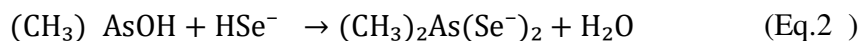
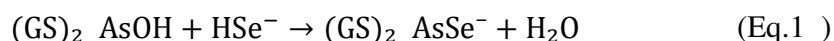

In the above pathway, the nucleophilic  $HSe^-$  attacked As atom and transferred its -OH group, finally  $(GS)_2 AsSe^-$  and water excreted out of the cell. A similar type of pathway was defined by (Manley, George, Pickering, Glass, Prenner, Yamdagni, Wu and Gailer 2006) and specified  $(GS)_2 AsSe^-$  formation in erythrocytes and excreted through the blood. Moreover,  $Se^{IV}$  mediated inhibition and reduction of the methemoglobin by  $As^{III}$  in the presence of GSH, which indicated the erythrocytes involved in facilitating this antagonism interaction between  $As^{III}$  and Se (Zeng, Uthus and Combs Jr 2005).

Arsenite suppressed the formation of  $H_2Se$  from  $Se^{IV}$  in a biological system that contained glutathione reductase in bovine serum albumin (Shibata, Morita and Fuwa 1992). Biochemical interactions between  $As^{III}$  and  $Se^{IV}$  mostly occurred in blood and liver cells (Gailer 2007, Buchet and Lauwerys 1985). Moreover, As and Se interaction pathways have been demonstrated by Gailer et al. (Gailer, George, Harris, Pickering, Prince, Somogyi, Buttigieg, Glass and Denton 2002). Arsenic and Se compounds detected as  $(CH_3)_2 As(Se)_2$ , and it was speculated that  $DMA^V$  first reduced by GSH and then converted to  $DMA^{III}$ . After that, the  $Hse^-$  attacked As atom and relocated the -OH group and yielding compound as  $(CH_3)_2 As(Se)_2$  (Eq. 2). Another pathway (Eq. 3), the SAM provided a methyl group, to transform  $(GS)_2 AsSe^-$  into the  $(CH_3)_2 AsSe^-$  and methyltransferase used as a substrate (Fig. 6a).

## 6.2. Synergetic

Synergetic interaction between As and Se generated Se metabolites such as trimethyl Se ion and dimethyl  $Se^{II-}$  which increased As toxicity (Zeng, Uthus and Combs 2005, Levander 1977). Methylated  $As^{III}$  caused adverse effects on Se metabolism, increased toxicity through blocking its metabolism pathways mainly in rats (Sun, Rathinasabapathi, Wu, Luo, Pu and Ma 2014). Furthermore, the synergetic effects and toxicity of As and Se nexus inhibited the formation of methylated metabolites and, therefore, retained inorganic, monomethyl As and Se in tissues (Fig. 6b) (Styblo and Thomas 2001, Walton, Waters,

Jolley, LeCluyse, Thomas and Styblo 2003). Arsenic and Se undergo a similar type of metabolic change, linked through supplies such as GSH and SAM. However, GSH is one of the essential reductants in organisms; during the metabolism of As and Se. The GSH provides the electron to the intended reduction reaction (Sun, Rathinasabapathi, Wu, Luo, Pu and Ma 2014, Hayakawa, Kobayashi, Cui and Hirano 2005, Yang, Kuo, Chen and Chen 1999). The SAM is versatile molecules in several biological reactions, involves in the detoxification process of methyl As and Se. Once organisms exposed to high doses of As and Se that mutually inhibited the formation of methylated metabolites through competing with limited SAM (Sun, Rathinasabapathi, Wu, Luo, Pu and Ma 2014, Styblo and Thomas 2001).

Furthermore, a summary of studies elucidating insights on the antagonistic and synergetic supplementation interactions between As and Se and toxicity in animals/rat and humans cell culture models are described in Table 2.

#### **Figure 6**

#### **Table 2**

### **7. Arsenic and selenium effects on zinc finger proteins/nucleases (ZFNs) and cellular functions**

Selenium is chemically and qualitatively resembles with sulfur, albeit when Se combine with the zinc protein, it has more oxidoreductive potential (Zeng, Uthus and Combs 2005). Zinc, just like finger structure abundant in motifs of the eukaryotic genome, performed various biological functions not only the transcription but also presented in various kinds of proteins that take part in maintaining the genomic stability, DNA repairing, and control cell cycle (Klug 2010). It has been estimated that around 3% of the known genes that encrypt proteins in the various cellular process included Zn finger protein domains (Zeng, Uthus and Combs 2005, Laity, Lee and Wright 2001, Maret 2003). Selenium can replace the sulfur of the Cys and changed its stability of oxidation states in the course of the catalytic cycle and redox potential (Jacob, Giles, Giles and Sies 2003). Under reducing conditions, Se can oxidize the thiols, mainly found in the cytosol (Moriarty-Craige and Jones 2004).

Low concentration of Se compounds, under reducing condition, the selenocystamine (diselenide) can oxidize thiol groups and releases Zn ions from the metallothionein (Chen

and Maret 2001). Moreover, the low concentration of the Se compounds under reducing conditions inhibits the DNA regulation due to the inactivation of DNA repair proteins (Letavayova, Vlčková and Brozmanova 2006). The reducible Se compounds including phenylseleninic acid ( $C_6H_6O_2Se$ ), phenylselenenyl chloride ( $C_6H_5ClSe$ ), selenocysteine ( $C_6H_{12}N_2O_4Se_2$ ), 2-nitrophenylselenocyanate ( $C_3H_7N_2O_2Se$ ), and ebselen ( $C_{13}H_9NOSe$ ) can also inhibit the activity of Fpg, Zn finger proteins that involved in DNA repairing (Blessing, Kraus, Heindl, Bal and Hartwig 2004, Zeng, Uthus and Combs Jr 2005, Witkiewicz-Kucharczyk and Bal 2006, Hartwig, Blessing, Schwerdtle and Walter 2003). However, no inhibition detected in completely selenomethionine methyl selenocysteine or some sulfur-containing analogs (Zeng, Uthus and Combs 2005, Blessing, Kraus, Heindl, Bal and Hartwig 2004).

Low concentrations of Se compounds can also inhibit the Zn finger protein that binds to DNA that leads to the release of Zn from the motif of Zn finger (Woo Youn, Fiala and Soon Sohn 2001). The cellular pathways mostly dependent on the Zn finger proteins, so the redox responses are essential for the regulation of Zn finger protein (Zeng, Uthus and Combs 2005, Blessing, Kraus, Heindl, Bal and Hartwig 2004). The inequality overdose or deficiency in Se compounds inhibit or decrease genomic stability (Zeng, Uthus and Combs 2005, Blessing, Kraus, Heindl, Bal and Hartwig 2004). The Zn finger proteins are also susceptible to intracellular targets for  $As^{III}$  at a preliminary low micromolar level of all  $As^{III}$  compounds triggered, and Zn released from the Zn finger protein domains and developed a disease which is known as xeroderma pigmentosum (XPA) (Zeng, Uthus and Combs 2005). Base on the previous findings, the  $MMA^V$  and  $DMA^V$  are more reactive as compared with  $As^{III}$  (Zeng, Uthus and Combs 2005, Blessing, Kraus, Heindl, Bal and Hartwig 2004, Hartwig, Blessing, Schwerdtle and Walter 2003). During uphold genomic stability process, the Zn finger proteins usually required in almost every intracellular reactions, therefore, the inactivation or inhibition of these proteins may enhance the genomic instability (Hamilton 2004).

While, several studies conducted to elucidate the effects of As and Se on cellular transduction signals (Zeng 2001, Yang and Frenkel 2002, Qian, Castranova and Shi 2003). Arsenic activated, different cellular signals pathways such as mitogen-activated protein kinase (MAPK), ROS, and nuclear factor- $\kappa$ B (NF $\kappa$ B) signaling pathways (Blessing, Kraus,

Heindl, Bal and Hartwig 2004, Zeng 2001). Activation protein-1 (AP-1) and NFκB are illustrative members of two diverse families of the heterodimeric transcriptional complexes, which induced changes in gene expression (Zeng, Uthus and Combs Jr 2005). Several studies demonstrated that As<sup>III</sup> and As<sup>V</sup> induced protein expression and increased AP-1 and NFκB DNA binding sites (Flora 2011, Arita and Costa 2009). However, various studies also demonstrated that the Se and Se containing compounds, reduced the oxidation related JNK AP-1 and NFκB in cellular activation process (Chauke 2013, József and Filep 2003). Now it has been proved globally that the As<sup>III</sup> is more toxic and carcinogenic than As<sup>V</sup> (Ali, Aslam, Feng, Junaid, Ali, Li, Chen, Yu, Rasool and Zhang 2019b). However, several studies reported that the methylated arsenicals such as MAs<sup>III</sup> and DMAs<sup>III</sup> have more potential than As<sup>III</sup> in the activation of the AP-1 (Wang, Thomas and Naranmandura 2015, Drobná, Jaspers, Thomas and STÝBLO 2003).

The cellular stress proteins are well known as a C-Jun N-terminal kinase (JNK) is a member of a stress-activated protein kinase family activated through cellular stress. Arsenic activated the AP-1 activity through inhibiting the JNK tyrosine phosphate protein (Fig.7), the result of the activation of JNK/AP-1, defected in the turning off activated JNK (Cowan and Storey 2003, Zarubin and Jiahuai 2005). That is why As<sup>III</sup> and As<sup>V</sup> induced apoptosis *via* the JNK pathway (Eguchi, Fujimori, Takeda, Tabata, Ohta, Kuribayashi, Fukuoka and Nakano 2011). Potent antagonistic effects between As and Se at the cellular level can cause cell apoptosis as well as cell necrosis in human leukemia (HL-60) through incubation with Na<sub>2</sub>SeO<sub>3</sub> and NaASO<sub>2</sub>/Na<sub>2</sub>-HASO<sub>4</sub> (Zeng, Uthus and Combs 2005, Zeng 2001). Presence of mineral induced HL-60 cells apoptosis concentration Se<sup>IV</sup> (3μM) > As<sup>III</sup> (50μM) > As<sup>V</sup> (50μM) higher as compared with cell apoptosis causing cell necrosis (Drobná, Jaspers, Thomas and Stýblo 2003). However, the elevated concentration of Se<sup>IV</sup>, causing toxic necrotic effects and these effects, may have suppressed or neutralized by As<sup>III</sup> or As<sup>V</sup> (Zeng 2001).

Selenium compounds such as methylene (1,4-phenylene bis), selenocyanate (p-XSC), selenocysteine, selenomethionine, and ebselen inhibiting or suppressed the DNA binding activities for the transcription factor of NFκB and AP-1 (Woo Youn, Fiala and Soon Sohn 2001, József and Filep 2003). Arsenic activated NFκB and AP-1 inhibitor or suppressed by Se, while the As inhibited or suppressed Se toxic necrotic effect (Sun, Rathinasabapathi,

Wu, Luo, Pu and Ma 2014). These scientific insights were demonstrating that Se plays an essential function as endogenous “stop cellular signals” for As induced cancer-causing cell signaling (Zeng, Uthus and Combs 2005).

### Figure 7

#### **8. Arsenic and selenium remediation/phytoremediation and handling of harvested biomass**

Arsenic induced plants, animals, and humans toxicity, whereas Se exhibited dual role (essential & toxic) both its deficiency and toxicity are considered as a severe problem worldwide (Bastías and Beldarrain 2016, Shahid, Niazi, Khalid, Murtaza, Bibi and Rashid 2018). In the case of Se deficient soils, the application of Se amended fertilizers is a common and best conceivable management strategy adopted in different Se in soil deficient countries (Shahid, Niazi, Khalid, Murtaza, Bibi and Rashid 2018). Several studies reported the As and Se contaminated soils, especially in various regions of China, and the USA (Khanam, Kumar, Nayak, Shahid, Tripathi, Vijayakumar, Bhaduri, Kumar, Mohanty and Panneerselvam 2019). With the advancement of science, technology, and research, several techniques based on diverse mechanisms or processes have been developed to remediate these metals from environmental matrices (Shahid, Niazi, Khalid, Murtaza, Bibi and Rashid 2018, Tanmoy and Saha 2019).

Phytoremediation, a plant-based green technology widely adopted and received cumulative consideration worldwide. Afterward, the discovery of hyperaccumulating plants was significant progress, in which plants can uptake, accumulate, and translocate the elevated concentrations of various toxic metals in their harvestable biomass (Rahman and Hasegawa 2011). Hyperaccumulator plants are reported as a very efficient, economical, and eco-friendly technique to remediated metals from contaminated soils (Ali, Khan and Sajad 2013, Rizwan, Ali, ur Rehman, Rinklebe, Tsang, Bashir, Maqbool, Tack and Ok 2018). Phytoremediation includes several consecutive steps such as Phytoextraction, Phytodegradation, Rhizofiltration, Phytostabilization, Phytovolatilization. Both aquatic and terrestrial plants have been confirmed to remediate metals contaminated waters and soils, respectively (Rahman and Hasegawa 2011).

In an As contamination case, the use of hyperaccumulator plants such as fern, *Pteris vittata*, has been suggested (Bastías and Beldarrain 2016). However, the significant

limitation of this method is that the plants absorbed As without using it, and transferred back to the food chain system (Singh, Singh, Parihar, Singh and Prasad 2015). Fungai can also offset As toxicity *via* transforming the organic form with reduced toxicity (Bastías and Beldarrain 2016). The basic behaviors of *Glomus geosporum* (*Gg*), *G. versiforme* (*Gv*), and *G. mosseae* (*Gm*) are considered to decrease As absorption mainly by rice plants; it was reported that species, taken distinctly or diverse, might be used because the concentration of As decreases in all conditions (Chan, Li, Wu, Wu and Wong 2013).

Similar to As, nearly 30 different kinds of plant species of Fabaceae, Brassicaceae, and Asteraceae families are reported that can hyperaccumulate and tolerate high concentrations of Se from soil-system (Shahid, Niazi, Khalid, Murtaza, Bibi and Rashid 2018, Winkel, Vriens, Jones, Schneider, Pilon-Smits and Bañuelos 2015). Several studies reported that the use of genetically modified plants efficiently increases Se uptake, accumulation, tolerance, and volatilization (Shahid, Niazi, Khalid, Murtaza, Bibi and Rashid 2018, Pilon-Smits and LeDuc 2009). Different remediation technologies suggested the application of hybrid plants, which are genetically modified with remediation physiognomies, are efficiently used to remediate specific or miscellaneous metals from polluted soil (Shahid, Dumat, Khalid, Schreck, Xiong and Niazi 2017). Some studies, particularly in urban agricultural soil-system, purposed a wise use of plants through adopting various crop rotation systems (Shahid, Niazi, Khalid, Murtaza, Bibi and Rashid 2018, Xiong, Austruy, Pierart, Shahid, Schreck, Mombo and Dumat 2016). The genetically modified plants increase Se uptake and accumulation by plants significantly reviewed earlier in some studies (Pilon-Smits and LeDuc 2009, Terry, Zayed, De Souza and Tarun 2000).

Phytoremediation of metals, such as As and Se, from contaminated soil, is likely to decrease the concentrations of metals in the soil-system and reduces environmental risks (Ye, Khan, McGrath and Zhao 2011, Wu, Bañuelos, Lin, Liu, Yuan, Yin and Li 2015). Metals are sequestered in plants aboveground biomass is classified as hazardous waste, leading to wide-ranging ecological risk (Rizwan, Ali, ur Rehman, Rinklebe, Tsang, Bashir, Maqbool, Tack and Ok 2018, Rizwan, Ali, Adrees, Ibrahim, Tsang, Zia-ur-Rehman, Zahir, Rinklebe, Tack and Ok 2017). Hence, appropriate handling of biomass either recycled or disposed of, is crucial to avoid secondary contamination and prevent potential risks (Rizwan, Ali, ur Rehman, Rinklebe, Tsang, Bashir, Maqbool, Tack and Ok 2018).

Depending on defined regulations and existing metal concentration in plants, the contaminated biomass needs to be landfill or metals reclaimed by smelting, pyrolysis of biomass, and extraction (da Conceição Gomes, Hauser-Davis, de Souza and Vitória 2016). If plants first incinerated (i.e., combustion & gasification), the subsequent ash must be disposed of in hazardous waste landfill, though the ash volume is approximately < 10% of the total volume that might be created if the polluted soil itself excavated for treatment, still being beneficial in this regard (da Conceição Gomes, Hauser-Davis, de Souza and Vitória 2016).

The combustion technology for biomass disposal generally used for energy production at both domestic and industrial levels, but the burning of metals polluted biomass in conventional firing systems is not appropriate because it may pose a severe environmental risk (Rizwan, Ali, ur Rehman, Rinklebe, Tsang, Bashir, Maqbool, Tack and Ok 2018). Pyrolyzed metal-contaminated biomass obtained the phytoremediation process afterward. Pyrolysis stabilized potentially toxic metals, and the pyrolyzed material could adsorb the dye, such as methylene blue. Several researchers suggested that biomass obtained from contaminated sites might be further utilized for the adsorption of dye afterward pyrolysis. Overall, the biomass of plants after harvesting obtained from As and Se polluted soil might be treated to avoid secondary pollution and the energy. Besides, the substance obtained from this process can be further utilized.

## **9. Conclusion and future research perspectives**

The current review highlighted the critical biogeochemical mechanisms of As and Se in the soil-plant system and focused on the insights of interaction between As and Se and their mechanisms of inducing toxicity in animals and humans.

The reduction of As<sup>V</sup> to As<sup>III</sup> can occur in-between redox potential, which leads to the mobilization of As<sup>III</sup> into soil solution and increases its availability to plants. Arsenic uptake in plant cells depends on As species such as As<sup>V</sup> uses phosphate as a transporter that is chemically similar to As<sup>V</sup>, whereas As<sup>III</sup> uses Si as transporters. The molecular and biochemical effects of As in plants system occurred in two ways, 1) the direct inactivation of essential enzymes, either through sulfhydryl groups interaction or replacement of compulsory ions from the enzyme active sites, and 2) the indirect spurt of ROS consequently in a cascade of irretrievable damages.



Though  $\text{Se}^{\text{IV}}$  and  $\text{Se}^{\text{VI}}$  transported through phosphate and sulfate channels, respectively. Selenosis took place in plants by two mechanisms 1) malformed selenoprotein induced plant toxicity, and 2) ROS induced Se toxicity. Malformed selenoprotein toxicity in plants occurs in the protein chain by replacement of SeCys or SeMet with that of Cys or Met.

Arsenic and Se induce cytotoxicity and genotoxicity in animals and humans through ROS generation, which ultimately affects DNA repairing and gene regulation. Under reducible conditions, the low Se concentration inhibits the DNA regulation process because it creates inactivation of DNA repair proteins. Arsenite and  $\text{Se}^{\text{IV}}$  did not wholly transfer through aquaglyceroporins, albeit both are very toxic due to their metabolic process associated with GSH and SAM. Likewise, low levels of Se compounds can constrain the Zn finger protein that binds to and release of Zn from the motif of the zinc finger.

Inhibition of  $\text{Se}^{\text{IV}}$  by  $\text{As}^{\text{III}}$  during gastrointestinal absorption resulted from antagonistic interaction between  $\text{As}^{\text{III}}$  and  $\text{Se}^{\text{IV}}$ . Immediate  $\text{As}^{\text{III}}$  contamination inhibited the excretion of pulmonary  $(\text{CH}_3)_2\text{Se}$  in animals/rats and hamsters. At low concentrations, Se formed complexes with As such as  $((\text{GS}_3)_2\text{AsSe})$ , due to insufficient Se interaction with  $\text{As}^{\text{III}}\text{MT}$  content. While, the elevated concentration of As in the form of  $\text{MMA}^{\text{V}}$  and  $\text{DMA}^{\text{V}}$  can form incomplete complexes  $((\text{GS}_3)_2\text{AsSe})$  and retain more As and MMA in a biological system, which can cause severe toxicity to animals and humans.

Though a large number of efforts have been made to understand insights interaction mechanisms between As and Se and associated toxicity in plants, animals, and humans, further research should be carried out aiming to save crop production and reduced animals and human toxicity. This should include the following research perspectives:

- Pilot studies are required to investigate As and Se detoxification mechanisms in the soil-plant system, animals, and humans.
- Long-term stability of toxicity and insights on the interactions between As and Se in the soil-plant system, animals, and humans still need to be further studied.
- Insights interaction mechanisms between As and Se in the aquatic ecosystem cause extended ecological risks and genotoxicity for aquatic life; therefore, warranted further investigations.

- The scientific community should pay more attention to insights mechanisms involved in As and Se interactions in various biological matrices and associated outcomes to further regularize the rational use and potential intake of these elements.

## 10. Acknowledgments

This work is supported by the National Science Foundation of China-Project of Karst Science Research Center (U1612442), Science and Technology Program of Guizhou Province [Grant No. Qiankehepingtairencai (2019)5618, Grant No. Qiankehezhicheng 2019(2963), and Grant No. QiankeheChengguo (2019)4428], STS project of Chinese Academy of Sciences (KFJ-STQ-QYZD-185), National Key R&D Program of China (No. 2017YFD0800302), Financial support from National Key Research and Development Program of China (No. 2019 YFC1803600), and Opening fund of State Key Laboratory of Environmental Geochemistry (SKLEG2019606, 2019717).

## 11. Conflict of Interest

The authors have no conflict of interest.

## 12. References

- Abbas, G., Murtaza, B., Bibi, I., Shahid, M., Niazi, N.K., Khan, M.I., Amjad, M. and Hussain, M. (2018). Arsenic uptake, toxicity, detoxification, and speciation in plants: physiological, biochemical, and molecular aspects. *International journal of environmental research and public health* 15, 59.
- Abhyankar, L.N., Jones, M.R., Guallar, E. and Navas-Acien, A. (2011). Arsenic exposure and hypertension: a systematic review. *Environmental health perspectives* 120, 494-500.
- Abul-Hassan, K.S., Lehnert, B.E., Guant, L. and Walmsley, R. (2004). Abnormal DNA repair in selenium-treated human cells. *Mutation Research/Genetic Toxicology and Environmental Mutagenesis* 565, 45-51.
- Akay, C., Thomas III, C. and Gazitt, Y. (2004). Arsenic trioxide and paclitaxel induce apoptosis by different mechanism. *Cell Cycle* 3, 322-332.

- Ali, H., Khan, E. and Sajad, M.A. (2013). Phytoremediation of heavy metals—concepts and applications. *Chemosphere* 91, 869-881.
- Ali, W., Aslam, M.W., Feng, C., Junaid, M., Ali, K., Li, S., Chen, Z., Yu, Z., Rasool, A. and Zhang, H. (2019). Unraveling prevalence and public health risks of arsenic, uranium and co-occurring trace metals in groundwater along riverine ecosystem in Sindh and Punjab, Pakistan. *Environmental Geochemistry and Health* 41, 2223-2238.
- Ali, W., Isayenkov, S.V., Zhao, F.-J. and Maathuis, F.J. (2009). Arsenite transport in plants. *Cellular and molecular life sciences* 66, 2329-2339.
- Ali, W., Mushtaq, N., Javed, T., Zhang, H., Ali, K., Rasool, A. and Farooqi, A. (2019). Vertical mixing with return irrigation water the cause of arsenic enrichment in groundwater of district Larkana Sindh, Pakistan. *Environmental pollution* 245, 77-88.
- Andrew, A.S., Burgess, J.L., Meza, M.M., Demidenko, E., Waugh, M.G., Hamilton, J.W. and Karagas, M.R. (2006). Arsenic exposure is associated with decreased DNA repair in vitro and in individuals exposed to drinking water arsenic. *Environmental health perspectives* 114, 1193-1198.
- Andrew, A.S., Karagas, M.R. and Hamilton, J.W. (2003). Decreased DNA repair gene expression among individuals exposed to arsenic in United States drinking water. *International journal of cancer* 104, 263-268.
- Arita, A. and Costa, M. (2009). Epigenetics in metal carcinogenesis: nickel, arsenic, chromium and cadmium. *Metallomics* 1, 222-228.
- Asati, A., Pichhode, M. and Nikhil, K. (2016). Effect of heavy metals on plants: an overview. *Int. J. Appl. Innov. Eng. Manage* 5, 2319-4847.
- ATSDR, U. (2007). Toxicological Profile for Arsenic. Agency for Toxic Substances and Disease Registry: US Department of Health and Human Services, Centers for Disease Control and ....
- Awasthi, S., Chauhan, R., Srivastava, S. and Tripathi, R.D. (2017). The journey of arsenic from soil to grain in rice. *Frontiers in Plant Science* 8, 1007.

- Balakhnina, T. and Nadezhkina, E. (2017). Effect of selenium on growth and antioxidant capacity of *Triticum aestivum* L. during development of lead-induced oxidative stress. *Russian journal of plant physiology* 64, 215-223.
- Bastías, J.M. and Beldarrain, T. (2016). Arsenic translocation in rice cultivation and its implication for human health. *Chilean journal of agricultural research* 76, 114-122.
- Bergeron, M., Cléménçon, B., Hediger, M. and Markovich, D. (2013). SLC13 family of Na<sup>+</sup>-coupled di- and tri-carboxylate/sulfate transporters. *Molecular aspects of medicine* 34, 299-312.
- Bhattacharjee, P., Banerjee, M. and Giri, A.K. (2013). Role of genomic instability in arsenic-induced carcinogenicity. A review. *Environment international* 53, 29-40.
- Bhattacharya, P., Mukherjee, A.B., Bundschuh, J., Zevenhoven, R. and Loeppert, R.H. (2007). *Arsenic in soil and groundwater environment: biogeochemical interactions, health effects and remediation*: Elsevier.
- Bhattacharya, S., Gupta, K., Debnath, S., Ghosh, U.C., Chattopadhyay, D. and Mukhopadhyay, A. (2012). Arsenic bioaccumulation in rice and edible plants and subsequent transmission through food chain in Bengal basin: a review of the perspectives for environmental health. *Toxicological & Environmental Chemistry* 94, 429-441.
- Bitterli, C., Bañuelos, G. and Schulin, R. (2010). Use of transfer factors to characterize uptake of selenium by plants. *Journal of Geochemical Exploration* 107, 206-216.
- Björnstedt, M., Kumar, S. and Holmgren, A. (1992). Selenodiglutathione is a highly efficient oxidant of reduced thioredoxin and a substrate for mammalian thioredoxin reductase. *Journal of Biological Chemistry* 267, 8030-8034.
- Blessing, H., Kraus, S., Heindl, P., Bal, W. and Hartwig, A. (2004). Interaction of selenium compounds with zinc finger proteins involved in DNA repair. *European journal of biochemistry* 271, 3190-3199.
- Bleys, J., Navas-Acien, A., Laclaustra, M., Pastor-Barriuso, R., Menke, A., Ordovas, J., Stranges, S. and Guallar, E. (2009). Serum selenium and peripheral arterial disease: results from the national health and nutrition examination survey, 2003–2004. *American journal of epidemiology* 169, 996-1003.

- Brammer, H. and Ravenscroft, P. (2009). Arsenic in groundwater: a threat to sustainable agriculture in South and South-east Asia. *Environment international* 35, 647-654.
- Brigelius-Flohé, R. (2008). Selenium compounds and selenoproteins in cancer. *Chemistry & biodiversity* 5, 389-395.
- Brown, K.G. and Ross, G.L. (2002). Arsenic, drinking water, and health: a position paper of the American Council on Science and Health. *Regulatory Toxicology and Pharmacology* 36, 162-174.
- Buchet, J.-P. and Lauwerys, R. (1985). Study of inorganic arsenic methylation by rat liver in vitro: relevance for the interpretation of observations in man. *Archives of toxicology* 57, 125-129.
- Burgess, J.L., Kurzius-Spencer, M., Poplin, G.S., Littau, S.R., Kopplin, M.J., Stürup, S., Boitano, S. and Lantz, R.C. (2014). Environmental arsenic exposure, selenium and sputum alpha-1 antitrypsin. *Journal of exposure science & environmental epidemiology* 24, 150.
- Cappa, J.J., Cappa, P.J., El Mehdawi, A.F., McAleer, J.M., Simmons, M.P. and Pilon-Smits, E.A. (2014). Characterization of selenium and sulfur accumulation across the genus *Stanleya* (Brassicaceae): A field survey and common-garden experiment. *American journal of botany* 101, 830-839.
- Carlin, D.J., Naujokas, M.F., Bradham, K.D., Cowden, J., Heacock, M., Henry, H.F., Lee, J.S., Thomas, D.J., Thompson, C. and Tokar, E.J. (2015). Arsenic and environmental health: state of the science and future research opportunities. *Environmental Health Perspectives* 124, 890-899.
- Challenger, F. (1945). Biological methylation. *Chemical Reviews* 36, 315-361.
- Chan, W., Li, H., Wu, F., Wu, S. and Wong, M.H. (2013). Arsenic uptake in upland rice inoculated with a combination or single arbuscular mycorrhizal fungi. *Journal of Hazardous Materials* 262, 1116-1122.
- Chandrakar, V., Naithani, S.C. and Keshavkant, S. (2016). Arsenic-induced metabolic disturbances and their mitigation mechanisms in crop plants: A review. *Biologia* 71, 367-377.

- Chandrakar, V., Pandey, N. and Keshavkant, S. (2018). Plant Responses to Arsenic Toxicity: Morphology and Physiology *Mechanisms of Arsenic Toxicity and Tolerance in Plants*, 27-48): Springer.
- Chang, C., Yin, R., Wang, X., Shao, S., Chen, C. and Zhang, H. (2019). Selenium translocation in the soil-rice system in the Enshi seleniferous area, Central China. *Science of the Total Environment* 669, 83-90.
- Châtelain, E., Satour, P., Laugier, E., Vu, B.L., Payet, N., Rey, P. and Montrichard, F. (2013). Evidence for participation of the methionine sulfoxide reductase repair system in plant seed longevity. *Proceedings of the National Academy of Sciences* 110, 3633-3638.
- Chauhan, R., Awasthi, S., Srivastava, S., Dwivedi, S., Pilon-Smits, E.A., Dhankher, O.P. and Tripathi, R.D. (2019). Understanding selenium metabolism in plants and its role as a beneficial element. *Critical Reviews in Environmental Science and Technology*, 1-22.
- Chauke, T.L. (2013). Evaluating the efficacy, safety and possible mechanism of action of potassium humate with selenium: University of Pretoria.
- Chen, Q., Wang, Z., Xiong, Y., Zou, X. and Liu, Z. (2010). Comparative study of p38 MAPK signal transduction pathway of peripheral blood mononuclear cells from patients with coal-combustion-type fluorosis with and without high hair selenium levels. *International journal of hygiene and environmental health* 213, 381-386.
- Chen, Y. and Maret, W. (2001). Catalytic oxidation of zinc/sulfur coordination sites in proteins by selenium compounds. *Antioxidants and Redox Signaling* 3, 651-656.
- Chen, Y., Han, Y.-H., Cao, Y., Zhu, Y.-G., Rathinasabapathi, B. and Ma, L.Q. (2017). Arsenic transport in rice and biological solutions to reduce arsenic risk from rice. *Frontiers in Plant Science* 8, 268.
- Chitta, K.R., Figueroa, J.A.L., Caruso, J.A. and Merino, E.J. (2013). Selenium mediated arsenic toxicity modifies cytotoxicity, reactive oxygen species and phosphorylated proteins. *Metallomics* 5, 673-685.
- Chou, W.-C., Jie, C., Kenedy, A.A., Jones, R.J., Trush, M.A. and Dang, C.V. (2004). Role of NADPH oxidase in arsenic-induced reactive oxygen species formation

- and cytotoxicity in myeloid leukemia cells. *Proceedings of the National Academy of Sciences* 101, 4578-4583.
- Chowdhury, R., Chowdhury, S., Roychoudhury, P., Mandal, C. and Chaudhuri, K. (2009). Arsenic induced apoptosis in malignant melanoma cells is enhanced by menadione through ROS generation, p38 signaling and p53 activation. *Apoptosis* 14, 108-123.
- Christian, W.J., Hopenhayn, C., Centeno, J.A. and Todorov, T. (2006). Distribution of urinary selenium and arsenic among pregnant women exposed to arsenic in drinking water. *Environmental research* 100, 115-122.
- Constantinescu-Aruxandei, D., Frîncu, R., Capră, L. and Oancea, F. (2018). Selenium analysis and speciation in dietary supplements based on next-generation selenium ingredients. *Nutrients* 10, 1466.
- Cowan, K.J. and Storey, K.B. (2003). Mitogen-activated protein kinases: new signaling pathways functioning in cellular responses to environmental stress. *Journal of Experimental Biology* 206, 1107-1115.
- Crighton, D., Wilkinson, S., O'Prey, J., Syed, N., Smith, P., Harrison, P.R., Gasco, M., Garrone, O., Crook, T. and Ryan, K.M. (2006). DRAM, a p53-induced modulator of autophagy, is critical for apoptosis. *Cell* 126, 121-134.
- Da Conceição Gomes, M.A., Hauser-Davis, R.A., de Souza, A.N. and Vitória, A.P. (2016). Metal phytoremediation: General strategies, genetically modified plants and applications in metal nanoparticle contamination. *Ecotoxicology and environmental safety* 134, 133-147.
- Das, K. and Roychoudhury, A. (2014). Reactive oxygen species (ROS) and response of antioxidants as ROS-scavengers during environmental stress in plants. *Frontiers in Environmental Science* 2, 53.
- De Temmerman, L., Waegeneers, N., Thiry, C., Du Laing, G., Tack, F. and Ruttens, A. (2014). Selenium content of Belgian cultivated soils and its uptake by field crops and vegetables. *Science of the Total Environment* 468, 77-82.
- Deavall, D.G., Martin, E.A., Horner, J.M. and Roberts, R. (2012). Drug-induced oxidative stress and toxicity. *Journal of toxicology* 2012.

- Devesa, V., Del Razo, L.M., Adair, B., Drobná, Z., Waters, S.B., Hughes, M.F., Stýblo, M. and Thomas, D.J. (2004). Comprehensive analysis of arsenic metabolites by pH-specific hydride generation atomic absorption spectrometry. *Journal of Analytical Atomic Spectrometry* 19, 1460-1467.
- Douillet, C., Currier, J., Saunders, J., Bodnar, W.M., Matoušek, T. and Stýblo, M. (2013). Methylated trivalent arsenicals are potent inhibitors of glucose stimulated insulin secretion by murine pancreatic islets. *Toxicology and applied pharmacology* 267, 11-15.
- Drobná, Z., Jaspers, I., Thomas, D.J. and STÝBLO, M. (2003). Differential activation of AP-1 in human bladder epithelial cells by inorganic and methylated arsenicals. *The FASEB Journal* 17, 67-69.
- Eguchi, R., Fujimori, Y., Takeda, H., Tabata, C., Ohta, T., Kuribayashi, K., Fukuoka, K. and Nakano, T. (2011). Arsenic trioxide induces apoptosis through JNK and ERK in human mesothelioma cells. *Journal of cellular physiology* 226, 762-768.
- Feng, R., Wei, C. and Tu, S. (2013). The roles of selenium in protecting plants against abiotic stresses. *Environmental and Experimental Botany* 87, 58-68.
- Fernández-Martínez, A. and Charlet, L. (2009). Selenium environmental cycling and bioavailability: a structural chemist point of view. *Reviews in Environmental Science and Bio/Technology* 8, 81-110.
- Finnegan, P. and Chen, W. (2012). Arsenic toxicity: the effects on plant metabolism. *Frontiers in physiology* 3, 182.
- Fleury, C., Mignotte, B. and Vayssière, J.-L. (2002). Mitochondrial reactive oxygen species in cell death signaling. *Biochimie* 84, 131-141.
- Flora, S.J. (2011). Arsenic-induced oxidative stress and its reversibility. *Free Radical Biology and Medicine* 51, 257-281.
- Fordyce, F.M. (2013). Selenium deficiency and toxicity in the environment *Essentials of medical geology*, 375-416): Springer.
- Frohne, T., Rinklebe, J., Diaz-Bone, R.A. and Du Laing, G. (2011). Controlled variation of redox conditions in a floodplain soil: impact on metal mobilization and biomethylation of arsenic and antimony. *Geoderma* 160, 414-424.



- Gailer, J. (2002). Review: Reactive selenium metabolites as targets of toxic metals/metalloids in mammals: a molecular toxicological perspective. *Applied organometallic chemistry* 16, 701-707.
- Gailer, J. (2007). Arsenic–selenium and mercury–selenium bonds in biology. *Coordination Chemistry Reviews* 251, 234-254.
- Gailer, J., George, G.N., Harris, H.H., Pickering, I.J., Prince, R.C., Somogyi, A., Buttigieg, G.A., Glass, R.S. and Denton, M.B. (2002). Synthesis, purification, and structural characterization of the dimethyldiselenoarsinate anion. *Inorganic chemistry* 41, 5426-5432.
- Gailer, J., George, G.N., Pickering, I.J., Prince, R.C., Younis, H.S. and Winzerling, J. (2002). Biliary excretion of [(GS) 2AsSe]-after intravenous injection of rabbits with arsenite and selenate. *Chemical research in toxicology* 15, 1466-1471.
- Gailer, J., Ruprecht, L., Reitmeir, P., Benker, B. and Schramel, P. (2004). Mobilization of exogenous and endogenous selenium to bile after the intravenous administration of environmentally relevant doses of arsenite to rabbits. *Applied organometallic chemistry* 18, 670-675.
- Ganyc, D., Talbot, S., Konate, F., Jackson, S., Schanen, B., Cullen, W. and Self, W.T. (2006). Impact of trivalent arsenicals on selenoprotein synthesis. *Environmental health perspectives* 115, 346-353.
- Garg, N. and Singla, P. (2011). Arsenic toxicity in crop plants: physiological effects and tolerance mechanisms. *Environmental Chemistry Letters* 9, 303-321.
- Gaxiola-Robles, R., Labrada-Martagón, V., Acosta-Vargas, B., Méndez-Rodríguez, L.C. and Zenteno-Savín, T. (2014). Interaction between mercury (Hg), arsenic (As) and selenium (Se) affects the activity of glutathione S-transferase in breast milk; possible relationship with fish and shellfish intake. *Nutricion hospitalaria* 30, 436-446.
- Ghosh, J. and Sil, P.C. (2015). Mechanism for arsenic-induced toxic effects *Handbook of Arsenic Toxicology*, 203-231): Elsevier.
- Golob, A., Gadžo, D., Stibilj, V., Djikić, M., Gavrić, T., Kreft, I. and Germ, M. (2016). Sulphur interferes with selenium accumulation in Tartary buckwheat plants. *Plant physiology and biochemistry* 108, 32-36.

- Gromer, S., Eubel, J., Lee, B. and Jacob, J. (2005). Human selenoproteins at a glance. *Cellular and Molecular Life Sciences CMLS* 62, 2414-2437.
- Gupta, M. and Gupta, S. (2017). An overview of selenium uptake, metabolism, and toxicity in plants. *Frontiers in Plant Science* 7, 2074.
- Gupta, M. and Khan, E. (2015). Mechanism of arsenic toxicity and tolerance in plants: role of silicon and signalling molecules *Stress responses in Plants*, 143-157): Springer.
- Hamilton, S.J. (2004). Review of selenium toxicity in the aquatic food chain. *Science of the Total Environment* 326, 1-31.
- Harper, L.K., Antony, S. and Bayse, C.A. (2014). Thiol Reduction of Arsenite and Selenite: DFT Modeling of the Pathways to an As–Se Bond. *Chemical research in toxicology* 27, 2119-2127.
- Hartikainen, H. (2005). Biogeochemistry of selenium and its impact on food chain quality and human health. *Journal of Trace elements in Medicine and Biology* 18, 309-318.
- Hartwig, A. (2001). Zinc finger proteins as potential targets for toxic metal ions: differential effects on structure and function. *Antioxidants and Redox Signaling* 3, 625-634.
- Hartwig, A., Blessing, H., Schwerdtle, T. and Walter, I. (2003). Modulation of DNA repair processes by arsenic and selenium compounds. *Toxicology* 193, 161-169.
- Hasanuzzaman, M., Nahar, K. and Fujita, M. (2013). Extreme temperature responses, oxidative stress and antioxidant defense in plants. *Abiotic stress-Plant responses and applications in agriculture*, 169-205.
- Hawkesford, M.J. and De Kok, L.J. (2006). Managing sulphur metabolism in plants. *Plant, Cell & Environment* 29, 382-395.
- Hayakawa, T., Kobayashi, Y., Cui, X. and Hirano, S. (2005). A new metabolic pathway of arsenite: arsenic–glutathione complexes are substrates for human arsenic methyltransferase Cyt19. *Archives of toxicology* 79, 183-191.
- Hering, J.G., Burris, D., Reisinger, H. and O'Day, P. (2008). Environmental fate and exposure assessment for Arsenic in Groundwater.

- Hettick, B.E., Canas-Carrell, J.E., French, A.D. and Klein, D.M. (2015). Arsenic: a review of the element's toxicity, plant interactions, and potential methods of remediation. *Journal of agricultural and food chemistry* 63, 7097-7107.
- Hondal, R.J., Marino, S.M. and Gladyshev, V.N. (2013). Selenocysteine in thiol/disulfide-like exchange reactions. *Antioxidants & redox signaling* 18, 1675-1689.
- Hsueh, Y.-M., Ko, Y.-F., Huang, Y.-K., Chen, H.-W., Chiou, H.-Y., Huang, Y.-L., Yang, M.-H. and Chen, C.-J. (2003). Determinants of inorganic arsenic methylation capability among residents of the Lanyang Basin, Taiwan: arsenic and selenium exposure and alcohol consumption. *Toxicology letters* 137, 49-63.
- Huang, J.-H. (2014). Impact of microorganisms on arsenic biogeochemistry: a review. *Water, Air, & Soil Pollution* 225, 1848.
- Huang, Y.-Z., Hu, Y. and Liu, Y.-X. (2007). Interactions between sulfur and selenium uptake by corn in solution culture. *Journal of plant nutrition* 31, 43-54.
- Hughes, M.F. (2002). Arsenic toxicity and potential mechanisms of action. *Toxicology letters* 133, 1-16.
- Hughes, M.F., Beck, B.D., Chen, Y., Lewis, A.S. and Thomas, D.J. (2011). Arsenic exposure and toxicology: a historical perspective. *Toxicological Sciences* 123, 305-332.
- Hugouvieux, V., Dutilleul, C., Jourdain, A., Reynaud, F., Lopez, V. and Bourguignon, J. (2009). Arabidopsis putative selenium-binding protein1 expression is tightly linked to cellular sulfur demand and can reduce sensitivity to stresses requiring glutathione for tolerance. *Plant physiology* 151, 768-781.
- Jacob, C., Giles, G.I., Giles, N.M. and Sies, H. (2003). Sulfur and selenium: the role of oxidation state in protein structure and function. *Angewandte Chemie International Edition* 42, 4742-4758.
- Jain, C. and Ali, I. (2000). Arsenic: occurrence, toxicity and speciation techniques. *Water Research* 34, 4304-4312.
- Jomova, K., Jenisova, Z., Feszterova, M., Baros, S., Liska, J., Hudecova, D., Rhodes, C. and Valko, M. (2011). Arsenic: toxicity, oxidative stress and human disease. *Journal of Applied Toxicology* 31, 95-107.

- Jones, G.D., Droz, B., Greve, P., Gottschalk, P., Poffet, D., McGrath, S.P., Seneviratne, S.I., Smith, P. and Winkel, L.H. (2017). Selenium deficiency risk predicted to increase under future climate change. *Proceedings of the National Academy of Sciences* 114, 2848-2853.
- Jornstedt, M.B., Kumar, S. and Holmgren, A. (1995). [22] Selenite and selenodiglutathione: Reactions with thioredoxin systems. *Methods in enzymology* 252, 209-219.
- Joseph, J. and Loscalzo, J. (2013). Selenistasis: epistatic effects of selenium on cardiovascular phenotype. *Nutrients* 5, 340-358.
- József, L. and Filep, J.G. (2003). Selenium-containing compounds attenuate peroxynitrite-mediated NF- $\kappa$ B and AP-1 activation and interleukin-8 gene and protein expression in human leukocytes. *Free Radical Biology and Medicine* 35, 1018-1027.
- Khalid, S., Shahid, M., Niazi, N.K., Rafiq, M., Bakhat, H.F., Imran, M., Abbas, T., Bibi, I. and Dumat, C. (2017). Arsenic behaviour in soil-plant system: Biogeochemical reactions and chemical speciation influences *Enhancing Cleanup of Environmental Pollutants*, 97-140): Springer.
- Khanam, R., Kumar, A., Nayak, A., Shahid, M., Tripathi, R., Vijayakumar, S., Bhaduri, D., Kumar, U., Mohanty, S. and Panneerselvam, P. (2019). Metal (loid) s (As, Hg, Se, Pb and Cd) in paddy soil: Bioavailability and potential risk to human health. *Science of the Total Environment*, 134330.
- Kim, E.H., Sohn, S., Kwon, H.J., Kim, S.U., Kim, M.-J., Lee, S.-J. and Choi, K.S. (2007). Sodium selenite induces superoxide-mediated mitochondrial damage and subsequent autophagic cell death in malignant glioma cells. *Cancer research* 67, 6314-6324.
- Kim, T.-s., Jeong, D.-w., Yun, B.Y. and Kim, I.Y. (2002). Dysfunction of rat liver mitochondria by selenite: induction of mitochondrial permeability transition through thiol-oxidation. *Biochemical and biophysical research communications* 294, 1130-1137.
- Kircelli, F., Akay, C. and Gazitt, Y. (2007). Arsenic trioxide induces p53-dependent apoptotic signals in myeloma cells with SiRNA-silenced p53: MAP kinase

- pathway is preferentially activated in cells expressing inactivated p53. *International journal of oncology* 30, 993-1001.
- Klaunig, J.E. and Kamendulis, L.M. (2004). The role of oxidative stress in carcinogenesis. *Annu. Rev. Pharmacol. Toxicol.* 44, 239-267.
- Klug, A. (2010). The discovery of zinc fingers and their applications in gene regulation and genome manipulation. *Annual review of biochemistry* 79, 213-231.
- Kofroňová, M., Mašková, P. and Lipavská, H. (2018). Two facets of world arsenic problem solution: crop poisoning restriction and enforcement of phytoremediation. *Planta* 248, 19-35.
- Kojima, C., Ramirez, D.C., Tokar, E.J., Himeno, S., Drobná, Z., Stýblo, M., Mason, R.P. and Waalkes, M.P. (2009). Requirement of arsenic biomethylation for oxidative DNA damage. *Journal of the National Cancer Institute.*
- La Porte, P.F. (2011). *Selenium in the detoxification of arsenic: Mechanisms and clinical efficacy*: The University of Chicago.
- Lai, R., Wang, Y., Li, X. and Yu, R. (2008). Effect of selenium and arsenic on oxidative stress, DNA oxidative damage and repair in HepG2 cells. *Wei sheng yan jiu= Journal of hygiene research* 37, 645-648.
- Laity, J.H., Lee, B.M. and Wright, P.E. (2001). Zinc finger proteins: new insights into structural and functional diversity. *Current opinion in structural biology* 11, 39-46.
- Larabee, J.L., Hocker, J.R. and Hanas, J.S. (2009). Mechanisms of inhibition of zinc-finger transcription factors by selenium compounds ebselen and selenite. *Journal of inorganic biochemistry* 103, 419-426.
- Letavayova, L., Vlčková, V. and Brozmanova, J. (2006). Selenium: from cancer prevention to DNA damage. *Toxicology* 227, 1-14.
- Levander, O.A. (1977). Metabolic interrelationships between arsenic and selenium. *Environmental Health Perspectives* 19, 159.
- Lin, L., Zhou, W., Dai, H., Cao, F., Zhang, G. and Wu, F. (2012). Selenium reduces cadmium uptake and mitigates cadmium toxicity in rice. *Journal of Hazardous Materials* 235, 343-351.

- Liu, J., Yin, M., Zhang, W., Tsang, D.C., Wei, X., Zhou, Y., Xiao, T., Wang, J., Dong, X. and Sun, Y. (2019). Response of microbial communities and interactions to thallium in contaminated sediments near a pyrite mining area. *Environmental pollution* 248, 916-928.
- Liu, Z., Shen, J., Carbrey, J.M., Mukhopadhyay, R., Agre, P. and Rosen, B.P. (2002). Arsenite transport by mammalian aquaglyceroporins AQP7 and AQP9. *Proceedings of the National Academy of Sciences* 99, 6053-6058.
- Lozano, G. and Elledge, S.J. (2000). Cancer: p53 sends nucleotides to repair DNA. *Nature* 404, 24-25.
- Lu, J. and Jiang, C. (2001). Antiangiogenic activity of selenium in cancer chemoprevention: metabolite-specific effects. *Nutrition and cancer* 40, 64-73.
- Ma, J.F. and Yamaji, N. (2008). Functions and transport of silicon in plants. *Cellular and molecular life sciences* 65, 3049-3057.
- Maiti, S. (2015). Arsenic-induced mutagenesis and carcinogenesis: A possible mechanism *Handbook of arsenic toxicology*, 233-279): Elsevier.
- Manley, S.A., George, G.N., Pickering, I.J., Glass, R.S., Prenner, E.J., Yamdagni, R., Wu, Q. and Gailer, J. (2006). The seleno bis (S-glutathionyl) arsinium ion is assembled in erythrocyte lysate. *Chemical research in toxicology* 19, 601-607.
- Maret, W. (2003). Cellular zinc and redox states converge in the metallothionein/thionein pair. *The Journal of nutrition* 133, 1460S-1462S.
- Maritim, A., Sanders, a. and Watkins, r.J. (2003). Diabetes, oxidative stress, and antioxidants: a review. *Journal of biochemical and molecular toxicology* 17, 24-38.
- Mazej, D., Osvald, J. and Stibilj, V. (2008). Selenium species in leaves of chicory, dandelion, lamb's lettuce and parsley. *Food Chemistry* 107, 75-83.
- McKenzie, R.C., Arthur, J.R. and Beckett, G.J. (2002). Selenium and the regulation of cell signaling, growth, and survival: molecular and mechanistic aspects. *Antioxidants and Redox Signaling* 4, 339-351.
- Messarah, M., Klibet, F., Boumendjel, A., Abdennour, C., Bouzerna, N., Boulakoud, M.S. and El Feki, A. (2012). Hepatoprotective role and antioxidant capacity of

- selenium on arsenic-induced liver injury in rats. *Experimental and toxicologic pathology* 64, 167-174.
- Moreno-Jiménez, E., Esteban, E. and Peñalosa, J.M. (2012). The fate of arsenic in soil-plant systems *Reviews of environmental contamination and toxicology*, 1-37): Springer.
- Moriarty-Craige, S.E. and Jones, D.P. (2004). Extracellular thiols and thiol/disulfide redox in metabolism. *Annu. Rev. Nutr.* 24, 481-509.
- Naranmandura, H., Suzuki, N. and Suzuki, K.T. (2006). Trivalent arsenicals are bound to proteins during reductive methylation. *Chemical research in toxicology* 19, 1010-1018.
- Naujokas, M.F., Anderson, B., Ahsan, H., Aposhian, H.V., Graziano, J.H., Thompson, C. and Suk, W.A. (2013). The broad scope of health effects from chronic arsenic exposure: update on a worldwide public health problem. *Environmental health perspectives* 121, 295-302.
- Navarro-Alarcon, M. and Cabrera-Vique, C. (2008). Selenium in food and the human body: a review. *Science of the Total Environment* 400, 115-141.
- Navas-Acien, A., Silbergeld, E.K., Streeter, R.A., Clark, J.M., Burke, T.A. and Guallar, E. (2006). Arsenic exposure and type 2 diabetes: a systematic review of the experimental and epidemiologic evidence. *Environmental Health Perspectives*, 641-648.
- Ogra, Y. and Anan, Y. (2009). Selenometabolomics: Identification of selenometabolites and specification of their biological significance by complementary use of elemental and molecular mass spectrometry. *Journal of Analytical Atomic Spectrometry* 24, 1477-1488.
- Ohta, Y. and Suzuki, K.T. (2008). Methylation and demethylation of intermediates selenide and methylselenol in the metabolism of selenium. *Toxicology and applied pharmacology* 226, 169-177.
- Park, S.-H., Kim, J.-H., Chi, G.Y., Kim, G.-Y., Chang, Y.-C., Moon, S.-K., Nam, S.-W., Kim, W.-J., Yoo, Y.H. and Choi, Y.H. (2012). Induction of apoptosis and autophagy by sodium selenite in A549 human lung carcinoma cells through generation of reactive oxygen species. *Toxicology letters* 212, 252-261.

- Pilon-Smits, E.A. and LeDuc, D.L. (2009). Phytoremediation of selenium using transgenic plants. *Current Opinion in Biotechnology* 20, 207-212.
- Pilon-Smits, E.A. and Quinn, C.F. (2010). Selenium metabolism in plants *Cell biology of metals and nutrients*, 225-241): Springer.
- Pilsner, J.R., Hall, M.N., Liu, X., Ahsan, H., Ilievski, V., Slavkovich, V., Levy, D., Factor-Litvak, P., Graziano, J.H. and Gamble, M.V. (2010). Associations of plasma selenium with arsenic and genomic methylation of leukocyte DNA in Bangladesh. *Environmental health perspectives* 119, 113-118.
- Plant, J., Kinniburgh, D., Smedley, P., Fordyce, F. and Klinck, B. (2004). Arsenic and selenium.
- Prasad, K.S. and Selvaraj, K. (2014). Biogenic synthesis of selenium nanoparticles and their effect on As (III)-induced toxicity on human lymphocytes. *Biological trace element research* 157, 275-283.
- Qian, Y., Castranova, V. and Shi, X. (2003). New perspectives in arsenic-induced cell signal transduction. *Journal of inorganic biochemistry* 96, 271-278.
- Rahman, M.A. and Hasegawa, H. (2011). Aquatic arsenic: phytoremediation using floating macrophytes. *Chemosphere* 83, 633-646.
- Rahman, M.A., Hogan, B., Duncan, E., Doyle, C., Krassoi, R., Rahman, M.M., Naidu, R., Lim, R.P., Maher, W. and Hassler, C. (2014). Toxicity of arsenic species to three freshwater organisms and biotransformation of inorganic arsenic by freshwater phytoplankton (*Chlorella* sp. CE-35). *Ecotoxicology and environmental safety* 106, 126-135.
- Rai, P.K., Kumar, V., Lee, S., Raza, N., Kim, K.-H., Ok, Y.S. and Tsang, D.C. (2018). Nanoparticle-plant interaction: Implications in energy, environment, and agriculture. *Environment international* 119, 1-19.
- Ramoutar, R.R. and Brumaghim, J.L. (2007). Effects of inorganic selenium compounds on oxidative DNA damage. *Journal of inorganic biochemistry* 101, 1028-1035.
- Ratnaike, R.N. (2003). Acute and chronic arsenic toxicity. *Postgraduate medical journal* 79, 391-396.
- Rayman, M.P. (2000). The importance of selenium to human health. *The lancet* 356, 233-241.



- Rees, K., Hartley, L., Day, C., Flowers, N., Clarke, A. and Stranges, S. (2013). Selenium supplementation for the primary prevention of cardiovascular disease. *Cochrane Database of Systematic Reviews*.
- Reichard, J.F. and Puga, A. (2010). Effects of arsenic exposure on DNA methylation and epigenetic gene regulation.
- Ren, X., McHale, C.M., Skibola, C.F., Smith, A.H., Smith, M.T. and Zhang, L. (2010). An emerging role for epigenetic dysregulation in arsenic toxicity and carcinogenesis. *Environmental health perspectives* 119, 11-19.
- Renkema, H., Koopmans, A., Kersbergen, L., Kikkert, J., Hale, B. and Berkelaar, E. (2012). The effect of transpiration on selenium uptake and mobility in durum wheat and spring canola. *Plant and Soil* 354, 239-250.
- Rizwan, M., Ali, S., Adrees, M., Ibrahim, M., Tsang, D.C., Zia-ur-Rehman, M., Zahir, Z.A., Rinklebe, J., Tack, F.M. and Ok, Y.S. (2017). A critical review on effects, tolerance mechanisms and management of cadmium in vegetables. *Chemosphere* 182, 90-105.
- Rizwan, M., Ali, S., ur Rehman, M.Z., Rinklebe, J., Tsang, D.C., Bashir, A., Maqbool, A., Tack, F. and Ok, Y.S. (2018). Cadmium phytoremediation potential of Brassica crop species: a review. *Science of the Total Environment* 631, 1175-1191.
- Rosen, B.P. and Liu, Z. (2009). Transport pathways for arsenic and selenium: a minireview. *Environment international* 35, 512-515.
- Rossmann, T.G. and Uddin, A.N. (2004). Selenium prevents spontaneous and arsenite-induced mutagenesis *International Congress Series*, 173-179): Elsevier.
- Sah, S., Vandenberg, A. and Smits, J. (2013). Treating chronic arsenic toxicity with high selenium lentil diets. *Toxicology and applied pharmacology* 272, 256-262.
- Saha, U., Fayiga, A. and Sonon, L. (2017). Selenium in the soil-plant environment: a review. *International Journal of Applied Agricultural Sciences* 3, 1-18.
- Salnikow, K. and Zhitkovich, A. (2007). Genetic and epigenetic mechanisms in metal carcinogenesis and cocarcinogenesis: nickel, arsenic, and chromium. *Chemical research in toxicology* 21, 28-44.
- Sampayo-Reyes, A., Taméz-Guerra, R.S., de León, M.B., Vargas-Villarreal, J., Lozano-Garza, H.G., Rodríguez-Padilla, C., Cortés, C., Marcos, R. and Hernández, A.

- (2017). Tocopherol and selenite modulate the transplacental effects induced by sodium arsenite in hamsters. *Reproductive Toxicology* 74, 204-211.
- Sarkar, B., Bhattacharjee, S., Daware, A., Tribedi, P., Krishnani, K. and Minhas, P. (2015). Selenium nanoparticles for stress-resilient fish and livestock. *Nanoscale research letters* 10, 371.
- Savitha, P. (2014). Role of selenium. *Journal of Pharmaceutical Sciences and Research* 6, 56.
- Schiavon, M. and Pilon-Smits, E.A. (2017). Selenium biofortification and phytoremediation phytotechnologies: a review. *Journal of environmental quality* 46, 10-19.
- Schiavon, M., Pilon, M., Malagoli, M. and Pilon-Smits, E.A. (2015). Exploring the importance of sulfate transporters and ATP sulphurylases for selenium hyperaccumulation—a comparison of *Stanleya pinnata* and *Brassica juncea* (Brassicaceae). *Frontiers in Plant Science* 6, 2.
- Schrauzer, G.N. (2000). Selenomethionine: a review of its nutritional significance, metabolism and toxicity. *The Journal of nutrition* 130, 1653-1656.
- Selvaraj, V., Tomblin, J., Armistead, M.Y. and Murray, E. (2013). Selenium (sodium selenite) causes cytotoxicity and apoptotic mediated cell death in PLHC-1 fish cell line through DNA and mitochondrial membrane potential damage. *Ecotoxicology and environmental safety* 87, 80-88.
- Shafik, N.M. and El Batsh, M.M. (2016). Protective effects of combined selenium and *Punica granatum* treatment on some inflammatory and oxidative stress markers in arsenic-induced hepatotoxicity in rats. *Biological trace element research* 169, 121-128.
- Shahid, M., Dumat, C., Khalid, S., Schreck, E., Xiong, T. and Niazi, N.K. (2017). Foliar heavy metal uptake, toxicity and detoxification in plants: A comparison of foliar and root metal uptake. *Journal of Hazardous Materials* 325, 36-58.
- Shahid, M., Niazi, N.K., Khalid, S., Murtaza, B., Bibi, I. and Rashid, M.I. (2018). A critical review of selenium biogeochemical behavior in soil-plant system with an inference to human health. *Environmental pollution* 234, 915-934.

- Shakir, S.K., Azizullah, A., Murad, W., Daud, M.K., Nabeela, F., Rahman, H., ur Rehman, S. and Häder, D.-P. (2016). Toxic metal pollution in Pakistan and its possible risks to public health *Reviews of environmental contamination and toxicology*, 1-60): Springer.
- Shankar, S. and Shanker, U. (2014). Arsenic contamination of groundwater: a review of sources, prevalence, health risks, and strategies for mitigation. *The Scientific World Journal* 2014.
- Sharma, I. (2012). Arsenic induced oxidative stress in plants. *Biologia* 67, 447-453.
- Shen, H.-M. and Liu, Z.-g. (2006). JNK signaling pathway is a key modulator in cell death mediated by reactive oxygen and nitrogen species. *Free Radical Biology and Medicine* 40, 928-939.
- Shi, H., Hudson, L.G., Ding, W., Wang, S., Cooper, K.L., Liu, S., Chen, Y., Shi, X. and Liu, K.J. (2004). Arsenite causes DNA damage in keratinocytes via generation of hydroxyl radicals. *Chemical research in toxicology* 17, 871-878.
- Shibata, Y., Morita, M. and Fuwa, K. (1992). Selenium and arsenic in biology: their chemical forms and biological functions. *Advances in Biophysics* 28, 31-80.
- Shini, S., Sultan, A. and Bryden, W. (2015). Selenium biochemistry and bioavailability: Implications for animal agriculture. *Agriculture* 5, 1277-1288.
- Singh, R., Singh, S., Parihar, P., Singh, V.P. and Prasad, S.M. (2015). Arsenic contamination, consequences and remediation techniques: a review. *Ecotoxicology and environmental safety* 112, 247-270.
- Skalickova, S., Milosavljevic, V., Cihalova, K., Horky, P., Richtera, L. and Adam, V. (2017). Selenium nanoparticles as a nutritional supplement. *Nutrition* 33, 83-90.
- Skröder Löveborn, H., Kippler, M., Lu, Y., Ahmed, S., Kuehnelt, D., Raqib, R. and Vahter, M. (2016). Arsenic metabolism in children differs from that in adults. *Toxicological Sciences* 152, 29-39.
- Sneddon, A. (2012). Selenium nutrition and its impact on health. *J. Food & Health Innovation Service*, 104-108.
- Snider, G.W., Ruggles, E., Khan, N. and Hondal, R.J. (2013). Selenocysteine confers resistance to inactivation by oxidation in thioredoxin reductase: comparison of selenium and sulfur enzymes. *Biochemistry* 52, 5472-5481.

- Stadtman, T.C. (2005). Selenoproteins—Tracing the role of a trace element in protein function. *PLoS biology* 3, e421.
- Stoeva, N. and Bineva, T. (2003). Oxidative changes and photosynthesis in oat plants grown in As-contaminated soil. *Bulg J Plant Physiol* 29, 87-95.
- Stolz, J.F., Basu, P., Santini, J.M. and Oremland, R.S. (2006). Arsenic and selenium in microbial metabolism. *Annu. Rev. Microbiol.* 60, 107-130.
- Styblo, M. and Thomas, D.J. (2001). Selenium modifies the metabolism and toxicity of arsenic in primary rat hepatocytes. *Toxicology and applied pharmacology* 172, 52-61.
- Su, C.-T., Hsieh, R.-L., Chung, C.-J., Huang, P.-T., Lin, Y.-C., Ao, P.-L., Shiue, H.-S., Chen, W.-J., Huang, S.-R. and Lin, M.-I. (2019). Plasma selenium influences arsenic methylation capacity and developmental delays in preschool children in Taiwan. *Environmental research* 171, 52-59.
- Sun, H.-J., Rathinasabapathi, B., Wu, B., Luo, J., Pu, L.-P. and Ma, L.Q. (2014). Arsenic and selenium toxicity and their interactive effects in humans. *Environment international* 69, 148-158.
- Surai, P.F. (2006). *Selenium in nutrition and health*: Nottingham university press Nottingham.
- Suzuki, K.T., Kurasaki, K. and Suzuki, N. (2007). Selenocysteine  $\beta$ -lyase and methylselenol demethylase in the metabolism of Se-methylated selenocompounds into selenide. *Biochimica et Biophysica Acta (BBA)-General Subjects* 1770, 1053-1061.
- Talbot, S., Nelson, R. and Self, W. (2008). Arsenic trioxide and auranofin inhibit selenoprotein synthesis: implications for chemotherapy for acute promyelocytic leukaemia. *British journal of pharmacology* 154, 940-948.
- Tanmoy, P. and Saha, N.C. (2019). Environmental arsenic and selenium contamination and approaches towards its bioremediation through the exploration of microbial adaptations: A review. *Pedosphere* 29, 554-568.
- Terry, N., Zayed, A., De Souza, M. and Tarun, A. (2000). Selenium in higher plants. *Annual review of plant biology* 51, 401-432.

- Tinggi, U. (2003). Essentiality and toxicity of selenium and its status in Australia: a review. *Toxicology letters* 137, 103-110.
- Tseng, C.-H. (2009). A review on environmental factors regulating arsenic methylation in humans. *Toxicology and applied pharmacology* 235, 338-350.
- Vahter, M.E. (2007). Interactions between arsenic-induced toxicity and nutrition in early life. *The Journal of nutrition* 137, 2798-2804.
- Valdiglesias, V., Pásaro, E., Méndez, J. and Laffon, B. (2010). In vitro evaluation of selenium genotoxic, cytotoxic, and protective effects: a review. *Archives of toxicology* 84, 337-351.
- Valko, M., Rhodes, C., Moncol, J., Izakovic, M. and Mazur, M. (2006). Free radicals, metals and antioxidants in oxidative stress-induced cancer. *Chemico-biological interactions* 160, 1-40.
- Ventura, J.-J., Cogswell, P., Flavell, R.A., Baldwin, A.S. and Davis, R.J. (2004). JNK potentiates TNF-stimulated necrosis by increasing the production of cytotoxic reactive oxygen species. *Genes & development* 18, 2905-2915.
- Villa-Bellosta, R. and Sorribas, V. (2008). Role of rat sodium/phosphate cotransporters in the cell membrane transport of arsenate. *Toxicology and applied pharmacology* 232, 125-134.
- Vinceti, M., Maraldi, T., Bergomi, M. and Malagoli, C. (2009). Risk of chronic low-dose selenium overexposure in humans: insights from epidemiology and biochemistry. *Reviews on environmental health* 24, 231-248.
- Vinceti, M., Solovyev, N., Mandrioli, J., Crespi, C.M., Bonvicini, F., Arcolin, E., Georgouloupoulou, E. and Michalke, B. (2013). Cerebrospinal fluid of newly diagnosed amyotrophic lateral sclerosis patients exhibits abnormal levels of selenium species including elevated selenite. *Neurotoxicology* 38, 25-32.
- Vogelstein, B., Lane, D. and Levine, A.J. (2000). Surfing the p53 network. *Nature* 408, 307-310.
- Wallenberg, M., Olm, E., Hebert, C., Björnstedt, M. and Fernandes, A.P. (2010). Selenium compounds are substrates for glutaredoxins: a novel pathway for selenium metabolism and a potential mechanism for selenium-mediated cytotoxicity. *Biochemical Journal* 429, 85-93.

- Walton, F.S., Waters, S.B., Jolley, S.L., LeCluyse, E.L., Thomas, D.J. and Styblo, M. (2003). Selenium compounds modulate the activity of recombinant rat AsIII-methyltransferase and the methylation of arsenite by rat and human hepatocytes. *Chemical research in toxicology* 16, 261-265.
- Wang, Q.Q., Thomas, D.J. and Naranmandura, H. (2015). Importance of Being Thiomethylated: Formation, Fate, and Effects of Methylated Thioarsenicals. *Chemical research in toxicology* 28, 281-289.
- Wei, Y., Cao, X., Ou, Y., Lu, J., Xing, C. and Zheng, R. (2001). SeO<sub>2</sub> induces apoptosis with down-regulation of Bcl-2 and up-regulation of P53 expression in both immortal human hepatic cell line and hepatoma cell line. *Mutation Research/Genetic Toxicology and Environmental Mutagenesis* 490, 113-121.
- Weiller, M., Latta, M., Kresse, M., Lucas, R. and Wendel, A. (2004). Toxicity of nutritionally available selenium compounds in primary and transformed hepatocytes. *Toxicology* 201, 21-30.
- Wen, H. and Carignan, J. (2007). Reviews on atmospheric selenium: emissions, speciation and fate. *Atmospheric environment* 41, 7151-7165.
- Whanger, P. (2004). Selenium and its relationship to cancer: an update. *British journal of nutrition* 91, 11-28.
- Wilson, S.C., Lockwood, P.V., Ashley, P.M. and Tighe, M. (2010). The chemistry and behaviour of antimony in the soil environment with comparisons to arsenic: a critical review. *Environmental pollution* 158, 1169-1181.
- Winkel, L., Vriens, B., Jones, G., Schneider, L., Pilon-Smits, E. and Bañuelos, G. (2015). Selenium cycling across soil-plant-atmosphere interfaces: a critical review. *Nutrients* 7, 4199-4239.
- Winkel, L.H., Johnson, C.A., Lenz, M., Grundl, T., Leupin, O.X., Amini, M. and Charlet, L. (2011). Environmental selenium research: from microscopic processes to global understanding: ACS Publications.
- Witkiewicz-Kucharczyk, A. and Bal, W. (2006). Damage of zinc fingers in DNA repair proteins, a novel molecular mechanism in carcinogenesis. *Toxicology letters* 162, 29-42.

- Woo Youn, B., Fiala, E.S. and Soon Sohn, O. (2001). Mechanisms of organoselenium compounds in chemoprevention: effects on transcription factor-DNA binding. *Nutrition and cancer* 40, 28-33.
- Wu, Z., Bañuelos, G.S., Lin, Z.-Q., Liu, Y., Yuan, L., Yin, X. and Li, M. (2015). Biofortification and phytoremediation of selenium in China. *Frontiers in Plant Science* 6, 136.
- Xiong, T., Austruy, A., Pierart, A., Shahid, M., Schreck, E., Mombo, S. and Dumat, C. (2016). Kinetic study of phytotoxicity induced by foliar lead uptake for vegetables exposed to fine particles and implications for sustainable urban agriculture. *Journal of Environmental Sciences* 46, 16-27.
- Xu, Z., Wang, Z., Li, J.-j., Chen, C., Zhang, P.-c., Dong, L., Chen, J.-h., Chen, Q., Zhang, X.-t. and Wang, Z.-l. (2013). Protective effects of selenium on oxidative damage and oxidative stress related gene expression in rat liver under chronic poisoning of arsenic. *Food and Chemical Toxicology* 58, 1-7.
- Yang, C. and Frenkel, K. (2002). Arsenic-mediated cellular signal transduction, transcription factor activation, and aberrant gene expression: implications in carcinogenesis. *Journal of environmental pathology, toxicology and oncology* 21.
- Yang, C., Kuo, M., Chen, J. and Chen, Y. (1999). Arsenic trioxide sensitivity is associated with low level of glutathione in cancer cells. *British journal of cancer* 81, 796.
- Yang, J., Cao, W. and Rui, Y. (2017). Interactions between nanoparticles and plants: phytotoxicity and defense mechanisms. *Journal of plant interactions* 12, 158-169.
- Ye, W.-L., Khan, M.A., McGrath, S.P. and Zhao, F.-J. (2011). Phytoremediation of arsenic contaminated paddy soils with *Pteris vittata* markedly reduces arsenic uptake by rice. *Environmental pollution* 159, 3739-3743.
- Yoshioka, J., Schreiter, E.R. and Lee, R.T. (2006). Role of thioredoxin in cell growth through interactions with signaling molecules. *Antioxidants & redox signaling* 8, 2143-2151.
- Zakharyan, R.A. and Aposhian, H.V. (1999). Arsenite methylation by methylvitamin B<sub>12</sub> and glutathione does not require an enzyme. *Toxicology and applied pharmacology* 154, 287-291.

- Zarubin, T. and Jiahuai, H. (2005). Activation and signaling of the p38 MAP kinase pathway. *Cell research* 15, 11.
- Zeng, G., Wu, H., Liang, J., Guo, S., Huang, L., Xu, P., Liu, Y., Yuan, Y., He, X. and He, Y. (2015). Efficiency of biochar and compost (or composting) combined amendments for reducing Cd, Cu, Zn and Pb bioavailability, mobility and ecological risk in wetland soil. *Rsc Advances* 5, 34541-34548.
- Zeng, H. (2001). Arsenic suppresses necrosis induced by selenite in human leukemia HL-60 cells. *Biological trace element research* 83, 1-15.
- Zeng, H. (2009). Selenium as an essential micronutrient: roles in cell cycle and apoptosis. *Molecules* 14, 1263-1278.
- Zeng, H. and Combs Jr, G.F. (2008). Selenium as an anticancer nutrient: roles in cell proliferation and tumor cell invasion. *The Journal of nutritional biochemistry* 19, 1-7.
- Zeng, H. and Combs, G.F. (2008). Selenium as an anticancer nutrient: roles in cell proliferation and tumor cell invasion. *The Journal of nutritional biochemistry* 19, 1-7.
- Zeng, H., Uthus, E.O. and Combs Jr, G.F. (2005). Mechanistic aspects of the interaction between selenium and arsenic. *Journal of inorganic biochemistry* 99, 1269-1274.
- Zeng, H., Uthus, E.O. and Combs, G.F. (2005). Mechanistic aspects of the interaction between selenium and arsenic. *Journal of inorganic biochemistry* 99, 1269-1274.
- Zhao, F.J., Ma, J.F., Meharg, A. and McGrath, S. (2009). Arsenic uptake and metabolism in plants. *New Phytologist* 181, 777-794.
- Zhong, C.X. and Mass, M.J. (2001). Both hypomethylation and hypermethylation of DNA associated with arsenite exposure in cultures of human cells identified by methylation-sensitive arbitrarily-primed PCR. *Toxicology letters* 122, 223-234.
- Zhou, N., Xiao, H., Li, T.-K., Nur-E-Kamal, A. and Liu, L.F. (2003). DNA damage-mediated apoptosis induced by selenium compounds. *Journal of Biological Chemistry* 278, 29532-29537.
- Zhou, X., Sun, X., Cooper, K.L., Wang, F., Liu, K.J. and Hudson, L.G. (2011). Arsenite interacts selectively with zinc finger proteins containing C3H1 or C4 motifs. *Journal of Biological Chemistry* 286, 22855-22863.



- Zwolak, I. (2019). The Role of Selenium in Arsenic and Cadmium Toxicity: an Updated Review of Scientific Literature. *Biological trace element research*, 1-20.
- Zwolak, I. (2020). The role of selenium in arsenic and cadmium toxicity: an updated review of scientific literature. *Biological trace element research* 193, 44-63.
- Zwolak, I. and Zaporowska, H. (2012). Selenium interactions and toxicity: a review. *Cell biology and toxicology* 28, 31-46.

## List of figure captions

**Figure 1** General overview of arsenic and selenium transport, fate in various environmental matrices associated with human health toxicological effects.

**Figure 2** An overview of arsenic and selenium uptake, accumulation, metabolic reactions, and pathways in the soil-plant system.

**Figure 3** Arsenic metabolic pathways, thiolation in mammal's, and human cells: Arsenic methylation metabolic pathway in *scopulariopsis Brevicaulis* (a), non-enzymatic arsenic methylation pathway in rat liver cells (b), arsenic metabolic pathway in rate liver cells (c), arsenic metabolic pathway in rate liver cells (d), and arsenic metabolic pathway in wild-type rate liver cells (e).

**Figure 4** Selenium metabolism pathways in human (a) and animals (rats) (b).

**Figure 5** Arsenic and selenium epidemical effects, cytotoxicity, and genotoxicity in animals and humans.

**Figure 6** Antagonistic (a) and synergetic (b) interactions between As and Se, and toxicity in animals and humans

**Figure 7** Arsenic and selenium effects on zinc finger proteins/nucleases (ZFNs) cellular functions pathways. The arrows indicate induction, single green capped line indicated inhibition of cellular pathways while, double capped red line indicated the mutual inhibition of the As/Se bioactivity by an increase of Se/As biliary excretion, the formation of As-Se precipitation and to modify As/Se methylation in the cellular pathway.

Figure 1

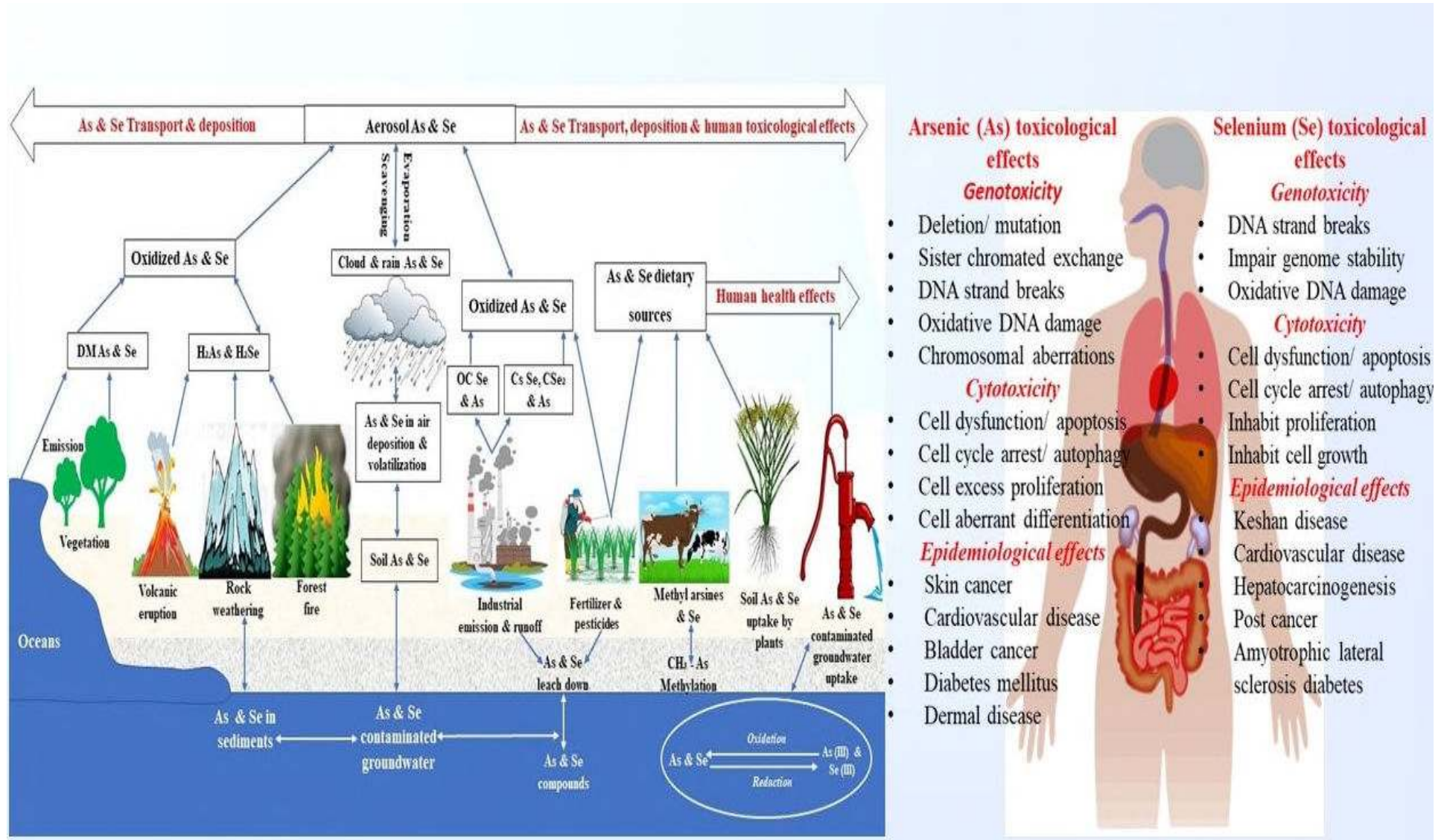





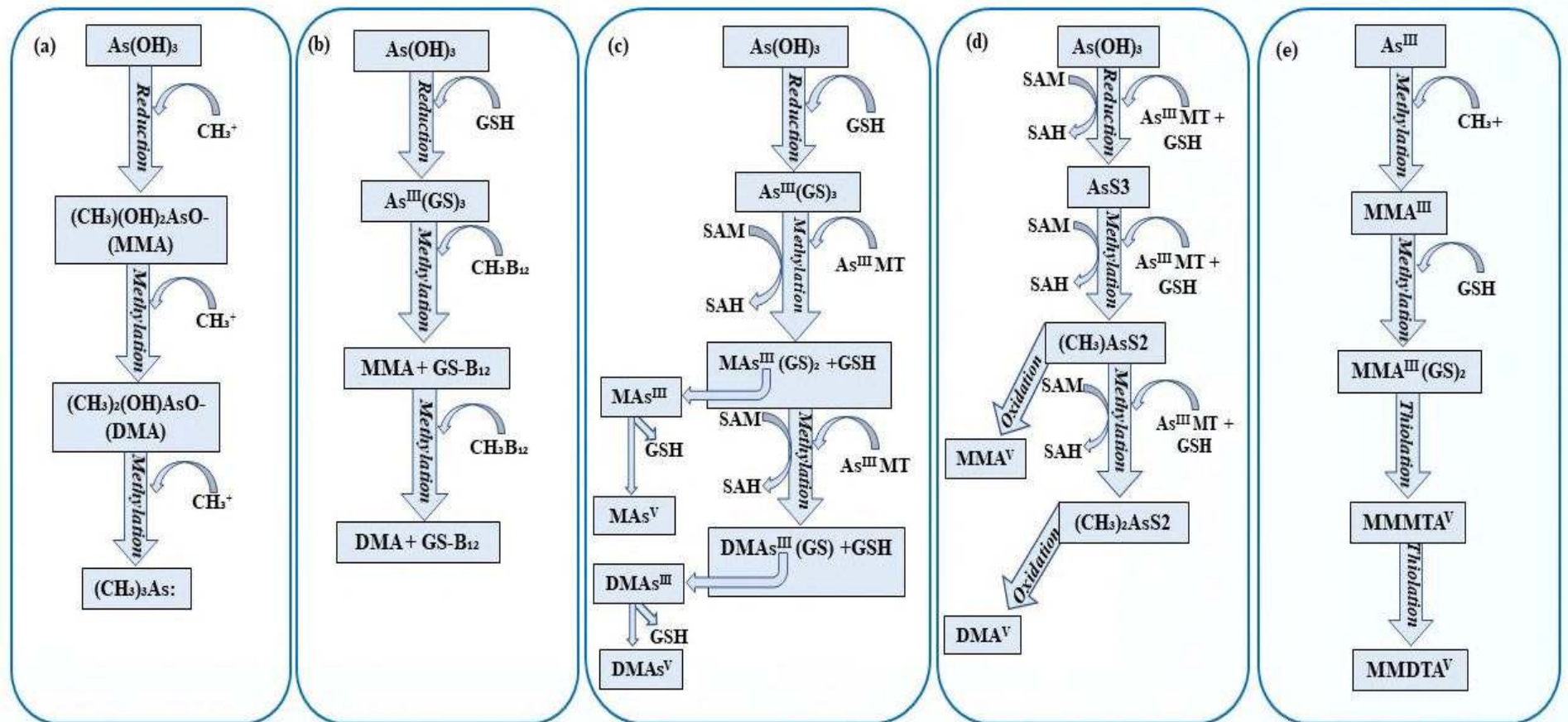

Where  $\text{As}(\text{OH})_3$  = arsenous acid;  $\text{CH}_3^+$  = methyl group;  $(\text{CH}_3)(\text{OH})_2\text{AsO}^-$  = monomethyl arsonous acid;  $(\text{CH}_3)_2(\text{OH})\text{AsO}^-$  = dimethyl arsenic acid;  $(\text{CH}_3)_3\text{As:}$  = trimethyl arsine; GSH = glutathione;  $\text{As}^{\text{III}}(\text{GS})_3$  = arsenite trglutathione;  $\text{CH}_3\text{B}_{12}$  = methyl cobalamin; MMA = monomethyl arsonic acid; DMA = dimethyl arsenic acid;  $\text{GS-B}_{12}$  = glutathione-vitamin B<sub>12</sub> complex; SAM = S-adenosyl methionine; SAH = s-adenosyl homocysteine;  $\text{As}^{\text{III}}\text{MT}$  = arsenite methyl transferase;  $\text{MAAs}^{\text{III}}$  = monomethyl arsonic acid;  $\text{DMAAs}^{\text{III}}$  = dimethyl arsenous acid;  $\text{DMAAs}^{\text{V}}$  = dimethyl arsenic acid;  $\text{AsS}_3$  = pyruvate carboxylase protein;  $(\text{CH}_3)\text{AsS}_2$  = monomethyl protein complex;  $(\text{CH}_3)_2\text{AsS}_2$  = dimethyl protein complex;  $\text{MMA}^{\text{V}}$  = Penta valent monomethyl arsonic acid;  $\text{DMA}^{\text{V}}$  = Penta valent dimethyl arsenic acid;  $\text{MMA}^{\text{III}}$  = monomethyl arsonic acid;  $\text{MMMTA}^{\text{V}}$  = monomethyl monothioarsenic; and  $\text{MMDTA}^{\text{V}}$  = monomethyl dithioarsenic.

Figure 3

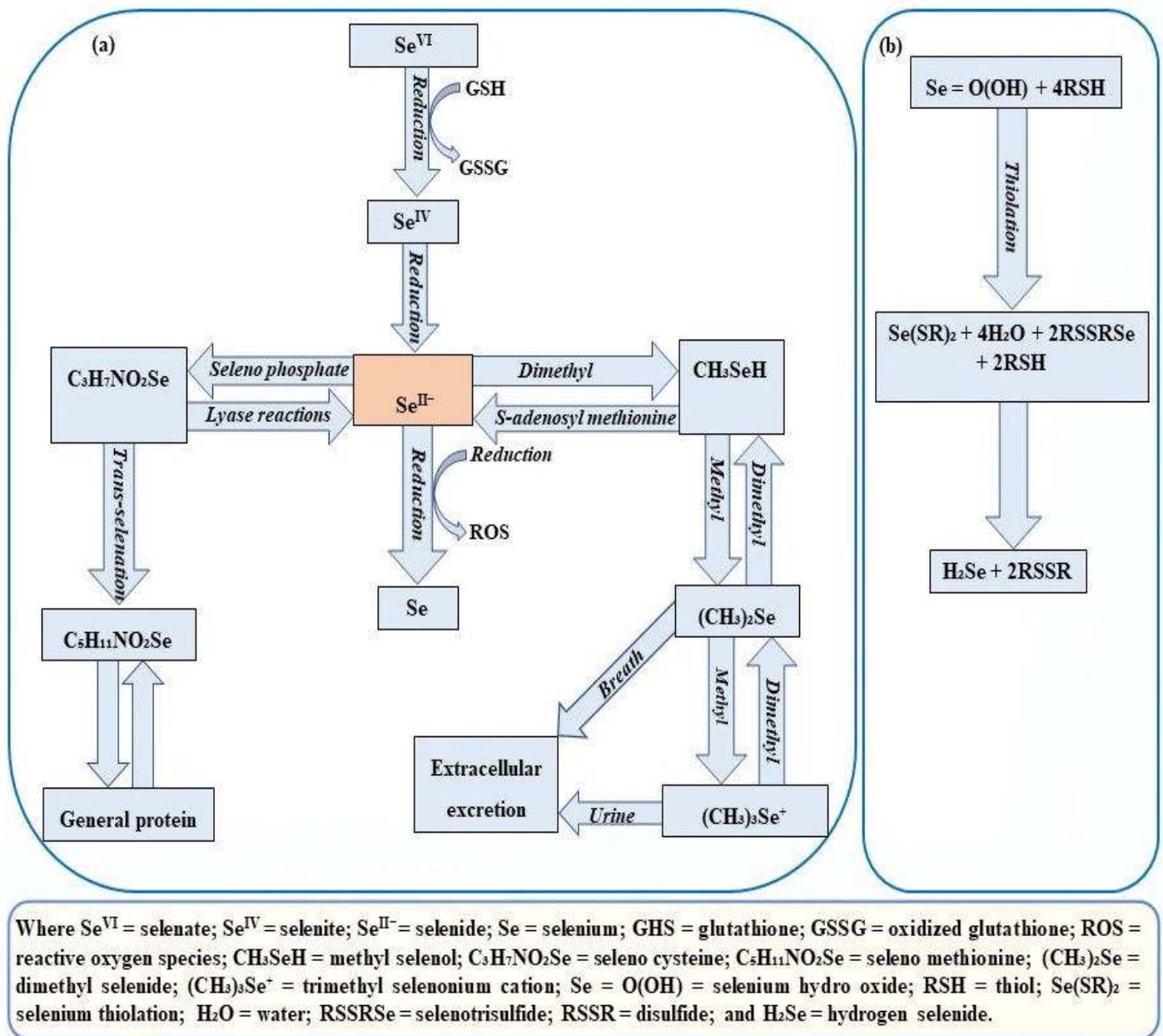
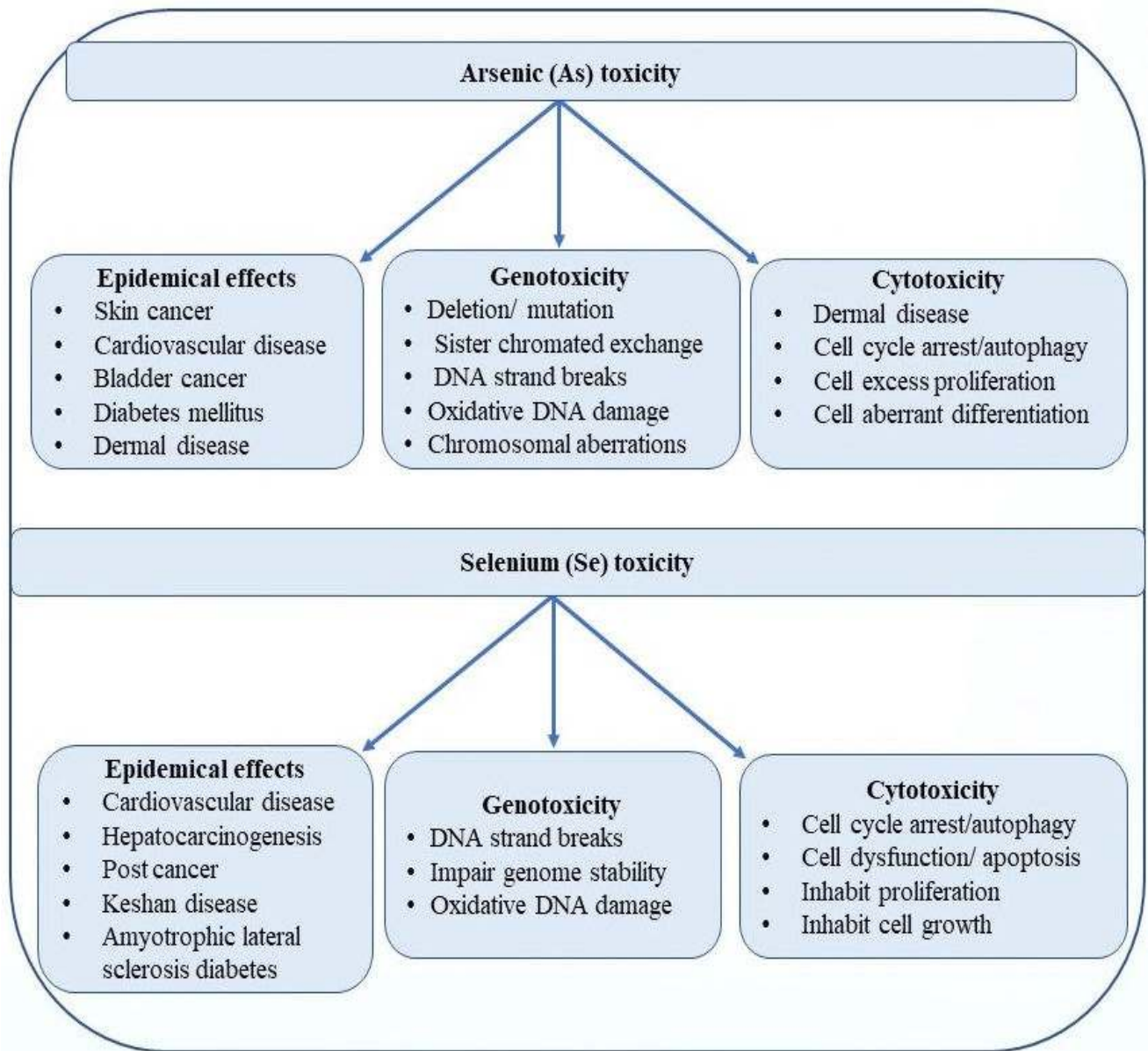

Figure 4



**Figure 5**

(the content of this figure is repeated with Fig. 1 )



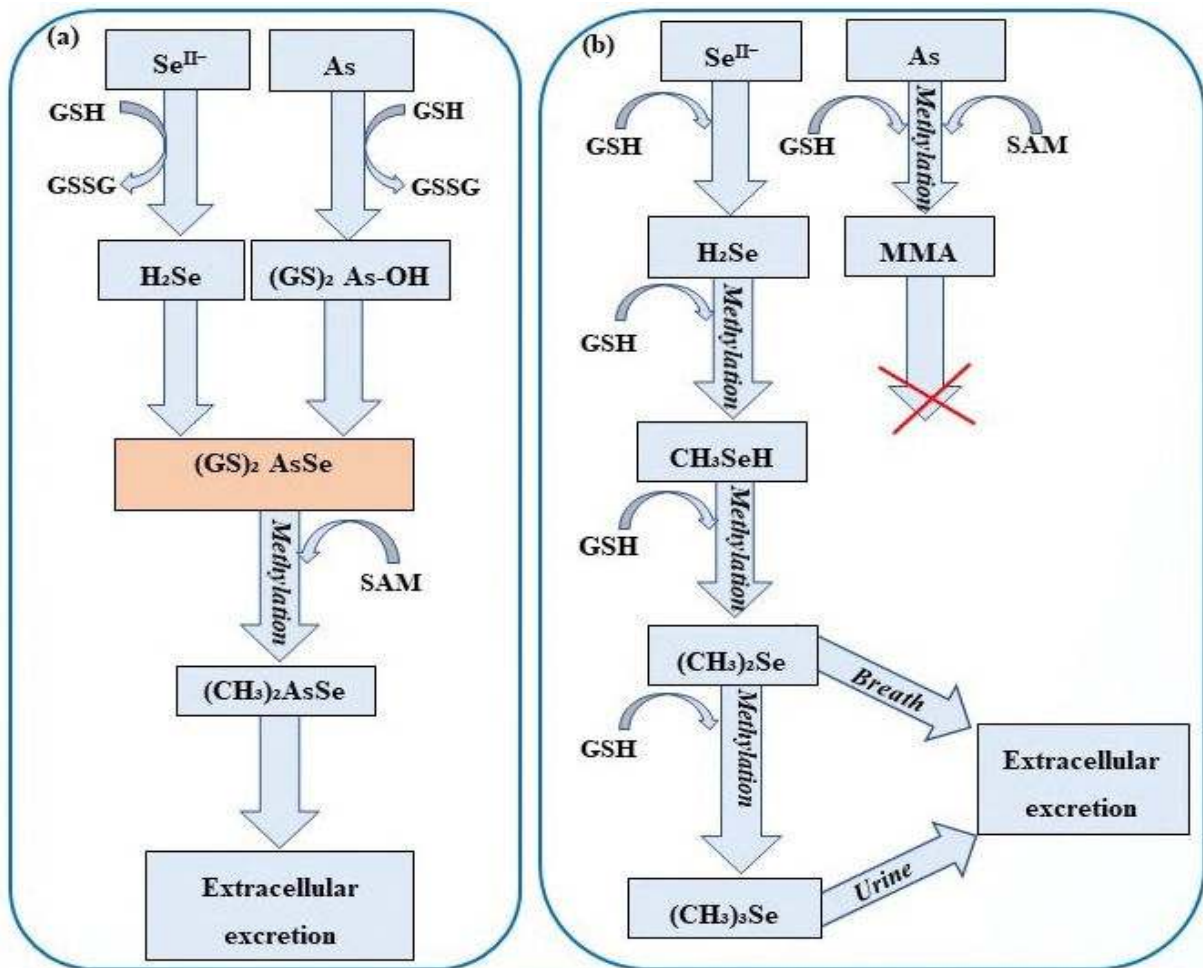

Where  $\text{Se}^{\text{II-}}$  = selenide; As = arsenic; GSH = glutathione; GSSG = oxidized glutathione;  $\text{H}_2\text{Se}$  = hydrogen selenide;  $(\text{GS})_2 \text{As-OH}$  = diglutathione arsenic-oxide;  $(\text{CH}_3)_2\text{AsSe}$  = dimethyl arsenic selenium complex;  $(\text{GS})_2 \text{AsSe}$  = diglutathione arsenic selenium complex; SAM = S-adenosyl methionine; MMA = monomethylarsenic acid;  $\text{CH}_3\text{SeH}$  = methylselenol;  $(\text{CH}_3)_2\text{Se}$  = dimethylselenide; and  $(\text{CH}_3)_3\text{Se}$  = trimethyl selenide.

Figure 6



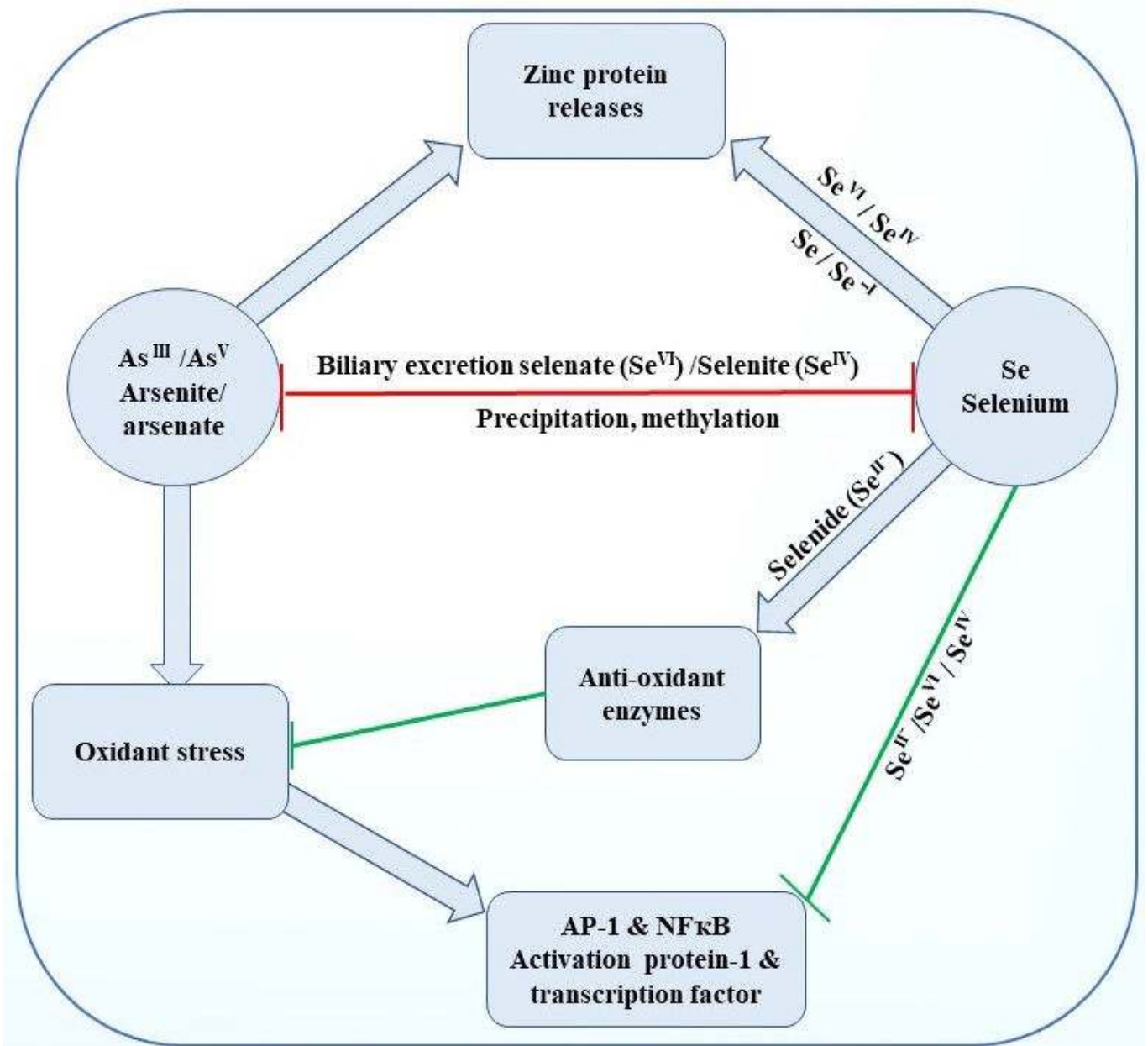

Figure

## **List of table captions**

**Table 1** Abbreviations used in the current review.

**Table 2** Summary of studies elucidating insights antagonistic and synergetic supplementation interactions between arsenic and selenium, and associate toxicity in animals/rat and humans cell culture models.

**Table 1 Abbreviations used in the current review.**

Name	Abbreviations	Name	Abbreviations
Adenosine triphosphate	ATP	Activation protein	AP
Arsenate	As <sup>V</sup>	Adenosine phosphoselenate	APSe
Arsenic	As	Arsenite-glutathione complex	As (GS) <sub>2</sub> -OH, As(GS) <sub>3</sub>
Arsenic reductase	AR	Dimethyl selenide	(CH <sub>3</sub> ) <sub>2</sub> Se (DMSe)
Arsenic triglutathione	As (GS) <sub>3</sub>	Dimethyl diselenide	DMDS <sub>2</sub>
Arsenite	As <sup>III</sup>	Ebselen	C <sub>13</sub> H <sub>9</sub> N <sub>2</sub> OSe
Arsenite methyltransferase	As <sup>III</sup> MT	Glutaredoxins	Grxs
Dimethylarsenic acid	DMA	Hydrogen selenide	H <sub>2</sub> Se
Dimethylarsinic	DMA <sup>III</sup>	Methylselenol	CH <sub>3</sub> SeH
Dimethylarsinic acid	(CH <sub>3</sub> ) <sub>2</sub> (OH) <sub>2</sub> AsO <sup>-</sup>	Mitogen-Activated Protein Kinase	MAPK
Dimethylarsinic glutathione	DMA <sup>III</sup> (GS)	Phenyarselenyl chloride	C <sub>6</sub> H <sub>5</sub> ClSe
Dimethylarsinous	DMA <sup>V</sup>	Phenylseleninic acid	C <sub>6</sub> H <sub>6</sub> O <sub>2</sub> Se
Glutathione	GSH	Phosphate transporter	Pi
Methyl group	CH <sub>3</sub> <sup>+</sup>	Phytochelatin transporter	PCs
Monomethyl dithioarsenic	MMDTA <sup>V</sup>	Reactive oxygen species	ROS
Monomethyl monothioarsenic	MMMTA <sup>V</sup>	S-adenosylmethionine	SAM
Monomethylarsenic acid	MMA	Selenate	Se <sup>VI</sup>
Monomethylarsonic	MMA <sup>III</sup>	Selenide	Se <sup>II-</sup>
Monomethylarsonic diglutathione	MA <sup>III</sup> (GS) <sub>2</sub>	Selenite	Se <sup>IV</sup>
Monomethylarsonous	MMA <sup>V</sup>	Selenium	Se
Monomethylarsonous acid	(CH <sub>3</sub> ) (OH) <sub>2</sub> AsO <sup>-</sup>	Selenocysteine	SeCys
Oxidized glutathione	GSSG	Selenomethionine	SeMet
Pentavalent dimethylarsinic acid	DMA <sup>V</sup>	Seleno persulfide	GSSeH
Pentavalent monomethyl arsonic acid	MMA <sup>V</sup>	Selenotrisulfide	RSSeSR
S-Adenosylhomocysteine	SAH	Sulfate transporter	ST
S-Adenosylmethionine	SAM	Sulfide	S <sup>II-</sup>
Trimethylarsineoxide	TMAO <sup>III</sup>	Thioselenate	SSeO <sub>3</sub> <sup>2-</sup>
Trimethyl arsenic oxide	TMAO <sup>V</sup>	Phytochelatin	PCs
Damage regulated autophagy modulator	DRAM	Silicon transporter	Lsil
Thioredoxin reductase	TrxR	Thioredoxin	Trx
Trivalent monomethyl arsenous acid	DMA <sup>III</sup>	Trimethyl selenium	(CH <sub>3</sub> ) <sub>3</sub> Se <sup>+</sup>

**Table 2 Summary of studies elucidating insights antagonistic and synergetic supplementation interactions between arsenic and selenium, and associate toxicity in animals/rat and humans cell culture models.**

Experimental duration	Arsenic & selenium form & (dose)	Biomarker & (target)	Arsenic -selenium interactions, effects in animals & humans	References
6 to 14 days	Sodium selenite (Na <sub>2</sub> SeO <sub>3</sub> ) = Na <sub>2</sub> SeO <sub>3</sub> = (0.025 mg/kg) BW oral drinking water	Pregnant Syrian hamster and (fetus)	<ul style="list-style-type: none"> <li>Increases As methylation index in urine, tissues of dams in the whole fetus, the activity of glutathione peroxidase (GPx), and a viable fetus</li> <li>Reduced the As concentration in kidney, liver bladder, brain, the skin of pregnant animals, accumulation in the placenta, and fetus.</li> </ul>	(Zwolak 2020, Sampayo-Reyes, Taméz-Guerra, de León, Vargas-Villarreal, Lozano-Garza, Rodríguez-Padilla, Cortés, Marcos and Hernández 2017).
3 weeks	Na <sub>2</sub> SeO <sub>3</sub> = (3 mg/kg) BW oral intubation	Wistar rat (liver)	<ul style="list-style-type: none"> <li>Increases glutathione (GSH) level and GPx activity</li> <li>Reduces aspartate aminotransferase (AST), alanine aminotransferase (ALT), and alkaline phosphatase (ALP) activity in plasma compared with As-treated animals.</li> <li>Reduces the lipid peroxidation, glutathione S-transferase activity, and cytoplasmic As-induced histological changes.</li> </ul>	(Messarah, Klibet, Boumendjel, Abdennour, Bouzerna, Boulakoud and El Feki 2012, Zwolak 2020).
3 weeks	Na <sub>2</sub> SeO <sub>3</sub> = (3 mg/kg) BW oral intubation	Sprague Dawley (SD) Rat (liver)	<ul style="list-style-type: none"> <li>Increases liver weight and partly protect against As- induced.</li> <li>Increases mRNA gene expression of nuclear factor erythroid 2 related factors (Nrf2), thioredoxin reductase (TrxR), and total antioxidant capacity (TAC) activity, which decreased by As.</li> <li>Decrease ALT, AST activity in blood serum, malondialdehyde (MDA), nitric oxide (NO) advanced oxidation protein products, and serum interleukin-6 (IL-6) levels, which increased by As.</li> </ul>	(Zwolak 2020, Shafik and El Batsh 2016).

20 weeks	Na <sub>2</sub> SeO <sub>3</sub> = (17.0 mg/L) Oral	SD Rat (liver)	<ul style="list-style-type: none"> <li>Increases mRNA expression of GPx, superoxide dismutase (SOD), Txnrd1, TrxR protein expressions, which reduced by As.</li> <li>Reduced the ALT, AST activities in blood, As- induced heme oxygenase-1 (OH-1) protein expression which increased by As.</li> </ul>	(Zwolak 2020, Xu, Wang, Li, Chen, Zhang, Dong, Chen, Chen, Zhang and Wang 2013).
14 weeks	Not specified Se rich lentils Se deficient = (< 0.01 mg), and Se high oral = (0.3 mg)	Wistar rat (Blood, kidney & liver)	<ul style="list-style-type: none"> <li>Increases As concentration in urine and faces and GSH level in the blood, mitigated liver lipid peroxidation, and partly recovered antibody response, which reduced in Se-deficient animals.</li> <li>Selenium high intake reduced As the level in kidney</li> </ul>	(Zwolak 2020, Sah, Vandenberg and Smits 2013).
24 hours	Selenomethionine (SeMet) = (100 μm)	Human embryonic kidney cell line (HEK-293)	<ul style="list-style-type: none"> <li>Reduces As-induced cytotoxicity and reactive oxygen species (ROS) level.</li> <li>Increases the phosphorylation of the protein, which is involved in ROS antitumor activity, cell growth, and detoxification.</li> </ul>	(Zwolak 2020, Chitta, Figueroa, Caruso and Merino 2013).
1 hour	Selenium nanoparticles (SeNPs) = (0.01 μg/L)	Human lymphocytes	<ul style="list-style-type: none"> <li>Nano selenium reduced As-induced toxicity and DNA damage.</li> </ul>	(Zwolak 2020, Prasad and Selvaraj 2014).
48 hours	Sodium arsenite (NaAsO <sub>2</sub> ) = (2.5 μM) Na <sub>2</sub> SeO <sub>3</sub> = (10 μM)	Human osteosarcoma (Cells-TE85)	<ul style="list-style-type: none"> <li>Increases level of selenite (Se<sup>IV</sup>) and SeMet.</li> <li>Partly decreases the arsenite (As<sup>III</sup>) cytotoxicity.</li> <li>Selenium compound like organoselenium treatment block As species (As<sup>III</sup>-dependent) accumulation of mutants in cultures for six weeks growth.</li> </ul>	(Zwolak and Zaporowska 2012, Rossman and Uddin 2004).

Not defined	NaAsO <sub>2</sub> = (6.25 μM) Na <sub>2</sub> SeO <sub>3</sub> = (2.5 μM)	Human hepatocellular carcinoma (Cells-HepG2)	<ul style="list-style-type: none"> <li>Selenium species Se<sup>IV</sup> reduces the lipid peroxidation (LPO) and 8-hydroxy-2deoxyguanosine (8-OHdG) levels.</li> <li>No effects on the inhibition of 8-oxoguanine DNA glucosylase-1 expressions in cells exposed to arsenous acid (H<sub>3</sub>AsO<sub>3</sub>)</li> <li>The immunoblot As<sup>III</sup> treatment showed to increase in the TrxR1 proteins level and reduced the GPx proteins.</li> <li>Reduces radiolabeled TrxR1, GPx, and overall selenoprotein levels.</li> </ul>	(Zwolak and Zaporowska 2012, Lai, Wang, Li and Yu 2008).
24 hours	NaAsO <sub>2</sub> (2 to 10 μM) <sup>75</sup> Se- Se <sup>IV</sup> = (10 nM)	Human keratinocyte (Cells-HaCat)	<ul style="list-style-type: none"> <li>Treatment of cells with As<sup>III</sup> reduces radiolabeled TrxR1 and overall selenoprotein levels.</li> </ul>	(Zwolak and Zaporowska 2012, Ganyc, Talbot, Konate, Jackson, Schanen, Cullen and Self 2006).
24 hours	NaAsO <sub>2</sub> = (2 to 10 μM) <sup>75</sup> Se- Se <sup>IV</sup> = (10 nM)	Human lung adenocarcinoma (Cells-A549)	<ul style="list-style-type: none"> <li>The Se<sup>IV</sup> increases the level of GSH and GPx activity.</li> <li>Reduces LPO, glutathione S-transferee, transaminases activity, and alkaline phosphatase in plasma of As<sup>III</sup>-exposed rats.</li> </ul>	(Zwolak and Zaporowska 2012, Messarah, Klibet, Boumendjel, Abdennour, Bouzerna, Boulakoud and El Feki 2012).
3 weeks	NaAsO <sub>2</sub> = (5.5 mg/kg) Na <sub>2</sub> SeO <sub>3</sub> = (3 mg/kg) oral	Wistar rat		

