



# Internet Presence and Multilingual Dissemination in Corporate Websites: A Portrait of Spanish Healthcare SMEs

Irene Rivera-Trigueros, University of Granada, Spain

 <https://orcid.org/0000-0003-4877-4083>

María-Dolores Olvera-Lobo, University of Granada, Spain

 <https://orcid.org/0000-0002-0489-7674>

## ABSTRACT

The development of information and communication technologies has enabled companies to spread messages globally, allowing them to open new markets and reach international clients. In this sense, the multilingual dissemination of corporate information plays a key role, and, for this purpose, websites are great communication vehicles. The aim of this paper is to offer an overview of the internet presence of SMEs in Andalusia, along with their intention to reach international targets via the multilingual dissemination of corporate information, as well as determining the variables that influence these factors. To meet these objectives, a sample of 1,425 SMEs has been analyzed. Results show that 52.3% of the companies evaluated had a website and only 10.3% of them offered their content translated to, at least, one language, and that variables such as company size, area of specialty, and location may have an impact on these two aspects. The findings reveal that more research and policies are required to support SMEs in their digitalization and internationalization process.

## KEYWORDS

Companies, Health, Internet, Multilingual Information, SMEs, Translation, Web, Web Translation

## INTRODUCTION

The information society provides great opportunities for companies when it comes to pursuing their professional activity and offering their products and services to clients and customers. ICTs have meant great change at all levels of society, including the business sphere, as they allow messages to reach a global audience at a considerably reduced cost. Consequently, ICTs are a good indicator of the ability of companies to modernize and compete in globalized environments (Peris-Ortiz et al., 2014). These environments undoubtedly pose new challenges and offer competitive opportunities, such as the opening of international markets both for large firms and corporations and for small and medium-sized enterprises (SMEs) (Chhibber & Chadha, 2020; de la Hoz Hernandez et al., 2020; Jean & Kim, 2019). Therefore, this research shares the vision of Alcaide et al. (2013) and Ferreira

DOI: 10.4018/JGIM.20211101.aa24

This article published as an Open Access article distributed under the terms of the Creative Commons Attribution License (<http://creativecommons.org/licenses/by/4.0/>) which permits unrestricted use, distribution, and production in any medium, provided the author of the original work and original publication source are properly credited.

et al. (2018), who remarks that, despite the economic sphere being demanding and challenging for SMEs, they can take advantage of the elements provided by ICTs to create a solid internet presence allowing them to take their brands to their target audiences. This presence is achieved by means of the internet and the world wide web, which are great allies for the dissemination of corporate and commercial information, allowing SMEs to access global markets, interact with potential customers and improve their corporate image (Chaffey & Smith, 2013; Olvera-Lobo & Castillo-Rodríguez, 2018). As a result, it is undoubtable that a corporate website is one of the most important public relations vehicles for a company, as it enables them to foster engagement and gain the attention of users (Alcaide et al., 2013; Kotler & Armstrong, 2007; Osakwe et al., 2016; Peris-Ortiz et al., 2014).

Nevertheless, it is important to have into consideration the fact that opening international markets poses a great challenge for SMEs as they face language and cultural barriers, particularly, as regards regions with strong tourism and immigration flows. This is the case of Spain, the second most important country in the world in terms of receiving international tourists (World Tourism Organization, 2019) and one of the top five countries in Europe with the highest migrant population (Eurostat, 2019).

The scope of the present study is based on variables such as the location, area of specialty and the size of the companies, following the conceptualization proposed by Simmons et al. (2008), more specifically the hypothesis 7 states that “size, and size gradation, will not necessarily limit a small business in its website adoption compared to companies increasing in size gradation” (p.375).

The selection of Andalusia as the specific focus of this study is motivated for two key factors i) it is the most populated region in Spain (Instituto Nacional de Estadística, 2019b) and ii) it presents a linguistic and cultural context that is remarkably rich and diverse due to tourism and migrations (Instituto Nacional de Estadística, 2019a; 2020).

In the light of this scenario, this research addresses the following research questions:

1. Are health SMEs from Southern Spain taking advantage of the benefits of having corporate websites?
2. Are health SMEs from Southern Spain aware of the potential of a translated website for attracting foreign clients and entering new markets?
3. Which are the variables that influence the fact of having or not a corporate website and translating it or not?

The aim of this paper, therefore, is to offer an overview of the internet presence of Andalusian healthcare SMEs, together with their intention of reaching international targets via the multilingual dissemination of corporate information, as well as determining what variables influence these factors.

## **BACKGROUND**

### **SMES Situation in Europe and Spain**

In the European Union (EU), 99.8% of all enterprises—save for the financial business sector—are SMEs (Muller et al., 2019) and 77% of them have a website (Eurostat, 2018). As regards the situation in Spain, according to the latest official report (Dirección General de Industria y de la Pequeña y Mediana Empresa, 2019), the data coincides with the European situation, given that 99.8% of the Spanish business fabric is comprised of SMEs. However, the numbers corresponding to the use of websites is slightly higher, with 78.2% of Spanish SMEs having a website. Catalonia, Madrid, Valencia, and Andalusia are the autonomous regions that contain the most SMEs, over 60% of the total in Spain. Specifically, 508,648 small and medium enterprises in Andalusia make up 99.92% of the business fabric of this region. In terms of Web 2.0 tool usage, according to the aforementioned report, Andalusia follows the national and European trend, with 70.6% of SMEs having a website.

Regarding business activity by sector, according to data from the latest report from the General Secretariat for Industry and Small and Medium Enterprises (Dirección General de Industria y de la Pequeña y Mediana Empresa, 2020), 81.4% of Spanish companies carry out their activity in the services sector. In the case of Andalusia, the figure is quite similar as 81.9% belong to this sector (Instituto de Estadística y Cartografía de Andalucía, 2018). Within it, healthcare is the second biggest group as regards business creation in net terms (Dirección General de Industria y de la Pequeña y Mediana Empresa, 2020). These companies belong to what is referred to as Group Q: Healthcare and social services activities according to the CNAE-2009 classification (Spanish National Classification of Economic Activities), which is divided into various subgroups: hospital activities; medical and dentistry activities; and other healthcare activities (Instituto Nacional de Estadística, 2009).

Under this scenario, it is a self-evident fact that SMEs are a key element in both the Spanish and Andalusian economy and, as a result, several initiatives have been set up. At national level, amongst the objectives established by the Digital Agenda for Spain, driven by the Ministry of Industry, Energy and Tourism (Ministerio de Industria, 2013), are the use of ICTs to improve SME productivity and competitiveness. This has translated over to autonomous regional level, in the case of Andalusia, in the development of the Horizon 2020 Strategic Plan for the Internationalization of the Andalusian Economy (Junta de Andalucía, 2015). For its part, the main objective of the 2020 Stimulus Strategy for the Andalusia ICT Sector is to favor the development and consolidation of the ICT sector in Andalusia (Junta de Andalucía, 2017a). Finally, one of the challenges of the Digital Enterprise Action Plan is to improve the establishment of ICTs in Andalusian SMEs (Junta de Andalucía, 2016).

It has been evidenced that, both at national and regional level, internationalization and digitalization are key aspects for SMEs. Therefore, the focus of this research is on these two aspects as they will foster Andalusian healthcare SMEs competitiveness at international levels, given that could open an important market niche in view of the strong presence of international tourism and the current multiculturalism present in the region.

### **Multilingual dissemination of corporate information**

Following the approach of Korsakiene & Tvaronavičiene (2012), internationalization is understood as a complex process which involves the expansion of companies' operations to foreign markets and this process can also result from punctual and independent actions. Nowadays, the globalized market and ICTs have given SMEs valuable opportunities to reach potential international clients. However, as Clavijo-Olmos (2018) remarks, entering new markets requires cultural knowledge and localizing language—adapting the translation language to a specific culture or locale—to be close to customers and stakeholders. In addition, it is key for managers to encourage transcultural communication, which implies transcending cultural differences. (Christiansen et al., 2014).

Given the fact that a website, which is a product itself, can potentially be tool for global advertising and for opening new markets, it is essential for SMEs to develop cultural capabilities and language skills as they will enable them to attract foreign clients (Tiessen et al., 2001). To this end, having their corporate websites translated into different languages helps SMEs to create a friendly environment, generate engagement, develop a strong branding strategy, and increase their competitive strength (Chhibber & Chadha, 2020; Clavijo-Olmos, 2018; Olvera-Lobo & Castillo-Rodríguez, 2018). In addition, website localization—the cultural adaptation of the content and language of a website for a specific locale—contribute to the internationalization of SMEs, overcoming the linguistic and cultural barriers of internet users from different socio-cultural and linguistic contexts, thus improving SME competitiveness in a globalized environment (Cermak & Smutny, 2017; Gutiérrez-Artacho & Olvera-Lobo, 2017a; Zhu, 2016).

### ***Website Translation and Localization***

There is wide research outlining the importance of website translation or localization for business internationalization. For instance, Ahlfors and Fang, (2017) studied the relationship between firm

internationalization level in online business and their language strategy. Their findings revealed that language decisions are statistically significant in the geographical expansion of companies and draw attention to the importance of online language strategies for international expansion. Other authors have highlighted the impact of localization on SME business and their findings showed that localization makes the buying experience easier, influences the purchasing behavior of customers and contributes to trust and personal assurance with local merchants (Chhibber & Chadha, 2020; Singh et al., 2006). For her part, Chiocchetti, (2018) conducted research into bilingual and multilingual regions and analyzed how SMEs managed communications. The data revealed that companies which hired foreign language speakers were more likely to be successful in foreign language markets.

Regarding website localization, which is of paramount importance for achieving successful website international outreach, several authors have proposed frameworks for analyzing the overall quality of this aspect (Cermak & Smutny, 2017; Singh et al., 2009, 2012) and some of these studies determined that, in general, the companies analyzed emphasized content translation over localization in terms of navigation, graphics, colors and other culturally relevant content (Singh et al., 2009, 2012). In a similar approach, other authors (Medina Reguera & Ramírez Delgado, 2015) have analysed the quality of localized agro-alimentary exporter SMEs websites and have concluded that there is a generalized lack of quality. In contrast, a more recent study determined that the overall quality of localized websites of SMEs from the chemical sector was acceptable, and that those companies that had their website localized were more internationally visible (Gutiérrez-Artacho & Olvera-Lobo, 2017b), which should be the ultimate goal of website translation and localization. Finally, Rike, (2013) explored the benefits of transcreation in corporate websites, which is a further step in website localization as it involves taking a text in one language and recreating it in another, often entailing (re)creating the message from scratch in order to achieve maximum impact in all markets.

In the light of the reviewed literature, the basic premise of this research is that having a website and translating it is one of the first steps that a SMEs should take in order to attract foreign clients and entering new markets and, thus, beginning its internationalization process. Nevertheless, in relation to the specific subject of this study, there is limited research with regards to offering an overview of the internet presence of healthcare SMEs and the multilingual dissemination of their corporate information as well as the variables that influence these factors. However, some authors (Budiman et al., 2019; Cermak & Smutny, 2017; Pollard, 2000; Zwier, 2017) outline the importance of websites in medical markets as they serve as promotional mediums, improve communication, enhance business process, and often represent the first contact of consumers with the companies, a key element for customer satisfaction. In contrast, other studies remark the importance of offering multilingual and transcreated contents in this sector (Macario & Boyte, 2008; Olvera-Lobo & García-Santiago, 2019; Rivera et al., 2016), as cultural adaptation is particularly relevant for fields often dealing with sensitive content such as the healthcare sector.

Finally, concerning the variables that influence a company to have or not a website Tiessen et al. (2001) described a model of the use of e-commerce by internationalizing Canadian SMEs and discovered that there was a positive link between the size of the company and the size and sophistication of its website: bigger companies were more likely to implementing websites. Another interesting conclusion of their study is that SMEs owners usually limit their e-strategies to attaining web presence, however, they lacked planning concerning the assessment of how the website could add value to their companies, for instance, helping them to adapt to environmental uncertainties or to their limited resources.

## **SAMPLE AND METHODOLOGY**

### **Sampling and Data Description**

The sample was selected using information from the Sectoral Ranking of Companies by Turnover offered by the Spanish source *elEconomista.es*, a daily newspaper with special focus on economics,

**Table 1. Distribution of companies by sector in the study sample**

Sector	Frequency	Percentage
<i>Sector 8610: Hospital activities</i>	42	2.9
<i>Sector 8621: General medical activities</i>	128	9.0
<i>Sector 8622: Specialized medical activities</i>	343	24.1
<i>Sector 8623: Dentistry activities</i>	496	34.8
<i>Sector 8690: Other healthcare activities</i>	416	29.2
<b>Total</b>	1425	100.0

finance, and business. The data from this Company Ranking comes from the INFORMA D&B S.A.U. (S.M.E.) database—which boasts the Spanish Association for Standardization and Certification (AENOR) quality certificate—and is fed from a number of public and private sources, including the Spanish Official Companies Register Gazette, the Official Accounts Records, the Official State, Autonomous Regional and Provincial Gazettes, national and regional press, ad hoc studies and other publications.

The selected companies belong to Group Q: Healthcare and social services activities according to CNAE classification. In this work the focus has been on healthcare activities, which include different sectors: hospital activities (Sector 8610); general medical activities (Sector 8621); specialized medical activities (Sector 8622); dentistry activities (Sector 8623); and other healthcare activities (Sector 8690). The company data were compiled between the months of May and June 2019.

In Spain, at the time of the data collection, there were 11978 companies listed in the national ranking that belong to the healthcare sector, 95.9% of which were SMEs. In the case of Andalusia, the data from the 1487 companies included in the ranking were collected and filtered to discard those records corresponding to large international corporations or franchises as they cannot be considered as SMEs, companies who had ceased their commercial activity, and companies whose description of the company purpose did not coincide with the activities specific to the healthcare sector. The final sample was comprised by the data of 1425 SMEs belonging to the healthcare sector, which in this case corresponds to the population of this sector in the region, and which represent 12.4% of the sector at national level according to the Sectoral Ranking of Companies by Turnover. Table 1 shows the distribution of companies by sector.

### **Description of Variables**

First, the data included in the Sectoral Ranking of Companies by Turnover were compiled. These data were as follows: company name, commercial or brand name (where available), size according to turnover, location, specialty area (where available), website address (where available). Later, it was determined whether the companies had a corporate website or not. The websites were examined to check whether they were translated or not and, in the affirmative cases, the number of languages and the translation languages were registered.

### **Size According To Turnover**

The sample was made up of 278 medium companies (19.5%) and 1147 small companies (80.5%). The total sample comprised 1425 SMEs, as previously stated.

### **Location**

Table 2 shows frequency distribution of the companies within the Andalusian provinces according to their fiscal domicile.

Table 2. Distribution of companies by location in the study sample

Location	Frequency	Percentage
<i>Almeria</i>	95	6.7
<i>Cadiz</i>	189	13.3
<i>Cordoba</i>	106	7.4
<i>Granada</i>	137	9.6
<i>Huelva</i>	59	4.1
<i>Jaen</i>	58	4.1
<i>Malaga</i>	372	26.1
<i>Seville</i>	409	28.7
<b>Total</b>	1425	100.0

### Specialty Area

The specialty area was determined according to the index established by the Spanish General Council of Official Medical Colleges and to the classification of medical specialties established by Spanish Royal Decree 183/2008 (Ministerio de la Presidencia, 2008; Organización Médica Colegial, 2007). Some of the stated purposes of the companies included in the ranking records did not exactly correspond to any of the specialties comprised in the two indexes used; thus, these companies were included in the most related area. On the other hand, the following categories were included, even if they were not medical specialties, as a significant number of the analyzed companies offered related services. These categories were: polyclinics and hospitals; dentistry; legal medicine and injury lawyers; health or funeral transport; manufacture and/or sale of medical devices; intermediation services; and other healthcare services. Additionally, those companies whose specialty area could not be clearly identified—either because the companies did not have a website or because their company purpose was not stated in the record of the ranking—were included in a separate category named unidentified. As the design of this study is transactional, descriptive and correlational, the minimum sample size should be 30 cases per group (Hernández-Sampieri et al., 1991), so those specialty areas with less than 30 companies were grouped in the other medical specialties category. Table 3 shows the frequency distribution of companies according to their specialty area.

### Website

In the cases in which company websites were not available in the national ranking record, they were located via internet searches—both using company and/or commercial name, when the latter appeared in the information from the source used, i.e., *eEconomista.es*. In those cases where it was not possible to locate the link to the company website, or to verify the effective belonging of a specific website to a company (consulting information on the legal notice, address, etc.), it was determined that the company did not have, or it was impossible to locate, a website. In addition, all the websites reporting errors or under construction were discarded, meaning only fully functional websites were considered for the analysis.

### Translated Website and Languages

Once the company having a website was determined one way or the another, the affirmative cases were examined by an expert translator in order to check whether or not they were translated and, in the affirmative cases, into how many and which languages. Those websites offering Machine Translation widgets were not considered. Language data was compiled according to the ISO 639-1 standardized

**Table 3. Distribution of companies by specialty area in the study sample**

Specialty area	Frequency	Percent
<i>Polyclinics and hospitals</i>	115	8.1
<i>Pathology-Anatomic &amp; Clinical</i>	34	2.4
<i>Plastic Surgery</i>	69	4.8
<i>Radiology-Diagnostic</i>	49	3.4
<i>Obstetrics and Gynecology</i>	50	3.5
<i>Ophthalmology</i>	57	4.0
<i>Physical Medicine &amp; Rehabilitation</i>	77	5.4
<i>Orthopedic Surgery and Traumatology</i>	32	2.2
<i>Dentistry</i>	507	35.6
<i>Legal medicine and injury lawyers</i>	33	2.3
<i>Manufacture and/or sale of medical devices</i>	48	3.4
<i>Intermediation services</i>	44	3.1
<i>Other medical specialties</i>	152	10.7
<i>Other healthcare services</i>	71	5.0
<i>Unidentified</i>	87	6.1
<b>Total</b>	1425	100.0

nomenclature (International Organization for Standardization, 2002). Thus, the translation languages available were Spanish (ES); English (EN); French (FR); German (DE); Italian (IT); Catalan (CA); Portuguese (PT); Finnish (FI); Russian (RU); Chinese (ZH); Swedish (SV); Danish (DA); Norwegian (NO); Basque (EU); Galician (GL); and Arabic (AR).

## Data Analysis

The whole data collection and analysis process is summarised in Figure 1. The data were analyzed using frequency distribution and the Chi-square automatic interaction detection (CHAID) decision tree technique, which permits the categorization of dependent variables and the detection of the interaction between variables using the most significant predictors (Kass, 1980). The SPSS software platform was used for the data analysis while MS Excel was used for creating the charts.

## RESULTS

### Internet Presence of SMEs

More than half (52.3%) of the SMEs analyzed had a fully functional website, whereas the rest—47.7%—either lacked a website or the one they had reported errors or was under construction.

The CHAID algorithm was used to identify the most important drivers of the variable website. For this analysis those companies whose specialty area could not be identified were discarded, as they were not relevant for the statistical analysis (87 companies). The summary of the model shows that only the variables size and specialty have predictive validity, whereas the location variable does not have statistical significance. The variable size presents the strongest relationship with the variable website. The accuracy rate of the model is 85.5%.

Figure 1. Flow chart of the analysis process

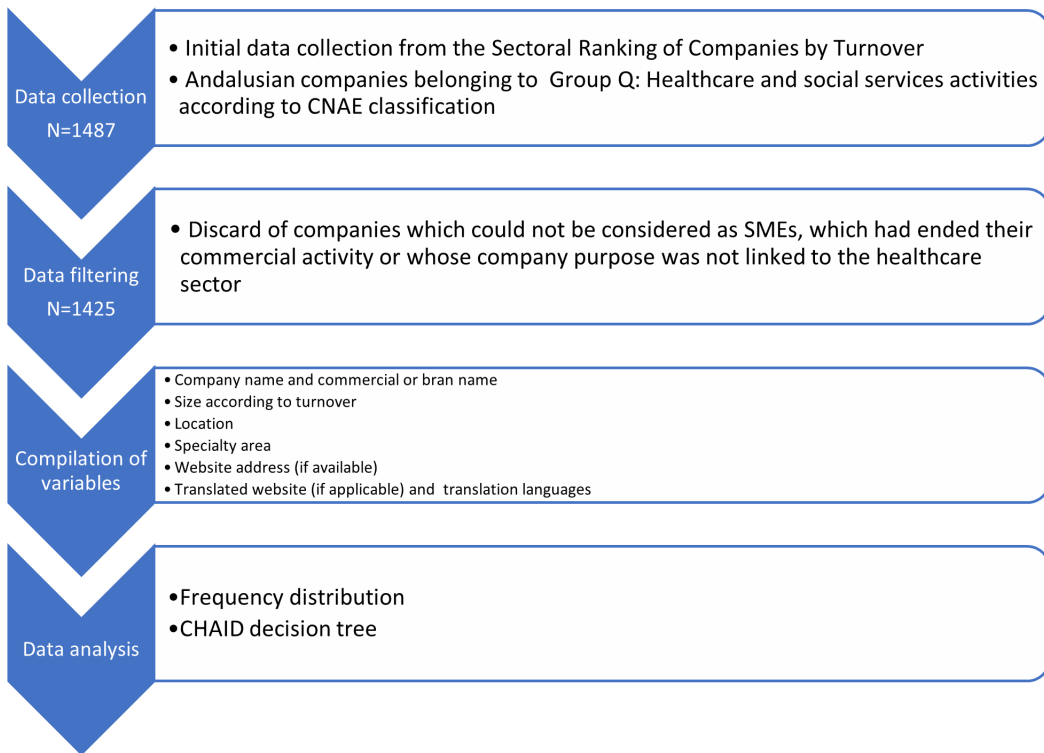

In Figure 2 it can be observed that 55.9% of the 1338 companies included in the model have a fully functional website. The split variable is company size, having the most significant effect on whether they have a website or not ( $p=0.000$ , Chi-square=20.603,  $df=4$ ). Node 2 shows that the model predicted that 68.3% of medium-sized companies do have a website whereas for small companies (Node 1) this percentage is slightly reduced (52.8%).

Branches from Nodes 1 and 2 generated 6 nodes which correspond to specialty area, the second split variable. For small-sized companies ( $p=0.000$ , Chi-square= 54.671,  $df=2$ ), there is a wide variety regarding specialty areas (Nodes 3, 4 and 5). The highest rate (67%) for small-sized companies is found in the specialty areas of legal medicine and injury lawyers, orthopedic surgery and traumatology, physical medicine and rehabilitation, plastic surgery, pathology-anatomic and clinical and polyclinics and hospitals. On the contrary, the specialty areas corresponding to other health services, intermediation services, manufacture and/or sale of medical devices, ophthalmology and radiology-diagnosis present the lowest rates (33%). Medium-sized companies ( $p=0.003$ , Chi-square=38.557,  $df=2$ ) present the highest rate of the model—94% (Node 8)—for companies whose specialty areas were legal medicine and injury lawyers, ophthalmology, obstetrics and gynecology and polyclinics and hospitals.

### Translated Websites

Concerning the availability of translation, of all the SMEs which had a website, a total of 745, only 77 (10.3%) of them had their website translated, at least, to one language. Within these 77 companies, in Table 4 it can be observed that more than a half, 57.3%, of the companies that translate their website do it to just one language, so their website is available in two languages. 19.5% of the companies offer their website in three different languages, 10.4% of them in four languages and 6.5% in five



Figure 2. Decision tree using the CHAID method for the variable website

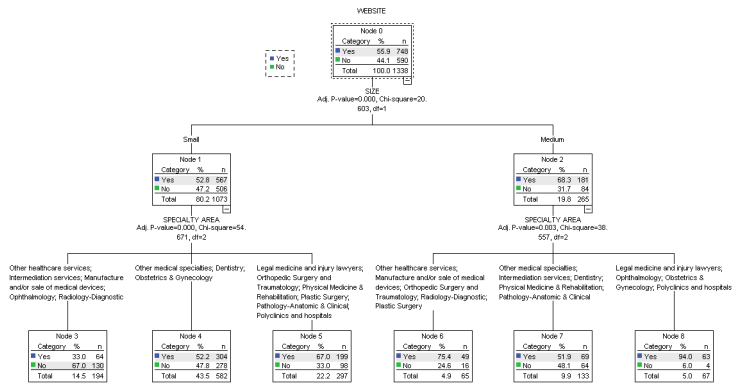

languages. Therefore, 93.5% of the companies offered their website in less than 6 languages. On the contrary, only 5 of the 77 SMEs analyzed translated their website to more than five languages. The mean is 2.95 languages with a standard deviation of 1.538.

In Figure 3 it can be observed that, among the languages available in the analyzed websites, English is the majority language, just one of the websites did not have English among the languages offered. On its part, Spanish was available in 74 websites, it is remarkable the fact that, despite being Spanish companies, there are 3 companies which do not offer their websites in Spanish, but their main website is in English and translated to Russian, Swedish or Finnish. The three cases correspond to medium sized companies located in Malaga whose areas of expertise were polyclinics and hospitals (website in English and Russian); dentistry (website in English and Swedish) and physical medicine and rehabilitation (website in English and Finnish). Among the languages available—in smaller proportion—are French, German, Italian, Portuguese, Russian and Swedish. Finally, Catalan, Norwegian, Finnish, Chinese, Danish, Basque, Galician and Arab have the lowest frequencies—one or two cases for each language.

Concerning the size of the companies that translated their websites, 62.3% –48 companies—are small sized companies whereas the remaining 37.7% –29 companies—are medium sized companies.

Table 4. Frequency and percentages of available languages

Number of available languages	Frequency	Percentage	Cumulative percentage
2	44	57.1	57.1
3	15	19.5	76.6
4	8	10.4	87.0
5	5	6.5	93.5
6	2	2.6	96.1
7	1	1.3	97.4
8	1	1.3	98.7
10	1	1.3	100.0
<b>Total</b>	<b>77</b>	<b>100.0</b>	

Figure 3. Available languages in the analyzed websites

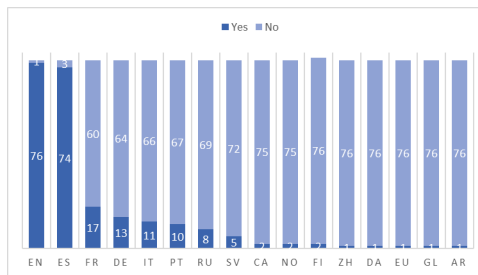
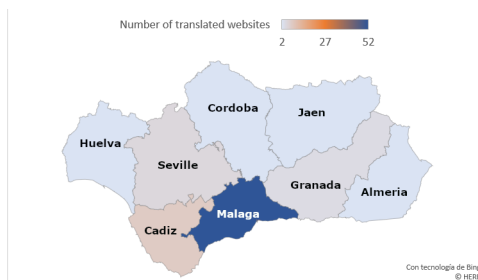

Figure 4. Location of the companies with translated websites



With regard to the location of the SMEs (Figure 4), most of the companies are located in Malaga (67.5%). Cadiz is the second region with more translated websites (10.4%). The rest of Andalusian provinces have percentages lower than 10%.

As far as medical specialties are concerned (Figure 5), 26% of the companies that translate their website belong to the dentistry sector, followed by companies specialized in other medical specialties, obstetrics and gynecology, polyclinics and hospitals and companies devoted to plastic and reconstructive surgery. The rest of the specialties analyzed present percentages lower than 10%.

CHAID algorithm was used to identify which were the most important drivers of the variable translated website. For this analysis, those companies whose specialty area could not be identified were discarded (87 companies). The summary of the model shows that only the location and size variables have predictive validity whereas specialty does not have statistical significance. The variable location presents the strongest relationship with the variable translated website. The accuracy rate of the model is 89.9%.

Figure 5. Specialty areas of the companies with translated websites

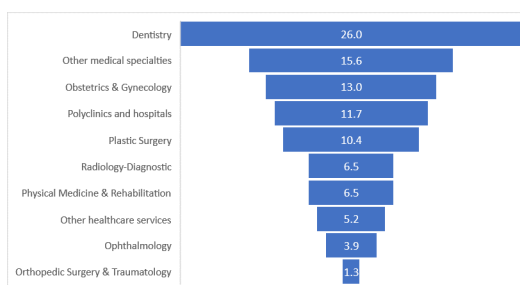
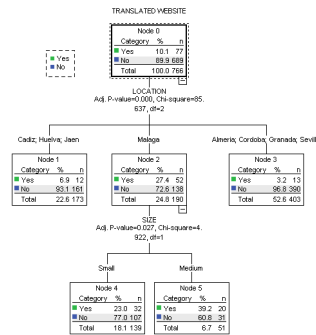

Figure 6. Decision tree using the CHAID method for the translated website variable



In Figure 6 it can be observed that only 10.1% of the 766 companies with a website translated their content. The split variable is the location of the company, having the most significant effect on whether companies translated their website or not ( $p=0.000$ , Chi-square=85.637,  $df=2$ ). Node 2 shows that the model predicted that 27.4% of the companies located in Malaga translated their websites whereas those from the remaining locations (Nodes 1 and 3) present very low translation rates (6.2% and 3.2%). The branch from Node 2 generated 2 nodes which correspond to company size, which is the second split variable ( $p=0.027$ , Chi-square= 4.922,  $df=1$ ). For small-sized companies, 23% of those located in Malaga translated their websites, whereas for medium-sized enterprises the rate increases to 39.2%.

## DISCUSSION

The purpose of this study was to examine the presence of Andalusian healthcare SMEs on the internet, as well as the multilingual dissemination of their corporate websites and the variables that influence these factors. This study adds to existing SMEs literature by offering a detailed overview of both the situation of Andalusian healthcare SMEs and the variables that may influence companies for having a website and translating its content. In this sense, a similar study (Sandoval & Saadi, 2015) conducted in the horticulture sector in Spain studied the translation of corporate websites considering translation as a marketing tool for commercializing products, and their results were similar to the ones presented in the study as around half of the companies did not have a website and there was a generalized lack of translations in the 147 companies analyzed.

These results lead to the suggestion that the initiatives implemented by the national and autonomous governments have improvement opportunities. The report included in the Digital Enterprise Action Plan (Junta de Andalucía, 2016) stated that most companies with over 50 employees (medium companies) had a website, while this percentage was reduced to 70% in the case of small enterprises. Results for the healthcare sector are far removed from those reported by the autonomous government, as only 52.3% of the companies analyzed had a website, with this rate increasing to 65.1% in the case of medium-sized companies and dropping to 49.1% for small-sized ones. These results are even further from the national average, which is 78.2% (Dirección General de Industria y de la Pequeña y Mediana Empresa, 2019).

The objective 1 (O1) of the Digital Enterprise Action Plan (Junta de Andalucía, 2016) was to raise awareness among SMEs of the importance of digital transformation. For this objective, one of the indicators was the percentage of companies with an internet connection and website; therefore, in the light of the results, there appears to still be a long way to go for Andalusian health SMEs.

Concerning multilingual dissemination of corporate information, only 10.3% of the SMEs analyzed had their website translated into at least one language. Despite the numerous studies outlining

the importance of web translation and localization for SME internationalization (Ahlfors and Fang, 2017; Cermak and Smutny, 2017; Chhibber and Chadha, 2020; Clavijo-Olmos, 2018; Gutiérrez-Artacho and Olvera-Lobo, 2017a; Singh et al., 2012), the findings reveal there is a generalized lack of awareness of the benefits of offering a website adapted to several languages and cultures. To this end, the national government has recently developed a plan for strengthening Spanish SMEs in a global, digital, innovative and changing environment which includes among its action lines improving information on services and resources available to foster internationalization (Secretaría General de Industria y de la Pequeña y Mediana Empresa, 2020).

### **Limitations and Future Research Directions**

This study is not without limitations. Firstly, it is focused on healthcare SMEs from Andalusia and, as such, its contributions should not be considered as a portrait of the national situation. Consequently, to overcome this limitation, future research should be conducted that takes in other regions and economic sectors.

Secondly, despite having considered all the variables available from the records of the Sectoral Ranking of Companies by Turnover, other variables may affect the fact of a company having and translating its corporate website. Future research could include other variables such as number of employees or the company founding date, among others. In addition, future works could deepen the existing conceptualizations about the reasons leading a company to having a corporate website or not (Simmons et al., 2008), and the subsequent translation of it. This approach should include qualitative methods such as interviews, open questionnaires and focus groups. Moreover, cost could be one of the reasons behind the decision not to translate websites, and more affordable alternatives should be studied such as implementing machine translation processes, followed by human post-editing (Bowker & Ciro, 2018). Finally, the quality and cultural adaptation of the translated websites could be examined in light of existing frameworks (Cermak and Smutny, 2017; Singh et al., 2009, 2017) and taking into account the particularities of medical translation (Jiménez-Crespo & Tercedor Sánchez, 2017).

### **CONCLUSION**

This paper contributes to furthering knowledge on the situation of SMEs in terms of their internet presence and the multilingual dissemination of their corporate information. From a theoretical point of view, this article contributes to existing literature on website translation as a tool to foster SME internationalization. While prior research has highlighted the importance of websites as promotion and commercialization tools (Alcaide et al., 2013; Kotler and Armstrong, 2007; Osakwe et al., 2016; Peris-Ortiz et al., 2014) as well as their role in the internationalization process (Ahlfors and Fang, 2017; Cermak and Smutny, 2017; Chhibber and Chadha, 2020; Clavijo-Olmos, 2018; Gutiérrez-Artacho and Olvera-Lobo, 2017a; Singh et al., 2012), this study offers a detailed overview of the internet presence of healthcare SMEs in southern Spain, presenting a considerable expansion of the sample in similar research (Sandoval and Saadi, 2015), and taking into account healthcare, one of the most important and growing economic sectors in Spain.

In addition, this study has empirically analyzed the variables that have an influence on whether a company has a website or not, and its subsequent translation. The findings of this paper also extend to practitioners, as they can identify the variables found to influence internet presence and website translation and use them to their benefit, as having a translated and localized website would mean a significant improvement in their competitiveness. In this sense, company size had the most noticeable effect on companies having a website or not, with medium-sized enterprises found to be more likely to have one. The specialty area was the other variable that had the most effect on determining whether a company had a website or not; thus, the vast majority of medium-sized companies specializing in legal medicine and injury lawyers; ophthalmology, obstetrics and gynecology and polyclinics and hospitals had one.

Concerning translation, only around 10% of the companies had a translated website and more than half of those that translated their site did so to just one language. The most important factor driving the website translation variable was found to be company location, with most companies translating their websites located in the province of Málaga. This situation can be explained by it being the province with the highest foreign population rate, mainly from the United Kingdom, which also explains the prevalence of the English language among the translated languages, and by it being the main tourist destination in Andalusia (Instituto de Estadística y Cartografía de Andalucía, 2019; Junta de Andalucía, 2017b). In addition, company size was found to have predictive value as well with, as in the previous case, medium-sized companies presenting the highest rate of translated websites.

Finally, this study also has research implications for policymakers. There is still room for improvement regarding the initiatives put into practice to date, especially those concerning small-sized SMEs, as they have proved to be the companies presenting the lowest rates in this study. More research and policies are required to support Spanish SMEs in their digitalization and internationalization process, considering that having a website and the multilingual dissemination of its corporate information are key factors for these processes.

## **ACKNOWLEDGMENT**

This work was supported by the Spanish Ministry of Science, Innovation and Universities (MCIU) [RTI2018.093348.B.I00, FPU17/00667]; the Spanish State Research Agency (AEI) [RTI2018.093348.B.I00]; and the European Regional Development Fund (ERDF) [RTI2018.093348.B.I00].

## REFERENCES

- Ahlfors, U. R., & Fang, M. (2017). Language in globalised interactive business: Adaptation vs. standardisation. *International Journal of Electronic Business*, 13(2/3), 143–162. doi:10.1504/IJEB.2017.083292
- Alcaide, J. C., Bernués, S., Díaz-Aroca, E., Espinosa, R., Muñoz, R., & Smith, C. (2013). *Marketing y Pymes. Las principales claves de marketing en la pequeña y mediana empresa*. Academic Press.
- Bowker, L., & Ciro, J. B. (2018). Localizing websites using machine translation. Exploring connections between user eXperience and translatability. In C. Sin-wai (Ed.), *The Human Factor in Machine Translation* (pp. 7–29). Routledge. doi:10.4324/9781315147536-2
- Budiman, A., Bačík, R., Fedorko, R., Ivanková, V., Turáková, A., & Kovařová, E. (2019). Healthcare facilities website and their impact on customer satisfaction from the perspective of customer relationship management (CRM). *Polish Journal of Management Studies*, 19(2), 75–88. doi:10.17512/pjms.2019.19.2.06
- Cermak, R., & Smutny, Z. (2017). A Framework for Cultural Localization of Websites and for Improving Their Commercial Utilization. In S. Sarma (Ed.), *Global Observations of the Influence of Culture on Consumer Buying Behavior* (pp. 206–232). IGI Global. doi:10.4018/978-1-5225-2727-5.ch013
- Chaffey, D., & Smith, P. R. (2013). *EMarketing eXcellence : planning and optimizing your digital marketing*. Routledge. doi:10.4324/9780203082812
- Chhibber, R., & Chadha, C. (2020). Adoption of localization in e-commerce: Impact of localization on emerging smes. *Lecture Notes in Electrical Engineering*, 612, 419–432. doi:10.1007/978-981-15-0372-6\_34
- Chiocchetti, E. (2018). Small- and medium-sized enterprises in a multilingual region: Best practices in multilingualism or missed opportunities? *European Journal of International Management*, 12(1/2), 138–157. doi:10.1504/EJIM.2018.089040
- Clavijo-Olmos, S. (2018). Breaking Language and Cultural Barriers: A Key to Improve Stakeholder Relationships of SMEs. In R. Pérez-Urbe (Ed.), *Handbook of Research on Intrapreneurship and Organizational Sustainability in SMEs* (pp. 73–94). IGI Global. doi:10.4018/978-1-5225-3543-0.ch004
- de la Hoz Hernandez, J., Caraballo, H. M., Ventura, J. M., Palma, H. H., Herazo, J. C. M., Orozco, S. M. A., Toscano, A. R., & Silva, J. (2020). Good Practices in Logistics for SMEs: A Strategy for the Global Marketplace. *Smart Innovation. Systems and Technologies*, 167, 435–443. doi:10.1007/978-981-15-1564-4\_40
- Dirección General de Industria y de la Pequeña y Mediana Empresa. (2019). *Estadísticas Pyme. Evolución e indicadores*. <http://www.ipyme.org/Publicaciones/Estadisticas-PYME-2018.pdf>
- Dirección General de Industria y de la Pequeña y Mediana Empresa. (2020). *Retrato de la Pyme*. <http://www.ipyme.org/Publicaciones/Retrato-PYME-DIRCE-1-enero-2019.pdf>
- Eurostat. (2018). *Internet advertising of businesses-statistics on usage of ads Statistics Explained*. <https://ec.europa.eu/eurostat/statisticsexplained/>
- Ferreira, T., Gutiérrez-Artacho, J., & Bernardino, J. (2018). Freemium Project Management Tools: Asana, Freedcamp and Ace Project. In Á. Rocha, H. Adeli, L. P. Reis, & S. Costanzo (Eds.), *Trends and Advances in Information Systems and Technologies. WorldCIST'18 2018. Advances in Intelligent Systems and Computing* (pp. 1026–1037). Springer. doi:10.1007/978-3-319-77703-0\_100
- Gutiérrez-Artacho, J., & Olvera-Lobo, M. D. (2017a). Web Localization as an Essential Factor in the Internationalisation of Companies: An Approximation of Spanish SMEs. In Á. Rocha, A. Correia, H. Adeli, L. Reis, & S. Costanzo (Eds.), *Recent Advances in Information Systems and Technologies. WorldCIST 2017. Advances in Intelligent Systems and Computing* (Vol. 569, pp. 511–520). Springer. doi:10.1007/978-3-319-56535-4\_52
- Gutiérrez-Artacho, J., & Olvera-Lobo, M. D. (2017b). Web Localization of Spanish SMEs: The Case of Study in Chemical Sector. *Journal of Information Systems Engineering & Management*, 2(3), 15. doi:10.20897/jisem.201715
- Hernández-Sampieri, R., Fernández Collado, C., & Baptista Lucio, P. (1991). *Metodología de la Investigación*. McGraw-Hill.

- Instituto de Estadística y Cartografía de Andalucía. (2018). *Nota Divulgativa. Directorio de Empresas y Establecimientos con Actividad Económica en Andalucía. 1 de enero de 2017*. <https://www.juntadeandalucia.es/institutodeestadisticaycartografia/direst/notaprensa.htm>
- Instituto Nacional de Estadística. (2009). *Clasificación Nacional de Actividades Económicas (CNAE-2009)*. [https://www.ine.es/dyngs/INEbase/es/operacion.htm?c=Estadistica\\_C&cid=1254736177032&menu=ultiDatos&idp=1254735976614](https://www.ine.es/dyngs/INEbase/es/operacion.htm?c=Estadistica_C&cid=1254736177032&menu=ultiDatos&idp=1254735976614)
- Instituto Nacional de Estadística. (2019a). *Cifras de Población (CP). Estadística de Migraciones (EM)*. [https://www.ine.es/prensa/cp\\_j2018\\_p.pdf](https://www.ine.es/prensa/cp_j2018_p.pdf)
- Instituto Nacional de Estadística. (2019b). *Población por comunidades y ciudades autónomas y tamaño de los municipios*. <https://www.ine.es/jaxiT3/Datos.htm?t=2915>
- Instituto Nacional de Estadística. (2020). *Estadística de Movimientos Turísticos en Fronteras*. <https://www.ine.es/daco/daco42/frontur/frontur0120.pdf>
- International Organization for Standardization. (2002). *ISO - ISO 639 Language codes*. <https://www.iso.org/iso-639-language-codes.html>
- Jean, R. J., & Kim, D. (2019). Internet and SMEs' internationalization: The role of platform and website. *Journal of International Management*. Advance online publication. doi:10.1016/j.intman.2019.100690
- Jiménez-Crespo, M. A., & Tercedor Sánchez, M. (2017). Lexical variation, register and explicitation in medical translation. *Translation and Interpreting Studies*, 12(3), 405–426. doi:10.1075/tis.12.3.03jim
- Junta de Andalucía. (2015). *Plan Estratégico de Internacionalización de la Economía Andaluza Horizonte 2020*. [https://www.juntadeandalucia.es/export/drupaljda/PLAN ESTRAT INTERNACIONALIZ HORIZ 2020\\_0.pdf](https://www.juntadeandalucia.es/export/drupaljda/PLAN ESTRAT INTERNACIONALIZ HORIZ 2020_0.pdf)
- Junta de Andalucía. (2016). *Plan de Acción Empresa Digital 2020*. <https://www.empresa.andaluciaesdigital.es/documents/398962/520208/Memoria+Plan+EmpresaDigital/d3ae69a3-3ccd-4244-8fe5-d66104e569e0>
- Junta de Andalucía. (2017). *Estrategia de Impulso del Sector Tic. Andalucía 2020*. [https://www.tic2020.andaluciaesdigital.es/documents/20182/378204/TIC2020\(2\).pdf/77467c5f-51af-46b1-951f-998259f82f61](https://www.tic2020.andaluciaesdigital.es/documents/20182/378204/TIC2020(2).pdf/77467c5f-51af-46b1-951f-998259f82f61)
- Junta de Andalucía. (2017b). *Informe Bienal. Andalucía e Inmigración*. [http://www.juntadeandalucia.es/justiciaeinterior/opam/sites/default/files/DOC/INFORME\\_2016\\_17\\_completo\\_versi%C3%B3n%20final%20provincias.pdf](http://www.juntadeandalucia.es/justiciaeinterior/opam/sites/default/files/DOC/INFORME_2016_17_completo_versi%C3%B3n%20final%20provincias.pdf)
- Kass, G. V. (1980). An Exploratory Technique for Investigating Large Quantities of Categorical Data. *Applied Statistics*, 29(2), 119–127. doi:10.2307/2986296
- Kotler, P., & Armstrong, G. (2007). *Marketing. Versión para Latinoamérica*. Atlacomulco: Pearson Educación.
- Macario, E., & Boyte, R. M. (2008). Lost in Translation: Tips for Avoiding Translation “Travesties”. *Health Promotion Practice*, 9(3), 216–219. doi:10.1177/1524839908319169 PMID:18560013
- Medina Reguera, A., & Ramírez Delgado, C. (2015). *Internationalization of industrial small-medium enterprises in an emerging country*. In *TRAlinea*. doi:10.1108/ARLA-10-2018-0223
- Ministerio de Industria de Industria Energía y Turismo. (2013). *Agenda Digital para España*. <https://www.lamoncloa.gob.es/documents/agendadigital150213.pdf>
- Misterio de la Presidencia. (2008). *Real Decreto 183/2008, de 8 de febrero, por el que se determinan y clasifican las especialidades en Ciencias de la Salud y se desarrollan determinados aspectos del sistema de formación sanitaria especializada*. <https://www.boe.es/buscar/doc.php?id=BOE-A-2008-3176>
- Muller, P., Robin, N., Jessie, W., Schroder, J., Braun, H., Becker, L. S., Farrenkopf, J., Aranda-Ruiz, F., Caboz, S., Miroslava, I., Lange, A., Lonkeu, O. K., Mühlischlegel, T. S., Pedersen, B., Privetera, M., Bormans, J., Bogen, E., & Cooney, T. (2019). *Annual Report on European SMEs. Research & Development and Innovation by SMEs*. 10.2873/742338
- Olvera-Lobo, M. D., & Castillo-Rodríguez, C. (2018). Dissemination of Spanish SME information through web 2.0 tools. *Journal of Transnational Management*, 23(4), 178–197. doi:10.1080/15475778.2018.1509422

Olvera-Lobo, M. D., & García-Santiago, L. (2019). Aproximación a las estrategias transcreacionales de la comunicación publicitaria audiovisual en la web. *RISTI - Revista Iberica de Sistemas e Tecnologias de Informacao*, 2019(E24), 90–100.

Organización Médica Colegial. (2007). *Clasificación terminológica y codificación de actos y técnicas médicas*. <https://www.cgcom.es/sites/default/files/nomenclator.pdf>

Osakwe, C. N., Chovancová, M., & Agu, M. (2016). Can micro-enterprises leverage on the adoption of corporate websites to bolster their brand visibility? Examining salient adoption issues in Nigeria. *Information Development*, 32(4), 904–919. doi:10.1177/0266666915573551

Peris-Ortiz, M., Benito-Osorio, D., & Rueda-Armengot, C. (2014). Positioning in Online Social Networks Through QDQ Media: An Opportunity for Spanish SMEs? In I. Gil-Pechuán, D. Palacios-Marqués, M. Peris-Ortiz, E. Vendrell-Vidal, & C. Ferri Ramírez (Eds.), *Strategies in E-Business* (pp. 1–10). New York: Springer Science + Business Media. doi:10.1007/978-1-4614-8184-3\_1

Pollard, K. (2000). The use of websites in medical markets. *Journal of Medical Marketing*, 1(2), 115–122. doi:10.1057/palgrave.jmm.5040020

Rike, S. M. (2013). Bilingual corporate websites-from translation to transcreation? *The Journal of Specialised Translation*, 20, 68–85. [https://www.jostrans.org/issue20/art\\_rike.pdf](https://www.jostrans.org/issue20/art_rike.pdf)

Rivera, Y. M., Vélez, H., Canales, J., Jiménez, J. C., Moreno, L., Torres, J., Vadaparampil, S. T., Muñoz-Antonia, T., & Quinn, G. P. (2016). When a Common Language Is Not Enough : Transcreating Cancer 101 for Communities in Puerto Rico. *Journal of Cancer Education*, 31(4), 776–783. doi:10.1007/s13187-015-0912-2 PMID:26365291

Sandoval, A. C., & Saadi, Z. A. (2015). Elementos de contextualización para la justificación de la (no) traducción de un sitio web corporativo: El sector agroalimentario en España. *InTRAlinea*, 2015, 11–25. <http://www.intraline.org/specials/article/2152>

Secretaría General de Industria y de la Pequeña y Mediana Empresa. (2020). *Marco Estratégico en política de PYME 2030*. [https://plataformapyme.es/SiteCollectionDocuments/EstrategiaPYME/Marco\\_Estrategico\\_Politica\\_PYME\\_2030.pdf](https://plataformapyme.es/SiteCollectionDocuments/EstrategiaPYME/Marco_Estrategico_Politica_PYME_2030.pdf)

Simmons, G., Gillian, A. A., & Durkin, M. G. (2008). A Conceptualization of the Determinants of Small Business Website Adoption Setting the Research Agenda. *International Small Business Journal*, 26(3), 351–389. Advance online publication. doi:10.1177/0266242608088743

Singh, N., Fassott, G., Zhao, H., & Boughton, P. D. (2006). A cross-cultural analysis of German, Chinese and Indian consumers' perception of web site adaptation. *Journal of Consumer Behaviour*, 5(1), 56–68. doi:10.1002/cb.43

Singh, N., Park, J., & Kalliny, M. (2012). A framework to localize international business to business web sites. *The Data Base for Advances in Information Systems*, 44(1), 56–77. doi:10.1145/2436239.2436243

Singh, N., Toy, R. D., & Wright, L. (2009). A Diagnostic Framework for Measuring Web-Site Localization. *Thunderbird International Business Review*, 51(3), 281–295. doi:10.1002/tie.20265

Tiessen, J. H., Wright, R. W., & Turner, I. (2001). A model of e-commerce use by internationalizing SMEs. *Journal of International Management*, 7(3), 211–233. doi:10.1016/S1075-4253(01)00045-X

World Tourism Organization. (2019). International Tourism Highlights. In International Tourism Highlights. World Tourism Organization (UNWTO). doi:10.18111/9789284421152

Zhu, P. (2016). Impact of business cultural values on web homepage design that may hinder international business. *Journal of Technical Writing and Communication*, 46(1), 105–124. doi:10.1177/0047281615600644

Zwier, S. (2017). “On the doctor’s orders”: A pilot study of the effects of website marketing for medical specialist providers under gatekeeping arrangements. *Health Marketing Quarterly*, 34(4), 233–246. doi:10.1080/07359683.2017.1310551 PMID:28467194



*Irene Rivera-Trigueros is a PhD candidate at the Department of Translation and Interpreting of the University of Granada, Spain. She is currently working as a predoctoral researcher at the University of Granada with an FPU contract funded by the Spanish Ministry of Education, Culture and Sports. Her research lines are focused on translation, Machine Translation, post-editing, localization and transcreation.*

*María-Dolores Olvera-Lobo is a Doctor in Documentation, Full Professor at the Department of Information and Communication at the University of Granada (Spain) and teacher at the Faculties of Communication and Documentation, and Translation and Interpreting. She is the principal investigator of the HUM466 Research Group "Scientific Information: Access and Evaluation," PI in national R&D&I projects financed by the Ministry of Economy, Industry and Competitiveness, and in numerous teaching innovation projects at the University of Granada. Her research lines are focused on Information Retrieval, advanced systems in information retrieval, specialized documentation, Web 2.0, translators training and information resources for translators.*