

# Introduction: Varieties of Iconicity

Valeria Giardino · Gabriel Greenberg

Published online: 15 November 2014  
© Springer Science+Business Media Dordrecht 2014

This introduction aims to familiarize readers with basic dimensions of variation among pictorial and diagrammatic representations, as we understand them, in order to serve as a backdrop to the articles in this volume. Instead of trying to canvas the vast range of representational kinds, we focus on a few important axes of difference, and a small handful of illustrative examples. We begin in Section 1 with background: the distinction between pictures and diagrams, the concept of systems of representation, and that of the properties of usage associated with signs. In Section 2 we illustrate these ideas with a case study of diagrammatic representation: the evolution from Euler diagrams to Venn diagrams. Section 3 is correspondingly devoted to pictorial representation, illustrated by the comparison between parallel and linear perspective drawing. We conclude with open questions, and then briefly summarize the articles to follow.

## 1 Types of Iconicity

As early as 1868, Charles S. Peirce distinguished between at least two basic kinds of sign: symbols and icons.<sup>1</sup> As we shall understand these categories, SYMBOLIC

---

<sup>1</sup>We use Peirce's taxonomy as the point of departure for our own, but we don't aspire to exegetical accuracy. In fact, Peirce famously distinguished up to three kinds of sign, including not only symbols and icons, but also *indices*. To simplify our presentation, we will only discuss the first two. Moreover, in 1868, Peirce used the term "likeness" instead of "icon", but later changed his terminology.

V. Giardino (✉)  
Institut Jean Nicod (CNRS - EHESS - ENS), Département d'Etudes Cognitives, Ecole Normale Supérieure - PSL Research University, Paris, France  
e-mail: Valeria.Giardino@ens.fr

G. Greenberg  
UCLA, Los Angeles, CA, USA  
e-mail: ggreenberg@humnet.ucla.edu

representation is exemplified by the lexicons of languages like English, Chinese, or Predicate Logic. It also includes codes like those governing maritime signal flags, Arabic numerals, and emblematic gestures (e.g. the “OK” hand sign). According to a rough first approximation, all forms of symbolic representation are based on arbitrary connections between signs and their contents. Thus, for example, the string “tree” is associated in English with the concept for *tree*, but the association is arbitrary, because the string “dree” would have served just as well. By contrast, ICONIC representations include the likes of drawings, photographs, maps, graphs, Venn diagrams, and depictive gestures (e.g. gestural maps or indicators of size). Such signs are characterized, very roughly, by natural and *non*-arbitrary relations between sign and content, often described as relations of “resemblance.” The relationship between an accurate drawing of a tree and the tree itself is one of intimate correspondence, quite unlike that of the linguistic string; a drawing of a flower would *not* have served just as well.

Both Peirce (1868) and his contemporary Ferdinand de Saussure (1922) imagined a general science of signs, encompassing symbolic, iconic, and other forms of representation. But in the twentieth century, breakthroughs in logic, linguistics, and computer science meant that it was symbolic representation, especially language, which was the focus of philosophical attention. Iconicity remained marginalized and poorly understood. And yet, as matter of actual use, iconic signs have always played a central role in human society, in everything from communication, reasoning, and proof, to planning and navigation. This role has only grown in recent years, with the explosion of diagrams and pictures in social media, digital communication, and the sciences. In this special issue, we seek to bring additional attention to this foundational topic.

To fix ideas, we’ll use the term REPRESENTATION to describe any event, process, state or object which is a vehicle for content, broadly construed. In this sense, there are both symbolic and iconic representations. We may further distinguish between those representations which are purely mental, and those which are instantiated in some publicly perceivable physical medium. For the latter class of public representations we reserve the term SIGN. Thus there are both symbolic signs (“symbols”) and iconic signs (“icons”). There are also complex signs, which combine iconic and symbolic elements, such as advertisements, magazine articles, depictive gestures with speech, and certain kinds of sentences in signed languages (Lascarides and Stone 2009; Schlenker et al. 2013). The articles in this special issue focus specifically on representations which are wholly or primarily iconic, and upon iconic *signs* specifically. They thus bypass some of the more familiar examples of mental iconic representation, including those involved in perception and mental imagery. We propose that, like languages, icons deserve treatment as an independent object of inquiry.

Iconic signs divide naturally, but not necessarily exhaustively, into *pictures* and *diagrams*. Although the terms ‘picture’ and ‘diagram’ admit many readings, under at least one natural precisification they mark a basic distinction in iconic kinds. Among the class of PICTURES we include the likes of perspectival drawings, photographs, paintings, and film clips. Among the class of DIAGRAMS we include the likes of graphs, charts, timelines, and Venn diagrams. The distinction is certainly not a sharp

one, with the likes of maps and pictographs occupying intermediate positions; it may instead reflect polar ends of a spectrum of kinds (Greenberg 2011, 160–163; Casati and Giardino 2013, 118–125). But what characterizes these two classes of sign?

Casati and Giardino (2013, 116) propose that pictures are *perspectival* representations, while diagrams are not. That is, pictures alone necessarily express content which describes the world relative to some spatial viewpoint or perspective. As illustration, consider the following pair of iconic signs.<sup>2</sup>

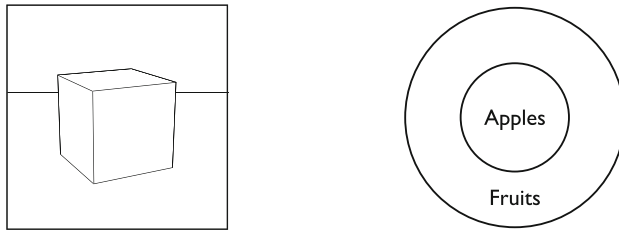

The icon on the left is a picture; it represents a cube from a viewpoint located somewhere above that cube. The icon on the right is a diagram; it involves no such viewpoint. As a corollary, note that the picture might veridically depict the world from one viewpoint, but fail to veridically depict it from another. The same kind of variation of veridicality with viewpoint cannot be applied to the circle-diagram. And typically, as in the case above, viewers can recover the viewpoint (or range of viewpoints) implied by the layout of a picture, but no such recovery can be carried out with diagrams. This way of distinguishing pictures and diagrams is *semantic*: it distinguishes the two kinds of sign on the basis of the kind of content they express. It does not characterize the difference between pictures and diagrams in terms of *syntax*, such as the kinds of lines used, or the presence or absence of textual elements. (We do not think that the distinction between picture and diagram is usefully drawn in terms of the presence or absence of text. The picture above could have included a textual caption or even local annotation—“Cube here!”—but it would still be a picture, albeit one supplemented with text. In a variety of contexts, both pictures and diagrams do and do not typically incorporate such textual features. Still, we recognize that diagrams often make essential use of symbolic elements in a way which pictures seem not to.)

Having drawn the distinction between pictures and diagrams, it may now be less obvious what they ultimately have in common. What is the unifying and distinctive feature of *iconic* signs? One of the major challenges facing any would-be answer to this question is that of providing an account sufficiently general to include *both* pictures and diagrams, but sufficiently narrow to exclude language-like representation.

For example, an appealing idea is that icons are distinctively “visual” in a manner that symbols are not. But this proposal is problematic on several counts. On one

<sup>2</sup>All images in this article are author-created, unless otherwise noted.

hand, if it means that iconic signs must be *seen* to be understood, then the criterion is too broad, for it would include sentences of written languages. On the other hand, if it means that the cognition characteristically engaged by iconic signs belongs to the visual system, then the criteria is likely too narrow. While it is clear that the comprehension of pictures is governed by the same systems which give rise to perception and mental imagery, this is not the case of graphs, charts, and Venn diagrams. After all, the visual system seems to work specifically with perspectival representations; but the contents of diagrams are characteristically non-perspectival. Of course, the interpretation of diagrams may indeed rely on *spatial* cognition, but this need not be *visual* cognition. Thus we have reason to think that iconic representation includes, but is not limited to, visual signs.

More promising characterizations of iconicity begin with the intuitive idea that, for pictures and diagrams alike, there is a kind of “direct” or “natural” correspondence between the spatial structure of the sign and the internal structure of the thing it represents. These vague ideas have in turn been analyzed in terms of likeness, resemblance, isomorphism, or transformation (e.g. Peirce 1906, French 2003, Abell 2009, Greenberg 2013). Though iconicity seems to be a fundamental representational kind, its precise nature remains the subject of open and active inquiry. It awaits collaborative investigation from philosophy, cognitive science, and beyond.

Further understanding of iconicity requires a more intimate acquaintance with the range of phenomena it includes. We now turn to introduce two basic dimensions of variation, exhibited by both pictures and diagrams. The first concerns differences among the *systems of representation* to which individual icons belong. The second concerns the various *use properties* which these signs are designed and used to serve.

### 1.1 Systems of Iconic Representation

Pictorial and diagrammatic representation are not homogenous kinds. There is not *one* sort of picture, nor *one* sort of diagram. Instead, there are indefinitely many species of each, corresponding to indefinitely many SYSTEMS OF REPRESENTATION. (In the special case of pictures, these systems are often called SYSTEMS OF DEPICTION, but we opt here for the more inclusive term.) Such systems are the iconic counterparts of languages. They embody the general rules which artists and viewers must coordinate on in order to arrive at the same association of public signs with informational content.

Though their significance has long been appreciated, the idea that iconic representations are thoroughly governed by systems was championed by Nelson Goodman (1968) under the banner of “languages of art” (though officially he termed them “symbol systems”). Goodman took an especially bloodless view of such systems, attempting to define them primarily in terms of low-level features of syntax. Theorists since Goodman have inherited his conviction that iconic representations are best explained as elements of general systems, without endorsing his view of the nature of these systems.

Systems of iconic representation share two fundamental features with languages. First, each determines a set of *construction rules*, the analogue of linguistic syntax; every representation in a given system is constructed according to these rules. Second, and most important for our purposes, each determines a set of *interpretation rules*, the analogue of a linguistic semantics; every representation in a given system is (at least partly) associated with its content according to these rules. This second feature implies that pictures and diagrams have content only *relative* to one system or another, but not in isolation, just as sentences are only meaningful relative to one language or another. In the case studies that follow, we demonstrate these points first with respect to systems of diagrammatic representation, and then with respect to systems of pictorial representation.

Despite these broad commonalities, the character of iconic systems differs fundamentally from that of languages, in a number of ways. To reiterate the basic point: languages are based on lexicons of arbitrary associations between signs and contents, while systems of iconic representation are founded on rules that establish more natural and direct associations.<sup>3</sup> (We expect this to be true however the terms “arbitrary,” “natural,” and “direct” are ultimately understood.) The distribution of iconic systems also seems to differ substantially from that of languages. Whereas citizens of modern industrial societies are typically fluent in two or three languages at most, we are all competent consumers of dozens, possibly hundreds, of iconic systems of representation.<sup>4</sup> These are the subtle codes which mediate our use of graphical displays on computers and phones, street signs, maps, movies, newspapers, technical articles, and so on. In this sense, we are all massively, iconically multi-lingual.<sup>5</sup>

Though it is natural to group iconic signs into something like systems, the idea that these systems are based on sets of definite *rules* is open to challenge. The alternative is that iconic signs are produced and interpreted in a manner which is ad-hoc, organic, and *unsystematic*. On this view, iconic representations may be organized into loose groups of affiliated style and subject matter, but not subsumed under strict sets of rules. This intuition is often fueled by a sense that, while language is genuinely rule-governed, pictorial and diagrammatic representations are merely pragmatic and improvised. But as we will see, such skepticism is not born out by careful study of the phenomena.

One of the most compelling pieces of evidence for systematicity is the record of success that rule-based analysis of iconic representation has enjoyed over the last

---

<sup>3</sup>This is a difference in rules of interpretation, but there are vivid differences in construction rules as well. Symbolic languages are widely thought to be governed by recursive syntax, but this does not seem to be true of pictures, at least not in anything like the same way (Hauser et al. 2002). The contrast (or comparison) between linguistic syntax and diagrammatic syntax is more complex, since many diagram systems clearly *are* governed by recursive construction rules, albeit relatively simple ones (Shin 1994).

<sup>4</sup>But see Armstrong (2013) for the view that languages are as numerous as iconic systems.

<sup>5</sup>In order to overcome differences in education, Otto Neurath worked over the course of his life on a language-like visual system, “Isotype,” motivated by the modernist idea that purely visual signs would not require interpretation or enculturation (Neurath 1945/1973). Though perhaps partly accurate, this assumption was misguided: even Neurath’s icons must be interpreted, and the conventions regulating their use must be specified in order for the system to be effectively shared by a community of consumers.

25 years. Close study of specific systems has yielded mathematical models of their underlying rules, and these models are admirable in their ability to predict and explain our own, intuitive understanding of icons. Later in this essay we'll discuss some notable examples of this approach, including Shin's (1994) logic for Venn diagrams, and the analysis of perspective line drawing that has emerged from projective geometry and computer vision. These findings parallel achievements in formal linguistics, where theorists have developed sophisticated mathematical and computational models of linguistic representation. Unfortunately, only a small handful of iconic systems have been studied in any depth.

Positing knowledge of such rule-based systems helps explain our patterns of use with iconic representations. With reference to pictures, Schier (1986, 43) called such knowledge "pictorial competence," analogous to linguistic competence. He observed that a viewer who can interpret one line drawing, under suitable conditions, is, all things equal, in a position to interpret *any* line drawing. Similarly, a viewer who can interpret one Venn diagram is in a position to interpret any other Venn diagram (but not any other Euler diagram or graph). The best explanation for this capacity for constrained generalization is that, in learning to interpret token icons, viewers are also acquiring competence with an underlying system of interpretive rules. Once learned, such rules can then be freely applied to other tokens. By contrast, if there were no systems of iconic representation, each icon would be interpreted on its own terms. The knowledge of how to interpret any one icon would provide at best a loose guide for the interpretation of any other— but this is not what we find.

Such an account follows a tradition established by Chomsky (1957, 1965), which distinguishes *implicit* from *explicit* knowledge of rules. *Implicit knowledge* requires only that subjects have internalized, and be able to follow, the rules in question. One may or may not be able to describe these rules, and they may be encoded in entirely unconscious aspects of cognition. This is the typical condition for a speaker of a language or a consumer of diagrams or pictures. We can understand a sentence or a graphic, and can use it in communication, planning, and so on, but we aren't in a position to explain *how* this understanding was achieved. *Explicit knowledge*, by contrast, requires that the subject be in a position to consciously articulate the precise rules in question. This is the kind of knowledge that a theorist achieves with deliberate study. Both artists and viewers have possessed implicit knowledge of iconic systems since the ancient appearance of iconic representation in human society. But full, explicit knowledge of these rules has only come about recently, with the application of methods from logic, linguistics, computer science, and mathematics. And even now, such knowledge is limited.<sup>6</sup>

---

<sup>6</sup>In fact, explicit knowledge comes in degrees. Artists and theorists of art have codified rules of drawing and diagramming for hundreds of years, at least. The formalization of linear perspective during the Renaissance is a vivid example. While such informal descriptions are explicit, they typically fall short of full mathematical precision. As a consequence, they are insufficiently exact to train a computer in the interpretation of the class of icons in question. As we will see for the cases of Euler and Venn diagrams, this is true even when the systems in question were deliberately *invented*. The inventors relied on implicit human understanding to supplement their own explicit but partial descriptions.

## 1.2 Iconic Use Properties

Although a system-based analysis is necessary to understand the underlying structure of iconic representation, it does little to explain how or why iconicity makes an entrance into daily life (Lewis 1975). After all, signs are not merely realizations of abstract rules— they are typically created to serve some more or less practical purposes. And different systems of representation have distinctive features which, relative to a given kind of user and given kind of use, make them more or less suited to these purposes. We shall introduce the term *USE PROPERTY* to describe generic dispositional features of the signs of a given system having to do with the *use* of those signs in context.<sup>7</sup> The relevant “users” of a sign may be its creators or its consumers. As examples, signs from one system might, depending on context, have the use properties of *being easy (or difficult) to construct, facilitating proof, or allowing efficient interpretation*. They may pertain to features of signs having to do with their physical implementation, computation, design, and more.<sup>8</sup> The field of possible use properties is open-ended, limited only by the kinds of tasks signs are enlisted to fulfill. But because the same kinds of context of use tend to recur, certain generic use properties acquire explanatory relevance. Variation among such properties is our subject here.

At a relatively high level, different systems of representation facilitate different “cognitive” functions. That is, they enable their users to achieve distinctively cognitive tasks, like navigation, problem solving, inference, communication, information storage, and so on. Of course, other, more mundane kinds of tools— like pencil, paper, or eyeglass— also promote navigation and problem solving. But icons make a distinctive contribution to cognitive tasks by fulfilling more proximal representational functions, having to do with how and what they are supposed to represent (Burge 2010). Our primary concern here is with those relatively low-level use properties relevant to the construction of signs and the expression of content.

Suppose, for example, that a stranger asks you for directions to the nearest gas station, and you elect to draw him a map. When you decide to draw a map, you in effect select from a range of possible sign systems. In addition to a drawn map (typically, with verbal annotation), you could have constructed a “virtual map” through spatial gestures, or produced a purely verbal description. Each of these complex signs can express more or less the same geographic content. If your only goal was to produce a sign that expressed a certain content, you would be indifferent among these options. But of course, you likely have other representational priorities. In order to assist your interlocutor with navigation, you will want to select a sign with the use property of expressing its spatial content in a manner that is immediately available to spatial cognition. In this case, a *map* of some kind is likely more appropriate than a purely verbal description. If, further, you wished to produce a *durable* sign, one

---

<sup>7</sup>Strictly speaking, use properties might best be thought of as relations to contexts or types of context, but nothing we say depends on such details.

<sup>8</sup>Use properties include but are not limited to the likes of what (Larkin and Simon 1987) term “computational efficiency.”

whose content can be accessed at any time without the aid of memory, then a drawn map is more appropriate than a gestural one. (Of course, other kinds of use properties may come into play as well, like the time and energy required to produce signs from each kind of system.) In the end, it is the drawn map which is enlisted, because its use properties— its natural expression of spatial content, and its durability— best satisfy your immediate goals.

Identifying the use properties associated with a given system can help explain when it is and is not employed among a population of potential users. More often than not, designers *begin* with some function (or set of functions) in mind, and on this basis select that form of representation whose use properties, they guess, best suits this purpose. Such considerations guide the choice of whether to express oneself in a symbolic or iconic idiom, and if the latter, with pictures or with diagrams, and finally with one or another of the myriad possible systems of representation. Of course the “choice” between systems may be an entirely unconscious process, guided only by implicit awareness of the relevant use properties. There may even be use properties which are relevant to *viewers*, and help explain their continuing engagement with a class of signs, but which may have played no causal role in the creative process of the artist.

To be sure, many factors may influence the use of a given system *beyond* its use properties. As Lewis (1969) has emphasized, when a system is subject to coordination with other agents (even your future self), social factors like precedence, salience, and even arbitrary fiat may play an essential role in the selection of one system over another. And Gombrich (1960) documents many cases where the choice of system was limited simply by the state of cultural innovation at the time of use. (Iconic systems, he shows, are often not only intentionally *created*, but also subsequently improved.) And yet, over and above these external factors, it is undeniable that a system’s use properties play a key role in whether or not that system is enlisted for use. We suspect that this is especially true for the iconic realm, where there is particularly dramatic variation in use properties from system to system.

For our purposes, one use property is especially important, but difficult to describe precisely. For lack of a better term, we join other authors in calling it “naturalness.” (Bordwell 2008, 61–63; Cumming et al. 2014) A system is more or less NATURAL to the degree to which human *nature*— including relatively universal aspects of cognition, physiology, social behavior, and environmental interaction— rather than enculturation, makes that system easy to internalize and use.<sup>9</sup> Bordwell (2008, 60) illustrates roughly this idea with the system of turn signals on cars. The system in which a left-hand blinking light indicates a left turn, and a right-hand blinking light indicates a right turn is especially natural in this sense: it is easy to internalize and use, presumably because it harmonizes with basic features of human cognition and body organization. The opposite system, where a left-hand light indicates a *right* turn is correspondingly *unnatural*.

In this sense, commonly used iconic representations are typically more natural than symbolic representations with similar expressive power. For example, the fact

---

<sup>9</sup>This characterization of naturalness derives from conversations with Sam Cumming.



that diagram systems are often used to teach Boolean algebra and set theory suggests that these diagram systems are more natural than their symbolic counterparts. Whether naturalness as we have defined it is not only characteristic of iconicity, but *coextensive* with iconicity is an open question awaiting further investigation. (As a corollary, naturalness as we define it may or may not be the complement of *arbitrariness*, the property which characterizes symbolic lexicons; though certainly non-arbitrary systems tend to be more natural than arbitrary ones.) In the cases we investigate below, people choose to use iconic signs instead of symbolic ones for a variety of practical reasons. They may be easier to construct, more familiar to their audience, or more attractive. But a common theme is the desire to represent some subject matter in a manner that is especially natural.

In what follows, we first consider a case study of diagram systems, and in the next section, a case study of pictorial systems. In each case, we'll see that different systems continue to be used in contemporary discourse because they offer subtly different suites of use properties.

## 2 Diagrammatic Representation

While the class of diagrams is extraordinarily heterogeneous, we have selected here two closely related diagram systems as exemplars. Many of the lessons illustrated by this pair of cases apply to diagrams in general. Still, readers should not be misled by the orientation of the cases discussed here. Diagrams are realized not only by ink on paper, but with gestures, road signs, buttons, trail markings, even bodily actions—and they serve an equally diverse range of cognitive functions (Tversky 2011).

Like most other diagram systems, those considered here exploit *spatial* relationships between shapes to represent relationships in some other domain—in this case, *logical* relationships between classes of objects. The first, the system of EULER DIAGRAMS, was introduced by Leonard Euler in 1761. His aim was to make Aristotle's syllogistic term-logic—a logic exclusively concerned with the relationship between classes—intuitive and visual, with the aid of overlapping circles. In his own words: “these circles, or rather these spaces, for it is of no importance of what figure they are of, are extremely commodious for facilitating our reflection on this subject, and for unfolding all the boasted mysteries of logic, which that art finds it so difficult to explain; whereas by means of these signs the whole is rendered sensible to the eye” Euler (1795, 340).

Here we elaborate a slightly simplified version of Euler's original scheme, sidestepping well-known complications. To begin, every Euler diagram is made up of at least two closed shapes, typically circles; each circle is labeled with the name of a category; and the labeled circles are arranged in any manner. Here are several examples.<sup>10</sup>

---

<sup>10</sup>In this version of the system, the spatial position of a label is irrelevant, except insofar as it disambiguates which circle it attaches to.

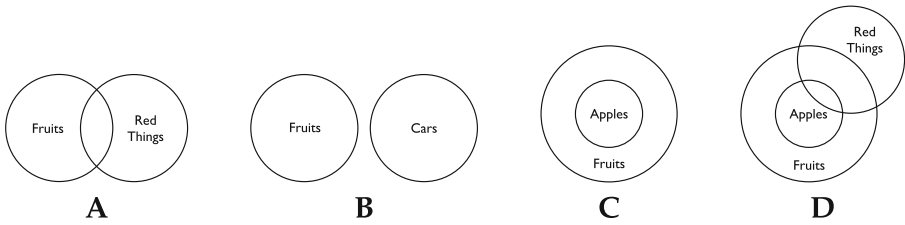

The interpretation of these diagrams is familiar and probably obvious up to a point. Diagram (A) indicates that the class of *fruits* and the class of *red things* are overlapping, but not identical. (B) indicates that nothing is both a fruit and a car, and (C) that all apples are fruits. At this point, most readers will easily interpret (D) without guidance. This in itself is a demonstration of viewers' implicit competence with some underlying system. Since you have almost certainly not encountered (D) before, your ability to interpret it is evidence that you have applied a general interpretive rule to a novel example. Thus Euler diagrams, like all systems of representation, are governed by general semantic rules.

Two points help to clarify the nature of these rules. First, the size and shape of the enclosed regions in Euler diagrams have no semantic significance. The defining features of Euler diagrams— inclusion, overlap, and disjunction— are essentially topological features. Thus, while Euler diagrams are in an important sense *spatial*, the space in question is highly abstract. Second, the interpretation of Euler diagrams seems to be “course grained” in the sense that their content cannot, in general, be captured by a single atomic sentence. For example, (C) indicates that *all apples are fruits*; but it also seems to indicate that *there are non-apple fruits*. This inevitable informational coupling is, as we will see, precisely what Venn sought to overcome in his alternative system.

Explicitly stating the rules underlying the Euler system, in mathematically precise terms, is not trivial. Euler himself claimed that the basic interpretive principle could be stated in two clauses: “Whatever is in the thing contained must likewise be in the thing containing; whatever is out of the containing must likewise be out of the contained” (Euler 1795, 350). Such a principle in effect sets up an equivalence between spatial inclusion (in the diagram) and logical inclusion. More recently, Hammer and Shin (1998) have elaborated on Euler's own remarks with a comprehensive formal semantics and logic for the Euler system. A careful presentation of their analysis is beyond the scope of the present essay, but it can hardly be doubted that a logic of some kind is at work here.

The fact that Euler diagrams are based on a bonafide system of representation is thrown into relief by comparison with a closely related alternative system. This system was originally proposed by John Venn in 1881— over one hundred years after Euler— as a revision and improvement to the Euler system. (Technically, what we present here is an extension of Venn's original system due to C.S. Pierce (Shin 1994, 20–40).) Venn diagrams are constructed in two stages. First a “primary diagram” is established— this consists of at least two labeled circles in a particular arrangement:

every circle must overlap every other circle, as well as every other overlap of circles, as in the following cases.<sup>11</sup>

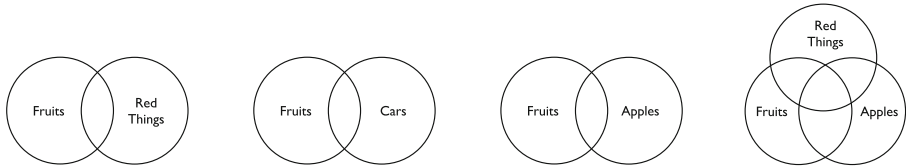

In the Venn system, primary diagrams alone have no standard interpretation. Rather, they merely delimit regions of logical space. As with Euler diagrams, the structure of a Venn diagram is ultimately topological; the shapes and sizes of the closed regions don't matter.

To transform a primary diagram into a finalized Venn diagram, at least one region, and possibly all, are either (a) shaded-in with grey or (b) marked with an X, but not both. The following are all finalized in this way.

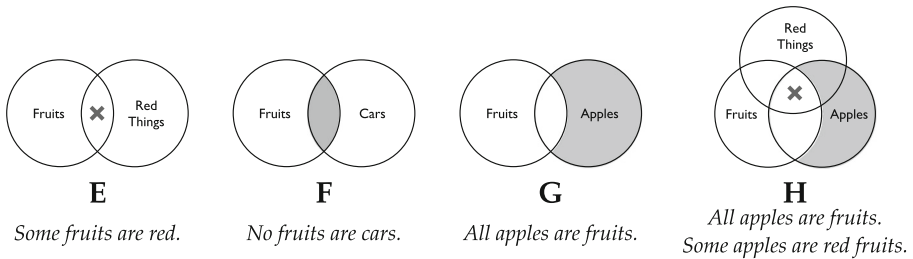

With the addition of shading and X's, Venn diagrams can now represent relations between categories. Shading a region indicates that the corresponding category is *empty*, while marking a region with an X indicates that the corresponding category is *not empty*. So, for example, (F) indicates that the class of things which are both fruits and cars is itself empty— that is, no fruits are cars. But (G) indicates that the class of apples which are not fruits is empty— all apples are fruits.<sup>12</sup>

With a little practice, Venn diagrams can become as easy to interpret and clear as Euler diagrams. They are commonly used in logic and math textbooks to teach principles of propositional logic and set theory. Despite their ubiquity, the underlying semantics and logic of Venn diagrams was not discovered until Shin's (1994) comprehensive study. Working with a slight extension of the Venn system, Shin provided both semantic definitions and graphical proof rules. She went on to prove both

<sup>11</sup>In a technically complete presentation, each primary diagram includes a box surrounding the overlapping circles. The outer space— between the box and the circles— is used to represent the class of things which fall under none of the categories associated with the circles. See Shin (1994, 48–53) for discussion.

<sup>12</sup>Here we assume that “all” does not imply “some”, else (G) would have to be amended to reflect the existential quantification.

soundness and completeness for the diagram system, and demonstrated its equivalence to a monadic predicate logic (Shin 1994, 141–152). In the wake of these findings, it is clear that Venn diagrams constitute a genuine system of representation, replete with rules of construction, interpretation, and even proof.

Though the systems of Euler and Venn were deliberately invented and extended, and are in this sense artificial, they live on, without formal explication, in textbooks, technical documents, newspaper articles, and classrooms. What’s more, even the original definitions for these systems were vague and highly informal— nowhere near sufficient, for example, to train a computer in their interpretation. Instead, their inventors happened upon systems that were sufficiently natural for humans to acquire *implicitly*, circumventing the cumbersome chore of explicit learning. It wasn’t until the likes of Shin (1994) and Hammer and Shin (1998) that these systems were explicitly codified. Such logical studies of iconic systems are a counterpart to contemporary formal linguistics, but they are still in their infancy.

We are now in a position to see how clearly different one system of representation may be from another, even when pursuing similar logical ends and with similar tools. To dramatize the point, consider the assertion “*all apples are fruits*”. The most natural representation of this content in the Euler and Venn systems respectively is illustrated below. The stark graphical difference between these two signs again demonstrates that the expression of content by diagrams depends essentially on the operative system of representation.

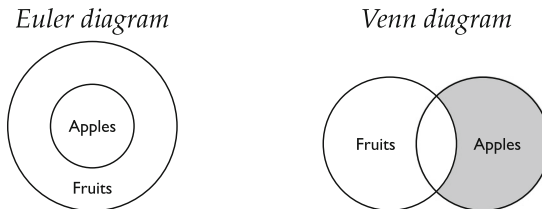

These superficial differences of form also reveal deep differences in the semantic architecture of each system. Indeed, Venn conceived of his system as a corrective to basic expressive defects of Euler’s. For Venn, the central problem with the Euler system was that it was too course-grained. From the point of view of Aristotle’s logic, we might put the issue this way: the Euler system can only represent certain *clusters* of assertions, but not the assertions themselves. (“Assertions” in this sense are sentences containing one subject and one predicate. In Aristotle’s logic, both premises and conclusions are assertions (Smith 2014)). For example, the Euler diagram above expresses the content that that (i) all apples are fruits; but also (ii) there are fruits which are not apples. By contrast, the Venn diagram only expresses (i), that all apples are fruits. Furthermore, there is no Euler diagram which expresses (i) alone.

In Venn’s words: “The weak point about these [Euler diagrams] consists in the fact that they only illustrate in strictness the actual relations of classes to one another, rather than the imperfect knowledge of these relations which we may possess, or

wish to convey, by means of the proposition” (1881, 424). As Venn observes, the two systems seem to have different subject matters. In the Euler system, circles directly represent actual classes of objects, and relationships among circles indicates actual relationships among these classes. In the Venn system, circles represent merely *possible* classes, and their spatial relationships reflect the merely *logically possible* relations between these possible classes. As a consequence, Venn diagrams represent fine-grained propositions, while Euler diagrams can only represent more concrete, course-grained situations.

These expressive differences are not in themselves problematic. But anyone setting out to represent a deduction involving the assertion “*all apples are fruits*” in the Euler system would inevitably commit themselves to more information than is strictly implied by that assertion. Thus Euler diagrams cannot generally stand in as premises in an Aristotelean deductions, for they would license unintended inferences. By contrast, for each expression in Aristotle’s term logic, there is exactly one Venn diagram which expresses the same content, making them ideal stand-ins for premises in a deduction. (Euler himself was apparently sensitive to this problem, and devised a solution, albeit an awkward solution. But the solution raises even greater problems, and to the extent that the Euler system lives on today, it is the simplified version presented above, not the one he originally offered (Euler 1795, 340–342; Shin 1994, 13–16).)

The formal differences between Euler and Venn reflect differences of immediate relevance to their use— that is, differences in their use properties. Venn diagrams facilitate the representation of Aristotelean deduction in a way that Euler diagrams do not. This fact motivated their adoption by Venn, and even today, when Aristotle’s logic no longer commands the same interest, the Venn system is preferred for visualizing principles of Boolean algebra for essentially the same reasons. Yet expressive power is only one relevant use property among many. For, despite its shortcomings, the Euler system was not eclipsed by Venn’s, but continues to thrive in the modern era. This flourishing can be attributed largely to a different kind of use property, what we earlier term *naturalness*, one of the hallmarks of iconic representation. The Euler system is easier to learn and apply than Venn’s, and it makes its content more easily accessible through its distinctive spatial organization. Put simply, Euler diagrams simply seem to be more *iconic* than Venn diagrams.

Here there appears to be a kind of trade-off between expressive power and iconicity. Hammer and Shin (p. 14) describe the situation this way: “Venn’s revision resulted in loss of visual clarity at the cost of gaining expressive power... in the process of extending the system Peirce lost even more of the capacity for visual naturalness.” (The Venn system presented here is a mixture of Venn’s original account with some of Peirce’s additions.) It is difficult to pinpoint what it is about the Venn system which makes it less natural than the Euler system, though this claim can hardly be doubted. Perhaps it is the addition of quasi-symbolic elements like the grey shading or X-markings. Perhaps it is the more abstract contents Venn diagrams express. Understanding this difference is an important but unresolved subject of inquiry.

We have dwelt upon this case in part because the contrast between Euler and Venn parallels the contrast between iconic and symbolic representation generally. On one side lies greater naturalness, on the other, greater expressivity. Long after their invention, the continued use of these diagram systems in the modern era suggests that both boast use properties not possessed by conventional, symbolic means. This is underscored by the fact that all human languages and even simple artificial languages (like Predicate Logic) have expressive power that far outstrips those of either the Euler or Venn systems. Thus their ongoing use must be explained in part, once again, by their *naturalness*: both systems allow content to be made manifest in a way that, for human cognition, is particularly easy to grasp, especially as compared to familiar symbolic systems. The point was captured by Euler's initial remark that his diagrams "are extremely commodious for facilitating our reflection... By means of these signs the whole is rendered sensible to the eye."

### 3 Pictorial Representation

It might be thought that abstract diagrams, with their natural parallels to language, are correspondingly system-driven, while pictures, with their roots in perception, could not be. In fact, however, pictorial representation appears to be governed by systems of representation in the same way. While all pictorial systems do recapitulate the perspectival character of visual perception, they also deviate from vision freely in response to external demands. The range of variation is wide: differences can be found in the treatment of overall geometry, line, color, and the encoding of light (Willats 1997; Maynard 2005). In this section we focus again on a pair of illustrative examples: the system of *linear perspective* and that of *parallel perspective*.<sup>13</sup> As we will discuss, they differ fundamentally in their use of projective geometry to express content.

Pictures in the system of LINEAR PERSPECTIVE are dominant in contemporary media, realized as drawings, paintings, and photographs.<sup>14</sup> They are marked by a few prototypical features. In linear perspective, for example, as objects move farther from the viewpoint, they are depicted by smaller regions on the picture plane, as in figure A below. A related feature is exhibited by the representation of parallel lines, as in figure B below: in linear perspective, parallel lines extending away from the viewpoint are depicted by converging lines on the picture plane. Though elements of linear perspective have been employed since antiquity, the geometry it depends on was not explicitly codified and mastered until the Renaissance (Alberti 1991 [1435]; Hagen 1986; Willats 1997).

---

<sup>13</sup>Strictly speaking, these are two *classes* of system. Each class can be realized with different treatments of line, color, and light— and each such realization corresponds to a distinct system of representation.

<sup>14</sup>Linear perspective is often simply called "perspective." Linear perspective is to be distinguished from curvilinear perspective—the sort of image produced by a fisheye lens.

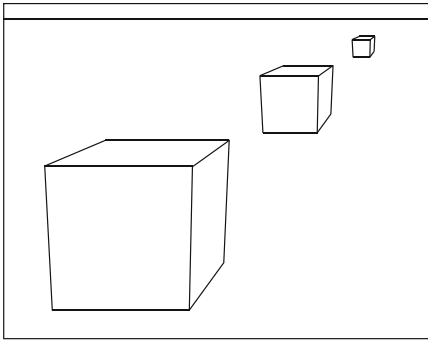

A

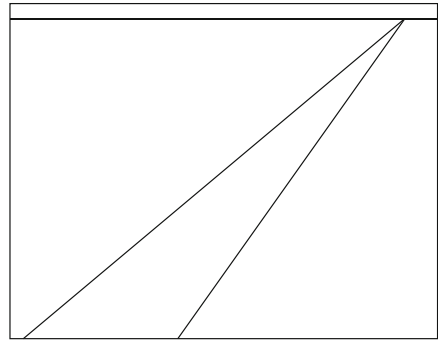

B

Pictures in PARALLEL PERSPECTIVE are less common in mainstream media, but prevalent in architecture, engineering, and other technical fields.<sup>15</sup> The same features which characterize linear perspective distinguish it from parallel perspective. In parallel perspective, for example, even as objects move farther from the viewpoint, they are depicted by regions of the same size on the picture plane, as shown in figure C. In addition, parallel lines extending away from the picture plane are depicted by parallel lines on the picture plane, as in D. Parallel perspective is sometimes described as giving rise to a kind of unsituated “god’s eye view.”

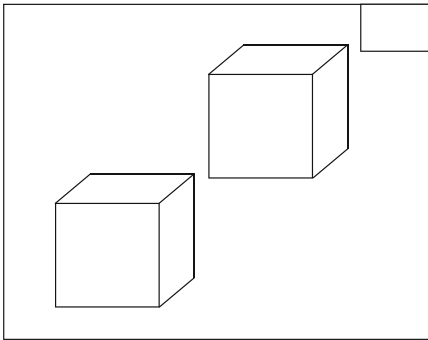

C

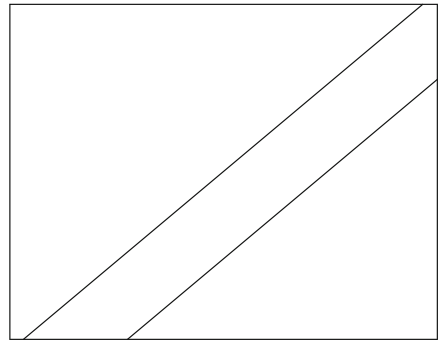

D

Though parallel perspective may be less familiar than linear perspective, it is by no means a curiosity. It was commonly deployed in classical Asian painting, as in

<sup>15</sup>While the term “perspective” is typically reserved for *linear* perspective, images in the parallel system are clearly perspectival in an important sense, so we persist with our choice of terminology. In addition, there are many versions of parallel perspective, including isometric, axonometric, and orthogonal projection systems. See Dubery and Willats (1972) for a clear discussion of these distinctions.

figure E, and has been used in technical drawing continually since the 19th century, as in figure F (Willats 1997, 37–59).<sup>16</sup>



E

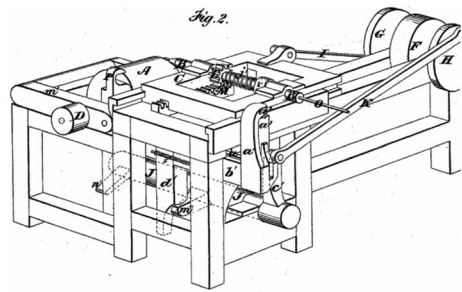

F

Put side by side, the difference between the two systems is stark, as illustrated below. On the left you can see a cube in linear perspective and on the right in parallel perspective. The blue guide-lines show how the two systems differ in their representation of the parallel edges of the cube— with converging lines or with parallel lines.<sup>17</sup>

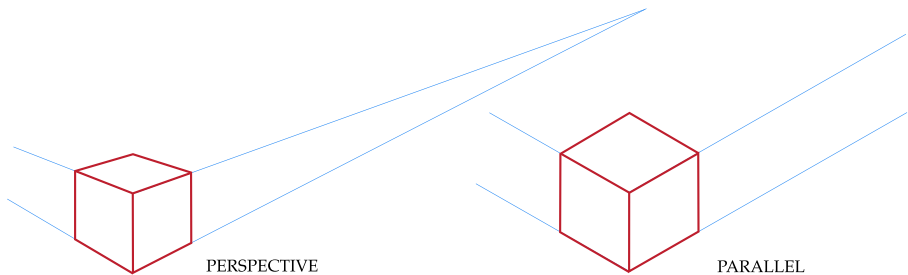

This example makes it clear that pictorial systems are not merely *styles*— guide-lines for construction with no semantic consequences. Rather, they are full-blooded systems of representation, with determinate rules of interpretation. As illustration, suppose we isolate the drawing below without specifying the intended system of representation. What is the content of the picture? Relative to the linear perspective system it depicts a cube, but relative to the parallel perspective system it depicts an irregular solid. This is because, in linear perspective, the converging lines may be interpreted as representing the parallel edges of a cube; but in parallel perspective, converging lines can only be interpreted as representing converging edges. (Similarly, a picture that depicts a cube in parallel perspective normally depicts an irregular solid in linear perspective.) Thus, the drawing might accurately represent an actual

<sup>16</sup>The first image is “Along the River During the Qingming Festival” (12th century, detail of original) by Zhang Zeduan (1085 -1145). The second is “Machine for forming Temple-Teeth” (May 12, 1874) from U.S. Patent 150,828, filed by Nathan Chapman.

<sup>17</sup>The remainder of the images in this article are adapted or copied from Greenberg (2011).



cube relative to the linear system, but not relative to the parallel system. Just as with diagram systems and languages, pictorial content is system-relative.

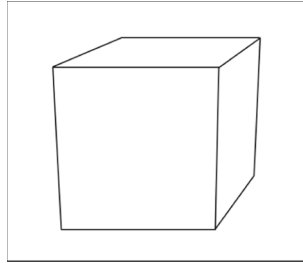

It is not immediately obvious that the pictorial systems we have just described can be defined in terms of precise and coherent sets of rules. The alternative is that they are merely the products of loose heuristics like *draw parallel lines parallel*, or *draw further objects smaller*. The conclusion that pictorial systems are rule governed is the result of centuries of work by artists and art theorists, as well as some recent innovations in computer vision and cognitive science. Today, scholars of depiction have achieved considerable success in the formal analysis of pictorial systems by using tools from projective geometry, as we now briefly explain.

GEOMETRICAL PROJECTION is a general method for transposing three-dimensional scenes onto two-dimensional picture planes, much the way a flashlight may be used at night to project the shadow of an extended object onto a flat wall.<sup>18</sup> The method works by defining an array of lines which project outward from a viewpoint, through the picture plane, to a target scene; these lines are then used to map spatially distributed features of the scene back to surface features of the picture itself. A simple example is illustrated below, with the resulting picture plane revealed at right.<sup>19</sup>

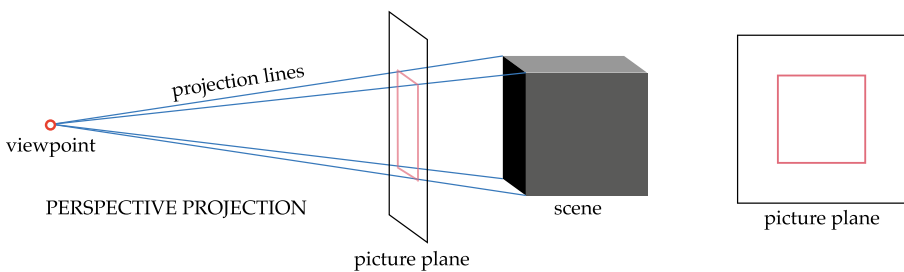

The viewpoint can be shifted, with the effect that new features of the scene are revealed in the projected image.

<sup>18</sup>The description of geometrical projection given here is based on the presentation in Greenberg (2011). Formal details are elaborated in Sedgwick (1980) and Willats (1997, 37–69).

<sup>19</sup>Note that the projection lines indicated here are only a representative sample of the full array.

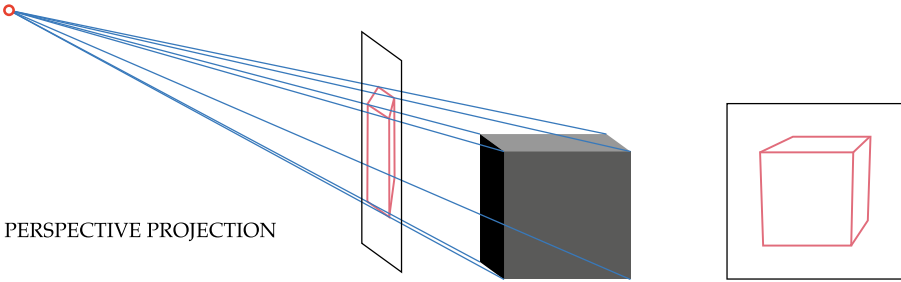

The particular method of projection illustrated here constitutes the core of the system of linear perspective. The defining feature of this kind of projection is simply that the projection lines converge on a single viewpoint. This simple constraint is responsible for the distinctive geometry of linear perspective. A different kind of projection underlies the system of parallel perspective. In that case, the projection lines, rather than converging on a single *point*, are all perpendicular to a single *plane*, hence parallel to one another. The resulting projection is subtly but visibly distinct from the linear perspective image above.<sup>20</sup> Still other methods of projection (and types of pictorial representation) can be defined by varying aspects of the viewpoint, picture plane, projection lines, and their relative relationships.

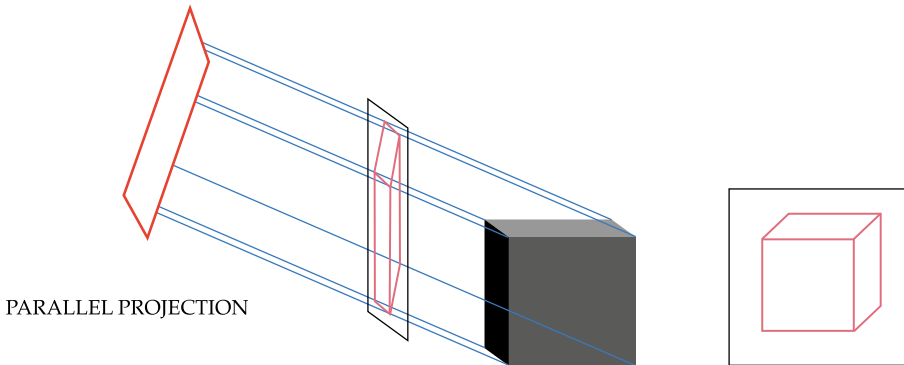

Regardless of projective geometry, all of the pictures considered thus far have been *line drawings*. That is, in addition to the overall image structure imposed by the method of projection, they also make use of a particular criterion that specifies *which* features of the scene are projected to the picture plane. Very roughly, this rule dictates that *visible edges* in the scene are mapped to *lines* on the picture plane. This somewhat facile description turns out to obscure the rich complexity of the scene-to-line relationships exploited by actual line drawings. This fact was not fully appreciated until the 1960's and 70's when researchers in the field of computer vision, including

<sup>20</sup>The projection illustrated below is an oblique projection, a species of parallel projection.

Guzman (1969), Huffman (1971), Clowes (1971), and Waltz (1975) began to investigate the automated interpretation of line drawings.<sup>21</sup> It turned out that the notion of “visible edge” required considerable refinement, for there are many different kinds of edges—sharp discontinuities, soft contours, occlusion contours, changes in coloration, shadows, wrinkles, and more. In addition, lines are often used to represent non-edge elements, as in the use of line for shading and texture. Perhaps surprisingly, research has shown that this wide variety of lines can be analyzed algorithmically, once again confirming the hypothesis that representational systems are at root rule-governed. At the same time, and despite considerable progress in this area, there are still species of line drawing which remain the subject of open investigation (e.g. DeCarlo et al. 2003).

There are many other kinds of rendering besides the mapping of “visible edges” to lines. In “wireframe” projections, for example, *all* edges in the scene are mapped to lines in the picture. In methods of color projection, colors in the scene are mapped to suitably related colors in the picture. These and other variations—by no means exhaustive—are illustrated below, in combination with the distinctive structure of perspective projection. In general, the geometry of projection and the treatment of line and color are independent. There are both perspective and parallel projection line drawings, perspective and parallel color pictures, and so on.

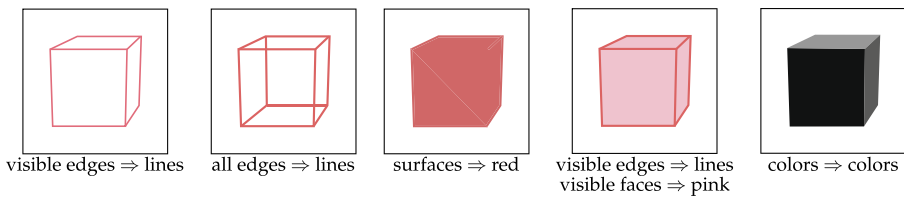

In fact, the alternatives surveyed here are only a small sampling of the wide range of projections and renderings actually in use, differing in their treatment of overall geometry, line and color, stylization, and a host of other factors (Maynard 2005). Yet Hagen (1986) and Willats (1997), among others, have demonstrated that an impressive range of art historical “styles” can be understood as arising from the same basic types of ingredients as those reviewed here.

It is natural to think of methods of projection as describing idealized rules for *constructing* pictures. But as a number of authors have suggested, they also constrain the rules for *interpreting* pictures (Hagen 1986; Kulvicki 2006; Hyman 2006). Greenberg (2011) in turn has developed this suggestion into an explicit set of semantic rules. The motivating idea here is straightforward: the content of a picture can be thought of as the scene (or set of possible scenes) *from which* the picture could have been projected. To interpret a picture is to recover the scene which it purports to be a projection of. Any act of pictorial interpretation thus depends on specific assumptions about the operative method of projection. The content associated with a picture will

<sup>21</sup>See Palmer (1999, 237–243) and Willats (1997, 109–127) for reviews of these developments.

vary depending on whether the projection in question is thought to be parallel or perspective. It is not claimed that this account exhausts the analysis of pictorial content, but rather that it describes a necessary and foundational component.

This proposal effectively analyzes systems of representation for pictures in terms of methods of geometrical projection together with principles for rendering line and color. If this is right, the rules underlying pictorial systems are superficially unlike those at work in diagrammatic representation. Nevertheless, such a projection-based analysis gives rise to the key features of any system of representation: rules of construction and rules of interpretation. The interpretive variation we noted earlier, when alternating between parallel and linear perspective systems, can now be attributed to an underlying alternation between methods of projection. Furthermore, establishing the link between projection and systems of pictorial representation has important methodological implications, for it provides an illuminating bridge between a relatively obscure field of inquiry—the interpretation of pictorial images—and relatively rich and systematic ones—the mathematical and computational analyses of projection and line.

Thus far we have distinguished parallel and linear perspective in terms of their underlying projection rules, but what if anything distinguishes the *use properties* of each system? Why do both survive today, but in such different contexts? Practically speaking, parallel perspective has much to recommend it. Consider, for example, the kinds of scenes that pictures in each system may represent. In parallel perspective, figures, no matter how distant, are represented by image regions of the same size. This is a fact of value to the artist who wishes to convey equal information about disparate locations. Parallel perspective depictions can encompass vast scenes covering many different terrains. This is arguably why parallel perspective is used in video games like *Sim City*; and it makes parallel perspective the right system for illustrating a continuous scene across an entire scroll, as in classical East Asian art. The same feat attempted in linear perspective would result in unreadable distortions very quickly.

A second set of advantages has to do with the *construction* of the images in question. Parallel depictions are much easier to create, particularly when the subject matter is architectural. For example, when drawing a cube, each visible parallel edge will be depicted by a diagonal line on the picture plane *with the same angle*. Once a mechanism has been devised for drawing lines of that angle, it is trivial to accurately represent all the remaining edges. By contrast, in the case of linear perspective, the depiction of parallel lines is a subtle matter, since each must be depicted by a converging line of a slightly different angle. Accuracy can only be achieved with considerable skill or painstaking computation.

Finally, parallel perspective drawings preserve direct mappings of distance in a manner that linear perspective drawings do not. This means that, given a parallel depiction, a viewer can calculate the length of the object depicted by simply measuring elements of the drawing itself, and multiplying by some factor. By contrast, working out precise distances from linear perspective drawings is a computationally intensive task requiring a host of heuristic assumptions about the depicted environment. This is the use property which, above all others, recommends parallel perspective depiction for use in architecture and engineering.

Given how the foregoing considerations of use favor parallel perspective so heavily, why does linear perspective not only survive but flourish? Linear perspective images are, in a word, more “visual.” The contents they express are closer to the contents of visual perception. And the images themselves have more affinities with the retinal images that are the input to vision. Overall, the cognitive processes governing the interpretation of linear perspective drawings seem likely closer to those at work in normal visual perception. As a result, linear perspective images put viewers in a better position to imagine for themselves what a given scene would look like in person. As Gombrich (1960) has documented, such “visualness” was a use property which was hard won by generations of artists making incremental improvements over many centuries—a testament to its profound human importance. Today, an architect wishing to help her client envision the interior of his future house would likely use a system of linear perspective, though she would likely employ a system of parallel perspective in any transactions with her engineers. Like naturalness, visualness is a desideratum that is as difficult to define as it is sought after in the history of iconicity.

#### 4 Conclusion

We have attempted to sketch a map by which the reader may begin to navigate the varied domain of iconic signs. We began with the basic distinction between *pictures* and *diagrams*, noting both their unity—the “iconicity” of this introduction’s title—and their expressive differences. We went on to show that both pictures and diagrams can be analyzed along two interrelated axes of variation. On one hand, individual icons belong to general, rule-based *systems of representation*, of which they are elements. From this point of view, icons as well as linguistic symbols belong to “languages,” as Goodman (1968) rightly suggested. On the other hand, classes of icons possess what we termed *use properties*, generic features that reflect the characteristic effects they have on and for their users. It is these use properties which inform most directly whether one or another system of representation is deployed in context.

We illustrated these ideas first for the case of diagrams, comparing the systems of Euler and Venn diagrams, and then for the case of pictures, comparing the systems of linear perspective and parallel perspective. We selected these particular case studies because both their system-based and use properties have already been studied in considerable detail. The challenge then is to carry the successes of these analyses over to the diverse range of diagrammatic and pictorial forms. Many of these have been the subject of systematic research—but even more have not.

We turn now, briefly, to a few of the unresolved questions this study provokes. In the context of the preceding discussion, we must wonder what general relationships exist between the formal descriptions of systems, on one hand, and their practical uses, on the other. It would be of great practical significance to be able to taxonomically associate specific kinds of tasks with the systems best suited to them. More specific but fundamental questions about the status of iconicity also remain unresolved. For example, is iconicity in general best defined as an intrinsic feature of systems, or only relationally, as a use property that emerges in interaction with human

nature and human interest? There seems to be a close relationship between iconicity and the use property of *naturalness* discussed throughout— but the idea of naturalness itself remains at best vague. How should it be defined? Are there general features of systems which correspond to naturalness? And are there other features of systems which are *incompatible* with naturalness? Our study of the Euler and Venn systems, for instance, suggested a kind of trade-off between expressive power, on one hand, and relative naturalness on the other. Does this pattern generalize to other domains, even the symbolic/iconic distinction itself?

Finally, there are questions which lie outside the scope of the present discussion, but demand attention. Linguistic representation has traditionally been studied through a multi-layered approach which includes the fields of syntax, semantics, and pragmatics. The systemic approach outlined here is clearly affiliated with the traditional subjects of syntax and semantics; and the use-based approach has connections with pragmatics. Still, the broader concerns of pragmatics— the public status of signs, the structure of communicative acts (aka “speech acts”), and the interaction of signs with social context— have not been engaged here. How should a pragmatics of iconicity be elaborated?

Nearly all of the questions enumerated have been taken up by scholars of iconicity at one point or another, with varying results. But such discussions are, by any account, still in their infancy. The articles in this volume attack many of these problems at their core, bringing fresh and promising strategies to bear on the enduring puzzles of iconic representation.

## 5 Contributions

The first article, “**Wayfinding: Notes on the ‘Public’ as Interactive,**” by **Patrick Maynard**, examines the public nature of representation by signs. He focuses on the challenges and choices faced by the designer of a representation, as she prepares it for use by a broader public, and the various functions such a sign may assume in this context. His analysis is informed throughout by attention to the artifactual nature of visual displays, the intentionality behind their construction, and the cognitive makeup of their consumers.

In “**The Mystery of Deduction and Diagrammatic Aspects of Representation,**” **Sun-Joo Shin** introduces what she calls the “mystery of deduction.” The first aspect of this, “surprise effect,” refers to the fact that the conclusion of a deduction may be surprising, despite the fact that its truth is guaranteed by the truth of the premises, and its content contained in them. The second aspect, “demonstration-difficulty” refers to the challenge of identifying the premises and proof for a theorem which is guaranteed to be true. What explains these “mysteries”? Shin explores this question as it arises for logical reasoning carried out in different representational media, in particular symbolic and diagrammatic proof.

In “**Meaning and Demonstration,**” **Matthew Stone** and **Una Stojnic** examine the phenomena of demonstration, in which an interlocutor at once performs a practical action and communicates a message through that action. They focus on the case

of an origami-based proof of the Pythagorean Theorem— that is, a demonstration which communicates a geometrical proof through the actions of folding, unfolding and cutting a piece of paper. By relying on David Lewis's characterizations of coordination and conversational scorekeeping, Stone and Stojnic aims to show how practical actions can acquire precise informational significance. In their view, as a discourse unfolds, representations of diverse kinds make integrated contributions to an evolving conversational record.

**“The Cognitive Design of Tools of Thought”** by **Barbara Tversky** explores the ways in which humans deliberately modify their spatial environments to express, shape, and extend their cognitive lives. She illustrates these ideas with a panoply of historical and contemporary examples, ranging over diverse media, with case studies drawn from both naturally occurring uses and laboratory studies.

In **“Diagrams as Tools for Scientific Reasoning,”** **Adele Abrahamsen** and **William Bechtel** examine the role of diagrams in scientific inquiry through a case study of diagrams used in circadian rhythm research. They argue that diagrams in science serve not only as useful vehicles of communication, but as integrated parts of the research itself. Scientists rely on diagrams to “give a shape” to the phenomena that are to be explained, to identify explanatory relations, and to construct and revise their theories.

**Marcello Frixione** and **Antonio Lombardi** propose a pragmatic approach to pictorial communication in **“Street Signs and Ikea Instruction Sheets: Pragmatics and Pictorial Communication.”** The authors take aim at Wittgensteinian skepticism about the possibility of communication with pictures, arguing that verbal communication suffers from the same apparent defects. Both challenges can be met, they hold, with suitable attention to the pragmatics of communication, and they illustrate a Gricean approach with examples drawn from street signs and Ikea instructions.

In **“Pictures Have Propositional Content”** **Alex Grzankowski** argues for the claim expressed by his title. A common objection to the view turns on the apparent impossibility of expressing negation by pictorial means. Grzankowski first contends that the objection misses its mark, and goes on to argue that closely related phenomena in fact imply the opposite— that pictures do, after all, have propositional content.

In **“Analog Representation and the Parts Principle,”** **John Kulvicki** reconsiders the familiar distinction between analog and digital representation, arguing that we can achieve a better taxonomy of representational kinds by leaving aside the traditional focus on continuous versus discrete structure. Instead, he proposes that a version of the “Parts Principle,” prominently advocated by Jerry Fodor, captures the distinctive character of analog representation. But Kulvicki reconceives a picture's “parts” as including the levels of abstraction that it realizes. On the resulting view, analog representations are structure-preserving representations which allow viewers to freely engage the content expressed at multiple levels of abstraction.

Finally, in **“Trompe l'oeil” and the Dorsal/Ventral Account of Picture Perception,”** **Bence Nanay** takes an interdisciplinary approach to the topic of picture perception. He aims to resolve long-standing puzzles about the perception of *tromp l'oeil* depictions, by drawing on his own “dorsal/ventral account” of picture

perception. Nanay holds that the characteristic “two-foldedness” of picture perception derives from the duality of dorsal and ventral visual processing, and goes on to apply this idea both to *tromp l’oeil* perception and normal picture perception.

**Acknowledgments** We would like to thank Paul Egré and Roberto Casati at the *Institut Jean Nicod*, and Allan Nebres, Christi Lue and Ties Nijssen at *Springer* for their patience and competence as they helped us to prepare this issue. We thank Joshua Armstrong, Sam Cumming, and Katie Elliott for constructive conversation and Milo Crimi for editorial assistance. Special thanks are due to our anonymous reviewers for their careful and insightful comments, and to our authors for their outstanding contributions.

## References

- Abell, C. 2009. Canny resemblance. *The Philosophical Review*, 118(2): 183-223.
- Alberti, L.B 1991/1435. *On painting*, ed. C. Grayson. London: Pengu in Classics.
- Armstrong, J. 2013. Language change in context. PhD diss., Rutgers University.
- Bordwell, D. 2008. Poetics of cinema. Routledge New York. ISBN: 0415977789.
- Burge, T. 2010. *Origins of objectivity*. Oxford: Oxford University Press.
- Casati, R., and V. Giardino 2013. Public representation and indeterminacies of perspectival content. In *Enacting images*, ed. Zsuzsanna Kondor, 111-126. Herbert von Halem Verlag.
- Chomsky, N. 1957. *Syntactic structures*. Walter de Gruyter.
- Chomsky, N. 1965. *Aspects of the theory of syntax*. The MIT press.
- Clowes, M.B. 1971. On seeing things. *Artificial Intelligence*, 2(1): 79116.
- Cumming, S., G. Greenberg, and R Kelly 2014. The representation of space in visual sequences.
- DeCarlo, D., A. Finkelstein, S. Rusinkiewicz, and A. Santella. 2003. Suggestive contours for conveying shape. *ACM Transactions on Graphics (TOG)*, 22(3): 848-855.
- Dubery, F., and J. Willats 1972. *Drawing systems*. Studio Vista London.
- Euler, L. 1795. *Letters to a german princess, on different subjects in physics and philosophy*. London.
- French, S. 2003. A model-theoretic account of representation (or, i dont know much about art but i know it involves isomorphism). *Philosophy of Science*, 70(5): 14721483.
- Gombrich, E.H. 1960. *Art and illusion: a study in the psychology of pictorial representation*. London: Phaidon.
- Goodman, N. 1968. *Languages of art: an approach to a theory of symbols*. Indianapolis: Bobbs-Merrill.
- Greenberg, G. 2011. The semiotic spectrum. PhD diss., Rutgers University.
- Greenberg, G. 2013. Beyond resemblance. *Philosophical Review*, 122(2): 215287.
- Guzman, A. 1969. Decomposition of a visual scene into three-dimensional bodies. In *Automatic interpretation and classification of images*, ed. A. Griselli, 243-276. New York: Academic Press.
- Hagen, M.A. 1986. *Varieties of realism: geometries of representational art*. Cambridge: Cambridge University Press.
- Hammer, E., and S.J. Shin. 1998. Eulers visual logic. *History and Philosophy of Logic*, 19(1): 129. ISSN: 0144-5340.
- Hauser, M.D, N. Chomsky, and W Tecumseh Fitch. 2002. The faculty of language: what is it, who has it, and how did it evolve? *Science*, 298(5598): 1569-1579.
- Huffman, D.A. 1971. Impossible objects as nonsense sentences. *Machine Intelligence*: 295.
- Hyman, J. 2006. *The objective eye: color, form, and reality in the theory of art*. Chicago: University of Chicago Press.
- Kulvicki, J. 2006. *On images: their structure and content*. Oxford: Clarendon.
- Larkin, J.H., and H.A Simon. 1987. Why a diagram is (sometimes) worth ten thousand words. *Cognitive Science*, 11(1): 65-100.
- Lascarides, A., and M. Stone. 2009. A formal semantic analysis of gesture. *Journal of Semantics*, 26(4).
- Lewis, D. 1969. *Convention: a philosophical study*. Oxford: Blackwell.
- Lewis, D. 1975. Languages and language. In *Language, mind and knowledge*, ed. Keith Gunderson, 3-35. Vol. 7. Minnesota Studies in the Philosophy of Science. Minneapolis: University of Minnesota Press.
- Maynard, P. 2005. *Drawing distinctions: the varieties of graphic expression*. Cornell University Press.



- Neurath, O. 1945/1973. Visual education: humanisation versus popularisation. In, ed. R. S. Cohen and M. Neurath, 227-248. Dordrecht: Reidel.
- Palmer, S. 1999. *Vision science: photons to phenomenology*. The MIT Press.
- Peirce, C.S. 1868. On a new list of categories. In *Proceedings of the american academy of arts and sciences*, 287-298. Vol. 7. 1868.
- Peirce, C.S. 1906. Prolegomena to an apology for pragmatism. *The Monist*, 16(4): 492-546.
- Saussure, F., C. Bally, A. Séchehaye, A. Riedlinger, L.J. Calvet, and T. De Mauro. 1922. *Cours de linguistique générale*. Paris: Payot.
- Schier, F. 1986. *Deeper into pictures: an essay on pictorial representation*. Cambridge University Press.
- Schlenker, P., J. Lamberton, and M. Santoro. 2013. Iconic variables. *Linguistics and philosophy*, 36(2): 91-149.
- Sedgwick, H.A. 1980. The geometry of spatial layout in pictorial representation. In *The perception of pictures*, 33-90. Vol. 1. London: Academic Press.
- Shin, S.J. 1994. The logical status of diagrams. Cambridge Univ Press.
- Smith, R. 2014. Aristotle's logic. In *The stanford encyclopedia of philosophy*, Spring 2014, ed. Edward N. Zalta.
- Tversky, B. 2011. Visualizing thought. *Topics in Cognitive Science*, 3(3): 499-535.
- Venn, J. 1881. *Symbolic logic*. Macmillan.
- Waltz, D. 1975. Understanding line drawings of scenes with shadows. In *The psychology of computer vision*. Citeseer.
- Willats, J. 1997. *Art and representation: new principles in the analysis of pictures*. Princeton: Princeton University Press.