

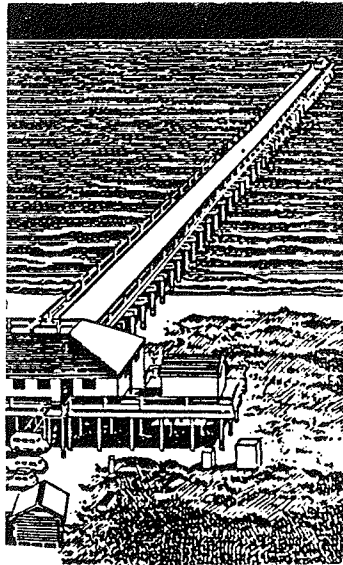

US Army Corps
of Engineers



TECHNICAL REPORT CERC-89-3

INVESTIGATION OF BREAKWATER STABILITY AT PRESQUE ISLE PENINSULA ERIE, PENNSYLVANIA

by

Peter J. Grace

Coastal Engineering Research Center

DEPARTMENT OF THE ARMY
Waterways Experiment Station, Corps of Engineers
PO Box 631, Vicksburg, Mississippi 39181-0631



May 1989
Final Report

Approved For Public Release; Distribution Unlimited

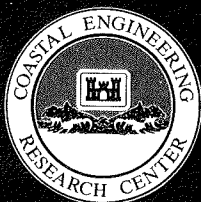
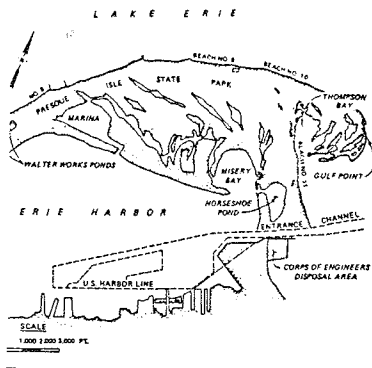

Prepared for US Army Engineer District, Buffalo
1776 Niagara Street
Buffalo, New York 14207-3199

Under Intra-Army Order NCB-1A-88-34JM

Destroy this report when no longer needed. Do not return
it to the originator.

The findings in this report are not to be construed as an official
Department of the Army position unless so designated
by other authorized documents.

The contents of this report are not to be used for
advertising, publication, or promotional purposes.
Citation of trade names does not constitute an
official endorsement or approval of the use of
such commercial products.

Unclassified
SECURITY CLASSIFICATION OF THIS PAGE

REPORT DOCUMENTATION PAGE				Form Approved OMB No. 0704-0188	
1a. REPORT SECURITY CLASSIFICATION Unclassified		1b. RESTRICTIVE MARKINGS			
2a. SECURITY CLASSIFICATION AUTHORITY		3. DISTRIBUTION/AVAILABILITY OF REPORT Approved for public release; distribution unlimited.			
2b. DECLASSIFICATION/DOWNGRADING SCHEDULE					
4. PERFORMING ORGANIZATION REPORT NUMBER(S) Technical Report CERC-89-3		5. MONITORING ORGANIZATION REPORT NUMBER(S)			
6a. NAME OF PERFORMING ORGANIZATION USAEWES, Coastal Engineering Research Center	6b. OFFICE SYMBOL (If applicable)	7a. NAME OF MONITORING ORGANIZATION			
6c. ADDRESS (City, State, and ZIP Code) PO Box 631 Vicksburg, Mississippi 39181-0631		7b. ADDRESS (City, State, and ZIP Code)			
8a. NAME OF FUNDING/SPONSORING ORGANIZATION US Army Engineer District, Buffalo	8b. OFFICE SYMBOL (If applicable)	9. PROCUREMENT INSTRUMENT IDENTIFICATION NUMBER Intra-Army Order NCB-IA-88-34JM			
8c. ADDRESS (City, State, and ZIP Code) 1776 Niagara St. Buffalo, NY 14207-3199		10. SOURCE OF FUNDING NUMBERS			
		PROGRAM ELEMENT NO.	PROJECT NO.	TASK NO.	WORK UNIT ACCESSION NO.
11. TITLE (Include Security Classification) Investigation of Breakwater Stability at Presque Isle Peninsula, Erie, Pennsylvania					
12. PERSONAL AUTHOR(S) Grace, Peter J.					
13a. TYPE OF REPORT Final report		13b. TIME COVERED FROM Jun 88 TO Aug 88	14. DATE OF REPORT (Year, Month, Day) May 1989		15. PAGE COUNT 58
16. SUPPLEMENTARY NOTATION Available from National Technical Information Service, 5285 Port Royal Road, Springfield, VA 22161.					
17. COSATI CODES			18. SUBJECT TERMS (Continue on reverse if necessary and identify by block number)		
FIELD	GROUP	SUB-GROUP			
			Breakwater Physical model		
			Irregular waves Stability		
			Monochromatic waves Wave transmission		
19. ABSTRACT (Continue on reverse if necessary and identify by block number) A physical model investigation was performed to establish a stable breakwater design for use in the proposed construction of 58 offshore breakwaters at Erie, Pennsylvania. The study was conducted at a geometrically undistorted linear scale of 1:22, model to prototype. Monochromatic and irregular wave conditions were generated to simulate design wave conditions at still-water levels of +1.9 ft and +7.5 ft, low water datum. Incident and transmitted wave heights were measured throughout the investigation. Tests indicated that the armor design proposed by the sponsor was adequate. This design was characterized by an armor layer consisting of stones with weights ranging from 3.5 to 7.5 tons. Additional tests indicated that use of a 1.4- to 7.5-ton armor stone weight range resulted in an unstable structure. A final breakwater design armored with 2.9- to 7.5-ton stone was also tested and found to be adequate. A presentation of wave transmission measurements is included.					
20. DISTRIBUTION/AVAILABILITY OF ABSTRACT <input checked="" type="checkbox"/> UNCLASSIFIED/UNLIMITED <input type="checkbox"/> SAME AS RPT. <input type="checkbox"/> DTIC USERS			21. ABSTRACT SECURITY CLASSIFICATION Unclassified		
22a. NAME OF RESPONSIBLE INDIVIDUAL			22b. TELEPHONE (Include Area Code)		22c. OFFICE SYMBOL

PREFACE

The model investigation reported herein was requested by the US Army Engineer District, Buffalo (NCB), and the US Army Engineer Division, North Central (NCD), and conducted at the Coastal Engineering Research Center (CERC) of the US Army Engineer Waterways Experiment Station (WES). Funding authorization was granted by NCB through Intra-Army Order NCB-IA-88-34JM, dated 25 May 1988.

Physical model tests and report preparation were performed at WES during June through August 1988 under general direction of Dr. James R. Houston and Mr. Charles C. Calhoun, Jr., Chief and Assistant Chief, CERC, respectively; and under direct supervision of Mr. C. Eugene Chatham, Jr., Chief, Wave Dynamics Division (CW), and Mr. D. D. Davidson, Chief, Wave Research Branch, (CW-R). Testing was performed by Messrs. Cornelius Lewis, Sr., Engineering Technician, CW, John M. Heggins, Computer Technician, CW, and L. L. Friar, Instrumentation Specialist, Instrumentation Services Division, under the supervision of Mr. Peter J. Grace, Research Hydraulic Engineer, CW. Assistance related to establishing irregular waveboard control signals was provided by Ms. Jane Smith, Research Division, CERC. This report was prepared by Mr. Grace and edited by Ms. Shirley A. J. Hanshaw, Information Technology Laboratory, WES.

During the course of this investigation, liaison was maintained among CERC, Mr. Charlie Johnson of NCD, and Mr. Denton Clark of NCB. During the course of the study, Mr. Johnson visited WES to observe model operations and provide valuable input.

Commander and Director of WES during publication of this report was COL Dwayne G. Lee, EN. Technical Director was Dr. Robert W. Whalin.

CONTENTS

	<u>Page</u>
PREFACE.....	1
CONVERSION FACTORS, NON-SI TO SI (METRIC) UNITS OF MEASUREMENT.....	3
PART I: INTRODUCTION.....	4
The Prototype.....	4
The Problem.....	4
Purpose of the Model Study.....	8
PART II: THE MODEL.....	9
Model Design.....	9
Test Facilities and Equipment.....	10
Test Conditions.....	11
Test Procedures.....	14
PART III: BREAKWATER STABILITY TESTS.....	16
Description of Proposed Breakwater Design.....	16
Conditions Tested and Results.....	16
Wave Transmission Measurements.....	19
PART IV: CONCLUSIONS.....	24
REFERENCES.....	25
TABLES 1-20	
PHOTOS 1-18	

CONVERSION FACTORS, NON-SI TO SI (METRIC)
UNITS OF MEASUREMENT

Non-SI units of measurement used in this report can be converted to SI (metric) units as follows:

<u>Multiply</u>	<u>By</u>	<u>To Obtain</u>
acres	4,046.873	square metres
cubic feet	0.02831685	cubic metres
cubic yards	0.7645549	cubic metres
feet	0.3048	metres
inches	2.54	centimetres
miles (US statute)	1.609347	kilometres
pounds (mass)	0.4535924	kilograms
pounds (mass) per cubic foot	16.01846	kilograms per cubic metre
square feet	0.09290304	square metres
tons (short)	907.1847	kilograms

INVESTIGATION OF BREAKWATER STABILITY AT PRESQUE ISLE
PENINSULA, ERIE, PENNSYLVANIA

PART I: INTRODUCTION

The Prototype

1. Harbor facilities at Erie, Pennsylvania, are protected by Presque Isle Peninsula, a sand spit which extends northeastward from the south shore of Lake Erie (Figure 1). The peninsula is located approximately 78 miles* southwest of Buffalo, New York, in US Army Engineer Division, Buffalo (NCB), and its northern shore is fronted by 11 recreational beaches controlled by the Pennsylvania Park Service. These beaches are used extensively during the summer months, as is Presque Isle State Park which occupies 3,200 acres of the peninsula. This park provides facilities for outdoor activities such as boating, hiking, and fishing, to approximately 4 million visitors each year.

The Problem

2. Physical characteristics of the peninsula and past experience have indicated that sediment transport along the lakeside shoreline occurs from west to east; therefore, the peninsula has a tendency to migrate eastward. Because of this migration and the ever decreasing supply of sand feeding the peninsula, the area has a relatively long history of erosion problems. Since development of Erie Harbor in the early 1800's, shore protection measures have been required in the area to the west where the peninsula joins the mainland. At times, breaches up to 1 mile wide occurred, thereby exposing the harbor area to wave attack from Lake Erie. In the mid-1800's, efforts were made to prevent these breaches, among which was the construction of timber crib breakwaters filled with stone and brush. However, these efforts were unsuccessful, and shoreline erosion along the peninsula has been a persistent problem.

3. In the 1950's, severe beach erosion along the entire length of the

* A table of factors for converting non-SI units of measurement to SI (metric) units is presented on page 3.

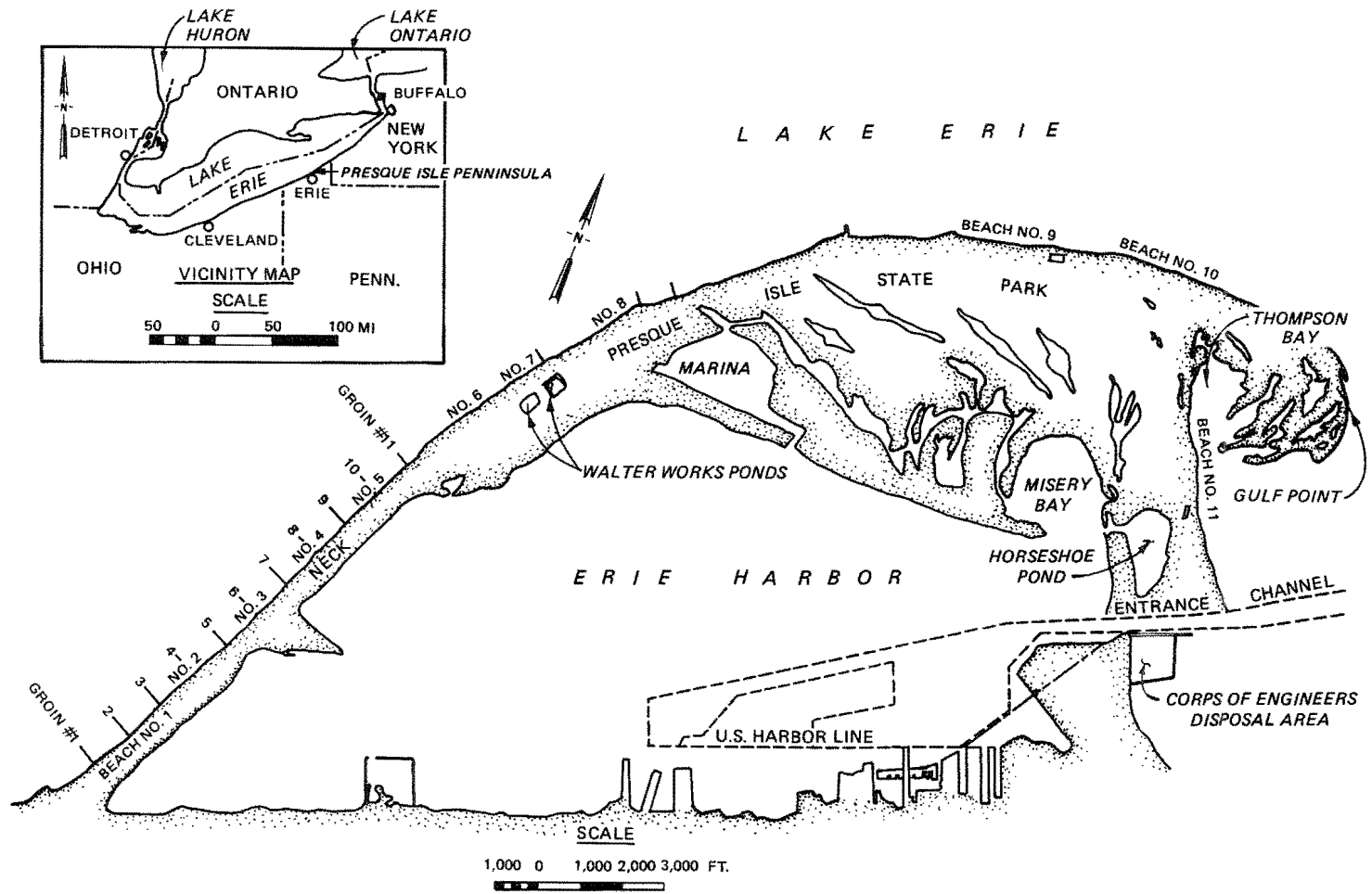

Figure 1. Project vicinity and location map

peninsula led to a cooperative beach protection program involving the US Government and the State of Pennsylvania. This program, which was authorized in 1954, included measures to improve existing groins, construct ten new sheet-pile groins, and place 4,150,000 cu yd of sand beach fill.

4. The last major authorization of protective measures occurred as part of the 1976 Water Resources Development Act which authorized extension of beach nourishment activities to take place until a more permanent solution could be developed and implemented. This program has been a cooperative effort between the US Government and the Pennsylvania Department of Environmental Resources. It consists primarily of beach nourishment activities which are executed each spring, just prior to the bathing season. Up to 1983, the amount of sand deposited had averaged more than 200,000 tons per year at an annual cost of more than \$ 1 million (NCB 1983). The more permanent solution, referred to above, was authorized by Section 101(a) of the 1976 Water Resources Development Act. This project, which may be referred to as the Presque Isle Breakwater Plan, calls for the construction of 58 detached breakwaters, each 150 ft long, 350 ft apart, and 200 to 300 ft offshore. It also specifies (a) placement of approximately 500,000 cu yd of sand fill to provide a beach berm with an average width of 60 ft and crest elevation of 10.0 ft above low water datum (lwd), and (b) annual replenishment of approximately 38,000 cu yd of sand fill to maintain the minimum design beach dimensions.

5. In an effort to study the behavior of the proposed structure and its effect on shoreline erosion, NCB constructed three experimental detached breakwater segments along the east end of Presque Isle Peninsula in 1978 (Figure 2). Each of these breakwaters was 125 ft long, with a crest elevation of +6.0 ft lwd and a crest width of 6 ft. Armor stone weights ranged from 1.5 to 3.5 tons. The results of these prototype experiments indicated that the presence of the offshore breakwaters resulted in good development of tombolos during the summer months with gradual erosion of this accreted material in the winter and spring. In general, it was concluded that the offshore rubble-mound segmented breakwaters could provide substantial protection against shoreline erosion along Presque Isle Peninsula. There exist no records of maintenance repairs associated with the breakwaters since their construction and in 1986 when it was reported that the three structures were in good condition (Bottin 1987).



Figure 2. Existing breakwaters at Presque Isle Peninsula

6. During May 1980 through February 1982, the US Army Engineer Waterways Experiment Station's (WES's) Hydraulics Laboratory conducted a 1:50 scale hydraulic model investigation to evaluate the use of detached offshore breakwaters as a preventive measure against shoreline erosion and, if necessary, to refine and optimize breakwater parameters such as length, height, distance between breakwaters, distance offshore, and orientation (Seabergh 1983). The results of that study indicated that the breakwater designs proposed by NCB were satisfactory, in terms of spacings and geometric characteristics, and that good tombolo formation and beach retention during severe wave conditions were accomplished. No breakwater stability tests were performed during that investigation.

Purpose of the Model Study

7. Original sizing of the breakwater armor stones was based on a Goda significant wave height of 9.2 ft and a head stability coefficient of 2.5. Previous experience with stability of breakwaters on the lakeshore at Chicago, Illinois, had indicated that use of the Goda significant wave height for breakwater trunks with a stability coefficient of 3.5 resulted in a very conservative design; however, due to the segmented nature of the proposed breakwaters, there was much concern relative to the stability of the breakwater head sections. For this reason, NCB and US Army Engineer Division, North Central (NCD), requested that WES's Coastal Engineering Research Center (CERC) perform the physical model investigation documented herein. The purpose of that investigation was to evaluate the stability of the breakwater head sections when subjected to extreme monochromatic and irregular wave attack.

PART II: THE MODEL

Model Design

8. This physical model study was conducted at a geometrically undistorted linear scale of 1:22, model to prototype. Selection of this scale was based on several factors, including (a) specifications of the proposed breakwater design, (b) availability of required model stone sizes, (c) capabilities of the available wave generator, and (d) preclusion of stability scale effects. Based on Froude's Model Law (Stevens et al. 1942) and the linear scale of 1:22, the following model-to-prototype relations were derived. Dimensions are in terms of length L and time T .

<u>Characteristic</u>	<u>Dimension</u>	<u>Model to Prototype Scale Relation, r</u>
Length	L	$L_r = 1:22$
Area	L^2	$A_r = L_r^2 = 1:484$
Volume	L^3	$V_r = L_r^3 = 1:10,648$
Time	T	$T_r = L_r^{1/2} = 1:4.69$

9. The specific weights of water used in the model and in Lake Erie were both assumed to be 62.4 pcf; however, specific weights of the breakwater stones used in the model were not identical to their prototype counterparts. These variables were related using the following transference equation:

$$\frac{(Wa)_m}{(Wa)_p} = \frac{(\gamma_a)_m}{(\gamma_a)_p} \left(\frac{L_m}{L_p} \right) \left[\frac{(S_a)_p - 1}{(S_a)_m - 1} \right]^3$$

where

Wa = weight of an individual armor unit, lb

m and p = model and prototype quantities, respectively

γ_a = specific weight of an individual armor unit, pcf

L_m/L_p = linear scale of the model

S_a = specific gravity of an individual armor unit relative to the water in which it was placed (i.e., $S_a = \gamma_a / \gamma_w$, where γ_w is the specific weight of water, pcf).

10. As stated earlier, NCB and NCD personnel were primarily concerned with stability of the head sections of the breakwaters; therefore, the breakwater test section was constructed to a model length of 5.5 ft (one half of the 11-ft flume width) as shown in Figure 3. This section corresponds to

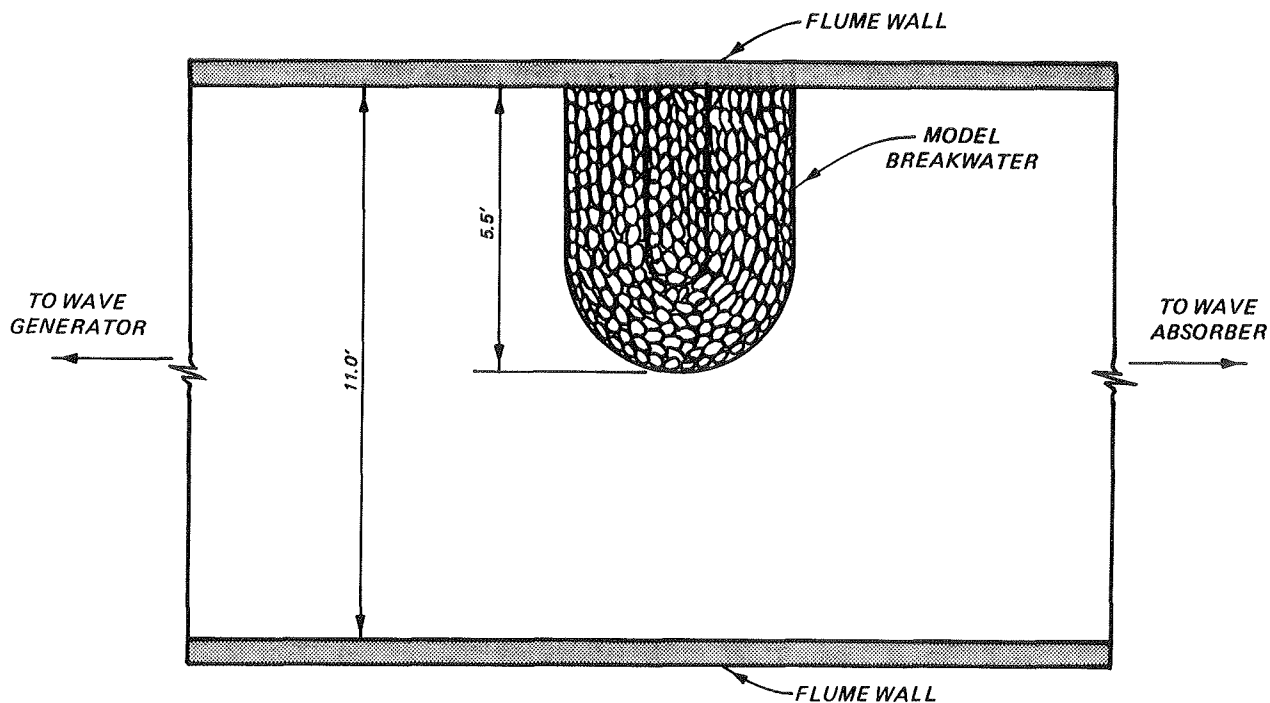

Figure 3. Plan view of 11-ft flume with structure simulation of a 121-ft-long section of the prototype breakwater. The remaining 5.5 ft of flume width allowed sufficient space between the breakwater head and flume wall to achieve proper modeling of wave dynamics and structural response at and around the head.

Test Facilities and Equipment

11. As mentioned above, the model study was performed in an 11-ft-wide flume. The entire length of this facility is 245 ft; however, since other model structures related to ongoing research and development efforts occupied the window portion of the flume, the Presque Isle study was conducted in the 165-ft-long area toward the wave generator from the existing structures (Figure 4). This location allowed for a 50-ft-long, flat-bottomed deepwater

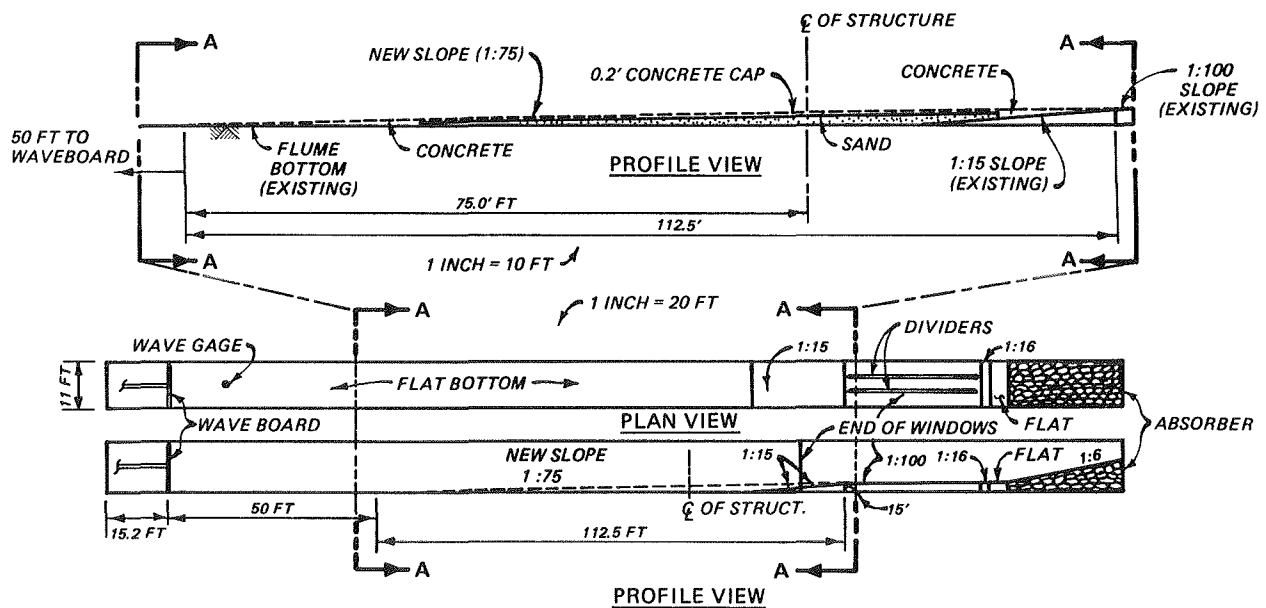

Figure 4. Details of 11-ft flume

section immediately shoreward of the waveboard followed by a 1:75 bottom slope for the remaining 115 ft. The prototype water depth at the waveboard was -29.0 ft lwd, and the lakeward toe of the test structure was located at a depth of -7.0 ft lwd.

12. The 11-ft-wide flume was equipped with a wave generator characterized by a hydraulically actuated piston-driven wave board. This generator was capable of producing unidirectional monochromatic and irregular waves. Wave heights were measured in the model using capacitance wave gages and a sampling rate of 20 Hz. Wave signal generation and data acquisition were controlled by a Digital Equipment Corporation (DEC) MicroVAX I computer. Analysis of the collected wave data was accomplished with a DEC VAX 11/750.

Test Conditions

13. NCB and NCD personnel requested that both monochromatic and irregular wave conditions be used during stability testing. They also specified that test conditions include high (+7.5 ft lwd) and low (+1.9 ft lwd) still water levels (swl's).

14. Irregular wave conditions were established using a numerical algorithm which simulates shoaling of a wave spectrum from deep water to a given shallower depth based on an input deepwater wave height and peak frequency. The nearshore spectrum was assumed to be fully developed and was

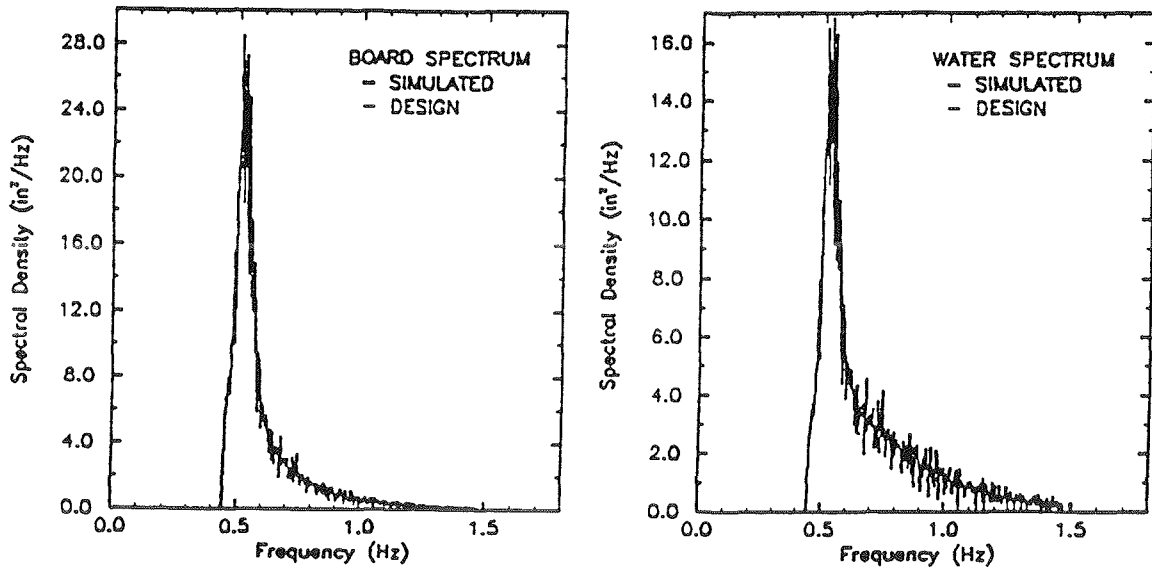

```

WINDOW MODE = 1 (COSINE SQUARED)
DETTREND MODE = 1 (MEAN REMOVED)
WATER DETTREND FUNCTION = (-0.7056E-03) + ( 0.0000E+00)*T + ( 0.0000E+00)*(T**2)
BOARD DETTREND FUNCTION = (-0.8373E-03) + ( 0.0000E+00)*T + ( 0.0000E+00)*(T**2)
WINDOW FRACTION = 0.10
BANDS AVERAGED = 10

```

```

UNIDIRECTIONAL WAVE TANK GENERATOR DIGITAL DRIVER FILE HEADER (V3.0 JAN 88)
OUTPUT FILE - HIGHWAT.DAT
BOARD - PISTON
SPECTRUM - SINGLE PEAKED TMA
TRANSFER FUNCTION BY BIESEL (1953) CORRECTION - AHRENS (A= 0.60)
LOW FREQ. BOUND = 0.449414E+00 HZ (AT POINT OF 3.0000 PCNT TOTAL VARIANCE)
HIGH FREQ. BOUND = 0.146829E+01 HZ (AT POINT OF 97.0000 PCNT TOTAL VARIANCE)
TIME SERIES - LENGTH = 1800 SEC (18000 STEPS AT 10 STEPS/SEC)
STROKE - MAXIMUM = 6.813 IN, MINIMUM = -6.423 IN
SPECTRUM PARAMETERS
PP (SEC) HS (IN) GAMMA SIGLO SIGHI ALPHA FP (HZ)
0.1920E+01 0.6569E+01 0.4490E+01 0.7000E-01 0.9000E-01 0.1606E-01 0.5208E+00

```

Figure 6. Characteristics of waveboard control spectrum at +7.5 ft swl

A 9.0-sec period of peak energy density was used for both swl's. Analysis of wave height data indicated that incident zero moment wave heights H_{mo} measured just lakeward of the breakwater toe averaged 7.8 ft and 10.2 ft for the +1.9-ft lwd and +7.5-ft lwd swl's, respectively. Detailed tabulations of the measured wave data are presented in Tables 3 through 20.

15. Monochromatic wave tests were performed using 7.0- and 9.0-sec waves at each swl. For a given period and water depth, the most severe breaking wave (i.e., the wave which broke directly on the structure) was determined by varying the waveboard stroke length in small increments and observing which stroke length resulted in the most potentially destructive

waves at the structure. Once established, these worst wave conditions then were used in subsequent stability tests. Analysis of the monochromatic wave data indicated that the structure was subjected to the following regular wave conditions:

<u>SWL, ft</u>	<u>T, sec</u>	<u>Hswb,* ft</u>	<u>Hsns,** ft</u>
+1.9	7.0	6.3	7.4
+1.9	9.0	5.7	8.0
+7.5	7.0	11.3	11.3
+7.5	9.0	9.3	10.9

* Hswb = prototype significant wave height just shoreward of waveboard.

** Hsns = prototype significant wave height just lakeward of structure.

Test Procedures

16. At CERC, calibration of the test facility is normally performed without the breakwater structure in place; therefore, conditions are analogous to the prototype conditions for which the measured and/or predicted design wave data were determined. For both monochromatic and irregular wave tests, wave gages were placed in the wave flume at a point that would coincide with the toe of the proposed breakwater section, and the wave generator was calibrated for the various wave conditions. Once calibration was completed, the breakwater section was placed in the wave flume, and the wave generator was again tuned to determine the most severe breaking waves that could be experimentally made to attack the structure (i.e., for each swl and wave period, the length of the waveboard stroke was varied slightly until the most severe wave condition relative to armor stability was obtained).

17. Model breakwater sections were constructed to reproduce, as closely as possible, the results of prototype breakwater construction. Bedding material, dumped by bucket and shovel, was compacted and smoothed to grade with hand trowels in an effort to simulate the natural consolidation that would occur during prototype construction. With the bedding material in place, the armor stone then was placed on the structure by hand. Exposure of the bedding layer to excessive pressure or compaction was carefully avoided. The armor stones were positioned using random placement techniques; i.e.,

stones were individually hand-placed, but no intentional interlocking or special orientation was achieved.

18. The following list of adjectives, in order of increasing severity, was used for recording model observations and reporting test results for each test plan: (a) slight, (b) minor, (c) moderate, (d) significant, (e) major, and (f) extensive. "Slight" and "minor" described acceptable results, and "moderate" described borderline acceptability, whereas "significant" to "extensive" described unacceptable levels of increasing severity. Use of these adjectives allowed for some degree of quantification of the severity of resulting damage incurred by the breakwater's armor layer.

PART III: BREAKWATER STABILITY TESTS

Description of Proposed Breakwater Design

19. As mentioned previously, the recommended plan involves the construction of 58 offshore breakwater segments for wave attenuation and the prevention of beach erosion along approximately 5.5 miles of shoreline on the lakeward side of Presque Isle Peninsula. Each breakwater segment will be 150 ft long with a 350-ft gap width between adjacent segments. The breakwaters will be aligned parallel to the peninsula shoreline and constructed about 200 to 300 ft offshore of the existing beach. There are actually two breakwater designs which will be used in construction of the 58 segments. The westernmost 21 breakwater segments will be slightly more massive than the remaining 37 segments which will protect the beaches farther east. The two different designs were required due to the variation in water depth between the east and west ends of the peninsula. The larger breakwaters will, of course, be constructed in the deeper areas. Design cross sections of the two breakwater plans are presented in Figure 7. This investigation was performed to optimize the design of the larger breakwater plan only.

20. Wave and water level conditions used by NCB in establishing the larger breakwater design are (a) design deepwater wave height, 12.8 ft; (b) design incident significant wave height, 9.2 ft; (c) design wave period, 9.0 sec; and (d) nearshore slope, 1:75. The water depth at the structure toe is 14.5 ft for design water level (+7.5 ft, lwd) and 18.9 ft for the 1900-1985 average water level (+1.9 ft, lwd). As shown in Figure 7, the breakwater design is characterized by only two stone classifications, a bedding layer composed of 1- to 15-in.-diam stones, on top of which lies the 3.5- to 7.5-ton armor material. All stone weights were based on the assumption that the density of prototype stone was 155 pcf. The specified crest width and crest height for the structure were 11.0 and +8.0 ft lwd, respectively.

Conditions Tested and Results

21. Stability tests were initiated using the breakwater design section originally proposed by NCB. This design (Plan A) was characterized by an

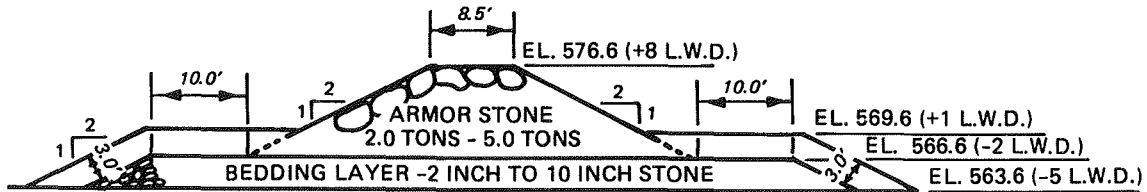

TYPICAL SECTION
 BEACH NO. 6 TO BEACH NO. 10
 37 BREAKWATER SEGMENTS

a. For the 37 easternmost segments

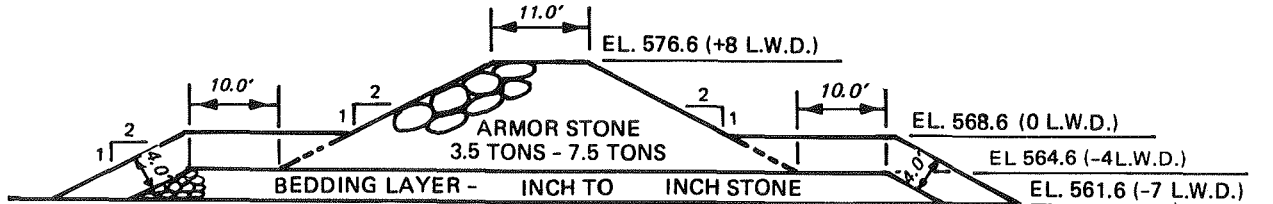

TYPICAL SECTION
 BEACH NO. 1 TO BEACH NO. 5
 21 BREAKWATER SEGMENTS

SCALE



b. For the 21 westernmost segments

Figure 7. Proposed breakwater design cross sections

armor layer consisting of stones with weights ranging from 3.5 to 7.5 tons. Photos 1-3 were taken of the structure before testing was begun. This structure was first subjected to 7.0-sec, 11.3-ft, monochromatic waves at the +7.5-ft swl. Ninety-second-long test cycles (7-min prototype) were repeated until a cumulative prototype duration of 5.3 hr of wave attack was accomplished. The use of repetitive, short (90-sec) test cycles during monochromatic testing ensured that the structure was not subjected to an undefined system of waves created by reflections from the model boundaries and/or wave generator. The structure responded to this first series of 7.0-sec, monochromatic wave attack with virtually no damage incurred. Plan A was then subjected to 5.3 prototype hours of attack by 9.0-sec, 10.9-ft, monochromatic waves at the +7.5 ft swl, and only slight damage was observed. Although damage was slight, photographs depicting the structure after monochromatic testing were taken (Photos 4-6) in preparation for stability tests with irregular waves.

22. Spectral stability tests at the higher swl then were initiated, and repetitive 30-min test cycles were run until a 7.0-hr prototype storm

($T_p = 9.0$ sec, $H_{mo} = 10.2$ ft) had been simulated in the model. The structure again exhibited a good stability response with only slight damage observed.

23. At this point, the swl was lowered to +1.9 feet lwd, and testing with monochromatic wave attack was resumed. It was soon apparent that wave conditions at the lower swl were much less severe and that the structure was in no danger of being damaged; therefore, after discussion among CERC, NCB, and NCD personnel, a decision was made to change the breakwater design by widening the range of armor stone weights before any further tests were performed. If it could be established that a wider range of armor stone weights was acceptable, it might ease some of the quarrying restrictions, thereby reducing the overall cost of the construction process.

24. The structure was removed, and a new breakwater section (Plan B) was built using an armor layer with stone weights ranging from 1.4 to 7.5 tons. Photos 7-9 show this structure before testing was initiated. Testing with Plan B was begun at the higher swl with 7.0-sec, 11.3-ft monochromatic waves. Again, 90-sec tests were repeated, and after approximately 1.8 hr (prototype) of wave attack, only minor damage had been observed. Testing with 9.0-sec, 10.2-ft monochromatic waves then was initiated. After approximately 1.2 hr (prototype) of attack, significant damage had occurred; and it was obvious that this breakwater design was inadequate. Observations indicated that failure was originating with displacement of armor stones in the 1.4- to 2.1-ton weight range. After these initial movements of the lightest armor stones, progressive failure occurred as larger stones moved into the resulting voids. Photos 10-12 depict the Plan B structure after the testing described above.

25. Due to the mode of failure observed with Plan B, a third design (Plan C) was established. This plan differed from the others in that the armor stone weights ranged from 2.9 to 7.5 tons. The breakwater's condition before testing is depicted in Photos 13-15. The structure was subjected to an extensive series of monochromatic and spectral tests at both the high and low swl's. A list of those test conditions is presented below.

a. SWL = +7.5 ft, lwd.

(1) Monochromatic wave attack.

(a) $T = 7.0$ sec, $H = 11.3$ ft, prototype duration = 1.8 hr.

(b) $T = 9.0$ sec, $H = 10.2$ ft, prototype duration = 1.8 hr.

- (2) Irregular wave attack. $T_p = 9.0$ sec, $H_{mo} = 10.2$ ft, prototype duration = 7.0 hr.
- b. SWL = +1.9 ft, lwd.
 - (1) Monochromatic wave attack.
 - (a) $T = 7.0$ sec, $H = 11.3$ ft, prototype duration = 1.8 hr.
 - (b) $T = 9.0$ sec, $H = 10.2$ ft, prototype duration = 1.8 hr.
 - (2) Irregular wave attack. $T_p = 9.0$ sec, $H_{mo} = 10.2$ ft, prototype duration = 7.0 hr.

Throughout this test series, stability results indicated that Plan C was an acceptable breakwater design. To ensure repeatability of the results, the Plan C breakwater section was rebuilt and again subjected to the above most severe monochromatic and irregular wave conditions. Observations indicated that damage was slight. Photos 16-18 show this plan after testing.

Wave Transmission Measurements

26. Transmitted wave heights were measured for all wave conditions used during the stability tests (Tables 3-14). Additional transmission tests, with incident wave heights less than those used during stability testing, were conducted during the last stages of the investigation (Tables 15-20). Summarized results of all wave measurements are presented in Tables 3-20.

27. During the majority of the model tests, the incident and transmitted wave gages were positioned as shown in Figure 8 (Tables 3-14); however, there was concern that wave energy diffracted around the breakwater head was substantially influencing the transmitted wave data. In an effort to reduce the diffracted component of the wave transmission measurements, the gages were moved to the positions indicated in Figure 9 (Tables 15-21).

28. For all tests reported herein, the wave transmission coefficient C_t is defined as

$$C_t = \frac{H_t}{H_i}$$

where H_t is the transmitted wave height, and H_i is the incident wave height. Separate values of the transmission coefficient were calculated for each of the two transmitted wave gages; however, in all cases measurements

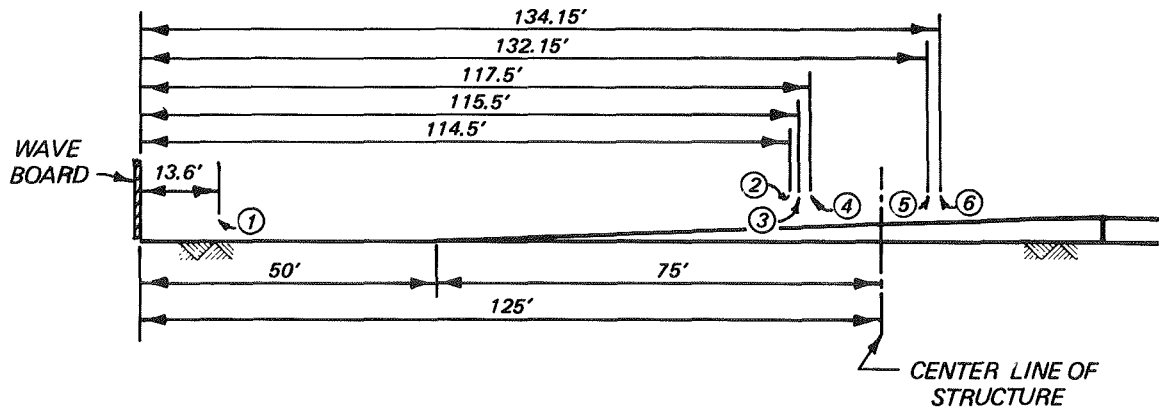

a. Profile

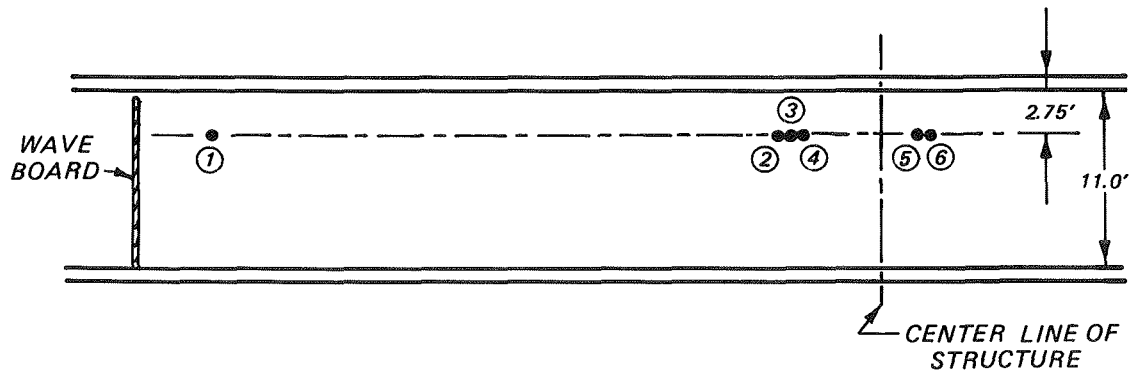

b. Plan

Figure 8. Wave gage locations used during stability tests

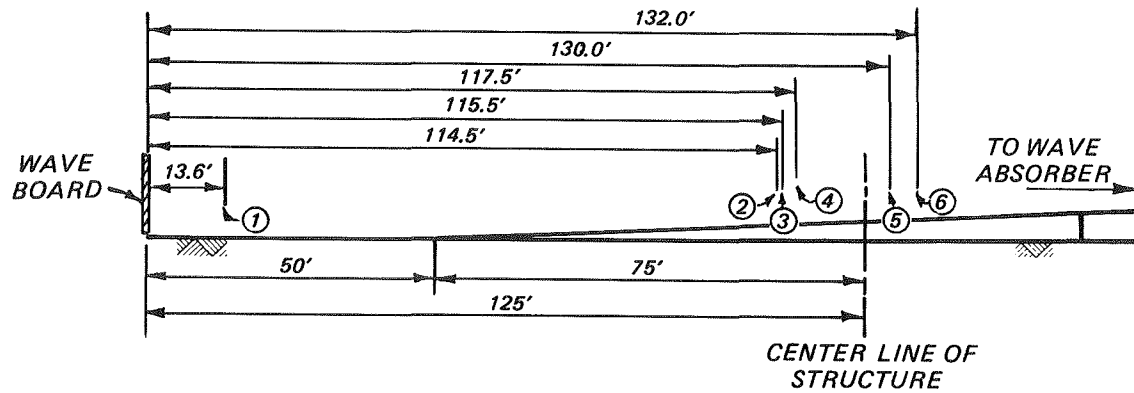

a. Profile

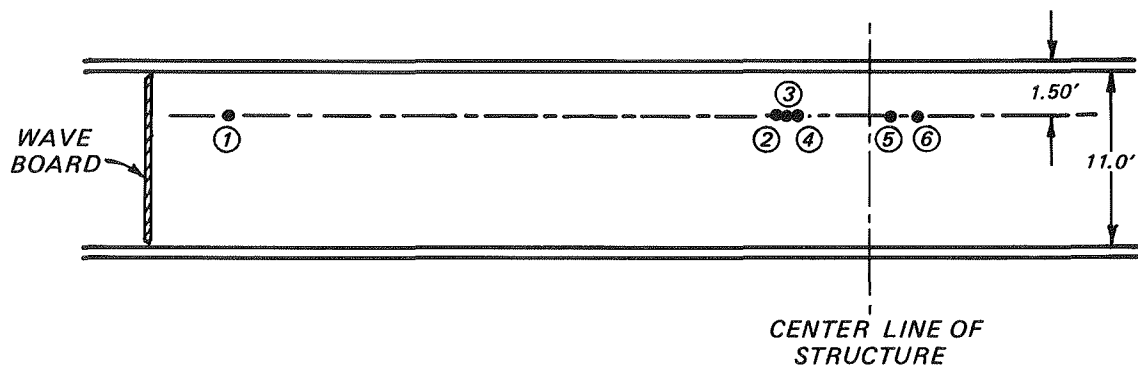

b. Plan

Figure 9. Wave gage locations used during transmission tests

from the lakeward gage nearest the breakwater were used as incident wave heights. For the monochromatic wave tests, gage measurements were averaged for each 90-sec run. These average wave heights then were used for computation of the transmission coefficient. For the irregular wave tests, measured zero moment wave heights were used in the same manner. A condensed tabulation of the wave transmission data is presented below. As mentioned previously, more detailed listings of the measured wave data are included in Tables 3-20.

a. Stability tests (performed with design incident wave heights).

(1) Plan A.

Monochromatic wave attack

swl = +7.5 ft, T = 7.0 sec; avg C_t = 0.35

swl = +7.5 ft, T = 9.0 sec; avg C_t = 0.46

swl = +1.9 ft, T = 7.0 sec; avg C_t = 0.33

Irregular wave attack

swl = +7.5 ft, T_p = 9.0 sec; avg C_t = 0.52

(2) Plan B.

Monochromatic wave attack

swl = +7.5 ft, T = 7.0 sec; avg C_t = 0.43

swl = +7.5 ft, T = 9.0 sec; avg C_t = 0.42

(3) Plan C.

Monochromatic wave attack

swl = +7.5 ft, T = 7.0 sec; avg C_t = 0.41

swl = +7.5 ft, T = 9.0 sec; avg C_t = 0.46

swl = +1.9 ft, T = 7.0 sec; avg C_t = 0.33

swl = +1.9 ft, T = 9.0 sec; avg C_t = 0.33

Irregular wave attack

swl = +7.5 ft, T_p = 9.0 sec; avg C_t = 0.49

swl = +1.9 ft, T_p = 9.0 sec; avg C_t = 0.37

b. Transmission tests (performed with various wave heights) for Plan C.

Monochromatic wave attack

swl = +7.5 ft, T = 7.0 sec; avg C_t = 0.41

swl = +7.5 ft, T = 9.0 sec; avg C_t = 0.53

swl = +1.9 ft, T = 7.0 sec; avg C_t = 0.24

swl = +1.9 ft, T = 9.0 sec; avg C_t = 0.21

Irregular wave attack

swl = +7.5 ft, $T_p = 9.0$ sec, avg $C_t = 0.44$

swl = +1.9 ft, $T_p = 9.0$ sec, avg $C_t = 0.32$

As expected, wave transmission coefficients were greater for those conditions tested at the higher water level. Transmission coefficients for breakwater Plan C ranged between 0.35 and 0.53 for the +7.5 ft swl and from 0.21 to 0.37 for the +1.9 ft swl.

PART IV: CONCLUSIONS

29. Design sections for the proposed Presque Isle breakwaters were constructed in the physical model and subjected to various monochromatic and irregular wave conditions. Based on the results of those stability tests, it was concluded that:

- a. The original breakwater design (Plan A) recommended for construction by NCB proved adequate when subjected to the specified wave and water level conditions. This plan utilized an armor layer with stone weights ranging from 3.5 to 7.5 tons.
- b. A second breakwater design (Plan B) was tested in an effort to expand the lower end of the acceptable range of armor stone weights. Armor weights for Plan B ranged from 1.4 to 7.5 tons. Monochromatic testing with 7.0- and 9.0-sec waves at the +7.5-ft swl indicated that this plan was unacceptable.
- c. Additional stability tests indicated that a structure with a 2.9- to 7.5-ton armor stone weight range (Plan C) was also acceptable.

30. It should be noted that in all cases of breakwater construction in the model, the armor layer consisted of a mixture of equal volumes of stone from each available weight category. For example, Plan C armor layers were constructed from a stockpiled mixture of model stones, including 1 ft³ of each stone weight listed below.

<u>Model, lb</u>	<u>Prototype, tons</u>	<u>Model, ft³</u>
1.05	7.14	1.0
0.86	5.85	1.0
0.71	4.83	1.0
0.55	3.74	1.0
0.43	2.92	1.0

If it were suspected that such a uniform volumetric distribution would be difficult to achieve in the prototype quarry, then Plan A would be recommended. The slight increase in conservatism would be justified in the event that a portion of the breakwater were armored with loads of stone primarily from the lower range of acceptable weights.

31. Measurements of incident and transmitted wave heights indicated that transmission coefficients for breakwater Plan C ranged between 0.35 and 0.53 for the +7.5 ft swl and from 0.21 to 0.37 for the +1.9 ft swl.

REFERENCES

Bottin, R. R., Jr. 1987 (Mar). "Case Histories of Corps Breakwater and Jetty Structures; Report 3: North Central Division," Repair, Evaluation, Maintenance and Rehabilitation Technical Report CO-3, US Army Engineer Waterways Experiment Station, Vicksburg, MS.

Resio, D. T., and Vincent, C. L. 1976 (Jan). "Design Wave Information for the Great Lakes; Lake Erie," Technical Report H-76-1, Report 1, US Army Engineer Waterways Experiment Station, Vicksburg, MS.

Seabergh, W. C. 1983 (Jun). "Design for Prevention of Beach Erosion at Presque Isle Beaches, Erie, Pennsylvania," Technical Report HL-83-15, US Army Engineer Waterways Experiment Station, Vicksburg, MS.

Stevens, J. C., et al. 1942. "Hydraulic Models," Manuals on Engineering Practice No. 25, American Society of Civil Engineers, New York, NY.

US Army Engineer District, Buffalo. 1983 (Apr). "Current Civil Works Projects of the US Army Corps of Engineers Buffalo District," Buffalo, NY.

Table 1
Extreme Design Wave Height Estimates*

<u>Year</u>	<u>Dir 1</u>	<u>Dir 2</u>	<u>Dir 3</u>	<u>All Dir</u>
<u>Winter Angle Classes</u>				
5	4.6 (0.8)**	7.9 (0.6)	12.1 (0.3)	12.3 (0.8)
10	6.6 (1.0)	9.5 (0.8)	12.8 (0.4)	13.1 (1.1)
20	8.2 (1.3)	10.8 (1.0)	13.4 (0.5)	14.9 (1.3)
50	10.8 (1.6)	12.8 (1.3)	14.4 (0.6)	15.3 (1.6)
100	12.8 (1.8)	14.4 (1.5)	15.1 (0.7)	16.4 (1.9)
<u>Spring Angle Classes</u>				
5	3.6 (0.6)	2.6 (0.5)	7.2 (0.4)	7.3 (0.6)
10	3.9 (0.8)	3.9 (0.6)	8.2 (0.6)	8.5 (0.8)
20	5.6 (1.0)	4.9 (0.8)	9.2 (0.7)	9.6 (1.0)
50	7.2 (1.2)	6.6 (1.0)	10.8 (0.9)	11.2 (1.2)
100	8.9 (1.4)	7.9 (1.1)	11.8 (1.0)	12.4 (1.4)
<u>Summer Angle Classes</u>				
5	3.6 (0.9)	4.3 (0.6)	6.9 (0.6)	7.2 (0.9)
10	3.9 (1.1)	5.2 (0.8)	7.5 (0.8)	7.8 (1.2)
20	4.3 (1.4)	5.9 (1.1)	8.2 (1.0)	8.4 (1.5)
50	5.2 (1.8)	6.9 (1.3)	8.9 (1.2)	9.1 (1.8)
100	6.2 (2.0)	7.5 (1.5)	9.5 (1.4)	9.7 (2.1)
<u>Fall Angle Classes</u>				
5	6.6 (0.2)	8.2 (0.5)	11.5 (0.3)	11.6 (0.5)
10	7.5 (0.2)	9.2 (0.6)	12.1 (0.4)	12.3 (0.6)
20	7.9 (0.3)	10.5 (0.8)	12.8 (0.5)	13.1 (0.8)
50	8.5 (0.4)	11.8 (0.9)	13.8 (0.6)	14.1 (1.0)
100	8.5 (0.4)	13.1 (1.1)	14.4 (0.7)	14.9 (1.1)

* Grid location = 6, 18; latitude = 42.27; longitude = 80.17; shoreline grid point = 18.

** Control band (one standard deviation) estimates for each wave height are included in parentheses.

Table 2

Wave Periods Associated with Design Wave Height Estimates*

<u>Wave Height, ft</u>	<u>Angle Class</u>		
	<u>1</u>	<u>2</u>	<u>3</u>
1	2.3	2.3	2.4
2	3.6	3.5	3.7
3	4.5	4.4	4.7
4	5.2	5.1	5.4
5	5.7	5.6	6.0
6	6.0	5.9	6.4
7	6.2	6.2	6.8
8	6.5	6.5	7.1
9	6.8	6.8	7.5
10	7.1	7.1	7.9
11	7.3	7.3	8.3
12	7.6	7.6	8.7
13	7.9	7.9	9.0
14	8.1	8.2	9.4
15	8.4	8.5	9.8
16	8.7	8.8	10.2
17	8.9	9.1	10.6
18	9.2	9.4	10.9
19	9.5	9.7	11.3
20	9.8	10.0	11.7
21	10.0	10.2	12.1
22	10.3	10.5	12.5
23	10.6	10.8	12.8
24	10.8	11.1	13.2
25	11.1	11.4	13.6

* Grid location = 6, 8; latitude = 42.27; longitude = 80.17; grid point number = 18.

Table 3

Measured Wave Data; Plan A; Monochromatic Wave AttackSWL = +7.5 ft; Prototype Wave Period = 7.0 sec

Run Number	H_{avg} , ft						C_t 5/4	C_t 6/4
	Gage 1	Gage 2	Gage 3	Gage 4	Gage 5	Gage 6		
1	10.3	11.5	11.7	10.6	3.5	3.2	0.33	0.30
2	10.4	11.8	12.1	11.1	3.3	3.1	0.30	0.28
3	10.2	11.2	11.3	10.5	4.1	4.2	0.39	0.40
4	10.1	11.1	11.4	10.9	3.3	3.4	0.31	0.31
5	10.2	11.5	11.6	11.4	3.4	3.0	0.30	0.26
6	10.0	10.9	11.1	10.5	3.3	4.4	0.32	0.42
7	10.3	11.3	11.7	10.8	3.6	4.1	0.33	0.38
8	10.3	10.8	10.9	10.8	3.8	4.1	0.35	0.38
9	10.3	11.2	11.5	10.8	3.9	4.1	0.36	0.38
10	10.1	10.8	11.3	10.7	3.3	4.1	0.31	0.38
11	10.8	11.6	12.0	11.0	4.0	4.3	0.37	0.39
12	10.6	11.2	11.6	11.0	3.3	3.3	0.30	0.30
13	10.3	11.0	11.3	10.7	3.4	4.0	0.31	0.37
14	10.5	11.2	11.6	11.0	3.0	3.6	0.27	0.33
15	10.5	11.7	11.9	11.0	4.7	4.7	0.43	0.43
16	10.2	10.7	11.0	10.8	3.6	3.7	0.34	0.34
17	10.6	12.0	12.2	10.2	5.1	4.3	0.50	0.42
18	10.1	10.9	11.2	10.9	3.7	3.8	0.34	0.35
19	9.9	11.1	11.5	10.3	3.6	3.9	0.35	0.38
20	10.2	10.8	11.1	10.8	3.9	4.2	0.36	0.39
21	10.5	11.3	11.7	11.1	4.0	4.2	0.36	0.37
22	10.3	11.3	11.4	11.0	3.3	3.6	0.30	0.33
23	9.9	10.8	11.1	10.6	3.5	3.4	0.33	0.32
24	10.1	11.1	11.2	10.8	4.0	4.2	0.37	0.38
25	10.2	11.2	11.4	11.0	4.0	4.5	0.37	0.41
26	10.2	10.7	11.0	10.8	3.7	4.0	0.34	0.37
27	10.5	11.3	11.4	11.2	3.5	4.0	0.31	0.36
28	10.3	11.1	11.4	10.8	4.0	4.0	0.37	0.37
29	10.3	10.9	11.1	10.4	3.6	3.6	0.34	0.35
30	10.3	11.0	11.5	10.7	3.7	3.4	0.35	0.32
31	10.5	11.1	11.3	11.1	3.8	4.2	0.34	0.38
32	10.6	11.1	11.4	10.8	3.7	4.3	0.35	0.40
33	10.7	11.2	11.4	11.0	4.0	4.2	0.36	0.38
34	10.6	11.2	11.6	11.3	3.8	3.9	0.33	0.34
35	10.8	11.2	11.5	11.0	3.4	3.7	0.31	0.33
36	10.4	10.9	11.2	10.7	3.7	3.9	0.35	0.36
37	10.6	11.2	11.5	10.8	3.7	4.3	0.34	0.39
38	10.8	10.9	11.2	11.2	4.1	4.4	0.36	0.40
39	10.7	10.9	11.3	11.1	3.8	3.7	0.35	0.34
40	10.6	10.8	11.2	10.6	4.0	4.0	0.37	0.38
41	10.7	11.5	11.8	10.9	3.9	4.6	0.36	0.42
42	10.5	10.8	11.1	10.7	3.8	4.2	0.35	0.40
43	10.8	11.7	11.9	11.4	4.8	5.1	0.42	0.45
44	10.5	10.7	10.7	10.5	3.9	3.9	0.37	0.37
45	10.8	12.0	12.3	11.2	5.6	5.1	0.50	0.46
AVERAGES	10.4	11.2	11.4	10.9	3.8	4.0	0.35	0.37

Table 4

Measured Wave Data; Plan A; Monochromatic Wave AttackSWL = +7.5 ft; Prototype Wave Period = 9.0 sec

Run Number	H _{avg} , ft						C _t 5/4	C _t 6/4
	Gage 1	Gage 2	Gage 3	Gage 4	Gage 5	Gage 6		
1	9.3	11.1	12.1	10.0	4.5	4.8	0.45	0.48
2	8.9	11.0	11.8	9.6	4.5	5.0	0.47	0.52
3	9.5	11.4	12.4	10.3	4.6	4.8	0.45	0.47
4	9.5	11.5	12.3	10.3	4.9	5.2	0.48	0.50
5	9.6	11.3	12.4	10.1	4.8	5.3	0.48	0.53
6	9.6	11.7	13.1	11.0	4.7	4.5	0.43	0.41
7	9.5	11.1	11.8	9.7	5.1	5.4	0.53	0.56
8	9.4	12.1	13.4	11.2	5.1	4.6	0.46	0.41
9	9.5	11.2	11.9	9.7	5.1	5.5	0.52	0.56
10	9.8	12.4	13.9	11.7	5.1	4.6	0.43	0.40
11	9.4	10.9	11.7	9.6	4.9	5.5	0.51	0.57
12	10.0	11.7	13.0	11.2	4.8	5.0	0.43	0.44
13	9.8	11.6	12.4	10.3	4.5	5.1	0.44	0.50
14	9.9	11.6	12.6	10.5	5.0	5.5	0.48	0.53
15	10.1	12.2	13.6	11.6	5.2	4.6	0.45	0.39
16	9.5	11.2	12.0	9.8	5.0	5.5	0.51	0.56
17	9.8	11.7	13.1	11.0	4.8	4.8	0.44	0.43
18	10.3	11.9	12.9	10.8	5.1	5.4	0.47	0.50
19	10.4	11.9	13.0	11.0	5.0	5.5	0.45	0.50
20	10.6	12.1	13.1	11.0	5.6	5.9	0.51	0.54
21	10.3	12.0	13.0	11.0	5.0	5.2	0.45	0.48
22	10.5	12.1	13.0	10.9	5.3	5.7	0.48	0.52
23	10.6	12.1	13.1	11.1	4.8	5.5	0.44	0.49
24	10.6	12.5	13.8	12.0	5.2	5.0	0.44	0.41
25	10.8	12.0	13.0	11.2	5.3	5.9	0.47	0.53
26	10.7	12.4	13.7	12.0	5.4	5.3	0.45	0.44
27	10.2	11.8	12.8	10.7	5.1	5.4	0.47	0.50
28	10.7	12.2	13.6	11.7	5.1	5.7	0.44	0.48
29	10.6	12.1	13.3	11.5	5.1	5.4	0.45	0.47
30	10.9	12.3	13.4	11.4	5.1	5.8	0.44	0.51
31	10.8	12.2	13.5	11.5	5.2	5.2	0.45	0.45
32	10.9	12.3	13.3	11.3	5.5	5.9	0.48	0.52
33	10.5	12.1	13.2	11.1	5.0	5.1	0.45	0.46
34	10.5	12.0	13.3	11.1	5.0	5.5	0.45	0.50
35	10.1	11.7	12.6	11.0	5.0	5.5	0.46	0.50
36	10.1	11.6	12.4	10.5	5.3	5.9	0.51	0.56
37	9.9	11.7	12.6	10.9	5.0	5.4	0.45	0.50
38	10.2	11.6	12.8	10.8	5.1	5.6	0.47	0.52
39	10.5	12.1	13.0	11.4	4.9	5.0	0.43	0.44
40	10.6	12.3	13.1	11.3	5.0	5.0	0.44	0.44
41	10.6	12.1	12.9	11.0	5.1	5.7	0.46	0.52
42	10.6	12.5	13.8	12.2	5.6	5.2	0.46	0.43
43	10.4	12.0	12.8	11.1	5.1	5.5	0.46	0.50
44	10.5	12.1	13.3	11.7	5.1	4.9	0.44	0.42
45	9.9	11.8	12.5	10.5	5.0	5.1	0.47	0.48
AVERAGES	10.1	11.8	12.9	10.9	5.0	5.3	0.46	0.49

Table 5

Measured Wave Data; Plan A; Monochromatic Wave AttackSWL = +1.9 ft; Prototype Wave Period = 7.0 sec

Run Number	H_{avg} , ft						C_t 5/4	C_t 6/4
	Gage 1	Gage 2	Gage 3	Gage 4	Gage 5	Gage 6		
1	5.6	6.2	7.6	6.5	1.9	1.4	0.29	0.22
2	5.5	6.2	6.9	6.3	2.5	2.4	0.40	0.38
3	5.6	6.2	6.9	6.2	1.8	1.9	0.29	0.30
4	5.7	6.5	7.7	7.3	2.2	2.7	0.30	0.36
5	5.5	6.1	6.9	6.3	2.4	2.3	0.38	0.37
6	5.7	6.3	6.9	6.3	2.1	1.9	0.33	0.31
AVERAGES	5.6	6.2	7.1	6.5	2.2	2.1	0.33	0.32

Table 6

Measured Wave Data; Plan A; Irregular Wave AttackSWL = +7.5 ft; Peak Period = 9.0 sec (Prototype)

Run Number	H_{mo} , ft						C_t 5/4	C_t 6/4
	Gage 1	Gage 2	Gage 3	Gage 4	Gage 5	Gage 6		
1	13.4	10.7	10.9	10.5	5.4	5.6	0.51	0.53
2	13.5	10.4	10.6	10.3	5.4	5.6	0.52	0.54
3	13.6	10.7	10.7	10.4	5.5	5.7	0.53	0.55
AVG	13.5	10.6	10.7	10.4	5.4	5.6	0.52	0.54

Note: Runs 1-3 were performed at 100% gain setting; duration of each run was equal to 30 min model time (2.4 hr prototype).

Table 7

Measured Wave Data; Plan B; Monochromatic Wave AttackSWL = +7.5 ft; Prototype Wave Period = 7.0 sec

Run Number	H_{avg} , ft						C_t 5/4	C_t 6/4
	Gage 1	Gage 2	Gage 3	Gage 4	Gage 5	Gage 6		
1	10.3	11.4	11.8	9.8	4.2	4.1	0.43	0.42
2	10.7	11.8	12.6	10.5	4.0	4.1	0.38	0.39
3	10.3	11.3	12.1	10.6	4.6	4.6	0.44	0.43
4	10.4	11.2	11.9	10.4	4.3	4.6	0.42	0.44
5	10.4	11.4	12.5	10.3	4.3	5.1	0.41	0.49
6	10.2	10.9	11.7	10.4	4.1	4.9	0.39	0.47
7	10.0	11.2	12.0	10.4	4.4	4.6	0.43	0.44
8	10.5	11.8	12.6	10.8	5.5	5.4	0.52	0.50
9	10.4	11.2	11.7	11.0	4.2	5.0	0.38	0.46
10	10.5	11.9	12.5	11.2	4.7	5.0	0.42	0.45
11	10.1	10.7	11.1	10.3	4.2	4.2	0.40	0.41
12	10.7	11.3	12.6	10.9	5.8	5.3	0.53	0.49
13	10.2	9.6	10.5	9.3	4.1	4.4	0.44	0.48
14	10.0	11.4	12.1	10.5	5.4	5.1	0.51	0.49
15	10.3	10.6	11.3	10.2	4.0	3.8	0.39	0.38
AVERAGES	10.3	11.2	11.9	10.4	4.5	4.7	0.43	0.45

Table 8

Measured Wave Data; Plan B; Monochromatic Wave AttackSWL = +7.5 ft; Prototype Wave Period = 9.0 sec

Run Number	H_{avg} , ft						C_t 5/4	C_t 6/4
	Gage 1	Gage 2	Gage 3	Gage 4	Gage 5	Gage 6		
1	10.7	11.9	13.1	11.7	5.0	5.3	0.42	0.45
2	10.5	12.2	13.7	11.9	4.8	4.7	0.40	0.40
3	10.8	11.9	12.9	11.4	4.7	5.1	0.41	0.45
4	10.8	11.8	12.8	11.6	4.9	4.8	0.42	0.41
5	10.5	12.3	13.6	12.0	4.8	4.7	0.40	0.39
6	10.8	12.0	12.8	11.4	4.8	5.5	0.42	0.48
7	10.8	12.3	13.6	12.4	5.0	4.9	0.40	0.40
8	10.7	12.0	13.0	11.3	5.0	5.1	0.44	0.45
9	10.8	12.1	13.1	11.5	5.0	5.2	0.43	0.46
10	10.6	11.8	12.8	11.4	4.8	5.1	0.42	0.45
AVERAGES	10.7	12.0	13.1	11.7	4.9	5.1	0.42	0.43

Table 9

Measured Wave Data; Plan C; Monochromatic Wave Attack

SWL = +7.5 ft; Prototype Wave Period = 7.0 sec

Run Number	H_{avg} , ft						C_t 5/4	C_t 6/4
	Gage 1	Gage 2	Gage 3	Gage 4	Gage 5	Gage 6		
1	11.0	11.6	12.2	11.0	4.2	4.3	0.38	0.39
2	10.9	11.1	12.3	10.6	4.2	4.0	0.40	0.38
3	11.2	11.6	12.4	10.8	4.4	3.9	0.41	0.36
4	11.2	11.7	12.6	11.0	4.1	4.4	0.38	0.40
5	10.8	11.1	11.9	9.4	5.6	5.7	0.59	0.60
6	11.2	11.2	12.4	10.6	3.8	3.6	0.36	0.34
7	11.2	11.7	13.0	10.6	5.2	5.2	0.49	0.49
8	11.0	11.0	12.0	10.8	4.1	3.3	0.38	0.31
9	10.5	10.7	11.9	10.2	4.3	4.7	0.42	0.46
10	10.7	11.0	11.7	9.4	3.9	4.4	0.41	0.46
11	10.9	11.3	12.6	10.3	4.2	3.8	0.41	0.37
12	10.8	11.0	12.1	10.7	3.8	4.1	0.36	0.38
13	11.2	11.5	12.3	11.1	4.9	4.3	0.44	0.39
14	11.1	11.7	12.4	10.5	4.0	4.3	0.38	0.41
15	10.9	11.6	12.5	10.3	3.8	4.5	0.36	0.43
16	10.8	11.2	12.3	10.7	4.1	4.7	0.39	0.44
17	10.8	11.4	12.0	9.9	4.2	4.6	0.43	0.47
18	11.3	11.1	12.5	10.9	4.0	5.4	0.37	0.50
19	11.0	11.7	12.6	10.6	4.7	4.6	0.44	0.44
20	11.3	11.6	12.3	10.4	4.0	4.4	0.39	0.42
21	11.1	11.5	12.5	10.5	4.4	3.7	0.42	0.36
22	10.9	11.7	12.3	10.5	4.1	4.6	0.39	0.44
23	11.2	11.1	11.7	10.5	4.3	4.8	0.41	0.45
24	11.0	12.1	12.6	10.0	6.0	4.7	0.60	0.47
25	11.3	10.5	12.0	10.7	4.2	3.8	0.39	0.36
26	10.9	11.6	12.4	10.3	4.3	4.3	0.41	0.41
27	10.9	11.2	12.4	10.7	4.2	4.6	0.39	0.43
28	11.3	11.2	12.3	10.6	3.6	4.1	0.34	0.39
29	11.2	11.9	12.5	11.0	4.8	4.5	0.43	0.41
30	11.0	11.6	12.7	10.9	4.6	4.4	0.43	0.41
AVERAGES	11.0	11.4	12.3	10.5	4.3	4.4	0.41	0.42

Table 10

Measured Wave Data; Plan C; Monochromatic Wave AttackSWL = +7.5 ft; Prototype Wave Period = 9.0 sec

Run Number	H_{avg} , ft						C_t 5/4	C_t 6/4
	Gage 1	Gage 2	Gage 3	Gage 4	Gage 5	Gage 6		
1	9.0	10.3	11.5	10.0	4.8	4.7	0.49	0.47
2	9.2	10.5	11.7	10.4	4.8	4.6	0.46	0.44
3	9.3	10.5	11.6	10.3	4.7	4.7	0.46	0.45
4	9.3	10.7	11.9	11.1	5.0	4.6	0.45	0.42
5	9.0	10.3	11.4	10.4	4.9	4.6	0.48	0.45
6	9.1	10.1	11.1	9.7	4.6	4.9	0.48	0.50
7	9.2	10.3	11.2	10.1	4.7	5.0	0.47	0.50
8	9.3	10.8	11.9	10.9	4.9	4.4	0.45	0.41
9	9.1	10.2	11.1	9.8	4.7	4.7	0.48	0.48
10	8.8	10.4	11.6	10.4	4.9	4.5	0.47	0.43
11	8.9	10.3	11.3	10.0	4.7	4.6	0.47	0.46
12	8.9	10.0	11.1	9.9	4.5	4.6	0.45	0.46
13	9.1	10.7	11.8	10.9	4.7	4.1	0.43	0.37
14	8.9	10.2	10.8	9.5	4.8	5.0	0.50	0.53
15	9.2	10.4	11.0	10.2	5.0	5.3	0.49	0.52
16	9.1	10.4	11.6	10.3	4.7	4.7	0.46	0.46
17	8.9	10.2	11.0	9.7	4.7	4.9	0.48	0.50
18	8.9	10.4	11.4	10.5	4.8	4.7	0.45	0.44
19	9.1	10.1	11.0	10.0	4.8	4.8	0.48	0.48
20	9.2	10.8	12.1	11.0	4.8	4.3	0.44	0.39
21	9.1	10.4	11.3	10.0	4.8	4.8	0.48	0.48
22	9.4	10.3	11.0	10.1	5.0	5.4	0.49	0.54
23	9.3	10.7	12.0	10.8	4.6	4.5	0.43	0.42
24	9.4	10.3	11.3	10.3	4.7	5.0	0.46	0.49
25	8.8	10.5	11.7	10.5	4.6	3.8	0.44	0.36
26	9.0	10.2	10.9	9.7	4.4	5.0	0.45	0.51
28	9.1	10.4	11.3	10.1	4.8	5.0	0.48	0.50
29	9.0	10.5	11.5	10.4	4.8	4.8	0.46	0.46
30	9.2	10.3	11.4	10.4	4.9	5.0	0.47	0.48
AVERAGES	9.1	10.4	11.4	10.3	4.8	4.7	0.46	0.46

Table 11

Measured Wave Data; Plan C; Monochromatic Wave AttackSWL = +1.9 ft; Prototype Wave Period = 7.0 sec

Run Number	H_{avg} , ft						C_t 5/4	C_t 6/4
	Gage 1	Gage 2	Gage 3	Gage 4	Gage 5	Gage 6		
1	5.8	6.8	6.7	6.9	2.0	2.2	0.29	0.32
2	6.0	6.6	6.6	6.8	2.0	2.4	0.30	0.34
3	6.1	6.6	6.5	6.7	2.2	2.4	0.32	0.36
4	6.0	6.9	7.0	6.9	2.3	2.4	0.34	0.35
5	6.2	7.2	7.4	7.7	2.2	2.3	0.28	0.30
6	6.2	6.9	6.9	6.9	2.2	2.4	0.31	0.35
7	6.1	6.6	6.6	6.7	2.4	2.4	0.36	0.36
8	6.3	7.0	7.1	7.0	2.6	2.7	0.37	0.39
9	6.2	6.9	7.5	7.5	2.5	2.6	0.34	0.34
10	6.1	6.8	7.2	7.0	2.2	2.3	0.32	0.33
11	6.2	6.7	6.7	7.0	2.3	2.4	0.33	0.33
12	6.2	6.6	6.7	6.8	2.4	2.6	0.35	0.38
13	6.1	7.0	7.3	7.7	2.3	2.4	0.30	0.31
14	6.1	6.7	6.7	6.7	2.3	2.5	0.35	0.38
15	6.0	6.9	7.1	7.2	2.7	2.7	0.37	0.38
AVERAGES	6.1	6.8	6.9	7.0	2.3	2.4	0.33	0.35

Table 12

Measured Wave Data; Plan C; Monochromatic Wave AttackSWL = +1.9 ft; Prototype Wave Period = 9.0 sec

Run Number	H_{avg} , ft						C_t 5/4	C_t 6/4
	Gage 1	Gage 2	Gage 3	Gage 4	Gage 5	Gage 6		
1	5.9	6.8	7.2	8.5	2.5	2.0	0.30	0.24
2	5.8	7.1	7.2	8.3	2.4	2.2	0.29	0.26
3	5.6	6.2	6.9	7.1	2.5	2.1	0.35	0.30
4	5.5	6.4	6.8	7.5	2.7	2.4	0.36	0.32
5	5.6	6.5	6.9	7.7	2.4	2.1	0.31	0.28
6	5.5	6.4	6.8	7.5	2.5	2.0	0.34	0.27
7	5.5	6.3	6.8	7.4	2.5	2.1	0.33	0.28
8	5.7	6.5	7.0	7.5	2.6	2.4	0.34	0.32
9	5.6	6.6	7.0	7.5	2.5	2.4	0.33	0.33
10	5.5	6.7	7.0	7.9	2.4	2.4	0.30	0.31
11	5.5	6.5	6.8	7.5	2.5	2.1	0.34	0.28
12	5.3	6.2	6.6	7.2	2.5	2.2	0.34	0.30
13	5.7	6.4	6.9	7.7	2.5	2.2	0.33	0.29
14	5.4	6.3	6.9	7.4	2.4	2.1	0.32	0.28
15	5.4	6.3	6.8	7.2	2.5	2.2	0.35	0.31
16	5.5	6.5	6.9	7.7	2.6	2.2	0.33	0.28
17	5.5	6.6	7.1	7.8	2.5	2.3	0.32	0.29
18	5.7	6.5	7.0	7.9	2.6	2.2	0.33	0.28
19	5.5	6.4	6.9	7.7	2.6	2.2	0.34	0.29
20	5.7	6.6	7.0	7.9	2.5	2.4	0.32	0.30
21	5.6	6.4	6.9	7.7	2.5	2.2	0.32	0.28
22	5.7	6.4	6.9	7.8	2.5	2.1	0.32	0.27
AVERAGES	5.6	6.5	6.9	7.7	2.5	2.2	0.33	0.29

Table 13

Measured Wave Data; Plan C; Irregular Wave AttackSWL = +7.5 ft; Peak Period = 9.0 sec (Prototype)

Run Number	H _{mo} , ft						C _t 5/4	C _t 6/4
	Gage 1	Gage 2	Gage 3	Gage 4	Gage 5	Gage 6		
1	12.2	10.2	10.4	10.2	4.9	5.0	0.48	0.49
2	12.5	10.1	10.3	10.1	5.0	5.1	0.50	0.50
3	12.7	10.3	10.4	10.3	5.0	5.1	0.49	0.50
-----	-----	-----	-----	-----	-----	-----	-----	-----
AVG	12.5	10.2	10.4	10.2	5.0	5.1	0.49	0.50

Note: Runs 1-3 were performed at 100% gain setting; duration of each run was equal to 30 min model time (2.4 hr prototype).

Table 14

Measured Wave Data; Plan C; Irregular Wave AttackSWL = +1.9 ft; Peak Period = 9.0 sec (Prototype)

Run Number	H _{mo} , ft						C _t 5/4	C _t 6/4
	Gage 1	Gage 2	Gage 3	Gage 4	Gage 5	Gage 6		
1	9.6	7.8	7.9	7.8	2.9	3.0	0.37	0.38
2	----- no data -----						-----	-----
3	----- no data -----						-----	-----
-----	-----	-----	-----	-----	-----	-----	-----	-----
AVG	9.6	7.8	7.9	7.8	2.9	3.0	0.37	0.38

Note: Runs 1-3 were performed at 100% gain setting; duration of each run was equal to 30 min model time (2.4 hr prototype).

Table 15

Measured Wave Data; Wave Transmission Tests; Plan CMonochromatic Wave Attack; SWL = +7.5 ftPeriod = 7.0 sec

Run Number	H _{avg} , ft						C _t 5/4	C _t 6/4
	Gage 1	Gage 2	Gage 3	Gage 4	Gage 5	Gage 6		
1	6.5	6.2	8.2	5.5	3.1	3.1	0.57	0.56
2	7.8	8.9	9.2	8.0	3.3	3.1	0.41	0.40
3	16.1	9.0	9.4	9.0	3.6	3.6	0.40	0.40
4	10.5	12.6	13.0	10.4	3.1	2.9	0.30	0.27
5	11.1	12.3	12.5	10.7	4.0	4.3	0.37	0.40
AVERAGES	10.4	9.8	10.5	8.7	3.4	3.4	0.41	0.41

Table 16

Measured Wave Data; Wave Transmission Tests; Plan CMonochromatic Wave Attack; SWL = +7.5 ftPeriod = 9.0 sec

Run Number	H _{avg} , ft						C _t 5/4	C _t 6/4
	Gage 1	Gage 2	Gage 3	Gage 4	Gage 5	Gage 6		
1	6.6	7.5	7.8	5.9	4.3	4.3	0.72	0.73
2	7.5	8.8	9.0	7.2	4.1	4.4	0.57	0.60
3	8.3	9.9	9.9	7.8	4.0	4.3	0.51	0.55
4	9.8	11.8	11.8	9.9	3.9	4.3	0.40	0.44
5	11.0	13.4	13.2	9.7	4.3	4.6	0.45	0.48
AVERAGES	8.6	10.3	10.3	8.1	4.1	4.4	0.53	0.56

Table 17

Measured Wave Data; Wave Transmission Tests; Plan CMonochromatic Wave Attack; SWL = +1.9 ftPeriod = 7.0 sec

Run Number	H _{avg} , ft						C _t 5/4	C _t 6/4
	Gage 1	Gage 2	Gage 3	Gage 4	Gage 5	Gage 6		
1	3.4	3.7	3.2	3.7	1.3	1.5	0.35	0.41
2	4.3	4.7	4.5	4.6	1.3	1.5	0.28	0.33
3	5.1	5.7	6.0	5.8	1.3	1.7	0.23	0.29
4	6.1	6.7	7.3	7.0	1.4	1.7	0.20	0.25
5	6.8	7.5	8.4	7.3	1.3	1.7	0.18	0.23
AVERAGES	5.1	5.7	5.9	5.7	1.3	1.6	0.24	0.30

Table 18

Measured Wave Data; Wave Transmission Tests; Plan CMonochromatic Wave Attack; SWL = +1.9 ftPeriod = 9.0 sec

Run Number	H _{avg} , ft						C _t 5/4	C _t 6/4
	Gage 1	Gage 2	Gage 3	Gage 4	Gage 5	Gage 6		
1	4.2	5.0	4.7	5.0	1.3	1.7	0.26	0.34
2	4.7	5.8	5.6	6.0	1.4	1.9	0.24	0.32
3	5.2	6.4	6.4	6.8	1.4	1.7	0.20	0.25
4	6.1	8.1	7.6	7.8	1.3	1.8	0.16	0.23
5	6.8	8.1	7.6	7.1	1.2	1.4	0.17	0.19
AVERAGES	5.4	6.7	6.4	6.5	1.3	1.7	0.21	0.27

Table 19

Measured Wave Data; Wave Transmission Tests; Plan CIrregular Wave Attack; SWL = +7.5 ftPeak Period = 9.0 sec

<u>Gain</u> <u>Percent</u>	<u>H_{mo}, ft</u>						<u>C_t</u> <u>5/4</u>	<u>C_t</u> <u>6/4</u>
	<u>Gage</u> <u>1</u>	<u>Gage</u> <u>2</u>	<u>Gage</u> <u>3</u>	<u>Gage</u> <u>4</u>	<u>Gage</u> <u>5</u>	<u>Gage</u> <u>6</u>		
100	12.7	10.4	10.6	10.5	4.6	4.9	0.44	0.47
90	11.6	9.9	10.1	9.9	4.4	4.7	0.44	0.47
80	10.6	9.6	9.8	9.5	4.0	4.4	0.42	0.46

Table 20

Measured Wave Data; Wave Transmission Tests; Plan CIrregular Wave Attack; SWL = +1.9 ftPeak Period = 9.0 sec

<u>Gain</u> <u>Percent</u>	<u>H_{mo}, ft</u>						<u>C_t</u> <u>5/4</u>	<u>C_t</u> <u>6/4</u>
	<u>Gage</u> <u>1</u>	<u>Gage</u> <u>2</u>	<u>Gage</u> <u>3</u>	<u>Gage</u> <u>4</u>	<u>Gage</u> <u>5</u>	<u>Gage</u> <u>6</u>		
100	12.0	8.5	8.4	8.2	2.5	2.9	0.30	0.35
90	11.1	8.6	8.6	8.5	2.7	3.0	0.32	0.35
80	10.2	7.8	7.9	8.0	2.6	2.9	0.33	0.36



Photo 1. Lakeside view of Plan A before testing with monochromatic waves

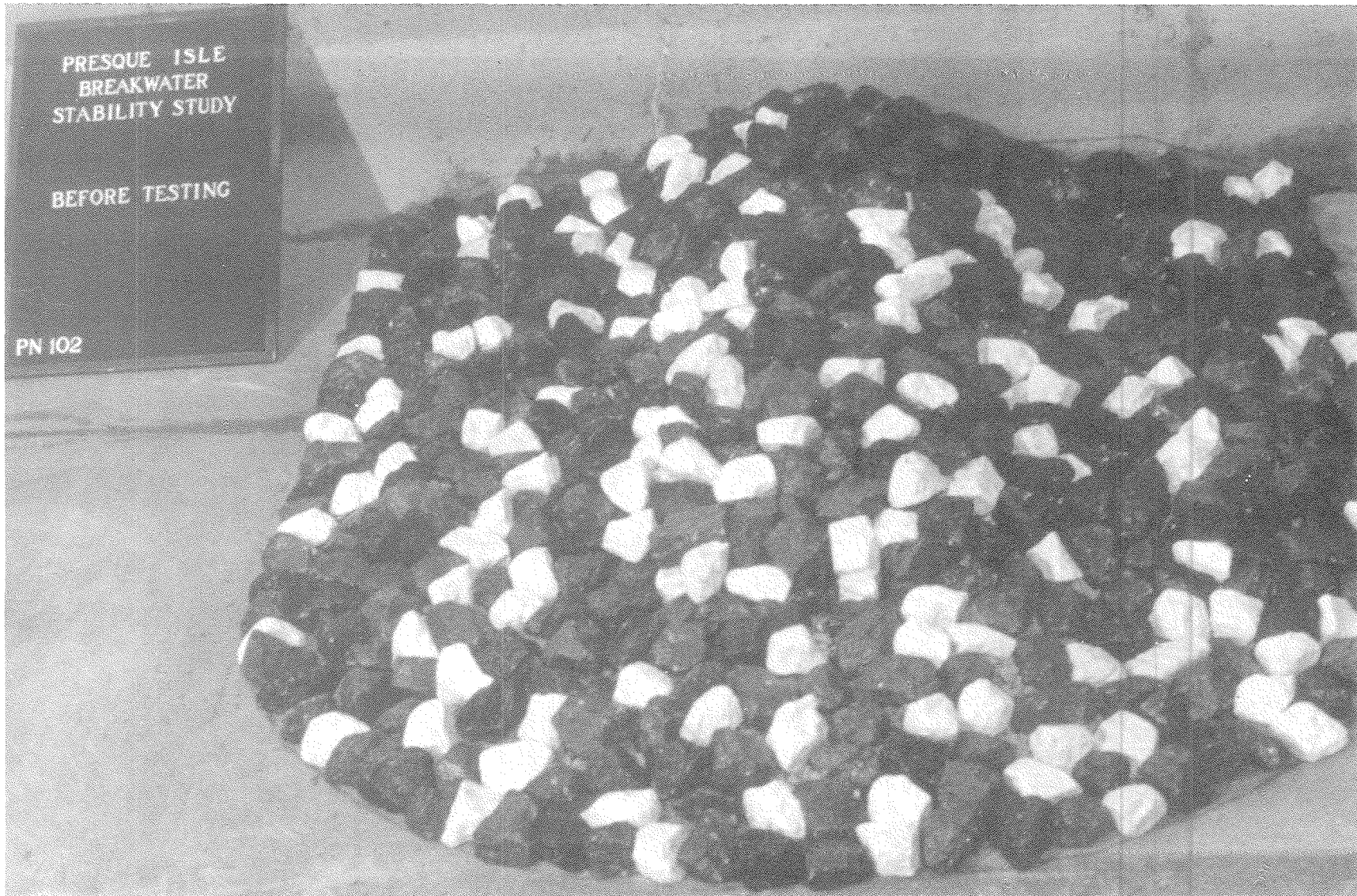

Photo 2. Long axis view of Plan A before testing with monochromatic waves

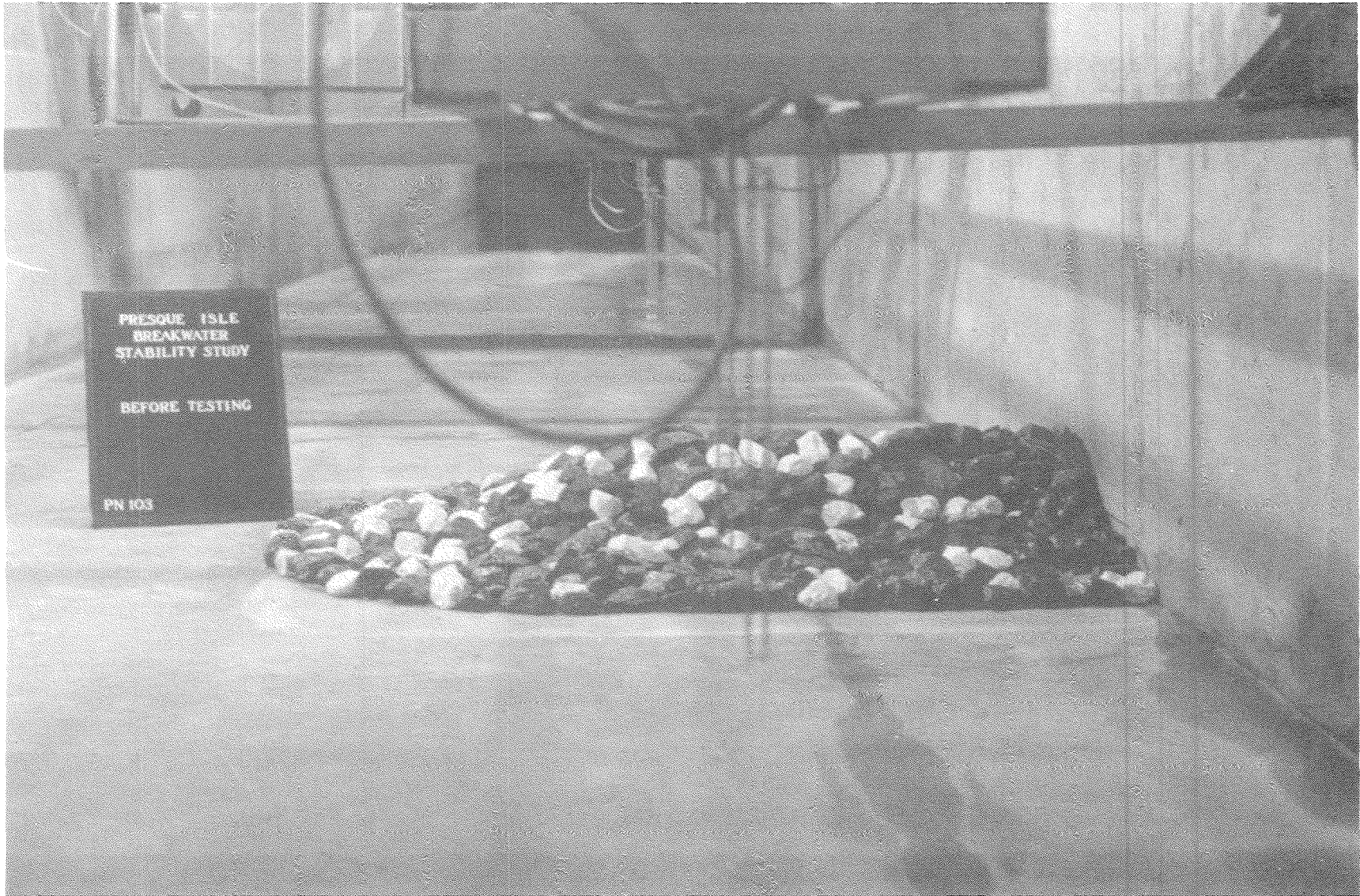

Photo 3. Beachside view of Plan A before testing with monochromatic waves



Photo 4. Lakeside view of Plan A after testing with monochromatic waves

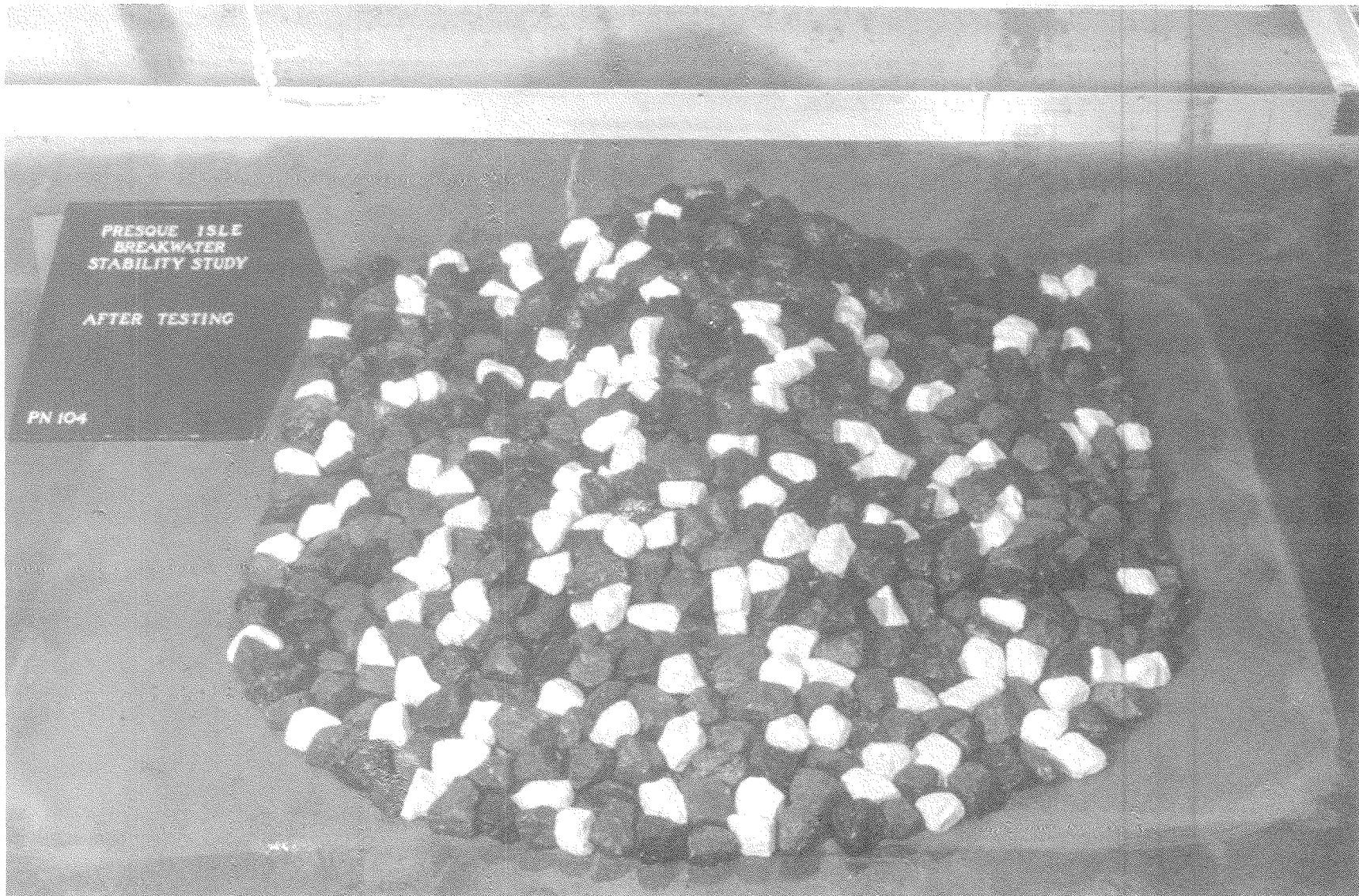

Photo 5. Long axis view of Plan A after testing with monochromatic waves



Photo 6. Beachside view of Plan A after testing with monochromatic waves

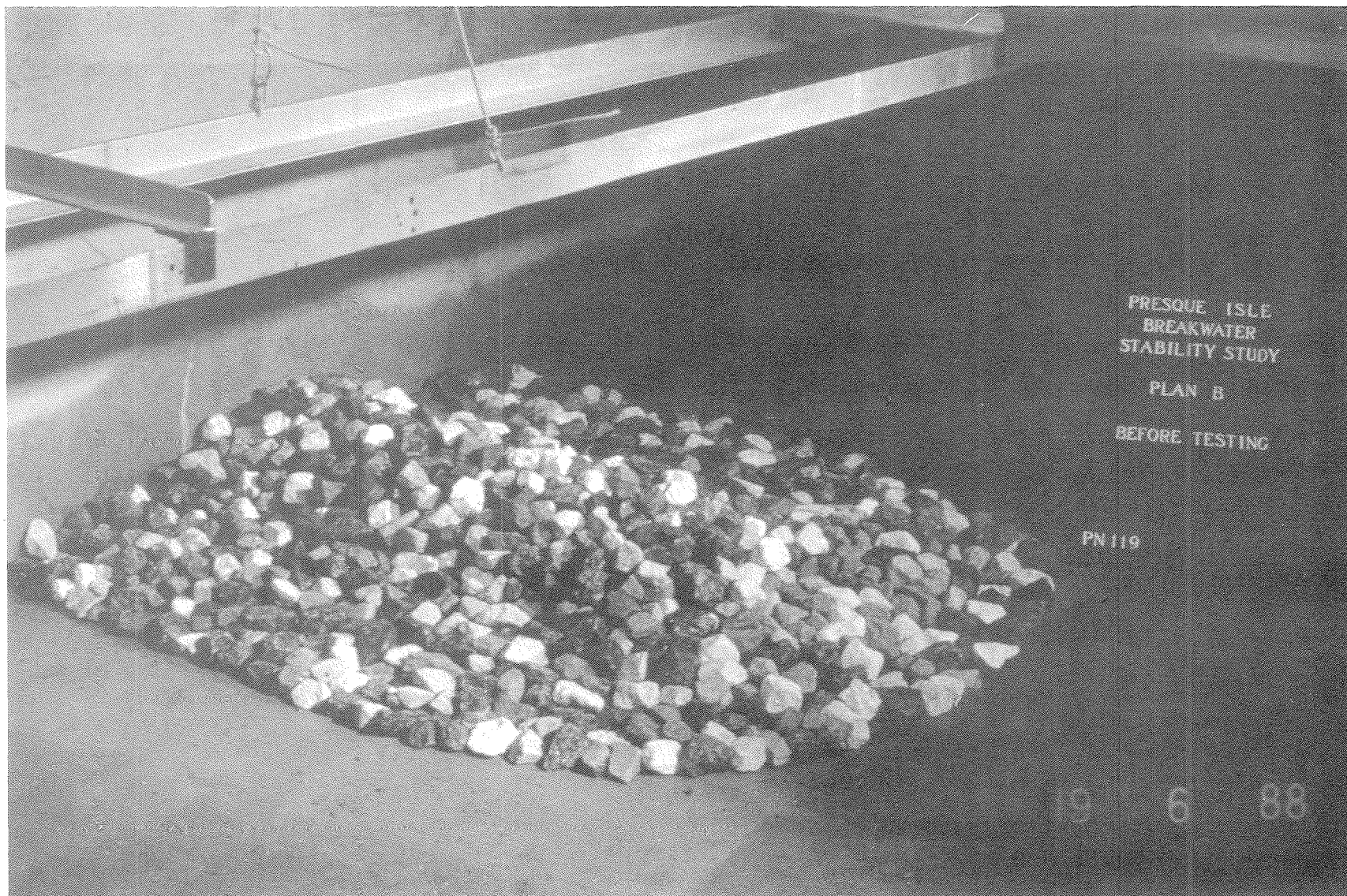

Photo 7. Lakeside view of Plan B before testing with monochromatic waves

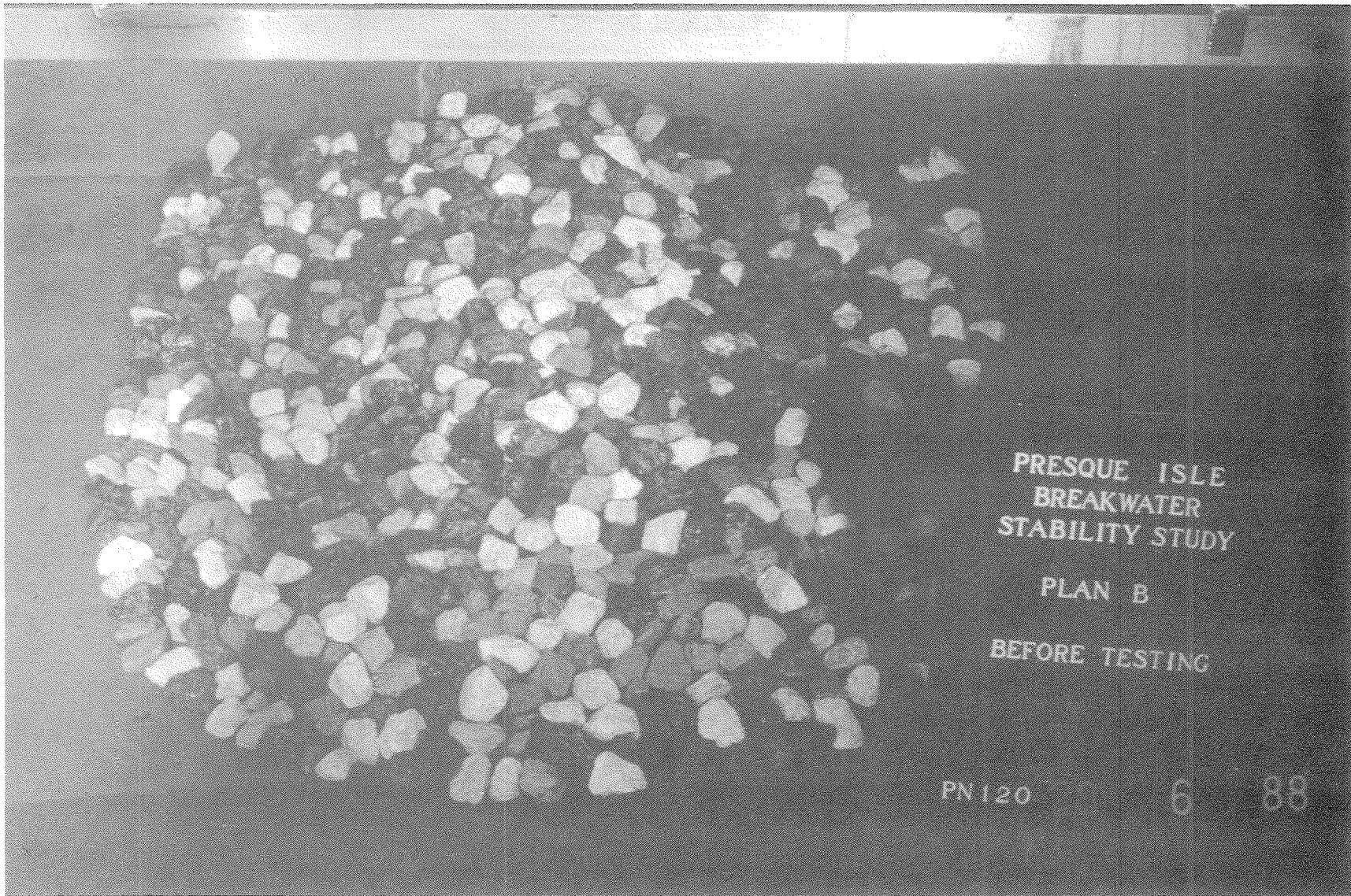

Photo 8. Long axis view of Plan B before testing with monochromatic waves

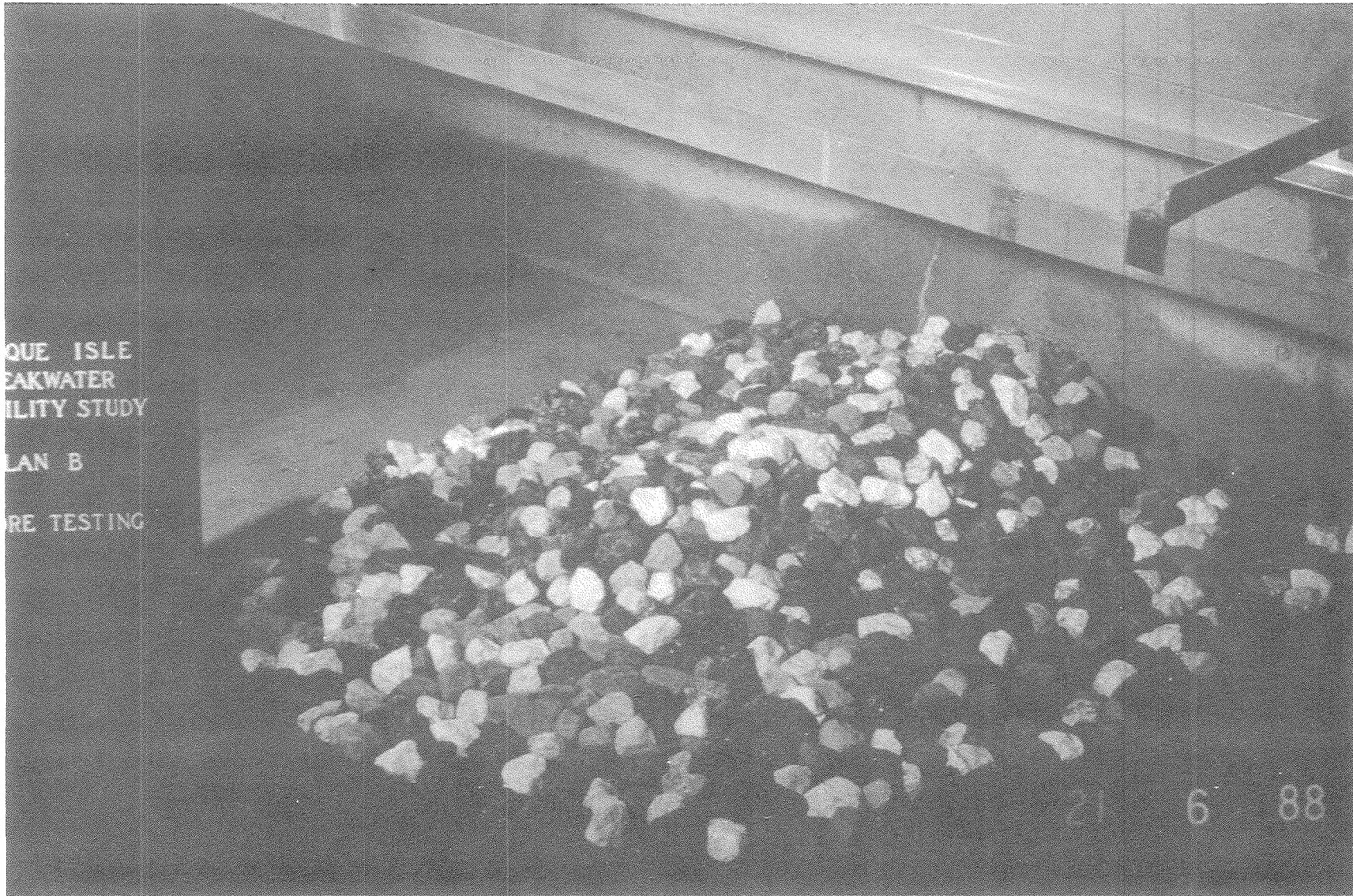

Photo 9. Beachside view of Plan B before testing with monochromatic waves



Photo 10. Lakeside view of Plan B after testing with monochromatic waves



Photo 11. Long axis view of Plan B after testing with monochromatic waves

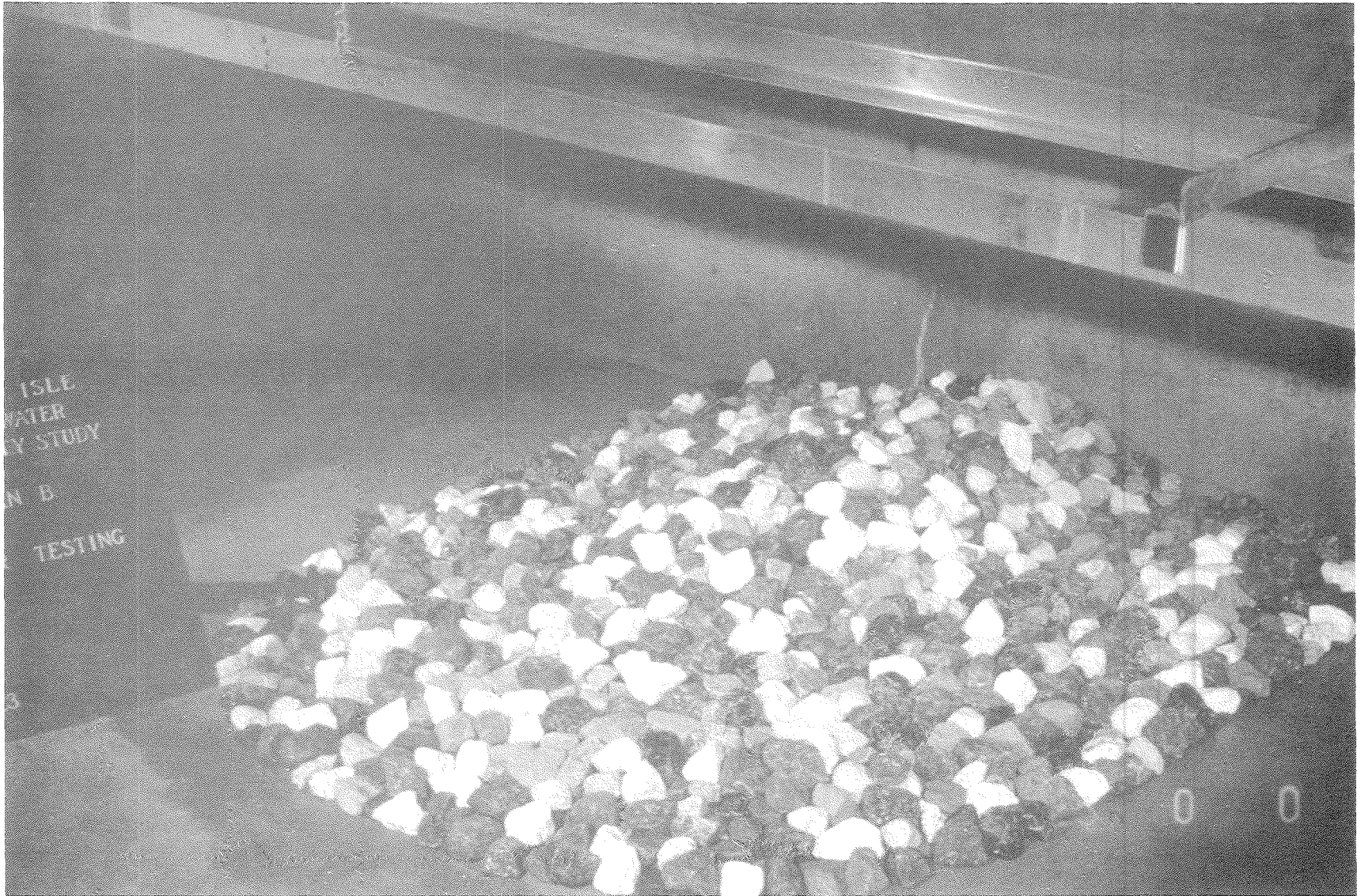

Photo 12. Beachside view of Plan B after testing with monochromatic waves



Photo 13. Lakeside view of Plan C before testing with all wave conditions

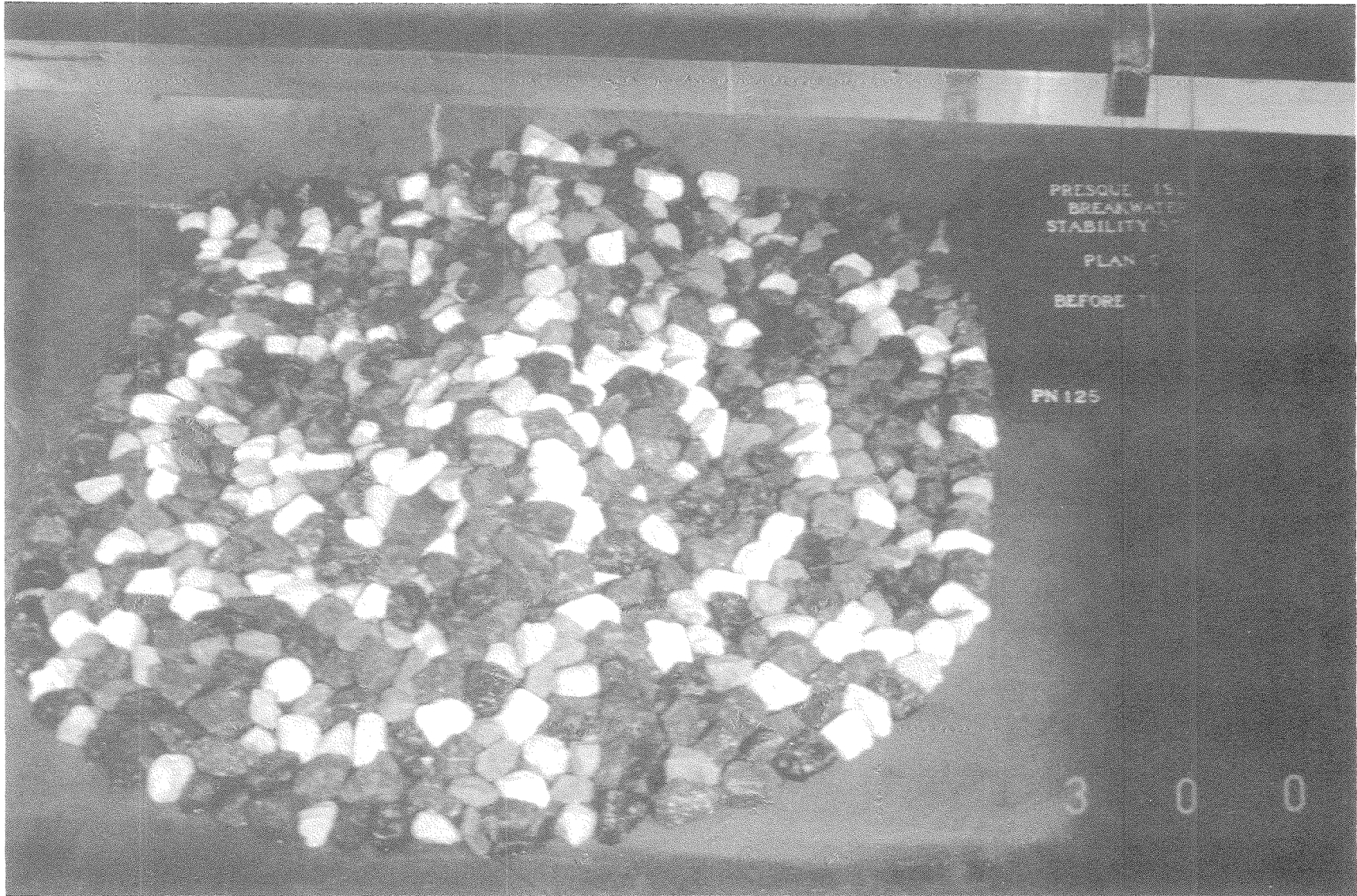

Photo 14. Long axis view of Plan C before testing with all wave conditions

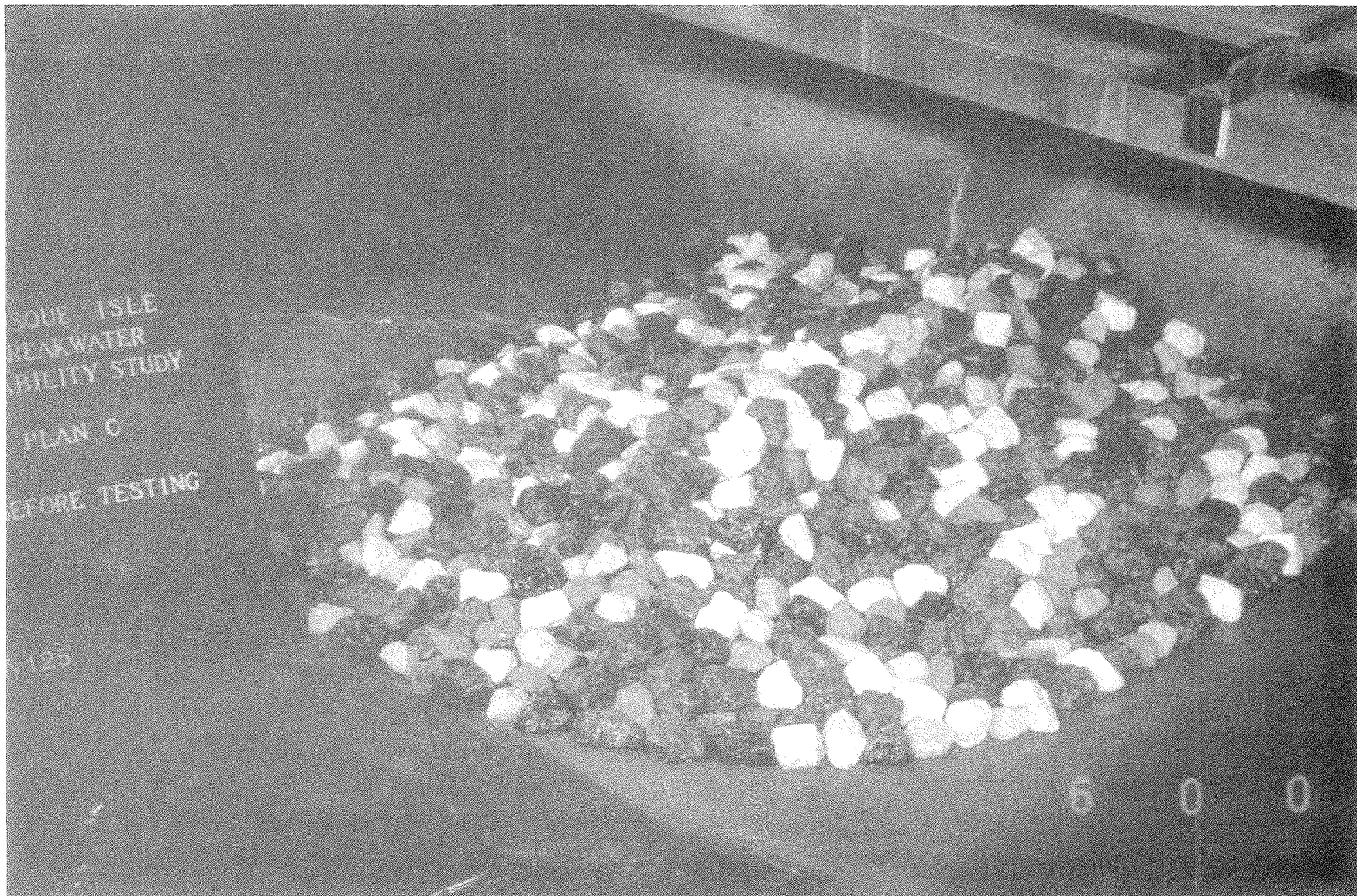

Photo 15. Beachside view of Plan C before testing with all wave conditions

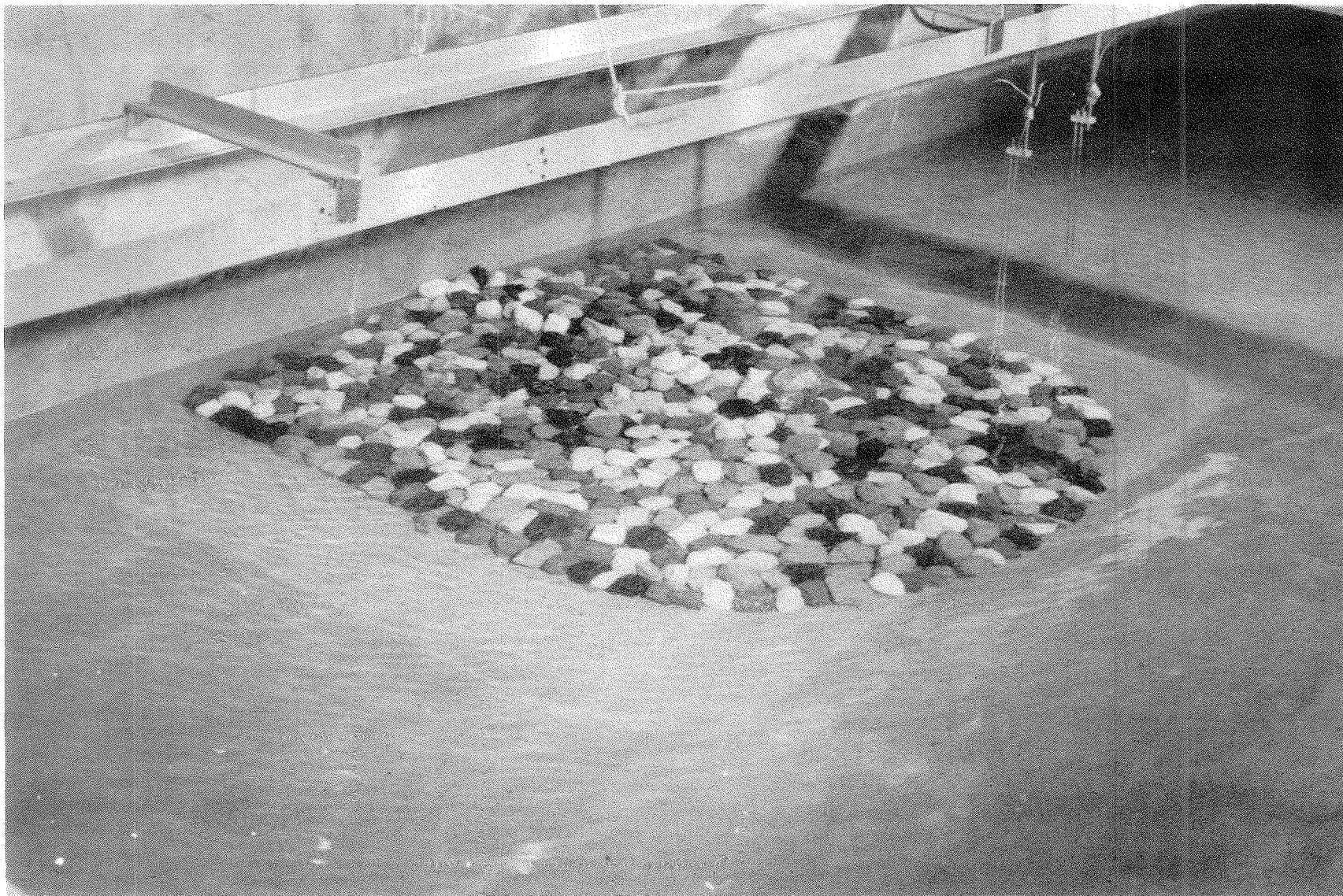

Photo 16. Lakeside view of Plan C after testing



Photo 17. Long axis view of Plan C after testing

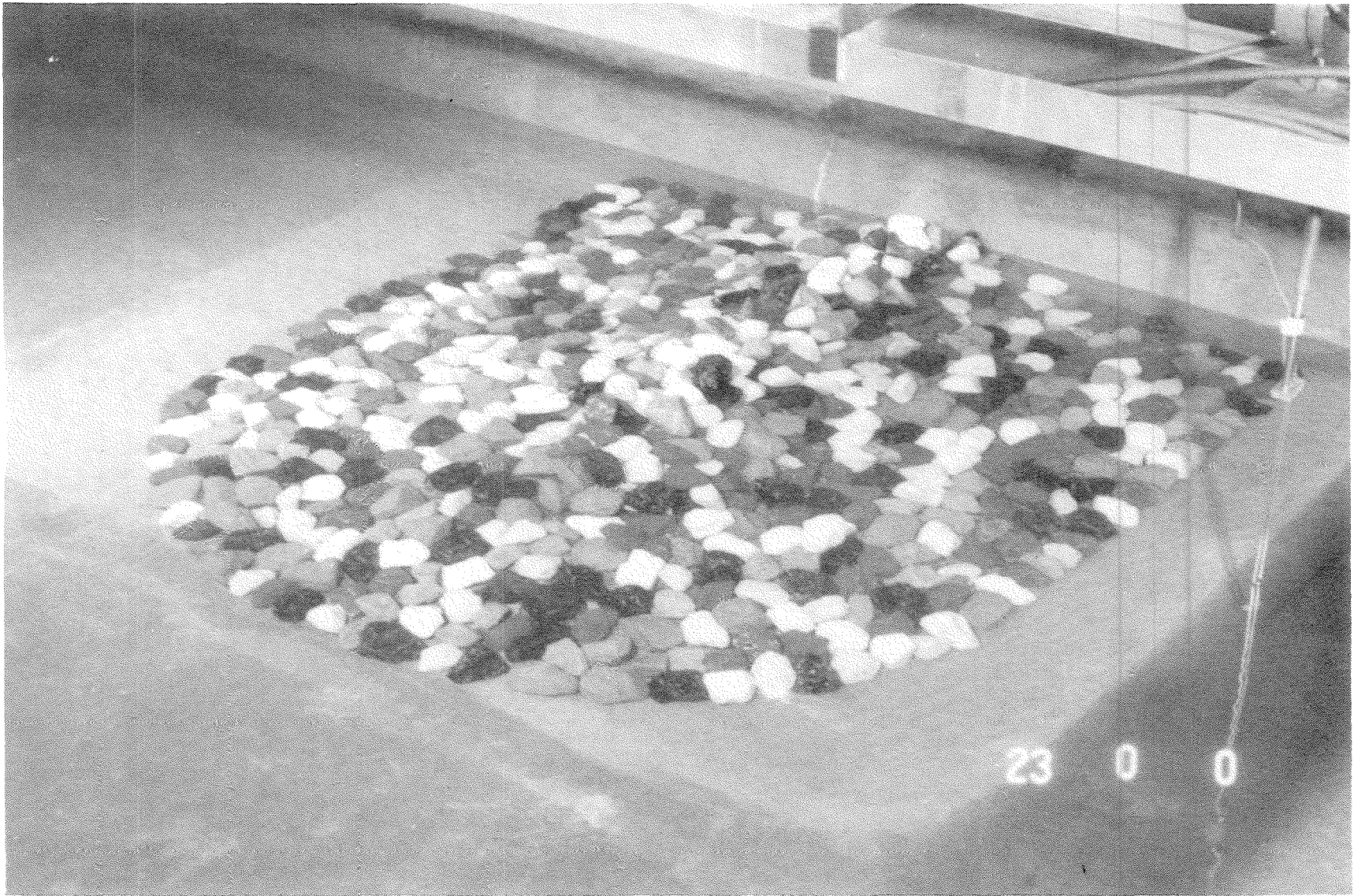

Photo 18. Beachside view of Plan C after testing