

 Open access • Journal Article • DOI:10.1109/TDEI.2004.1266329

Investigation of polarization and depolarization current measurements for the assessment of oil-paper insulation of aged transformers — [Source link](#)

Tapan Kumar Saha, Prithwiraj Purkait

Institutions: University of Queensland

Published on: 19 Feb 2004 - IEEE Transactions on Dielectrics and Electrical Insulation (IEEE)

Topics: Transformer oil, Insulation system, Dielectric withstand test and Transformer

Related papers:

- [Dielectric spectroscopy in time and frequency domain for HV power equipment. I. Theoretical considerations](#)
- [Applications of dielectric spectroscopy in time and frequency domain for HV power equipment](#)
- [Deriving an equivalent circuit of transformers insulation for understanding the dielectric response measurements](#)
- [Review of modern diagnostic techniques for assessing insulation condition in aged transformers](#)
- [Frequency response of oil impregnated pressboard and paper samples for estimating moisture in transformer insulation](#)

Share this paper:    

View more about this paper here: <https://typeset.io/papers/investigation-of-polarization-and-depolarization-current-296m8m887o>

Investigation of Polarization and Depolarization Current Measurements for the Assessment of Oil-paper Insulation of Aged Transformers

T. K. Saha and P. Purkait

School of Information Technology and Electrical Engineering
University of Queensland
St. Lucia, Qld- 4072
Australia

ABSTRACT

Moisture and ageing strongly influence the dielectric properties of oil/paper insulation system of power transformer. Moisture measurement in oil sample generally gives inconclusive information since oil/paper moisture equilibrium is temperature dependent and takes a long time to be in equilibrium. Direct moisture measurement of paper sample is not practicable for in-service transformers. The measurement and evaluation of the “dielectric response” and conductivity is one possible way of diagnosing a transformer insulation condition. In a recent research project, polarization and depolarization current measurement has been used for assessing the condition of oil/paper insulation. The polarization and depolarization current (PDC) analysis is a non-destructive dielectric testing method for determining the conductivity and moisture content of insulation materials in a transformer. On the basis of this analysis it is possible to take further actions like oil-refurbishment, drying or replacement of the winding of the transformer. This paper presents a description of the PDC technique with the physical and mathematical background and some results of PDC measurements on several transformers. Analyses and interpretation of the field test data are also presented in this paper.

Index Terms — Transformer, oil-paper insulation, aging, moisture content, dielectric response, conductivity, polarization current, depolarization current.

1 INTRODUCTION

LARGE numbers of power transformers around the world are approaching towards the end of their design life. They are very expensive to replace; however, some of these transformers are still in good condition and could be used for many more years. Clearly determining their condition would be of tremendous importance to the electricity industry. Well-established time-based maintenance by experienced staff as well as conservative replacement planning is not feasible in the current market oriented electricity industry. Condition based maintenance and online monitoring are gaining importance now. A variety of electrical, mechanical and chemical techniques are currently available for insulation testing of power transformers.

Most of these techniques have been in use for many years, such as the measurement of insulation resistance (IR), dielectric loss factor (DLF), partial discharges (PD),

interfacial polarization (IP) using anomalous IR and frequency dispersion capacitance, oil quality, moisture content, dissolved gas analysis (DGA), viscometric degree of polymerization (DP_v) and tensile strength of cellulosic paper and pressboard [1–3].

For obtaining a more clear and focused information on insulation health, newer diagnostic testing and analytical techniques are investigated in recent times. Over the last 10 years, several sophisticated techniques have been implemented. These include chemical techniques like high performance liquid chromatography (HPLC) for furan analysis [4–5]. Other analytical chemical techniques recently being introduced include various techniques for studying morphology such as X-ray diffraction, Fourier transform infra-red (FTIR) absorption, nuclear magnetic resonance (NMR) [6], scanning electron microscopy and gel permeation chromatography (GPC) for determining molecular weights (MW) and its distributions.

Modern electrical testing techniques include frequency domain measurements [7–8] of dissipation factor, complex

capacitance and permittivity of the transformer insulation. In such measurements a sinusoidal voltage of variable frequency (typically 1 mHz to 1 kHz) is used to get the frequency domain spectra of the permittivity, dissipation factor and complex capacitance of the insulation system. In addition to these, time domain dielectric response measurement techniques like the return voltage measurement (RVM) [9–11] and more recently the polarization and depolarization current (PDC) measurement [12–16] have gained immense popularity as supplements to the existing insulation assessment techniques. These dielectric response measurement techniques, in addition to being simple to perform, can provide adequate relevant information about the condition of the oil/paper insulation in a transformer.

In recent times the authors of this paper have been investigating the PDC measurement for separation of moisture and ageing impacts on transformer insulation degradation. PDC tests have been performed on a number of transformers in substation environment. Tests have been carried out on extremely aged transformers as well as moderately aged transformers to encompass a wide range of test specimens. Field tests were also performed on a transformer before and after oil reclamation to assess the efficiency of the oil reclamation process. These findings and their analyses are reported in this paper. The current research project also includes modeling of dielectric phenomena in composite oil/paper insulation system. Assessments of oil/paper insulation condition based on field test results, supplemented by knowledge acquired through modeling is reported in this paper.

2 DIELECTRIC RESPONSE MEASUREMENTS

Ageing of the oil/paper insulation system of power transformers is influenced by thermal, electromechanical and chemical stresses. Thermal stress leads to a major degradation process for both oil and cellulose paper. Under all these stresses, the paper ultimately becomes brittle and the durability against mechanical stress is strongly reduced. The process of breaking glucose molecule chains in cellulose produces water in the solid insulation, which acts as a catalyst for further breakdown. Further, the breakdown voltage of the insulating oil and paper is reduced with increasing moisture content of the oil. The conductivity of a material is the property, which can be related to the moisture content and different ageing by-products present in the insulation. Thus a knowledge about the conductivity of the oil and the solid insulation material can be used as an important basis for the assessment of the condition of the oil/paper insulation. Further actions like on-site drying, oil reclamations or even complete overhauling may then be decided upon.

There are indirect methods available to estimate moisture content of paper insulation. However, to date paper

ageing and moisture can only be reliably measured by paper samples collected from critical locations (leads, outer winding, etc.) and analyzing in the laboratory. Solid insulation can only be examined directly by opening a transformer and taking samples from the insulation. Obviously, this is not an acceptable method for a non-destructive evaluation of solid insulation. Moisture in oil can be estimated by collecting oil samples from the tank and analyzing by Karl Fischer titration. Then moisture in paper/press-board can be estimated using Oommen's [17] equilibrium curves, provided correct oil temperature at the time of sampling is known. This has severe inaccuracy in lower part of the equilibrium curves. Hence, there is a great demand in using dielectric diagnostic methods to relate to insulation properties. In previous and current research projects, the authors of this paper have extensively used the return voltage method for analyzing the condition of aged oil/paper insulation [1–3], [9–10].

Gafvert et al. [7] reported their findings on polarization/depolarization current measurements to assess the quality of the insulation systems of a number of power transformers. They recommend polarization current measurement as the preferred method since the properties of oil and paper can be separately assessed from the experimental results. The authors explained that return voltage measurement results are convoluted by two constituents and it is difficult to separate the oil and paper impacts. Alff et al. [12], in their paper described the development of a novel type of equipment based on polarization/depolarization current measurements, which is designed for on-site testing of high voltage power apparatus. They presented some examples of on-site measurements on power transformers and demonstrated the interpretation of results. Hassig et al. [13] mentioned the polarization/depolarization current (PDC) method as a user friendly method for assessing the integral condition of the oil/cellulose insulation system of a transformer. Der Houhanessian et al. [14] presented results of polarization depolarization current measurements of pressboard samples at different moisture content and temperature. They also demonstrated how the moisture content of pressboard could be quantified from evaluation of the polarization/depolarization current measurements of power transformers. Leibfried et al [15] demonstrated the application of the PDC technique on new and aged power transformers for assessment of the insulation condition and moisture content in solid insulation. Frimpong et al. [16] reported measurements and modeling of polarization and depolarization currents in a composite oil/paper insulation system. They also showed the influence of material properties like conductivity on the dielectric response.

The basic theory of the dielectric response measurements will be given in the following section with special emphasis on the PDC technique and the different insulation condition assessment parameters that can be obtained from the PDC measurement.

2.1 BASIC THEORY OF DIELECTRIC RESPONSE [7,8,16,18]

Assuming a homogeneous electric field $E(t)$ is applied to the dielectric material, the current density through the surface of the material can be written as

$$J(t) = \sigma E(t) + \frac{dD(t)}{dt} \quad (1)$$

The current density $J(t)$ is the sum of the conduction current and the displacement current, where σ is the dc conductivity and $D(t)$ is the electric displacement as given below

$$D(t) = \epsilon_0 \epsilon_r E(t) + \Delta P(t) \quad (2)$$

where ϵ_0 is the vacuum permittivity and ϵ_r is the relative permittivity of the insulation at power frequency (typically 4.5 for cellulose paper/pressboard and 2.2 for transformer hydrocarbon oil). $P(t)$ is the dielectric polarization and is related to the response function $f(t)$ of the material by the relationship

$$\Delta P(t) = \epsilon_0 \int_0^\infty f(t-\tau) \cdot E(\tau) d\tau \quad (3)$$

The response function $f(t)$ describes the fundamental memory property of the dielectric system and can provide significant information about the insulating material [8]. The function $f(t)$ can be determined experimentally as the response of the dielectric to a step-function charging field [8].

2.2 POLARIZATION AND DEPOLARIZATION CURRENTS

One way, in the time domain, to investigate the polarization process for a dielectric material is to measure polarization and depolarization currents. Combining equations (2) and (3), equation (1) can be re-written as

$$J(t) = \sigma E(t) + \epsilon_0 \epsilon_r \frac{dE(t)}{dt} + \epsilon_0 \frac{d}{dt} \int_0^t f(t-\tau) \cdot E(\tau) d\tau \quad (4)$$

For a homogeneous material, the field strength $E(t)$ can be considered as generated by an external voltage $U(t)$, the current through a test object with geometric capacitance C_0 (measured capacitance at or near power frequency, divided by ϵ_r) can be written as

$$i(t) = C_0 \left[\frac{\sigma}{\epsilon_0} U(t) + \epsilon_r \frac{dU(t)}{dt} + \frac{d}{dt} \int_0^t f(t-\tau) \cdot U(\tau) d\tau \right] \quad (5)$$

The test object can be a single dielectric material or an arrangement of several dielectric materials in series or in

parallel. For more than one dielectric material, σ , ϵ_r and $f(t)$ represent, respectively, composite conductivity, relative permittivity and dielectric response function of this heterogeneous test object. Assuming that the test object is totally discharged and that a step voltage is applied with the following characteristics

$$U(t) = \begin{cases} 0 & t < 0 \\ U_0 & 0 \leq t \leq t_c \\ 0 & t > t_c \end{cases} \quad (6)$$

This will give zero current for times before $t=0$, and so-called polarization currents for times $0 \leq t \leq t_c$. The polarization current is built up in two parts—one part is related to the conductivity of the test object and the other is related to the activation of the different polarization processes within the test object. The polarization (charging) current through the object can thus be expressed as

$$i_p(t) = C_0 U_0 \left[\frac{\sigma}{\epsilon_0} + f(t) \right] \quad (7)$$

Once the step voltage is replaced by a short circuit, a depolarization current is built up. The magnitude of the depolarization current is expressed as

$$i_d(t) = C_0 U_0 [f(t) - f(t+t_c)] \quad (8)$$

where t_c is the time during which the voltage has been applied to the test object.

2.3 DIELECTRIC RESPONSE FUNCTION ESTIMATION

It has been shown [8,16,19] that, for oil/cellulose insulation systems, the “general response function” can be expressed in parametric form as

$$f(t) = \frac{A}{\left(\frac{t}{t_0}\right)^n + \left(\frac{t}{t_0}\right)^m} \quad (9)$$

with A , $t_0 > 0$, $m > n > 0$ and $m > 1$.

In order to estimate the dielectric response function $f(t)$ from a depolarization current measurement it is assumed that the dielectric response function is a continuously decreasing function in time, then if the polarization period is sufficiently long, so that $f(t+t_c) \cong 0$, the dielectric response function $f(t)$ is proportional to the depolarization current. Thus from equation (8)

$$f(t) \approx \frac{-i_d(t)}{C_0 U_0} \quad (10)$$

The parameters of $f(t)$ are obtained from a non-linear least square fit into equation (10).

2.4 ESTIMATION OF THE CONDUCTIVITY

From the measurements of polarization and depolarization currents, it is possible to estimate the dc conductivity σ , of the test object. If the test object is charged for a sufficiently long time so that $f(t + t_c) \cong 0$, equation (7) and equation (8) can be combined to express the dc conductivity of the composite dielectric as:

$$\sigma \approx \frac{\epsilon_0}{C_0 U_0} (i_p(t) - i_d(t)) \quad (11)$$

The average conductivity for a given insulation system thus, is found to be dependent upon the difference between the polarization and depolarization current values. For a linear dielectric, it is expected that the difference between the polarization and depolarization current is equal to the time-independent direct current [9]. However, practical dielectric systems inevitably have certain non-linearity in their dielectric response. As a result, the difference between the polarization and depolarization current is found to vary with time [8] depending upon the condition of the oil and paper. The conductivity of the dielectric computed using equation (11) would thus be dependent on time. This composite conductivity, in practice, is the convolution of the conductivities of the oil and the paper that make up the insulation structure.

3 PDC MEASUREMENT

The principle of measurement of polarization and depolarization current is based on application of a dc voltage across a test object for a long time (e.g., 10000 s). During this time, the current, arising from the activation of the polarization process with different time constants corresponding to different insulation materials and due to the conductivity of the object is measured. Then the voltage is removed and the object is short-circuited. The previously activated polarization process now gives rise to the

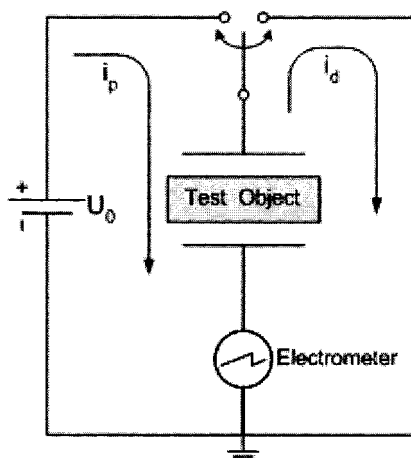

Figure 1. Basic PDC measuring circuit.

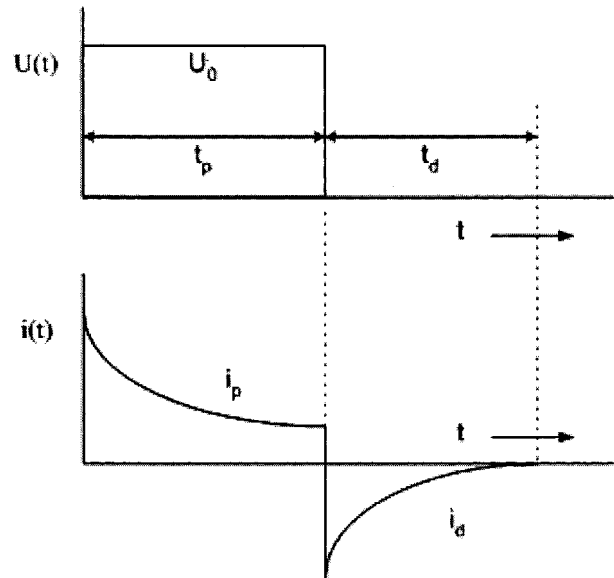

Figure 2. Waveform of polarization and depolarization currents.

discharging current in the opposite direction, where no contribution of the conductivity is present. The schematic diagram of the PDC measuring set-up is shown in Figure 1. Figure 2 shows the typical nature of these currents due to a step charging voltage U_0 .

Charging and discharging currents (i.e. polarization and depolarization currents) are influenced by the properties of the insulating materials as well as by the geometric structure of the insulating system [20].

The interfacial polarization spectra (IPS) measurement equipment [10,18,21] developed at the School of Information Technology and Electrical Engineering, University of Queensland, has the capability of measuring the PDC. The system is equipped with a computer, a GPIB card, a high resistance electrometer with a built-in dc charging voltage source (software controllable up to 1000 V), a 16-channel with PCAC2 switch module power control interface (control 488/16) and two HV relays. The required software has been developed in the LabView environment to control this hardware system. The user-friendly interface of the developed software enables the operator to choose the voltage and time for charging and discharging. Once the operator sets the system into operation the measurement system becomes fully automated. The measurement data can be stored in the computer for future analysis.

4 SIMULATION OF DIELECTRIC RESPONSES

The dielectric properties of an insulating material change with moisture, ageing and contamination products. The conductivities of both oil and paper can change over a wide range during the operation of the transformer de-

pending upon the operating conditions. In order to assess the state of the insulation system by the analysis of dielectric response characteristics, it is thus important to understand the influence of various dielectric properties on the dielectric response measurements.

A software based modeling tool has been developed for the numerical solution of the integral-differential equations described in Section 2 for determination of various dielectric responses. For modeling purpose, a series combination of oil duct and paper/pressboard has been adopted [7,12,16]. Each material is characterized by its conductivity and permittivity along with the composite dielectric response function $f(t)$.

4.1 MODELING OF THE RESPONSE FUNCTION $f(t)$ AND ESTIMATION OF CONDUCTIVITY

The first step is to fit the measured depolarization current in parametric form to obtain the *Dielectric Response Function* $f(t)$ from equations (9) and (10). The nature of the depolarization current is dependent on several factors including the geometry, the moisture content, conductivity and other ageing conditions of the oil-paper composite insulation system. The response function $f(t)$ thus, when fitted to the depolarization current, is supposed to characterize all these physical properties and conditions of the composite insulation system. Figure 3 shows the depolarization current measured on a 60 MVA transformer with 500 V_{dc} charging voltage and 10⁴ s charging and discharging periods each. The response function $f(t)$ fitted to the depolarization current is also shown in Figure 3, which shows a good agreement between the measured depolarization current and the fitted response function $f(t)$.

The next step is to compute the conductivities of oil and paper insulation utilizing equation (11). The quantity C_0 in equation (11) is the geometric capacitance of the

insulation given by (12)

$$C_0 = \frac{C_m}{\epsilon_r} \quad (12)$$

C_m is the capacitance measured between the two terminals of the insulation system under test. It can be measured with any capacitance measuring ac bridge at or around the power frequency. ϵ_r is the effective relative permittivity of the composite oil-paper insulation system. For accurate estimation of this effective permittivity, it is desirable to have correct and complete knowledge about the design and exact composition of the oil-paper insulation system of the transformer. In most cases, however, information about the exact design and composition of the transformer insulation system is not readily available from the utilities. For modeling purposes (and for most practical cases) it is sufficient to assume a series arrangement of paper/pressboard and oil duct of the transformer insulation system. In such a case, Gafvert et al. [16] suggested equation (13) as the expression for the effective permittivity.

$$\epsilon_r = \frac{\epsilon_p \cdot \epsilon_d}{\epsilon_p \cdot (1 - X) + \epsilon_d \cdot X} \quad (13)$$

where ϵ_p and ϵ_d are the relative permittivity of paper and oil respectively. X is the relative amount of paper in the composite system. The range of X is typically 20% to 50% [16] for a transformer.

Similarly, the effective conductivity may be written as

$$\sigma_r = \frac{\sigma_{paper} \cdot \sigma_{oil}}{\sigma_{paper} \cdot (1 - X) + \sigma_{oil} \cdot X} \quad (14)$$

where σ_{paper} and σ_{oil} are paper and oil conductivities respectively.

Once the values of the effective permittivity ϵ_r and hence C_0 is estimated, effective conductivity σ_r can be

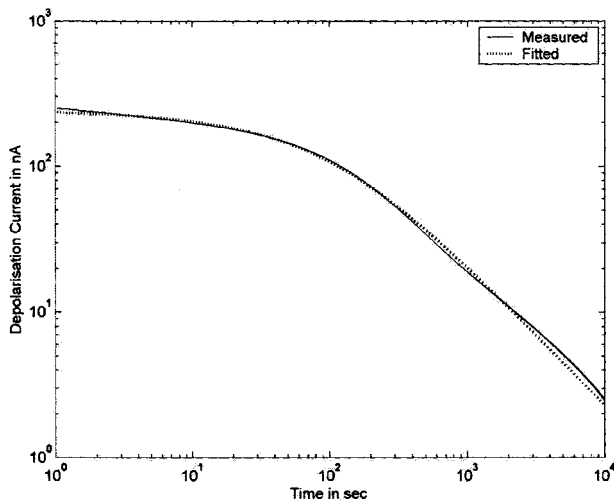

Figure 3. A typical $f(t)$ fitted from depolarization current.

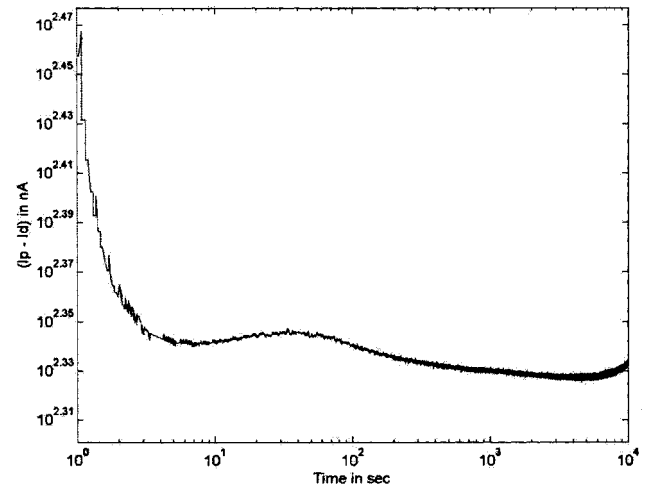

Figure 4. Difference between polarization and depolarization currents.

determined using equation (11) from the difference between the polarization and depolarization currents. Figure 4 is the plot of the difference between the polarization and depolarization current of a 35 MVA transformer tested with 500 V_{dc} for 10⁴ s charging and discharging periods each. Unlike in Figure 4, one would expect that the difference between the polarization and depolarization currents is constant throughout and equal to the conduction current. This condition is only true for a linear dielectric and when the charging time is sufficiently long. But in practical dielectric systems, like in the complex oil/paper insulation system of a transformer, the assumption of linearity is not always true. Moreover due to time constraints in actual field-testing, it is often not possible to charge the insulation for periods longer than 10⁴ s. The conduction current (difference between polarization and depolarization currents) shown in Figure 4 is thus found to be time-varying. Earlier researchers [11,15,16,18] have reported that the initial parts of the polarization and depolarization currents are sensitive to the condition of the oil, whereas the final long-term values of these currents are influenced by the condition of the solid insulation (paper). In other words, the initial higher magnitude of the conduction current, as seen in Figure 4, is due to the higher mobility of the charge carriers in the liquid dielectric (oil). This initial part of the response is found to die down after some time and the steady conduction current due to the less mobile charge carriers in the solid insulation (paper/pressboard) becomes predominant. The initial polarization current (after the first transient that is normally not recorded) can be written as

$$i_p(+0) = C_0 U_0 \frac{\sigma_{oil}}{\epsilon_0} \cdot \frac{\epsilon_r}{\epsilon_d} \quad (15)$$

such that

$$\sigma_{oil} = \frac{\epsilon_0 \cdot \epsilon_d}{\epsilon_r \cdot C_0 \cdot U_0} \cdot i_p(+0) \quad (16)$$

On the other hand, the long-time polarization current (steady dc value i_{dc}) can be related to the paper conductivity as

$$i_{dc} = C_0 \cdot U_0 \frac{\sigma_r}{\epsilon_0} \quad (17)$$

If $\sigma_{oil} \gg \sigma_{paper}$, then from equation (14) we get

$$\sigma_r = \frac{\sigma_{paper}}{X} \quad (18)$$

Combining equations (17) and (18) we get

$$i_{dc} = C_0 \cdot U_0 \cdot \frac{\sigma_{paper}}{\epsilon_0 \cdot X}$$

or,

$$\sigma_{paper} = \frac{\epsilon_0 \cdot X}{C_0 \cdot U_0} \cdot i_{dc} \quad (19)$$

An average value of $X = 0.35$ has been chosen for the calculation of paper conductivity.

4.2 INFLUENCES OF OIL AND PAPER CONDUCTIVITIES ON PDC

For better understanding of the interrelationship between the oil and paper conductivities and the nature of the polarization and depolarization currents, a simulation study was performed with the developed dielectric response modeling tool. Jonscher [8] described that the response function $f(t)$ given by equation (9) is influenced by the two major time constants n and m in the logarithmic representation. The time constant n influences the shape of the response function at shorter times, while the nature of the response function at longer times is dependent on the other time constant m . On the other hand, it was previously pointed out [11,15,16,18] that the nature of the polarization and depolarization currents at shorter times are influenced by the oil conductivity, whereas the final parts of these currents are controlled by the conductivity of the solid insulation. These two-time constants n and m thus, can be related to the conductivities of oil and paper respectively. To investigate the effect of the variation of oil and paper conductivity on the polarization and depolarization currents, these currents are simulated using equations (7), (9), (11) and (14) with different values of oil and paper conductivities. Figures 5 to 8 show the effect of change of paper and oil conductivities (σ_{paper} and σ_{oil} respectively) on the shape of the polarization and depolarization currents.

In general, moisture and contamination tend to increase the conductivity of both the solid and liquid dielec-

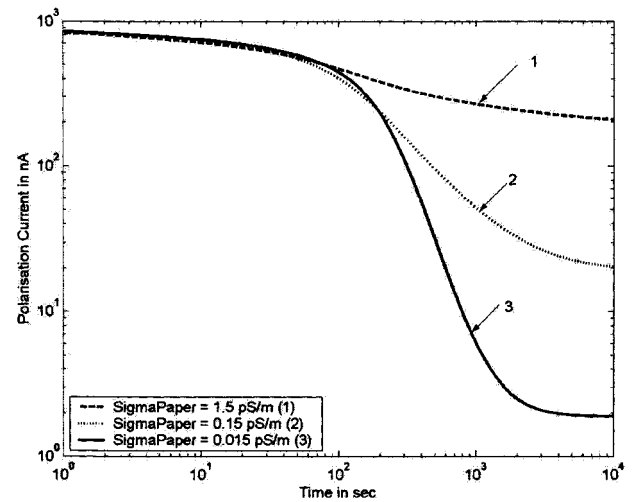

Figure 5. Variation of polarization currents with paper conductivity. 1, $\sigma_{paper} = 1.5$ pS/m; 2, $\sigma_{paper} = 0.15$ pS/m; 3, $\sigma_{paper} = 0.015$ pS/m.

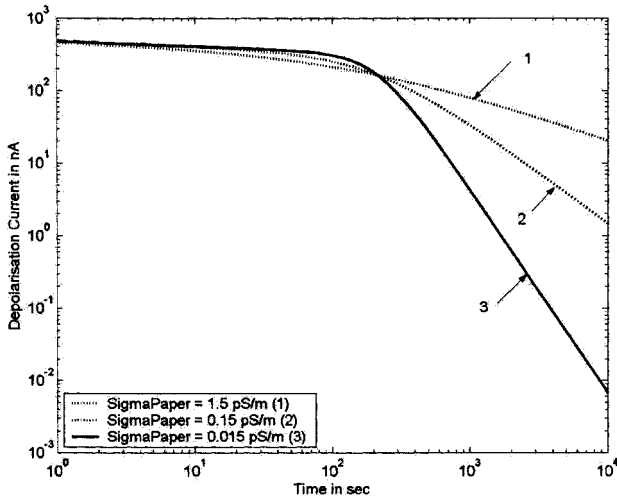

Figure 6. Variation of depolarization currents with paper conductivity. 1, $\sigma_{paper} = 1.5$ pS/m; 2, $\sigma_{paper} = 0.15$ pS/m; 3, $\sigma_{paper} = 0.015$ pS/m.

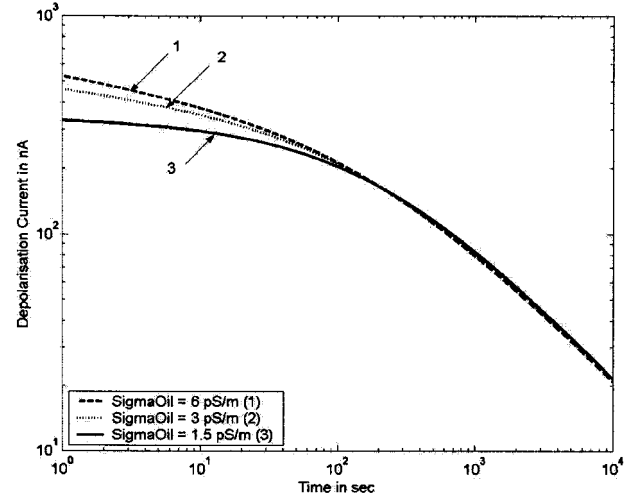

Figure 8. Variation of depolarisation currents with oil conductivity. 1, $\sigma_{oil} = 6$ pS/m; 2, $\sigma_{oil} = 3$ pS/m; 3, $\sigma_{oil} = 1.5$ pS/m.

tric in the transformer. A close study of the nature of the polarization and depolarization currents shown in Figures 5 to 8 brings out the following general observations.

As shown in Figure 5 and Figure 6, changes in paper conductivity tend to affect the tail of both polarization and depolarization currents. Whereas, Figure 7 and Figure 8 demonstrate that the initial part of the dielectric responses is primarily controlled by the parameters of the

liquid dielectric. It is also observed from Figure 5 through Figure 8 that higher values of conductivity tend to increase the magnitude of both the polarization and depolarization currents.

These general observations are employed for the analysis of the results of the on-site PDC measurements on several transformers as discussed in the following section.

5 FIELD TEST RESULTS

A number of recently tested transformers' information is summarized in Table 1. These transformers were tested under open substation environment. The transformers were taken out of service at least one day prior to the testing, so that the transformer temperature could settle down to the ambient before starting the tests. All the tests were carried out at a charging voltage of 500 V_{dc} and with 10⁴ s charging and discharging periods each. For the purpose of better understanding, they have been categorized into three groups A, B and C. The first group (A) consists of two transformers of which one is lightly loaded and the other one is heavily loaded. The second group (B) consists of a single transformer, on which PDC measurements have been carried out before and after oil reclamation and the third group (C) consists of two very old transformers (still in service). The polarization and depolarization currents for the transformers in group A, group B and group

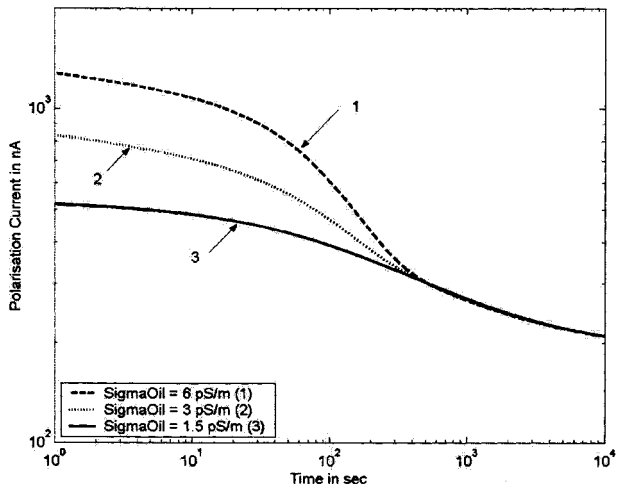

Figure 7. Variation of polarisation currents with oil conductivity. 1, $\sigma_{oil} = 6$ pS/m; 2, $\sigma_{oil} = 3$ pS/m; 3, $\sigma_{oil} = 1.5$ pS/m.

Table 1. Transformer Details.

Transformer	A1	A2	B1	B2	C1	C2
MVA	7	30	100	100	35	45
Volt (kV)	66/11	132/66/11	330/132/16	330/132/16	66/22	66/22
Connection	Y/Δ	Y/Y/Δ	Y/Y/Δ	Y/Y/Δ	Y/Y	Y/Y
Year of Manufacture	1968	1966	1966	1966	1936	1959
Service Record	Lightly loaded	Suspected to be very aged	Before Oil Reclamation	After Oil Reclamation	Operating, but aged	Operating, but aged

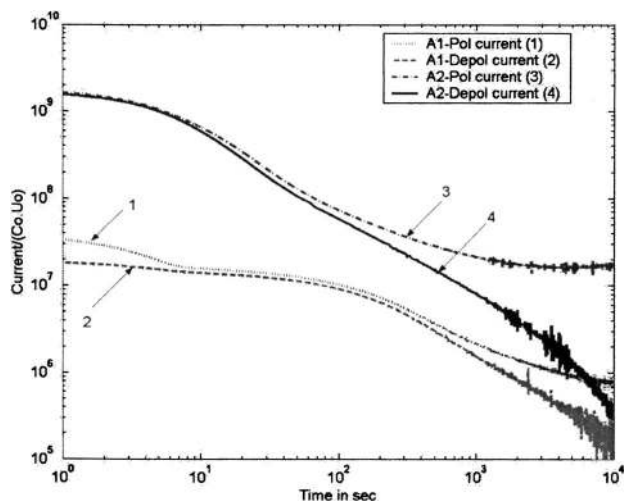

Figure 9. Variation of polarisation and depolarisation currents 1 and 2, POI/Depol current for A1 and A2. 3 and 4, Pol/Depol current for A2.

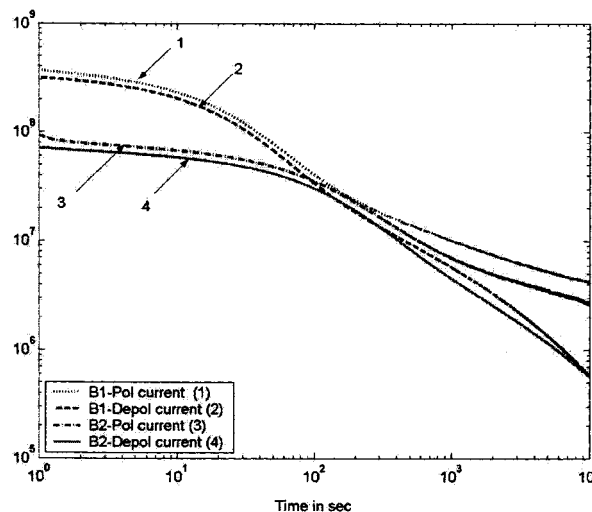

Figure 10. Variation of polarization and depolarization currents for B1 and B2. 1 and 2, Pol/Depol current for B1; 3 and 4, Pol/Depol current for B2.

C are plotted in Figures 9 to 11, respectively. The current plots in each case are divided by the corresponding charging voltage and geometric capacitance values. In this way, they have been normalized to an equivalent base of geometry and charging voltage for easier inter-comparison.

5.1 TRANSFORMERS A1 AND A2

It is evident from the Figure 9, that both polarization and depolarization currents for A2 are higher than those of A1. Transformers with poor insulation condition normally have higher values of polarization/depolarization currents. The transformer A2 was suspected for advanced insulation ageing due to the fact that one of the companion transformers of this group failed in service. A1 was relatively lightly loaded during its service life—it was expected that the condition of the insulation in A1 was better than A2.

The polarization and depolarization currents at longer times are lower for the transformer A1 as compared to the transformer A2. This is indicative of the fact that the paper insulation of A1 is less conductive than that of A2. The paper conductivity values for A1 and A2 calculated using equation (19) are presented in Table 2. The higher conductivity of paper in A2 than A1 indicates that the paper insulation in A2 is in more moist and degraded condition than A1. Oil conductivity values calculated from the

polarizations current during the initial period of time using equation (16) are also presented in Table 2. The higher value of oil conductivity of A2 as compared to that of A1 indicates that the oil in A2 has higher moisture content and degradation by-products than A1. These results once again agree with the fact that A1 was lightly loaded during its service period, whereas A2 was taken out of service with suspected condition of advanced insulation degradation.

Oil samples were collected for furan analysis by the HPLC technique. Results of 2-furfuraldehyde are also shown in Table 2. The furan content of A2 is more than 50 times higher than that of A1. A higher value of 2-furfuraldehyde in the oil analysis data also supports the inference of a more degradation of the paper insulation in A2 than A1.

5.2 TRANSFORMERS B1 AND B2

Figure 10 represents the polarization and depolarization current plots for B1 and B2, which essentially is the same transformer. Recently, oil reclamation was conducted for the transformer and we had the opportunity to test this transformer both before and after the oil reclamation process. According to the information available from the utility, the oil-reclamation process basically consisted of recycling, filtering and drying the oil through vacuum and at high temperature. The dry and filtered oil was pumped back to the tank and the whole process was continued in a close-cycle. In such a close-cycle oil reclamation process, it is expected that some moisture and other degradation by-products will be driven off the oil. At the same time when the dry oil is circulated through the transformer, some moisture will also migrate out of the paper towards the relatively dry oil. Thus, in such oil-re-

Table 2. Insulation condition of A1 and A2.

Transformer		A1	A2
Conductivity (S/m)	Oil	3.0×10^{-13}	5.7×10^{-12}
	Paper	2.5×10^{-15}	3.0×10^{-13}
Capacitance (nF)		3.9	2.4
2-Furfuraldehyde (ppm)		0.02	1.03

Table 3. Insulation condition of B1 and B2.

Transformer		B1	B2
Conductivity (S/m)	Oil	7.6×10^{-12}	1.9×10^{-12}
	Paper	3.5×10^{-14}	2.2×10^{-14}
Capacitance (nF)		3.3	3.2
2-Furfuraldehyde (ppm)		1.9	0.26
Moisture Content	Oil (ppm)	28	10
	Paper (%)	5	3.5
Oil Sampling Temp. (°C)		23	25

clamination process, the oil moisture content and other ageing by-products are expected to go down along with some improvement in the paper moisture condition as well.

As can be seen from Figure 10, both the polarization and depolarization currents for B1, which represents the transformer before oil reclamation, have higher values during the initial period than B2, which represents the transformer after oil reclamation. Oil conductivity values of B1 and B2 calculated from the initial values of polarization currents are shown in Table 3. The oil moisture content values measured by Karl Fischer Titration method are also presented in Table 3. The initial lower magnitudes of polarization and depolarization currents and lower oil conductivity of B2 as compared to B1 indicates that after oil reclamation, the oil condition has improved as a whole. This observation is also confirmed by the lower oil moisture-content value of B2 than B1 as shown in Table 3.

As seen in Figure 10, the final values of polarization and depolarization currents are higher for B1 than B2. Paper conductivity values calculated from these current values using equation (19) are presented in Table 3. It is found that the paper conductivity of B2 (after oil reclamation) is lower than the paper conductivity of B1 (before oil reclamation). Table 3 also contains the paper moisture content values determined using the equilibrium chart [17] from the measured oil moisture content values at the corresponding oil sampling temperatures. As seen in Table 3, the estimated paper moisture drops to a value of 3.5% after oil reclamation from the initial value of 5% before the oil reclamation. It however remains a fact that the accuracy of the equilibrium chart [17] is questionable at the lower ranges of oil and paper moisture content values. Even then, it is not beyond expectation that during such an oil-reclamation process, some moisture has migrated out of the paper insulation towards the relatively dry oil.

Table 3 also contains the furan (2-furfuraldehyde) values measured in the oil samples using the HPLC technique. As expected, filtering and drying of the oil at high temperature under vacuum during the reclamation process have driven out some amount of furan and other ageing by-products from the oil.

In summary, it is observed that after the oil reclamation process, the conductivity values of both oil and paper are

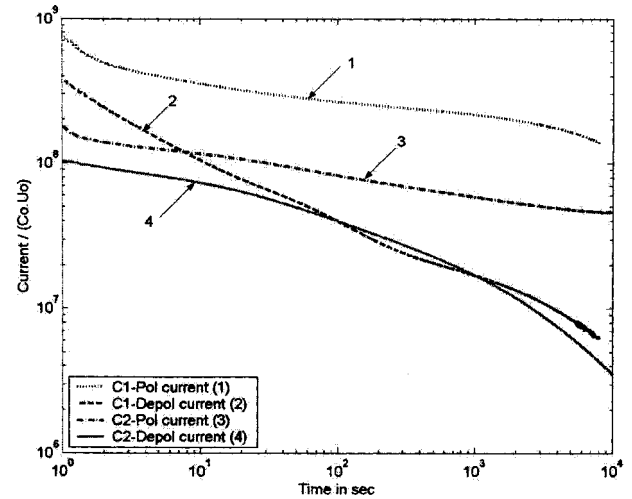
**Figure 11.** Variation of polarisation and depolarisation currents for C1 and C2. 1 and 2, Pol/Depol current for C1; 3 and 4, Pol/Depol current for C2.

reduced. The reductions are, however, not very significant, only of the order of half. This suggests that oil reclamation did not significantly improve the ageing condition, though it drove out some moisture and ageing by-products out of the oil and paper. One would expect that the reduction of conductivity should be in the order of 10 for a significant reduction in ageing and moisture condition.

5.3 TRANSFORMERS C1 AND C2

Polarization and depolarization currents for the transformers C1 and C2 are plotted in Figure 11. The magnitudes of the polarization and depolarization currents of C1 are higher than those of C2. This indicates that the general condition of the insulation of C1 is worse than C2. This is not unexpected since transformer C1 has been in operation since 1936 as compared to C2, which was manufactured in 1959. As seen in Figure 11, there is quite a big difference between the polarization and depolarization currents of C1. This may be due to the extremely degraded and moist condition of insulation in C1. Another reason for this unusually large value of the polarization current may be due to the presence of some amount of ions in the oil and paper from previous excitation processes. However, the current values could not be re-con-

Table 4. Insulation condition of C1 and C2.

Transformer		C1	C2
Conductivity (S/m)	Oil	31.0×10^{-12}	3.6×10^{-12}
	Paper	2.3×10^{-12}	3.8×10^{-13}
Capacitance (nF)		9.2	10.2
2-Furfuraldehyde (ppm)		1.87	3.81
Moisture Content	Oil (ppm)	36	26
	Paper (%)	4.2	3.2
Oil Sampling Temp. (°C)		40	40

firmed by a second repeat measurement due to the limited period of actual testing time provided by the distribution company.

The polarization and depolarization currents during the initial period of time are larger in C1 than C2. The oil conductivities for C1 and C2 calculated from using equation (16) are given in Table 4. As expected, oil conductivity for C1, with more degraded insulation, is higher than that of C2. The values of the oil moisture contents measured by Karl Fischer Titration method are also shown in Table 4. The higher value of oil moisture content of C1 over C2 once again supports the observation that the oil condition of C1 is more degraded than that of C2.

Figure 11 also shows that the polarization and depolarization currents are high at larger values of time for C1 than C2. Paper conductivity values calculated using equation (19) and paper moisture content values estimated from the measured oil moisture content values using the equilibrium chart [17] are presented in Table 4. As expected, both the paper conductivity and paper moisture content of C1 are higher than those of C2, indicating a more degraded condition of paper in C1 compared to C2.

Furan measurements, however, showed an opposite trend for C1 and C2. Although both transformers are having high 2-furfuraldehyde contents, this anomaly in result could not be explained in any other way than attributing it to measurement errors and other associated inaccuracies.

6 CONCLUSIONS

THIS paper describes the usefulness of PDC technique as a modern non-destructive tool for the condition assessment of transformers insulation. From the simulation and field-test results presented in this paper, it appears that both the polarization and depolarization currents are strongly influenced by the conductivity, moisture contents and ageing status of the oil and the paper. Higher values of polarization and depolarization currents can be attributed to higher conductivity, higher moisture content and advanced ageing state of the insulation. Initial period of the polarization/depolarization current are found to be governed by the oil properties and the long time values of these currents are primarily determined by the paper/pressboard condition. Though the condition of both oil and paper can thus be separately estimated, it still appears to be difficult to quantify the exact degree of ageing from the PDC measurements. The authors are currently involved in laboratory experiments on moisture-controlled dielectric testing for better understanding and interpretation of the PDC test results.

PDC tests carried out on very old transformers suggest that ageing of paper and oil insulation is manifested in the form of higher moisture contents and other ageing by-products and subsequently shows higher conductivities of both the oil and the paper. The PDC measurement re-

sults presented also suggest that oil reclamation, in general, improves moisture condition of the oil and paper. A significant reduction of furan content has been monitored from the oil sampled immediately after the oil reclamation. Transformers ageing by-products are mostly polar in nature and are always bound to the paper surface. So it is expected that ageing process of paper would be again accelerated at a faster rate in future depending on other operating conditions inside the transformer. Hence the evidence of reduction of ageing by products is not guaranteed by a single test. Further tests in future could be useful for the estimation of paper ageing.

REFERENCES

- [1] M. Darveniza, D. J. T. Hill, T. T. Le and T. K. Saha, "Investigations into Effective Methods for Assessing the Condition of Insulation in Aged Power Transformers", IEEE Trans. Power Del., Vol. 13, pp. 1214-1223, 1998.
- [2] D. J. T. Hill, M. Darveniza, T. T. Le and T. K. Saha, "A Study of Degradation of Cellulosic Insulation Materials in a Power Transformer, Part 1: Molecular Weight Study of Cellulose Insulation Paper", Polymer Degradation and Stability, Vol. 48, pp. 79-87, 1995.
- [3] D. J. T. Hill, M. Darveniza, T. T. Le and T. K. Saha, "A Study of Degradation of Cellulosic Insulation Materials in a Power Transformer. Part 2: Tensile Strength of Cellulose Insulation Paper", Polymer Degradation and Stability, Vol. 49, pp. 429-435, 1995.
- [4] J. Unsworth and F. Mitchell, "Degradation of Electrical Insulation Paper Monitored Using High Performance Liquid Chromatography", IEEE 2nd International Conference on Properties and Application of Dielectric Materials (ICPADM), China, Vol. 1, pp. 337-340, 1988.
- [5] R. Andersson and K. Heinonen, "Experiences of Furfuraldehyde Analysis in Condition Monitoring of Power Transformers", Nordic Insulation Symposium NORD-IS, Paper 6.4, pp. 1-10, 1992.
- [6] M. Darveniza, D. J. T. Hill, T. T. Le, and A. K. Whittaker, "NMR Relaxation Behaviour of Cellulose Transformer Insulation Paper", IEEE 4th International Conference on Properties and Applications of Dielectric Materials (ICPADM), Vol. 2, pp. 784-787 1994.
- [7] U. Gafvert, L. Adeen, M. Tapper, P. Ghasemi and B. Jonsson, "Dielectric Spectroscopy in Time and Frequency Domain Applied to Diagnostics of Power Transformers", IEEE 6th Intern. Conf. Properties and Applications of Dielectric Materials (ICPADM), China, Vol. 2, pp. 825-830, 2000.
- [8] A. K. Jonscher, *Dielectric Relaxation in Solids*, Chelsea Dielectric Press, 1983.
- [9] Z. T. Yao and T. K. Saha, "Analysis and Modelling of Dielectric Responses of Power Transformer Insulation", Proc. IEEE PES Summer Meeting, Chicago, Vol. 1, pp. 417-421, 2002.
- [10] T. K. Saha, D. J. T. Hill, Z. T. Yao, G. Yeung and M. Darveniza, "The Application of Interfacial Polarization Spectra for Assessing Insulation Condition in Aged Power Transformers", CIGRE Paris session, Paper no. 12-202, Paris, 1998.
- [11] E. Ildstad, U. Gafvert and P. Tharning, "Relation between Return Voltage and Other Methods for Measurements of Dielectric Response", IEEE Intern. Sympos. Electr. Insul., USA, pp. 25-28, 1994.
- [12] J. J. Alff, Vahe Der. Houhanessian, W. S. Zaengl and A. J. Kachler, "A Novel, Compact Instrument for the Measurement and Evaluation of Polarisation/Depolarisation Currents Conceived for On-Site Diagnosis of Electric Power Apparatus", IEEE Intern. Sympos. Electr. Insul., USA, pp. 161-167, 2000.
- [13] M. Hassig, R. Braunlich, R. Gysi, J. J. Alff, Vahe Der. Houhanessian and W. S. Zaengl, "On-site Applications of Ad-

vanced Diagnosis Methods for Quality Assessment of Insulation of Power Transformers", IEEE Conf. Electr. Insul. Dielectr. Phenomena, USA, pp. 441-447, 2001.

- [14] Vahe Der. Houhanessian and W. S. Zaengl, "Time Domain Measurements of Dielectric Response in Oil-Paper Insulation Systems", IEEE Intern. Sympos. Electr. Insul., Canada, Vol. 1, pp. 47-52, 1996.
- [15] T. Leibfried and A. J. Kachler, "Insulation Diagnostics on Power Transformers Using the Polarisation and Depolarisation Current (PDC) Analysis", IEEE Intern. Sympos. Electr. Insul., USA, pp. 170-173, 2002.
- [16] U. Gafvert, L. Adeen, M. Tapper, P. Ghasemi and B. Jonsson, "Dielectric Spectroscopy in Time and Frequency Domain Applied to Diagnostics of Power Transformers", IEEE 6th International Conference on Properties and Applications of Dielectric Materials, China, Vol. 2, pp. 825-830, 2000.
- [17] T. V. Oommen, "Moisture Equilibrium in Paper Oil Insulation Systems", IEEE 16th Electrical/Electronics Insul. Conf., Chicago, pp. 162-166, 1983.
- [18] T. K. Saha, "Review of Time Domain Polarisation Measurements for Assessing Insulation Condition in Aged Transformers", IEEE Trans. Power Delivery, 2002 (in Press, accepted).
- [19] U. Gafvert and E. Ildstad, "Modelling Return Voltage Measurement of Multi-Layer Insulation Systems", IEEE 4th International Conference on Properties and Applications of Dielectric Materials, Australia, Vol. 1, pp. 123-126, 1994.
- [20] A. Kuchler and T. Bedel, "Dielectric Diagnosis of Water Content in Transformer Insulation Systems", European Trans. Electr. Power, Vol. 11, pp. 65-68, 2001.
- [21] T. K. Saha, M. Darveniza, D. J. T. Hill and T. T. Le, "Electrical and Chemical Diagnostics of Transformers Insulation. Part A. Aged Transformer Samples", IEEE Transactions on Power Delivery, Vol. 12, pp. 1547-1554, 1997.



Tapan Kumar Saha (M'93, SM'97) was born in Dhaka, Bangladesh in 1959. He received the B.Sc. Engineering degree (electrical and electronic) in 1982 from the Bangladesh University of Engineering & Technology, Dhaka, Bangladesh, the M.Tech (electrical engineering) degree in 1985 from the Indian Institute of Technology, New Delhi, India and the Ph.D. degree in 1994 from the University of Queensland, Brisbane, Australia.

Before joining the University of Queensland as a lecturer in 1996 he taught at the Bangladesh University of Engineering and Technology, Dhaka, Bangladesh for three and a half years and at James Cook University, Townsville, Australia for two and a half years. Dr Saha is currently a Senior Lecturer in the School of Information Technology and Electrical Engineering, University of Queensland, Australia. He is a Fellow and Chartered Professional Engineer of the Institution of Engineers, Australia. His research interests include condition monitoring of electrical plants, power systems and power quality. He has published widely in these fields.



Prithwiraj Purkait (M'99) was born in Kolkata, India in 1973. He obtained the B.E.E., M.E.E. and Ph.D. degrees from Jadavpur University, Kolkata, India in 1996, 1999 and 2002, respectively. He worked with M/s Crompton Greaves Ltd, Mumbai, India as a design engineer for one year. Presently he holds the post of lecturer in the department of Electronics and Instrumentation Engineering in Haldia Institute of Technol-

ogy, Haldia, India. He is currently involved in post-doctoral research in the University of Queensland, Australia. His current research includes transformer insulation condition assessment techniques and advanced signal processing applications in High Voltage Engineering.