

Ion Channels and Signaling in the Pituitary Gland

Stanko S. Stojilkovic, Joël Tabak, and Richard Bertram

Section on Cellular Signaling (S.S.S.), Program in Developmental Neuroscience, National Institute of Child Health and Human Development, National Institutes of Health, Bethesda, Maryland 20892-4510; and Department of Biological Science (J.T.) and Department of Mathematics and Programs in Neuroscience and Molecular Biophysics (R.B.), Florida State University, Tallahassee, Florida 32306

Endocrine pituitary cells are neuronlike; they express numerous voltage-gated sodium, calcium, potassium, and chloride channels and fire action potentials spontaneously, accompanied by a rise in intracellular calcium. In some cells, spontaneous electrical activity is sufficient to drive the intracellular calcium concentration above the threshold for stimulus-secretion and stimulus-transcription coupling. In others, the function of these action potentials is to maintain the cells in a responsive state with cytosolic calcium near, but below, the threshold level. Some pituitary cells also express gap junction channels, which could be used for intercellular Ca^{2+} signaling in these cells. Endocrine cells also express extracellular ligand-gated ion channels, and their activation by hypothalamic and intrapituitary hormones leads to amplification of the pacemaking activity and facilitation of calcium influx and hormone release. These cells also express numerous G protein-coupled receptors, which can stimulate or silence electrical activity and action potential-dependent calcium influx and hormone release. Other members of this receptor family can activate calcium channels in the endoplasmic reticulum, leading to a cell type-specific modulation of electrical activity. This review summarizes recent findings in this field and our current understanding of the complex relationship between voltage-gated ion channels, ligand-gated ion channels, gap junction channels, and G protein-coupled receptors in pituitary cells. (*Endocrine Reviews* 31: 0000–0000, 2010)

- I. Introduction
- II. Pituitary Cell Types
 - A. POMC-producing cells
 - B. Heterodimeric glucoprotein-producing cells
 - C. GH- and PRL-producing cells
 - D. Nonsecretory cells
- III. Ion Channels Expressed in Pituitary Cells
 - A. Voltage-gated channels
 - B. Chloride channels and transporters
 - C. Channels expressed in and controlled by the endoplasmic reticulum
- IV. Spontaneous Electrical Activity
 - A. Spiking and bursting
 - B. Pacemaking mechanisms
 - C. Channels involved in spike depolarization
 - D. A mechanism for bursting
 - E. Functional roles of spontaneous spiking
- V. Signaling by Gap Junction Channels
 - A. Connexins
 - B. Pannexins
- VI. Signaling by Receptor Channels
 - A. Cys-loop family of receptor channels
 - B. Glutamate receptor channels
 - C. Purinergic receptor channels
- VII. Role of GPCRs in the Regulation of Electrical Activity
 - A. Stimulation of electrical activity by GPCRs

- B. Inhibition of electrical activity by GPCRs
- VIII. Calcium-Mobilizing Receptors and Electrical Activity
 - A. The dynamics of Ca^{2+} release
 - B. Calcium mobilization and secretion
- IX. Summary

I. Introduction

The pituitary gland is composed of two embryonically, anatomically, and functionally distinct entities, the neurohypophysis and the adenohypophysis. The neuro-

Abbreviations: AC, Adenylyl cyclase; AMPA, α -amino-3-hydroxy-5-methyl-4-isoxazole propionic acid; AP, action potential; AVP, arginine vasopressin; BK, calcium-activated big conductance K^+ (channels); $[\text{Ca}^{2+}]_{\text{ER}}$, Ca^{2+} concentration in the ER; $[\text{Ca}^{2+}]_{\text{i}}$, intracellular calcium concentration; CaCC, calcium-activated chloride (channels); Ca_v , voltage-gated calcium (channels); $[\text{Cl}^-]_{\text{i}}$, intracellular chloride concentration; CNG, cyclic nucleotide-gated; CNS, central nervous system; DAG, diacylglycerol; EAG, ether-a-go-go; ER, endoplasmic reticulum; erg, eag-related; ET, endothelin; GABA, γ -aminobutyric acid; GEF, guanine nucleotide exchange factor; GlyR, glycine receptor; GPCR, G protein-coupled receptor; α -GSU, glucoprotein hormone α -subunit; HCN, hyperpolarization-activated and cyclic nucleotide-modulated (channels); 5-HT, 5-hydroxytryptamine (serotonin); I_h , hyperpolarization-activated current; IP_3 , inositol 1,4,5-trisphosphate; IP_3R , IP_3 receptor; K_{Ca} , Ca^{2+} -activated K^+ (channels); K_{ir} , inwardly rectifying K^+ (channels); K_{v} , voltage-gated potassium (channels); Na_v , background sodium (channels); nAChR, nicotinic acetylcholine receptors; Na_v , voltage-gated sodium (channels); Na_x , Na^+ channel-like protein; NMDA, *N*-methyl-D-aspartate; PACAP, pituitary adenylyl cyclase-activating peptide; PDE, phosphodiesterase; PIP_2 , phosphatidylinositol 4,5 bisphosphate; PKA, protein kinase A; PKC, protein kinase C; PLC, phospholipase C; PMA, phorbol 12-myristate 13-acetate; POMC, proopiomelanocortin; PRL, prolactin; P2XR, ATP-gated (purinergic) receptor (channels); P2YR, P2Y receptor; RyR, ryanodine receptor; S, transmembrane segment; SERCA, sarcoplasmic-ER Ca^{2+} ATPase; sGC, soluble guanylyl cyclase; SK, calcium-activated small-conductance K^+ (channels); STIM, stromal-interacting molecule; TM, transmembrane; TRP, transient receptor-potential (channels); TRPC, canonical TRP; TRPM, melastatin TRP; TRPV, vanilloid TRP; TTX, tetrodotoxin; UDP, uridine-5'-diphosphate; VGIC, voltage-gated Ca^{2+} influx; VIP, vasoactive intestinal polypeptide.

hypophysis includes the posterior pituitary lobe, whereas the adenohypophysis includes the intermediate and anterior pituitary lobes. The posterior lobe is composed of axonal terminals of the hypothalamic magnocellular neurons surrounded by astrocytes, also known as pituicytes. The magnocellular neurons from paraventricular and supraoptic nuclei synthesize vasopressin and oxytocin and transport them to the axonal terminals in the posterior pituitary where they are secreted into the general circulation. The intermediate lobe is populated by melanotrophs, which synthesize and release α -MSH (or intermedins). The anterior pituitary is a heterogeneous gland with multiple cell types that secrete six major peptide hormones necessary for reproduction, lactation, growth, development, metabolic homeostasis, and the response to stress: FSH and LH-producing gonadotrophs, prolactin (PRL)-producing lactotrophs, GH-producing somatotrophs, TSH-producing thyrotrophs, and ACTH-producing corticotrophs. This lobe also contains the non-hormone-producing folliculostellate cells, which are glia-like cells, and endothelial cells that line the capillaries. The adenohypophysis of the fish pituitary is directly innervated by hypothalamic neurons, whereas in other vertebrates such a connection was preserved with the intermediate lobe, and whereas in the anterior lobe central nervous system (CNS) neurotransmitters act as releasing and inhibitory hormones delivered through the portal vessels.

This year, we celebrate the 35th anniversary of the discovery that not only neurons and muscle fibers but also endocrine pituitary cells fire action potentials (APs) (1). This pathway, known as the electrical signaling system, is composed of two basic elements: the lipid bilayer and two classes of macromolecular proteins, known as voltage-gated ion channels and ion transporters (2). From the beginning, it was obvious that the role of APs in the propagation of signals along the cells is not of great importance for spherical endocrine cells. However, the discovery of the electrical signaling system in endocrine pituitary cells supported the earlier proposed concept of stimulus secretion coupling (3). The elegance of this concept is that single cells contain all the elements needed for generating Ca^{2+} signals and triggering Ca^{2+} -dependent hormone secretion. The electrical signaling system of endocrine pituitary cells is under intrapituitary and hypothalamic control. Research on chemical signaling within the pituitary cells resulted in the discovery of autocrine and paracrine modes of regulation of pituitary functions and emphasized the role of extracellular ligand-gated ion channels (hereafter called receptor channels) and G protein-coupled receptors (GPCRs) in modulation of electrical activity (4). Communication between pituitary cells through gap junction channels has also been proposed (5).

The main control of spontaneous electrical activity and accompanied voltage-gated Ca^{2+} influx (VGCI) in some pituitary cell types *in vivo* occurs through hypothalamic releasing and inhibitory hormones acting on pituitary GPCRs signaling through $G_{i/o}$ and G_s signaling pathway. Activated receptors engage variable cellular processes, utilizing G proteins, cyclic nucleotides cAMP and cGMP, and their kinases, protein kinase A (PKA) and protein kinase G. All endocrine pituitary cells have an additional pathway for Ca^{2+} signaling, called the calcium-mobilizing pathway. This pathway is triggered by activation of $G_{q/11}$ -coupled receptors and some tyrosine kinase receptors, leading to inositol 1,4,5-trisphosphate (IP_3) and diacylglycerol (DAG) production, IP_3 -mediated Ca^{2+} release from the endoplasmic reticulum (ER), and activation of protein kinase C (PKC) and other signaling pathways. Activated GPCRs also cause a very complex and cell type-specific pattern of changes in the spontaneous firing of APs (6).

The pioneering work on pituitary cell excitability has been summarized in several reviews. The focus in the review by Ozawa and Sand (7) was on voltage-gated ion channels expressed in the pituitary, the effects of TRH on electrical activity and Ca^{2+} signaling, and the characterization of electrical properties of several cell lines. Two subsequent reviews were focused on the plasma membrane and ER Ca^{2+} channels that contribute to Ca^{2+} signaling in pituitary cells (6, 8). Calcium signaling pathways of endocrine pituitary cells have also been reviewed (9). The roles of GPCR-triggered intracellular messengers in hormone secretion were also studied in great detail in (10). Since then, several hundred experimental and tens of theoretical studies have been published describing the structural and functional properties of ion channels expressed in pituitary cells and their roles in spontaneous and receptor-controlled electrical activity, Ca^{2+} signaling, and secretion. In this review, we summarize novel findings on expression, signaling functions, and regulation of ion channels in endocrine pituitary cells.

II. Pituitary Cell Types

The adenohypophysis and neurohypophysis develop from two distinct embryological sources. During craniofacial development, separation of the neuroepithelium (which will become the brain) and the surface ectoderm (which will become the oral epithelium) occurs everywhere except in the middle region forming Rathke's pouch. The neurohypophysis is derived from the neuroepithelium and originates at the base of the diencephalons. Rathke's pouch separates from the oral epithelium and forms the adenohypophysis (Fig. 1, *inset*). Initially, Rathke's pouch forms a closed epithelial structure with the lumen. Soon after, the

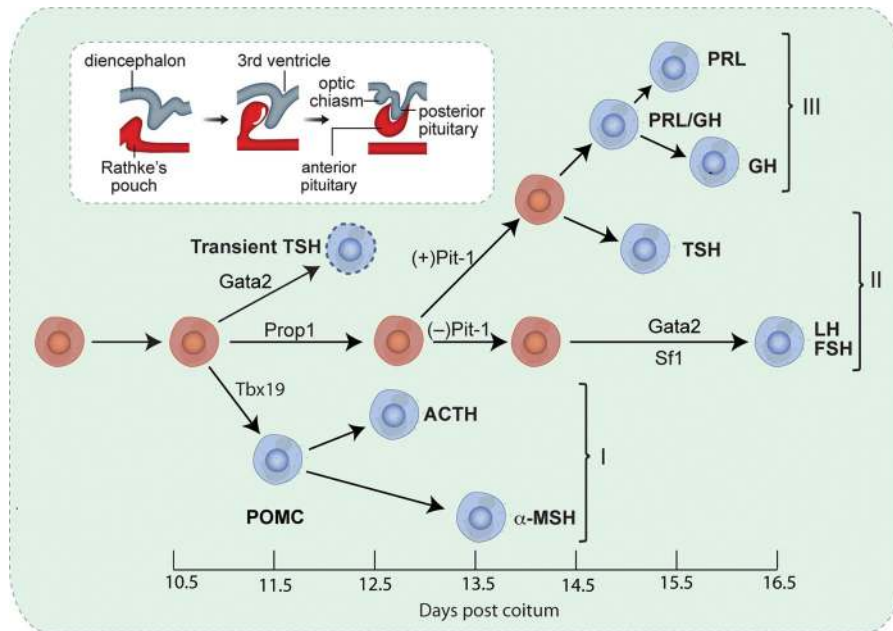

FIG. 1. Schematic representation of pituitary gland development. *Inset*, Formation of Rathke's pouch and early pituitary development. *Gray areas*, Neuroepithelium; *red areas*, oral epithelium. *Main panel*, Cell lineage development and selected transcriptional factors involved during mouse pituitary organogenesis. Prop-1 and Pit-1, Pituitary-specific transcription factors; Sf1, steroidogenic factor-1; GATA2, zinc finger transcription factor; Tbx19 (or Tpit), member of the T-box family of transcription factors; I, POMC-producing cells; II, α -GSU-producing cells; and III, PRL/GH-producing cells.

cells from the ventral side of the pouch leave and proliferate to form the nascent anterior lobe, whereas a more limited development of the dorsal wall gives rise to the intermediate lobe. Proliferation is accompanied by the epithelium-mesenchyme transition, with the pituitary-specific transcription factors, Pit-1 (also called Pou1f1) and prophet of Pit-1 (Prop-1) playing important roles in this transition. This stage is closely associated with the initiation of the cell differentiation program (11).

It appears that cell-to-cell contact with the primordial neuroepithelium of the ventral hypothalamus is a critical factor in the differentiation of anterior pituitary cells. The hormone-secreting cells differentiate in a temporal- and spatial-specific fashion under the influence of various transcriptional factors (Fig. 1). In mouse, the expression of the glycoprotein hormone α -subunit (α -GSU) gene is the earliest marker of anterior pituitary differentiation, occurring at embryonic d 11.5 of gestation. Thyrotrophs, somatotrophs, and lactotrophs arise through a common cell lineage determined by Prop-1 and Pit-1 (also known as Pou1f1) transcriptional factors, and mutations of these genes are a cause of combined pituitary hormone deficiency of GH, PRL, and TSH. Terminal differentiation of corticotrophs and melanotrophs is dependent on the T-box transcriptional factor Tbx-19, also known as Tpit. In contrast, Tbx-19 is a negative regulator of the gonadotropic and Pit-1-independent rostral type of thyrotrophs. Steroidogenic factor-1 and the zinc finger transcriptional factor GATA-2 appear to be important positive regulators of gonadotroph differentiation (11–14). Consistent with

this developmental pattern, lactotrophs, gonadotrophs, somatotrophs, and thyrotrophs express neurofilaments NS-68, whereas cells of proopiomelanocortin (POMC) lineage lack the expression of this protein (15, 16).

A. POMC-producing cells

The *POMC* gene is highly expressed in corticotrophs and melanotrophs and is transcribed by the pituitary promoter P1 to an approximately 1200 nucleotide *POMC* mRNA transcript. In mammals, *POMC* is posttranslationally modulated by intracellular proteolytic cleavage into an N-terminal peptide, ACTH (1-39) and β -lipotropic hormone in corticotrophs, and into α -MSH, γ -lipotropic hormone, and β -endorphin in melanotrophs. This specific processing of *POMC* is due to differential expression of prohormone convertases in the two cell types. Corticotrophs only express prohormone convertase-1, which cleaves at a limited number of sites on the *POMC* prohormone, whereas melanotrophs express prohormone convertase-1 and -2 and more extensively cleave *POMC* at a number of sites during biosynthesis (17, 18).

Corticotrophs are the first anterior pituitary cells to differentiate during embryonic development; they are derived from the intermediate pituitary but are scattered throughout the anterior lobe in adult animals (Fig. 1). It has been reported that these cells comprise 2 to 15% of AP cells in rats. The large range could reflect age and sex, and also the methods used for identification. The main control of ACTH release is mediated by CRH, which is secreted by paraventricular neurons that project to the median emi-

nence and release CRH into the hypophyseal portal system. In corticotrophs, CRH binds to G_s -coupled CRH receptors and facilitates spontaneous electrical activity and ACTH release. In addition to CRH and the CRH family of peptides (urocortin 1-3), arginine vasopressin (AVP) directly stimulates ACTH release and acts in synergy with CRH to potentiate ACTH release (19). Glucocorticoid receptors are expressed in corticotrophs and CRH neurons and contribute to negative feedback actions of glucocorticoids on ACTH secretion (20). There is one corticotroph mouse cell line available, called AtT-20 cells. Like corticotrophs in primary culture, AtT-20 cells synthesize POMC and have been extensively used to study the processing of POMC. These cells can also package ACTH into secretory vesicles and were originally used to define the constitutive and regulated secretory pathways. These cells express glucocorticoid, somatostatin, IL-1, dopamine, histamine H_3 , and muscarinic cholinergic receptors (21).

Melanotrophs are the only secretory cells present in the intermediate lobe and account for more than 95% of the cells found in this lobe. In contrast to the anterior pituitary, which is richly vascularized, the intermediate lobe contains very few blood vessels but is supplied by nerve fibers originating from the hypothalamus. Mammalian melanotrophs are electrically excitable cells, and spontaneous electrical activity is sufficient to trigger release of POMC-derived peptides. Such secretion is primarily regulated by dopaminergic neurons that originate in the mediobasal hypothalamus and directly innervate the intermediate lobe. Dopamine tonically inhibits the synthesis and release of POMC peptides by activating D_2 receptors, leading to inhibition of electrical activity and Ca^{2+} signaling. Connections between dopamine-secreting neurons and the intermediate lobe in rats are established during the first postnatal week (22). Mammalian melanotrophs also express GPCRs for γ -aminobutyric acid (GABA) (23), prostaglandin E_2 (24), and serotonin (5-hydroxytryptamine; 5-HT) (25), whereas frog melanotrophs also express receptors for TRH, neuropeptide Y (26), acetylcholine (27), and adenosine (28). Cells from the melanotroph cell line mL39 express POMC and dopamine D_2 receptors and thus could represent a good cell model for studies on dopaminergic regulation of melanotroph functions (29).

B. Heterodimeric glucoprotein-producing cells

Thyrotrophs and gonadotrophs express the 92-amino acid-long α -GSU, which is needed for the formation of TSH, FSH, and LH (and also chorionic gonadotropin) heterodimers with hormone-specific β -subunits. Thyrotrophs are the smallest subpopulation of anterior pituitary cells, representing less than 10% of cells in the gland, and are regionally localized within the anteromedial and lateral portions of the gland. The β -TSH subunit containing

110 amino acids is unique for thyrotrophs and confers specificity of biological actions. TSH is packed into secretory vesicles, which are small (50–100 nm in diameter). The hypothalamic control of thyrotrophs is mediated by TRH, which is released by neurons localized in the hypothalamic paraventricular nucleus. TRH acts as an agonist for $G_{q/11}$ -coupled TRH receptors expressed in thyrotrophs and lactotrophs. In thyrotrophs, TRH stimulates TSH release, as well as the transcription of both α - and β -subunits, whereas T_4 and T_3 suppress transcription. The feedback regulation occurs primarily in the pituitary (30). Somatostatin and dopamine have small suppressive effects in TSH-secreting tumors. Secretion of TRH is also controlled by numerous autocrine and paracrine factors, including endothelins (ETs) acting on ET_A receptors (31). There are two thyrotroph cell lines: α -TSH cells, secreting the α -subunit and missing some of the Pit-1 transcript isoforms; and $T\alpha T$ -1 cells, expressing both α - and β -subunits and the transcriptional factor Pit-1 (21).

Gonadotrophs constitute about 10–15% of the anterior pituitary cell population and are localized throughout the anterior lobe, frequently adjoining lactotrophs. They secrete the gonadotropins LH and FSH, which are packed in secretory vesicles of about 200 and 500 nm in diameter, respectively. The decapeptide GnRH is the main agonist for these cells. GnRH-secreting neurons are dispersed within the mediobasal hypothalamus and preoptic areas, but organize functionally as a pulse generator, delivering GnRH in portal blood every 30 min in rodents; this release is influenced by numerous factors, including the age and gender of the animals, and the stage of the estrous cycle (32). In gonadotrophs, GnRH binds to $G_{q/11}$ -coupled GnRH receptors, leading to the release of both LH and FSH in a pulsatile manner (33). GnRH also affects FSH β and LH β transcription (34, 35). In addition to GnRH receptors, gonadotrophs also express functional receptors for pituitary adenylyl cyclase-activating peptide (PACAP) (36), ETs (37), AVP (38), and substance P (39), which contribute to gonadotropin synthesis and secretion. Inhibins, activins, and follistatin are important regulators of gonadotropin synthesis and secretion. Sex steroids exert negative feedback on gonadotropin release via GnRH neurons and directly at the pituitary level; estradiol can also exert a positive action on pituitary gonadotrophs (40, 41).

There are four mouse cell lines developed by Mellon and colleagues (42, 43): $\alpha T1$ -1, $\alpha T3$ -1, $L\beta T2$, and $L\beta T4$. The $\alpha T1$ -1 is not a gonadotroph cell line but rather is an anterior pituitary precursor cell line that expresses α -GSU and probably represents a progenitor for the thyrotroph and gonadotroph lineages. The $\alpha T3$ -1 cell type represents a later stage in cell differentiation, corresponding to the early embryonic gonadotroph cell lineage. It expresses

GnRH receptors and α -GSU, which is secreted in a constitutive manner, but does not express LH β and FSH β . These cells were used to clone the GnRH receptor and were extensively used for studies on GnRH- and PACAP-dependent signaling and gene regulation as well as the roles of various homeobox genes in pituitary cell differentiation. The L β T2 and L β T4 cells have more mature gonadotroph phenotypes because they express LH β and FSH β -subunits, as well as steroidogenic factor-1 and GnRH receptor (for references, see Ref. 21).

C. GH- and PRL-producing cells

A fraction of anterior pituitary cells, known as mammosomatotrophs, secrete both GH and PRL and are probably transitional cells capable of becoming somatotrophs or lactotrophs (Fig. 1). Somatotrophs are the most common cell type in the anterior pituitary, representing up to 50% of cells, and are localized predominantly in the lateral portions of the anterior lobe. They synthesize GH, a single-chain polypeptide containing 191 amino acids, which is packed into secretory vesicles of variable sizes. Two hypothalamic neuropeptides, GHRH and somatostatin, play major roles in the control of GH synthesis and release. GHRH is a 44-amino acid peptide secreted by neurons in the arcuate nucleus of the hypothalamus that acts as a native agonist for GHRH receptors. These receptors are coupled to the G_s signaling pathway (44). Somatostatin is a 14-amino acid neuropeptide that is secreted by neurons in the periventricular nucleus of the hypothalamus and is delivered to pituitary cells by a portal vascular system. It binds to receptors coupled to the G_{i/o} signaling pathway (45). These cells also express receptors for ghrelin (46), PACAP (47), and ETs (48).

PRL is a single-chain protein of 198 amino acids that is similar in structure to GH. It is synthesized and released by lactotrophs, which account for 10–25% of pituitary cells. This is a nonhomogeneous group of cells (some have large and irregular dense-core vesicles, and others have small round vesicles) that secrete PRL due to spontaneous electrical activity. These cells can be separated into subpopulations based on morphology (49) or density (50). Consistent with the high basal level of PRL secretion, the predominant hypothalamic influence is inhibitory rather than stimulatory and is mediated by dopamine D₂ receptors coupled to the G_{i/o} signaling pathway (51). These cells also express ET_A receptors, which transiently stimulate PRL release, followed by sustained inhibition (52, 53). On the other hand, TRH, angiotensin II, oxytocin, ATP, acetylcholine, and 5-HT stimulate PRL release (54). Estrogens stimulate PRL gene transcription and secretion, and prolonged estrogen treatments lead to an increase in the number of lactotrophs (55).

There are several cell lines that secrete GH, PRL, or both hormones. GH₃ cells produce PRL and GH and ex-

press TRH, vasoactive intestinal polypeptide (VIP), and epidermal growth factor receptors but not dopamine D₂ receptors. GH₄C₁ cells are derived from GH₃ cells and produce only PRL. Both cell types have been very useful in the characterization of electrical activity and the channels involved. There are four MtT cell lines; among them, MtT/S cells are pure somatotroph cell lines expressing high levels of GH and GHRH receptors, whereas MtT/SM are mammosomatotrophs. On the other hand, the 235-1 lactotroph cell line has the PRL gene, but not the GH gene. These cells do not express TRH and D₂ receptors, but secrete PRL in a Ca²⁺-dependent manner. The MMQ cells also secrete PRL only in a Ca²⁺-dependent manner, but in addition express functional D₂, ET_A, and oxytocin receptors and thus could be used for studies on the receptor-controlled electrical activity and secretion (21).

D. Nonsecretory cells

Folliculostellate cells from the anterior lobe are derived from the neuroectodermal cells and are nonendocrine cells devoid of secretory granules. These cells express the neuronal marker S-100 protein and glial fibrillary acidic protein, reflecting their neuroectodermal origin. It has also been suggested that folliculostellate cells develop from marginal layers of the pars tuberalis and pars intermedia. Although they represent only 5–10% of the anterior pituitary cells and are sparsely distributed within the gland, folliculostellate cells make a complex three-dimensional anatomical network extending over the whole gland. It has been suggested that these cells express gap junction channels and play important roles in intercellular communication (56, 57). There are several folliculostellate cell lines, including human PDFS cells, mouse TtT/GF and Tpit/F cells, and rat FS/D1 h cells. Like native cells, these immortalized cells also express muscarinic acetylcholine, β -adrenergic and PACAP receptors positively coupled to cAMP production, and Ca²⁺-mobilizing angiotensin II receptors (21).

Pituicytes constitute approximately 30% of the posterior pituitary volume, and are the only resident cells. It is well established that neurosecretory axons are capable of making synaptoid contacts with pituicytes. GABA-containing axons also terminate in synaptoid contacts either on pituicytes or the neurosecretory axons. Other neurons can make direct synaptoid contacts with pituicytes. These cells express receptors for GABA, as well as for AVP, κ -opioid, nucleotides, atrial natriuretic peptide, 5-HT, bradykinin, angiotensin II, and ETs. Cultured pituicytes express several Ca²⁺-mobilizing receptors, the activation of which leads to the generation of Ca²⁺ waves, either through gap junctions that are expressed in these cells or via the release of ATP and activation of purinergic receptors. Pituicytes also express IL-1 receptors and release IL-6. Such a complex expression pattern of receptors indicates that released neurohormones can act on

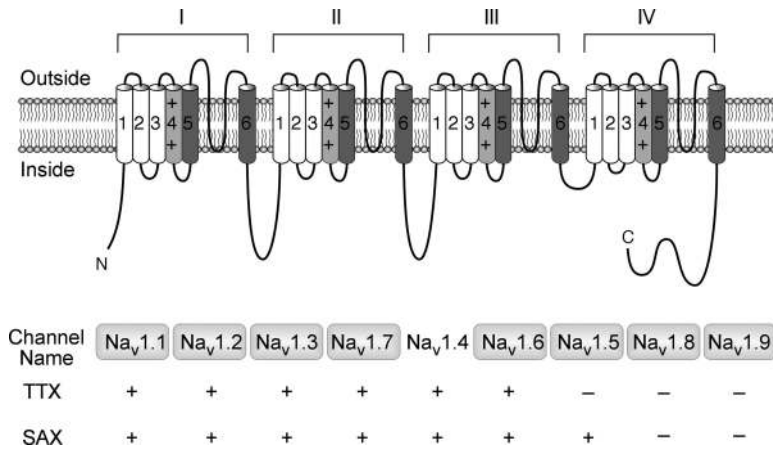

FIG. 2. Na_v and Ca_v channels. *Top*, Structural TM folding model of Na_v and Ca_v channels. In this and the following models, α -helices are illustrated as *cylinders* and the extracellular and intracellular chains of amino acids as *continuous lines*. The positively charged 4S domain illustrates the voltage sensor, and the S5 and S6 domains contribute to the formation of the channel pore. *Bottom*, TTX and saxitoxin (SAX) sensitivity of Na_v- α subunits. *Rectangles* show the subunits whose presence was identified in pituitary cells at the mRNA level. TTX-sensitive Na_v currents have been identified in all endocrine pituitary cells.

pituitocytes (58). The physiological role of activated pituitocytes is unknown, but they could trigger release of various neuroactive substances and influence the release of AVP and oxytocin. For example, it is known that ATP released by pituitocytes activates purinergic receptor channels expressed in vasopressinergic terminals and stimulates hormone release (59, 60).

III. Ion Channels Expressed in Pituitary Cells

A. Voltage-gated channels

Functional analysis, homology cloning, and the sequencing of genomes of several species have revealed that voltage-gated channels are one of the largest groups of signal transduction proteins. These channels have been classified into two major subgroups: a superfamily of more than 140 members of voltage-gated cation channels that share structural similarity; and a small family of structurally different voltage-gated chloride channels. The superfamily of voltage-gated channels includes sodium (Na_v) (Fig. 2), calcium (Ca_v) (Figs. 2 and 3), and potassium (K_v) channels (Figs. 4–6), as well as numerous less selective channels. These channels are composed of the pore-forming α -subunits and auxiliary subunits. The α -subunits of Na⁺ channels and Ca²⁺ channels have similar amino acid sequences and folding, whereas the pore-forming subunit of K⁺-channels is smaller, but with obvious homology to Na⁺ and Ca²⁺ channels. In cation-selective channels, the part of the pore known as the ionic selectivity filter is able to distinguish among Na⁺, Ca²⁺, and K⁺. The majority of voltage-gated channels contain voltage sensors, charged transmembrane (TM) helices or segments (S) that

sense the electrical field in the membrane and drive conformation changes, leading to opening and closing of the gates near the mouth of the pore (61).

Combined pharmacological, electrophysiological, and molecular biology experiments have revealed that there is a high diversity of K_v channels, whereas Ca_v and Na_v channels are less diverse. Among voltage-gated channels, the structures of inwardly rectifying K⁺ (K_{ir}) channels and bacterial K⁺ channels, known as KcsA, are the simplest. The α -subunit of these channels is a tetramer, each monomer of which contains two TM segments (S), with a reentry P loop in between (Fig. 4). The primordial members of the voltage-gated cationic channel superfamily were probably 2TM domain K⁺ channels.

The K_{2P} channels are known as leak K⁺ channels, and these channels have two P loops and 4TM domains, a topology similar to a tandem fusion of two K_{ir} channels. These channels do not have a voltage sensor. The K_v channel α -subunit monomer contains the two TM segments found in K_{ir} channels plus an additional four TM segments (Fig 5). Cyclic nucleotide-gated (CNG) channels, hyperpolarization-activated and cyclic nucleotide-modulated (HCN) channels, transient receptor-potential (TRP) channels, and some members of Ca²⁺-activated K⁺ channels (K_{Ca}) also have this type of architecture (Figs. 6 and 7). Like K_{ir} channels, all 6TM domain channels are homo- or heterotetramers of principal subunits, fre-

Voltage Dependence	Currents	Previous Name	Current Name	Defining Blockers
HVA	L	α_{1S}	Ca _v 1.1	DHP
		α_{1C}	Ca _v 1.2	DHP
		α_{1D}	Ca _v 1.3	DHP
		α_{1F}	Ca _v 1.4	DHP
LVA	N P/Q R	α_{1A}	Ca _v 2.1	IVA
		α_{1B}	Ca _v 2.2	GVIA
		α_{1E}	Ca _v 2.3	SNT
LVA	T	α_{1G}	Ca _v 3.1	Kurtoxin
		α_{1H}	Ca _v 3.2	Kurtoxin
		α_{1I}	Ca _v 3.3	—

FIG. 3. Classification of Ca_v channel α -subunits. HVA, High-voltage activated; LVA, low-voltage activated; DHP, dihydropyridines; IVA, w-agatoxin; GVIA, w-conotoxin; SNT, SNK-482. HVA and LVA currents have been detected in all endocrine pituitary cells. *Rectangles* indicate the mRNA transcripts for Ca_v- α subunits in pituitary cells. Immunocytochemical studies showed the presence of Ca_v1.1, 1.2, 1.3, 2.1, 2.2, 2.3, and 3.1- α subunits in these cells.

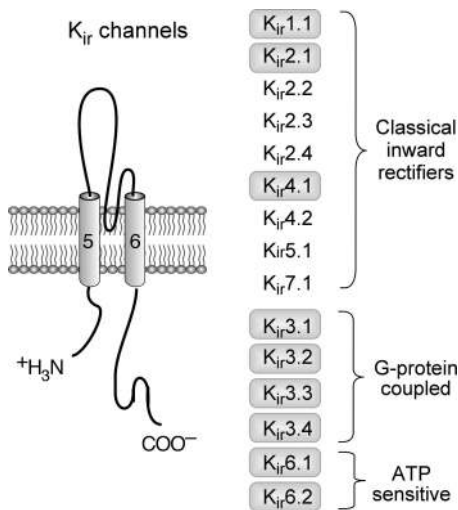

FIG. 4. K_{ir} channels play important roles in the control of resting membrane potential and agonist-induced inhibition of spontaneous electrical activity in pituitary cells. *Left*, Structural TM folding model of K_{ir} channels. *Right*, The 15 known members of K_{ir} channels are divided into three groups, based on their regulation. *Rectangles* indicate K_{ir}-α subunits identified in pituitary cells. The presence of K_{ir}3.1 and 3.2 has also been confirmed by Western blot analysis.

quently associated with auxiliary β-subunits. The 6TM domain of these channels is doubled in the two pore channels and quadrupled in Na_v and Ca_v channels. In all of these channels, the 4S in the 6TM domain serves as a voltage sensor, whereas the pore loop between 5S and

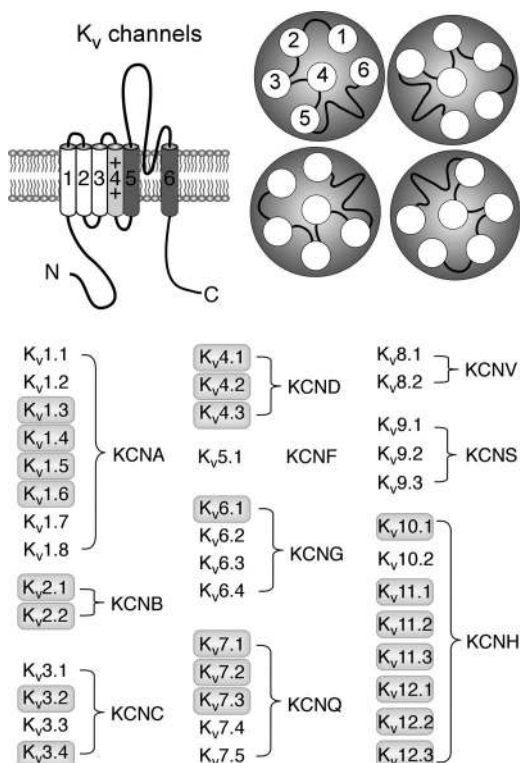

FIG. 5. K_v channels reduce excitation in pituitary cells. *Top*, Structural TM folding model of K_v channels (*left*) and tetrameric organization of α-subunits (*right*). *Bottom*, Families of K_v channels. *Rectangles* indicate K_v-α subunits for which mRNAs were identified in pituitary cells.

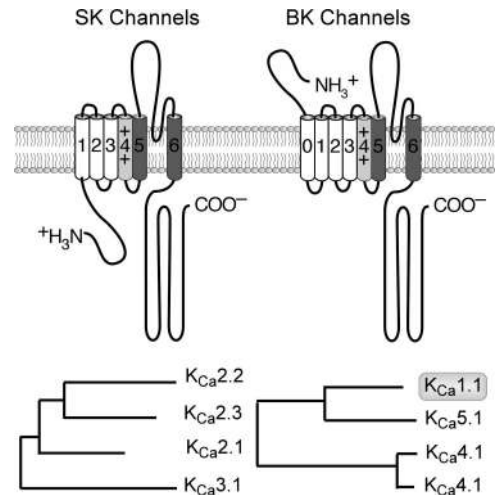

FIG. 6. Two types of K_{Ca} channels are expressed in pituitary cells. *Top left*, SK channels have similar TM organization as K_v channels, but are not voltage-regulated. *Top right*, BK (maxi) channels have an additional TM domain (S0) and are regulated by both voltage and calcium. *Bottom*, Phylogenetic tree for K_{Ca} channels. The K_{Ca}1.1 mRNA transcript was found in pituitary cells, and the presence of SK and BK currents in pituitary cells was confirmed using specific blockers of these channels.

6S in each domain determines ion conductance and selectivity (61, 62).

1. Voltage-gated Na⁺ channels

Mammals express nine genes for the Na⁺ channel α-subunit, termed Na_v1.1–Na_v1.9, and closely related Na⁺ channel-like proteins (Na_x) with approximately 50% structure similarity with Na_v1 channels. The α-subunit contains four homologous domains, each consisting of a 6TM domain and a reentry P loop between 5S and 6S, which contains the tetrodotoxin (TTX) binding site, a voltage gate and sensor, and contains the sites for phos-

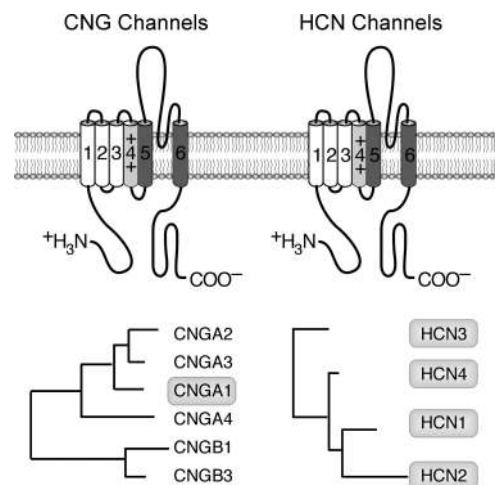

FIG. 7. Cyclic nucleotide-modulated channels are nonselective cation channels. *Top*, Structural TM folding model of CNG channels and HCN channels. *Bottom*, Phylogenetic tree of CNG and HCN channels. The mRNA transcripts for all four HCN α-subunits and CNGA1 α-subunit were identified in pituitary cells, as well as the functional HCN current.

phorylation by protein kinases on the intracellular surface. Na_v 1.5, 1.8, and 1.9 are TTX insensitive (Fig. 2). Four auxiliary subunits have been identified so far, termed $\text{Na}_v\beta_1$, $\text{Na}_v\beta_2$, $\text{Na}_v\beta_3$, and $\text{Na}_v\beta_4$. They belong to a single family of proteins, which interact with different α -subunits and alter their physiological properties. The main function of Na_v channels is to depolarize cells and generate the upstroke of the AP, controlling the firing amplitude in excitable cells, including nerve, muscle, and neuroendocrine cell types. In some cells, these channels are solely responsible for the rapid and regenerative upstroke of an AP. In others, they act in conjunction with Ca_v channels to depolarize cells. Na_v channels are also expressed in non-excitable cells at a lower level, where their physiological role is unclear (63).

The expression of TTX-sensitive and -insensitive Na_v channels has been extensively studied in endocrine pituitary cells. Electrophysiological experiments revealed that both freshly dispersed and cultured melanotrophs express functional channels composed of TTX-sensitive and TTX-resistant components (64, 65). Single-cell Ca^{2+} measurements further indicated the presence of functional Na_v channels in frog melanotrophs (66, 67). The TTX-sensitive current has also been identified in rat (68–70), mouse (71), ovine (72, 73), and fish (74, 75) gonadotrophs, as well as in $\alpha\text{T3-1}$ mouse gonadotrophs (76, 77). The presence of functional Na_v channels in gonadotrophs was recently confirmed using mice pituitaries with genetically labeled gonadotrophs (78). Rat lactotrophs (79, 80), somatotrophs (70), corticotrophs (68), and GH_3 cells (81), and fish lactotrophs (82) also express Na_v channels. GH_3 cells were frequently used as a cell model to study the gating properties of Na_v channels (83, 84). Thus, it is reasonable to conclude that Na_v channels are native to all secretory pituitary cells.

There has also been progress in identifying the mRNA transcripts for Na_v subunits in pituitary cells in various physiological conditions influencing the expression of these channels. Rat melanotrophs express mRNA transcripts of seven α -subunits, including the TTX-insensitive Na_v 1.8 and 1.9 subunit mRNAs and β_1 and β_2 auxiliary subunit mRNAs (65). The mRNA transcripts for the α -subunit of Na_v 1.1, Na_v 1.2, Na_v 1.3, and Na_v 1.6, as well as β_1 - and β_3 -subunits of Na^+ channels, are present in GH_3 cells (85). The expression of the Na_v 1.7- α -subunit in the rat anterior pituitary was confirmed by *in situ* hybridization and immunohistochemistry (86). Somatotrophs from GH -green fluorescent protein transgenic mice express mRNA transcripts for Na_v 1.5, 1.8, and 1.9, as well as the TTX-sensitive and TTX-resistant Na^+ current (87). It appears that the level of Na^+ channel expression is greater in cultured rat gonadotrophs than in soma-

totrophs and lactotrophs (70). The level of expression of Na_v channels in GH_3 cells is inhibited by glucocorticoids (81) and stimulated by long-term activation of the ghrelin-GH secretagogue receptor (88) and activation of L-type Ca_v channels (85). The role of these channels in electrical activity is summarized in *Section IV.C*.

2. Voltage-gated Ca^{2+} channels

Electrophysiologically, Ca_v channels are separated into two groups. The first group of channels is known as high-voltage-activated Ca_v channels because these channels require moderate to strong membrane depolarization to open. Among this group, biophysical and pharmacological studies have identified L-, N-, P/Q-, and R-type Ca^{2+} channels that are distinguished by their single-channel conductance, pharmacology, and metabolic regulation. The second group is known as low-voltage-activated Ca_v channels because they require less depolarization for activation and subsequent inactivation than high-voltage-activated channels, and a strong membrane hyperpolarization is required to bring them out of steady inactivation. Because of such gating properties, these channels are often referred to as transient or T-type Ca_v channels (Fig. 3). Purification of calcium channels has identified five subunits: a pore-forming large α_1 -subunit and four smaller ancillary subunits: α_2 , β , γ , and δ . Like α -subunits of Na_v channels, the α_1 -subunit of Ca_v channels consists of four homologous repeats, each consisting of a 6TM domain and a P-loop between 5S and 6S. In addition to the voltage sensor, gating machinery, and the channel pore, the α_1 -subunit also contains most of the known sites of channel regulation by intracellular messengers, drugs, and toxins, including $\text{G}\beta\gamma$ domains and multiple PKA phosphorylation sites (89).

Ca_v channels serve two major functions in cells: electrogenic and regulatory. In some neurons and many neuroendocrine cells, these channels give rise to APs in the same way as Na_v channels, although typically with slower kinetics and lower amplitude. In other neurons, Ca_v channels shape the Na^+ -dependent APs. The regulatory function of these channels is based on Ca^{2+} influx during the transient depolarization, which acts as an intracellular (second) messenger controlling a variety of cellular functions. During a short-term depolarization, Ca^{2+} entry through T-type channels constitutes a disproportionately large fraction of the total Ca^{2+} entry (90). Because T-type Ca_v channels exhibit rapid and complete voltage-dependent inactivation, however, they are unlikely candidates to promote Ca^{2+} influx of sufficient amplitude to generate global Ca^{2+} signals in neuroendocrine cells firing slow APs. The major function of these channels is electrogenic; at the resting potential, these channels depolarize cells to the threshold level for a Na^+ or Ca^{2+} spike. In contrast,

high-voltage-activated channels inactivate incompletely and help to keep the cells depolarized for a prolonged period. Such APs increase intracellular calcium concentration ($[Ca^{2+}]_i$) of sufficient amplitude to trigger Ca^{2+} -dependent processes (89, 91).

The functional expression of both inactivating and noninactivating Ca_v currents is well documented in rat (68–70, 92), ovine (93), and fish (75) gonadotrophs, as well as in genetically labeled mouse gonadotrophs (78) and α T-3 immortalized mouse gonadotrophs (76). These currents are also present in somatotrophs and lactotrophs (70, 94) and GH cells (95–97). In GH_3 cells, there are multiple conductance levels of the L-type Ca_v channels (98), and estrogens stimulate the expression of T-type channels (99). In the same preparation of rat anterior pituitary cells, it appears that Ca_v channels are more prominent in rat somatotrophs than in lactotrophs and gonadotrophs (70). Within the same subpopulation of cells, the expression of T-type Ca_v channels varies, as is well documented for lactotrophs (100). Mouse (101) and rat (102, 103) melanotrophs also express functional Ca_v channels. The properties of inactivating Ca_v channels are consistent with the expression of T-type Ca^{2+} channels, whereas the noninactivating Ca^{2+} current in pituitary cells is mediated by dihydropyridine-sensitive and -insensitive Ca_v channels (69, 92, 96, 104). The prominent expression of T-type Ca^{2+} channels in somatotrophs is reflected by their contribution to the generation of the high-amplitude $[Ca^{2+}]_i$ transients in spontaneously active cells, whereas L-type channels are essential to the generation of both spontaneous and agonist-induced electrical activity and Ca^{2+} signaling in pituitary cells (for details, see *Section IV*).

Progress has been made in the identification of Ca_v - α -subunit transcripts present in pituitary cells. The $Ca_v3.1$ and $Ca_v3.3$ mRNAs were detected in GH_3 cells exhibiting prominent T-type Ca^{2+} current (105). Several pore-forming subunits of Ca_v channels are present in GH_3/B_6 pituitary cells and account for the formation of T-type ($Ca_v3.1$), L-type ($Ca_v1.1$, 1.2, and 1.3), and P/Q ($Ca_v2.1$) type currents. The mRNA transcripts for β_1 , β_2 , and β_3 Ca_v subunits were also detected in these cells (95). Immunocytochemical analysis confirmed the expression of $Ca_v1.2$, 1.3, 2.2, and 3.1 α -subunits in mouse anterior pituitary cells (106). The disulfide-linked $\alpha 2\delta$ -subunit was cloned from human pituitary (107). An immunocytochemical study also suggested that pituitary cells express $Ca_v1.2$, 2.1, 2.2, 2.3, and 3.1 subunits (108). In GH somatotrophs, ghrelin and GH-releasing peptide-6 enhanced the expression of the $Ca_v1.3$ pore-forming α -subunit (109). In $L\beta T2$ gonadotrophs, leptin increases L-type Ca_v channel expression and GnRH-stimulated LH release (110). In guinea pigs, estrogen significantly increases the

mRNA expression of the $Ca_v3.1$ α -subunit in the pituitary and the hypothalamus, accompanied by an increase in the peak T-current, which could explain the stimulatory effects of estrogens on burst firing (111). This increase is dependent on the expression of estradiol receptor α (112). Because of their enormous physiological relevance (discussed in *Section IV.E*), it is reasonable to speculate that other hormones and neuropeptides affect the expression of Ca_v channels in pituitary cells and other excitable cells.

3. Inwardly rectifying K^+ channels

The term “inward rectifier” describes the activation of inward current under hyperpolarization, leading to K^+ influx, and almost no K^+ efflux under depolarization. Because of these unusual activation properties, these channels are also known as anomalous rectifiers. K_{ir} channels are expressed in numerous tissues, including brain, heart, kidney, endocrine cells, ears, and retina. They participate in the control of resting potential and are closed by a strong depolarization. There are 15 members of this family of channels that are divided into three groups, based on their regulation (Fig. 4). The majority of channel subtypes are “classical” K_{ir} channels that are controlled by intracellular messengers ($K_{ir}1$, 2, 4, 5, and 7). On the other hand, $K_{ir}3$ channels are regulated by G proteins and $K_{ir}6$ channels by intracellular ATP. The long cytoplasmic pore of these channels plays a critical role for inward rectification and provides the structural basis for modulation of gating by G proteins and phosphatidylinositol 4,5 bisphosphate (PIP_2) (113).

G protein-regulated K_{ir} channels are present in endocrine pituitary cells. In rat pituitary lactotrophs, K_{ir} currents are activated by dopamine (114) and ETs (115), whereas in somatotrophs they are activated by somatostatin (116) and ETs (48). AtT-20 corticotrophs also express K_{ir} channels activated by G protein-coupled somatostatin and muscarinic receptors (117–120). The G protein dependence of activation of K_{ir} currents in AtT-20 cells and human GH-secreting adenoma cells was shown by downregulation of their expression by antisense oligonucleotides (121, 122). Consistent with the G protein-dependent K_{ir} currents, RT-PCR analysis showed the presence of $K_{ir}3.1$, 3.2, and 3.4 mRNA transcripts in female rat pituitary cells (123), and $K_{ir}3.1$ –3.4 mRNA transcripts in GH_3/B_6 mammosomatotrophs (124). The presence of $K_{ir}3.1$ and 3.2 proteins in AtT-20 cells was also confirmed by Western blot analysis (118). For details on the role of these channels in receptor-controlled electrical activity see *Section VII.B*.

Other members of this family of channels are also expressed in pituitary cells but were only partially characterized. In GH_3 cells, constitutively active K_{ir} channels play an important role in the maintenance of the resting

membrane potential (125, 126). These channels are inhibited by activation of the TRH receptor, presumably through their cross-coupling to the G_s signaling pathway (127). TRH also inhibits K_{ir} channels in lactotrophs from lactating rats (128). In ovine somatotrophs, GH-releasing peptide-2 reduces K_{ir} current via the PKA-dependent signaling pathway (129). The presence of ATP-sensitive K^+ channels in pituitary cells has also been reported (130). RT-PCR analysis revealed the presence of K_{ir} 1.1, 2.2, 4.1, 6.1, and 6.2 mRNA transcripts in GH_3/B_6 cells (124). Further studies are required for identification of classical and ATP-regulated K_{ir} channels in native pituitary cells and their roles in spontaneous and receptor-stimulated electrical activity and Ca^{2+} signaling.

4. Voltage-gated K^+ channels

Electrophysiological studies have revealed that at least four functional classes of K_v channels exist: fast or rapidly activating delayed rectifier, slow delayed rectifier (including M channels), A-type K^+ channels, and EAG (ether-a-go-go gene) channels. The fast delayed rectifier is expressed in unmyelinated axons, motoneurons, and fast skeletal muscle, and is responsible for very short APs. Slow delayed rectifier channels are expressed in cardiac tissue and are also involved in cell repolarization. As indicated by their name, the gating kinetics of these channels is slow and the channels are noninactivating, which is reflected in the shape of APs. A-type channels show rapid and transient activation in the subthreshold range of membrane potential, fast inactivation and fast recovery from inactivation. These channels contribute to the regulation of firing frequency in cardiac and other excitable tissues. Tetraethylammonium blocks delayed rectifier channels, but it is much less effective in blocking A-type channels. 4-Aminopyridine blocks A-type channels in a millimolar concentration range and delayed rectifier channels in a micromolar concentration range (131). There are three subfamilies of EAG channels: eag, eag-like (elk), and eag-related (erg). Among them, the erg channels are the best characterized. They are expressed in heart, neuroblastoma cells, smooth muscle cells, and neuroendocrine cells and are selectively blocked by E-4031. Like K_{ir} channels, erg channels also have inward-rectifying properties and contribute to the maintenance of the resting potential (132).

Molecular studies have identified a large number of pore-forming α -subunits of K_v channels, which are classified into several groups or subfamilies based on sequence similarities (Fig. 5). This diversity allows for the generation of many subtypes of K_v channels. Formation of heterotetramers between different subunits within the K_v 1, 7, and 10 families, as well as the presence of β -subunits and modifier subunits (K_v 5, 6, 8, and 9), further increases diversity of this group. The coding regions of K_v 3, 4, 6, 7, 9,

10, and 11 gene families are made up of several exons that are alternatively spliced, leading to a further increase in functional diversity (133). It is likely that K_v 1.4, 3.3, 3.4, 4.1, 4.2, and 4.3 contribute to the formation of A-type channels (133, 134). The M-channel is made up of several subunits from the K_v 7 (KCNQ) family of α -subunits, and the voltage-dependent activity of this channel is modulated by PIP_2 (135). The members of K_v 1, 2, and 3 contribute to the formation of the fast activating delayed rectifier, and the members of K_v 10, 11, and 12 generate various EAG channels, including the erg1 channel expressed in cardiac tissues (133).

Qualitative RT-PCR analysis revealed that GH_3/B_6 pituitary cells express mRNA transcripts for K_v 1.3, 1.4, 1.6, 2.1, 2.2, 3.2, 3.4, 4.1, 4.2, 4.3, 6.1, 7.1, 7.2, 7.3, 10.1, 11.1–11.3, and 12.1–12.3 (124). Others reported about the expression of K_v 1.5 in pituitary cells (136). There is also evidence that K_v expression is modulated by hormonal status. Glucocorticoid injection *in vivo* increases 8-fold the amount of K_v 1.5 mRNA in rat pituitaries (137). The increase in K_v 1.5 (but not K_v 1.4) expression is associated with an increase in a noninactivating component of the K_v current in GH_3 cells (138). Interestingly, both depolarization and TRH application reduces K_v 1.5 expression in GH_3 cells, increasing cell excitability (136, 139). Thus, hormonal and physiological status can dynamically alter the excitability of pituitary cells on a time scale of hours.

Electrophysiological experiments confirmed the presence of delayed rectifier current in GH cells (96, 140–142) and their regulation by GHRH (143). This current is also present in native rat lactotrophs and somatotrophs (70, 144–146). Mouse α T3-1 gonadotrophs (76), and native goldfish (75), rat (70), and ovine (147) gonadotrophs also express delayed rectifiers, and estrogens transiently increase the expression of these channels (147). Other fish pituitary cell types also have these channels (74, 148). The potential role of delayed rectifier K^+ channels in electrical activity was examined in various pituitary cells. In GH_3 cells, inhibition of this channel by tetraethylammonium increases the duration of the AP (149) and the amplitude of the spontaneous $[Ca^{2+}]_i$ transients (125), whereas in native rat lactotrophs, tetraethylammonium does not alter the pattern of AP firing (149). In frog melanotrophs, adenosine potentiates the delayed rectifier K^+ conductance, leading to inhibition of electrical activity (150).

A-type K_v channels are also expressed in the majority of secretory pituitary cells. They were identified in GH_3 mammosomatotrophs (142) and α T3-1 gonadotrophs (76). Native fish (74, 75, 148), frog (150), and rat (70, 144, 145) pituitary cells also express A-type K_v channels. In frog melanotrophs, adenosine potentiates these chan-

nels (151). Direct comparison of rat lactotrophs, somatotrophs, and gonadotrophs indicates that the expression level of the A-type K_v channels is much higher in lactotrophs and gonadotrophs than in somatotrophs (70). In contrast, high levels of expression of these channels have been observed in ovine somatotrophs and may contribute to the regulation of AP firing and hormone secretion (152). The participation of the A-type K^+ channel in regulating AP firing in other anterior pituitary cell types is unclear. In rat lactotrophs, for example, they do not appear to participate in AP generation (149), which may be due to their prominent inactivation at the resting membrane potential in these cells.

The M-type K^+ current has also been identified in lactotrophs, where it is inhibited by TRH, leading to an increase in the firing frequency during sustained stimulation (153). The M-type current resembles one generated by erg channels (154), which are also expressed in GH mammosomatotrophs and native rat lactotrophs (155). Blockade of erg channels by E-4031 causes depolarization of the membrane potential of about 5 mV, facilitating the release of PRL (156). In our hands, E-4031 did not alter basal PRL release in perfused pituitary cells measured by RIA, in contrast to Cs^+ in concentrations that inhibit K_{ir} channels (157). Erg channels are inhibited by TRH through an unidentified intracellular messenger (155, 158). TRH was also able to inhibit erg1, erg2, and erg3 channels, as well as human erg, when expressed in HEK293 cells (159). Erg currents are also expressed in MMQ lactotrophs, and their blockade facilitates AP firing and PRL secretion (160). Functional channels were identified in mouse gonadotrophs, and GnRH inhibits these channels through a still uncharacterized signal cascade (161). Human PRL-secreting tumors also express human erg, and they are functionally coupled to PRL secretion (162).

5. Calcium-activated K^+ channels

K_{Ca} are the third major group of K^+ channels and are composed of two families (Fig. 6). One family of these channels includes three small-conductance [calcium-activated small K^+ channels (SK)] channels ($K_{Ca}2.1$, 2.2, and 2.3) and one intermediate-conductance channel ($K_{Ca}3.1$). Splice variants have also been identified for SK channel genes. These channels have a general topology similar to that of K_v channels but show little voltage dependence and are activated by Ca^{2+} entering through Ca_v channels and released from intracellular stores, but they are not tightly coupled to Ca^{2+} channels. SK channels use calmodulin constitutively bound to the C terminus of each α -subunit as a high-affinity Ca^{2+} sensor (163, 164). The high-conductance K^+ [calcium-activated big K^+ channels (BK)] channels represent the other family of K_{Ca} channels, only distantly related to SK and intermediate-conductance

channels. BK channels are composed of four pore-forming $K_{Ca}1.1$ α -subunits that share the 6TM topology of K_v channels but contain an additional TM segment at the N terminus, termed S0 (Fig. 6). Alternative splicing of the RNA produces numerous transcripts, resulting in channels exhibiting distinct functional properties. BK channels are activated by voltage, and their open probability is modulated by Ca^{2+} . In contrast to SK channels, BK channels form macromolecular complexes with Ca_v channels and establish a prototypic Ca^{2+} nanodomain. This provides an effective mechanism for control of activity of these channels by Ca^{2+} influx through Ca_v channels. Calcium activation of BK channels is not dependent on calmodulin but is mediated by cation binding sites in the C termini of channel α -subunits (165). The gating properties of these channels are influenced by auxiliary β -subunits. BK channels are blocked by charybdotoxin, iberiotoxin, and paxilline (164, 166).

There are several reasons why K_{Ca} channels are incorporated into the Ca^{2+} signaling pathway. The colocalization of BK and Ca_v channels facilitates spike repolarization, which limits AP-driven Ca^{2+} influx. BK channel activation can also influence the frequency of AP-driven $[Ca^{2+}]_i$ transients by slowing the pacemaker depolarization. Activation of these channels may relieve the steady inactivation of Na_v and Ca_v channels, which stimulates or enhances AP generation in some cells. BK channels may also play a role in the generation of the pseudo-plateau bursting type of electrical activity in pituitary cells (see Section IV.D). Such diverse effects on AP firing probably depend on the type of K_{Ca} channels expressed and the context of other channels (167). Activation of K_{Ca} channels and the resulting membrane hyperpolarization may also serve to synchronize electrical activity and secretion in cell networks and electrical activity and Ca^{2+} release through IP_3 receptors (IP_3Rs) (168).

Both BK and SK channels are operative in endocrine pituitary cells. SK currents were initially identified in GH cells and had magnitude of less than 20% that of Ca_v current (169, 170) and about 25% of the hyperpolarizing current triggered by TRH (171). The expression of SK channels is also well documented in rat (172, 173), mouse (174), and ovine gonadotrophs (72), and the level of their expression is dependent on estradiol (71). SK currents are mainly responsible for the oscillatory hyperpolarization triggered by activation of GnRH receptors, leading to periodic Ca^{2+} release from the ER (discussed in Section VIII.A). In these cells, the function of SK channels is facilitated by PKC (175). Corticotrophs also express SK channels that are activated by AVP (176). An additional Ca^{2+} -activated current was observed in rat gonadotrophs and masked by SK channels when the recording was done

in cells held at -40 mV (177). Other Ca^{2+} -sensitive channels, such as Cl^- channels, which are expressed in AtT-20 cells (178) and native lactotrophs (179), may also be masked. It has also been suggested that SK channels contribute to the after-spike hyperpolarization in GH cells (96). In GH_3 cells, SK channel activation requires high-frequency firing, prolongation of APs by voltage-dependent K^+ channel inhibitors, or release of Ca^{2+} from intracellular Ca^{2+} stores (169). In native pituitary cells, VGCI does not activate SK channels (70). We speculated that the SK channels in pituitary cells are in close proximity to intracellular Ca^{2+} release sites and can be activated only by Ca^{2+} -mobilizing receptors, sustained VGCI, and/or Ca^{2+} -induced Ca^{2+} release (180). In GnRH-secreting neurons, agonist-induced Ca^{2+} mobilization and the concomitant increase in firing frequency are needed to activate SK channels (181).

Single-channel recordings have shown that BK channels are expressed in melanotrophs (182) and lactotrophs (183). Whole cell current recordings confirmed the presence of BK current in rat somatotrophs and lactotrophs, but not in gonadotrophs (70). The relatively high levels of BK channel expression in somatotrophs and lactotrophs should limit AP-driven Ca^{2+} influx compared with that in gonadotrophs, which exhibit the lowest levels of BK channel expression. However, duration of the AP waveform is longer in somatotrophs and lactotrophs (100–500 msec) than in gonadotrophs (10–100 msec) (69, 116, 149, 184). In addition, both the amplitude and duration of the spontaneous, extracellular Ca^{2+} -dependent Ca^{2+} transients are greater in somatotrophs and lactotrophs than in gonadotrophs (184–186). It is unlikely that the prolonged duration of AP-driven Ca^{2+} entry in somatotrophs and lactotrophs is due to the inability of AP firing to activate BK channels because short Ca^{2+} influx steps (<25 msec) were sufficient to activate BK channels in both cell types. An atypical role of BK channels in regulating the pattern of spontaneous AP firing and Ca^{2+} signaling in anterior pituitary cells is discussed in detail in *Section IV.D*. The role of GPCRs in regulation of BK channel activity in endocrine pituitary cells has not been systematically investigated. In one study, the role of $G_{i/o}$ -coupled ET_A and dopamine D_2 receptors in activation of these channels in lactotrophs was addressed (183).

The BK-type K^+ channels are expressed in GH_3 and AtT-20 pituitary cell lines (169, 187–189), and activation of PKC inhibits these channels, which could account for the sustained excitability of pituitary cells during sustained activation of $G_{q/11}$ -coupled GPCRs (190). In GH_3 cells, BK channels contribute to AP repolarization (169), and these cells have been used frequently to study modulation of native BK channels by different compounds

(191–193). The *mslo* transcripts encoding the pore-forming α -subunit of BK channels are robustly expressed in AtT-20 cells, and native channels are not functionally coupled to β -subunits (194). In these cells, glucocorticoids rapidly activate BK channels via a nongenomic mechanism (195). Glucocorticoids applied for 2 h also promote *de novo* BK mRNA and protein synthesis and antagonize PKA- and PKC-dependent inhibition of BK channels (188, 196). Further studies revealed that glucocorticoid regulation of BK channels in these cells is mediated by serine/threonine protein phosphatase (197) and that alternative splicing determines sensitivity of BK channels to glucocorticoids and switches their sensitivity to protein phosphorylation (198, 199). The functional effect of such regulation is thought to be to facilitate ACTH release in response to CRH through inhibition of BK channels (188).

Alternative splicing of the BK channel pore-forming α -subunit also occurs in the adrenal and pituitary gland (200–202). Hypophysectomy of rats causes changes in alternative splicing of the α -subunit in the adrenal medulla, which can be reversed by ACTH treatment (202). This splice decision is also regulated in both adrenal and pituitary tissues in stress situations (200, 203). The role of glucocorticoids in the regulation of BK α -subunit alternative splicing in these tissues was confirmed *in vitro* (200, 201), and the action of glucocorticoids is mediated by both mineralocorticoid and glucocorticoid receptors (200). Female mice genetically deficient in the pore-forming BK subunit respond to restraint stress with reduced ACTH and corticosterone release. It appears that both CRH expression in the paraventricular nucleus and ACTH peptide content in the pituitary were reduced in mice deficient in BK channels (204). Gonadal testosterone also plays a role in the regulation of Slo α -subunit alternative splicing in pituitary cells (205). Stress influences not only the splice decision but also the level of mRNA expression of α -, β_2 -, and β_4 -subunits (167). The β_2 - and β_4 -subunits of BK channels are regulated by steroid hormones (206).

6. Cyclic nucleotide-modulated channels

These channels are directly activated by cyclic nucleotides, in contrast to other channels regulated by their protein kinases. Thus, they translate changes in concentrations of cyclic nucleotides to changes in membrane potential. These channels belong to two families: the hyperpolarization-activated and cyclic nucleotide-modulated channels (HCN channels, with resulting current I_h , where “h” stands for hyperpolarization) and CNG channels (Fig. 7). As their name indicates, HCN channels are activated by voltage and cyclic nucleotides, whereas CNG channels are virtually voltage-independent and activated by cyclic nucleotide binding. Structurally, these channels belong to the superfamily of K_v channels. However, HCN

and CNG channels functionally dissociate from other 6TM domain K^+ channels. Their activation does not dampen excitation, but it increases the firing of APs. Such a paradoxical role for channels that structurally belong to the K^+ -channel family comes from their permeability properties: HCN channels are weakly K^+ -selective channels, and CNG are practically nonselective cation channels (207).

In mammals, the HCN channel family comprises four subunit isoforms, encoded by four genes, HCN1-4 (Fig. 7). When expressed alone, each subunit forms functional channels, but the native channels are probably organized as heterotetramers. HCN channels are activated by hyperpolarization beyond -60 mV, do not inactivate, and conduct Na^+ and K^+ . In cells expressing these channels, their activation leads to slow depolarization, an action consistent with their equilibrium potential of about -30 mV. HCN channels were identified first in cardiac sinoatrial node cells, and subsequently in a variety of peripheral and central neurons. Their voltage sensitivity is modulated by cAMP. HCN channels serve three principal functions in excitable cells: 1) they contribute to the resting potential; 2) they generate or contribute to the pacemaker depolarization that controls rhythmic activity in spontaneously firing cells; and 3) they compensate for inhibitory postsynaptic potentials. A small fraction of HCN channels are tonically activated at rest, producing the first two functions of these channels (208).

Qualitative RT-PCR analysis suggests that AtT-20 cells express mRNA transcripts for HCN1 (209). GH₃ cells express mRNA transcripts for HCN2, HCN3, and HCN4, but not for HCN1 (210). Consistent with these data, electrophysiological experiments confirmed the presence of I_h in GH₃ cells (210, 211), AtT-20 cells (209), melanotrophs (150), somatotrophs (211), and lactotrophs (212). The biophysical and pharmacological properties of this current are similar to the I_h current described in neuronal and cardiac cells. This includes the sensitivity to both ZD7288 and Cs^+ (209–211) as well as to tramadol (213). In contrast to neuronal and cardiac cells, experiments with GH₃ cells showed no effect of elevated cyclic nucleotides on the channel activity in resting cells. Specifically, application of TRH, forskolin, and 8-Br-cAMP does not affect the channel activity in GH₃ cells (210, 211). However, inhibition of the basal cAMP production significantly attenuates the I_h current, which fully recovers by the application of 8-Br-cAMP (210). In AtT-20 cells, current is also robustly inhibited by a cAMP antagonist (209). These results suggest that in pituitary cells, I_h is under tonic activation by basal levels of cAMP.

This current is unlikely to play a major role in pacemaking or setting the resting membrane potential in pituitary

cells *in vitro*. First, in GH₃ cells these channels operate in the range of potentials negative to -60 mV, with small activation at the resting membrane potential. Second, although the extracellular application of Cs^+ and ZD7288 almost completely blocks I_h , it does not stop spontaneous electrical activity or influence the resting membrane potential. However, I_h may limit the excessive hyperpolarization in response to hyperpolarizing stimuli (209–211). Finally, in normal and immortalized GH₃ pituitary cells, ZD7288 has I_h -independent effects. This compound induced a rapid increase in the frequency of spontaneous APs and Ca^{2+} transients in a fraction of cells, which was accompanied by a transient and dose-dependent increase in PRL release in perfused pituitary cells, indicating that channels other than I_h could also be affected by this compound (210, 212). Further studies should be focused on characterization of HCN channels in intact pituitary tissue, including the effects of dopamine and somatostatin on cAMP production, and the role of I_h in pacemaking activity.

In vertebrates, there are six CNG subunits: CNGA1, CNGA2, CNGA3, CNGA4, CNGB1, and CNGB3 (Fig. 7). As with other channels, differential splicing of primary transcripts yields channels of altered structure and behavior. CNGA1-3 subunits can form homomeric channels in heterologous expression systems, and other subunits can coassemble to form functional heteromeric channels. These channels are expressed in olfactory neurons and outer segments of rod and cone photoreceptors, where they play a critical role in sensory transduction. Photoreceptors have a strong preference for cGMP, whereas the olfactory channel is almost equally sensitive to both ligands. The channels are permeable to Na^+ , K^+ , and Ca^{2+} , but not to Cl^- and other anions. Low levels of mRNA transcripts for these channels are also found in brain, testes, kidney, and heart (207). The mRNA transcripts for rod CNG were also detected in rat pituitary cells by RT-PCR analysis (214) and RNA blot hybridization (215). The zebrafish-specific CNGA5 mRNA and protein transcripts are also expressed in the pituitary (216). Stimulation of cGMP production by nitric oxide donors did not change the pattern of spontaneous VGCI in rat lactotrophs (217), and application of a cell permeable 8-Br-cGMP was also ineffective (218), arguing against the relevance of CNG channels in signaling and secretion. Further studies are required to clarify their expression at the protein level and their potential role in electrical activity and Ca^{2+} signaling in other endocrine and/or non-secretory pituitary cells.

7. Transient receptor potential channels

TRP channels were initially found in *Drosophila*, where they contribute to phototransduction. Six protein

families comprise the mammalian TRP superfamily: the “canonical” receptors (TRPCs), the vanilloid receptors (TRPVs), the melastatin receptors (TRPMs), the poly-sistins (TRPPs), the mucolipins (TRPMLs), and the ankyril TM protein 1 (TRPA1). These channels resemble K_v channels in overall structure. However, they show limited conservation of the S4-positive charges and P loop sequences. Assembly of channel subunits as homo- and heterotetramers results in the formation of cation-selective channels. Two members of this superfamily are Ca^{2+} -selective (TRPV5 and TRPV6), and two are monovalent cation selective (TRPM4b and TRPM5); all other channels are relatively nonselective (219). These channels have been studied extensively in numerous tissues, but not in the pituitary gland. The TRPM3 channel mRNA transcripts are present in pituitary cells (220) as well as unidentified member(s) of the TRPC family of channels that are activated by phospholipase C (PLC) (221). The mRNA transcripts for TRPC1, TRPC3, TRPC5, and TRPC7 have also been identified in human pituitary cells (222). There are at least two types of currents present in pituitary cells whose nature is unknown and could be mediated by TRP channels: Ca^{2+} -activated nonselective cationic currents in GH₃ cells (223) and gonadotrophs (177), and TTX-insensitive Na^+ conductance present in all endocrine pituitary cells (80, 224). It is reasonable to suggest that future electrophysiological investigations in pituitary cells should be focused on this superfamily of channels, especially on members of the TRPC and TRPM families.

B. Chloride channels and transporters

Anion channels are proteins forming pores in biological membranes that allow the passive diffusion of negatively charged ions along their electrochemical gradients. Because all of these channels conduct Cl^- , the most abundant anion in organisms, they are often called chloride channels. However, some of these channels may be better conductors of ions other than Cl^- . As with cation channels, the most logical classification of Cl^- channels is based on their molecular structure, but entire gene families of anion channels remain to be discovered. The most common division of these channels is based on molecular structure and biophysical characteristics and include: voltage-gated chloride channels, ligand-gated (GABA and glycine) chloride channels, calcium-activated chloride (CaCC) channels, high (maxi) conductance channels, the cystic fibrosis TM conductance receptor, and volume-regulated channels (225).

GABA and glycine channels have been studied in pituitary cells and are described in *Section VI.A.3*. The expression and role of voltage-gated chloride channels in pituitary cells have not been studied. The CLIC6, a member of the intracellular Cl^- channel family, was identified

in the posterior pituitary (226). Most studies on pituitary cells were focused on CaCC channels. The first report about the Ca^{2+} -dependent Cl^- conductance was done in GH₃ cells (227). These channels are also present in AtT-20 cells and contribute to the control of APs and VGCI (178). In native lactotrophs, TRH activates CaCC channels in addition to BK and SK channels (228). Depolarization-induced Ca^{2+} influx and Ca^{2+} ionophore application also trigger activation of these channels in lactotrophs (179). A large conductance Ca^{2+} -sensitive chloride channel is present in lactotrophs and takes part in the background regulation of the intracellular chloride concentration (229). Hypotonicity also activates CaCC channels in GH₄/C₁ cells (230).

The common characteristic of K^+ and Cl^- ions in neurons is their negative equilibrium potential. Activation of channels conducting these ions draws the membrane potential closer to their equilibrium potentials and farther from the threshold for firing. Channels conducting these ions tend to stabilize the membrane potential by setting the resting potential, repolarize and hyperpolarize cells after a depolarizing event, and control the interspike interval. In the majority of cells from adult animals, intracellular chloride concentration ($[Cl^-]_i$) is low, which permits chloride channels to stabilize the membrane potential of excitable cells. Experiments with AtT-20 cells, however, found that $[Cl^-]_i$ was between 40 and 50 mM and that activation of CaCC channels by Ca^{2+} influx during APs tends to maintain the membrane potential at a depolarized level and to enhance VGCI (178). In lactotrophs, $[Cl^-]_i$ was estimated to be around 60 mM (231). Electroneutral ion transporters, such as the Cl^- extruding K^+ - Cl^- cotransporter KCC2 and the Cl^- accumulating Na^+ - K^+ - $2Cl^-$ cotransporter NKCC1, participate actively in maintaining a high $[Cl^-]_i$ in the endocrine pituitary cell (232). For further discussion on this subject, see *Section VI.A.3*.

Elevated basal $[Cl^-]_i$ may explain the finding that Cl^- channel blockers inhibit ACTH release from corticotrophs (233) and provides a rationale for the complex pattern of interactions between Ca^{2+} and Cl^- movements in pituitary lactotrophs (179). It has also been shown that PRL secretion is an osmotically driven process depending on $[Cl^-]_i$ (234). Additionally, granule fusion recorded by the patch clamp technique is facilitated when the intrapipette Cl^- is elevated (235, 236). Experiments with substitution of Cl^- with other ions also confirmed the specific role for this anion in stimulus-secretion coupling (237).

C. Channels expressed in and controlled by the endoplasmic reticulum

The expression of ion channels is not limited to the plasma membrane. Two families of Ca^{2+} release channels, IP₃Rs and ryanodine receptors (RyRs), are predominantly

expressed in the ER/sarcoplasmic reticulum membrane. These channels are structurally and functionally similar. IP₃Rs are activated by two classes of plasma-membrane receptors known as Ca²⁺-mobilizing receptors, whereas RyRs provide an effective mechanism for intracellular transduction and translation of electrical signals. The activity of both types of channels is regulated by Ca²⁺, and the variety of Ca²⁺ signaling patterns, including Ca²⁺ sparks and puffs and oscillatory Ca²⁺ waves, depends critically on the [Ca²⁺]_i dependence of these two families of channels. Activation of IP₃Rs leads to stimulation of voltage-insensitive Ca²⁺ channels expressed on the plasma membrane, a process known as capacitative Ca²⁺ entry (238, 239).

1. IP₃ receptors

IP₃Rs are found in the ER and nuclear membranes of almost all cells. These receptors are composed of four similar subunits that are noncovalently associated to form a four-leaf clover-like structure, the center of which makes the Ca²⁺-selective channel. Each subunit contains approximately 2700 amino acids, with the cytoplasmic N terminus comprising approximately 85% of the protein mass, a hydrophobic region predicted to contain six membrane-spanning helices, and a short cytoplasmic C terminus. Physiologically, activation of IP₃Rs is triggered by GPCRs and the plasma membrane receptor tyrosine kinases. Calcium-mobilizing GPCRs activate PLC-β, whereas receptor tyrosine kinases activate PLC-γ. Both enzymes hydrolyze the membrane-associated PIP₂ to increase the production of IP₃ and DAG. IP₃ rapidly diffuses into the cytosol to activate IP₃Rs. In addition to IP₃, Ca²⁺ plays an important role in the control of permeability of these channels. There are three subtypes of IP₃Rs, which exhibit the isoform-specific properties in terms of their sensitivity to IP₃ and Ca²⁺. Further diversity of IP₃R expression is created by alternative splicing. Most cells express multiple isoforms of IP₃Rs, indicating that they have different functions (240).

IP₃Rs are commonly expressed in pituitary cells, as indicated by the ability of numerous Ca²⁺-mobilizing agonists, including GnRH (241), TRH (242), AVP and oxytocin (54, 243), angiotensin II (244), ET-1 (245), neurotensin (246), and ATP (247), to trigger an extracellular Ca²⁺-independent rise in [Ca²⁺]_i. The presence of high-affinity IP₃ binding sites was initially demonstrated using bovine pituitary membranes (248). The ability of IP₃ and its nonmetabolized form to initiate Ca²⁺ oscillations has been shown in patch-clamped rat gonadotrophs (173, 249). In these cells, Ca²⁺ can stimulate Ca²⁺ release in the presence of IP₃, as indicated by phase resetting of IP₃-dependent Ca²⁺ oscillations by membrane depolarization (250). Elevated [Ca²⁺]_i (above 500 nM) can also stop IP₃-

dependent Ca²⁺ oscillations (251). Thus, the gating of IP₃Rs in gonadotrophs depends on both IP₃ and Ca²⁺. The existence of stimulatory and inhibitory effects of Ca²⁺ on IP₃-dependent Ca²⁺ release combined with Ca²⁺ influx was the basis of a mathematical model of GnRH-induced Ca²⁺ oscillations that nicely reproduces experimental records (252) (for details see *Section VIII*).

Among pituitary cells, the oscillatory pattern of Ca²⁺ release through IP₃Rs is a unique characteristic of gonadotrophs and is not species specific (174, 253). Other native pituitary cells typically release Ca²⁺ from the ER in a nonoscillatory manner (254). Immortalized αT3-1 and LβT2 gonadotrophs also release Ca²⁺ in a nonoscillatory manner (42, 255), indicating that the oscillatory response is not established at an early phase of pituitary development. However, it is already established at birth because neonatal gonadotrophs respond to GnRH application with oscillatory Ca²⁺ release (256). The cell-type specificity in the pattern of Ca²⁺ release could be related to the expression of IP₃R subtypes, which has not been studied in native pituitary cells. αT3-1 gonadotrophs express all three subtypes of receptors, but the expression of IP₃R₁ dominates (257). Furthermore, in these cells the sustained desensitization of GnRH action is due to uncoupling of IP₃ generation and Ca²⁺ mobilization (258) and down-regulation of IP₃R₁ (257). Ubiquitination and proteasomal degradation account for down-regulation of endogenous and exogenous IP₃R₁ in αT3-1 gonadotrophs (259), and this action is triggered by the concerted action of IP₃ and Ca²⁺ binding to this receptor (260).

2. Ryanodine receptors

RyRs are the largest known ion channels. Mammalian tissues express three isoforms: RyR₁ is expressed predominantly in skeletal muscle; RyR₂ is expressed in cardiac muscle; and RyR₃ has a wide tissue distribution, including the nonexcitable cells. RyRs are tetramers, with a large N-terminal region forming the head and a C-terminal region that forms the Ca²⁺-selective channel. Intracellular Ca²⁺ is a major regulator of RyRs. The ability of Ca²⁺ to stimulate Ca²⁺ release from the endoplasmic/sarcoplasmic reticulum via RyRs is known as Ca²⁺-induced Ca²⁺ release. This process is of fundamental importance for coordinating the elementary Ca²⁺-release events into Ca²⁺ spikes and waves. Unlike IP₃Rs, RyRs can release Ca²⁺ in response to an increase in [Ca²⁺]_i with no other change in the concentration of second messengers. This is crucial for excitation-contraction coupling. For example, in cardiac cells, Ca²⁺ entry through dihydropyridine-sensitive Ca_v channels activates RyRs to induce a further increase in [Ca²⁺]_i. In skeletal muscle cells, the dihydropyridine receptors act primarily as voltage sensors to directly activate RyRs in response to membrane depolarization. These

receptors are susceptible to many different modulators. Ryanodine and dantrolene activate and inhibit RyRs, depending on their concentrations, and caffeine is a standard pharmacological tool for the activation of RyRs (261, 262).

Ryanodine-sensitive Ca^{2+} stores are present in goldfish pituitaries and contribute to agonist-induced Ca^{2+} signaling and secretion (263). In tilapia fish pituitary cells, however, ryanodine-sensitive Ca^{2+} stores do not contribute to hyposmotically-induced PRL release (264). The mRNA transcripts for RyR₁ and RyR₃ are present in AtT-20 cells, and caffeine stimulates ACTH release, presumably by activating these receptors (265). Furthermore, it has been suggested that cADP-ribose is a second messenger in these cells that regulates ACTH secretion by a mechanism dependent on activation of RyRs by extracellular Ca^{2+} (266). In GH₃ cells, caffeine stimulates Ca^{2+} release from intracellular pools but also inhibits Ca^{2+} influx through L-type Ca_v channels (267). The mRNA transcripts for RyR₂ and RyR₃, but not RyR₁, are present in rat pituitary cells, and ruthenium red treatment, which should block these channels, inhibits GnRH-induced LH release from gonadotrophs (268). In contrast, the ryanodine treatment does not affect GnRH-induced Ca^{2+} oscillations, suggesting that a ryanodine-sensitive pool does not contribute significantly to IP₃-dependent Ca^{2+} oscillations in rat gonadotrophs (249, 269). It is also unlikely that Ca^{2+} influx through Ca_v channels is coupled to Ca^{2+} -induced Ca^{2+} release in rat somatotrophs (214), lactotrophs, and GH₃ cells (270). A detailed characterization of the expression and function of RyRs in endocrine and nonendocrine pituitary cells is needed.

3. STIM-controlled Orai channels

The term “capacitative Ca^{2+} entry,” by analogy with a capacitor in an electrical circuit, implies that intracellular Ca^{2+} stores prevent entry when they are charged (filled by Ca^{2+}) but promote entry as soon as the stored Ca^{2+} is discharged (released). The similarities in the properties of this entry within different cell types, including excitable cells, suggest a common mechanism. In addition to Ca^{2+} -mobilizing agonists, capacitative Ca^{2+} entry can be activated by injection of IP₃ or its nonmetabolized forms into the cell, inhibition of the ER- Ca^{2+} pumps [sarcolemmal ER Ca^{2+} ATPase (SERCA)] by thapsigargin, discharge of the intracellular content by Ca^{2+} ionophores, or prolonged incubation of cells in Ca^{2+} -deficient medium. When heparin, an IP₃R inhibitor, was injected into the cells, it completely blocked agonist and IP₃-induced Ca^{2+} mobilization and capacitative Ca^{2+} entry. Because depletion of the ER- Ca^{2+} stores is followed by the influx of Ca^{2+} into the cell, the channels involved in such influx were termed store-operated Ca^{2+} -selective plasma-mem-

brane channels. Two proteins have been identified as critical for this pathway: stromal-interacting molecule (STIM) and Orai (271).

Capacitative Ca^{2+} entry is probably operative in immortalized pituitary cells. It has been suggested that capacitative Ca^{2+} entry cooperates with Ca_v channels to generate spontaneous Ca^{2+} oscillations and the sustained rise in $[\text{Ca}^{2+}]_i$ in TRH-stimulated GH₃ cells (272). In these cells, thapsigargin and thymol treatment is also accompanied with capacitative Ca^{2+} influx, which is inhibited by La^{3+} and SKF 96365 (273–275). In GH₄C₁ cells, the contribution of capacitative Ca^{2+} entry to $[\text{Ca}^{2+}]_i$ is modest compared with the robust Ca^{2+} influx through Ca_v channels (276, 277) and is facilitated by loperamide (278). Furthermore, some of the effects could be related to the expression of TRP channels in pituitary cells (222). Thapsigargin also triggers Ca^{2+} influx in $\alpha\text{T3-1}$ cells, but in these cells GnRH stimulates Ca^{2+} influx predominantly through L-type Ca_v channels (279, 280).

At the present time, there is no information about the contribution of capacitative Ca^{2+} entry in normal pituitary cells. Two lines of evidence, however, argue against their activation upon ER- Ca^{2+} store depletion. In lactotrophs, activation of ET_A receptors leads to stimulation of Ca^{2+} release through $\text{G}_{q/11}$ coupling accompanied with a sustained inhibition of Ca^{2+} influx, in contrast to the expected rise in $[\text{Ca}^{2+}]_i$ (281, 282), suggesting that depletion of the ER- Ca^{2+} pool does not trigger capacitative Ca^{2+} influx in these cells. In gonadotrophs, the duration of GnRH-induced Ca^{2+} oscillations depends on the membrane potential (269). Hyperpolarization of the cell membrane should facilitate capacitative Ca^{2+} influx, but in gonadotrophs Ca^{2+} signaling is terminated after depletion of the ER- Ca^{2+} pool. Furthermore, there was a rapid recovery of Ca^{2+} oscillations when cells were depolarized to facilitate VGCI, suggesting that Ca_v channels in these cells provide the major pathway for Ca^{2+} influx after the ER- Ca^{2+} depletion (283). It has also been shown that in rat gonadotrophs, GnRH-stimulated LH release is not mediated by store-dependent Ca^{2+} influx (279). Further studies in this field should focus on the expression of STIM-Orai in secretory and nonsecretory pituitary cells and, if expressed, on the mechanism of their activation and blockade by GPCRs.

IV. Spontaneous Electrical Activity

A. Spiking and bursting

Electrically excitable cells have been defined as those with voltage-sensitive ion permeability that show regenerative and propagated electrical activity spontaneously or in response to stimulation. Thirty-five years ago it was

shown for the first time that endocrine pituitary cells, like neurons, generate APs (1). Initially, it was believed that only lactotrophs and GH pituitary cells are excitable. With time, it became obvious that all secretory pituitary cell types of vertebrates fall into this category. The membrane potential of isolated pituitary cells *in vitro* is not stable but oscillates from resting potentials of -60 to -50 mV, reflecting the balance between the activity of depolarizing and hyperpolarizing channels. When membrane potential oscillations reach the threshold level, cells generate APs. *In vitro*, firing of APs has been observed in frog (284), mouse (285), porcine (286), ovine (72), and bovine (287) endocrine pituitary cells. Firing of APs in cultured cells is not an *in vitro* artifact; it has also been observed *in situ* in rat pituitary slices (288).

However, the pattern of electrical activity varies among cells. Gonadotrophs obtained from male rats are typically quiescent (69), whereas about half of those from female rats exhibit spontaneous spiking (184, 289), but this difference could reflect the method of recording (whole cell recording in male gonadotrophs and perforated cell recording in female gonadotrophs). The spiking frequency is typically approximately 0.7 Hz, and the APs are tall and narrow, with amplitude of more than 60 mV (from initiation to peak) and half-width of less than 50 msec (185). Ovine gonadotrophs also fire single APs spontaneously (72). In one study, approximately 80% of lactotrophs and somatotrophs from female rats exhibited spontaneous activity (184). The pattern of activity can be similar to female gonadotrophs, with large and narrow spikes (80, 218, 290), but more often a bursting pattern is produced. These bursts consist of periodic depolarized potentials with superimposed small-amplitude spikes (185, 290, 291). The bursts have a much longer duration (several seconds) than gonadotroph APs, and the burst frequency is significantly lower (~ 0.3 Hz). The membrane potential rarely goes above -10 mV during a plateau burst, and the spikes are quite small, with amplitude of 10 mV or less (185). This was originally termed “plateau bursting,” but it has recently been renamed “pseudo-plateau bursting” to distinguish it from the type of bursting produced in agonist-stimulated gonadotrophs and pancreatic islets, where the spikes are larger and the bursting pattern is longer and more regular (292). Corticotrophs also exhibit both spontaneous large-amplitude spiking and pseudo-plateau bursting (293, 294), as do melanotrophs (284–286) and GH cell lines (96, 295, 296). Little is known about the spontaneous electrical activity of thyrotrophs.

B. Pacemaking mechanisms

What drives the spontaneous activity of anterior pituitary cells? Although there is still uncertainty about which subthreshold ionic currents are most responsible for depolariz-

ing the cell to the AP threshold, much has been learned in recent years about the candidate currents. The resting membrane potential of -50 to -60 mV in pituitary cells suggests that in addition to resting K^+ conductance, there are also depolarizing conductances due to other ions. The resting membrane potential rapidly reaches about -85 mV, a value close to equilibrium potential for K^+ , when extracellular Na^+ is substituted with large organic cations, suggesting the constitutive activity of a Na^+ -conducting channel. Such prominent hyperpolarization of the plasma membrane in the absence of bath Na^+ causes abolition of spontaneous firing of APs in gonadotrophs, lactotrophs, somatotrophs, and GH_3 cells. In contrast, blockade of Na_v channels by TTX does not affect resting membrane potential in a majority of pituitary cells. These observations indicate that constitutive activity of TTX-insensitive Na^+ -conducting channels, termed the background Na^+ (Na_b) channels, contributes to the control of resting membrane potential and may account for the pacemaking depolarization (80, 96, 224, 297). The nature of Na_b channels has not been clarified. There are several channel candidates, which could potentially account for the existence of this conductance in pituitary cells. It has been shown recently that the neuronal channel Na^+ leak channel, nonselective contributes resting Na^+ permeability (298). Because pituitary cells express several TRP channels (see Section III.A.7), it is also possible that the background activity of these channels could contribute to the resting membrane potential.

The channels that mediate subthreshold TTX-insensitive Na^+ currents are frequently activated by cyclic nucleotides, either directly or indirectly. Evidence for this hypothesis comes from data showing that inhibition of phosphodiesterases (PDEs) led to an increase in the frequency of bursting in somatotrophs, suggestive of increased excitation (291). Stimulation of pituitary cells with forskolin also initiates firing of APs in quiescent lactotrophs and increases the frequency of firing in spontaneously active lactotrophs (218). Both treatments increase levels of cAMP and cGMP (218, 299), suggesting that elevation in their intracellular concentrations accounts for changes in the pattern of electrical activity.

In general, cAMP can modulate channel activities indirectly, by PKA-mediated phosphorylation of channels (89, 300) or directly by activating HCN and CNG channels (207). Some years ago, Kato *et al.* (301) showed that GHRH stimulates a rise in $[Ca^{2+}]_i$ and GH secretion by a mechanism involving cAMP/PKA. They also reported that these effects were dependent on bath Na^+ but were not abolished by TTX in concentrations that block Na_v1-4 and Na_v6-7 channels. Elevation in TTX concentrations had a partial inhibitory effect, suggesting that TTX-insensitive Na_v5 and $Nav8-9$ channels could account for the

GHRH-stimulation of VGCI and GH secretion (301). Hille's group (302) also reported a TTX-insensitive Na^+ current that is up-regulated by PKA phosphorylation and was proposed to be important for GHRH-stimulated pacemaking activity in somatotrophs. The synthetic peptide, GHRP-6, elevates the intracellular Na^+ concentration in somatotrophs by facilitating Na^+ influx, which in turn facilitates VGCI (303). This agonist, however, does not elevate cAMP production but operates as a Ca^{2+} -mobilizing agonist (304). Recently, Chen's group (87) reported a stimulatory effect of GHRH on TTX-resistant Na_v channels in somatotrophs from GH-green fluorescent protein transgenic mice, but suggested that PKC mediates the action of GHRH. None of these studies suggested that TTX-insensitive Na_v channels account for the Na_b conductance.

The HCN channels are permeable to both Na^+ and K^+ , and the current mediated by the channels (I_h) has a reversal potential of about -30 mV (305). Thus, activation of the currents depolarizes the cell. The HCN channels activate at hyperpolarized voltages, typically negative to -50 or -60 mV, and deactivate upon depolarization. Their activity is up-regulated by cAMP, and to a much lesser extent by cGMP. The cyclic nucleotides bind directly to HCN channels and shift the voltage dependence of activation toward more depolarized potentials (306). HCN current is present in several pituitary cell types (see *Section III.A.6*), but it appears to contribute little to pacemaking. In both AtT20 and GH_3 cell types, spontaneous activity continued when I_h was blocked, although I_h was maximally activated at basal levels of cAMP (209, 210). Such fully activated HCN channels in turn may contribute to resting Na^+ permeability. These currents may also play the role of a brake of membrane hyperpolarization or in the fast recovery from inhibition that follows activation of $G_{i/o}$ -coupled receptors (209). Pituitary cells also express mRNA transcripts for the rod type of CNG channels (see *Section III.A.7*). However, if functional CNG channels are expressed in pituitary cells, it is unlikely that they contribute to spontaneous firing of APs. Neither application of cGMP-permeable analogs nor stimulation/inhibition of soluble guanylyl cyclase (sGC) activity had any effect on the spontaneous firing of APs in lactotrophs (217, 218). Also, spontaneous firing persisted in lactotrophs when adenylyl cyclase (AC) activity was blocked (218).

One subthreshold current, commonly found in neurons, is the T-type Ca^{2+} current. Voltage-clamp studies have shown that this current is present in anterior pituitary cells and is most prominent in somatotrophs (see *Section III.A.2*). The T-type current activates at lower voltages than other types of Ca_v channels, but inactivates within approximately 10 msec. Thus, it provides transient depo-

larization that can help bring a repolarized cell to the AP threshold. It has been suggested that T-type Ca^{2+} current acts as the pacemaker current for the firing of APs in gonadotrophs (307) or contributes to the control of pacemaking because the frequency of AP decreases in cells with blocked T-type Ca_v channels (291). Because PKA does not phosphorylate the T-type channel (91), it is unlikely that it accounts for forskolin-stimulated electrical activity in pituitary cells. The L-type Ca^{2+} channels are stimulated by PKA-dependent phosphorylation of their α -subunits (89), which in turn could change the steady-state Ca^{2+} influx (308) and facilitate pacemaking.

C. Channels involved in spike depolarization

In neurons, TTX-sensitive Na_v channels are critical for the development of the depolarizing phase of APs (131). As previously discussed, all pituitary cells express TTX-sensitive Na_v channels. However, in the majority of rat anterior pituitary cells, inhibition of these channels does not affect the pattern of spontaneous electrical activity, whereas removal of extracellular Ca^{2+} or blockade of L-type Ca_v channels by dihydropyridines abolishes electrical activity without affecting the resting membrane potential, indicating that these channels are critical for spike depolarization (184, 291). In contrast, in a fraction of ovine gonadotrophs (72) and bovine lactotrophs (287), Na_v channels are responsible for AP generation. Also, two lactotroph subpopulations have been identified that differ with respect to their level of Na^+ channel expression; only in lactotrophs expressing high levels of Na^+ channels did TTX application abolish basal hormone secretion (79). Furthermore, TTX-sensitive Na_v channels may contribute to the firing of APs and the accompanied VGCI in frog and rat melanotrophs (65, 66). Involvement of TTX-sensitive Na_v channels in PACAP-induced GH secretion was also reported (309).

These differences could reflect the impact of culturing conditions on cell behavior *in vitro* and the status of TTX-sensitive Na_v channels at the resting potential. The lack of TTX-sensitive Na^+ channel involvement in controlling membrane excitability and secretion in many rat pituitary cells is most likely due to the inactivation of a large proportion (above 90%) of these channels at the resting membrane potential in these cells *in vitro* (70). Consistent with this, GnRH-induced transient membrane hyperpolarization in rat gonadotrophs is required to remove the steady-state inactivation of TTX-sensitive Na^+ channels before they can contribute to AP firing (69). In melanotrophs, at typical resting potential of -50 mV, approximately 60–70% of the channels are in the inactivated state, which may explain the presence of a TTX-sensitive component in spike depolarization. However, the firing of TTX-sensitive APs is not an essential requirement for hormone release from these cells (64). These observations raised the

question about the physiological importance of the resting membrane potential on the contribution of Na_v and L-type Ca_v channels in the spike depolarization. In GnRH-secreting GT1 neurons, a shift in the firing of APs from TTX+ dihydropyridine sensitive to exclusively dihydropyridine-sensitive APs was consistently observed in receptor and nonreceptor depolarized cells, which limits the participation of both channels in firing but facilitates AP-driven Ca^{2+} influx (310, 311). Further studies are needed to clarify whether the same mechanism is operative in endocrine pituitary cells.

D. A mechanism for bursting

Why is the spontaneous activity of gonadotrophs characterized by tall AP spiking, whereas that of other cell types is often characterized by bursting? The simplest explanation could be that there is a cell-specific expression of channels, leading to different patterns of spiking. In a study of ion channel distribution in cells from randomly cycling female rats, it was shown that lactotrophs and somatotrophs express lower levels of TTX-sensitive Na_v current than do gonadotrophs (70). As mentioned above, however, blockage of these channels with TTX was shown to have no impact on the frequency of spontaneous electrical activity in these cells (184). The T-type Ca_v current is more abundant in somatotrophs than in lactotrophs and gonadotrophs (70), but this could not explain why bursting is observed in both somatotrophs and lactotrophs, but not gonadotrophs.

One type of current that is larger in somatotrophs and lactotrophs than in gonadotrophs is the BK current. These channels activate rapidly upon membrane depolarization, most likely due to colocalization of the BK channels with Ca^{2+} channels (70, 185). The BK current acts in conjunction with the delayed rectifying K^+ current to repolarize the cell membrane during the downstroke of an AP (312). There is evidence that this inhibitory current is the key to bursting behavior in a fraction of somatotrophs (185). First, the membrane-permeable Ca^{2+} chelator BAPTA-AM was used in somatotrophs and converted spontaneous bursting to large-amplitude spiking. By rapidly chelating Ca^{2+} , BAPTA is thought to greatly attenuate the Ca^{2+} nanodomain that forms at the mouth of an open Ca_v channel, and thus reduce the degree of activation of BK channels. Second, the BK channel blockers iberiotoxin and paxilline both convert bursting to large-amplitude spiking in somatotrophs. Apamin, a blocker of SK channels has little effect on K_{Ca} current in somatotrophs. Third, other agents including GHRH and KCl did not convert the bursting to spiking, but only increased the burst frequency and produced baseline depolarization. Taken together, these data suggest that BK channels are a key element in the production of bursting, and that their greater expression in somatotrophs is responsible for the

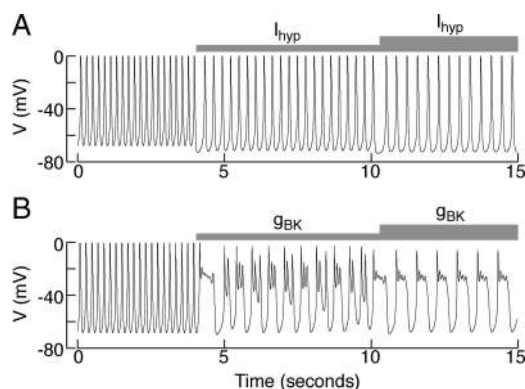

FIG. 8. Model simulation of the transition from spiking to bursting with the addition of BK current. A, Application of a voltage-independent hyperpolarizing current slows down spiking, but does not convert the spiking to bursting (*thin bar*, small current; *thick bar*, larger current). B, Application of a rapidly activating BK-type K^+ current converts spiking to bursting.

different activity patterns of somatotrophs/lactotrophs and gonadotrophs (185).

Mathematical modeling was used to understand how an inhibitory current could have a stimulatory action by converting spiking to bursting (185). Results from a similar model are shown in Fig. 8 to demonstrate the behavior. When a hyperpolarizing voltage-independent current is added to a spiking model cell, it simply reduces the spike frequency and produces some baseline hyperpolarization (Fig. 8A). Increasing the magnitude of the current accentuates this effect and eventually brings the model cell to a low-voltage steady state (data not shown). If instead a hyperpolarizing BK-like current is added to a spiking cell, the spiking is converted to bursting (Fig. 8B). The burst frequency and size of the spikes is decreased when more BK-like current is added. The explanation is that the fast activation of the BK current reduces the amplitude of an AP. As a result, less delayed rectifying current is activated, so the downstroke of the spike is less extreme, reaching less negative voltages. Thus, the spikes of the burst ride on a depolarized plateau. It is thought that the burst ends when Ca^{2+} has built up sufficiently to activate BK channels that are more distant from the Ca^{2+} channels (185). When this accumulated Ca^{2+} is removed by Ca^{2+} -ATPases, a new burst is initiated. A mathematical analysis of this type of bursting has been performed (291, 313), and the bursting is named “pseudo-plateau bursting.” The resetting properties of this type of bursting oscillation are quite different from those of “plateau bursting” typically exhibited by neurons (292).

Consistent with this observation, stimulation of BK channels prolongs the duration of APs, whereas their inhibition potentiates the firing of APs in dorsal root ganglion neurons (314). Participation of these channels in broadening of APs was also observed in rat amygdala cells

(315). However, in some pituitary cells exhibiting bursting, blockade of BK channels does not lead to single spiking. In GH₃ cells, BK channels act primarily to end the APs (169, 312). Mathematical modeling suggests that the A-type K⁺ current, like the BK current, can help convert a spiking cell to a bursting cell (313). The mechanism for this is similar to that for the BK current, in that the A-current limits the amplitude of the voltage spike and thus reduces the activation of the delayed-rectifying K⁺ current. It has been suggested recently that such diverse effects on AP firing probably depend on the type of K_{Ca} channels, gating properties, and the context of other channels (167). In rat chromaffin cells, inactivating and noninactivating BK channels contribute differentially to AP firing behavior (316). Also, in the somatotroph cell model the localized Ca²⁺ rather than bulk Ca²⁺ accounts for the burst-promoting effect of BK channels. A small distance between Ca_v and BK channels was also proposed for rat supraoptic neurons (317) and *Xenopus* motor nerve terminals (318). Additional experiments are needed using several different pituitary cell types exhibiting plateau bursting and single spiking, preferably in intact tissue, to clarify the specific roles of BK channels in electrical activity and the alternative mechanisms for generating plateau bursting.

E. Functional roles of spontaneous spiking

In their article published in 1996, Mollard and Schlegel (319) addressed the question of why endocrine pituitary cells are excitable. Since then there has been significant progress in understanding the role of excitability in pituitary cell functions. It appears that both changes in the membrane potential and the accompanied changes in Ca²⁺ influx have functional roles in endocrine pituitary cells. In this section, we review the functional role of spontaneous excitability in isolated pituitary cells at resting conditions. In the following sections, the focus is on modulation of spontaneous electrical activity by gap junction coupling (*Section V*) and activation of receptor channels (*Section VI*) and GPCRs (*Sections VII and VIII*) that are endogenously expressed in pituitary cells.

1. AP-driven Ca²⁺ signals

The high-voltage activated Ca_v channels in pituitary cells not only give rise to APs in the same way as Na_v channels, but also provide an effective pathway for Ca²⁺ influx during the transient depolarization, which acts as an intracellular messenger controlling a variety of cellular functions. The patterns of spontaneous electrical activity in the different cell types have a large impact on the intracellular Ca²⁺ dynamics and overall Ca²⁺ levels. Simultaneous measurements of membrane potential and [Ca²⁺]_i showed that the bulk Ca²⁺ levels are low in spontaneously

spiking gonadotrophs (20 to 70 nM), whereas they are much higher (300 to 1200 nM) and clearly oscillatory in spontaneously bursting lactotrophs and somatotrophs (184, 291) and GH₃B₆ cell line (296). Others also observed high-amplitude spontaneous Ca²⁺ transients in somatotrophs (186), lactotrophs (94), corticotrophs (320), and GH and AtT-20 cell lines (96, 125, 321–323). Rhythmic bursts of Ca²⁺ transients were also observed in acute anterior pituitary slices (324). The pattern of Ca²⁺ signaling also varies among cells of the same origin. For example, the light fraction of lactotrophs was found to have higher basal PRL release and this is correlated with high [Ca²⁺]_i and the presence of spontaneous Ca²⁺ transients, as well as a depolarized (~ -45 mV) resting potential and spontaneous electrical activity. In contrast, the heavy fraction of lactotrophs has a more hyperpolarized resting potential (~ -65 mV), and the cells are generally silent with lower [Ca²⁺]_i levels (325). A similar heterogeneity was found in porcine somatotrophs, with the low-density somatotrophs exhibiting higher basal [Ca²⁺]_i than the high-density somatotrophs (326).

The difference in the patterns of Ca²⁺ transients between cells firing single APs and those exhibiting pseudo-plateau bursting is reflected in the dynamics of Ca²⁺ channel activation and in the spatial distribution of Ca²⁺ within the cell. Both large-amplitude spikes and bursts depolarize the membrane sufficiently to activate the various types of Ca²⁺ channels expressed in pituitary cells (70, 104). However, Ca_v channels are open for a short time during the short duration of a gonadotroph AP, and as a consequence the elevated Ca²⁺ concentration is localized to nanodomains that form at the inner mouth of open channels. With the longer duration and smaller amplitude of somatotroph/lactotroph bursts, channels stay open longer and significant Ca²⁺ entry occurs throughout the burst, which lasts several seconds. A global Ca²⁺ signal is produced because individual Ca²⁺ nanodomains overlap, producing a global signal that is easily resolved with fluorescent Ca²⁺ dyes such as fura-2, as shown by confocal measurements in pituitary somatotrophs (214). Thus, the Ca²⁺ influx summed over time is much greater during bursting than during large-amplitude spiking (180).

It is unlikely that Ca²⁺-induced Ca²⁺ release through RyRs contribute to the generation of such global Ca²⁺ signals in mammalian lactotrophs and somatotrophs (214, 270), but their contribution in GH₄C₁ pituitary cell types should not be excluded at the present time (323). The most complex pattern of spontaneous Ca²⁺ oscillations was observed in frog melanotrophs. These cells also exhibit spontaneous Ca²⁺ transients, which are dependent on Ca²⁺ influx through Ca_v channels (327, 328). The rise in Ca²⁺, however, occurs in a stepwise manner (329), and

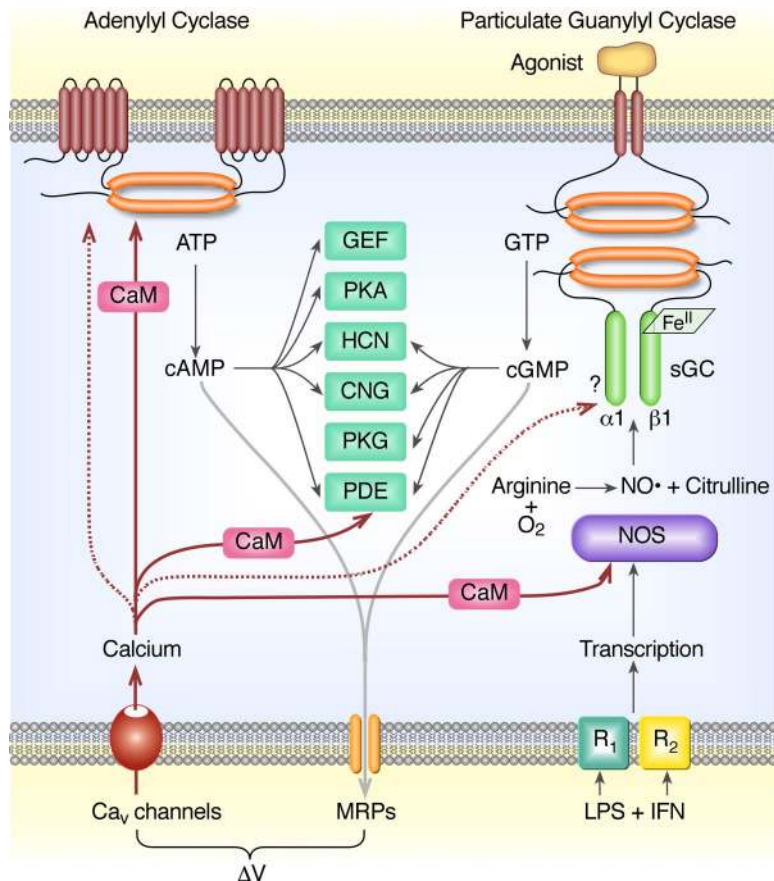

FIG. 9. Dependence of the cyclic nucleotide signaling pathway on Ca^{2+} influx through Ca_v channels. Calcium stimulates the activity of several adenylyl cyclases, PDE1, and nitric oxide synthase (NOS) in a calmodulin (CaM)-dependent manner (continuous lines). It also inhibits some adenylyl cyclase isoforms and sGC directly (dotted lines). Changes in the resting membrane potential affect the multidrug resistance protein (MRP)-mediated cyclic nucleotide efflux. PKG, Protein kinase G; LPS+IFN, lipopolysaccharide and interferon.

generation of Ca^{2+} transients is abolished in cells in which the ER Ca^{2+} pump is blocked by thapsigargin (330). It appears that in these cells spontaneous VGCI is coupled to Ca^{2+} -induced Ca^{2+} release, presumably through IP_3Rs (331).

2. Dependence of the cyclic nucleotide signaling pathway on electrical activity

Anterior pituitary cells not only fire APs spontaneously, but also generate cyclic nucleotides in resting conditions. Two lines of evidence support the conclusion that basal AC activity accounts for cAMP production in unstimulated cells. First, in pituitary cells *in vitro* several inhibitors of ACs decrease basal cAMP production in cells with inhibited PDEs, a family of enzymes that metabolize cyclic nucleotides (218). Second, basal cAMP production in pituitary cells *in vitro* was also inhibited by activation of two $G_{i/o}$ -coupled receptors, dopamine D_2 and ET_A (218, 281). Unstimulated pituitary cells also generate cGMP due to basal activity of the nitric oxide synthase-sGC signaling pathway, as indicated by a concentration-dependent de-

crease in cGMP production in cells treated with variable nitric oxide synthase inhibitors (332–335). Intracellular cyclic nucleotide levels in pituitary cells in resting conditions are controlled by PDEs (336) and multidrug resistance proteins, which in pituitary cells operate as cyclic nucleotide efflux pumps (224, 332). The relevance of PDEs in the control of intracellular cyclic nucleotides in pituitary cells at rest was indicated in experiments with 3-isobutyl-1-methylxanthine, a general inhibitor of these enzymes (218, 334), whereas the relevance of multidrug resistance proteins in the control of cyclic nucleotide intracellular levels at rest was suggested based on experiments with probenecid, an inhibitor of this pump (224, 332).

In many cell types, Ca^{2+} and cyclic nucleotide signaling pathways are tightly interconnected at the level of intracellular messenger generation and at the level of their intracellular effectors. That is also the case with pituitary cells. Figure 9 summarizes the effects of VGCI on the cyclic nucleotide signaling pathway in pituitary cells. Both normal and immortalized GH pituitary cells express Ca^{2+} -inhibitable AC, as indicated by the ability of elevated Ca^{2+} to inhibit cAMP production in rat broken cells and cell membranes. In these

experiments, concentrations of Ca^{2+} required for inhibition of AC activity were in the range observed in intact pituitary cells, suggesting that spontaneous electrical activity may influence cAMP production. In intact pituitary cells, VGCI also attenuates intrinsic AC activity independently of the status of PDEs (218). In GH_3 cells, there is an intimate colocalization of ACs with L-type Ca_v channels and capacitative Ca^{2+} entry channels (276). RT-PCR and Western blot analysis confirmed the expression of Ca^{2+} -inhibitable AC3, AC5/6, and AC9 in pituitary cells (218). AC9 is also expressed in AtT-20 cells, and its activation leads to stimulation of VGCI, which inhibits the enzyme. The negative feedback effect of Ca^{2+} on the enzyme activity is mediated by calcineurin (337).

The nitric oxide synthase-sGC signaling pathway is also modulated by Ca^{2+} influx through Ca_v channels. Pituitary cells express neuronal and endothelial nitric oxide synthase, which require spontaneous VGCI for their activation. This in turn results in nitric oxide-dependent stimulation of sGC (333, 334). In pituitary cells, there is

also Ca^{2+} -independent and cAMP/PKA-dependent activation of sGC (299, 333). In contrast, facilitation of VGCI in high K^{+} -depolarized pituitary cells leads to inhibition of sGC activity, suggesting that Ca^{2+} also serves as a negative feedback to break the stimulatory action of nitric oxide on enzyme activity in intact pituitary cells (335). It is also well established that Ca^{2+} plays important roles in the control of PDE-1 activity in other cells types. Roles of these enzymes in the control of cyclic nucleotide signaling have not been systematically investigated in pituitary cells.

The excitability of pituitary cells may also influence multidrug resistance protein-mediated cyclic nucleotide efflux. In normal and GH_3 pituitary cells, abolition of Na_b conductance by complete or partial replacement of extracellular Na^{+} with organic cations or sucrose not only induces a rapid and reversible hyperpolarization of cell membranes and inhibition of AP firing, but also rapidly inhibits cyclic nucleotide efflux. Valinomycin-induced hyperpolarization of the plasma membranes also inhibits cyclic nucleotide efflux, whereas depolarization of the cell membrane facilitates cyclic nucleotide efflux. In contrast to AC and sGC, AP-driven Ca^{2+} influx is not coupled to the control of the cyclic nucleotide efflux pump activity. It appears that changes in the resting membrane potential not only influence steady-state Ca^{2+} influx through Ca_v channels and switches the pattern of firing between TTX-sensitive and dihydropyridine-sensitive channels, but also represents the signal for changes in cyclic nucleotide pump activity (224).

3. AP-secretion coupling

Neurotransmitter and hormone secretion is a process of synthesis and release of proteins out of the cell. The path of a protein destined for secretion has its origins in the rough ER, and the protein then proceeds through the many compartments of the Golgi apparatus before ending up in small secretory vesicles containing neurotransmitters (neurons) and large dense-core vesicles (also known as secretory granules) containing hormones (neuroendocrine and endocrine cells). Biogenesis of both types of secretory vesicles (formation of immature vesicles and their remodeling to form mature secretory vesicles) was followed over a significant distance, using actin- and the microtubule-based cytoskeletons along with several motor proteins. Vesicles in the reserve pool are loosely tethered to the plasma membrane, whereas those that are docked are held within a bilayer's distance from the plasma membrane (<5–10 nm for synaptic vesicles). Stable docking probably represents several distinct, molecular states: the molecular interactions underlying the close and tight association of a vesicle with its target may include the molecular rearrangements needed to trigger bilayer fusion. Tethering and docking of a vesicle at the target membrane precedes the

formation of a tight core SNARE complex, a step called priming. Vesicle fusion is driven by SNARE proteins, which when triggered cause the vesicle membrane to merge with the plasma membrane, releasing the neurotransmitters/hormones into the synaptic cleft (for neurons) or extracellular space (for hormones). The trafficking of secretory vesicles toward the plasma membrane and their fusion with the plasma membrane is termed exocytosis (338).

In general, this process can occur in the absence of stimuli (constitutive exocytosis), or in response to stimuli (regulated exocytosis). The main difference between constitutive and regulated exocytosis is in the last two steps of exocytosis. In neuronal and endocrine exocytosis, there is priming of secretory vesicles, including all of the molecular rearrangements and ATP-dependent protein and lipid modifications taking place after the initial docking of a synaptic vesicle but before fusion, and a rise in $[\text{Ca}^{2+}]_i$ is needed to trigger nearly instantaneous neurotransmitter release. In other cell types, whose secretion is constitutive (*i.e.*, continuous, Ca^{2+} -independent, nontriggered), there is no priming and no need for elevation in $[\text{Ca}^{2+}]_i$ to complete fusion of secretory vesicles. In cells secreting by regulated exocytosis, not only VGCI but also GPCR-mediated Ca^{2+} mobilization from the ER can initiate vesicle release. Other signaling molecules triggered by activation of GPCRs also contribute to the control of hormone release by exocytosis, suggesting that the term stimulus-secretion coupling is more appropriate for regulated exocytosis, independent of the pathways involved (338–340). Here we will use the term AP secretion coupling to focus on the role of spontaneous electrical activity and the accompanying VGCI in hormone secretion by endocrine pituitary cells.

Pituitary cells secrete hormones in a Ca^{2+} -regulated manner. Calcium plays several roles in this process, including priming of secretory granules, and triggering of granule exocytosis (101, 341–343). The last step has a low Ca^{2+} affinity and requires an elevation of intracellular Ca^{2+} that results from the opening of Ca^{2+} channels or release of Ca^{2+} from intracellular stores (which does not occur in unstimulated pituitary cells). Early experiments by Douglas and Shibuya (344) showed that removal of Ca^{2+} and blockade of L-type Ca_v channels by dihydropyridines diminish α -MSH release, whereas facilitation of VGCI by high K^{+} -induced depolarization of cells facilitated hormone release. Our early experiments also showed that removal of bath Ca^{2+} and addition of nifedipine reduced $[\text{Ca}^{2+}]_i$ and diminished GH and PRL release (345). However, we were unable to observe any significant changes in basal release of LH, FSH, TSH, and ACTH. In contrast, high K^{+} -induced depolarization and the conse-

quent Ca^{2+} influx stimulated secretion of all six hormones in a mixed population of pituitary cells (345). These observations could suggest that only melanotrophs, lactotrophs, and somatotrophs exhibit spontaneous firing of APs.

However, as discussed above, all endocrine pituitary cells are excitable. More recently, we showed that lactotrophs, somatotrophs, and gonadotrophs from the same preparation exhibit spontaneous firing of APs, but only in somatotrophs and lactotrophs is the spontaneous electrical activity coupled to hormone secretion (184). Specifically, in perfused pituitary cells, the level of basal secretion of PRL from lactotrophs and GH from somatotrophs is high, whereas basal secretion of LH from gonadotrophs is negligible, although these cells also exhibit spontaneous activity. The near absence of secretion from gonadotrophs, even in the presence of electrical activity, is in contrast with neurotransmitter release from synapses, where single APs are typically effective at evoking release. In the case of the synapse, there is spatial colocalization of Ca^{2+} channels and secretory vesicles, so that single Ca^{2+} nanodomains are capable of evoking release (346). Such extreme colocalization is not present in endocrine and neuroendocrine cells, so secretion is evoked by the overlap of many Ca^{2+} nanodomains. This is well illustrated in experiments with melanotrophs, in which all classes of Ca_v channels couple with equal efficiency to exocytosis (347).

The difference in basal secretion between gonadotrophs and lactotrophs/somatotrophs is likely due to the very different basal levels of $[\text{Ca}^{2+}]_i$ and the location of release sites relative to Ca^{2+} channels. In the presence of Bay K 8644, the duration of single APs in gonadotrophs is prolonged, resulting in larger $[\text{Ca}^{2+}]_i$ transients and initiation of LH release (184). On the other hand, in somatotrophs, conversion of pseudo-plateau bursts to single APs by BK channel blockade reduced spontaneous Ca^{2+} influx (185). Similarly, single APs evoke only a small amount of secretion from chromaffin cells, whereas prolonged depolarization induces massive secretion (348). So the much higher basal level of $[\text{Ca}^{2+}]_i$ in lactotrophs and somatotrophs compared with gonadotrophs leads to the higher basal hormone secretion in these cells. Indeed, blockage of Ca^{2+} channels with nifedipine reduces basal secretion from lactotrophs and somatotrophs to levels similar to the basal secretion level from gonadotrophs (184). The dependence of basal GH secretion on the amplitude of spontaneous Ca^{2+} transients is nicely shown in measurements of $[\text{Ca}^{2+}]_i$ by imaging microscopy and GH secretion by plaque assay in the same cells (186). The same study also showed that the amount of GH released correlates with both the amplitude and the frequency of Ca^{2+} transients. The L-type Ca_v channels and K_ir channels play a critical role in the frequency control of Ca^{2+} transients

and PRL release (125). Single-cell recordings of secretion in lactotrophs using single green fluorescent atrial natriuretic peptide-labeled secretory vesicles and FM 4-64 revealed that basal hormone release, also known as spontaneous secretion, is slow compared with stimulated exocytosis, which occurs rapidly. The authors also observed differences between two secretion modes in lactotrophs, both in terms of kinetics and in the rates of loading and discharge of the two probes (349).

V. Signaling by Gap Junction Channels

Pituitary cells are not randomly distributed throughout the gland but are highly organized in three-dimensional network structures. Folliculostellate cells make the most impressive network (350). In rodents, this network starts to develop 10 d after birth and is fully developed by the peripubertal period (351). The GH-producing cells also form a network shortly after GH-expressing cells are formed (embryonic d 16), and this network undergoes profound changes, especially during puberty (352). Different contact and signaling molecules could contribute to the formation of these networks, including cadherins (353). Such networks provide the basis for coordinating the activities of different members of the endocrine pituitary population. There are two mechanisms for communication between cells: electrical and chemical. The first requires cells to be coupled through low resistance pathways such as gap junctions. The second requires the release of chemical transmitters, which act as agonists for receptors expressed in electrically interconnected (autocrine mode of regulation) and neighboring cells (paracrine mode of regulation). In this section, we discuss the expression of gap junction proteins in pituitary cells, and in *Sections VI–VIII*, we focus on receptor channels and GPCRs.

The cytoplasmic compartments of neighboring cells are frequently connected by gap junctions, which are clusters of intercellular channels that form a cytoplasmic bridge between adjacent cells to allow for the cell-to-cell transfer of ions, metabolites, and small messenger molecules, including Ca^{2+} , ATP, cAMP, cADP ribose, and IP_3 . Thus, gap junction channels provide an effective mechanism for electrical, Ca^{2+} , and metabolic coupling, depending on the size of the pore. Vertebrate intercellular channels are made up of a multigene family of conserved proteins called connexins. The invertebrate gap junction channels, called innexins, have no detectable sequence homology with vertebrate gap junctions, although they exhibit similar functions and membrane topology. Recently, another family of junctional coupling proteins, called pannexins, has been identified in mammals. These channels have low sequence homology, but general structure similarity, to a family of

innexins. The gap junction proteins show identical membrane topology: four TM domains connected by two extracellular loops and one intracellular loop with both N and C termini in the cytosol. Such structure is essential for the formation of hexameric pore complexes termed hemichannels, which are large, nonselective ion channels expressed in the plasma membrane before their assembly into gap junctions (354).

A. Connexins

Mammalian connexins are encoded by a gene family of 20 members. Six connexin subunits assemble in a circle to form hemichannels known as connexons in the plasma membrane that can dock to another hemichannel in the plasma membrane of an adjacent cell to form an intercellular channel that spans the gap between the two cells. Hemichannels can contain a single type of connexin (homomeric), or multiple connexins (heteromeric) to form the hemichannel pore, and two identical connexons or different connexons can join to form either homotypic or heterotypic intercellular channels, respectively. The presence of heteromeric connexins and heterotypic intercellular channels can produce a diverse group of structurally different intercellular channels, with different permeabilities and/or function. A variety of other factors, including membrane potential, Ca^{2+} , pH, and phosphorylation of channels, can modulate gap junction channels. Several neurotransmitters and hormones, such as dopamine, acetylcholine, GABA, and estrogens, have also been found to alter intercellular channel activity. Because of the large size of the channel pore, several diffusible second-messenger molecules are potential candidates for mediating the propagation of intercellular Ca^{2+} waves via gap junctions, including IP_3 and Ca^{2+} itself (355, 356).

Gap junctions in the anterior pituitary were initially shown by Fletcher *et al.* (5). Subsequent studies have revealed that gap junctions are formed between folliculostellate cells and that the number of gap junctions increases with the developmental increase in the number of these cells. Other physiological and experimental conditions also influence the gap junction connections of the folliculostellate cells (56, 357, 358). Electrical coupling between some, but not all, folliculostellate cells was observed (359). The network of these cells participates in the long distance conduction of information in intact anterior pituitary cells, which involves Ca^{2+} (350). It has also been suggested that the gap junction-mediated network of folliculostellate cells provides messages necessary for the hormone release by anterior pituitary cells (357).

Northern blot analysis and immunostaining studies indicated the expression of connexins 26, 32, and 43 in pituitary cells (360), and localization of connexin 43 in folliculostellate cells and pituicytes (361). In mink anterior

pituitary, changes in connexin 43 expression in folliculostellate cells are associated with seasonal changes in PRL content (362). $\text{TGF}\beta 3$ may act on folliculostellate cells to increase gap junction communication, resulting in stimulation of fibroblast growth factor by these cells (363). Locally produced adenosine stimulates connexin 43 expression and gap junctional communication in folliculostellate cells (364). In a folliculostellate cell line, proinflammatory cytokines also modulate the level of connexin 43 expression (365), and $\text{TNF-}\alpha$ causes cell uncoupling mediated by connexin 43 dephosphorylation (366). The recent development of the S100b-GFP transgenic rat with expressed green fluorescent protein specifically in folliculostellate cells in anterior pituitary will facilitate further work on the relevance of this network in pituitary cell functions (367).

It has also been suggested that the endocrine anterior pituitary cells could be coupled by gap junctions. In a hypothalamo-pituitary slice preparation from the tilapia fish, electrotonic coupling between neighboring cells was detected, as well as diffusion of Lucifer Yellow between cells. Such coupling was observed in about one third of the cells (368). Diffusion of Lucifer Yellow was also observed in intact anterior pituitary cells up to 300 μm apart from its site of induction. In addition to folliculostellate cells, coupling was also observed between lactotrophs and somatotrophs (369). This conclusion was confirmed using $[\text{Ca}^{2+}]_i$ measurements by real-time confocal imaging in pituitary slices and halothane, a gap junction blocker. It appears that somatotrophs in pituitary slices are either single units or arranged in synchronized gap junction-coupled assemblies scattered throughout the anterior lobe (370).

B. Pannexins

Pannexins are a three-member family of channels. Unlike connexins and innexins, homomeric pannexin 1 hexamers do not form gap junctions when expressed in mammalian cells but operate as hemichannels (371). They are activated by membrane depolarization, mechanical stress, and in a receptor-dependent manner. The channel pore is permeable to ions, small molecules, and metabolites up to 1 kDa, including ATP, ADP, nicotinamide adenine dinucleotide, cyclic nucleotides, and IP_3 . Such wide permeability probably accounts for their numerous nonjunctional functions in variable cell types (372, 373). ATP-gated P2X_7 receptor channels are the potential partners in Panx1 -mediated signaling (374, 375). However, the details regarding the association of pannexin 1 with purinergic receptors and their modes of interaction have not been clarified. This includes a lack of information regarding the specificity of physical associations between purinergic receptors and pannexins. Recently, it has been shown that rat anterior pituitary cells expressed pannex-

ins 1 and 2 but not pannexin 3. The mRNA transcripts for two novel pannexin 1 splicing isoforms were also identified in pituitary cells. Heterologous expression of the three pannexin 1 isoforms and pannexin 2 formed homomeric and heteromeric complexes in any combination. All three pannexin 1 isoforms physically associate with several ATP-gated (purinergic) receptor (P2XR) channels, which are expressed endogenously in pituitary cells (376).

VI. Signaling by Receptor Channels

The pattern of electrical activity in single pituitary cells is also modulated by chemical signals. These signals act as ligands or agonists for specific plasma membrane receptors expressed in pituitary cells. Many of these agonists are delivered by hypothalamic neurons and are released into the posterior lobe or into the hypophyseal portal systems. Other agonists are secreted by pituitary cells and act in autocrine and paracrine manners. Agonists can also reach the pituitary cells through the general blood circulation. There are several classes of stimuli, including neurotransmitters, hormones, eicosanoids (metabolites of arachidonic acid), growth factors, and chemokines. Four groups of receptors recognize these agonists: extracellular ligand-gated ion channels (receptor channels), GPCRs, enzyme-linked receptors (receptor tyrosine kinases, natriuretic peptide receptors, cytokine receptors, and intracellular enzyme-containing receptors), and intracellular steroid receptors. There are other channels that are activated or modulated by ligands, such as IP₃Rs and RyRs that are expressed in the ER membrane (see *Section III.C*) and cyclic nucleotide-regulated channels of the plasma membrane (see *Section III.A.6*), and they are known as intracellular ligand-gated ion channels. In this section, we review the literature on the role of receptor channels in electrical activity, whereas the role of GPCRs in electrical signaling is summarized in *Sections VII and VIII*. Pituitary cells also express the enzyme-linked receptors and the intracellular steroid receptors, but their roles in electrical activity and Ca²⁺ signaling have not been systematically investigated and will not be reviewed here.

Receptor channels contain two functional domains: an extracellular domain that binds an agonist, and a TM domain that forms an ion channel. Because these proteins combine transmitter binding and channel functions into a single molecular entity, they are also called ionotropic receptors. The agonists for these channels are acetylcholine, GABA, glycine, 5-HT, glutamate, and ATP. Based on ion conductivity, receptor channels are divided into two classes: the excitatory cation-selective channels, operated by acetylcholine, glutamate, 5-HT, and ATP; and the anion-selective channels, activated by GABA and glycine, which

are usually inhibitory. With the exception of glycine, these agonists can also activate so-called metabotropic receptors, which belong to the family of GPCRs. These receptors do not have an ion channel as a part of their structure, but they can affect channel activity through one or several metabolic steps (see *Sections VII and VIII*).

From a structural point of view, receptor channels belong to three families of evolutionary related proteins (377, 378). The acetylcholine, 5-HT, GABA, and glycine-activated receptor channels are grouped as one family, known as ligand-gated ion channels of the Cys-loop family. These channels are composed of five subunits (pentamers), each of which contributes to the ionic pore. All subunits have a large extracellular N-terminal region followed by four hydrophobic TM segments and an extracellular C terminus (379). The second family represents glutamate-activated receptor channels, which are also composed of four TM segments, but their TM2 segment forms a pore-loop structure, entering and exiting the cell membrane from the intracellular side. Thus, the N terminus is extracellularly located, whereas the C terminus is intracellularly located and is regulated by signaling molecules, including the kinases. A detailed analysis of the intrasubunit interactions that govern glutamate-receptor assembly indicates that these channels are dimers of dimers (380). The third family is known as P2XR channels. Members of this family have only two TM domains, with the N and C termini facing the cytoplasm. As with acetylcholine and glutamate channels, the functional diversity of P2XR channels is generated by subunit multimerization. The functional channels are composed of three subunits (381).

A. Cys-loop family of receptor channels

1. Nicotinic acetylcholine receptor channels

Acetylcholine is an agonist for two classes of membrane receptors: muscarinic and nicotinic acetylcholine receptors. Muscarinic receptors belong to the GPCR superfamily of receptors. There are five subtypes of these receptors, termed M₁–M₅; the M₁, M₃, and M₅ receptors signal predominantly through the G_{q/11} pathway, whereas M₂ and M₄ receptors are coupled to the G_{i/o} signaling pathway (382). Nicotinic acetylcholine receptors (nAChRs) are a family of acetylcholine-gated channels. The nAChRs are more diverse, with genes encoding a total of 17 identified subunits that can assemble into a variety of pharmacologically distinct receptor subtypes. Muscle types of nAChRs are located postsynaptically at the neuromuscular junctions, where they mediate fast synaptic transmission of electrical signals from motor neurons. Neuronal types of nAChRs are expressed in the central and peripheral nervous system and are distributed post-, pre-, and perisyn-

aptically. The pore of activated channels is permeable to Na^+ and K^+ and, for some neuronal subtypes, to Ca^{2+} (383, 384).

The role of acetylcholine as a putative autocrine factor has been relatively well established in intermediate pituitary functions. Acetylcholine is released from frog melanotrophs onto M_1 receptors (385) and stimulates electrical activity and α -MSH release (386, 387). Functional nAChRs are described in porcine intermediate pituitary cells at both the whole-cell and single-channel levels (388). These channels are depolarizing, and their activation leads to facilitation of Ca^{2+} influx directly through the pore of the channel and indirectly by activating Ca_v channels (389). The possibility that nAChRs are cross-coupled to the PLC signaling pathway has also been proposed (390), whereas the role of these channels in secretion has not been studied. Deneff's laboratory (391) also suggested that acetylcholine acts as a paracrine factor in the anterior pituitary. This group observed that immunoreactivity for choline acetyltransferase, the enzyme catalyzing the biosynthesis of acetylcholine, was present in anterior pituitary cells and that acetylcholine was released by high K^+ -depolarized pituitary cells. They further showed that acetylcholine stimulates secretion by corticotrophs and the corticotroph cell line AtT-20 through activation of nAChRs (4). The structure of nAChRs, their biophysical and electrophysiological properties, and Ca^{2+} signaling function have not been studied in the anterior pituitary cells.

2. 5-Hydroxytryptamine receptor (5-HT₃R) channels

The neurotransmitter 5-HT is a native agonist for seven receptors. Six of these are heteromeric GPCRs, whereas the 5-HT₃R operates as a receptor channel (392). The 5-HT₃R exists as a pentamer of four TM subunits that form a cationic-selective channel. Three 5-HT₃ subunits (5-HT_{3A}, 5-HT_{3B}, and 5-HT_{3C}) have been cloned, but only homomeric 5-HT_{3A} and heteromeric 5-HT_{3A+3B} form functional receptors when expressed in heterologous systems. A short form of the 5HT_{3A} subunit was also identified, but this splice form does not differ physiologically from the full-size channel. Homomeric and heteromeric channels mediate a rapidly activating, desensitizing, inward current that predominantly carries Na^+ and K^+ . Some forms are also permeable to Ca^{2+} (393). 5-HT₃R are expressed throughout the central and peripheral nervous systems, where they mediate a variety of physiological functions. The receptors are also involved in information transfer in the gastrointestinal tract, and in the enteric nervous system they regulate gut motility and peristalsis (394). The hypothalamic actions of 5-HT and its receptors, including the control of PRL, gonadotropin, CRH, AVP, and oxytocin release, are well characterized (re-

viewed in Refs. 54 and 395). In addition, 5-HT₃R are likely to be expressed in the fish pituitary and to play important roles in signaling and secretion (396). It has also been suggested that functional 5-HT₃R are expressed in mammalian pituitary cells in culture and L β T3 cell lines. The evidence includes RT-PCR analysis and pharmacological studies on basal and agonist-stimulated LH and ACTH release, but not the electrophysiological characterization of 5-HT₃R current and its role in signaling (397–400).

3. GABA receptor channels

GABA acts as a neurotransmitter through three structurally and pharmacologically distinct classes of receptors: G protein-coupled GABA_B receptors and ligand-gated GABA_A and GABA_C chloride channels. There are two GABA_B subunits, and functional receptors are probably heterodimers; the specific agonist for these receptors is baclofen (401). To date, 16 different GABA_A subunits (α 1-6, β 1-3, γ 1-3, δ , ϵ , π , and θ) have been cloned and sequenced from the mammalian nervous system. Additional variants arise through alternative splicing (402). The GABA_A receptor is a pentameric assembly derived from a combination of various subunits. The preferred combination includes two α -, two γ -, and one β -subunit. However, the colocalization of these three types of subunits is not an absolute requirement for the formation of functional channels. The great diversity of receptor subunits leads to profound differences in tissue distribution, ontogeny, pharmacology, and regulation of GABA_A receptors. These receptors are targets for many drugs in wide clinical use, including benzodiazepines, barbiturates, neurosteroids, ethanol, and general anesthetics, which increase the conductance through the pore of the channels. A specific agonist is muscimol, and a specific blocker is bicuculline (403, 404). The molecular components of GABA_C receptors are ρ 1-3 subunits, which form functional channels without assembling with GABA_A- α and β -subunits. These receptors are specifically activated by (+)-cis-2-aminomethylcyclopropane carboxylic acid (405).

GABA_{A/C} channels are chloride ion channels, and the nature of their actions depends on the $[\text{Cl}^-]_i$. In the majority of adult neurons, $[\text{Cl}^-]_i$ is low and activation of GABA_{A/C} channels leads to hyperpolarization of the cell membrane and silencing of electrical activity. In developing neurons, however, $[\text{Cl}^-]_i$ is relatively high and GABA channels are depolarizing, leading to facilitation of electrical activity and VGCI. Chloride homeostasis in most brain cells is controlled by two electrically neutral cation/chloride cotransporters, called NKCC1 and KCC2. The ubiquitously expressed NKCC1 derives energy from the electrochemical gradient for Na^+ to take up Cl^- , whereas KCC2 uses the K^+ gradient to facilitate Cl^- extrusion

(406). The developmental switch from GABA excitation to inhibition could be determined by down-regulation of NKCC1 and up-regulation of KCC2 transporters (407).

All three GABA receptor subtypes are expressed in the pituitary gland (408–410). High radioactivity was detected in pituitary cells 3–6 min after injection of ^{14}C -GABA (411), and specific [^3H]muscimol binding sites were also identified in membranes from rat anterior pituitary cells (408, 412). The RT-PCR analysis indicated the presence of $\alpha 1$, $\alpha 4$, $\beta 1$, $\beta 2$, $\beta 3$, and $\gamma 2$ -subunits in a mixed population of anterior pituitary cells (409, 412–414). More recently, mRNA transcripts for $\alpha 2$, $\alpha 3$, $\alpha 5$, $\alpha 6$, $\gamma 1$, $\gamma 3$, θ , π , δ , and ε -subunits were found in anterior pituitary cells, and the expression of $\alpha 3$, $\alpha 5$, and $\alpha 6$ mRNAs was somewhat lower. Immunocytochemical studies further showed the expression of $\alpha 1$ - and $\beta 1$ -subunit proteins in all secretory anterior pituitary cells (414). Immunohistochemical labeling revealed that frog melanotrophs *in situ* and in cell culture were intensely stained with $\alpha 2$, $\alpha 3$, $\gamma 3$, and $\beta 2/\beta 3$ -subunits (415). Thus, the whole repertoire of mRNAs for GABA_A receptor subunits is present in the pituitary gland, providing the possibility for variable and cell type-specific combinations of subunits into pentamers.

There have been contradictory reports about the nature of GABA actions in pituitary cells. Earlier studies suggested that GABA inhibits PRL release *in vitro*. It has also been reported that muscimol inhibits PRL release *in vitro* and that bicuculline and picrotoxin block the action of GABA and muscimol, suggesting the presence of hyperpolarizing GABA_A receptors in these cells and their potential inhibitory role in VGCI and secretion (for references, see Ref. 414). Inhibitory effects of GABA on α -MSH secretion from the intermediate lobe and on AVP and oxytocin from the posterior pituitary were also reported by several laboratories (for references, see Ref. 416). Contrary to these findings, GABA and muscimol were found to stimulate, rather than inhibit, secretion of ACTH, GH, LH, and TSH from pituitary cells *in vitro* (417–419). It has also been shown that GABA increases $[\text{Ca}^{2+}]_i$ in a majority of the anterior pituitary cells, including lactotrophs, gonadotrophs, and $\alpha\text{T3-1}$ cells. This effect is mimicked by muscimol, antagonized by picrotoxin, and abolished by removal of extracellular Ca^{2+} (414, 420, 421). In frog melanotrophs, GABA also stimulates Ca^{2+} influx and α -MSH release (422). Augmentation of exocytosis and the depolarizing effect of GABA at high $[\text{Cl}^-]_i$ has also been documented in melanotrophs from mouse pituitary tissue slices (236) and frogs (284, 423). Stimulation of GABA_C receptors in somatotrophs also increases $[\text{Ca}^{2+}]_i$ (424), further supporting the view that GABA receptors in the majority of pituitary cells are depolarizing, leading to stimulation of VGCI.

Electrophysiological measurements provided more conclusive evidence for the expression of GABA_A channels. The GABA-induced activation of a chloride current with pharmacological properties of GABA_A receptors was initially shown in bovine lactotrophs (425), frog melanotrophs (426), and neonatal rat anterior pituitary cells (427). GABA-induced currents were also detected in posterior pituitary nerve terminals (416, 428). It has also been suggested that the activity of GABA_A channels depends on the status of sGC activity in frog melanotrophs (429). To clarify whether GABA-induced current is depolarizing or hyperpolarizing, it is essential to preserve $[\text{Cl}^-]_i$, which was done in intermediate and anterior pituitary cells using gramicidin-perforated patch clamp recordings. These experiments showed that the reversal potential of GABA current is positive to the resting membrane potential, indicating that $[\text{Cl}^-]_i$ in the majority of pituitary cells from adult animals is elevated and that activation of GABA_A channels leads to Cl^- efflux causing depolarization. GABA-induced depolarization of pituitary cells was associated with either an increase in the frequency of APs in spontaneously firing cells or a sustained depolarization (284, 414).

In accordance with these results, the expression of NKCC1 in postpubertal anterior pituitary cells is high, whereas mRNA expression for KCC2 (if present) is low (414), and imaging studies suggested that $[\text{Cl}^-]_i$ in lactotrophs is around 50 mM (231). In posterior pituitary nerve endings, however, $[\text{Cl}^-]_i$ was estimated to be around 20 mM, and the GABA_A current is hyperpolarizing (416). The contradiction in the field about the nature of GABA actions in anterior pituitary cells might be explained in part by the presence of GABA_B receptors, because their activation leads to inhibition of spontaneous electrical activity and basal AC activity (402), and both Ca^{2+} and cAMP regulate exocytosis in these cells (343, 430–432).

Although the majority of cells in the anterior and intermediate lobes express GABA receptors and their *in vitro* activation triggers substantial Cl^- influx and alters the pattern of electrical activity, Ca^{2+} signaling, and hormone secretion, the *in vivo* operation and physiological relevance of this signaling pathway has not been clarified (433). In search of a PRL inhibitory factor, Schally *et al.* (434) isolated GABA from the hypothalamus. Subsequent studies showed that GABA is released from tuberoinfundibular and other hypothalamic regions, that concentrations of GABA in portal blood are higher than in peripheral blood, and that electrical stimulation of the median eminence induces a several-fold increase in the rate of GABA release (435), which could indicate that GABA acts in the pituitary as a hypothalamic neurohormone. However, it has also been reported that GABA is synthesized and released from intermediate and anterior pituitary

lobes (435–438), which could suggest that GABA acts as a paracrine factor. At the present time, little information exists about the mechanism of GABA release in the portal blood and pituitary. It has been suggested that substance P modifies hypothalamic GABA release (439) and that injection of estradiol leads to a several-fold increase in the intrapituitary GABA concentration (440).

4. Glycine receptor (GlyR) channels

GlyRs are pentameric proteins composed of three α -subunits and two β -subunits. In contrast to other members of this group of receptor channels, GlyRs do not have a counterpart in the GPCR receptor family. There are four isoforms of α -subunits, which have highly homologous sequences but different pharmacological and functional properties, and alternative splicing of α -subunits further increases GlyR heterogeneity. The α -subunit contains the ligand-binding site and is sufficient to form a functional homomeric channel, whereas the β -subunit modulates the pharmacological and conductance properties of the GlyRs. There are many similarities between GABA_A and GlyRs, including ion selectivity, which arise from their close and conservative evolutionary relationship. As with GABA_{A/C} receptors, the direction of the flux depends on the electrochemical gradient for Cl⁻. In contrast to GABA_{A/C} receptors, GlyRs are not expressed in the anterior pituitary. However, there are reports on the expression of these receptors in the nerve endings in posterior pituitary cells and their activation by taurine, a GABA-like amino acid that is released by pituicytes (441, 442).

B. Glutamate receptor channels

L-Glutamate is the major excitatory neurotransmitter in the CNS, acting as an agonist for eight members of GPCRs (443) and receptor channels, each encoded by 18 genes that assemble to form four major subtypes: AMPA (α -amino-3-hydroxy-5-methyl-4-isoxazole propionic acid); kainate; NMDA (*N*-methyl-D-aspartate); and δ receptor channels. Molecular cloning has revealed several subunits for each receptor group. Four AMPA receptor genes (GluR1–GluR4) denote the AMPA-sensitive family, whereas five kainate receptor genes (GluR5–GluR7, KA1, and KA2) make up the kainate subclass. For NMDA-receptor channels, seven subunits (NR1, NR2A–NR2D, NR3A, and NR3B) have been established. In addition, two δ -subunits exist, belonging to the GluR type, but the function of this particular subunit is unknown. Finally, the molecular diversity of NR1 and GluRs is further increased by variants created by alternative splicing and RNA editing. In addition to the specific structure and pharmacology, NMDA channels exhibit a different excitation behavior than the other channel types. These channels are

both ligand- and voltage-gated. Full activation of the NMDA receptor requires application of two ligands, L-glutamate and glycine. The NMDA receptors only become fully activated by glutamate after their Mg²⁺ block has been relieved by membrane depolarization. Kainate and AMPA-receptor subunits do not form mixed channel complexes, but both types of receptors can be expressed in the same neuron. Native AMPA receptors are either homomeric or heteromeric oligomers composed of these multiple subunits (444).

Glutamate has numerous well-established indirect effects on pituitary hormone secretion by modulating hypothalamic functions (445). In addition, several reports have suggested that glutamate directly affects cells of the anterior and intermediate lobes. However, there are some contradictions in these reports. Initially, it was reported that glutamate stimulates PRL release in perfused pituitary cells, and this effect is abolished by a selective non-competitive NMDA receptor antagonist (446). Further work in this field suggested a dual effect of glutamate on PRL release, consisting of a stimulatory effect mediated via receptor channels and an inhibitory effect via GPCRs (447). Others reported inhibitory effects of kainate and NMDA on PRL release in static cultures (448). A stimulatory effect of glutamate through non-NMDA receptors on LH release was also reported (449), and kainate-2 mRNA was detected in embryonic rat pituitary tissue (450). Double immunohistochemistry suggested that only a fraction (4–11%) of all secretory anterior pituitary cells express NMDA receptors (451). Single-cell Ca²⁺ measurements showed a glutamate-induced rise in [Ca²⁺]_i in TRH- and GHRH-responsive rat cells (452). In tilapia PRL cells, glutamate also induced a rise in [Ca²⁺]_i due to cell depolarization and activation of Ca_v channels (453). No data on the electrophysiological characterization of glutamate receptor channels in anterior pituitary cells are available. In contrast, the expression of these receptor channels in cells from the intermediate lobe was demonstrated by patch clamp recording of glutamate-induced current, and pharmacological characterization of these responses was consistent with the presence of AMPA-type glutamate channels in these cells (454). Single-cell secretory data confirmed that activation of these channels is sufficient to trigger α -MSH release (455), whereas agonists specific for glutamate GPCRs were unable to trigger release of this hormone (456).

C. Purinergic receptor channels

ATP is released by excitable and nonexcitable cells and acts as an extracellular messenger for two families of purinergic receptors: seven-TM domain P2Y receptors (P2YRs) and two-TM domain P2XR channels. The agonist actions of ATP are terminated by several enzymes,

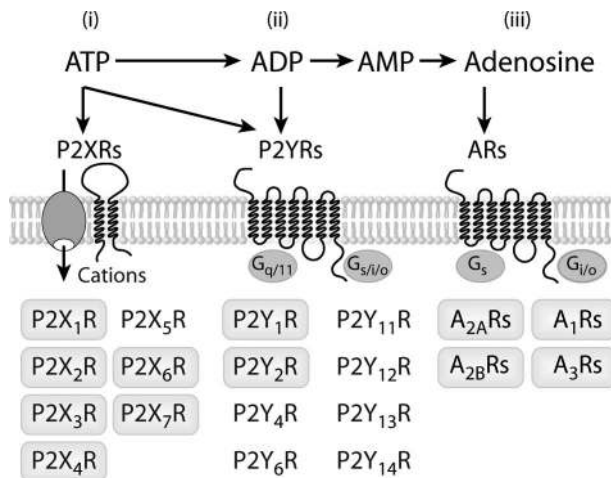

FIG. 10. ATP acts as an extracellular messenger in pituitary cells. The extracellularly released ATP is hydrolyzed by two enzyme families, ectonucleotide pyrophosphatase/PDE and ectonucleoside triphosphate diphosphohydrolase, generating ADP and AMP, whereas AMP is efficiently hydrolyzed by the ecto-5'-nucleotidase family of enzymes, generating adenosine. ATP is an agonist for two TM domain P2X receptors (P2XRs) and 7TM domain P2YRs, whereas ADP activates a few P2YRs but no P2XRs. Adenosine also acts as an agonist for four GPCRs, called adenosine receptors (ARs). Rectangles indicate receptors expressed in pituitary cells.

which hydrolyze ATP to ADP, AMP, and adenosine. ADP and adenosine also act as extracellular messengers; ADP activates a few P2YRs but not P2XR, whereas adenosine acts as an agonist for four G protein-coupled adenosine receptors (Fig. 10). UTP (uridine-5'-triphosphate), UDP (uridine-5'-diphosphate), and UDP glucose are also native agonists for P2YRs. The purinergic signaling pathway is operative in the hypothalamo-posterior pituitary system as well as in the intermediate and anterior pituitary lobes (457).

P2XRs comprise a family of ATP-gated cation channels, which are expressed in numerous excitable and non-excitable cells and play important roles in a variety of physiological processes. Seven mammalian P2XR subunits, termed P2X1–7, and several nonmammalian subunits have been identified. Each subunit is composed of cytoplasmic N and C termini, two TM domains, and a large extracellular domain; and three subunits are required for formation of a functional receptor. P2XRs differ with respect to their ligand-selectivity profiles, antagonist sensitivity, and cation selectivity. Their activation leads to an increase in $[Ca^{2+}]_i$, with Ca^{2+} influx occurring through the pores of these channels and through Ca_v channels after the initial depolarization of cells by P2XR-generated currents. They can form ion permeable pores through homo- and heteropolymerization. The P2X7R also triggers other signaling pathways (458–460).

Single-cell Ca^{2+} measurements were instrumental in establishing the role of P2XRs in anterior pituitary cells. These experiments reveal functional P2XRs in all secre-

tory anterior pituitary cell types and raise the possibility that several subtypes of these channels are expressed in a cell type-specific manner (reviewed in Ref. 461). However, this method is of limited use for identifying the receptor subtypes expressed because the rapidly desensitizing homomeric and heteromeric P2XRs are not able to generate global Ca^{2+} signals (462). In more recent studies, molecular biology techniques combined with electrophysiology were used to better understand the structure of P2XRs expressed in anterior pituitary cells and their downstream signaling pathways. Quantitative RT-PCR analysis revealed that secretory cells abundantly express P2X2R and P2X4R, with less expression of other subunits. Western blot analysis showed the expression of P2X2R, P2X4R, and P2X7R at the protein level. Cloning experiments showed that rat anterior pituitary cells express two functional splice forms of the P2X2 subunit, termed P2X2a and P2X2b (463), and that mouse pituitary cells express three functional forms of the P2X2R subunit, termed P2X2a, P2X2b, and P2X2e. The P2X2b and P2X2e subunits are missing 69 and 90 residues, respectively, in their C termini (464). When expressed as homomeric channels, three splice forms of P2X2R differ in the rate of receptor desensitization; P2X2eR desensitizes most rapidly, at a rate comparable to that observed in cells expressing P2X1R and P2X3R, whereas the rate of P2X2bR desensitization is faster than P2X2a but slower than P2X2e receptors (464). Deletions in the C terminal of P2X2aR also effectively reduced the peak amplitude and duration of Ca^{2+} signals, indicating a role of Arg³⁷¹-Pro³⁷⁶ (P2X2R numbering) in receptor desensitization (465, 466). The physiological relevance of these splice forms is in the formation of functional heteromers, which desensitize faster than full-size receptors but slower than the homomeric splice receptors. This in turn limits excessive ion influx but does not terminate signaling during prolonged agonist stimulation (467).

Functional P2X2Rs are expressed in gonadotrophs and somatotrophs, but not in other pituitary cell types (463). In gonadotrophs, their activation leads to firing of APs along with modulation of the frequency of firing in spontaneously active cells, accompanied by elevation in $[Ca^{2+}]_i$ that reflects Ca^{2+} influx through both P2X2R channel pores and Ca_v channels (468). The ATP-induced rise in $[Ca^{2+}]_i$ is sufficient to trigger LH release (468, 469). ATP also influences GnRH-induced current and membrane potential oscillations in an extracellular Ca^{2+} -dependent manner. These IP_3 -dependent oscillations are facilitated, slowed, or stopped depending on ATP concentrations and the time of ATP application (468). Thus, P2X2R could contribute to the pacemaking and modulation of GPCR-controlled electrical activity (468). Mice deficient in

P2X2R subunit are available and are fertile (470), but changes in pituitary function in such mice have not yet been studied.

The biophysical and pharmacological properties of recombinant rat P2X4R cloned from the pituitary gland have also been characterized. This receptor desensitizes with a rate comparable to that observed in cells expressing P2X2bR. In contrast to the P2X₂R, suramin, pyridoxal-phosphate-6-azophenyl-2',4'-disulfonic acid tetrasodium salt (PPADS), and reactive blue 2 are not effective antagonists of P2X₄R, but these receptors are sensitive to ivermectin, a high molecular weight lipophilic compound used as an antiparasitic agent in human and veterinary medicine. Ivermectin increases sensitivity of P2X4R to ATP, amplifies peak current amplitude in response to supra-maximal agonist concentrations, and delays receptor deactivation (471). These allosteric actions of ivermectin on P2X4R were successfully used in structural and functional characterization of recombinant receptors (471–473).

The PPADS insensitivity of P2XRs in TRH-responsive cells suggests that lactotrophs and/or thyrotrophs from the anterior lobe express functional P2X4Rs (474). This was confirmed recently by electrophysiological characterization of P2XR current in TRH-responsive cells. Activation of these channels leads to stimulation of electrical activity and promotion of voltage-gated and voltage-insensitive Ca²⁺ influx in these cells. In the presence of ivermectin, the peak amplitude of the current increases, as well as the sensitivity of the receptors to ATP, whereas the receptor deactivation slows. The activation of these receptors causes depolarization, which is sufficient to increase the frequency of APs and to initiate spiking in quiescent cells, as well as to facilitate Ca²⁺ influx through Ca_v channels. Calcium influx through the pore of P2X4Rs also contributes to ATP-induced Ca²⁺ signaling. Ivermectin also enhances ATP-induced PRL release, indicating that these receptors are expressed in lactotrophs (475). Further studies should clarify whether thyrotrophs also express these channels and whether there is any change in the status of electrical activity and Ca²⁺ signaling in pituitary cells from P2X7^{-/-} animals, which are available (476).

The physiological sources of ATP required for activation of purinergic receptors in the pituitary gland remain largely uncharacterized. The magnocellular neurons of the hypothalamus with nerve endings in posterior pituitary also contain ATP, and the specific pattern of APs originating from the cell bodies of these neurons has been suggested to control the release of this nucleotide (477). The extracellular ATP concentration in posterior pituitary can reach 4–40 μM, a concentration range sufficient to activate the majority of P2XRs (478). In addition to its action on nerve terminals of vaso-

pressinergic neurons in the posterior pituitary, released ATP probably acts on pituicytes (478, 479).

In the anterior pituitary, ATP probably acts as an autocrine/paracrine factor. Normal and immortalized GH₃ and αT3-1 pituitary cells release ATP at resting conditions, and such basal ATP release is enhanced in cells treated with ARL67156, an inhibitor of ectonucleotidases (480). GnRH-induced stimulation of gonadotropin release is accompanied by elevation in basal ATP release, suggesting that ATP is stored in the secretory vesicles of these cells (469). This is consistent with an earlier study showing Ca²⁺-dependent ATP release (247) and modulation of ATP release by PRL secretagogues (481). However, we did not observe ATP release when PRL release was evoked by depolarization of perfused pituitary cells (480), and the amplitude of GnRH-induced ATP release in perfused pituitary cells is too low to activate endogenous P2XRs. In other tissues, ABC-binding cassette transporters, pannexins, and P2X7R have been suggested to participate in nonvesicular ATP release (482). Interestingly, anterior pituitary cells express functional multidrug resistance proteins (224, 332) and P2X₇R (475, 483), which could contribute to ATP release.

The action of ATP as an autocrine/paracrine factor is critically dependent on its rapid metabolism by ectonucleotidases, which include members of the ectonucleotide triphosphate diphosphohydrolyase family of enzymes (E-NTPDase) and ecto-5'-nucleotidase, among others. Four of eight known E-NTPDases are expressed in the plasma membrane. These enzymes not only hydrolyze extracellular ATP and/or ADP to AMP but also metabolize other nucleotide tri- and diphosphates, including UTP and UDP, whereas cAMP is hydrolyzed by the ecto-5'-nucleotidase family of enzymes (484, 485). These enzymes are also expressed on the plasma membrane of pituicytes and neurosecretory posterior pituitary terminals (486). Extracellularly applied ATP is rapidly hydrolyzed by the isolated posterior pituitary accompanied by accumulation of adenosine, suggesting that these enzymes provide a pathway for the activation of adenosine receptors in this tissue and termination of ATP-induced vasopressin release (487). The mRNA transcripts for plasma membrane-located E-NTPDases 1, 2, and 3 are also expressed in pituitary tissues, cultured pituitary cells, and αT3-1, AtT-20, and GH₃ cell lines, and normal and immortalized pituitary cells rapidly metabolize ATP (480). Ecto-5'-nucleotidases (CD73), which generate adenosine from AMP, were found by immunocytochemistry in a fraction of anterior pituitary cells (364). Because anterior pituitary cells express the ADP-activated P2Y1 receptor and several adenosine-activated receptors, it is reasonable to suggest a role for

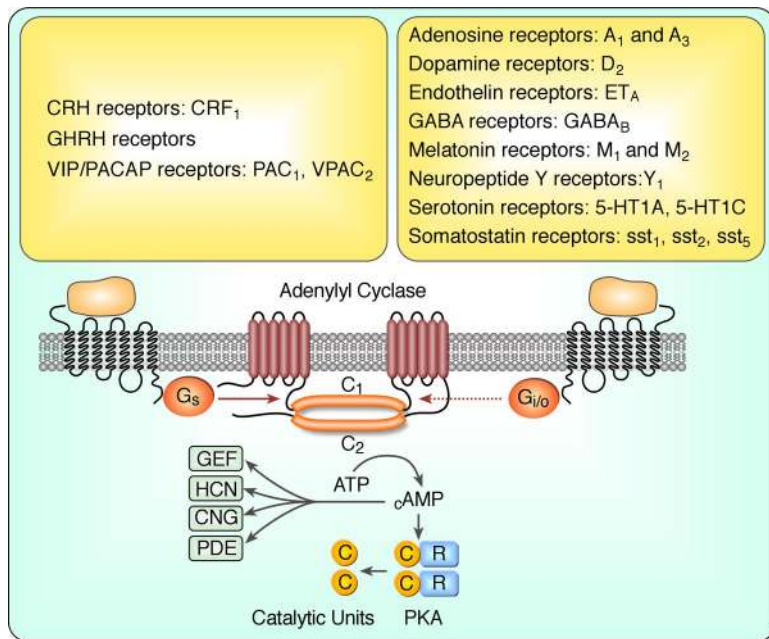

FIG. 11. Pituitary cells express GPCRs that engage the cAMP signaling pathway. *Top left*, A small number of neurohormones act through GPCRs coupled to G_s heterotrimeric proteins, and their α -subunit binds to AC, leading to stimulation of cAMP production. cAMP acts as an intracellular messenger by directly activating HCN and CNG channels, and indirectly through PKA. Binding of cAMP to PKA leads to dissociation of the catalytic (C) from regulatory (R) subunits. The messenger function of cAMP is terminated by PDEs and by efflux of cAMP mediated by cyclic nucleotide pumps (not shown). *Top right*, Coupling of several GPCRs to $G_{i/o}$ and/or G_z provide an effective mechanism for inhibition of adenylyl cyclase activity by their α -subunits. In addition to inhibition of the cAMP signaling pathway, these receptors also modulate electrical activity through $\beta\gamma$ dimers acting on K_{ir} and Ca_v channels (not shown).

ectonucleotidases in the sequential activation of purinergic receptors in the anterior pituitary (Fig. 10).

VII. Role of GPCRs in the Regulation of Electrical Activity

GPCRs are a very large and diverse superfamily of receptors that help define cellular responsiveness to extracellular signals. They share a common structure of seven α -helix TM domains with an extracellularly located N terminus and an intracellularly located C terminus and are coupled to heterotrimeric G proteins. These G proteins have α - and $\beta\gamma$ -subunits, which function as transducers to relay information to different signaling pathways, such as the PLC and AC signaling pathways, which operate as amplifiers by producing intracellular messengers. These messengers carry information to intracellular sensors and effectors. Downstream effectors produce one or more actions, including membrane depolarization/hyperpolarization, activation/inactivation of membrane Ca²⁺ channels, mobilization of Ca²⁺ from the ER, and sensitization/desensitization of the exocytotic machinery. The specific action initiated by the hormone agonist is determined by

the nature of the GPCR and the cell type (488, 489). In this section and the following section, we discuss the actions of GPCRs linked to the $G_{q/11}$, G_s , and $G_{i/o}$ signaling pathways and their impact on the electrical activity, cytosolic Ca²⁺ dynamics, and secretion from pituitary cells. The focus in our review will be on the role of G proteins, Ca²⁺, cyclic nucleotides, PKC, and PKA in control of channel activity, Ca²⁺ signaling, and secretion. These receptors have numerous other functions, including activation of the MAPK cascade, which are not discussed here because of their limited role in electrical signaling and calcium mobilization.

A. Stimulation of electrical activity by GPCRs

cAMP is a ubiquitous intracellular messenger generated by the AC family of enzymes that regulates numerous cellular responses, including electrical activity and VGCI. There are nine plasma membrane isoforms of these enzymes, each with two 6TM regions and two cytosolic domains, C1 and C2, which contain the catalytic region that converts ATP into cAMP (Fig. 11). The intrinsic activity of these enzymes is up-regulated by GPCRs linked to heterotrimeric G_s proteins and down-regulated by GPCRs linked to heterotrimeric $G_{i/o/z}$ proteins. There are several cAMP signaling effectors: PKA, PDEs, CNG and HCN channels, and the exchange proteins guanine nucleotide exchange factors (GEFs) that activate small GTP binding protein Rap1. PKA is composed of two regulatory subunits (R) and two catalytic subunits (C) (Fig. 11). Binding of cAMP to the R subunits enables the C subunits to phosphorylate different substrates, including the plasma membrane channels. A family of PKA-anchoring proteins determines the cellular localization of PKA. The cross talk between cAMP and Ca²⁺ is important in the control of cellular functions. In general, activation of receptors linked to G_s increases [Ca²⁺]_i by up-regulating electrical activity. In cells expressing HCN and/or CNG channels, this occurs through their activation and the subsequent depolarization of the plasma membrane and facilitation of Ca_v channel activity. PKA also phosphorylates numerous plasma membrane channels, including Ca_v channels, leading to facilitation of excitability of cells. Phosphorylation of other channels, such as Na_v, down-

regulates excitability or changes excitability from Na^+ to Ca^{2+} spikes (2).

GPCRs linked to the G_s -signaling pathways are operative in endocrine pituitary cells. The G_s -signaling pathway in corticotrophs is triggered by hypothalamic CRH (490). Somatotrophs express two receptors coupled to the G_s -signaling pathway, GHRH (491) and VIP/PACAP (47). VIP/PACAP receptors are also present in mammalian melanotrophs (492), lactotrophs (54), and folliculostellate cells (493). Some eicosanoids may also signal through this pathway in pituitary cells (494). The lack of expression of typical G_s -coupled receptors in other pituitary cell types does not mean that the cAMP signaling pathway is not operative. These cells also express ACs, and their activities are regulated by other mechanisms. This could include the cross-coupling of other GPCRs to the G_s signaling pathway, as suggested by stimulation of AC by GnRH receptors in other cell types (495, 496). VGCI also affects cAMP signaling in pituitary cells by modulating AC activity (218, 497). Activation of G_s -linked GPCRs in pituitary cells stimulates electrical activity and facilitates VGCI. The type of Ca^{2+} response typically obtained through this pathway is a plateau elevation of $[\text{Ca}^{2+}]_i$ or an increase in the frequency and/or amplitude of Ca^{2+} transients. The cross talk between Ca^{2+} and cAMP also exists at effector levels, including the control of exocytosis (see *Section VII.B.4*).

1. CRH-induced calcium influx in corticotrophs

CRH, also known as CRF, is the main regulator of ACTH release in normal and immortalized corticotrophs. It acts on CRH receptors known as CRF- R_1 receptors coupled to the G_s signaling pathway, leading to stimulation of cAMP production (19, 490). One of the main functions of CRH in corticotrophs is to modulate spontaneous electrical activity and facilitate Ca^{2+} influx; in the absence of extracellular Ca^{2+} , *de novo* production of cAMP is not affected, but CRH-induced ACTH release is completely blocked. This does not exclude the Ca^{2+} -independent effects of the cAMP signaling pathway on exocytosis, but it demonstrates that the modulatory role of this signaling pathway could be manifested only in the presence of elevated Ca^{2+} . The relevance of this cation in cAMP effects on secretion is also demonstrated in experiments with AVP and CRH. AVP stimulates Ca^{2+} mobilization from the ER in corticotrophs, but alone it is not a very potent secretagogue. However, in the presence of CRH, secretion is greatly enhanced by AVP (498).

A key element in the control of spontaneous firing of APs in pituitary cells, including corticotrophs, is control of the resting membrane potential and slow membrane depolarization, called the pacemaking depolarization. CRH changes the resting membrane potential and the rate of the pacemaking depolarization, leading to an increase in the

firing rate of spontaneously active cells and causing silent cells to become active (293, 320, 499). The slow membrane depolarization is caused in large part by a reduction in a background K^+ conductance mediated by a member of the K_{ir} channel family (294, 500). Depolarization alone is not sufficient to induce spiking in quiescent cells (499), and the firing frequency of cells depolarized by CRH is higher than for corticotrophs depolarized to the same voltage level by blocking the K_{ir} current. This indicates that a small component of the depolarization might be mediated by the reduction of another type of background K^+ conductance or facilitation of an inward current (294). A mathematical model of the corticotroph confirms that depolarization induced by blocking a background K^+ current facilitates spiking but cannot by itself trigger AP firing (501). On the other hand, facilitation of the L-type Ca_v current is sufficient for the model to generate spikes or bursts (501, 761). However, there is no evidence that CRH receptor activation leads to phosphorylation of these channels by PKA, as in other cell types. The inward current is not generated by HCN channels, which are expressed in AtT-20 cells, but are fully activated by the resting cAMP levels (209). The background Na^+ conductance discovered by Simasko and colleagues (80, 297), which is present in all endocrine pituitary cells (224), could play a major role in CRH- and GHRH-induced electrical activity and secretion (discussed in *Section VII.A.2*).

The inhibition of K_{ir} and associated depolarization and increase in spike frequency last up to 15 min after removal of CRH from the physiological solution, suggesting that phosphorylation of K_{ir} channels could account for this memory (294). These effects of CRH and their time courses are mimicked by application of forskolin, an activator of AC, and by membrane-permeant analogs of cAMP (294, 500). No CRH-induced depolarization is observed in the presence of intracellular Rp-cAMPS, a blocker of PKA (500), confirming that the effects of CRH on the pacemaking depolarization are mediated through cAMP activation of PKA. However, some effects of CRH were resistant to the PKA inhibitor H-89, raising the possibility that CRH might act through an additional G protein pathway (499, 502).

Ca_v channels can be activated with sufficiently strong pacemaking depolarization, and their opening produces the upstroke of the AP spike and a robust Ca^{2+} influx. It appears that the main channel involved is the L-type Ca_v channel, but P-type Ca_v channels also play a role in the regulation of spike frequency, and another high-voltage-activated and toxin-resistant Ca_v channel may as well (293). Rapid PKA-mediated phosphorylation of L-type Ca_v channels has not been studied but should not be excluded. However, cAMP stimulates the expression of the

L-type Ca_v channels in AtT-20 cells at the mRNA and protein levels, presumably through PKA (503). Corticotrophs also express T-type Ca_v channels, but their role in CRH action has not been studied. The recovery of membrane potential in corticotrophs depends on at least two K^+ channels, the delayed rectifier and BK channels. In AtT-20 cells, CRH inhibits BK channels through activation of PKA (188). Thus, whereas the intracellular signaling pathway activated by CRH may be the same in corticotrophs and AtT-20 cells, the PKA targeted ion channels appear to be different.

2. GHRH-induced calcium influx in somatotrophs

The GHRH receptor is expressed predominantly in the pituitary gland and is coupled to the G_s signaling pathway. In rats, there are two splice forms of this receptor showing similar sensitivity to GHRH, but only the short receptor isoform stimulates cAMP production (491). In a fraction of porcine pituitary cells, GHRH could also trigger Ca^{2+} mobilization in an IP_3 -dependent manner, which could indicate the cross-coupling of GHRH receptors to the $\text{G}_{q/11}$ signaling pathway (504). Like CRH in corticotrophs, GHRH facilitates electrical activity and Ca^{2+} influx through L-type Ca_v channels of silent or already active somatotrophs (214, 291, 302, 505–509). Forskolin also increases Ca^{2+} influx in somatotrophs (510, 511), and inhibition of PDEs increases the electrical activity of somatotrophs (291), indicating the relevance of cAMP in GHRH action. An increase in electrical activity after GHRH application is also observed in pituitary slices (288). This response can be detected for up to 90 min after removal of GHRH (505). Such long-lasting effects of G_s -linked receptors on the electrical status of somatotrophs suggests that the time course of the phosphorylation-dephosphorylation cycle, rather than the direct effect of cAMP, could account for prolonged effects of GHRH on electrical activity in these cells. Consistent with this, although somatotrophs and GH_3 lactosomatotrophs also express HCN channels (210, 211), these channels are unlikely to contribute to the GHRH-stimulated electrical activity because basal AC activity is sufficient to fully activate them.

It is possible that GHRH decreases the intrinsic activity of a K_{ir} channel in somatotrophs, as CRF does in corticotrophs. This was shown in experiments with blockade of these channels in spontaneously firing cells and model simulations (291). Several findings suggested that a background Na^+ conductance could mediate the action of GHRH on electrical activity in these cells. First, extracellular Na^+ is essential for GHRH-induced and cAMP-induced GH release. Removal of Na^+ does not affect GHRH-stimulated cAMP production, further indicating that this messenger alone is not sufficient to trigger exocytosis. Second, blockade of Na_v channels by TTX does

not mimic the effects on GH release of replacing bath Na^+ with organic cations. Finally, Li^+ can substitute for Na^+ in GHRH actions (301, 512). Isolation of GHRH-stimulated current revealed that the channel is permeable to Na^+ , Li^+ , and K^+ but not to organic cations, and that the stimulatory action of GHRH is mimicked by a cAMP analog (302) and blocked by inhibition of PKA (513). The Na^+ -dependent inward conductance involved in the GHRH-induced depolarization could be the background conductance that mediates spontaneous oscillations of membrane potential. This conductance is inhibited by large (10 mM) extracellular concentrations of Ca^{2+} , Mg^{2+} , and Sr^{2+} and is activated at low Ca^{2+} levels (214).

It appears that the action of GHRH on electrical activity also includes other ion channels. In parallel to the effects of cAMP-PKA on cardiac Ca_v channels, GHRH was shown to increase L- and T-type Ca^{2+} conductances in ovine somatotrophs and human adenoma GH cells (514–516). A role for delayed rectifier and A-type K^+ conductances in GHRH-induced depolarization in ovine somatotrophs, human adenoma GH cells (514, 517), and GH_4C_1 cells (143) has also been suggested. Although the increase in the Ca_v currents was mediated through cAMP/PKA (514, 516), the decrease in the K^+ currents was not blocked by PKA inhibitors, but was abolished by PKC inhibitors and mimicked by a PKC activator (143, 514, 517). The synthesized GH-releasing peptide GHRP-2 also acts through the cAMP/PKA pathway to increase L- and T-type currents (518). Other GH-releasing peptides that have been synthesized also depolarize the somatotrophs membrane, allowing Ca^{2+} influx, but they may act through different pathways (519).

3. VIP/PACAP-induced calcium influx in pituitary cells

The high degree of sequence homology between VIP and PACAP would be consistent with the presence of a common receptor for the two agonists. However, three distinct types of receptors exist in vertebrates. The type I (PAC_1) receptor exists in six splice forms, a short form and five variants having inserts in the third intracellular loop of the receptor. Two of these variants are linked to activation of both AC and PLC equipotently; two forms exhibit 10-fold preference for coupling to the PLC signaling pathway; two forms have characteristics intermediate between the two groups. Type II and III (VPAC_1 and VPAC_2) receptors exhibit equal potency for VIP and PACAP and signal exclusively through the AC pathway. Pituitary cells express PAC_1 and VPAC_2 receptors; gonadotrophs express the PAC_1 receptor linked to the PLC signaling pathway; and somatotrophs, lactotrophs, and melanotrophs express VPAC_2 receptors coupled to the G_s signaling pathway (47, 520).

PACAP activates Ca^{2+} mobilization through the PLC/ IP_3 pathway mediated by $\text{G}_{q/11}$ in both gonadotrophs and

α T3-1 cells (521). In α T3-1 cells, PACAP also stimulates cAMP production and facilitates extracellular Ca^{2+} influx through dihydropyridine-sensitive Ca_v channels, an effect blocked by the PKA antagonist H-89 and mimicked by forskolin and 8-Br-cAMP. This finding is consistent with the expression of both PAC_1 and VPAC_3 receptors in α T3-1 cells. A higher concentration of PACAP (>1 nM) produces a pulse-decay-plateau response, the pulse being mediated by IP_3 and the plateau by cAMP/PKA, a response similar to the TRH-evoked stimulation of the intracellular Ca^{2+} level in lactotrophs (47, 522).

PACAP stimulates cAMP production and α -MSH release from melanotrophs and ACTH release from AtT-20 cells (523). In melanotrophs, PACAP stimulates Ca^{2+} influx through L-type Ca_v channels but does not trigger Ca^{2+} mobilization from the ER. The rise in $[\text{Ca}^{2+}]_i$ is mimicked by activation of PKA and inhibited by blockade of this enzyme. Electrophysiological experiments also revealed that PACAP stimulation of melanotrophs causes an inward nonselective cation current, which depolarizes the cells and stimulates VGCI (492). In somatotrophs, PACAP also stimulates Ca^{2+} influx through Ca_v channels (524, 525). These responses are similar to the GHRH-evoked Ca^{2+} plateaus and transients. They are blocked by PKA antagonists and mimicked by forskolin and by the cAMP analog 8-Br-cAMP (526).

PACAP also causes extracellular Ca^{2+} influx in lactotrophs (527). In GH_3 cells, VIP evokes a modest Ca^{2+} influx via an increase in cAMP (528), and both VIP and PACAP increase cAMP levels in GH_4C_1 cells (529). There are also numerous reports of effects of VIP on PRL release from dissociated pituitary cells (reviewed in Ref. 54). There is another mechanism by which the cAMP signaling pathway could contribute to the control of electrical activity in lactotrophs. *In vivo* lactotrophs are tonically inhibited by dopamine, which decreases cAMP levels and opens K^+ channels, decreasing $[\text{Ca}^{2+}]_i$ to its basal level (29, 51). The main stimulatory signal for PRL release is generated by inhibition of dopamine secretion and results in an increase in cAMP levels and stimulation of electrical activity and Ca^{2+} influx (530). Consistent with this, cAMP acts as a potent modulator of electrical activity, Ca^{2+} influx, and PRL release in lactotrophs *in vitro* (218).

4. cAMP signaling pathway and secretion

Forskolin, an activator of AC, and cell-permeable cAMP stimulate GH (531), PRL (218), LH (532, 533), and ACTH release (534). In single lactotrophs, cAMP-induced facilitation of exocytosis, measured by changes in the plasma membrane capacitance, was also detected (430). In these cells, forskolin increases the number of granule-to-granule fusion events without altering the number of granule-to-plasma membrane fusion events (535). In single rat

melanotrophs, cAMP also stimulates the fusion of larger granules with the plasma membrane (431). In general, facilitation of hormone release reflects dual actions of the cAMP signaling pathway on exocytosis, indirectly by facilitating VGCI (*Section VII.A.1–3*) and directly on the exocytotic pathway. In some cell types, the calcium-independent effect of cAMP on exocytosis is mediated by PKA (536). In neurons, PKA-dependent facilitation of synaptic transmission includes recruitment of synaptic vesicles from the reserve pool to the readily releasable pool of vesicles (537) and phosphorylation of the secretory vesicle-associated synapsin proteins (538). A more recent study suggested that cAMP facilitates Ca^{2+} -dependent exocytosis in melanotrophs through both PKA and Epac2 (432). Further studies are needed to identify the PKA and Epac2-sensitive steps in the exocytotic pathway in this and other pituitary cell types.

B. Inhibition of electrical activity by GPCRs

GPCRs linked to the $G_{i/o/z}$ -signaling pathways are also operative in endocrine pituitary cells, and their activation leads to inhibition of electrical activity and hormone secretion. Somatostatin (539, 540) and dopamine (51, 541) are two major hypothalamic factors that inhibit pituitary hormone secretion via $G_{i/o/z}$ -coupled receptors. Pituitary cells also express several other GPCRs linked to this signaling pathway, including receptors activated by adenosine (542), ET-1 (543), GABA (544), melatonin (545), neuropeptide Y (546), and 5-HT (25) (Fig. 11). Inhibition of AC activity by these receptors represents one of the mechanisms by which spontaneous electrical activity and hormone secretion are inhibited. The $\beta\gamma$ dimer of these G proteins also has prominent effects on electrical activity and hormone secretion in a cAMP/PKA-independent manner.

1. Somatostatin inhibits electrical activity, calcium influx, and hormone secretion

Somatostatin or somatotropin release-inhibiting factor was initially discovered in hypothalamic extracts and was found to inhibit GH secretion from cultured anterior pituitaries. Subsequently, it was found that somatostatin also inhibits TSH and PRL release from normal pituitary cells, GH and PRL release from adenomatous glands in humans and from GH_4C_1 cells, and ACTH release from human and mouse ACTH-producing tumors. Somatostatin was found in other CNS regions and in peripheral tissues, including the pancreas, the gut, and the thyroid gland. The actions of somatostatin are mediated by five receptors, termed sst_1 , sst_2 , sst_3 , sst_4 , and sst_5 , all linked to the $G_{i/o}$ signaling pathway. The effector molecules include AC, K^+ channels, Ca^{2+} channels, Na^+/H^+ exchanger, and

cGMP-dependent protein kinase. Pituitary cells express predominantly sst_1 , sst_2 , and sst_5 receptors (539, 547).

In somatotrophs, somatostatin inhibits spontaneous and GHRH-stimulated electrical activity, VGCI, and GH secretion. In spontaneously firing somatotrophs and GH cell lines, somatostatin hyperpolarizes the plasma membrane, leading to inhibition of electrical activity and basal VGCI (116, 291, 505, 508, 509, 548–551). Somatostatin also inhibits basal and forskolin-stimulated $[Ca^{2+}]_i$ in human TSH-secreting adenoma cells (552). Because somatostatin inhibits cAMP production (553), it should antagonize the effects of GHRH mediated through cAMP/PKA. Indeed, somatostatin reverts the stimulatory effects of GHRH and cell permeable cAMP on VGCI (506, 508, 509) and on the background, TTX-independent Na^+ conductance (554) in somatotrophs and tumoral GH-secreting cell lines. In one study, a low concentration of somatostatin only abolished the early phase of GHRH-induced Ca^{2+} influx, whereas at higher concentration it abolished the early and late phases of the response, suggesting that somatostatin operates on multiple targets (508).

Two channel families modulated by GHRH in somatotrophs (K_{ir} and Ca_v) are also modulated by somatostatin, but in the opposite direction (555); there is evidence that somatostatin activates $K_{ir,3}$ channels (116, 552) and inhibits Ca_v channels (549, 556–558). The latter is also observed in ACTH-secreting AtT-20 cells (559). It appears that the L-type Ca_v channels are negatively coupled to somatostatin receptors (560, 561) and that withdrawal of somatostatin augments this current in rat somatotrophs (562) and cells from human somatotroph adenomas (563). Whereas GHRH-stimulated and PKA-mediated phosphorylation accounts for facilitation of Ca_v currents in somatotrophs, somatostatin inhibits these channels in a cAMP/PKA-independent manner (556, 559, 564). Control of activity of K_{ir} and Ca_v channels by somatostatin is not unique to pituitary cells, but was also observed in other cell types expressing these receptors (540).

It has also been suggested that somatostatin stimulates BK-type K_{Ca} channels through protein dephosphorylation (557), as well as the A-type and delayed rectifier K^+ channels (145, 549). Inhibition of the background Na^+ conductance by somatostatin has also been postulated; the somatotroph model of Tsaneva-Atanasova *et al.* (291) reproduces the effect of somatostatin on membrane potential and intracellular Ca^{2+} by decreasing the background Na^+ -dependent conductance and increasing a K_{ir} conductance. In contrast, activation of BK channels might increase the duration of spontaneous electrical events and therefore may not have an inhibitory effect on Ca^{2+} influx (see Section IV.D).

The effects of somatostatin on ion channels and electrical activity are antagonized by preincubation of the

cells with pertussis toxin, confirming that the somatostatin receptor is coupled to the $G_{i/o}$ family of G proteins (558, 561, 565). There were numerous studies focused on the subtypes of G proteins involved in the coupling of somatostatin receptors to channels. Treatment of ovine somatotrophs with antibodies and antisera to various $G\alpha$ -subunits has suggested that α_o2 mediates the reduction of Ca_v currents (566), whereas α_i3 mediates the increase in K_v currents (567). In GH_3 cells, downregulation of $G_o\alpha2\beta1\gamma3$ protein expression eliminates the inhibitory effect of somatostatin on Ca_v channels (568). It is reasonable to postulate that $\beta\gamma$ complexes released from G_i and G_o proteins mediate the action of somatostatin receptors on K_{ir} and Ca_v channels. In GH_3 cells, α_i2 specifically mediates inhibition of AC (569). The ability of somatostatin to stimulate inositol phosphate turnover, Ca^{2+} mobilization, and GH secretion in a fraction of porcine somatotrophs could suggest that the $G\beta\gamma$ dimer of $G_{i/o}$ also stimulates PLC. However, somatostatin in this subpopulation of somatotrophs also triggers elevation in cAMP production (570), suggesting that further studies are needed to clarify the mechanism of activation of these pathways.

2. Dopamine modulation of calcium influx in lactotrophs and melanotrophs

Among catecholamines, dopamine plays the major role in the control of pituitary cell functions. It is secreted from hypophyseal hypothalamic neurons and acts as a principal inhibitory regulator of PRL release by lactotrophs (51, 54) and α -MSH by melanotrophs (571). In low concentrations, dopamine also stimulates PRL release (572). There are five subtypes of dopamine receptors, called D_1 , D_2 , D_3 , D_4 , and D_5/D_{1b} . By using the radioligand binding assay, it was shown in the late 1970s that the dopamine D_2 subtype of receptors mediates the tonic inhibitory control of hypothalamic dopamine on PRL release in these cells (541). Later investigations showed that two subtypes of D_2 receptors, termed D_{2S} and D_{2L} , are generated by alternative splicing in lactotrophs and melanotrophs (571, 573, 574). Lactotrophs express varying ratios of these two receptor subtypes, depending on the level of gonadal steroids (575). Consistent with these findings, the knockout D_2 mice showed chronic hyperprolactinemia, pituitary hyperplasia, and a moderate decrease in α -MSH content (576).

The pituitary dopamine receptors are functionally associated with pertussis toxin-sensitive $G_{i/o}$ proteins (577–579). Dopamine-induced inhibition of PRL release is also affected by pertussis toxin treatment (572, 578, 580). Two intracellular messengers that play major roles in controlling the fusion of secretory vesicles with the plasma membrane to release hormones in endocrine cells (581), cAMP and Ca^{2+} , are affected by activation of D_2 receptors in

pituitary cells. Early studies suggested that inhibition of cAMP production contributes to inhibition of PRL release (578, 580). However, the relevance of cAMP in dopamine actions on PRL release was questioned by the finding that dopamine inhibits PRL secretion in cells with activated ACs by forskolin (582). We also observed that the dopamine agonist-induced inhibition of basal release of pre-stored PRL was preserved when cAMP levels were elevated by forskolin treatment (583). These experiments certainly do not exclude the modulatory role of cAMP/PKA in Ca^{2+} -controlled exocytosis, but suggest that control of Ca^{2+} influx represents the major pathway by which dopamine controls PRL release.

In lactotrophs, dopamine blocks spontaneous and stimulated VGCI in a similar way to Ca^{2+} channel blockers or removal of extracellular Ca^{2+} (583–587). Dopamine also hyperpolarizes the membrane and suppresses APs and bursts, which explains the decrease in VGCI (583, 587, 588). A similar effect of dopamine was observed in melanotrophs (589). The role of K_{ir} channels in dopamine-induced hyperpolarization has been suggested (114, 123, 589, 590). It has also been reported that dopamine increases K_{v} conductance (588) and the BK-type K_{Ca} conductance (183). Dopamine was also reported to inhibit Ca_{v} channels in lactotrophs (591–593), a conclusion questioned by others (594). Inhibition of high voltage-activated Ca_{v} currents was also observed in melanotrophs from neonatal rats (22, 589, 595).

In general, the action of dopamine on electrical activity could be mediated through cAMP-dependent and -independent mechanisms. Dopamine does decrease cAMP in lactotrophs (583) and an elevation of the cAMP level increases electrical activity and Ca^{2+} influx in these cells (218). However, only a minority of lactotrophs exhibits decreased electrical activity when cAMP is reduced from its basal level (583). Furthermore, whereas the effects of dopamine on VGCI are pertussis toxin-sensitive, they persist in cells with elevated cAMP (123, 583, 587, 588, 596, 597). Finally, the activation of voltage-independent K^{+} channels by dopamine is observed in excised outside-out patch (596), demonstrating that no second messenger is required to mediate this action. This suggests that coupling between the G protein and K_{ir} channels is mediated by the $\beta\gamma$ dimer (123).

In physiological conditions *in vivo*, dopamine tonically inhibits lactotrophs, and a transient release from such inhibition constitutes a stimulatory signal for PRL secretion (530). Even a brief removal of dopamine can potentiate the subsequent PRL-releasing action of TRH, presumably through a cAMP/PKA increase that leads to a long-lasting phosphorylation of Ca_{v} channels (530). In support of this hypothesis, dopamine application has been shown to in-

hibit Ca_{v} currents after a short (1–10 min) and a prolonged (over 24 h) application in GH_4C_1 cells transfected with D_2 receptors. After such treatments, washout of dopamine for 10–40 min doubled Ca_{v} currents, and the current further increased 24 h after dopamine removal (590). Withdrawal of dopamine after a short application also evokes a rapid rebound increase of basal PRL secretion above the level observed before agonist application (598), and such rebound is blocked by preventing VGCI (599, 600). Given that both rapidly and slowly inactivating Ca_{v} currents are potentiated after a hyperpolarizing conditioning potential, this suggests that recruitment of inactivated channels by dopamine-induced hyperpolarization contributes to the rebound effect on PRL release.

It has also been reported that picomolar doses of dopamine (about 1000 times less than the inhibitory range of concentration) can stimulate PRL release (601). This stimulatory effect is mediated, at least in part, by a rapid increase in $[\text{Ca}^{2+}]_{\text{i}}$, but not cAMP (572). There is evidence that this stimulatory effect is mediated by D_2 receptors (572, 602) and/or the D_5 receptor (603). There is also contradictory evidence regarding the implication of the G_i pathway in the stimulatory action of dopamine on PRL release (572, 604). If it is assumed that the effects of a low dose of dopamine encompass a subset of the effects of inhibitory doses, then a possible mechanism is that dopamine activates either BK or A-type K^{+} channels. As discussed above, the BK channel can promote bursting and increase the amplitude of Ca^{2+} oscillations in pituitary somatotrophs. Models of pituitary cells also show that BK and A-type K^{+} currents can promote bursting, due to their fast voltage-dependent activation, which prevents full-blown spikes and rapid membrane repolarization (291, 313).

Two additional transduction mechanisms have also been reported for D_2 dopamine receptors in target tissues. First, the D_2 receptors can exert their actions independently of G proteins by promoting the formation of a signaling protein complex composed of β -arrestin, Akt, and protein phosphatase-2A (605). In chromaffin cells, Akt-induced phosphorylation of cysteine string protein plays a role in late stages of exocytosis (606). Akt also regulates the PRL promoter activity (607), whereas the contribution of this signaling pathway to dopamine-controlled PRL release has not been observed (583). Second, dopamine $\text{D}_{2\text{S}}$ and $\text{D}_{2\text{L}}$ receptors couple to the same extent to the pertussis toxin-sensitive $\text{G}_{\text{i/o}}$ protein and to the pertussis toxin-insensitive G_z proteins *in vitro* (608) and *in vivo* (609). Other subtypes of dopamine receptors also couple to G_z proteins (608, 610). Indirect evidence has recently been presented that D_2 receptors in pituitary cells are also linked to the G_z signaling pathway, and that such coupling

provides an additional mechanism for inhibition of PRL release downstream of VGCI (583).

Dopamine actions in lactotrophs depend also on the gonadal steroid milieu. Estradiol decreases the expression of D_2 receptors (575) and the number of $G_{i/o}$ immunoreactive lactotrophs (611) but does not affect the expression ratio of the long and short D_2 receptor subtypes, in contrast to progesterone and testosterone (575). Also, the stimulatory and inhibitory actions of dopamine on PRL release vary throughout the estrous cycle and in ovariectomized animals vary with steroid replacement therapy (611). The rebound PRL release after dopamine withdrawal also appears to be steroid dependent (612). Dopamine-induced activation of K_{ir} channels was observed in most lactotrophs from proestrous females, but not in cells from estrous or diestrous rats (612), indicating that effects of estradiol on dopamine response are not limited to the control of expression of D_2 receptors. Furthermore, bath application of estradiol can quickly reverse the inhibitory effect of dopamine on electrical activity, indicating a nongenomic action of this steroid hormone on electrical activity (613). Estradiol can also affect the percentage of light and heavy fractions of lactotrophs, which respond specifically to dopamine and TRH (50, 100, 325).

3. ET inhibition of VGCI in pituitary cells

The ET family of peptides, originally discovered for their vasoconstrictive effects on vascular tissue, is composed of three endogenous isoforms (ET-1, ET-2, and ET-3), which are encoded by different genes (614, 615). The peptides are differentially expressed in tissues of the periphery and CNS and have profound effects on neuroregulatory and endocrine functions, in addition to effects on cardiovascular functions (616, 617). In mammals, there are two plasma membrane ET receptor subtypes, ET_A (618) and ET_B (619). These receptors are GPCRs that signal through variable G proteins, depending on the cell type in which they are expressed (620). The ET_A receptor is selective for ET-1 and ET-2 over ET-3, whereas the ET_B receptor is activated equally by these peptides (621). The ET_C receptor cloned from *Xenopus leavis* dermal melanophores is ET-3 specific (622); however, the mammalian homolog for the ET_C receptor does not exist. ET receptors arise through divergent intron-containing genes, and mRNAs arising from alternative splicing have been reported (621). Some splice isoforms of rat ET receptors are functional (623–625). The human ET_A receptor gene has also been proposed to give rise to several alternative splice isoforms (626–628).

Functional ET receptors are expressed in all five major secretory cell types (52, 629, 630), and ETs are produced by pituitary cells (631), suggesting autocrine or paracrine

modes of action. Stimulation of these receptors in gonadotrophs leads to activation of the $G_{q/11}$ signaling pathway accompanied with the oscillatory Ca^{2+} release from intracellular pools and gonadotropin secretion (245). The stimulatory action of these receptors on Ca^{2+} signaling and secretion in gonadotrophs is transient due to their rapid desensitization and internalization (37). In somatotrophs and lactotrophs, ETs also activate the Ca^{2+} -mobilization pathway and transiently stimulate GH and PRL release. In contrast to gonadotrophs, the stimulatory effect of ET is followed by inhibition of PRL and GH release below the basal levels (48, 282, 632, 633). In lactotrophs, the inhibitory phase lasts for several hours (52, 53), arguing against rapid desensitization of these receptors. Such a difference in the actions of ETs in gonadotrophs *vs.* somatotrophs/lactotrophs would be consistent with the expression of both subtypes of these receptors, but pituitary cells express only ET_A receptors (37, 634, 635), which are most likely a combination of the full-size and spliced forms of these receptors (628).

In general, activation of Ca^{2+} -mobilizing receptors leads to sustained Ca^{2+} influx. In nonexcitable cells, Ca^{2+} influx occurs through Orai channels (see *Section III.C.3*), and in excitable cells, Ca^{2+} -mobilizing receptors frequently facilitate VGCI. This is also the case with several Ca^{2+} -mobilizing agonists in pituitary cells, including TRH and angiotensin II (282). In contrast, ET-1-induced Ca^{2+} mobilization in lactotrophs and somatotrophs is followed by a return of $[Ca^{2+}]_i$ levels to baseline for quiescent cells, or to below control levels for spontaneously active cells (282). Such sustained inhibition of VGCI is not affected by raising intracellular cAMP (115), ruling out down-regulation of the cAMP/PKA pathway as the mechanism for ET-1-induced inhibition of Ca^{2+} influx.

The sustained inhibitory action of ET-1 on $[Ca^{2+}]_i$ levels is replaced by stimulation of Ca^{2+} influx through Ca_v channels when the cells are pretreated with pertussis toxin, suggesting that activation of the $G_{i/o}$ pathway inhibits Ca^{2+} influx. Also, ET-1 inhibits spontaneous and Bay K 8644 (an activator of L-type Ca_v channels) stimulated Ca^{2+} transients, but it does not inhibit Ca^{2+} influx stimulated by high K^+ , suggesting that the inhibition is not mediated by directly closing Ca_v channels. Rather, ET-1 increases a cesium-sensitive K_{ir} current in both somatotrophs and lactotrophs (48, 115). In parallel to somatostatin and dopamine actions, facilitation of K_{ir} currents by ET-1 hyperpolarizes the membrane, suppressing electrical activity and the resulting Ca^{2+} transients. Physiologically, the suppression of VGCI is sufficient to block secretion. In cells in which the $G_{i/o}$ signaling pathway is blocked, ET-1 still inhibits AC activity and PRL release, indicating that there is cross-coupling of ET_A receptors to

the G_z signaling pathway, with α_z inhibiting cAMP production and the $\beta\gamma$ dimer acting directly on the release machinery, desensitizing the Ca^{2+} -secretion coupling (281). The physiological significance of inhibition of PRL release downstream of VGCI is not clear at the present time.

ET-1 has also been reported to activate BK channels in lactotrophs (183). As discussed previously, activation of all BK channels may not have an inhibitory effect on Ca^{2+} influx (291), so BK channel activation may not be a predominant contributor to the inhibition of VGCI by ET-1. Acute application of dopamine also activated the same channels, but 48-h treatment with dopamine resulted in inhibition of BK channels by ET-1 (183). Interestingly, dopamine exposure for 48 h also reversed the inhibition of PRL release by ET-1, replacing it with a modest stimulation (632). Because lactotrophs are normally exposed to dopamine, the inhibitory signaling pathway may be uncoupled from the ET_A receptor *in vivo*. Thus, whereas tonically inhibiting PRL secretion, dopamine could also change the nature of the ET signal from inhibitory to excitatory. When the release of hypothalamic dopamine is impaired, ET_A receptors might recouple to the same inhibitory pathways coupled to D_2 receptors, and thus ETs might replace dopamine as the primary inhibiting factor.

4. Other pituitary receptors linked to the $G_{i/o}$ signaling pathway

Cloning of 5-HT receptors led to the recognition of several types of 5-HT-activated GPCRs. All 5-HT₁ receptors are negatively coupled to AC via $G_{i/o}$, whereas 5-HT₄, 5-HT₆, and 5-HT₇ receptors stimulate AC through G_s (636). In addition to dopamine D_2 receptors, porcine pituitary melanotrophs also express 5-HT_{1A} and 5-HT_{1C} receptors, and their activation leads to inhibition of L-type Ca_v channels (637). Inhibition of L-type and Q-type Ca_v channels mediated by 5-HT also occurs in rat melanotrophs (25). In both cell types, inhibition of Ca_v currents was abolished in cells treated with pertussis toxin, indicating the coupling of 5-HT receptors to the $G_{i/o}$ signaling pathway. There are contradictory conclusions about direct actions of 5-HT on PRL release (638, 639).

Adenosine is a potent inhibitor of α -MSH release from frog melanotrophs (640). The structure of these receptors has not been identified, but pharmacological, electrophysiological, and secretory data indicate the expression of adenosine receptors of the A_1 subtype, which is negatively coupled to the AC signaling pathway through pertussis toxin-sensitive G proteins (461). Two reports have also indicated the operation of adenosine receptors in pituitary lactotrophs (641, 642), but further studies are required to clarify their structure, coupling, and effects (stimulatory or inhibitory) on PRL secretion. GH₃ and GH₄C₁ cell lines

also express A_1 receptors, and their activation causes inhibition of PRL and GH secretion (643, 644). Electrophysiological experiments revealed that adenosine inhibits electrical activity-driven Ca^{2+} transients in GH cell lines (645). In frog melanotrophs, adenosine also inhibits spontaneous electrical activity (646), presumably reflecting the inhibitory action on Ca_v channels (647), facilitation of A-type K_v channels (151), and/or potentiation of delayed rectifier K^+ channels (150).

GABA_B receptors are GABA- and baclofen-sensitive $G_{i/o}$ -linked receptors, and their activation induces late hyperpolarization, attenuation of Ca_v currents, facilitation of K_{ir3} channels, and inhibition of AC activity (648). Pituitary melanotrophs express all three subtypes of these receptors [$GABA_{B(1a)}$, $GABA_{B(1b)}$, and $GABA_{B(2)}$], and functional receptors were identified in postnatal and adult melanotrophs (649). Activation of these receptors leads to inhibition of AC activity (423) and spontaneous Ca^{2+} oscillations (650), and inhibition in the Ca^{2+} -dependent basal α -MSH release (328). These receptors are also expressed in anterior pituitary cells and contribute to the control of PRL and gonadotropin secretion in an age-dependent manner (544, 651, 652). In female rats that received estradiol implants for 5 wk, pituitary GABA_B receptor mRNA was significantly decreased compared with proestrous rats, and the baclofen-induced decrease in $[Ca^{2+}]_i$ in pituitary cells was abolished (652). No details about the effects of these receptors on the electrical activity of anterior pituitary cells have been reported.

Pituitary cells from neonatal animals express the functional MT₁ subtype of melatonin receptors that signal through pertussis toxin-sensitive G proteins. Their activation by melatonin leads to a decrease in cAMP production and PKA activity and attenuation of GnRH-induced gonadotropin secretion (545). Single-cell Ca^{2+} and electrophysiological recordings revealed that the reduction in gonadotropin release results from melatonin-induced inhibition of both components of GnRH-induced Ca^{2+} signaling in gonadotrophs, Ca^{2+} influx through Ca_v channels, and IP₃-mediated Ca^{2+} release from intracellular stores (653–655). Inhibition of Ca^{2+} influx by melatonin results in a delay of GnRH-induced Ca^{2+} signaling. On the other hand, attenuation in GnRH-induced Ca^{2+} release affects the amplitude of the Ca^{2+} signals. The potent inhibition of GnRH-induced Ca^{2+} signaling and gonadotropin secretion by melatonin provides an effective mechanism to protect premature initiation of pubertal changes that are dependent on gonadotropin plasma levels. During development, the tonic inhibitory effects of melatonin on GnRH action gradually attenuate, due to a decline in expression of functional MT₁ receptors and changes in the GnRH receptor signaling pathways (656–658). In adult

animals, melatonin does not affect pituitary functions directly, whereas the coupling between melatonin release and hypothalamic functions, including GnRH release, are preserved and are critically important in synchronizing the external photoperiods and reproductive functions through mechanisms that are not well characterized (545).

Neuropeptide Y is a 36-amino acid peptide mainly localized in the nervous system that exerts its biological actions through five receptors, called Y_1 to Y_5 (659). Pituitary lactotrophs, somatotrophs, and gonadotrophs probably express the Y_1 receptor subtype, and the expression is regulated by estrogens in a cell-specific manner (660). In gonadotrophs, neuropeptide Y inhibits GnRH-induced Ca^{2+} signaling and LH release in a pertussis toxin-sensitive manner (661). The effects of neuropeptide Y on electrical activity in anterior pituitary cells have not been studied. Neuropeptide Y also inhibits spontaneous Ca^{2+} transients and the accompanied α -MSH release in melanotrophs (662). Electrophysiological experiments revealed that neuropeptide Y inhibits spontaneous electrical activity and Ca_v currents in these cells (663).

Galanin is produced by pituitary cells and acts as a paracrine factor (4). Pituitary cells express the GalR2 receptor subtype (664–666). In general, this receptor couples to the $G_{q/11}$ signaling pathway (667). However, the cloned receptor also couples to the $G_{i/o}$ signaling pathway (668). The coupling of GalR2 receptors in pituitary cells has not been studied. Based on observations that galanin stimulates PRL release (669) and inhibits gonadotropin secretion (670), it is reasonable to suggest differential coupling of these receptors in pituitary cells. At the present time, there is no information about the effects of galanin on electrical activity and Ca^{2+} signaling in these cells.

VIII. Calcium-Mobilizing Receptors and Electrical Activity

GPCRs linked to the $G_{q/11}$ signaling pathway are activated by agonists in all anterior pituitary cell types and include: acetylcholine M1 and M3 receptors, angiotensin receptor AT_{1b} , ATP-activated $P2Y_1$ and $P2Y_2$ receptors, ET_A , galanin receptor GalR2, ghrelin receptor GHS-R1a, GnRH receptor, serotonin 5-HT2A and 5-HT2B receptors, substance P receptor NK1, TRH receptor, AVP/oxytocin V_{1b} and OT receptors, and VIP/PACAP receptor PAC_{1b} (Fig. 12). In gonadotrophs, this signaling pathway is activated by GnRH (33, 671), which is the main agonist for these cells, as well as by ETs (52, 245), PACAP (36), substance P (39, 672), and AVP/oxytocin (38, 673). In thyrotrophs, the $G_{q/11}$ signaling pathway is activated by TRH, the main agonist for these cells (242, 671), and ETs (617). Lactotrophs express numerous Ca^{2+} -mobilizing re-

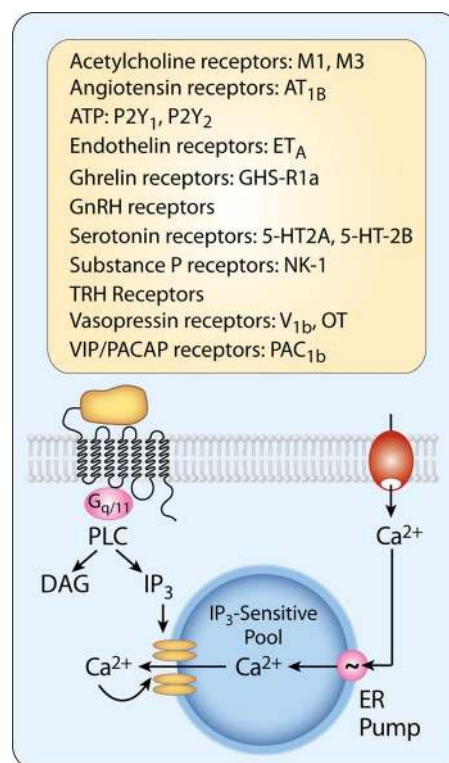

FIG. 12. Expression of Ca^{2+} -mobilizing GPCRs in endocrine pituitary cells. *Top rectangle*, Ca^{2+} -mobilizing GPCRs expressed in mammalian pituitary cells. Activation of these receptors by hypothalamic or intrapituitary hormones leads to dissociation of heterotrimeric G proteins, and their α -subunit (and in some cases $\beta\gamma$ -subunits) stimulates PLC. This enzyme serves as an amplifier by producing two intracellular messengers: IP_3 and DAG. IP_3 binds to its receptors in the ER and evokes Ca^{2+} release, called Ca^{2+} mobilization. During sustained agonist occupancy, Ca^{2+} mobilization is accompanied by Ca^{2+} flux into the cell.

ceptors, activated by: acetylcholine (54), angiotensin II (244), ATP (474), ETs (52, 53), oxytocin (674), 5-HT (54), substance P (672, 675), TRH (242), and galanin (676–678). Mammalian melanotrophs express muscarinic receptors (679), and frog melanotrophs express Ca^{2+} -mobilizing receptors for TRH and neuropeptide Y (26), in addition to muscarinic receptors (27). In corticotrophs, the Ca^{2+} -mobilizing pathway is activated by AVP (176, 680, 681), norepinephrine (682), and potentially by 5-HT (398). Somatotrophs express Ca^{2+} -mobilizing ghrelin (46) and ET_A (48) receptors. Several Ca^{2+} -mobilizing receptor tyrosine kinases are also expressed in pituitary cells (683–689), but their effects on Ca^{2+} signaling and electrical activity have not been studied in pituitary cells.

The activated $G_{q/11}$ protein leads to phosphoinositide hydrolysis and the production of IP_3 and DAG (690). IP_3 binds to IP_3 Rs in the ER membrane and along with Ca^{2+} is required for their activation. Activation binding sites for both IP_3 and Ca^{2+} are on the cytoplasmic side of the membrane. As stated in *Section III.C.1*, there are three closely

related subtypes of the mammalian IP₃R, and the functional receptor forms a tetramer (691). It appears likely that each subunit must be bound by IP₃ and Ca²⁺ for activation of the receptor (692). Once activated, the IP₃R functions as a Ca²⁺ channel, allowing Ca²⁺ to flow down its concentration gradient from the ER into the cytosol. The Ca²⁺ flux can be terminated by inactivation of the receptor, which occurs through binding of Ca²⁺ to an inactivation site on each subunit on the cytoplasmic side of the receptor. Thus, activation of one branch of the G_{q/11} pathway leads to Ca²⁺ mobilization from the ER store. The other branch follows the production of DAG, which together with Ca²⁺ activates PKC (693).

A. The dynamics of Ca²⁺ release

The ER is the primary storehouse for Ca²⁺ in most cells, including pituitary cells, with a resting Ca²⁺ concentration ([Ca²⁺]_{ER}) of a few hundred micromolar (694, 695). This is in contrast to the resting level of [Ca²⁺]_i, which is approximately 0.1 μM. The high [Ca²⁺]_{ER} is maintained by SERCA pumps. Efflux of Ca²⁺ from the ER is through passive leakage and through IP₃R and/or RyRs (696). Because of the large concentration difference, the activation of IP₃R by a G_{q/11} agonist results in a large and sudden increase in [Ca²⁺]_i. After this initial Ca²⁺ pulse, one of two behaviors is typically observed, depending on the cell type and in some cases on agonist. One behavior involves oscillations, whereas the other does not. In lactotrophs, somatotrophs, thyrotrophs, and cells from the GH cell lines, the pulse is typically followed by a slow decline to a plateau in [Ca²⁺]_i, although some cells may only have a pulse or a plateau, and in a fraction of cells oscillations are observed (242, 282, 697, 698). PRL secretion from lactotrophs is increased during both the [Ca²⁺]_i pulse and the subsequent decay and plateau phases (282). In mammalian gonadotrophs, the pulse is typically followed by large [Ca²⁺]_i oscillations (172, 173, 245, 521, 699). Fish gonadotrophs also show an oscillatory Ca²⁺ response to application of GnRH (700). However, αT3-1 (255) and LβT2 (42) mice gonadotrophs show nonoscillatory amplitude-modulated Ca²⁺ signals in response to GnRH application. Corticotrophs respond to norepinephrine with extracellular Ca²⁺-independent Ca²⁺ oscillations (682). In contrast, stimulation of these cells with AVP results in the pulse-decay-plateau type of response (176, 680).

1. Pulse-decay-plateau Ca²⁺ release

The pulse-decay-plateau Ca²⁺ response requires only that the IP₃Rs open and remain open during agonist application. That is, the IP₃R is passive. Such response is illustrated with a mathematical model (701) in Fig. 13. The top panel shows [Ca²⁺]_i in response to agonist acti-

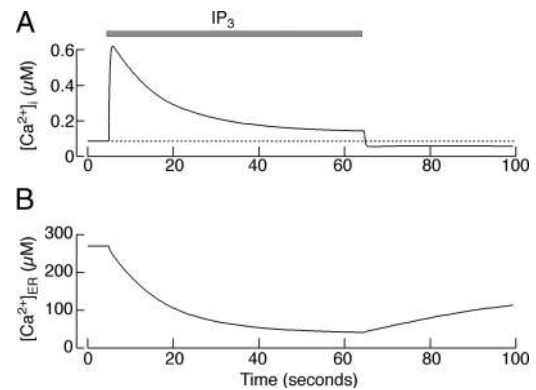

FIG. 13. Model simulation of the pulse-decay-plateau Ca²⁺ response to activation of the G_{q/11} pathway. A, Activation of the pathway results in production of IP₃, which binds to IP₃R and releases Ca²⁺ from the ER into the cytosol. This results in a rapid rise in [Ca²⁺]_i, and subsequent decay to an elevated plateau. In this and all other modeling figures, the IP₃ concentration is constant during simulated application. B, Partial depletion of the ER Ca²⁺ store due to release of Ca²⁺ through IP₃R. The slow [Ca²⁺]_{ER} decay underlies the slow decay of [Ca²⁺]_i. This model and others used in the article can be downloaded as freeware from www.math.fsu.edu/~bertram/software/pituitary.

vation of the G_{q/11} pathway and subsequent production of IP₃. The bottom panel shows [Ca²⁺]_{ER}, a quantity that is difficult to measure experimentally. The initial rapid increase in [Ca²⁺]_i is followed by a slow decline, reflecting the removal of Ca²⁺ from the cell by plasma membrane ATPase pumps and a Na⁺-dependent Ca²⁺ efflux. The decline in [Ca²⁺]_i is mirrored by a decline in [Ca²⁺]_{ER}, although [Ca²⁺]_{ER} is much larger. As [Ca²⁺]_{ER} declines to a sufficiently low level, a Ca²⁺ entry pathway is activated, bringing additional Ca²⁺ into the cell and producing an elevated plateau in [Ca²⁺]_i that is evident near the end of the agonist application. When the agonist is removed, [Ca²⁺]_i initially declines to a subbasal level and slowly climbs back to a basal level. This drop and slow rise are due to the increased Ca²⁺ flux into the ER that occurs as [Ca²⁺]_{ER} slowly returns to its basal level.

Notice a relatively rapid depletion of the ER Ca²⁺ store in the presence of agonist in Fig. 13. In cells bathed in Ca²⁺-deficient medium or with blocked VGCI, [Ca²⁺]_i drops to basal levels within a few minutes, indicating that sustained Ca²⁺ signaling by Ca²⁺-mobilizing GPCRs is critically dependent on Ca²⁺ influx. This is well illustrated in TRH-stimulated lactotrophs in cells bathed in Ca²⁺-deficient medium and by cells stimulated with ET (a Ca²⁺-mobilizing agonist that inhibits VGCI; see Section VII.B.3) in the presence of Ca²⁺ (281, 282).

Although the [Ca²⁺]_{ER} of pituitary cells is not typically measured, Fig. 13 suggests that the time course of [Ca²⁺]_{ER} during agonist application is reflected in the [Ca²⁺]_i time course. That is, the rate of decline in [Ca²⁺]_i after the initial peak is determined largely by the time dynamics of [Ca²⁺]_{ER}. If the decline of [Ca²⁺]_{ER} is more

rapid, then so too will be the decline in $[Ca^{2+}]_i$. If factors such as the total IP_3R conductance activated by agonist or the Ca^{2+} leakage rate are larger in one cell than a second cell, then the decline in $[Ca^{2+}]_{ER}$ and $[Ca^{2+}]_i$ will be more rapid in the first cell. In contrast, if the SERCA pumping rate is larger in one cell than another, then the decline in $[Ca^{2+}]_{ER}$ and $[Ca^{2+}]_i$ will be slower in the first cell. Thus, the decline in the readily measured $[Ca^{2+}]_i$ is an assay for the typically unmeasured $[Ca^{2+}]_{ER}$ (701–703) that could also be used in further work with pituitary cells.

The Ca^{2+} response to a $G_{q/11}$ -activating agonist can have a large impact on the plasma membrane potential. The pulse of Ca^{2+} that follows agonist application activates SK type K_{Ca} channels in the plasma membrane in rat somatotrophs, lactotrophs, corticotrophs, and GH_3 cells (171, 680, 704). The K_{Ca} current hyperpolarizes the membrane, terminating any spontaneous electrical activity that was present before agonist application (228, 282). Some time after the initial Ca^{2+} pulse, the membrane typically depolarizes, due to the modulation of a still-undefined current, presumably the down-regulation of an M (153) or an erg current (155, 158, 161). This depolarization activates Ca_v channels, further depolarizing the cell and initiating electrical activity such as spiking or bursting (282). This electrical activity would then be reflected in the $[Ca^{2+}]_i$ time course as small oscillations on top of the plateau in Fig. 13A and would contribute to the plateau. In studies done in the absence of extracellular Ca^{2+} , the $[Ca^{2+}]_i$ declines to below its basal level even while the agonist (TRH) is present (698). In this case, neither capacitative Ca^{2+} entry nor Ca_v currents provide the Ca^{2+} influx required for the $[Ca^{2+}]_i$ plateau or small oscillations after the initial surge in $[Ca^{2+}]_i$.

Thus, VCGI represents the major pathway for the plateau Ca^{2+} response during the sustained agonist stimulation and for recovery of the ER calcium pool after removal of agonist, but other pathways could also be operative. Although there is some evidence supporting the presence of store-operated Ca^{2+} entry in pituitary cells (272, 698), the data are inconclusive. In other cell types, it is also well established that Ca^{2+} -mobilizing receptors can activate the TRP family of channels, which conduct Ca^{2+} and also depolarize the cells, leading to facilitation of VCGI (219). Further studies are needed to clarify whether this pathway is activated by Ca^{2+} -mobilizing receptors in pituitary cells.

Sustained activation of Ca^{2+} -mobilizing GPCRs also causes changes in the gating properties of plasma membrane channels. In GH_3 cells, the Ca^{2+} released from the ER initially inactivates a Ca_v current, but this phase is followed by stimulation of the Ca_v current, which can contribute to the plateau (705). Both G_i ($\alpha 2$ and $\alpha 3$) and PKC are required for this TRH-induced stimulation of a

Ca_v current (706). In thyrotrophs and lactotrophs, a return to tonic spiking at higher frequency was accompanied with lower spike amplitude in the presence of TRH due to inhibition of L-type Ca_v channels (707).

2. IP_3R -mediated Ca^{2+} oscillations

Unlike the spontaneous Ca^{2+} oscillations that often occur in pituitary cells, those induced by GnRH in gonadotrophs or norepinephrine in corticotrophs persist when the bath Ca^{2+} is removed as well as in cells bathed in the presence of Ca^{2+} but clamped at potentials that silence Ca^{2+} influx through Ca_v channels (283, 682). This illustrates that the oscillation is intrinsic to the Ca^{2+} handling properties within the cell. There are differences in the oscillatory Ca^{2+} mobilization between these two cell types. In gonadotrophs, the oscillatory Ca^{2+} release is activated not only by GnRH but also by ET-1, PACAP, and AVP (172, 173, 245, 521, 699). In contrast, baseline Ca^{2+} oscillations are triggered by α -adrenergic stimulation of corticotrophs but not AVP application (682). Furthermore, the frequency of Ca^{2+} oscillations in gonadotrophs is determined by agonist concentration and varies between three and 20 pulses per minute (253, 708), whereas norepinephrine generates Ca^{2+} oscillations with a frequency of about one per minute (682).

In gonadotrophs, oscillations in IP_3 are not required to generate oscillatory Ca^{2+} release as documented by injection of nonmetabolized IP_3 analogs. Furthermore, the concentration of IP_3 underlines the frequency of Ca^{2+} spiking (249). The $[Ca^{2+}]_i$ influences IP_3 -dependent Ca^{2+} release in these cells. The rapid stimulatory effect of Ca^{2+} on IP_3 -dependent Ca^{2+} release in gonadotrophs is nicely demonstrated by phase resetting of GnRH-induced oscillations by a brief pulse of Ca^{2+} entry (250). The inhibitory effect of high $[Ca^{2+}]_i$ on GnRH-induced Ca^{2+} oscillations is also shown (251). Finally, inhibition of SERCA pumps causes a transition from the oscillatory to the nonoscillatory mode of Ca^{2+} release in GnRH-stimulated gonadotrophs (709, 710). At the present time, it is unknown whether nonoscillatory elevation in intracellular IP_3 levels could generate Ca^{2+} oscillations in corticotrophs.

3. Mathematical models of IP_3 -induced Ca^{2+} oscillations

A series of mathematical models were developed to help understand the mechanism for $G_{q/11}$ agonist-induced Ca^{2+} oscillations in gonadotrophs and how these depend on Ca^{2+} flux across the plasma membrane and between the cytosol and the ER (252, 711–714). These models all assume that the key player in the Ca^{2+} oscillations is an active IP_3R (called class 1 models in Ref. 715). These models also assume no role for mitochondria in the oscillations, which is contrary to some data (but the models can

start of the next spike the driving force will be the same as it was for the prior spike. However, when the influx through the plasma membrane is eliminated ($J_{in} = 0$), there is a progressive loss of Ca^{2+} from the cell, and therefore the ER does not refill completely between spikes. For this reason, the driving force is smaller for each subsequent spike, resulting in a slow decline in the spike amplitude. Also, because of the progressive decline in the driving force, the fraction of IP_3 R that must recover from inactivation for the start of a new spike gets progressively larger. That is, h must rise to progressively larger values to trigger spikes, so the time between spikes increases (frequency decreases). These behaviors, a slow decline in spike amplitude and spike frequency, are observed in GnRH-stimulated gonadotrophs in a Ca^{2+} -deficient medium (252, 289).

Although an active IP_3 R provides a good explanation for agonist-induced Ca^{2+} oscillations in gonadotrophs (and other cells in which similar oscillations are produced), Ca^{2+} oscillations may also be produced through the stimulatory feedback of Ca^{2+} onto PLC (720), which produces IP_3 , or onto 3-kinase (721), which converts IP_3 to IP_4 . With this mechanism (class 2 models) (715), oscillation in the IP_3 concentration is a key element, unlike the case described above where oscillations in Ca^{2+} are produced for a constant IP_3 concentration (class 1 models). These two classes of models for $G_{q/11}$ agonist-induced oscillations have been recognized for many years (722, 723). It is difficult to determine from inspection only which mechanism is responsible for oscillations in a given cell, and there is evidence that the oscillation class is determined by the type of GPCR activated (724). Consistent with this, norepinephrine generates Ca^{2+} oscillations in corticotrophs, whereas AVP does not. The slow frequency of Ca^{2+} oscillations in corticotrophs may suggest that these oscillations were mediated by oscillatory IP_3 production.

4. Role of mitochondria in IP_3 -induced Ca^{2+} release

Another player in the production of depolarization- and agonist-induced Ca^{2+} transients in pituitary cells is the mitochondrial Ca^{2+} store. Calcium is transported into mitochondria through Ca^{2+} uniporters, which are powered by the membrane potential across the inner membrane. Calcium is transported out of mitochondria primarily by Na^+/Ca^{2+} exchangers (725). It has been demonstrated that these actions impact the cytosolic Ca^{2+} time course in neurons (726–728). In corticotrophs, the rate of Ca^{2+} clearance after depolarization-induced Ca^{2+} influx is dramatically slowed by mitochondrial uncouplers or inhibitors of the mitochondrial uniporter. This in turn enhances the exocytotic response (729). In gonadotrophs, early work by Hille's group (719) revealed that Ca^{2+} released from the ER is partly taken up by the ER and

partly pumped into other intracellular compartments or out of the cells. Subsequent studies by the same group showed that collapsing the mitochondrial inner membrane potential with the protonophore carbonyl cyanide *m*-chlorophenylhydrazone, a manipulation that inhibits Ca^{2+} uptake into mitochondria, slowed or inhibited GnRH-induced cytosolic Ca^{2+} oscillations (730, 731).

Although these data demonstrate that mitochondrial Ca^{2+} filtering plays a role in the generation of agonist-induced Ca^{2+} oscillations, they do not allow one to determine whether this role is active or passive. That is, it is not evident whether the oscillations in mitochondrial Ca^{2+} content are required for the production of cytosolic oscillations (mitochondrial Ca^{2+} is an active player), or whether cytosolic oscillations would persist if the mitochondrial Ca^{2+} level could be clamped at its mean level in the stimulated cell (mitochondrial Ca^{2+} is a passive player). Although oscillations in mitochondrial Ca^{2+} concentration have been measured in gonadotrophs (730), it is not known whether these oscillations are required for the generation of cytosolic Ca^{2+} oscillations. In a mathematical modeling study, a Ca^{2+} oscillation model was modified so that oscillations were produced only if a mitochondrial Ca^{2+} store was present (732). However, the mitochondrial store played a passive role because $[Ca^{2+}]_i$ oscillations were produced even when the mitochondrial Ca^{2+} concentration was clamped at its mean stimulated value (R. Bertram, unpublished observation).

5. Coupled membrane and IP_3 -mediated oscillations

In two studies of GnRH-stimulated rat gonadotrophs, the membrane was voltage clamped, and the frequency of the oscillations in Ca^{2+} concentration was measured (269, 283). This procedure allows one to separate the IP_3 R-mediated oscillation from the intrinsic membrane oscillation discussed in *Section III*. It also provides a means to control the rate of Ca^{2+} influx by adjusting the holding potential of the cell. When the holding potential is low (hyperpolarized), few voltage-dependent Ca^{2+} channels are open, and the Ca^{2+} current is small. For larger (depolarized) holding potentials, many Ca^{2+} channels are open, yielding a larger Ca^{2+} current.

Besides demonstrating that Ca^{2+} oscillations persist in the absence of membrane potential oscillations, the study demonstrated that oscillations died out if the holding potential was not sufficiently depolarized. This could be explained by a gradual depletion of the ER due to insufficient replenishment of Ca^{2+} . In other words, redistribution of Ca^{2+} between ER and mitochondrial pools is not sufficient to prevent the depletion of the intracellular Ca^{2+} in oscillating cells. However, in cells clamped at -60 mV, GnRH-induced Ca^{2+} oscillations last for 6–15 min, much longer than Ca^{2+} signals in voltage-clamped cells respond-

ing to activation of Ca^{2+} -mobilizing receptors with a pulse-decay-plateau Ca^{2+} release. This indicates that depletion of the intracellular Ca^{2+} takes longer in cells with oscillatory Ca^{2+} release (283). As stated above, two Ca^{2+} -handling mechanisms are operative in GnRH-stimulated gonadotrophs: redistribution of Ca^{2+} within ER and mitochondrial pools, and a Na^{+} -dependent Ca^{2+} efflux followed by Ca^{2+} influx. Thus, it is reasonable to suggest that GnRH-induced baseline Ca^{2+} oscillation makes gonadotrophs less dependent on Ca^{2+} influx, in contrast to agonist-stimulated lactotrophs and somatotrophs. Consistent with this, our work with neonatal gonadotrophs showed that redistribution of Ca^{2+} within the cells dominates in GnRH-stimulated cells exhibiting baseline Ca^{2+} oscillations, whereas removal of Ca^{2+} from the cells dominates in GnRH-stimulated cells showing a prolonged Ca^{2+} spike, similar to those observed in agonist-stimulated lactotrophs and somatotrophs (256).

Experiments with cells voltage-clamped at different potentials also showed that the Ca^{2+} spike frequency increased with increases in the holding potential (for potentials between -60 and -20 mV). The interpretation of this, reproduced with our model, is that the greater Ca^{2+} influx provided by increased membrane depolarization fills the ER to higher levels, increasing the driving force for the Ca^{2+} spikes so that h does not have to rise as high to initiate a new spike. Thus, spikes are produced at shorter time intervals (269, 283).

From the discussion above, it is also evident that Ca^{2+} oscillations produced by agonist-stimulated gonadotrophs only require Ca^{2+} flux across the plasma membrane to keep the ER- Ca^{2+} store replenished; no patterned electrical activity is required. This is unlike other endocrine cells, where Ca^{2+} oscillations are due to bursting electrical activity (70, 184, 291, 293, 294, 733). However, stimulated gonadotrophs do produce electrical bursting, due to the bidirectional interactions between the plasma membrane and the ER (173, 289, 711, 734). Ion channels in the plasma membrane bring Ca^{2+} into the cell during each spike, which replenishes the ER and thereby provides coupling from the membrane to the ER.

Coupling from the ER to the plasma membrane is mediated through Ca^{2+} -activated SK channels (70, 72, 172, 173, 176). In mouse gonadotrophs, BK channels also contribute to the hyperpolarization of the plasma membrane (174). As discussed in *Section VIII.A.1*, this bidirectional coupling is also present in thyrotrophs and lactotrophs, but in agonist-activated gonadotrophs there are intrinsic activity oscillations in both the plasma membrane and the ER. Furthermore, after the hyperpolarization, gonadotrophs do not return to the tonic spiking state that typically characterizes the unstimulated cell, but instead they ex-

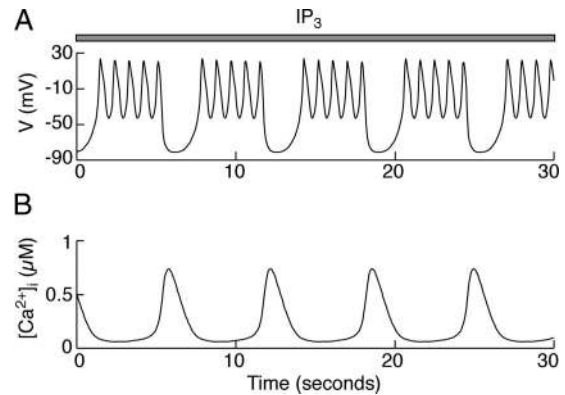

FIG. 15. Model simulation of coupled IP_3R and membrane oscillations. A, Bursting electrical oscillations are produced due to periodic hyperpolarizations that result from the activation of Ca^{2+} -activated K^+ (K_{Ca}) current. B, IP_3R -mediated oscillations in $[\text{Ca}^{2+}]_i$ periodically activate K_{Ca} current so that each peak of $[\text{Ca}^{2+}]_i$ produces a silent phase of the burst.

hibit a bursting pattern consisting of tall electrical spikes clustered into episodes. This bursting behavior is illustrated in Fig. 15 using a simple mathematical model from Ref. 716; a more detailed model can be found in Ref. 711. The key feature is the antiphasic pattern of electrical activity and Ca^{2+} spikes. This is due to the inhibitory action of each Ca^{2+} spike on the plasma membrane; each Ca^{2+} spike activates a Ca^{2+} -activated K^+ current, which terminates electrical spiking. The electrical spiking resumes once $[\text{Ca}^{2+}]_i$ returns to a low level after the Ca^{2+} spike. Thus, the Ca^{2+} oscillator periodically interrupts the plasma membrane oscillator, producing a bursting pattern of electrical activity. Thus, the electrical activity and secretion are out of phase; the former serves to refill the ER, which provides the periodic Ca^{2+} pulse needed to evoke secretion. However, such a pattern of GnRH-induced electrical activity still does not protect the L-type Ca_v channels from Ca^{2+} -dependent inactivation, resulting in smaller amplitude of this current (735).

B. Calcium mobilization and secretion

The release of neurotransmitter from neuronal synapses occurs when Ca^{2+} that enters through channels in the plasma membrane binds to nearby release sites. This secretion is rapid (less than 1 msec), and the speed of exocytosis is critical for neuronal functions. Thus, it is the localized high-concentration Ca^{2+} nanodomains that gate release (346, 736), not the bulk cytosolic Ca^{2+} . This allows single APs to evoke transmitter release, although the change in the mean $[\text{Ca}^{2+}]_i$ is small. In contrast, secretion in pituitary cells is slow. Initially, it was postulated that one of three reasons could underlie such slow secretion in endocrine cells: that Ca_v channels and secretory vesicles are not molecularly colocalized; that the exocytotic machinery is intrinsically slower; or that secretory vesicles are

not in close proximity to the plasma membrane to form the fusion pore (342).

As discussed in *Section IV.E.3*, spontaneous electrical activity in corticotrophs, gonadotrophs, and thyrotrophs does not trigger prominent secretion. In these cells, facilitation of VGCI by Bay K 8644, an L-type Ca^{2+} channel activator, and high K^+ -induced depolarization of cells generates large amplitude Ca^{2+} signals and stimulates ACTH, LH, PRL, and GH secretion (345, 737). In melanotrophs, lactotrophs, and somatotrophs, spontaneous electrical activity is sufficient to activate the exocytotic pathway, but in these cells spontaneous APs generate large-amplitude global Ca^{2+} signals. Single-cell recordings showed that pituitary cells start secreting at submicromolar $[\text{Ca}^{2+}]_i$ (738) and therefore have a high Ca^{2+} affinity (342). This indicates that in pituitary cells secretory vesicles are not colocalized with Ca_v channels and that global Ca^{2+} signals are needed to initiate fusion of vesicles with the plasma membrane.

Consistent with this view, activation of Ca^{2+} -mobilizing receptors in all endocrine pituitary cell types generates global Ca^{2+} signals and stimulates secretion. It appears that the pattern of Ca^{2+} mobilization (pulse-decay-plateau response *vs.* baseline Ca^{2+} oscillations) is not critical for activation of the exocytotic pathway, as is shown in experiments with rat corticotrophs in which both AVP (the pulse-decay-plateau response) (176) and norepinephrine (baseline oscillations) elicit secretion (682). Also, in $\text{L}\beta\text{T2}$ gonadotrophs, GnRH induces Ca^{2+} oscillations and hormone secretion, as monitored by measurements of plasma membrane capacitance (42). In rat gonadotrophs, the frequency of the oscillations and level of secretion are dependent on the GnRH level, so there is frequency coding in the Ca^{2+} response. Furthermore, activation of the exocytotic pathway in GnRH-stimulated gonadotrophs has nothing to do with the bursting electrical pattern exhibited by stimulated cells because secretion occurs during the Ca^{2+} pulses, when the plasma membrane is hyperpolarized (739, 740). These and other data indicate that two factors contribute to the effective coupling of Ca^{2+} -mobilizing receptors to secretion in endocrine pituitary cells. First, Ca^{2+} -mobilizing receptors in pituitary cells generate high amplitude global Ca^{2+} signals. Second, in corticotrophs and gonadotrophs, the majority of the secretion is from release sites colocalized with IP_3R in the ER (739). In corticotrophs, both intracellular Ca^{2+} release and VGCI generate a spatial Ca^{2+} gradient, such that the local $[\text{Ca}^{2+}]_i$ near the exocytotic sites is about 3-fold higher than the mean $[\text{Ca}^{2+}]_i$ (741). Thus, the plume of high Ca^{2+} concentration that forms near a single IP_3R or a cluster of IP_3Rs gates exocytosis. This hypothesis could also account for the finding that Ca^{2+} evokes exocytosis from melano-

trophs more effectively when it is released from the ER than when it is introduced through a recording pipette (742). Also, in pancreatic acinar cells, both exocytosis and Ca^{2+} release from the ER through IP_3Rs occur at the apical pole of the cell, suggesting some degree of colocalization of release sites and IP_3Rs (743).

Ca^{2+} -mobilizing receptors trigger not only Ca^{2+} signaling but also several other intracellular signaling pathways, which also contribute to the effectiveness of stimulus secretion coupling. One of the major signaling molecules contributing to the control of exocytosis during activation of Ca^{2+} -mobilizing receptors is DAG. In association with Ca^{2+} , DAG activates PKC, which has been shown to have several effects on gonadotrophs. In cells stimulated by GnRH, activation of PKC by application of phorbol 12-myristate 13-acetate (PMA) slowed down the Ca^{2+} oscillations and enhanced the SK current (175). These two effects appear to be independent because when unstimulated cells were loaded with IP_3 , the PMA had no effect on the frequency of Ca^{2+} oscillations, yet still enhanced the SK current induced by the Ca^{2+} oscillations. This suggests that PKC directly enhances SK current and also has an effect on PLC. Another study showed that PMA-activated PKC reduces Ca^{2+} influx in response to depolarization in gonadotrophs (241). This same study also found that depolarization-mediated secretion was enhanced by PKC, despite the reduction in Ca^{2+} influx. It is thus apparent that PKC has an action downstream of Ca^{2+} entry that amplifies secretion.

In chromaffin cells (744) and hippocampal neurons (745), the activation of PKC by phorbol esters or DAG increases the size of the readily releasable pool of vesicles by increasing the rate at which the pool is refilled. To see whether this was the case in gonadotrophs, flash photolysis was used to uncage Ca^{2+} , and both the membrane capacitance and the intracellular Ca^{2+} level were measured (746). With these measurements, the Ca^{2+} dependence of exocytosis was established, in both control cells and those in the presence of PMA. There was a substantial left shift of the response curve when PMA was present, but no significant change in the calculated size of the readily releasable pool. Thus, it appears that PKC enhances secretion from gonadotrophs by sensitizing the secretory machinery to Ca^{2+} (746). This is not totally at odds with the actions of PKC on chromaffin cells and hippocampal neurons because the fact that the readily releasable pool is unchanged by PMA in the face of increased secretion suggests that the rate of refilling of the pool is enhanced by the PMA, as it is in chromaffin cells and hippocampal neurons. The sensitizing actions of PKC in gonadotrophs could account for the finding that secretion is greater when $[\text{Ca}^{2+}]_i$ is elevated by application of GnRH rather than by

pipette or through photolysis of caged Ca^{2+} (739) because GnRH would activate PKC via DAG. In lactotrophs, PMA increases both granule-to-granule and granule-to-plasma membrane fusion events, which could account for potentiation of secretion by the PKC-dependent pathway (535).

Activation of GnRH receptors in gonadotrophs also leads to stimulation of phospholipase D (747, 748) in a PKC-dependent manner (748). This enzyme stimulates production of phosphatidic acid, which subsequently can be dephosphorylated to DAG by phosphatidate phosphohydrolase to sustain activation of PKC. In chromaffin cells, phosphatidic acid participates in the control of exocytosis (749). Also, in GT1 cells, the phospholipase D signaling pathway contributes to GnRH release (750). Further studies are needed to clarify the relevance of this signaling pathway in secretion from endocrine pituitary cells. One of the mechanisms could be activation of stimulus-transcription coupling by the phospholipase D signaling pathway (751) and facilitation of *de novo* formation of secretory vesicles. The sustained GnRH-stimulated and VGCI-dependent LH release is completely blocked by wortmannin at concentrations that inhibit phosphatidylinositol 4-kinase, an enzyme that participates in inositol phosphate metabolism (752), suggesting a potential role of PIP_2 in VGCI-dependent gonadotropin secretion. The steroid background also has a profound effect both on stimulus-induced Ca^{2+} mobilization and on Ca^{2+} -sensitivity of exocytosis (42, 753–756).

IX. Summary

The introduction of patch clamp techniques (757) was critical in the electrophysiological characterization of numerous voltage-gated Na^+ , Ca^{2+} , and K^+ channels in endocrine pituitary cells and their roles in spontaneous electrical activity, as well as in the characterization of receptor channels expressed in pituitary cells. GPCR-controlled electrical activity in single pituitary cells was also extensively studied using patch clamp techniques. The discovery of fluorescent dyes that are suitable for intracellular single-cell recordings, such as Indo-1 and Fura-2 (758), helped with the study of both the AP-driven rise in $[\text{Ca}^{2+}]_i$ and the IP_3 -driven Ca^{2+} release from ER in pituitary cells. Simultaneous measurements of currents and $[\text{Ca}^{2+}]_i$ or membrane potential and $[\text{Ca}^{2+}]_i$ in pituitary cells were important in characterizing the relationship between spontaneous and receptor-controlled electrical activity and Ca^{2+} signaling, as well as synchronization between Ca^{2+} mobilization and electrical activity. The discovery of fluorescent dyes for measurements of single-cell exocytosis (759) also complemented patch clamp capacitative measurements in studies on Ca^{2+} -dependent hormone secretion (760).

These techniques helped to establish that voltage-gated channels provide a basic signaling system for individual pituitary cells. Like neurons, endocrine pituitary cells express numerous voltage-gated Na^+ , K^+ , and Ca^{2+} -conducting channels, as well as cation-conducting cyclic nucleotide-modulated and TRP channels. In contrast to neurons, propagation of APs within endocrine pituitary cells is unlikely to occur, and the main function of APs in pituitary cells is to provide a driving force for Ca^{2+} influx through Ca_v channels. It is now well established that in three of the six endocrine pituitary cells—lactotrophs, somatotrophs, and melanotrophs—spontaneous electrical activity is sufficient to trigger hormone release in the absence of any stimulus. In gonadotrophs, thyrotrophs, and corticotrophs, spontaneous electrical activity is probably not coupled to secretion, at least in a majority of cells *in vitro*. It is reasonable to conclude that spontaneous electrical activity maintains these cells in a responsive state with $[\text{Ca}^{2+}]_i$ near the threshold level. It is also interesting to note that this division of cells into two groups is not consistent with the embryonic development of endocrine cells (Fig. 1). The pattern of electrical activity (single spikes *vs.* pseudo-plateau bursting) and the frequency of firing determine the AP secretion coupling in single cells. The channels participating in spike depolarization and repolarization are relatively well characterized, whereas further work is needed to identify channels responsible for the pacemaking activity.

The status of the electrical signaling system in pituitary cells *in vivo* is critically dependent on the release of stimulating and inhibiting neurohormones from the hypothalamus. These agonists act on G_s - and $G_{i/o}$ -coupled receptors expressed in pituitary cells (Fig. 16). Not accidentally, the inhibitory $G_{i/o/z}$ -coupled receptors are expressed predominantly in cells in which spontaneous electrical activity is sufficient to trigger hormone secretion; gonadotrophs express melatonin receptors, but only during embryonic and neonatal life. It has also been established that inhibition of spontaneous electrical activity, not inhibition of AC activity, accounts for down-regulation of basal PRL, GH, and α -MSH release. Solid evidence was obtained to support the concept that GPCRs inhibit electrical activity by inhibiting Ca_v channels and/or stimulating K_{ir} channels. In contrast, activation of G_s -coupled receptors leads to stimulation of electrical activity. Figure 16 shows that the G_s signaling pathway plays a major role in only two cell types: somatotrophs and corticotrophs. This signaling system changes the pattern of electrical activity by facilitating unidentified Na^+ -conducting channels and by facilitating Ca_v conductance, both in a PKA-dependent manner. The relevance of potential phosphorylation of TTX-sensitive Na^+ channels and cAMP-dependent activation of HCN

SOMATOTROPHS:	Somatostatin	PACAP GHRH	Endothelin Ghrelin
CORTICOTROPHS:		CRH	Norepinephrine Vassopressin
LACTOTROPHS:	Adenosine Dopamine Endothelin GABA Neuropeptide Y 5-HT	VIP	Acetylcholine Angiotensin II ATP Oxytocin Serotonin Substance P TRH
MELANOTROPHS:	Dopamine GABA Serotonin	PACAP	Acetylcholine
GONADOTROPHS:	Melatonin*		GnRH Endothelin PACAP Substance P Vassopressin
THYROTROPHS:	Somatostatin		Endothelin TRH

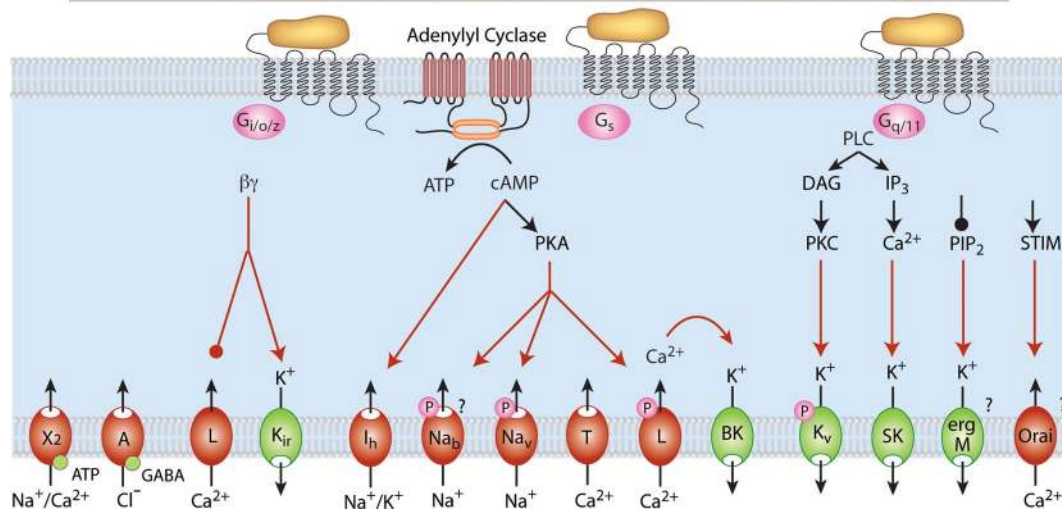

FIG. 16. GPCR-modulated channel activity in pituitary cells. GPCRs expressed in pituitary cells regulate numerous voltage-gated channels through intracellular messengers. *Top panel* shows agonists that activate GPCRs in mammalian cells. *Red letters* indicate the principal regulators of pituitary functions, and *black letters* indicate agonists that modulate pituitary cell function. Note that only somatotrophs utilize all three signaling pathways and that lactotroph function is regulated by numerous G_i and G_{q/11}-coupled receptors. Melatonin receptors are present only in neonatal pituitary gonadotrophs. *Bottom panel* shows channels expressed in pituitary cells in which gating is affected by an intracellular messenger. The nature of Na_B current is unknown at the present time, as well as the Na⁺-conducting channel that is phosphorylated by PKA. It has also not been clarified whether inhibition of erg and M current accounts for agonist-induced depolarization of cells and sustained stimulation. The operation of the STIM/Orai pathway in pituitary cells has not been established.

channels to the pattern of electrical activity is minimal in cultured cells but may play an important role in intact tissue.

Within the pituitary, there are three additional families of channels contributing to signaling: gap junction channels, receptor channels, and intracellular Ca²⁺ release channels. The role of gap junction coupling is well established in folliculostellate cells, but further work is needed to clarify their relevance in communication among secretory cell types. The potential relevance of these proteins forming hemichannels is also awaiting clarification. At least three types of receptor channels are expressed by pituitary cells: nAChRs, GABA_A, and P2XRs. In contrast to brain cells, where GABA_A channels are inhibitory, in

pituitary cells they stimulate electrical activity, as do nAChRs and P2XRs. GABA_A channels are common to all endocrine cells, as are P2XRs, but there is a cell type-specific expression of P2XR subtypes of these channels among pituitary cells. It appears that nAChRs are specific for POMC-producing melanotrophs and corticotrophs. From the electrophysiological point of view, these channels are relatively well characterized. Further work in this field should be focused on physiological conditions under which acetylcholine, GABA, and ATP are released.

All pituitary cells have an additional system to control intracellular calcium, composed of the calcium-conducting channels expressed in the ER membrane. Endocrine pituitary cells express at least 15 subtypes of G_{q/11}-coupled

GPCRs (Fig. 16) as well as several receptor tyrosine kinases, whose activation leads to mobilization of intracellular Ca^{2+} in an IP_3 -dependent manner. Ca^{2+} mobilization provides an additional security system for these cells to control hormone secretion, which is a calcium-dependent process. The pattern of Ca^{2+} release signaling is cell type specific, but not receptor type specific. Gonadotrophs have the most sophisticated Ca^{2+} mobilization pathway; they release Ca^{2+} in an oscillatory manner in response to activation of any of the Ca^{2+} -mobilizing receptors expressed in these cells, as well as in response to injection of IP_3 , with a frequency of spiking determined by IP_3 concentrations. Norepinephrine-stimulated corticotrophs also release Ca^{2+} in an oscillatory manner, but at lower frequency. In all other pituitary cell types, Ca^{2+} -mobilizing receptors trigger Ca^{2+} release in a nonoscillatory manner, raising the question of why the sister cells respond differently to activation of the $\text{G}_{q/11}$ pathway.

From the physiological point of view, electrically driven Ca^{2+} signals in somatotrophs, lactotrophs, and melanotrophs resemble the signaling pathway of neuronal cells, requiring high Ca^{2+} in extracellular medium and APs as a driving force for Ca^{2+} influx and secretion. In these cells, Ca^{2+} mobilization is a supplementary pathway to VGCI to up-regulate secretion, and oscillations in $[\text{Ca}^{2+}]_i$ are achieved by periodic activation of Ca_v channels. The Ca^{2+} release pathway provides only a transient source for nonoscillatory elevation in $[\text{Ca}^{2+}]_i$ due to the continuous opening of the IP_3 Rs in the presence of agonist, and Ca^{2+} influx through Ca_v channels is critical for sustained Ca^{2+} signaling. It is unlikely that capacitative Ca^{2+} entry is the major driving force for sustained Ca^{2+} influx. Further studies are needed to identify channels involved in sustained depolarization in these cells, including TRP channels that could be activated by Ca^{2+} -mobilizing receptors. GH cell lines behave similarly, suggesting that from the Ca^{2+} signaling point of view they are good cell models.

Gonadotrophs, on the other hand, resemble skeletal muscle cells, relying on Ca^{2+} mobilization for a prolonged period and with VGCI controlling the “excitability” of the ER membrane during receptor activation. In these cells, oscillations in $[\text{Ca}^{2+}]_i$ are generated by periodic activation of IP_3 Rs during continuous stimulation of Ca^{2+} -mobilizing receptors due to bidirectional actions of cytosolic Ca^{2+} on the gating of these channels. Conservation of intracellular Ca^{2+} is achieved by its redistribution between ER and mitochondria. In contrast to skeletal muscle cells, there is a “leak” of Ca^{2+} from the cells, and VGCI is temporally separated from Ca^{2+} mobilization by periodic activation of SK channels. The Ca^{2+} signaling properties of gonadotrophs are not preserved in $\alpha\text{T3-1}$ and $\text{L}\beta\text{T3}$

cells, indicating their limited use in the characterization of Ca^{2+} -dependent cellular processes. Corticotrophs are likely to have both plasma membrane- and ER-dependent oscillators operative, but further work is needed to clarify the mechanisms controlling these oscillators. Finally, the characterization of Ca^{2+} signaling pathways in thyrotrophs still is in a preliminary stage.

Acknowledgments

Address all correspondence and requests for reprints to: Dr. Stanko Stojilkovic, National Institute of Child Health and Human Development, Building 49, Room 6A-36, 49 Convent Drive, Bethesda, Maryland 20892-4510. E-mail: stankos@helix.nih.gov and stojilks@mail.nih.gov.

J.T. and R.B. were supported by National Institutes of Health (NIH) Grants DA19356 and DK43200. S.S.S. was supported by an NIH grant from the Intramural Research Program of the National Institute of Child Health and Human Development.

Disclosure Summary: The authors have nothing to declare.

References

1. **Kidokoro Y** 1975 Spontaneous calcium action potentials in a clonal pituitary cell line and their relationship to prolactin secretion. *Nature* 258:741–742
2. **Stojilkovic SS** 2008 Ion channels, transporters, and electrical signaling. In: Coon PM, ed. *Neuroscience in medicine*. Totowa, NJ: Humana Press
3. **Douglas WW** 1968 Stimulus-secretion coupling: the concept and clues from chromaffin and other cells. *Br J Pharmacol* 34:451–474
4. **Denef C** 2008 Paracrinicity: the story of 30 years of cellular pituitary crosstalk. *J Neuroendocrinol* 20:1–70
5. **Fletcher WH, Anderson Jr NC, Everett JW** 1975 Intercellular communication in the rat anterior pituitary gland. An in vivo and in vitro study. *J Cell Biol* 67:469–476
6. **Stojilkovic SS, Catt KJ** 1992 Calcium oscillations in anterior pituitary cells. *Endocr Rev* 13:256–280
7. **Ozawa S, Sand O** 1986 Electrophysiology of excitable endocrine cells. *Physiol Rev* 66:887–952
8. **Kwicien R, Hammond C** 1998 Differential management of Ca^{2+} oscillations by anterior pituitary cells: a comparative overview. *Neuroendocrinology* 68:135–151
9. **Stojilkovic SS** 1996 Special section on calcium signaling in pituitary cells. *Trends Endocrinol Metab* 7:357–360
10. **Tuomisto J, Männistö P** 1985 Neurotransmitter regulation of anterior pituitary hormones. *Pharmacol Rev* 37:249–332
11. **Drouin J** 2006 Molecular mechanisms of pituitary differentiation and regulation: implications for hormone deficiencies and hormone resistance syndromes. *Front Horm Res* 35:74–87
12. **Kelberman D, Rizzoti K, Lovell-Badge R, Robinson IC, Dattani MT** 2009 Genetic regulation of pituitary gland development in human and mouse. *Endocr Rev* 30:790–829
13. **Zhu X, Gleiberman AS, Rosenfeld MG** 2007 Molecular

- physiology of pituitary development: signaling and transcriptional networks. *Physiol Rev* 87:933–963
14. Savage JJ, Yaden BC, Kiratipranon P, Rhodes SJ 2003 Transcriptional control during mammalian anterior pituitary development. *Gene* 319:1–19
 15. Fiordelisis T, Millán-Aldaco D, Hernández-Cruz A 2006 Cells of proopiomelanocortin lineage from the rodent anterior pituitary lack sexually dimorphic expression of neurofilaments. *Neuroendocrinology* 83:360–370
 16. Fiordelisis T, Hernández-Cruz A 2002 Oestrogen regulates neurofilament expression in a subset of anterior pituitary cells of the adult female rat. *J Neuroendocrinol* 14:411–424
 17. Raffin-Sanson ML, de Keyser Y, Bertagna X 2003 Proopiomelanocortin, a polypeptide precursor with multiple functions: from physiology to pathological conditions. *Eur J Endocrinol* 149:79–90
 18. Jenks BG 2009 Regulation of proopiomelanocortin gene expression: an overview of the signaling cascades, transcription factors, and responsive elements involved. *Ann NY Acad Sci* 1163:17–30
 19. Aguilera G, Nikodemova M, Wynn PC, Catt KJ 2004 Corticotropin releasing hormone receptors: two decades later. *Peptides* 25:319–329
 20. McNicol AM, Carbajo-Perez E 1999 Aspects of anterior pituitary growth, with special reference to corticotrophs. *Pituitary* 1:257–268
 21. Ooi GT, Tawadros N, Escalona RM 2004 Pituitary cell lines and their endocrine applications. *Mol Cell Endocrinol* 228:1–21
 22. Gomora JC, Avila G, Cota G 1996 Ca²⁺ current expression in pituitary melanotrophs of neonatal rats and its regulation by D2 dopamine receptors. *J Physiol* 492:763–773
 23. Shibuya I, Kongsamut S, Douglas WW 1992 Effectiveness of GABAB antagonists in inhibiting baclofen-induced reductions in cytosolic free Ca concentration in isolated melanotrophs of rat. *Br J Pharmacol* 105:893–898
 24. Nagata T, Harayama N, Sasaki N, Inoue M, Tanaka K, Toyohira Y, Uezono Y, Maruyama T, Yanagihara N, Ueta Y, Shibuya I 2003 Mechanisms of cytosolic Ca²⁺ suppression by prostaglandin E2 receptors in rat melanotrophs. *J Neuroendocrinol* 15:33–41
 25. Ciranna L, Feltz P, Schlichter R 1996 Selective inhibition of high voltage-activated L-type and Q-type Ca²⁺ currents by serotonin in rat melanotrophs. *J Physiol* 490:595–609
 26. Vazquez-Martinez R, Castaño JP, Tonon MC, Vaudry H, Gracia-Navarro F, Malagon MM 2003 Melanotrope secretory cycle is regulated by physiological inputs via the hypothalamus. *Am J Physiol Endocrinol Metab* 285:E1039–E1046
 27. Garnier M, Lamacz M, Galas L, Lenglet S, Tonon MC, Vaudry H 1998 Pharmacological and functional characterization of muscarinic receptors in the frog pars intermedia. *Endocrinology* 139:3525–3533
 28. Jégou S, El Yacoubi M, Mounien L, Ledent C, Parmentier M, Costentin J, Vaugeois JM, Vaudry H 2003 Adenosine A2A receptor gene disruption provokes marked changes in melanocortin content and pro-opiomelanocortin gene expression. *J Neuroendocrinol* 15:1171–1177
 29. Hnasko R, Khurana S, Shackelford N, Steinmetz R, Low MJ, Ben-Jonathan N 1997 Two distinct pituitary cell lines from mouse intermediate lobe tumors: a cell that produces prolactin-regulating factor and a melanotroph. *Endocrinology* 138:5589–5596
 30. Szkudlinski MW, Fremont V, Ronin C, Weintraub BD 2002 Thyroid-stimulating hormone and thyroid-stimulating hormone receptor structure-function relationships. *Physiol Rev* 82:473–502
 31. Pazos-Moura CC, Ortiga-Carvalho TM, Gaspar de Moura E 2003 The autocrine/paracrine regulation of thyrotropin secretion. *Thyroid* 13:167–175
 32. Stojilkovic SS, Krsmanovic LZ, Spergel DJ, Catt KJ 1994 Gonadotropin-releasing hormone neurons: intrinsic pulsatility and receptor-mediated regulation. *Trends Endocrinol Metab* 5:201–209
 33. Stojilkovic SS, Reinhart J, Catt KJ 1994 Gonadotropin-releasing hormone receptors: structure and signal transduction pathways. *Endocr Rev* 15:462–499
 34. Ciccone NA, Xu S, Lacza CT, Carroll RS, Kaiser UB 2010 Frequency-dependent regulation of FSH β by pulsatile GnRH is mediated by functional antagonism of bZIP transcription factors. *Mol Cell Biol* 30:1028–1040
 35. Kaiser UB, Sabbagh E, Chen MT, Chin WW, Saunders BD 1998 Sp1 binds to the rat luteinizing hormone β (LH β) gene promoter and mediates gonadotropin-releasing hormone-stimulated expression of the LH β subunit gene. *J Biol Chem* 273:12943–12951
 36. Rawlings SR 1996 Pituitary adenylate cyclase-activating polypeptide regulates [Ca(2+)](i) and electrical activity in pituitary cells through cell type-specific mechanisms. *Trends Endocrinol Metab* 7:374–378
 37. Stojilkovic SS, Balla T, Fukuda S, Cesnjaj M, Merelli F, Krsmanovic LZ, Catt KJ 1992 Endothelin ETA receptors mediate the signaling and secretory actions of endothelins in pituitary gonadotrophs. *Endocrinology* 130:465–474
 38. Orcel H, Tobin VA, Alonso G, Rabić A 2002 Immunocytochemical localization of vasopressin v1a receptors in the rat pituitary gonadotrophs. *Endocrinology* 143:4385–4388
 39. Hidalgo-Diaz C, Castaño JP, López-Pedraza R, Malagón MM, García-Navarro S, Gracia-Navarro F 1998 A modulatory role for substance P on the regulation of luteinizing hormone secretion by cultured porcine gonadotrophs. *Biol Reprod* 58:678–685
 40. Bilezikjian LM, Blount AL, Leal AM, Donaldson CJ, Fischer WH, Vale WW 2004 Autocrine/paracrine regulation of pituitary function by activin, inhibin and follistatin. *Mol Cell Endocrinol* 225:29–36
 41. Ciccone NA, Kaiser UB 2009 The biology of gonadotroph regulation. *Curr Opin Endocrinol Diabetes Obes* 16:321–327
 42. Thomas P, Mellon PL, Turgeon J, Waring DW 1996 The L β T2 clonal gonadotrope: a model for single cell studies of endocrine cell secretion. *Endocrinology* 137:2979–2989
 43. Windle JJ, Weiner RI, Mellon PL 1990 Cell lines of the pituitary gonadotrope lineage derived by targeted oncogenesis in transgenic mice. *Mol Endocrinol* 4:597–603
 44. DeAlmeida VI, Mayo KE 2001 The growth hormone-releasing hormone receptor. *Vitam Horm* 63:233–276
 45. Patel YC, Greenwood M, Panetta R, Hukovic N, Grigorakis S, Robertson LA, Srikant CB 1996 Molecular biology of somatostatin receptor subtypes. *Metabolism* 45:31–38
 46. Muccioli G, Baragli A, Granata R, Papotti M, Ghigo E 2007 Heterogeneity of ghrelin/growth hormone secretagogue receptors. Toward the understanding of the molec-

- ular identity of novel ghrelin/GHS receptors. *Neuroendocrinology* 86:147–164
47. Rawlings SR, Hezareh M 1996 Pituitary adenylate cyclase-activating polypeptide (PACAP) and PACAP/vasoactive intestinal polypeptide receptors: actions on the anterior pituitary gland. *Endocr Rev* 17:4–29
 48. Tomic M, Zivadinovic D, Van Goor F, Yuan D, Koshimizu T, Stojilkovic SS 1999 Expression of Ca(2+)-mobilizing endothelin(A) receptors and their role in the control of Ca(2+) influx and growth hormone secretion in pituitary somatotrophs. *J Neurosci* 19:7721–7731
 49. Christian HC, Chapman LP, Morris JF 2007 Thyrotrophin-releasing hormone, vasoactive intestinal peptide, prolactin-releasing peptide and dopamine regulation of prolactin secretion by different lactotroph morphological subtypes in the rat. *J Neuroendocrinol* 19:605–613
 50. Kukstas LA, Verrier D, Zhang J, Chen C, Israel JM, Vincent JD 1990 Evidence for a relationship between lactotroph heterogeneity and physiological context. *Neurosci Lett* 120:84–86
 51. Ben-Jonathan N, Hnasko R 2001 Dopamine as a prolactin (PRL) inhibitor. *Endocr Rev* 22:724–763
 52. Kanyicska B, Burris TP, Freeman ME 1991 Endothelin-3 inhibits prolactin and stimulates LH, FSH and TSH secretion from pituitary cell culture. *Biochem Biophys Res Commun* 174:338–343
 53. Samson WK, Skala KD, Alexander BD, Huang FL 1990 Pituitary site of action of endothelin: selective inhibition of prolactin release in vitro. *Biochem Biophys Res Commun* 169:737–743
 54. Freeman ME, Kanyicska B, Lerant A, Nagy G 2000 Prolactin: structure, function, and regulation of secretion. *Physiol Rev* 80:1523–1631
 55. Sam S, Frohman LA 2008 Normal physiology of hypothalamic pituitary regulation. *Endocrinol Metab Clin North Am* 37:1–22, vii
 56. Fauquier T, Lacampagne A, Travo P, Bauer K, Mollard P 2002 Hidden face of the anterior pituitary. *Trends Endocrinol Metab* 13:304–309
 57. Allaerts W, Carmeliet P, Denef C 1990 New perspectives in the function of pituitary folliculo-stellate cells. *Mol Cell Endocrinol* 71:73–81
 58. Hatton GI 1988 Pituitary cells, glia and control of terminal secretion. *J Exp Biol* 139:67–79
 59. Hussy N 2002 Glial cells in the hypothalamo-neurohypophysial system: key elements of the regulation of neuronal electrical and secretory activity. *Prog Brain Res* 139:95–112
 60. Hatton GI 1999 Astroglial modulation of neurotransmitter/peptide release from the neurohypophysis: present status. *J Chem Neuroanat* 16:203–221
 61. Yu FH, Yarov-Yarovoy V, Gutman GA, Catterall WA 2005 Overview of molecular relationships in the voltage-gated ion channel superfamily. *Pharmacol Rev* 57:387–395
 62. Dai S, Hall DD, Hell JW 2009 Supramolecular assemblies and localized regulation of voltage-gated ion channels. *Physiol Rev* 89:411–452
 63. Catterall WA, Goldin AL, Waxman SG 2005 International Union of Pharmacology. XLVII. Nomenclature and structure-function relationships of voltage-gated sodium channels. *Pharmacol Rev* 57:397–409
 64. Kehl SJ 1994 Voltage-clamp analysis of the voltage-gated sodium current of the rat pituitary melanotroph. *Neurosci Lett* 165:67–70
 65. Schwab Y, Jahke R, Jover E 2004 Expression of tetrodotoxin-sensitive and resistant sodium channels by rat melanotrophs. *Neuroreport* 15:1219–1223
 66. Valentijn JA, Valentijn K 1997 Two distinct Na⁺ currents control cytosolic Ca²⁺ pulsing in *Xenopus laevis* pituitary melanotrophs. *Cell Calcium* 21:241–251
 67. Galas L, Garnier M, Lamacz M 2000 Calcium waves in frog melanotrophs are generated by intracellular inactivation of TTX-sensitive membrane Na⁺ channel. *Mol Cell Endocrinol* 170:197–209
 68. Marchetti C, Childs GV, Brown AM 1987 Membrane currents of identified isolated rat corticotropes and gonadotropes. *Am J Physiol* 252:E340–E346
 69. Tse A, Hille B 1993 Role of voltage-gated Na⁺ and Ca²⁺ channels in gonadotropin-releasing hormone-induced membrane potential changes in identified rat gonadotropes. *Endocrinology* 132:1475–1481
 70. Van Goor F, Zivadinovic D, Stojilkovic SS 2001 Differential expression of ionic channels in rat anterior pituitary cells. *Mol Endocrinol* 15:1222–1236
 71. Waring DW, Turgeon JL 2006 Estradiol inhibition of voltage-activated and gonadotropin-releasing hormone-induced currents in mouse gonadotropes. *Endocrinology* 147:5798–5805
 72. Heyward PM, Chen C, Clarke IJ 1995 Inward membrane currents and electrophysiological responses to GnRH in ovine gonadotropes. *Neuroendocrinology* 61:609–621
 73. Mason WT, Sikdar SK 1988 Characterization of voltage-gated sodium channels in ovine gonadotropes: relationship to hormone secretion. *J Physiol* 399:493–517
 74. Price CJ, Goldberg JI, Chang JP 1993 Voltage-activated ionic currents in goldfish pituitary cells. *Gen Comp Endocrinol* 92:16–30
 75. Van Goor F, Goldberg JI, Chang JP 1996 Electrical membrane properties and ionic currents in cultured goldfish gonadotropes. *Can J Physiol Pharmacol* 74:729–743
 76. Bosma MM, Hille B 1992 Electrophysiological properties of a cell line of the gonadotrope lineage. *Endocrinology* 130:3411–3420
 77. Tiwari JK, Sikdar SK 1998 Voltage gated Na⁺ channels contribute to membrane voltage fluctuation in α T3-1 pituitary gonadotroph cells. *Neurosci Lett* 242:167–171
 78. Wen S, Schwarz JR, Niculescu D, Dinu C, Bauer CK, Hirdes W, Boehm U 2008 Functional characterization of genetically labeled gonadotropes. *Endocrinology* 149:2701–2711
 79. Horta J, Hiriart M, Cota G 1991 Differential expression of Na channels in functional subpopulations of rat lactotropes. *Am J Physiol* 261:C865–C871
 80. Sankaranarayanan S, Simasko SM 1996 A role for a background sodium current in spontaneous action potentials and secretion from rat lactotropes. *Am J Physiol* 271:C1927–C1934
 81. Avila G, Monjaraz E, Espinosa JL, Cota G 2003 Down-regulation of voltage-gated sodium channels by dexamethasone in clonal rat pituitary cells. *Neurosci Lett* 339:21–24
 82. Xu SH, Cooke IM 2007 Voltage-gated currents of tilapia prolactin cells. *Gen Comp Endocrinol* 150:219–232
 83. Armstrong CM, Cota G 1990 Modification of sodium channel gating by lanthanum. Some effects that cannot be

- explained by surface charge theory. *J Gen Physiol* 96:1129–1140
84. Rosen AD 2001 Nonlinear temperature modulation of sodium channel kinetics in GH(3) cells. *Biochim Biophys Acta* 1511:391–396
 85. Vega AV, Espinosa JL, López-Domínguez AM, López-Santiago LF, Navarrete A, Cota G 2003 L-type calcium channel activation up-regulates the mRNAs for two different sodium channel α subunits (Nav1.2 and Nav1.3) in rat pituitary GH3 cells. *Brain Res Mol Brain Res* 116:115–125
 86. Morinville A, Fundin B, Meury L, Juréus A, Sandberg K, Krupp J, Ahmad S, O'Donnell D 2007 Distribution of the voltage-gated sodium channel Na(v)1.7 in the rat: expression in the autonomic and endocrine systems. *J Comp Neurol* 504:680–689
 87. Yang SK, Wang K, Parkington H, Chen C 2008 Involvement of tetrodotoxin-resistant Na⁺ current and protein kinase C in the action of growth hormone (GH)-releasing hormone on primary cultured somatotropes from GH-green fluorescent protein transgenic mice. *Endocrinology* 149:4726–4735
 88. Dominguez B, Felix R, Monjaraz E 2009 Upregulation of voltage-gated Na⁺ channels by long-term activation of the ghrelin-growth hormone secretagogue receptor in clonal GC somatotropes. *Am J Physiol Endocrinol Metab* 296:E1148–E1156
 89. Catterall WA 2000 Structure and regulation of voltage-gated Ca²⁺ channels. *Annu Rev Cell Dev Biol* 16:521–555
 90. McCobb DP, Beam KG 1991 Action potential waveform voltage-clamp commands reveal striking differences in calcium entry via low and high voltage-activated calcium channels. *Neuron* 7:119–127
 91. Perez-Reyes E 2003 Molecular physiology of low-voltage-activated t-type calcium channels. *Physiol Rev* 83:117–161
 92. Stutzin A, Stojilkovic SS, Catt KJ, Rojas E 1989 Characteristics of two types of calcium channels in rat pituitary gonadotrophs. *Am J Physiol* 257:C865–C874
 93. Mason WT, Sikdar SK 1989 Characteristics of voltage-gated Ca²⁺ currents in ovine gonadotrophs. *J Physiol* 415:367–391
 94. Lewis DL, Goodman MB, St John PA, Barker JL 1988 Calcium currents and fura-2 signals in fluorescence-activated cell sorted lactotrophs and somatotrophs of rat anterior pituitary. *Endocrinology* 123:611–621
 95. Glassmeier G, Hauber M, Wulfsen I, Weinsberg F, Bauer CK, Schwarz JR 2001 Ca²⁺ channels in clonal rat anterior pituitary cells (GH3/B6). *Pflugers Arch* 442:577–587
 96. Kwiecien R, Robert C, Cannon R, Vignes S, Arnoux A, Kordon C, Hammond C 1998 Endogenous pacemaker activity of rat tumour somatotrophs. *J Physiol* 508:883–905
 97. Simasko SM, Weiland GA, Oswald RE 1988 Pharmacological characterization of two calcium currents in GH3 cells. *Am J Physiol* 254:E328–E336
 98. Kunze DL, Ritchie AK 1990 Multiple conductance levels of the dihydropyridine-sensitive calcium channel in GH3 cells. *J Membr Biol* 118:171–178
 99. Ritchie AK 1993 Estrogen increases low voltage-activated calcium current density in GH3 anterior pituitary cells. *Endocrinology* 132:1621–1629
 100. Israel JM, Kukstas LA, Vincent JD 1990 Plateau potentials recorded from lactating rat enriched lactotroph cells are triggered by thyrotropin releasing hormone and shortened by dopamine. *Neuroendocrinology* 51:113–122
 101. Sedej S, Tsujimoto T, Zorec R, Rupnik M 2004 Voltage-activated Ca(2+) channels and their role in the endocrine function of the pituitary gland in newborn and adult mice. *J Physiol* 555:769–782
 102. Keja JA, Stoof JC, Kits KS 1991 Voltage-activated currents through calcium channels in rat pituitary melanotrophic cells. *Neuroendocrinology* 53:349–359
 103. Tanaka K, Shibuya I, Kabashima N, Ueta Y, Yamashita H 1998 Inhibition of voltage-dependent calcium channels by prostaglandin E2 in rat melanotrophs. *Endocrinology* 139:4801–4810
 104. Kuryshev YA, Childs GV, Ritchie AK 1995 Three high threshold calcium channel subtypes in rat corticotropes. *Endocrinology* 136:3916–3924
 105. Mudado MA, Rodrigues AL, Prado VF, Beirão PS, Cruz JS 2004 CaV 3.1 and CaV 3.3 account for T-type Ca²⁺ current in GH3 cells. *Braz J Med Biol Res* 37:929–935
 106. Fiordelisio T, Jiménez N, Baba S, Shiba K, Hernández-Cruz A 2007 Immunoreactivity to neurofilaments in the rodent anterior pituitary is associated with the expression of α 1A protein subunits of voltage-gated Ca²⁺ channels. *J Neuroendocrinol* 19:870–881
 107. Qin N, Yagel S, Momplaisir ML, Codd EE, D'Andrea MR 2002 Molecular cloning and characterization of the human voltage-gated calcium channel $\alpha(2)\delta$ -4 subunit. *Mol Pharmacol* 62:485–496
 108. Wang D, Yan B, Rajapaksha WR, Fisher TE 2009 The expression of voltage-gated Ca²⁺ channels in pituitary cells and the up-regulation of L-type Ca²⁺ channels during water deprivation. *J Neuroendocrinol* 21:858–866
 109. Dominguez B, Avila T, Flores-Hernandez J, Lopez-Lopez G, Martinez-Rodriguez H, Felix R, Monjaraz E 2008 Up-regulation of high voltage-activated Ca(2+) channels in GC somatotropes after long-term exposure to ghrelin and growth hormone releasing peptide-6. *Cell Mol Neurobiol* 28:819–831
 110. Avelino-Cruz JE, Flores A, Cebada J, Mellon PL, Felix R, Monjaraz E 2009 Leptin increases L-type Ca²⁺ channel expression and GnRH-stimulated LH release in β BT2 gonadotrophs. *Mol Cell Endocrinol* 298:57–65
 111. Qiu J, Bosch MA, Jamali K, Xue C, Kelly MJ, Rønnekleiv OK 2006 Estrogen upregulates T-type calcium channels in the hypothalamus and pituitary. *J Neurosci* 26:11072–11082
 112. Bosch MA, Hou J, Fang Y, Kelly MJ, Rønnekleiv OK 2009 17 β -estradiol regulation of the mRNA expression of T-type calcium channel subunits: role of estrogen receptor α and estrogen receptor β . *J Comp Neurol* 512:347–358
 113. Stanfield PR, Nakajima S, Nakajima Y 2002 Constitutively active and G-protein coupled inward rectifier K⁺ channels: Kir2.0 and Kir3.0. *Rev Physiol Biochem Pharmacol* 145:47–179
 114. Einhorn LC, Gregerson KA, Oxford GS 1991 D2 dopamine receptor activation of potassium channels in identified rat lactotrophs: whole-cell and single-channel recording. *J Neurosci* 11:3727–3737
 115. Tomic M, Van Goor F, He ML, Zivadinovic D, Stojilkovic SS 2002 Ca(2+)-mobilizing endothelin-A receptors inhibit voltage-gated Ca(2+) influx through G(i/o) signaling pathway in pituitary lactotrophs. *Mol Pharmacol* 61:1329–1339

116. Sims SM, Lussier BT, Kraicer J 1991 Somatostatin activates an inwardly rectifying K⁺ conductance in freshly dispersed rat somatotrophs. *J Physiol* 441:615–637
117. Thomas P, Smith PA 2001 Tetrabutylammonium: a selective blocker of the somatostatin-activated hyperpolarizing current in mouse AtT-20 corticotrophs. *Pflugers Arch* 441: 816–823
118. Kuzhikandathil EV, Yu W, Oxford GS 1998 Human dopamine D3 and D2L receptors couple to inward rectifier potassium channels in mammalian cell lines. *Mol Cell Neurosci* 12:390–402
119. Kozasa T, Kaziro Y, Ohtsuka T, Grigg JJ, Nakajima S, Nakajima Y 1996 G protein specificity of the muscarine-induced increase in an inward rectifier potassium current in AtT-20 cells. *Neurosci Res* 26:289–297
120. Tallent M, Dichter MA, Reisine T 1996 Evidence that a novel somatostatin receptor couples to an inward rectifier potassium current in AtT-20 cells. *Neuroscience* 73:855–864
121. Takano K, Yasufuku-Takano J, Kozasa T, Nakajima S, Nakajima Y 1997 Different G proteins mediate somatostatin-induced inward rectifier K⁺ currents in murine brain and endocrine cells. *J Physiol* 502:559–567
122. Takano K, Yasufuku-Takano J, Teramoto A, Fujita T 1997 Gi3 mediates somatostatin-induced activation of an inwardly rectifying K⁺ current in human growth hormone-secreting adenoma cells. *Endocrinology* 138: 2405–2409
123. Gregerson KA, Flagg TP, O'Neill TJ, Anderson M, Luring O, Horel JS, Welling PA 2001 Identification of G protein-coupled, inward rectifier potassium channel gene products from the rat anterior pituitary gland. *Endocrinology* 142:2820–2832
124. Wulfsen I, Hauber HP, Schiemann D, Bauer CK, Schwarz JR 2000 Expression of mRNA for voltage-dependent and inward-rectifying K channels in GH3/B6 cells and rat pituitary. *J Neuroendocrinol* 12:263–272
125. Charles AC, Piros ET, Evans CJ, Hales TG 1999 L-type Ca²⁺ channels and K⁺ channels specifically modulate the frequency and amplitude of spontaneous Ca²⁺ oscillations and have distinct roles in prolactin release in GH3 cells. *J Biol Chem* 274:7508–7515
126. Barros F, Villalobos C, García-Sancho J, del Camino D, de la Peña P 1994 The role of the inwardly rectifying K⁺ current in resting potential and thyrotropin-releasing-hormone-induced changes in cell excitability of GH3 rat anterior pituitary cells. *Pflugers Arch* 426:221–230
127. Barros F, del Camino D, Pardo LA, Palomero T, Giráldez T, de la Peña P 1997 Demonstration of an inwardly rectifying K⁺ current component modulated by thyrotropin-releasing hormone and caffeine in GH3 rat anterior pituitary cells. *Pflugers Arch* 435:119–129
128. Corrette BJ, Bauer CK, Schwarz JR 1996 An inactivating inward-rectifying K current present in prolactin cells from the pituitary of lactating rats. *J Membr Biol* 150:185–195
129. Xu R, Zhao Y, Chen C 2002 Growth hormone-releasing peptide-2 reduces inward rectifying K⁺ currents via a PKA-cAMP-mediated signalling pathway in ovine somatotrophs. *J Physiol* 545:421–433
130. Inagaki N, Tsuura Y, Namba N, Masuda K, Gono T, Horie M, Seino Y, Mizuta M, Seino S 1995 Cloning and functional characterization of a novel ATP-sensitive potassium channel ubiquitously expressed in rat tissues, including pancreatic islets, pituitary, skeletal muscle, and heart. *J Biol Chem* 270:5691–5694
131. Hille B 2001 Ion channels of excitable cells. Sunderland, MA: Sinauer Associates, Inc.
132. Schwarz JR, Bauer CK 2004 Functions of erg K⁺ channels in excitable cells. *J Cell Mol Med* 8:22–30
133. Gutman GA, Chandy KG, Grissmer S, Lazdunski M, McKinnon D, Pardo LA, Robertson GA, Rudy B, Sanguinetti MC, Stühmer W, Wang X 2005 International Union of Pharmacology. LIII. Nomenclature and molecular relationships of voltage-gated potassium channels. *Pharmacol Rev* 57:473–508
134. Maffie J, Rudy B 2008 Weighing the evidence for a ternary protein complex mediating A-type K⁺ currents in neurons. *J Physiol* 586:5609–5623
135. Haitin Y, Attali B 2008 The C-terminus of Kv7 channels: a multifunctional module. *J Physiol* 586:1803–1810
136. Levitan ES, Gealy R, Trimmer JS, Takimoto K 1995 Membrane depolarization inhibits Kv1.5 voltage-gated K⁺ channel gene transcription and protein expression in pituitary cells. *J Biol Chem* 270:6036–6041
137. Attardi B, Takimoto K, Gealy R, Severns C, Levitan ES 1993 Glucocorticoid induced up-regulation of a pituitary K⁺ channel mRNA in vitro and in vivo. *Receptors Channels* 1:287–293
138. Takimoto K, Fomina AF, Gealy R, Trimmer JS, Levitan ES 1993 Dexamethasone rapidly induces Kv1.5 K⁺ channel gene transcription and expression in clonal pituitary cells. *Neuron* 11:359–369
139. Zhang TT, Gealy R, Lu X, Heasley LE, Takimoto K, Levitan ES 2000 TRH regulates Kv1.5 gene expression through a Gαq-mediated PLC-independent pathway. *Mol Cell Endocrinol* 165:33–39
140. Chen BS, Lo YC, Peng H, Hsu TI, Wu SN 2009 Effects of ranolazine, a novel anti-anginal drug, on ion currents and membrane potential in pituitary tumor GH(3) cells and NG108-15 neuronal cells. *J Pharmacol Sci* 110:295–305
141. Wang YJ, Lin MW, Lin AA, Peng H, Wu SN 2008 Evidence for state-dependent block of DPI 201–106, a synthetic inhibitor of Na⁺ channel inactivation, on delayed-rectifier K⁺ current in pituitary tumor (GH3) cells. *J Physiol Pharmacol* 59:409–423
142. Simasko SM 1991 Evidence for a delayed rectifier-like potassium current in the clonal rat pituitary cell line GH3. *Am J Physiol* 261:E66–E75
143. Xu R, Clarke IJ, Chen S, Chen C 2000 Growth hormone-releasing hormone decreases voltage-gated potassium currents in GH4C1 cells. *J Neuroendocrinol* 12:147–157
144. Herrington J, Lingle CJ 1994 Multiple components of voltage-dependent potassium current in normal rat anterior pituitary cells. *J Neurophysiol* 72:719–729
145. Chen C, Zhang J, Vincent JD, Israel JM 1990 Somatostatin increases voltage-dependent potassium currents in rat somatotrophs. *Am J Physiol* 259:C854–C861
146. Lingle CJ, Sombati S, Freeman ME 1986 Membrane currents in identified lactotrophs of rat anterior pituitary. *J Neurosci* 6:2995–3005
147. Cowley MA, Chen C, Clarke IJ 1999 Estrogen transiently increases delayed rectifier, voltage-dependent potassium currents in ovine gonadotropes. *Neuroendocrinology* 69: 254–260

148. Haug TM, Hodne K, Weltzien FA, Sand O 2007 Electrophysiological properties of pituitary cells in primary culture from Atlantic cod (*Gadus morhua*). *Neuroendocrinology* 86:38–47
149. Sankaranarayanan S, Simasko SM 1998 Potassium channel blockers have minimal effect on repolarization of spontaneous action potentials in rat pituitary lactotrophs. *Neuroendocrinology* 68:297–311
150. Mei YA, Soriani O, Castel H, Vaudry H, Cazin L 1998 Adenosine potentiates the delayed-rectifier potassium conductance but has no effect on the hyperpolarization-activated Ih current in frog melanotrophs. *Brain Res* 793:271–278
151. Mei YA, Louiset E, Vaudry H, Cazin L 1995 A-type potassium current modulated by A1 adenosine receptor in frog melanotrophs. *J Physiol* 489:431–442
152. Chen C, Heyward P, Zhang J, Wu D, Clarke IJ 1994 Voltage-dependent potassium currents in ovine somatotrophs and their function in growth hormone secretion. *Neuroendocrinology* 59:1–9
153. Sankaranarayanan S, Simasko SM 1996 Characterization of an M-like current modulated by thyrotropin-releasing hormone in normal rat lactotrophs. *J Neurosci* 16:1668–1678
154. Meves H, Schwarz JR, Wulfsen I 1999 Separation of M-like current and ERG current in NG108-15 cells. *Br J Pharmacol* 127:1213–1223
155. Schäfer R, Wulfsen I, Behrens S, Weinsberg F, Bauer CK, Schwarz JR 1999 The erg-like potassium current in rat lactotrophs. *J Physiol* 518:401–416
156. Bauer CK, Schäfer R, Schiemann D, Reid G, Hanganu I, Schwarz JR 1999 A functional role of the erg-like inward-rectifying K⁺ current in prolactin secretion from rat lactotrophs. *Mol Cell Endocrinol* 148:37–45
157. Tomic M, Andric SA, Stojilkovic SS 2003 Dependence of prolactin release on coupling between Ca(2+) mobilization and voltage-gated Ca(2+) influx pathways in rat lactotrophs. *Endocrine* 20:45–52
158. Bauer CK 1998 The erg inwardly rectifying K⁺ current and its modulation by thyrotrophin-releasing hormone in giant clonal rat anterior pituitary cells. *J Physiol* 510:63–70
159. Schledermann W, Wulfsen I, Schwarz JR, Bauer CK 2001 Modulation of rat erg1, erg2, erg3 and HERG K⁺ currents by thyrotropin-releasing hormone in anterior pituitary cells via the native signal cascade. *J Physiol* 532:143–163
160. Lecchi M, Redaelli E, Rosati B, Gurrola G, Florio T, Crociani O, Curia G, Cassulini RR, Masi A, Arcangeli A, Olivotto M, Schettini G, Possani LD, Wanke E 2002 Isolation of a long-lasting eag-related gene-type K⁺ current in MMQ lactotrophs and its accommodating role during slow firing and prolactin release. *J Neurosci* 22:3414–3425
161. Hirdes W, Dinu C, Bauer CK, Boehm U, Schwarz JR 2010 Gonadotropin-releasing hormone inhibits ether-a-go-go-related gene K⁺ currents in mouse gonadotropes. *Endocrinology* 151:1079–1088
162. Bauer CK, Wulfsen I, Schäfer R, Glassmeier G, Wimmers S, Flitsch J, Lüdecke DK, Schwarz JR 2003 HERG K(+) currents in human prolactin-secreting adenoma cells. *Pflugers Arch* 445:589–600
163. Pedarzani P, Stocker M 2008 Molecular and cellular basis of small- and intermediate-conductance, calcium-activated potassium channel function in the brain. *Cell Mol Life Sci* 65:3196–3217
164. Fakler B, Adelman JP 2008 Control of K(Ca) channels by calcium nano/microdomains. *Neuron* 59:873–881
165. Wei AD, Gutman GA, Aldrich R, Chandy KG, Grissmer S, Wulff H 2005 International Union of Pharmacology. LII. Nomenclature and molecular relationships of calcium-activated potassium channels. *Pharmacol Rev* 57:463–472
166. Hou S, Heinemann SH, Hoshi T 2009 Modulation of BKCa channel gating by endogenous signaling molecules. *Physiology (Bethesda)* 24:26–35
167. Chatterjee O, Taylor LA, Ahmed S, Nagaraj S, Hall JJ, Finckbeiner SM, Chan PS, Suda N, King JT, Zeeman ML, McCobb DP 2009 Social stress alters expression of large conductance calcium-activated potassium channel subunits in mouse adrenal medulla and pituitary glands. *J Neuroendocrinol* 21:167–176
168. Bond CT, Maylie J, Adelman JP 2005 SK channels in excitability, pacemaking and synaptic integration. *Curr Opin Neurobiol* 15:305–311
169. Lang DG, Ritchie AK 1990 Tetraethylammonium blockade of apamin-sensitive and insensitive Ca2(+)-activated K⁺ channels in a pituitary cell line. *J Physiol* 425:117–132
170. Ritchie AK 1987 Two distinct calcium-activated potassium currents in a rat anterior pituitary cell line. *J Physiol* 385:591–609
171. Mørk HK, Haug TM, Sand O 2005 Contribution of different Ca-activated K channels to the first phase of the response to TRH in clonal rat anterior pituitary cells. *Acta Physiol Scand* 184:141–150
172. Kukuljan M, Stojilkovic SS, Rojas E, Catt KJ 1992 Apamin-sensitive potassium channels mediate agonist-induced oscillations of membrane potential in pituitary gonadotrophs. *FEBS Lett* 301:19–22
173. Tse A, Hille B 1992 GnRH-induced Ca2+ oscillations and rhythmic hyperpolarizations of pituitary gonadotropes. *Science* 255:462–464
174. Waring DW, Turgeon JL 2009 Ca2+-activated K⁺ channels in gonadotropin-releasing hormone-stimulated mouse gonadotrophs. *Endocrinology* 150:2264–2272
175. Tse A, Tse FW, Hille B 1995 Modulation of Ca2+ oscillation and apamin-sensitive, Ca2+-activated K⁺ current in rat gonadotropes. *Pflugers Arch* 430:645–652
176. Tse A, Lee AK 1998 Arginine vasopressin triggers intracellular calcium release, a calcium-activated potassium current and exocytosis in identified rat corticotropes. *Endocrinology* 139:2246–2252
177. Vergara L, Rojas E, Stojilkovic SS 1997 A novel calcium-activated apamin-insensitive potassium current in pituitary gonadotrophs. *Endocrinology* 138:2658–2664
178. Korn SJ, Bolden A, Horn R 1991 Control of action potentials and Ca2+ influx by the Ca(2+)-dependent chloride current in mouse pituitary cells. *J Physiol* 439:423–437
179. Sartor P, Dufy-Barbe L, Vacher P, Dufy B 1992 Calcium-activated chloride conductance of lactotrophs: comparison of activation in normal and tumoral cells during thyrotropin-releasing-hormone stimulation. *J Membr Biol* 126:39–49
180. Stojilkovic SS, Zemkova H, Van Goor F 2005 Biophysical

- basis of pituitary cell type-specific Ca²⁺ signaling-secretion coupling. *Trends Endocrinol Metab* 16:152–159
181. Van Goor F, Krsmanovic LZ, Catt KJ, Stojilkovic SS 1999 Coordinate regulation of gonadotropin-releasing hormone neuronal firing patterns by cytosolic calcium and store depletion. *Proc Natl Acad Sci USA* 96:4101–4106
 182. Kehl SJ, Wong K 1996 Large-conductance calcium-activated potassium channels of cultured rat melanotrophs. *J Membr Biol* 150:219–230
 183. Kanyicska B, Freeman ME, Dryer SE 1997 Endothelin activates large-conductance K⁺ channels in rat lactotrophs: reversal by long-term exposure to dopamine agonist. *Endocrinology* 138:3141–3153
 184. Van Goor F, Zivadinovic D, Martinez-Fuentes AJ, Stojilkovic SS 2001 Dependence of pituitary hormone secretion on the pattern of spontaneous voltage-gated calcium influx. Cell type-specific action potential secretion coupling. *J Biol Chem* 276:33840–33846
 185. Van Goor F, Li YX, Stojilkovic SS 2001 Paradoxical role of large-conductance calcium-activated K⁺ (BK) channels in controlling action potential-driven Ca²⁺ entry in anterior pituitary cells. *J Neurosci* 21:5902–5915
 186. Holl RW, Thorner MO, Mandell GL, Sullivan JA, Sinha YN, Leong DA 1988 Spontaneous oscillations of intracellular calcium and growth hormone secretion. *J Biol Chem* 263:9682–9685
 187. Vacher P, Vacher AM, Mollard P 1998 Tubocurarine blocks a calcium-dependent potassium current in rat tumoral pituitary cells. *Mol Cell Endocrinol* 139:131–142
 188. Shipston MJ, Kelly JS, Antoni FA 1996 Glucocorticoids block protein kinase A inhibition of calcium-activated potassium channels. *J Biol Chem* 271:9197–9200
 189. Lang DG, Ritchie AK 1990 Tetraethylammonium ion sensitivity of a 35-pS CA2(+)-activated K⁺ channel in GH3 cells that is activated by thyrotropin-releasing hormone. *Pflugers Arch* 416:704–709
 190. Shipston MJ, Armstrong DL 1996 Activation of protein kinase C inhibits calcium-activated potassium channels in rat pituitary tumour cells. *J Physiol* 493:665–672
 191. Sitdikova GF, Weiger TM, Hermann A 2010 Hydrogen sulfide increases calcium-activated potassium (BK) channel activity of rat pituitary tumor cells. *Pflugers Arch* 459:389–397
 192. Wu SN, Peng H, Chen BS, Wang YJ, Wu PY, Lin MW 2008 Potent activation of large-conductance Ca²⁺-activated K⁺ channels by the diphenylurea 1,3-bis-[2-hydroxy-5-(trifluoromethyl)phenyl]urea (NS1643) in pituitary tumor (GH3) cells. *Mol Pharmacol* 74:1696–1704
 193. Wu SN, Wang YJ, Lin MW 2007 Potent stimulation of large-conductance Ca²⁺-activated K⁺ channels by rottlerin, an inhibitor of protein kinase C- δ , in pituitary tumor (GH3) cells and in cortical neuronal (HCN-1A) cells. *J Cell Physiol* 210:655–666
 194. Shipston MJ, Duncan RR, Clark AG, Antoni FA, Tian L 1999 Molecular components of large conductance calcium-activated potassium (BK) channels in mouse pituitary corticotropes. *Mol Endocrinol* 13:1728–1737
 195. Huang MH, So EC, Liu YC, Wu SN 2006 Glucocorticoids stimulate the activity of large-conductance Ca²⁺-activated K⁺ channels in pituitary GH3 and AtT-20 cells via a non-genomic mechanism. *Steroids* 71:129–140
 196. Tian L, Philp JA, Shipston MJ 1999 Glucocorticoid block of protein kinase C signalling in mouse pituitary corticotroph AtT20 D16:16 cells. *J Physiol* 516:757–768
 197. Tian L, Knaus HG, Shipston MJ 1998 Glucocorticoid regulation of calcium-activated potassium channels mediated by serine/threonine protein phosphatase. *J Biol Chem* 273:13531–13536
 198. Tian L, Duncan RR, Hammond MS, Coghill LS, Wen H, Rusinova R, Clark AG, Levitan IB, Shipston MJ 2001 Alternative splicing switches potassium channel sensitivity to protein phosphorylation. *J Biol Chem* 276:7717–7720
 199. Tian L, Hammond MS, Florance H, Antoni FA, Shipston MJ 2001 Alternative splicing determines sensitivity of murine calcium-activated potassium channels to glucocorticoids. *J Physiol* 537:57–68
 200. Lai GJ, McCobb DP 2006 Regulation of alternative splicing of Slo K⁺ channels in adrenal and pituitary during the stress-hyporesponsive period of rat development. *Endocrinology* 147:3961–3967
 201. Lai GJ, McCobb DP 2002 Opposing actions of adrenal androgens and glucocorticoids on alternative splicing of Slo potassium channels in bovine chromaffin cells. *Proc Natl Acad Sci USA* 99:7722–7727
 202. Xie J, McCobb DP 1998 Control of alternative splicing of potassium channels by stress hormones. *Science* 280:443–446
 203. McCobb DP, Hara Y, Lai GJ, Mahmoud SF, Flügge G 2003 Subordination stress alters alternative splicing of the Slo gene in tree shrew adrenals. *Horm Behav* 43:180–186
 204. Brunton PJ, Sausbier M, Wietzorrek G, Sausbier U, Knaus HG, Russell JA, Ruth P, Shipston MJ 2007 Hypothalamic-pituitary-adrenal axis hyporesponsiveness to restraint stress in mice deficient for large-conductance calcium- and voltage-activated potassium (BK) channels. *Endocrinology* 148:5496–5506
 205. Mahmoud SF, McCobb DP 2004 Regulation of Slo potassium channel alternative splicing in the pituitary by gonadal testosterone. *J Neuroendocrinol* 16:237–243
 206. King JT, Lovell PV, Rishniw M, Kotlikoff MI, Zeeman ML, McCobb DP 2006 β 2 And β 4 subunits of BK channels confer differential sensitivity to acute modulation by steroid hormones. *J Neurophysiol* 95:2878–2888
 207. Craven KB, Zagotta WN 2006 CNG and HCN channels: two peas, one pod. *Annu Rev Physiol* 68:375–401
 208. Robinson RB, Siegelbaum SA 2003 Hyperpolarization-activated cation currents: from molecules to physiological function. *Annu Rev Physiol* 65:453–480
 209. Tian L, Shipston MJ 2000 Characterization of hyperpolarization-activated cation currents in mouse anterior pituitary, AtT20 D16:16 corticotropes. *Endocrinology* 141:2930–2937
 210. Kretschmannova K, Gonzalez-Iglesias AE, Tomiæ M, Stojilkovic SS 2006 Dependence of hyperpolarisation-activated cyclic nucleotide-gated channel activity on basal cyclic adenosine monophosphate production in spontaneously firing GH3 cells. *J Neuroendocrinol* 18:484–493
 211. Simasko SM, Sankaranarayanan S 1997 Characterization of a hyperpolarization-activated cation current in rat pituitary cells. *Am J Physiol* 272:E405–E414
 212. Gonzalez-Iglesias AE, Kretschmannova K, Tomic M, Stojilkovic SS 2006 ZD7288 inhibits exocytosis in an HCN-independent manner and downstream of voltage-

- gated calcium influx in pituitary lactotrophs. *Biochem Biophys Res Commun* 346:845–850
213. Liu YC, Wang YJ, Wu PY, Wu SN 2009 Tramadol-induced block of hyperpolarization-activated cation current in rat pituitary lactotrophs. *Naunyn Schmiedebergs Arch Pharmacol* 379:127–135
 214. Tomiæ M, Koshimizu T, Yuan D, Andric SA, Zivadinovic D, Stojilkovic SS 1999 Characterization of a plasma membrane calcium oscillator in rat pituitary somatotrophs. *J Biol Chem* 274:35693–35702
 215. Ding C, Potter ED, Qiu W, Coon SL, Levine MA, Guggino SE 1997 Cloning and widespread distribution of the rat rod-type cyclic nucleotide-gated cation channel. *Am J Physiol* 272:C1335–C1344
 216. Khan S, Perry C, Tetreault ML, Henry D, Trimmer JS, Zimmerman AL, Matthews G 2010 A novel cyclic nucleotide-gated ion channel enriched in synaptic terminals of isotocin neurons in zebrafish brain and pituitary. *Neuroscience* 165:79–89
 217. Andric SA, Gonzalez-Iglesias AE, Van Goor F, Tomic M, Stojilkovic SS 2003 Nitric oxide inhibits prolactin secretion in pituitary cells downstream of voltage-gated calcium influx. *Endocrinology* 144:2912–2921
 218. Gonzalez-Iglesias AE, Jiang Y, Tomic M, Kretschmannova K, Andric SA, Zemkova H, Stojilkovic SS 2006 Dependence of electrical activity and calcium influx-controlled prolactin release on adenylyl cyclase signaling pathway in pituitary lactotrophs. *Mol Endocrinol* 20:2231–2246
 219. Clapham DE, Julius D, Montell C, Schultz G 2005 International Union of Pharmacology. XLIX. Nomenclature and structure-function relationships of transient receptor potential channels. *Pharmacol Rev* 57:427–450
 220. Fonfria E, Murdock PR, Cusdin FS, Benham CD, Kelsell RE, McNulty S 2006 Tissue distribution profiles of the human TRPM cation channel family. *J Recept Signal Transduct Res* 26:159–178
 221. Yamashita M, Oki Y, Iino K, Hayashi C, Yogo K, Matsushita F, Sasaki S, Nakamura H 2009 The role of store-operated Ca²⁺ channels in adrenocorticotropin release by rat pituitary cells. *Regul Pept* 156:57–64
 222. Riccio A, Mattei C, Kelsell RE, Medhurst AD, Calver AR, Randall AD, Davis JB, Benham CD, Pangalos MN 2002 Cloning and functional expression of human short TRP7, a candidate protein for store-operated Ca²⁺ influx. *J Biol Chem* 277:12302–12309
 223. Wu SN, Li HF, Jan CR 1998 Regulation of Ca²⁺-activated nonselective cationic currents in rat pituitary GH3 cells: involvement in L-type Ca²⁺ current. *Brain Res* 812:133–141
 224. Kucka M, Kretschmannova K, Murano T, Wu CP, Zemkova H, Ambudkar SV, Stojilkovic SS 2010 Dependence of multidrug resistance protein-mediated cyclic nucleotide efflux on the background sodium conductance. *Mol Pharmacol* 77:270–279
 225. Jentsch TJ, Stein V, Weinreich F, Zdebik AA 2002 Molecular structure and physiological function of chloride channels. *Physiol Rev* 82:503–568
 226. Griffon N, Jeanneteau F, Prieur F, Diaz J, Sokoloff P 2003 CLIC6, a member of the intracellular chloride channel family, interacts with dopamine D(2)-like receptors. *Brain Res Mol Brain Res* 117:47–57
 227. Rogawski MA, Inoue K, Suzuki S, Barker JL 1988 A slow calcium-dependent chloride conductance in clonal anterior pituitary cells. *J Neurophysiol* 59:1854–1870
 228. Sartor P, Dufy-Barbe L, Corcuff JB, Taupignon A, Dufy B 1990 Electrophysiological response to thyrotropin-releasing hormone of rat lactotrophs in primary culture. *Am J Physiol* 258:E311–E319
 229. Fahmi M, Garcia L, Taupignon A, Dufy B, Sartor P 1995 Recording of a large-conductance chloride channel in normal rat lactotrophs. *Am J Physiol* 269:E969–E976
 230. Jakab M, Schmidt S, Grundbichler M, Paulmichl M, Hermann A, Weiger T, Ritter M 2006 Hypotonicity and ethanol modulate BK channel activity and chloride currents in GH4/C1 pituitary tumour cells. *Acta Physiol (Oxf)* 187:51–59
 231. Garcia L, Fahmi M, Prevarskaya N, Dufy B, Sartor P 1997 Modulation of voltage-dependent Ca²⁺ conductance by changing Cl[−] concentration in rat lactotrophs. *Am J Physiol* 272:C1178–C1185
 232. Sartor P, Garcia L, Madec F, Dufy-Barbe L, Rigoulet M, Dufy B 2004 Regulation of intracellular chloride concentration in rat lactotrope cells and its relation to the membrane resting potential. *Gen Physiol Biophys* 23:173–193
 233. Heisler S 1991 Chloride channel blockers inhibit ACTH secretion from mouse pituitary tumor cells. *Am J Physiol* 260:E505–E512
 234. Day RN, Hinkle PM 1988 Osmotic regulation of prolactin secretion. Possible role of chloride. *J Biol Chem* 263:15915–15921
 235. Rupnik M, Zorec R 1992 Cytosolic chloride ions stimulate Ca(2+)-induced exocytosis in melanotrophs. *FEBS Lett* 303:221–223
 236. Turner JE, Sedej S, Rupnik M 2005 Cytosolic Cl[−] ions in the regulation of secretory and endocytotic activity in melanotrophs from mouse pituitary tissue slices. *J Physiol* 566:443–453
 237. Garcia L, Couderc B, Odessa MF, Dufy-Barbe L, Sartor P 1999 Effects of Cl(−) substitution on electrophysiological properties, Ca(2+) influx and prolactin secretion of rat lactotrophs in vitro. *Neuroendocrinology* 70:332–342
 238. Berridge MJ, Lipp P, Bootman MD 2000 The versatility and universality of calcium signalling. *Nat Rev Mol Cell Biol* 1:11–21
 239. Iino M 1999 Dynamic regulation of intracellular calcium signals through calcium release channels. *Mol Cell Biochem* 190:185–190
 240. Foskett JK, White C, Cheung KH, Mak DO 2007 Inositol trisphosphate receptor Ca²⁺ release channels. *Physiol Rev* 87:593–658
 241. Stojilkovic SS, Iida T, Merelli F, Torsello A, Krsmanovic LZ, Catt KJ 1991 Interactions between calcium and protein kinase C in the control of signaling and secretion in pituitary gonadotrophs. *J Biol Chem* 266:10377–10384
 242. Ashworth R, Hinkle PM 1996 Thyrotropin-releasing hormone-induced intracellular calcium responses in individual rat lactotrophs and thyrotrophs. *Endocrinology* 137:5205–5212
 243. Zingg HH 1996 Vasopressin and oxytocin receptors. *Baillieres Clin Endocrinol Metab* 10:75–96
 244. Suárez C, Tornadú IG, Cristina C, Vela J, Iglesias AG, Libertun C, Díaz-Torga G, Becu-Villalobos D 2002 Angiotensin and calcium signaling in the pituitary and hypothalamus. *Cell Mol Neurobiol* 22:315–333

245. Stojilkovic SS, Merelli F, Iida T, Krsmanovic LZ, Catt KJ 1990 Endothelin stimulation of cytosolic calcium and gonadotropin secretion in anterior pituitary cells. *Science* 248:1663–1666
246. Belmeguenai A, Desrues L, Leprince J, Vaudry H, Tonon MC, Louiset E 2003 Neurotensin stimulates both calcium mobilization from inositol trisphosphate-sensitive intracellular stores and calcium influx through membrane channels in frog pituitary melanotrophs. *Endocrinology* 144:5556–5567
247. Chen ZP, Kratzmeier M, Levy A, McArdle CA, Poch A, Day A, Mukhopadhyay AK, Lightman SL 1995 Evidence for a role of pituitary ATP receptors in the regulation of pituitary function. *Proc Natl Acad Sci USA* 92:5219–5223
248. Guillemette G, Balla T, Baukal AJ, Catt KJ 1987 Inositol 1,4,5-trisphosphate binds to a specific receptor and releases microsomal calcium in the anterior pituitary gland. *Proc Natl Acad Sci USA* 84:8195–8199
249. Stojilkovic SS, Kukuljan M, Tomic M, Rojas E, Catt KJ 1993 Mechanism of agonist-induced $[Ca^{2+}]_i$ oscillations in pituitary gonadotrophs. *J Biol Chem* 268:7713–7720
250. Vergara LA, Stojilkovic SS, Rojas E 1995 GnRH-induced cytosolic calcium oscillations in pituitary gonadotrophs: phase resetting by membrane depolarization. *Biophys J* 69:1606–1614
251. Stojilkovic SS, Tomic M, Kukuljan M, Catt KJ 1994 Control of calcium spiking frequency in pituitary gonadotrophs by a single-pool cytoplasmic oscillator. *Mol Pharmacol* 45:1013–1021
252. Li YX, Rinzel J, Keizer J, Stojilkovic SS 1994 Calcium oscillations in pituitary gonadotrophs: comparison of experiment and theory. *Proc Natl Acad Sci USA* 91:58–62
253. Tomic M, Cesnajak M, Catt KJ, Stojilkovic SS 1994 Developmental and physiological aspects of Ca^{2+} signaling in agonist-stimulated pituitary gonadotrophs. *Endocrinology* 135:1762–1771
254. Stojilkovic SS, Tomic M, Koshimizu T-A, Van Goor F 2000 Calcium ions as intracellular messengers. In: Conn PM, Means AR, eds. *Principles of molecular regulation*. Totowa, NJ: Humana Press Inc.; 149–185
255. Merelli F, Stojilkovic SS, Iida T, Krsmanovic LZ, Zheng L, Mellon PL, Catt KJ 1992 Gonadotropin-releasing hormone-induced calcium signaling in clonal pituitary gonadotrophs. *Endocrinology* 131:925–932
256. Zemkova H, Balik A, Kretschmannova K, Mazna P, Stojilkovic SS 2004 Recovery of Ins(1,4,5)-trisphosphate-dependent calcium signaling in neonatal gonadotrophs. *Cell Calcium* 36:89–97
257. Willars GB, Royall JE, Nahorski SR, El-Gehani F, Everest H, McArdle CA 2001 Rapid down-regulation of the type I inositol 1,4,5-trisphosphate receptor and desensitization of gonadotropin-releasing hormone-mediated Ca^{2+} responses in $\alpha T3-1$ gonadotropes. *J Biol Chem* 276:3123–3129
258. McArdle CA, Willars GB, Fowkes RC, Nahorski SR, Davidson JS, Forrest-Owen W 1996 Desensitization of gonadotropin-releasing hormone action in $\alpha T3-1$ cells due to uncoupling of inositol 1,4,5-trisphosphate generation and Ca^{2+} mobilization. *J Biol Chem* 271:23711–23717
259. Wojcikiewicz RJ, Xu Q, Webster JM, Alzayady K, Gao C 2003 Ubiquitination and proteasomal degradation of endogenous and exogenous inositol 1,4,5-trisphosphate receptors in $\alpha T3-1$ anterior pituitary cells. *J Biol Chem* 278:940–947
260. Alzayady KJ, Wojcikiewicz RJ 2005 The role of Ca^{2+} in triggering inositol 1,4,5-trisphosphate receptor ubiquitination. *Biochem J* 392:601–606
261. Endo M 2009 Calcium-induced calcium release in skeletal muscle. *Physiol Rev* 89:1153–1176
262. Zucchi R, Ronca-Testoni S 1997 The sarcoplasmic reticulum Ca^{2+} channel/ryanodine receptor: modulation by endogenous effectors, drugs and disease states. *Pharmacol Rev* 49:1–51
263. Johnson JD, Chang JP 2002 Agonist-specific and sexual stage-dependent inhibition of gonadotropin-releasing hormone-stimulated gonadotropin and growth hormone release by ryanodine: relationship to sexual stage-dependent caffeine-sensitive hormone release. *J Neuroendocrinol* 14:144–155
264. Seale AP, Cooke IM, Hirano T, Grau GE 2004 Evidence that IP3 and ryanodine-sensitive intra-cellular Ca^{2+} stores are not involved in acute hyposmotically-induced prolactin release in tilapia. *Cell Physiol Biochem* 14:155–166
265. Yamamori E, Iwasaki Y, Oki Y, Yoshida M, Asai M, Kambayashii M, Oiso Y, Nakashima N 2004 Possible involvement of ryanodine receptor-mediated intracellular calcium release in the effect of corticotropin-releasing factor on adrenocorticotropin secretion. *Endocrinology* 145:36–38
266. Soares SM, Thompson M, Chini EN 2005 Role of the second-messenger cyclic-adenosine 5'-diphosphate-ribose on adrenocorticotropin secretion from pituitary cells. *Endocrinology* 146:2186–2192
267. Kramer RH, Mokkapatti R, Levitan ES 1994 Effects of caffeine on intracellular calcium, calcium current and calcium-dependent potassium current in anterior pituitary GH3 cells. *Pflugers Arch* 426:12–20
268. Sundaresan S, Weiss J, Bauer-Dantoin AC, Jameson JL 1997 Expression of ryanodine receptors in the pituitary gland: evidence for a role in gonadotropin-releasing hormone signaling. *Endocrinology* 138:2056–2065
269. Kukuljan M, Rojas E, Catt KJ, Stojilkovic SS 1994 Membrane potential regulates inositol 1,4,5-trisphosphate-controlled cytoplasmic Ca^{2+} oscillations in pituitary gonadotrophs. *J Biol Chem* 269:4860–4865
270. Zimmer MP, Simasko SM 2000 Recruitment of calcium from intracellular stores does not occur during the expression of large spontaneous calcium oscillations in GH(3) cells and lactotropic cells in primary culture. *Neuroendocrinology* 72:242–251
271. Putney JW 2009 Capacitative calcium entry: from concept to molecules. *Immunol Rev* 231:10–22
272. Villalobos C, Garcia-Sancho J 1995 Capacitative Ca^{2+} entry contributes to the Ca^{2+} influx induced by thyrotropin-releasing hormone (TRH) in GH3 pituitary cells. *Pflugers Arch* 430:923–935
273. Kerper LE, Hinkle PM 1997 Lead uptake in brain capillary endothelial cells: activation by calcium store depletion. *Toxicol Appl Pharmacol* 146:127–133
274. Shen AY, Huang MH, Wang TS, Wu HM, Kang YF, Chen CL 2009 Thymol-evoked Ca^{2+} mobilization and ion currents in pituitary GH3 cells. *Nat Prod Commun* 4:749–752
275. Secondo A, Tagliatela M, Cataldi M, Giorgio G, Valore

- M, Di Renzo G, Annunziato L 2000 Pharmacological blockade of ERG K(+) channels and Ca(2+) influx through store-operated channels exerts opposite effects on intracellular Ca(2+) oscillations in pituitary GH(3) cells. *Mol Pharmacol* 58:1115–1128
276. Fagan KA, Graf RA, Tolman S, Schaack J, Cooper DM 2000 Regulation of a Ca²⁺-sensitive adenylyl cyclase in an excitable cell. Role of voltage-gated versus capacitative Ca²⁺ entry. *J Biol Chem* 275:40187–40194
277. Karhapää L, Titievsky A, Kaila K, Törnquist K 1996 Redox modulation of calcium entry and release of intracellular calcium by thimerosal in GH4C1 pituitary cells. *Cell Calcium* 20:447–457
278. Harper JL, Shin Y, Daly JW 1997 Loperamide: a positive modulator for store-operated calcium channels? *Proc Natl Acad Sci USA* 94:14912–14917
279. McArdle CA, Forrest-Owen W, Davidson JS, Fowkes R, Bunting R, Mason WT, Poch A, Kratzmeier M 1996 Ca²⁺ entry in gonadotrophs and α T3-1 cells: does store-dependent Ca²⁺ influx mediate gonadotrophin-releasing hormone action? *J Endocrinol* 149:155–169
280. Fowkes RC, Forrest-Owen W, Williams B, McArdle CA 1999 C-type natriuretic peptide (CNP) effects on intracellular calcium [Ca²⁺]_i in mouse gonadotrope-derived α T3-1 cell line. *Regul Pept* 84:43–49
281. Andric SA, Zivadinovic D, Gonzalez-Iglesias AE, Lachowicz A, Tomic M, Stojilkovic SS 2005 Endothelin-induced, long lasting, and Ca²⁺ influx-independent blockade of intrinsic secretion in pituitary cells by Gz subunits. *J Biol Chem* 280:26896–26903
282. Lachowicz A, Van Goor F, Katzur AC, Bonhomme G, Stojilkovic SS 1997 Uncoupling of calcium mobilization and entry pathways in endothelin-stimulated pituitary lactotrophs. *J Biol Chem* 272:28308–28314
283. Kukuljan M, Vergara L, Stojilkovic SS 1997 Modulation of the kinetics of inositol 1,4,5-trisphosphate-induced [Ca²⁺]_i oscillations by calcium entry in pituitary gonadotrophs. *Biophys J* 72:698–707
284. Le Foll F, Castel H, Soriani O, Vaudry H, Cazin L 1998 Gramicidin-perforated patch revealed depolarizing effect of GABA in cultured frog melanotrophs. *J Physiol* 507:55–69
285. Taraskevich PS, Douglas WW 1989 Effects of BAY K 8644 on Ca-channel currents and electrical activity in mouse melanotrophs. *Brain Res* 491:102–108
286. Trouslard J, Demeneix BA, Feltz P 1989 Spontaneous spiking activities of porcine pars intermedia cells: effects of thyrotropin-releasing hormone. *Neuroendocrinology* 50:33–43
287. Cobbett P, Ingram CD, Mason WT 1987 Sodium and potassium currents involved in action potential propagation in normal bovine lactotrophs. *J Physiol* 392:273–299
288. Bonnefont X, Mollard P 2003 Electrical activity in endocrine pituitary cells in situ: a support for a multiple-function coding. *FEBS Lett* 548:49–52
289. Stojilkovic SS, Kukuljan M, Iida T, Rojas E, Catt KJ 1992 Integration of cytoplasmic calcium and membrane potential oscillations maintains calcium signaling in pituitary gonadotrophs. *Proc Natl Acad Sci USA* 89:4081–4085
290. Chen C, Zhang J, Vincent JD, Israel JM 1990 Sodium and calcium currents in action potentials of rat somatotrophs: their possible functions in growth hormone secretion. *Life Sci* 46:983–989
291. Tsaneva-Atanasova K, Sherman A, van Goor F, Stojilkovic SS 2007 Mechanism of spontaneous and receptor-controlled electrical activity in pituitary somatotrophs: experiments and theory. *J Neurophysiol* 98:131–144
292. Stern JV, Osinga HM, LeBeau A, Sherman A 2008 Resetting behavior in a model of bursting in secretory pituitary cells: distinguishing plateaus from pseudo-plateaus. *Bull Math Biol* 70:68–88
293. Kuryshev YA, Childs GV, Ritchie AK 1996 Corticotropin-releasing hormone stimulates Ca²⁺ entry through L- and P-type Ca²⁺ channels in rat corticotropes. *Endocrinology* 137:2269–2277
294. Kuryshev YA, Haak L, Childs GV, Ritchie AK 1997 Corticotropin releasing hormone inhibits an inwardly rectifying potassium current in rat corticotropes. *J Physiol* 502:265–279
295. Beltran-Parral L, Charles A 2003 Riluzole inhibits spontaneous Ca²⁺ signaling in neuroendocrine cells by activation of K⁺ channels and inhibition of Na⁺ channels. *Br J Pharmacol* 140:881–888
296. Schlegel W, Winiger BP, Mollard P, Vacher P, Wuarin F, Zahnd GR, Wollheim CB, Dufy B 1987 Oscillations of cytosolic Ca²⁺ in pituitary cells due to action potentials. *Nature* 329:719–721
297. Simasko SM 1994 A background sodium conductance is necessary for spontaneous depolarizations in rat pituitary cell line GH3. *Am J Physiol* 266:C709–C719
298. Lu B, Su Y, Das S, Liu J, Xia J, Ren D 2007 The neuronal channel NALCN contributes resting sodium permeability and is required for normal respiratory rhythm. *Cell* 129:371–383
299. Kostic TS, Tomic M, Andric SA, Stojilkovic SS 2002 Calcium-independent and cAMP-dependent modulation of soluble guanylyl cyclase activity by G protein-coupled receptors in pituitary cells. *J Biol Chem* 277:16412–16418
300. Cukierman S 1996 Regulation of voltage-dependent sodium channels. *J Membr Biol* 151:203–214
301. Kato M, Hattori MA, Suzuki M 1988 Inhibition by extracellular Na⁺ replacement of GRF-induced GH secretion from rat pituitary cells. *Am J Physiol* 254:E476–E481
302. Naumov AP, Herrington J, Hille B 1994 Actions of growth-hormone-releasing hormone on rat pituitary cells: intracellular calcium and ionic currents. *Pflugers Arch* 427:414–421
303. Kato M, Sakuma Y 1999 The effect of GHRP-6 on the intracellular Na⁺ concentration of rat pituitary cells in primary culture. *J Neuroendocrinol* 11:795–800
304. Herrington J, Hille B 1994 Growth hormone-releasing hexapeptide elevates intracellular calcium in rat somatotropes by two mechanisms. *Endocrinology* 135:1100–1108
305. Frère SG, Kuisle M, Lüthi A 2004 Regulation of recombinant and native hyperpolarization-activated cation channels. *Mol Neurobiol* 30:279–305
306. DiFrancesco D, Tortora P 1991 Direct activation of cardiac pacemaker channels by intracellular cyclic AMP. *Nature* 351:145–147
307. Li YX, Rinzel J, Vergara L, Stojilkovic SS 1995 Spontaneous electrical and calcium oscillations in unstimulated pituitary gonadotrophs. *Biophys J* 69:785–795
308. Mollard P, Theler JM, Guérineau N, Vacher P, Chiavaroli

- C, Schlegel W 1994 Cytosolic Ca²⁺ of excitable pituitary cells at resting potentials is controlled by steady state Ca²⁺ currents sensitive to dihydropyridines. *J Biol Chem* 269: 25158–25164
309. Murakami Y, Tanaka J, Koshimura K, Kato Y 1998 Involvement of tetrodotoxin-sensitive sodium channels in rat growth hormone secretion induced by pituitary adenylate cyclase-activating polypeptide (PACAP). *Regul Pept* 73: 119–121
310. Van Goor F, LeBeau AP, Krsmanovic LZ, Sherman A, Catt KJ, Stojilkovic SS 2000 Amplitude-dependent spike-broadening and enhanced Ca²⁺ signaling in GnRH-secreting neurons. *Biophys J* 79:1310–1323
311. Van Goor F, Krsmanovic LZ, Catt KJ, Stojilkovic SS 1999 Control of action potential-driven calcium influx in GT1 neurons by the activation status of sodium and calcium channels. *Mol Endocrinol* 13:587–603
312. Miranda P, de la Peña P, Gómez-Varela D, Barros F 2003 Role of BK potassium channels shaping action potentials and the associated [Ca²⁺]_i oscillations in GH(3) rat anterior pituitary cells. *Neuroendocrinology* 77:162–176
313. Tabak J, Toporikova N, Freeman ME, Bertram R 2007 Low dose of dopamine may stimulate prolactin secretion by increasing fast potassium currents. *J Comput Neurosci* 22:211–222
314. Zhang XF, Gopalakrishnan M, Shieh CC 2003 Modulation of action potential firing by iberiotoxin and NS1619 in rat dorsal root ganglion neurons. *Neuroscience* 122: 1003–1011
315. Faber ES, Sah P 2003 Ca²⁺-activated K⁺ (BK) channel inactivation contributes to spike broadening during repetitive firing in the rat lateral amygdala. *J Physiol* 552:483–497
316. Sun L, Xiong Y, Zeng X, Wu Y, Pan N, Lingle CJ, Qu A, Ding J 2009 Differential regulation of action potentials by inactivating and noninactivating BK channels in rat adrenal chromaffin cells. *Biophys J* 97:1832–1842
317. Roper P, Callaway J, Shevchenko T, Teruyama R, Armstrong W 2003 AHP's, HAP's and DAP's: how potassium currents regulate the excitability of rat supraoptic neurones. *J Comput Neurosci* 15:367–389
318. Sun XP, Yazejian B, Grinnell AD 2004 Electrophysiological properties of BK channels in *Xenopus* motor nerve terminals. *J Physiol* 557:207–228
319. Mollard P, Schlegel W 1996 Why are endocrine pituitary cells excitable? *Trends Endocrinol Metab* 7:361–365
320. Guérineau N, Corcuff JB, Tabarin A, Mollard P 1991 Spontaneous and corticotropin-releasing factor-induced cytosolic calcium transients in corticotrophs. *Endocrinology* 129:409–420
321. Hirono M, Takamura K, Ito Y, Nakano Y, Chikaoka Y, Suzuki N, Yoshioka T 1999 Role of Ca²⁺-ATPase in spontaneous oscillations of cytosolic free Ca²⁺ in GH3 rat pituitary cells. *Cell Calcium* 25:125–135
322. Fiekers JF, Konopka LM 1996 Spontaneous transients of [Ca²⁺]_i depend on external calcium and the activation of L-type voltage-gated calcium channels in a clonal pituitary cell line (AtT-20) of cultured mouse corticotropes. *Cell Calcium* 19:327–336
323. Wagner KA, Yacono PW, Golan DE, Tashjian Jr AH 1993 Mechanism of spontaneous intracellular calcium fluctuations in single GH4C1 rat pituitary cells. *Biochem J* 292: 175–182
324. Bonnefont X, Fiekers J, Creff A, Mollard P 2000 Rhythmic bursts of calcium transients in acute anterior pituitary slices. *Endocrinology* 141:868–875
325. Lledo PM, Israel JM, Vincent JD 1991 Chronic stimulation of D2 dopamine receptors specifically inhibits calcium but not potassium currents in rat lactotrophs. *Brain Res* 558: 231–238
326. Ramírez JL, Torronteras R, Malagón MM, Castaño JP, García-Navarro S, González de Aguilar JL, Martínez-Fuentes AJ, Gracia-Navarro F 1998 Growth hormone-releasing factor mobilizes cytosolic free calcium through different mechanisms in two somatotrope subpopulations from porcine pituitary. *Cell Calcium* 23:207–217
327. Shibuya I, Douglas WW 1993 Spontaneous cytosolic calcium pulses in *Xenopus* melanotrophs are due to calcium influx during phasic increases in the calcium permeability of the cell membrane. *Endocrinology* 132:2176–2183
328. Shibuya I, Douglas WW 1993 Spontaneous cytosolic calcium pulsing detected in *Xenopus* melanotrophs: modulation by secretory-inhibitory and stimulant ligands. *Endocrinology* 132:2166–2175
329. Lieste JR, Koopman WJ, Reynen VC, Scheenen WJ, Jenks BG, Roubos EW 1998 Action currents generate stepwise intracellular Ca²⁺ patterns in a neuroendocrine cell. *J Biol Chem* 273:25686–25694
330. Scheenen WJ, Jenks BG, van Dinter RJ, Roubos EW 1996 Spatial and temporal aspects of Ca²⁺ oscillations in *Xenopus laevis* melanotrope cells. *Cell Calcium* 19:219–227
331. Jenks BG, Roubos EW, Scheenen WJ 2003 Ca²⁺ oscillations in melanotropes of *Xenopus laevis*: their generation, propagation, and function. *Gen Comp Endocrinol* 131: 209–219
332. Andric SA, Kostic TS, Stojilkovic SS 2006 Contribution of multidrug resistance protein MRP5 in control of cyclic guanosine 5'-monophosphate intracellular signaling in anterior pituitary cells. *Endocrinology* 147:3435–3445
333. Kostic TS, Andric SA, Stojilkovic SS 2004 Receptor-controlled phosphorylation of α 1 soluble guanylyl cyclase enhances nitric oxide-dependent cyclic guanosine 5'-monophosphate production in pituitary cells. *Mol Endocrinol* 18:458–470
334. Kostic TS, Andric SA, Stojilkovic SS 2001 Spontaneous and receptor-controlled soluble guanylyl cyclase activity in anterior pituitary cells. *Mol Endocrinol* 15:1010–1022
335. Andric SA, Kostic TS, Tomic M, Koshimizu T, Stojilkovic SS 2001 Dependence of soluble guanylyl cyclase activity on calcium signaling in pituitary cells. *J Biol Chem* 276:844–849
336. Conti M, Beavo J 2007 Biochemistry and physiology of cyclic nucleotide phosphodiesterases: essential components in cyclic nucleotide signaling. *Annu Rev Biochem* 76:481–511
337. Antoni FA, Barnard RJ, Shipston MJ, Smith SM, Simpson J, Paterson JM 1995 Calcineurin feedback inhibition of agonist-evoked cAMP formation. *J Biol Chem* 270: 28055–28061
338. Burgoyne RD, Morgan A 2003 Secretory granule exocytosis. *Physiol Rev* 83:581–632
339. Ponnambalam S, Baldwin SA 2003 Constitutive protein

- secretion from the trans-Golgi network to the plasma membrane. *Mol Membr Biol* 20:129–139
340. **Kits KS, Mansvelder HD** 2000 Regulation of exocytosis in neuroendocrine cells: spatial organization of channels and vesicles, stimulus-secretion coupling, calcium buffers and modulation. *Brain Res Brain Res Rev* 33:78–94
 341. **Stojilkovic SS** 2005 Ca²⁺-regulated exocytosis and SNARE function. *Trends Endocrinol Metab* 16:81–83
 342. **Zorec R** 1996 Calcium signaling and secretion in pituitary cells. *Trends Endocrinol Metab* 7:384–388
 343. **Zorec R, Sikdar SK, Mason WT** 1991 Increased cytosolic calcium stimulates exocytosis in bovine lactotrophs. Direct evidence from changes in membrane capacitance. *J Gen Physiol* 97:473–497
 344. **Douglas WW, Shibuya I** 1993 Calcium signals in melanotrophs and their relation to autonomous secretion and its modification by inhibitory and stimulatory ligands. *Ann NY Acad Sci* 680:229–245
 345. **Stojilkovic SS, Izumi S, Catt KJ** 1988 Participation of voltage-sensitive calcium channels in pituitary hormone release. *J Biol Chem* 263:13054–13061
 346. **Stanley EF** 1993 Single calcium channels and acetylcholine release at a presynaptic nerve terminal. *Neuron* 11:1007–1011
 347. **Mansvelder HD, Kits KS** 2000 All classes of calcium channel couple with equal efficiency to exocytosis in rat melanotrophs, inducing linear stimulus-secretion coupling. *J Physiol* 526:327–339
 348. **Zhou Z, Misler S** 1995 Action potential-induced quantal secretion of catecholamines from rat adrenal chromaffin cells. *J Biol Chem* 270:3498–3505
 349. **Stenovec M, Kreft M, Poberaj I, Betz WJ, Zorec R** 2004 Slow spontaneous secretion from single large dense-core vesicles monitored in neuroendocrine cells. *FASEB J* 18:1270–1272
 350. **Fauquier T, Guérineau NC, McKinney RA, Bauer K, Mollard P** 2001 Folliculostellate cell network: a route for long-distance communication in the anterior pituitary. *Proc Natl Acad Sci USA* 98:8891–8896
 351. **Soji T, Mabuchi Y, Kurono C, Herbert DC** 1997 Folliculostellate cells and intercellular communication within the rat anterior pituitary gland. *Microsc Res Tech* 39:138–149
 352. **Bonnefont X, Lacampagne A, Sanchez-Hormigo A, Fino E, Creff A, Mathieu MN, Smallwood S, Carmignac D, Fontanaud P, Travo P, Alonso G, Courtois-Coutry N, Pincus SM, Robinson IC, Mollard P** 2005 Revealing the large-scale network organization of growth hormone-secreting cells. *Proc Natl Acad Sci USA* 102:16880–16885
 353. **Chauvet N, El-Yandouzi T, Mathieu MN, Schlernitzauer A, Galibert E, Lafont C, Le Tissier P, Robinson IC, Mollard P, Coutry N** 2009 Characterization of adherens junction protein expression and localization in pituitary cell networks. *J Endocrinol* 202:375–387
 354. **Scemes E, Spray DC, Meda P** 2009 Connexins, pannexins, innexins: novel roles of “hemi-channels.” *Pflugers Arch* 457:1207–1226
 355. **Harris AL** 2007 Connexin channel permeability to cytoplasmic molecules. *Prog Biophys Mol Biol* 94:120–143
 356. **Cruciani V, Mikalsen SO** 2006 The vertebrate connexin family. *Cell Mol Life Sci* 63:1125–1140
 357. **Shirasawa N, Mabuchi Y, Sakuma E, Horiuchi O, Yashiro T, Kikuchi M, Hashimoto Y, Tsuruo Y, Herbert DC, Soji T** 2004 Intercellular communication within the rat anterior pituitary gland. X. Immunohistochemistry of S-100 and connexin 43 of folliculo-stellate cells in the rat anterior pituitary gland. *Anat Rec A Discov Mol Cell Evol Biol* 278:462–473
 358. **Stojilkovic SS** 2001 A novel view of the function of pituitary folliculo-stellate cell network. *Trends Endocrinol Metab* 12:378–380
 359. **Sato Y, Hashitani H, Shirasawa N, Sakuma E, Naito A, Suzuki H, Asai Y, Sato G, Wada I, Herbert DC, Soji T** 2005 Intercellular communications within the rat anterior pituitary. XII: Immunohistochemical and physiological evidences for the gap junctional coupling of the folliculo-stellate cells in the rat anterior pituitary. *Tissue Cell* 37:281–291
 360. **Meda P, Pepper MS, Traub O, Willecke K, Gros D, Beyer E, Nicholson B, Paul D, Orci L** 1993 Differential expression of gap junction connexins in endocrine and exocrine glands. *Endocrinology* 133:2371–2378
 361. **Yamamoto T, Hossain MZ, Hertzberg EL, Uemura H, Murphy LJ, Nagy JI** 1993 Connexin 43 in rat pituitary: localization at pituitary and stellate cell gap junctions and within gonadotrophs. *Histochemistry* 100:53–64
 362. **Vitale ML, Cardin J, Gilula NB, Carbajal ME, Pelletier RM** 2001 Dynamics of connexin 43 levels and distribution in the mink (*Mustela vison*) anterior pituitary are associated with seasonal changes in anterior pituitary prolactin content. *Biol Reprod* 64:625–633
 363. **Kabir N, Chaturvedi K, Liu LS, Sarkar DK** 2005 Transforming growth factor- β 3 increases gap-junctional communication among folliculostellate cells to release basic fibroblast growth factor. *Endocrinology* 146:4054–4060
 364. **Lewis BM, Pexa A, Francis K, Verma V, McNicol AM, Scanlon M, Deussen A, Evans WH, Rees DA, Ham J** 2006 Adenosine stimulates connexin 43 expression and gap junctional communication in pituitary folliculostellate cells. *FASEB J* 20:2585–2587
 365. **Fortin ME, Pelletier RM, Meilleur MA, Vitale ML** 2006 Modulation of GJA1 turnover and intercellular communication by proinflammatory cytokines in the anterior pituitary folliculostellate cell line TtT/GF. *Biol Reprod* 74:2–12
 366. **Meilleur MA, Akpovi CD, Pelletier RM, Vitale ML** 2007 Tumor necrosis factor- α -induced anterior pituitary folliculostellate TtT/GF cell uncoupling is mediated by connexin 43 dephosphorylation. *Endocrinology* 148:5913–5924
 367. **Horiguchi K, Fujiwara K, Kouki T, Kikuchi M, Yashiro T** 2008 Immunohistochemistry of connexin 43 throughout anterior pituitary gland in a transgenic rat with green fluorescent protein-expressing folliculo-stellate cells. *Anat Sci Int* 83:256–260
 368. **Levavi-Sivan B, Bloch CL, Gutnick MJ, Fleidervish IA** 2005 Electrotonic coupling in the anterior pituitary of a teleost fish. *Endocrinology* 146:1048–1052
 369. **Morand I, Fonlupt P, Guerrier A, Trouillas J, Calle A, Remy C, Rousset B, Munari-Silem Y** 1996 Cell-to-cell communication in the anterior pituitary: evidence for gap junction-mediated exchanges between endocrine cells and folliculostellate cells. *Endocrinology* 137:3356–3367
 370. **Guérineau NC, Bonnefont X, Stoekel L, Mollard P** 1998

- Synchronized spontaneous Ca²⁺ transients in acute anterior pituitary slices. *J Biol Chem* 273:10389–10395
371. Huang YJ, Maruyama Y, Dvoryanchikov G, Pereira E, Chaudhari N, Roper SD 2007 The role of pannexin 1 hemichannels in ATP release and cell-cell communication in mouse taste buds. *Proc Natl Acad Sci USA* 104:6436–6441
 372. Shestopalov VI, Panchin Y 2008 Pannexins and gap junction protein diversity. *Cell Mol Life Sci* 65:376–394
 373. Yen MR, Saier Jr MH 2007 Gap junctional proteins of animals: the innexin/pannexin superfamily. *Prog Biophys Mol Biol* 94:5–14
 374. Locovei S, Scemes E, Qiu F, Spray DC, Dahl G 2007 Pannexin1 is part of the pore forming unit of the P2X(7) receptor death complex. *FEBS Lett* 581:483–488
 375. Pelegrin P, Surprenant A 2006 Pannexin-1 mediates large pore formation and interleukin-1 β release by the ATP-gated P2X7 receptor. *EMBO J* 25:5071–5082
 376. Li S, Yan Z, Tomic M, Stojilkovic SS 2009 Expression of pannexin 1 isoforms in pituitary cells and their interactions with P2X channels. Society for Neuroscience Annual Meeting, Chicago, IL, Abstract #864
 377. Collingridge GL, Olsen R, Peters JA, Spedding M 2009 Ligand gated ion channels. *Neuropharmacology* 56:1
 378. Collingridge GL, Olsen RW, Peters J, Spedding M 2009 A nomenclature for ligand-gated ion channels. *Neuropharmacology* 56:2–5
 379. Connolly CN, Wafford KA 2004 The Cys-loop superfamily of ligand-gated ion channels: the impact of receptor structure on function. *Biochem Soc Trans* 32:529–534
 380. Mayer ML, Olson R, Gouaux E 2001 Mechanisms for ligand binding to GluR0 ion channels: crystal structures of the glutamate and serine complexes and a closed apo state. *J Mol Biol* 311:815–836
 381. Kawate T, Michel JC, Birdsong WT, Gouaux E 2009 Crystal structure of the ATP-gated P2X(4) ion channel in the closed state. *Nature* 460:592–598
 382. Caulfield MP, Birdsall NJ 1998 International Union of Pharmacology. XVII. Classification of muscarinic acetylcholine receptors. *Pharmacol Rev* 50:279–290
 383. Hogg RC, Ragenbass M, Bertrand D 2003 Nicotinic acetylcholine receptors: from structure to brain function. *Rev Physiol Biochem Pharmacol* 147:1–46
 384. Zouridakis M, Zisimopoulou P, Poulas K, Tzartos SJ 2009 Recent advances in understanding the structure of nicotinic acetylcholine receptors. *IUBMB Life* 61:407–423
 385. Van Strien FJ, Roubos EW, Vaudry H, Jenks BG 1996 Acetylcholine autoexcites the release of proopiomelanocortin-derived peptides from melanotrope cells of *Xenopus laevis* via an M1 muscarinic receptor. *Endocrinology* 137:4298–4307
 386. Lamacz M, Tonon MC, Louiset E, Cazin L, Strosberg D, Vaudry H 1989 Acetylcholine stimulates α -melanocyte-stimulating hormone release from frog pituitary melanotrophs through activation of muscarinic and nicotinic receptors. *Endocrinology* 125:707–714
 387. Louiset E, Cazin L, Duval O, Lamacz M, Tonon MC, Vaudry H 1990 Effect of acetylcholine on the electrical and secretory activities of frog pituitary melanotrophs. *Brain Res* 533:300–308
 388. Zhang ZW, Feltz P 1990 Nicotinic acetylcholine receptors in porcine hypophyseal intermediate lobe cells. *J Physiol* 422:83–101
 389. Poisbeau P, Trouslard J, Feltz P, Schlichter R 1994 Calcium influx through neuronal-type nicotinic acetylcholine receptors present on the neuroendocrine cells of the porcine pars intermedia. *Neuroendocrinology* 60:378–388
 390. Garnier M, Lamacz M, Tonon MC, Vaudry H 1994 Functional characterization of a nonclassical nicotine receptor associated with inositol phospholipid breakdown and mobilization of intracellular calcium pools. *Proc Natl Acad Sci USA* 91:11743–11747
 391. Vankelecom H, Deneff C 1997 Paracrine communication in the anterior pituitary as studied in reaggregate cell cultures. *Microsc Res Tech* 39:150–156
 392. Hoyer D, Clarke DE, Fozard JR, Hartig PR, Martin GR, Mylecharane EJ, Saxena PR, Humphrey PP 1994 International Union of Pharmacology classification of receptors for 5-hydroxytryptamine (serotonin). *Pharmacol Rev* 46:157–203
 393. Costall B, Naylor RJ 2004 5-HT₃ receptors. *Curr Drug Targets CNS Neurol Disord* 3:27–37
 394. Thompson AJ, Lummis SC 2006 5-HT₃ receptors. *Curr Pharm Des* 12:3615–3630
 395. Jørgensen HS 2007 Studies on the neuroendocrine role of serotonin. *Dan Med Bull* 54:266–288
 396. Popesku JT, Martyniuk CJ, Mennigen J, Xiong H, Zhang D, Xia X, Cossins AR, Trudeau VL 2008 The goldfish (*Carassius auratus*) as a model for neuroendocrine signaling. *Mol Cell Endocrinol* 293:43–56
 397. Quirk PL, Siegel RE 2005 The serotonin type 3A receptor facilitates luteinizing hormone release and LH β promoter activity in immortalized pituitary gonadotropes. *Endocrine* 27:37–43
 398. Dinan TG 1996 Serotonin and the regulation of hypothalamic-pituitary-adrenal axis function. *Life Sci* 58:1683–1694
 399. Calogero AE, Bagdy G, Burrello N, Polosa P, D'Agata R 1995 Role for serotonin 3 receptors in the control of adrenocorticotrophic hormone release from rat pituitary cell cultures. *Eur J Endocrinol* 133:251–254
 400. Calogero AE, Bagdy G, Moncada ML, D'Agata R 1993 Effect of selective serotonin agonists on basal, corticotrophin-releasing hormone- and vasopressin-induced ACTH release in vitro from rat pituitary cells. *J Endocrinol* 136:381–387
 401. Bettler B, Kaupmann K, Mosbacher J, Gassmann M 2004 Molecular structure and physiological functions of GABA(B) receptors. *Physiol Rev* 84:835–867
 402. Owens DF, Kriegstein AR 2002 Is there more to GABA than synaptic inhibition? *Nat Rev Neurosci* 3:715–727
 403. Sieghart W, Sperk G 2002 Subunit composition, distribution and function of GABA(A) receptor subtypes. *Curr Top Med Chem* 2:795–816
 404. Michels G, Moss SJ 2007 GABAA receptors: properties and trafficking. *Crit Rev Biochem Mol Biol* 42:3–14
 405. Johnston GA 2002 Medicinal chemistry and molecular pharmacology of GABA(C) receptors. *Curr Top Med Chem* 2:903–913
 406. Fiumelli H, Woodin MA 2007 Role of activity-dependent regulation of neuronal chloride homeostasis in development. *Curr Opin Neurobiol* 17:81–86
 407. Mercado A, Mount DB, Gamba G 2004 Electroneutral

- cation-chloride cotransporters in the central nervous system. *Neurochem Res* 29:17–25
408. **Anderson RA, Mitchell R** 1986 Distribution of GABA binding site subtypes in rat pituitary gland. *Brain Res* 365:78–84
 409. **Boue-Grabot E, Taupignon A, Tramu G, Garret M** 2000 Molecular and electrophysiological evidence for a GABA_A receptor in thyrotropin-secreting cells. *Endocrinology* 141:1627–1632
 410. **Nakayama Y, Hattori N, Otani H, Inagaki C** 2006 γ -Aminobutyric acid (GABA)-C receptor stimulation increases prolactin (PRL) secretion in cultured rat anterior pituitary cells. *Biochem Pharmacol* 71:1705–1710
 411. **Kuroda E, Watanabe M, Tamayama T, Shimada M** 2000 Autoradiographic distribution of radioactivity from (14)C-GABA in the mouse. *Microsc Res Tech* 48:116–126
 412. **Berman JA, Roberts JL, Pritchett DB** 1994 Molecular and pharmacological characterization of GABA_A receptors in the rat pituitary. *J Neurochem* 63:1948–1954
 413. **Valerio A, Tinti C, Spano P, Memo M** 1992 Rat pituitary cells selectively express mRNA encoding the short isoform of the γ 2 GABA_A receptor subunit. *Brain Res Mol Brain Res* 13:145–150
 414. **Zemkova HW, Bjelobaba I, Tomic M, Zemkova H, Stojilkovic SS** 2008 Molecular, pharmacological and functional properties of GABA_A receptors in anterior pituitary cells. *J Physiol* 586:3097–3111
 415. **Louiset E, McKernan R, Sieghart W, Vaudry H** 2000 Subunit composition and pharmacological characterization of γ -aminobutyric acid type A receptors in frog pituitary melanotrophs. *Endocrinology* 141:1083–1092
 416. **Hansen SL, Fjalland B, Jackson MB** 2003 Modulation of GABA_A receptors and neuropeptide secretion by the neurosteroid allopregnanolone in posterior and intermediate pituitary. *Pharmacol Toxicol* 93:91–97
 417. **Anderson RA, Mitchell R** 1986 Effects of γ -aminobutyric acid receptor agonists on the secretion of growth hormone, luteinizing hormone, adrenocorticotrophic hormone and thyroid-stimulating hormone from the rat pituitary gland *in vitro*. *J Endocrinol* 108:1–8
 418. **Acs Z, Szabó B, Kapócs G, Makara GB** 1987 γ -Aminobutyric acid stimulates pituitary growth hormone secretion in the neonatal rat. A superfusion study. *Endocrinology* 120:1790–1798
 419. **Virmani MA, Stojilkovic SS, Catt KJ** 1990 Stimulation of luteinizing hormone release by γ -aminobutyric acid (GABA) agonists: mediation by GABA_A-type receptors and activation of chloride and voltage-sensitive calcium channels. *Endocrinology* 126:2499–2505
 420. **Lorsignol A, Taupignon A, Dufy B** 1994 Short applications of γ -aminobutyric acid increase intracellular calcium concentrations in single identified rat lactotrophs. *Neuroendocrinology* 60:389–399
 421. **Williams B, Bence M, Everest H, Forrest-Owen W, Lightman SL, McArdle CA** 2000 GABA_A receptor mediated elevation of Ca²⁺ and modulation of gonadotrophin-releasing hormone action in α T3-1 gonadotropes. *J Neuroendocrinol* 12:159–166
 422. **Desrues L, Castel H, Malagon MM, Vaudry H, Tonon MC** 2005 The regulation of α -MSH release by GABA is mediated by a chloride-dependent [Ca²⁺]_i increase in frog melanotrope cells. *Peptides* 26:1936–1943
 423. **Desrues L, Vaudry H, Lamacz M, Tonon MC** 1995 Mechanism of action of γ -aminobutyric acid on frog melanotrophs. *J Mol Endocrinol* 14:1–12
 424. **Gamel-Didelon K, Kunz L, Fohr KJ, Gratzl M, Mayerhofer A** 2003 Molecular and physiological evidence for functional γ -aminobutyric acid (GABA)-C receptors in growth hormone-secreting cells. *J Biol Chem* 278:20192–20195
 425. **Inenaga K, Mason WT** 1987 γ -Aminobutyric acid modulates chloride channel activity in cultured primary bovine lactotrophs. *Neuroscience* 23:649–660
 426. **Louiset E, Mei YA, Valentijn JA, Vaudry H, Cazin L** 1994 Characterization of the GABA-induced current in frog pituitary melanotrophs. *J Neuroendocrinol* 6:39–46
 427. **Zemková H, Vanček J, Krůsek J** 1995 Electrophysiological characterization of GABA_A receptors in anterior pituitary cells of newborn rats. *Neuroendocrinology* 62:123–129
 428. **Zhang SJ, Jackson MB** 1995 GABA_A receptor activation and the excitability of nerve terminals in the rat posterior pituitary. *J Physiol* 483:583–595
 429. **Castel H, Jégou S, Tonon MC, Vaudry H** 2000 Regulation of the GABA(A) receptor by nitric oxide in frog pituitary melanotrophs. *Endocrinology* 141:3451–3460
 430. **Sikdar SK, Zorec R, Mason WT** 1990 cAMP directly facilitates Ca-induced exocytosis in bovine lactotrophs. *FEBS Lett* 273:150–154
 431. **Sikdar SK, Kreft M, Zorec R** 1998 Modulation of the unitary exocytic event amplitude by cAMP in rat melanotrophs. *J Physiol* 511:851–859
 432. **Sedej S, Rose T, Rupnik M** 2005 cAMP increases Ca²⁺-dependent exocytosis through both PKA and Epac2 in mouse melanotrophs from pituitary tissue slices. *J Physiol* 567:799–813
 433. **Kreft M, Zorec R** 2008 Anterior pituitary cells excited by GABA. *J Physiol* 586:3023–3024
 434. **Schally AV, Redding TW, Arimura A, Dupont A, Linthicum GL** 1977 Isolation of γ -aminobutyric acid from pig hypothalami and demonstration of its prolactin release-inhibiting (PIF) activity *in vivo* and *in vitro*. *Endocrinology* 100:681–691
 435. **Mitchell R, Grieve G, Dow R, Fink G** 1983 Endogenous GABA receptor ligands in hypophysial portal blood. *Neuroendocrinology* 37:169–176
 436. **Duvilanski BH, Pérez R, Seilicovich A, Lasaga M, Díaz MC, Debeljuk L** 2000 Intracellular distribution of GABA in the rat anterior pituitary. An electron microscopic autoradiographic study. *Tissue Cell* 32:284–292
 437. **Mayerhofer A, Höhne-Zell B, Gamel-Didelon K, Jung H, Redecker P, Grube D, Urbanski HF, Gasnier B, Fritschy JM, Gratzl M** 2001 γ -Aminobutyric acid (GABA): a para- and/or autocrine hormone in the pituitary. *FASEB J* 15:1089–1091
 438. **Alvarez P, Cardinali D, Cano P, Rebollar P, Esquifino A** 2005 A Prolactin daily rhythm in suckling male rabbits. *J Circadian Rhythms* 3:1
 439. **Afione S, Debeljuk L, Seilicovich A, Pisera D, Lasaga M, Díaz MC, Duvilanski B** 1990 Substance P affects the GABAergic system in the hypothalamo-pituitary axis. *Peptides* 11:1065–1068
 440. **Nicoletti F, Grandison L, Meek JL** 1985 Effects of repeated administration of estradiol benzoate on tubero-infundibular GABAergic activity in male rats. *J Neurochem* 44:1217–1220

441. Hussy N, Brès V, Rochette M, Duvoid A, Alonso G, Dayanithi G, Moos FC 2001 Osmoregulation of vasopressin secretion via activation of neurohypophysial nerve terminals glycine receptors by glial taurine. *J Neurosci* 21:7110–7116
442. Song Z, Hatton GI 2003 Taurine and the control of basal hormone release from rat neurohypophysis. *Exp Neurol* 183:330–337
443. Pin JP, Acher F 2002 The metabotropic glutamate receptors: structure, activation mechanism and pharmacology. *Curr Drug Targets CNS Neurol Disord* 1:297–317
444. Mayer ML, Armstrong N 2004 Structure and function of glutamate receptor ion channels. *Annu Rev Physiol* 66:161–181
445. Brann DW, Mahesh VB 1997 Excitatory amino acids: evidence for a role in the control of reproduction and anterior pituitary hormone secretion. *Endocr Rev* 18:678–700
446. Login IS 1990 Direct stimulation of pituitary prolactin release by glutamate. *Life Sci* 47:2269–2275
447. Pampillo M, Theas S, Duvilanski B, Seilicovich A, Lasaga M 2002 Effect of ionotropic and metabotropic glutamate agonists and D-aspartate on prolactin release from anterior pituitary cells. *Exp Clin Endocrinol Diabetes* 110:138–144
448. González LC, Pinilla L, Tena-Sempere M, Aguilar E 1999 Role of α -amino-3-hydroxy-5-methylisoxazole-4-propionic acid receptors in the control of prolactin, growth hormone and gonadotropin secretion in prepubertal rats. *J Endocrinol* 162:417–424
449. Donoso AO, López FJ, Negro-Vilar A 1990 Glutamate receptors of the non-N-methyl-D-aspartic acid type mediate the increase in luteinizing hormone-releasing hormone release by excitatory amino acids *in vitro*. *Endocrinology* 126:414–420
450. Herb A, Burnashev N, Werner P, Sakmann B, Wisden W, Seeburg PH 1992 The KA-2 subunit of excitatory amino acid receptors shows widespread expression in brain and forms ion channels with distantly related subunits. *Neuron* 8:775–785
451. Bhat GK, Mahesh VB, Chu ZW, Chorich LP, Zamorano PL, Brann DW 1995 Localization of the N-methyl-D-aspartate R1 receptor subunit in specific anterior pituitary hormone cell types of the female rat. *Neuroendocrinology* 62:178–186
452. Villalobos C, Núñez L, Garcia-Sancho J 1996 Functional glutamate receptors in a subpopulation of anterior pituitary cells. *FASEB J* 10:654–660
453. Bellinger FP, Fox BK, Chan WY, Davis LK, Andres MA, Hirano T, Grau EG, Cooke IM 2006 Ionotropic glutamate receptor activation increases intracellular calcium in prolactin-releasing cells of the adenohypophysis. *Am J Physiol Endocrinol Metab* 291:E1188–E1196
454. Poisbeau P, Jo YH, Feltz P, Schlichter R 1996 Electrophysiological characterization of non-NMDA glutamate receptors on cultured intermediate lobe cells of the rat pituitary. *Neuroendocrinology* 64:162–168
455. Kreft M, Blaganje M, Grilc S, Rupnik M, Zorec R 2006 Glutamate stimulation increases hormone release in rat melanotrophs. *Neurosci Lett* 404:299–302
456. Pampillo M, Scimonelli T, Duvilanski BH, Celis ME, Seilicovich A, Lasaga M 2002 The activation of metabotropic glutamate receptors differentially affects GABA and α -melanocyte stimulating hormone release from the hypothalamus and the posterior pituitary of male rats. *Neurosci Lett* 327:95–98
457. Stojilkovic SS 2009 Purinergic regulation of hypothalamopituitary functions. *Trends Endocrinol Metab* 20:460–468
458. North RA 2002 Molecular physiology of P2X receptors. *Physiol Rev* 82:1013–1067
459. Khakh BS, North RA 2006 P2X receptors as cell-surface ATP sensors in health and disease. *Nature* 442:527–532
460. Surprenant A, North RA 2009 Signaling at purinergic P2X receptors. *Annu Rev Physiol* 71:333–359
461. Stojilkovic SS, Koshimizu T 2001 Signaling by extracellular nucleotides in anterior pituitary cells. *Trends Endocrinol Metab* 12:218–225
462. He ML, Zemkova H, Koshimizu TA, Tomic M, Stojilkovic SS 2003 Intracellular calcium measurements as a method in studies on activity of purinergic P2X receptor channels. *Am J Physiol Cell Physiol* 285:C467–C479
463. Koshimizu T, Tomic M, Van Goor F, Stojilkovic SS 1998 Functional role of alternative splicing in pituitary P2X2 receptor-channel activation and desensitization. *Mol Endocrinol* 12:901–913
464. Koshimizu TA, Kretschmannova K, He ML, Ueno S, Tanoue A, Yanagihara N, Stojilkovic SS, Tsujimoto G 2006 Carboxyl-terminal splicing enhances physical interactions between the cytoplasmic tails of purinergic P2X receptors. *Mol Pharmacol* 69:1588–1598
465. Koshimizu T, Tomic M, Koshimizu M, Stojilkovic SS 1998 Identification of amino acid residues contributing to desensitization of the P2X2 receptor channel. *J Biol Chem* 273:12853–12857
466. Koshimizu T, Koshimizu M, Stojilkovic SS 1999 Contributions of the C-terminal domain to the control of P2X receptor desensitization. *J Biol Chem* 274:37651–37657
467. Koshimizu TA, Van Goor F, Tomic M, Wong AO, Tanoue A, Tsujimoto G, Stojilkovic SS 2000 Characterization of calcium signaling by purinergic receptor-channels expressed in excitable cells. *Mol Pharmacol* 58:936–945
468. Zemkova H, Balik A, Jiang Y, Kretschmannova K, Stojilkovic SS 2006 Roles of purinergic P2X receptors as pacemaking channels and modulators of calcium-mobilizing pathway in pituitary gonadotrophs. *Mol Endocrinol* 20:1423–1436
469. Tomic M, Jobin RM, Vergara LA, Stojilkovic SS 1996 Expression of purinergic receptor channels and their role in calcium signaling and hormone release in pituitary gonadotrophs. Integration of P2 channels in plasma membrane and endoplasmic reticulum-derived calcium oscillations. *J Biol Chem* 271:21200–21208
470. Rong W, Gourine AV, Cockayne DA, Xiang Z, Ford AP, Spyer KM, Burnstock G 2003 Pivotal role of nucleotide P2X2 receptor subunit of the ATP-gated ion channel mediating ventilatory responses to hypoxia. *J Neurosci* 23:11315–11321
471. Zemkova H, Yan Z, Liang Z, Jelinkova I, Tomic M, Stojilkovic SS 2007 Role of aromatic and charged ectodomain residues in the P2X(4) receptor functions. *J Neurochem* 102:1139–1150
472. Jelinkova I, Vávra V, Jindrichova M, Obsil T, Zemkova HW, Zemkova H, Stojilkovic SS 2008 Identification of P2X(4) receptor transmembrane residues contributing to channel gating and interaction with ivermectin. *Pflugers Arch* 456:939–950

473. Jindrichova M, Vavra V, Obsil T, Stojilkovic SS, Zemkova H 2009 Functional relevance of aromatic residues in the first transmembrane domain of P2X receptors. *J Neurochem* 109:923–934
474. He ML, Gonzalez-Iglesias AE, Stojilkovic SS 2003 Role of nucleotide P2 receptors in calcium signaling and prolactin release in pituitary lactotrophs. *J Biol Chem* 278:46270–46277
475. Zemkova H, Kucka M, Li S, Gonzalez-Iglesias AE, Tomic M, Stojilkovic SS 2010 Characterization of purinergic P2X4 receptor channels expressed in anterior pituitary cells. *Am J Physiol Endocrinol Metab* 298:E644–E651
476. Yamamoto K, Sokabe T, Matsumoto T, Yoshimura K, Shibata M, Ohura N, Fukuda T, Sato T, Sekine K, Kato S, Isshiki M, Fujita T, Kobayashi M, Kawamura K, Masuda H, Kamiya A, Ando J 2006 Impaired flow-dependent control of vascular tone and remodeling in P2X4-deficient mice. *Nat Med* 12:133–137
477. Troadec JD, Thirion S 2002 Multifaceted purinergic regulation of stimulus-secretion coupling in the neurohypophysis. *Neuro Endocrinol Lett* 23:273–280
478. Troadec JD, Thirion S, Nicaise G, Lemos JR, Dayanithi G 1998 ATP-evoked increases in $[Ca^{2+}]_i$ and peptide release from rat isolated neurohypophysial terminals via a P2X2 purinoceptor. *J Physiol* 511:89–103
479. Knott TK, Marrero HG, Custer EE, Lemos JR 2008 Endogenous ATP potentiates only vasopressin secretion from neurohypophysial terminals. *J Cell Physiol* 217:155–161
480. He ML, Gonzalez-Iglesias AE, Tomic M, Stojilkovic SS 2005 Release and extracellular metabolism of ATP by ectonucleotidase eNTPDase 1–3 in hypothalamic and pituitary cells. *Purinergic Signal* 1:135–144
481. Nuñez L, Villalobos C, Frawley LS 1997 Extracellular ATP as an autocrine/paracrine regulator of prolactin release. *Am J Physiol* 272:E1117–E1123
482. Abbracchio MP, Burnstock G, Verkhratsky A, Zimmermann H 2009 Purinergic signalling in the nervous system: an overview. *Trends Neurosci* 32:19–29
483. Stojilkovic SS, He ML, Koshimizu TA, Balik A, Zemkova H 2010 Signaling by purinergic receptors and channels in the pituitary gland. *Mol Cell Endocrinol* 314:184–191
484. Zimmermann H 2000 Extracellular metabolism of ATP and other nucleotides. *Naunyn Schmiedebergs Arch Pharmacol* 362:299–309
485. Yegutkin GG 2008 Nucleotide- and nucleoside-converting ectoenzymes: important modulators of purinergic signaling cascade. *Biochim Biophys Acta* 1783:673–694
486. Thirion S, Troadec JD, Nicaise G 1996 Cytochemical localization of ecto-ATPases in rat neurohypophysis. *J Histochem Cytochem* 44:103–111
487. Sperlágh B, Mergl Z, Jurányi Z, Vizi ES, Makara GB 1999 Local regulation of vasopressin and oxytocin secretion by extracellular ATP in the isolated posterior lobe of the rat hypophysis. *J Endocrinol* 160:343–350
488. Probst WC, Snyder LA, Schuster DI, Brosius J, Sealson SC 1992 Sequence alignment of the G-protein coupled receptor superfamily. *DNA Cell Biol* 11:1–20
489. Savarese TM, Fraser CM 1992 In vitro mutagenesis and the search for structure-function relationships among G protein-coupled receptors. *Biochem J* 283:1–19
490. Bale TL, Vale WW 2004 CRF and CRF receptors: role in stress responsivity and other behaviors. *Annu Rev Pharmacol Toxicol* 44:525–557
491. Mayo KE, Miller T, DeAlmeida V, Godfrey P, Zheng J, Cunha SR 2000 Regulation of the pituitary somatotroph cell by GHRH and its receptor. *Recent Prog Horm Res* 55:237–266; discussion 266–267
492. Tanaka K, Shibuya I, Harayama N, Nomura M, Kabashima N, Ueta Y, Yamashita H 1997 Pituitary adenylate cyclase-activating polypeptide potentiation of Ca^{2+} entry via protein kinase C and A pathways in melanotrophs of the pituitary pars intermedia of rats. *Endocrinology* 138:4086–4095
493. Kunzelmann P, Creff A, Bauer K, Mollard P 2000 PACAP and VIP induce changes in cytosolic calcium in putative folliculostellate cells of the mouse pituitary. *Ann NY Acad Sci* 921:410–414
494. Spence JW, Sheppard MS, Kraicer J 1980 Release of growth hormone from purified somatotrophs: interrelation between Ca^{++} and adenosine 3',5'-monophosphate. *Endocrinology* 106:764–769
495. Kaiser UB, Conn PM, Chin WW 1997 Studies of gonadotropin-releasing hormone (GnRH) action using GnRH receptor-expressing pituitary cell lines. *Endocr Rev* 18:46–70
496. Krsmanovic LZ, Mores N, Navarro CE, Arora KK, Catt KJ 2003 An agonist-induced switch in G protein coupling of the gonadotropin-releasing hormone receptor regulates pulsatile neuropeptide secretion. *Proc Natl Acad Sci USA* 100:2969–2974
497. Boyajian CL, Cooper DM 1990 Potent and cooperative feedback inhibition of adenylate cyclase activity by calcium in pituitary-derived GH3 cells. *Cell Calcium* 11:299–307
498. Abou-Samra AB, Harwood JP, Catt KJ, Aguilera G 1987 Mechanisms of action of CRF and other regulators of ACTH release in pituitary corticotrophs. *Ann NY Acad Sci* 512:67–84
499. Kuryshev YA, Childs GV, Ritchie AK 1995 Corticotropin-releasing hormone stimulation of Ca^{2+} entry in corticotropes is partially dependent on protein kinase A. *Endocrinology* 136:3925–3935
500. Lee AK, Tse A 1997 Mechanism underlying corticotropin-releasing hormone (CRH) triggered cytosolic Ca^{2+} rise in identified rat corticotrophs. *J Physiol* 504:367–378
501. LeBeau AP, Robson AB, McKinnon AE, Donald RA, Sneyd J 1997 Generation of action potentials in a mathematical model of corticotrophs. *Biophys J* 73:1263–1275
502. Ritchie AK, Kuryshev YA, Childs GV 1996 Corticotropin-releasing hormone and calcium signaling in corticotropes. *Trends Endocrinol Metab* 7:365–369
503. Xie J, Nagle GT, Childs GV, Ritchie AK 1999 Expression of the L-type Ca^{2+} channel in AtT-20 cells is regulated by cyclic AMP. *Neuroendocrinology* 70:1–9
504. Ramírez JL, Castaño JP, Torronteras R, Martínez-Fuentes AJ, Frawley LS, García-Navarro S, Gracia-Navarro F 1999 Growth hormone (GH)-releasing factor differentially activates cyclic adenosine 3',5'-monophosphate- and inositol phosphate-dependent pathways to stimulate GH release in two porcine somatotrope subpopulations. *Endocrinology* 140:1752–1759
505. Kwiecien R, Tseeb V, Kurchikov A, Kordon C, Hammond C 1997 Growth hormone-releasing hormone triggers pace-

- maker activity and persistent Ca²⁺ oscillations in rat somatotrophs. *J Physiol* 499:613–623
506. Lussier BT, French MB, Moor BC, Kraicer J 1991 Free intracellular Ca²⁺ concentration and growth hormone (GH) release from purified rat somatotrophs. III. Mechanism of action of GH-releasing factor and somatostatin. *Endocrinology* 128:592–603
507. Lussier BT, French MB, Moore BC, Kraicer J 1991 Free intracellular Ca²⁺ concentration ([Ca²⁺]_i) and growth hormone release from purified rat somatotrophs. I. GH-releasing factor-induced Ca²⁺ influx raises [Ca²⁺]_i. *Endocrinology* 128:570–582
508. Lussier BT, Wood DA, French MB, Moor BC, Kraicer J 1991 Free intracellular Ca²⁺ concentration ([Ca²⁺]_i) and growth hormone release from purified rat somatotrophs. II. Somatostatin lowers [Ca²⁺]_i by inhibiting Ca²⁺ influx. *Endocrinology* 128:583–591
509. Holl RW, Thorner MO, Leong DA 1988 Intracellular calcium concentration and growth hormone secretion in individual somatotropes: effects of growth hormone-releasing factor and somatostatin. *Endocrinology* 122:2927–2932
510. Cuttler L, Glaum SR, Collins BA, Miller RJ 1992 Calcium signalling in single growth hormone-releasing factor-responsive pituitary cells. *Endocrinology* 130:945–953
511. Rawlings SR, Hoyland J, Mason WT 1991 Calcium homeostasis in bovine somatotrophs: calcium oscillations and calcium regulation by growth hormone-releasing hormone and somatostatin. *Cell Calcium* 12:403–414
512. Kato M, Suzuki M 1989 Effect of Li⁺ substitution for extracellular Na⁺ on GRF-induced GH secretion from rat pituitary cells. *Am J Physiol* 256:C712–C718
513. Takano K, Takei T, Teramoto A, Yamashita N 1996 GHRH activates a nonselective cation current in human GH-secreting adenoma cells. *Am J Physiol* 270:E1050–E1057
514. Chen C, Xu R, Clarke IJ, Ruan M, Loneragan K, Roh SG 2000 Diverse intracellular signalling systems used by growth hormone-releasing hormone in regulating voltage-gated Ca²⁺ or K channels in pituitary somatotropes. *Immunol Cell Biol* 78:356–368
515. Chen C, Clarke IJ 1995 Modulation of Ca²⁺ influx in the ovine somatotroph by growth hormone-releasing factor. *Am J Physiol* 268:E204–E212
516. Takei T, Takano K, Yasufuku-Takano J, Fujita T, Yamashita N 1996 Enhancement of Ca²⁺ currents by GHRH and its relation to PKA and [Ca²⁺]_i in human GH-secreting adenoma cells. *Am J Physiol* 271:E801–E807
517. Xu R, Roh SG, Loneragan K, Pullar M, Chen C 1999 Human GHRH reduces voltage-gated K⁺ currents via a non-cAMP-dependent but PKC-mediated pathway in human GH adenoma cells. *J Physiol* 520:697–707
518. Chen C, Clarke IJ 1995 Effects of growth hormone-releasing peptide-2 (GHRP-2) on membrane Ca²⁺ permeability in cultured ovine somatotrophs. *J Neuroendocrinol* 7:179–186
519. Müller EE, Locatelli V, Cocchi D 1999 Neuroendocrine control of growth hormone secretion. *Physiol Rev* 79:511–607
520. Vaudry D, Falluel-Morel A, Bourgault S, Basille M, Burel D, Wurtz O, Fournier A, Chow BK, Hashimoto H, Galas L, Vaudry H 2009 Pituitary adenylate cyclase-activating polypeptide and its receptors: 20 years after the discovery. *Pharmacol Rev* 61:283–357
521. Rawlings SR, Demareux N, Schlegel W 1994 Pituitary adenylate cyclase-activating polypeptide increases [Ca²⁺]_i in rat gonadotrophs through an inositol trisphosphate-dependent mechanism. *J Biol Chem* 269:5680–5686
522. Hezareh M, Schlegel W, Rawlings SR 1997 Stimulation of Ca²⁺ influx in α T3-1 gonadotrophs via the cAMP/PKA signaling system. *Am J Physiol* 273:E850–E858
523. Koch B, Lutz-Bucher B 1992 Pituitary adenylate cyclase-activating polypeptide (PACAP) stimulates cyclic AMP formation as well as peptide output of cultured pituitary melanotrophs and AtT-20 corticotrophs. *Regul Pept* 38:45–53
524. Yada T, Vigh S, Arimura A 1993 Pituitary adenylate cyclase activating polypeptide (PACAP) increases cytosolic-free calcium concentration in folliculo-stellate cells and somatotropes of rat pituitary. *Peptides* 14:235–239
525. Canny BJ, Rawlings SR, Leong DA 1992 Pituitary adenylate cyclase-activating polypeptide specifically increases cytosolic calcium ion concentration in rat gonadotropes and somatotropes. *Endocrinology* 130:211–215
526. Rawlings SR, Canny BJ, Leong DA 1993 Pituitary adenylate cyclase-activating polypeptide regulates cytosolic Ca²⁺ in rat gonadotropes and somatotropes through different intracellular mechanisms. *Endocrinology* 132:1447–1452
527. Alarcón P, García-Sancho J 2000 Differential calcium responses to the pituitary adenylate cyclase-activating polypeptide (PACAP) in the five main cell types of rat anterior pituitary. *Pflugers Arch* 440:685–691
528. Mollard P, Zhang Y, Rodman D, Cooper DM 1992 Limited accumulation of cyclic AMP underlies a modest vasoactive-intestinal-peptide-mediated increase in cytosolic [Ca²⁺]_i transients in GH3 pituitary cells. *Biochem J* 284:637–640
529. Rawlings SR, Piuz I, Schlegel W, Bockaert J, Journot L 1995 Differential expression of pituitary adenylate cyclase-activating polypeptide/vasoactive intestinal polypeptide receptor subtypes in clonal pituitary somatotrophs and gonadotrophs. *Endocrinology* 136:2088–2098
530. Martínez de la Escalera G, Weiner RI 1992 Dissociation of dopamine from its receptor as a signal in the pleiotropic hypothalamic regulation of prolactin secretion. *Endocr Rev* 13:241–255
531. Tena-Sempere M, Pinilla L, Aguilar E 1996 In vitro pituitary GH secretion after GHRH, forskolin, dibutyryl cyclic-adenosine 3',5'-monophosphate and phorbol 12-myristate 13-acetate stimulation in long-term orchidectomized rats. *J Mol Endocrinol* 16:81–88
532. Cronin MJ, Evans WS, Hewlett EL, Thorner MO 1984 LH release is facilitated by agents that alter cyclic AMP-generating system. *Am J Physiol* 246:E44–E51
533. Turgeon JL, Waring DW 1986 cAMP augmentation of secretagogue-induced luteinizing hormone secretion. *Am J Physiol* 250:E62–E68
534. Bernardini R, Iurato MP, Chiarenza A, Lempereur L, Calogero AE, Sternberg EM 1996 Adenylate-cyclase-dependent pituitary adrenocorticotropin secretion is defective in the inflammatory-disease-susceptible Lewis rat. *Neuroendocrinology* 63:468–474
535. Cochilla AJ, Angleson JK, Betz WJ 2000 Differential regulation of granule-to-granule and granule-to-plasma mem-

- brane fusion during secretion from rat pituitary lactotrophs. *J Cell Biol* 150:839–848
536. **Nagy G, Reim K, Matti U, Brose N, Binz T, Rettig J, Neher E, Sørensen JB** 2004 Regulation of releasable vesicle pool sizes by protein kinase A-dependent phosphorylation of SNAP-25. *Neuron* 41:417–429
537. **Kuromi H, Kidokoro Y** 2000 Tetanic stimulation recruits vesicles from reserve pool via a cAMP-mediated process in *Drosophila* synapses. *Neuron* 27:133–143
538. **Menegon A, Bonanomi D, Albertinazzi C, Lotti F, Ferrari G, Kao HT, Benfenati F, Baldelli P, Valtorta F** 2006 Protein kinase A-mediated synapsin I phosphorylation is a central modulator of Ca²⁺-dependent synaptic activity. *J Neurosci* 26:11670–11681
539. **Patel YC, Srikant CB** 1986 Somatostatin mediation of adeno-hypophysial secretion. *Annu Rev Physiol* 48:551–567
540. **Reisine T, Bell GI** 1995 Molecular biology of somatostatin receptors. *Endocr Rev* 16:427–442
541. **Missale C, Nash SR, Robinson SW, Jaber M, Caron MG** 1998 Dopamine receptors: from structure to function. *Physiol Rev* 78:189–225
542. **Rees DA, Scanlon MF, Ham J** 2003 Adenosine signalling pathways in the pituitary gland: one ligand, multiple receptors. *J Endocrinol* 177:357–364
543. **Stojilkovic SS, Catt KJ** 1992 Neuroendocrine actions of endothelins. *Trends Pharmacol Sci* 13:385–391
544. **Lux-Lantos V, Becú-Villalobos D, Bianchi M, Rey-Roldán E, Chamson-Reig A, Pignataro O, Libertun C** 2001 GABA(B) receptors in anterior pituitary cells. Mechanism of action coupled to endocrine effects. *Neuroendocrinology* 73:334–343
545. **Balik A, Kretschmannova K, Mazna P, Svobodova I, Zemkova H** 2004 Melatonin action in neonatal gonadotrophs. *Physiol Res* 53(Suppl 1):S153–S166
546. **Wang J, Ciofi P, Crowley WR** 1996 Neuropeptide Y suppresses prolactin secretion from rat anterior pituitary cells: evidence for interactions with dopamine through inhibitory coupling to calcium entry. *Endocrinology* 137:587–594
547. **Meyerhof W** 1998 The elucidation of somatostatin receptor functions: a current view. *Rev Physiol Biochem Pharmacol* 133:55–108
548. **Chen C, Israel JM, Vincent JD** 1989 Electrophysiological responses to somatostatin of rat hypophysial cells in somatotroph-enriched primary cultures. *J Physiol* 408:493–510
549. **Mollard P, Vacher P, Dufy B, Barker JL** 1988 Somatostatin blocks Ca²⁺ action potential activity in prolactin-secreting pituitary tumor cells through coordinate actions on K⁺ and Ca²⁺ conductances. *Endocrinology* 123:721–732
550. **Koch BD, Blalock JB, Schonbrunn A** 1988 Characterization of the cyclic AMP-independent actions of somatostatin in GH cells. I. An increase in potassium conductance is responsible for both the hyperpolarization and the decrease in intracellular free calcium produced by somatostatin. *J Biol Chem* 263:216–225
551. **Yamashita N, Kojima I, Shibuya N, Ogata E** 1987 Pertussis toxin inhibits somatostatin-induced K⁺ conductance in human pituitary tumor cells. *Am J Physiol* 253:E28–E32
552. **Takano K, Ajima M, Teramoto A, Hata K, Yamashita N** 1995 Mechanisms of action of somatostatin on human TSH-secreting adenoma cells. *Am J Physiol* 268:E558–E564
553. **Bilezikjian LM, Vale WW** 1983 Stimulation of adenosine 3',5'-monophosphate production by growth hormone-releasing factor and its inhibition by somatostatin in anterior pituitary cells *in vitro*. *Endocrinology* 113:1726–1731
554. **Kato M, Sakuma Y** 1997 Regulation by growth hormone-releasing hormone and somatostatin of a Na⁺ current in the primary cultured rat somatotroph. *Endocrinology* 138:5096–5100
555. **Yang SK, Chen C** 2007 Involvement of somatostatin receptor subtypes in membrane ion channel modification by somatostatin in pituitary somatotropes. *Clin Exp Pharmacol Physiol* 34:1221–1227
556. **Scherübl H, Hescheler J, Riecken EO** 1993 Molecular mechanisms of somatostatin's inhibition of hormone release: participation of voltage-gated calcium channels and G-proteins. *Horm Metab Res Suppl* 27:1–4
557. **White RE, Schonbrunn A, Armstrong DL** 1991 Somatostatin stimulates Ca(2+)-activated K⁺ channels through protein dephosphorylation. *Nature* 351:570–573
558. **Chen C, Zhang J, Vincent JD, Israel JM** 1990 Two types of voltage-dependent calcium current in rat somatotrophs are reduced by somatostatin. *J Physiol* 425:29–42
559. **Luini A, Lewis D, Guild S, Schofield G, Weight F** 1986 Somatostatin, an inhibitor of ACTH secretion, decreases cytosolic free calcium and voltage-dependent calcium current in a pituitary cell line. *J Neurosci* 6:3128–3132
560. **Yang SK, Parkington HC, Epelbaum J, Keating DJ, Chen C** 2007 Somatostatin decreases voltage-gated Ca²⁺ currents in GH3 cells through activation of somatostatin receptor 2. *Am J Physiol Endocrinol Metab* 292:E1863–E1870
561. **Tallent M, Liapakis G, O'Carroll AM, Lolait SJ, Dichter M, Reisine T** 1996 Somatostatin receptor subtypes SSTR2 and SSTR5 couple negatively to an L-type Ca²⁺ current in the pituitary cell line AtT-20. *Neuroscience* 71:1073–1081
562. **Kato M** 1995 Withdrawal of somatostatin augments L-type Ca²⁺ current in primary cultured rat somatotrophs. *J Neuroendocrinol* 7:855–859
563. **Chen ZP, Xu S, Lightman SL, Hall L, Levy A** 1997 Intracellular calcium ion responses to somatostatin in cells from human somatotroph adenomas. *Clin Endocrinol (Oxf)* 46:45–53
564. **Lewis DL, Weight FF, Luini A** 1986 A guanine nucleotide-binding protein mediates the inhibition of voltage-dependent calcium current by somatostatin in a pituitary cell line. *Proc Natl Acad Sci USA* 83:9035–9039
565. **Petrucci C, Cervia D, Buzzi M, Biondi C, Bagnoli P** 2000 Somatostatin-induced control of cytosolic free calcium in pituitary tumour cells. *Br J Pharmacol* 129:471–484
566. **Chen C, Clarke IJ** 1996 G(o)-2 protein mediates the reduction in Ca²⁺ currents by somatostatin in cultured ovine somatotrophs. *J Physiol* 491:21–29
567. **Chen C** 1998 Gi-3 protein mediates the increase in voltage-gated K⁺ currents by somatostatin on cultured ovine somatotrophs. *Am J Physiol* 275:E278–E284
568. **Kleuss C** 1995 Somatostatin modulates voltage-dependent Ca²⁺ channels in GH3 cells via a specific G(o) splice variant. *Ciba Found Symp* 190:171–182; discussion 182–186
569. **Liu YF, Jakobs KH, Rasenick MM, Albert PR** 1994 G protein specificity in receptor-effector coupling. *Analysis*

- of the roles of G₀ and G_{i2} in GH4C1 pituitary cells. *J Biol Chem* 269:13880–13886
570. Ramírez JL, Gracia-Navarro F, García-Navarro S, Torronteras R, Malagón MM, Castaño JP 2002 Somatostatin stimulates GH secretion in two porcine somatotrope subpopulations through a cAMP-dependent pathway. *Endocrinology* 143:889–897
571. Chronwall BM, Sands SA, Dickerson DS, Sibley DR, Gary KA 1996 Melanotrope dopamine D2 receptor isoform expression in the developing rat pituitary. *Int J Dev Neurosci* 14:77–86
572. Burris TP, Nguyen DN, Smith SG, Freeman ME 1992 The stimulatory and inhibitory effects of dopamine on prolactin secretion involve different G-proteins. *Endocrinology* 130:926–932
573. Giros B, Sokoloff P, Martres MP, Riou JF, Emorine LJ, Schwartz JC 1989 Alternative splicing directs the expression of two D2 dopamine receptor isoforms. *Nature* 342:923–926
574. Monsma Jr JF, McVittie LD, Gerfen CR, Mahan LC, Sibley DR 1989 Multiple D2 dopamine receptors produced by alternative RNA splicing. *Nature* 342:926–929
575. Kukstas LA, Domec C, Bascles L, Bonnet J, Verrier D, Israel JM, Vincent JD 1991 Different expression of the two dopaminergic D2 receptors, D2415 and D2444, in two types of lactotroph each characterised by their response to dopamine, and modification of expression by sex steroids. *Endocrinology* 129:1101–1103
576. Kelly MA, Rubinstein M, Asa SL, Zhang G, Saez C, Bunzow JR, Allen RG, Hnasko R, Ben-Jonathan N, Grandy DK, Low MJ 1997 Pituitary lactotroph hyperplasia and chronic hyperprolactinemia in dopamine D2 receptor-deficient mice. *Neuron* 19:103–113
577. Senogles SE, Benovic JL, Amlaiky N, Unson C, Milligan G, Vinitzky R, Spiegel AM, Caron MG 1987 The D2-dopamine receptor of anterior pituitary is functionally associated with a pertussis toxin-sensitive guanine nucleotide binding protein. *J Biol Chem* 262:4860–4867
578. Enjalbert A, Bockaert J 1983 Pharmacological characterization of the D2 dopamine receptor negatively coupled with adenylate cyclase in rat anterior pituitary. *Mol Pharmacol* 23:576–584
579. McDonald WM, Sibley DR, Kilpatrick BF, Caron MG 1984 Dopaminergic inhibition of adenylate cyclase correlates with high affinity agonist binding to anterior pituitary D2 dopamine receptors. *Mol Cell Endocrinol* 36:201–209
580. Cronin MJ, Myers GA, MacLeod RM, Hewlett EL 1983 Pertussis toxin uncouples dopamine agonist inhibition of prolactin release. *Am J Physiol* 244:E499–E504
581. Martin TF 2003 Tuning exocytosis for speed: fast and slow modes. *Biochim Biophys Acta* 1641:157–165
582. Boyd RS, Ray KP, Wallis M 1988 Actions of pertussis toxin on the inhibitory effects of dopamine and somatostatin on prolactin and growth hormone release from ovine anterior pituitary cells. *J Mol Endocrinol* 1:179–186
583. Gonzalez-Iglesias AE, Murano T, Li S, Tomic M, Stojilkovic SS 2008 Dopamine inhibits basal prolactin release in pituitary lactotrophs through pertussis toxin-sensitive and -insensitive signaling pathways. *Endocrinology* 149:1470–1479
584. Lledo PM, Guérineau N, Mollard P, Vincent JD, Israel JM 1991 Physiological characterization of two functional states in subpopulations of prolactin cells from lactating rats. *J Physiol* 437:477–494
585. Kuan SI, Login IS, Judd AM, MacLeod RM 1990 A comparison of the concentration-dependent actions of thyrotropin-releasing hormone, angiotensin II, bradykinin, and Lys-bradykinin on cytosolic free calcium dynamics in rat anterior pituitary cells: selective effects of dopamine. *Endocrinology* 127:1841–1848
586. Lamberts SW, Macleod RM 1990 Regulation of prolactin secretion at the level of the lactotroph. *Physiol Rev* 70:279–318
587. Malgaroli A, Vallar L, Elahi FR, Pozzan T, Spada A, Meldolesi J 1987 Dopamine inhibits cytosolic Ca²⁺ increases in rat lactotroph cells. Evidence of a dual mechanism of action. *J Biol Chem* 262:13920–13927
588. Lledo PM, Legendre P, Zhang J, Israel JM, Vincent JD 1990 Effects of dopamine on voltage-dependent potassium currents in identified rat lactotroph cells. *Neuroendocrinology* 52:545–555
589. Valentijn JA, Louiset E, Vaudry H, Cazin L 1991 Dopamine-induced inhibition of action potentials in cultured frog pituitary melanotrophs is mediated through activation of potassium channels and inhibition of calcium and sodium channels. *Neuroscience* 42:29–39
590. del Mar Hernández M, García Ferreira RE, García DE, Hernández ME, Clapp C, Martínez de la Escalera G 1999 Potentiation of prolactin secretion following lactotrope escape from dopamine action. I. Dopamine withdrawal augments l-type calcium current. *Neuroendocrinology* 70:20–30
591. Lledo PM, Legendre P, Israel JM, Vincent JD 1990 Dopamine inhibits two characterized voltage-dependent calcium currents in identified rat lactotroph cells. *Endocrinology* 127:990–1001
592. Lledo PM, Homburger V, Bockaert J, Vincent JD 1992 Differential G protein-mediated coupling of D2 dopamine receptors to K⁺ and Ca²⁺ currents in rat anterior pituitary cells. *Neuron* 8:455–463
593. Seabrook GR, Knowles M, Brown N, Myers J, Sinclair H, Patel S, Freedman SB, McAllister G 1994 Pharmacology of high-threshold calcium currents in GH4C1 pituitary cells and their regulation by activation of human D2 and D4 dopamine receptors. *Br J Pharmacol* 112:728–734
594. Rendt J, Oxford GS 1994 Absence of coupling between D2 dopamine receptors and calcium channels in lactotrophs from cycling female rats. *Endocrinology* 135:501–508
595. Valentijn JA, Louiset E, Vaudry H, Cazin L 1991 Dopamine regulates the electrical activity of frog melanotrophs through a G protein-mediated mechanism. *Neuroscience* 44:85–95
596. Einhorn LC, Oxford GS 1993 Guanine nucleotide binding proteins mediate D2 dopamine receptor activation of a potassium channel in rat lactotrophs. *J Physiol* 462:563–578
597. Lledo PM, Israel JM, Vincent JD 1990 A guanine nucleotide-binding protein mediates the inhibition of voltage-dependent calcium currents by dopamine in rat lactotrophs. *Brain Res* 528:143–147
598. Deneff C, Baes M, Schramme C 1984 Stimulation of prolactin secretion after short term or pulsatile exposure to dopamine in superfused anterior pituitary cell aggregates. *Endocrinology* 114:1371–1378
599. Gregerson KA, Goleosorkhi N, Chuknyiska R 1994 Stim-

- ulation of prolactin release by dopamine withdrawal: role of membrane hyperpolarization. *Am J Physiol* 267:E781–E788
600. Gregerson KA, Chuknyiska R, Golesorkhi N 1994 Stimulation of prolactin release by dopamine withdrawal: role of calcium influx. *Am J Physiol* 267:E789–E794
601. Deneff C, Manet D, Dewals R 1980 Dopaminergic stimulation of prolactin release. *Nature* 285:243–246
602. Chang A, Shin SH, Pang SC 1997 Dopamine D2 receptor mediates both inhibitory and stimulatory actions on prolactin release. *Endocrine* 7:177–182
603. Porter TE, Grandy D, Bunzow J, Wiles CD, Civelli O, Frawley LS 1994 Evidence that stimulatory dopamine receptors may be involved in the regulation of prolactin secretion. *Endocrinology* 134:1263–1268
604. Tagawa R, Takahara J, Sato M, Niimi M, Murao K, Ishida T 1992 Stimulatory effects of quinpirole hydrochloride, D2-dopamine receptor agonist, at low concentrations on prolactin release in female rats in vitro. *Life Sci* 51:727–732
605. Beaulieu JM, Sotnikova TD, Marion S, Lefkowitz RJ, Gainetdinov RR, Caron MG 2005 An Akt/ β -arrestin 2/PP2A signaling complex mediates dopaminergic neurotransmission and behavior. *Cell* 122:261–273
606. Evans GJ, Barclay JW, Prescott GR, Jo SR, Burgoyne RD, Birnbaum MJ, Morgan A 2006 Protein kinase B/Akt is a novel cysteine string protein kinase that regulates exocytosis release kinetics and quantal size. *J Biol Chem* 281:1564–1572
607. Hayakawa J, Ohmichi M, Tasaka K, Kanda Y, Adachi K, Nishio Y, Hisamoto K, Mabuchi S, Hinuma S, Murata Y 2002 Regulation of the PRL promoter by Akt through cAMP response element binding protein. *Endocrinology* 143:13–22
608. Obadiah J, Avidor-Reiss T, Fishburn CS, Carmon S, Bayewitch M, Vogel Z, Fuchs S, Levavi-Sivan B 1999 Adenylyl cyclase interaction with the D2 dopamine receptor family; differential coupling to Gi, Gz, and Gs. *Cell Mol Neurobiol* 19:653–664
609. Leck KJ, Blaha CD, Matthaehi KI, Forster GL, Holgate J, Hendry IA 2006 Gz proteins are functionally coupled to dopamine D2-like receptors in vivo. *Neuropharmacology* 51:597–605
610. Sidhu A, Kimura K, Uh M, White BH, Patel S 1998 Multiple coupling of human D5 dopamine receptors to guanine nucleotide binding proteins Gs and Gz. *J Neurochem* 70:2459–2467
611. Livingstone JD, Lerant A, Freeman ME 1998 Ovarian steroids modulate responsiveness to dopamine and expression of G-proteins in lactotropes. *Neuroendocrinology* 68:172–179
612. Gregerson KA 2003 Functional expression of the dopamine-activated K(+) current in lactotrophs during the estrous cycle in female rats: correlation with prolactin secretory responses. *Endocrine* 20:67–74
613. Dufy B, Vincent JD, Fleury H, Du Pasquier P, Gourdji D, Tixier-Vidal A 1979 Dopamine inhibition of action potentials in a prolactin secreting cell line is modulated by oestrogen. *Nature* 282:855–857
614. Yanagisawa M, Inoue A, Ishikawa T, Kasuya Y, Kimura S, Kumagaye S, Nakajima K, Watanabe TX, Sakakibara S, Goto K, Masaki T 1988 Primary structure, synthesis, and biological activity of rat endothelin, an endothelium-derived vasoconstrictor peptide. *Proc Natl Acad Sci USA* 85:6964–6967
615. Inoue A, Yanagisawa M, Takuwa Y, Mitsui Y, Kobayashi M, Masaki T 1989 The human preproendothelin-1 gene. Complete nucleotide sequence and regulation of expression. *J Biol Chem* 264:14954–14959
616. Simonson MS, Dunn MJ 1990 Cellular signaling by peptides of the endothelin gene family. *FASEB J* 4:2989–3000
617. Stojilkovic SS, Catt KJ 1996 Expression and signal transduction pathways of endothelin receptors in neuroendocrine cells. *Front Neuroendocrinol* 17:327–369
618. Arai H, Hori S, Aramori I, Ohkubo H, Nakanishi S 1990 Cloning and expression of a cDNA encoding an endothelin receptor. *Nature* 348:730–732
619. Sakurai T, Yanagisawa M, Takuwa Y, Miyazaki H, Kimura S, Goto K, Masaki T 1990 Cloning of a cDNA encoding a non-isopeptide-selective subtype of the endothelin receptor. *Nature* 348:732–735
620. Milligan G, Kostenis E 2006 Heterotrimeric G-proteins: a short history. *Br J Pharmacol* 147(Suppl 1):S46–S55
621. Davenport AP 2002 International Union of Pharmacology. XXIX. Update on endothelin receptor nomenclature. *Pharmacol Rev* 54:219–226
622. Karne S, Jayawickreme CK, Lerner MR 1993 Cloning and characterization of an endothelin-3 specific receptor (ETC receptor) from *Xenopus laevis* dermal melanophores. *J Biol Chem* 268:19126–19133
623. Shyamala V, Moulthrop TH, Stratton-Thomas J, Tekamp-Olson P 1994 Two distinct human endothelin B receptors generated by alternative splicing from a single gene. *Cell Mol Biol Res* 40:285–296
624. Elshourbagy NA, Adamou JE, Gagnon AW, Wu HL, Pullen M, Nambi P 1996 Molecular characterization of a novel human endothelin receptor splice variant. *J Biol Chem* 271:25300–25307
625. Nambi P, Wu HL, Ye D, Gagnon A, Elshourbagy N 2000 Characterization of a novel porcine endothelin (B) receptor splice variant. *J Pharmacol Exp Ther* 292:247–253
626. Miyamoto Y, Yoshimasa T, Arai H, Takaya K, Ogawa Y, Itoh H, Nakao K 1996 Alternative RNA splicing of the human endothelin-A receptor generates multiple transcripts. *Biochem J* 313:795–801
627. Bourgeois C, Robert B, Rebouret R, Mondon F, Mignot TM, Duc-Goiran P, Ferré F 1997 Endothelin-1 and ETA receptor expression in vascular smooth muscle cells from human placenta: a new ETA receptor messenger ribonucleic acid is generated by alternative splicing of exon 3. *J Clin Endocrinol Metab* 82:3116–3123
628. Hatae N, Aksentijevich N, Zemkova HW, Kretschmannova K, Tomic M, Stojilkovic SS 2007 Cloning and functional identification of novel endothelin receptor type A isoforms in pituitary. *Mol Endocrinol* 21:1192–1204
629. Hori S, Komatsu Y, Shigemoto R, Mizuno N, Nakanishi S 1992 Distinct tissue distribution and cellular localization of two messenger ribonucleic acids encoding different subtypes of rat endothelin receptors. *Endocrinology* 130:1885–1895
630. Stojilkovic SS, Iida T, Merelli F, Catt KJ 1991 Calcium signaling and secretory responses in endothelin-stimulated anterior pituitary cells. *Mol Pharmacol* 39:762–770
631. Kanyicska B, Lerant A, Freeman ME 2001 Endothelin-like

- immunoreactivity in lactotrophs, gonadotrophs, and somatotrophs of rat anterior pituitary gland are affected differentially by ovarian steroid hormones. *Endocrine* 14: 263–268
632. Kanyicska B, Livingstone JD, Freeman ME 1995 Long term exposure to dopamine reverses the inhibitory effect of endothelin-1 on prolactin secretion. *Endocrinology* 136: 990–994
633. Samson WK, Skala KD 1992 Comparison of the pituitary effects of the mammalian endothelins: vasoactive intestinal contractor (endothelin- β , rat endothelin-2) is a potent inhibitor of prolactin secretion. *Endocrinology* 130:2964–2970
634. Samson WK 1992 The endothelin-A receptor subtype transduces the effects of the endothelins in the anterior pituitary gland. *Biochem Biophys Res Commun* 187:590–595
635. Kanyicska B, Freeman ME 1993 Characterization of endothelin receptors in the anterior pituitary gland. *Am J Physiol* 265:E601–E608
636. Millan MJ, Marin P, Bockaert J, la Cour CM 2008 Signaling at G-protein-coupled serotonin receptors: recent advances and future research directions. *Trends Pharmacol Sci* 29:454–464
637. Ciranna L, Mougnot D, Feltz P, Schlichter R 1993 Serotonin inhibits Ca²⁺ currents in porcine melanotrophs by activating 5-HT_{1C} and 5-HT_{1A} receptors. *J Physiol* 463: 17–38
638. Balsa JA, Sánchez-Franco F, Pazos F, Lara JI, Lorenzo MJ, Maldonado G, Cacicedo L 1998 Direct action of serotonin on prolactin, growth hormone, corticotropin and luteinizing hormone release in cocultures of anterior and posterior pituitary lobes: autocrine and/or paracrine action of vasoactive intestinal peptide. *Neuroendocrinology* 68:326–333
639. Lamberts SW, MacLeod RM 1978 The interaction of the serotonergic and dopaminergic systems on prolactin secretion in the rat. The mechanism of action of the “specific” serotonin receptor antagonist, methysergide. *Endocrinology* 103:287–295
640. Chartrel N, Tonon MC, Lamacz M, Vaudry H 1993 Adenosine inhibits α -melanocyte-stimulating hormone release from frog pituitary melanotrophs via an A1 receptor subtype negatively coupled to adenylate cyclase. *Ann NY Acad Sci* 680:470–472
641. Yu WH, Kimura M, Walczewska A, Porter JC, McCann SM 1998 Adenosine acts by A1 receptors to stimulate release of prolactin from anterior-pituitaries in vitro. *Proc Natl Acad Sci USA* 95:7795–7798
642. Kumari M, Buckingham JC, Poyser RH, Cover PO 1999 Roles for adenosine A1- and A2-receptors in the control of thyrotrophin and prolactin release from the anterior pituitary gland. *Regul Pept* 79:41–46
643. Dorflinger LJ, Schonbrunn A 1985 Adenosine inhibits prolactin and growth hormone secretion in a clonal pituitary cell line. *Endocrinology* 117:2330–2338
644. Delahunty TM, Cronin MJ, Linden J 1988 Regulation of GH3-cell function via adenosine A1 receptors. Inhibition of prolactin release, cyclic AMP production and inositol phosphate generation. *Biochem J* 255:69–77
645. Mollard P, Guérineau N, Chiavaroli C, Schlegel W, Cooper DM 1991 Adenosine A1 receptor-induced inhibition of Ca²⁺ transients linked to action potentials in clonal pituitary cells. *Eur J Pharmacol* 206:271–277
646. Mei YA, Vaudry H, Cazin L 1994 Inhibitory effect of adenosine on electrical activity of frog melanotrophs mediated through A1 purinergic receptors. *J Physiol* 481:349–355
647. Mei YA, Le Foll F, Vaudry H, Cazin L 1996 Adenosine inhibits L- and N-type calcium channels in pituitary melanotrophs. Evidence for the involvement of a G protein in calcium channel gating. *J Neuroendocrinol* 8:85–91
648. Bowery NG 1993 GABAB receptor pharmacology. *Annu Rev Pharmacol Toxicol* 33:109–147
649. Purisai MG, Sands SA, Davis TD, Price JL, Chronwall BM 2005 GABAB receptor subunit mRNAs are differentially regulated in pituitary melanotrophs during development and detection of functioning receptors coincides with completion of innervation. *Int J Dev Neurosci* 23:315–326
650. Buzzi M, Bemelmans FF, Roubos EW, Jenks BG 1997 Neuroendocrine γ -aminobutyric acid (GABA): functional differences in GABAA versus GABAB receptor inhibition of the melanotrope cell of *Xenopus laevis*. *Endocrinology* 138:203–212
651. Kimura F, Jinnai K, Funabashi T 1993 A GABAB-receptor mechanism is involved in the prolactin release in both male and female rats. *Neurosci Lett* 155:183–186
652. Rey-Roldán EB, Bianchi MS, Bettler B, Becu-Villalobos D, Lux-Lantos VA, Libertun C 2006 Adenohypophyseal and hypothalamic GABA B receptor subunits are downregulated by estradiol in adult female rats. *Life Sci* 79:342–350
653. Vanecek J, Klein DC 1993 A subpopulation of neonatal gonadotropin-releasing hormone-sensitive pituitary cells is responsive to melatonin. *Endocrinology* 133:360–367
654. Vanecek J, Klein DC 1992 Sodium-dependent effects of melatonin on membrane potential of neonatal rat pituitary cells. *Endocrinology* 131:939–946
655. Vanecek J, Klein DC 1992 Melatonin inhibits gonadotropin-releasing hormone-induced elevation of intracellular Ca²⁺ in neonatal rat pituitary cells. *Endocrinology* 130: 701–707
656. Zemkova H, Vanecek J 2001 Dual effect of melatonin on gonadotropin-releasing-hormone-induced Ca(2+) signaling in neonatal rat gonadotropes. *Neuroendocrinology* 74: 262–269
657. Zemková H, Vanecek J 2000 Differences in gonadotropin-releasing hormone-induced calcium signaling between melatonin-sensitive and melatonin-insensitive neonatal rat gonadotropes. *Endocrinology* 141:1017–1026
658. Zemková H, Vaněček J 1997 Inhibitory effect of melatonin on gonadotropin-releasing hormone-induced Ca²⁺ oscillations in pituitary cells of newborn rats. *Neuroendocrinology* 65:276–283
659. Silva AP, Cavadas C, Grouzmann E 2002 Neuropeptide Y and its receptors as potential therapeutic drug targets. *Clin Chim Acta* 326:3–25
660. Hill JW, Urban JH, Xu M, Levine JE 2004 Estrogen induces neuropeptide Y (NPY) Y1 receptor gene expression and responsiveness to NPY in gonadotrope-enriched pituitary cell cultures. *Endocrinology* 145:2283–2290
661. Shangold GA, Miller RJ 1990 Direct neuropeptide Y-induced modulation of gonadotrope intracellular calcium transients and gonadotropin secretion. *Endocrinology* 126:2336–2342
662. Kongsamut S, Shibuya I, Uehara M, Douglas WW 1993

- Melanotrophs of *Xenopus laevis* do respond directly to neuropeptide-Y as evidenced by reductions in secretion and cytosolic calcium pulsing in isolated cells. *Endocrinology* 133:336–342
663. **Valentijn JA, Vaudry H, Kloas W, Cazin L** 1994 Melanostatin (NPY) inhibited electrical activity in frog melanotrophs through modulation of K⁺, Na⁺ and Ca²⁺ currents. *J Physiol* 475:185–195
664. **Waters SM, Krause JE** 2000 Distribution of galanin-1, -2 and -3 receptor messenger RNAs in central and peripheral rat tissues. *Neuroscience* 95:265–271
665. **Fathi Z, Cunningham AM, Iben LG, Battaglino PB, Ward SA, Nichol KA, Pine KA, Wang J, Goldstein ME, Iismaa TP, Zimanyi IA** 1997 Cloning, pharmacological characterization and distribution of a novel galanin receptor. *Brain Res Mol Brain Res* 51:49–59
666. **Wang S, He C, Hashemi T, Bayne M** 1997 Cloning and expressional characterization of a novel galanin receptor. Identification of different pharmacophores within galanin for the three galanin receptor subtypes. *J Biol Chem* 272:31949–31952
667. **Florén A, Land T, Langel U** 2000 Galanin receptor subtypes and ligand binding. *Neuropeptides* 34:331–337
668. **Wang S, Hashemi T, He C, Strader C, Bayne M** 1997 Molecular cloning and pharmacological characterization of a new galanin receptor subtype. *Mol Pharmacol* 52:337–343
669. **Cai A, Bowers RC, Moore Jr JP, Hyde JF** 1998 Function of galanin in the anterior pituitary of estrogen-treated Fischer 344 rats: autocrine and paracrine regulation of prolactin secretion. *Endocrinology* 139:2452–2458
670. **Todd JF, Small CJ, Akinsanya KO, Stanley SA, Smith DM, Bloom SR** 1998 Galanin is a paracrine inhibitor of gonadotroph function in the female rat. *Endocrinology* 139:4222–4229
671. **Hsieh KP, Martin TF** 1992 Thyrotropin-releasing hormone and gonadotropin-releasing hormone receptors activate phospholipase C by coupling to the guanosine triphosphate-binding proteins Gq and G11. *Mol Endocrinol* 6:1673–1681
672. **Mau SE, Witt MR, Saermark T, Vilhardt H** 1997 Substance P increases intracellular Ca²⁺ in individual rat pituitary lactotrophs, somatotrophs, and gonadotrophs. *Mol Cell Endocrinol* 126:193–201
673. **Evans JJ, Catt KJ** 1989 Gonadotrophin-releasing activity of neurohypophysial hormones: II. The pituitary oxytocin receptor mediating gonadotrophin release differs from that of corticotrophs. *J Endocrinol* 122:107–116
674. **Tabak J, Gonzalez-Iglesias AE, Toporikova N, Bertram R, Freeman ME** 2010 Variations in the response of pituitary lactotrophs to oxytocin during the rat estrous cycle. *Endocrinology* 151:1806–1813
675. **Mau SE, Saermark T, Vilhardt H** 1997 Cross-talk between cellular signaling pathways activated by substance P and vasoactive intestinal peptide in rat lactotroph-enriched pituitary cell cultures. *Endocrinology* 138:1704–1711
676. **Whitelaw CM, Robinson JE, Chambers GB, Hastie P, Padmanabhan V, Thompson RC, Evans NP** 2009 Expression of mRNA for galanin, galanin-like peptide and galanin receptors 1–3 in the ovine hypothalamus and pituitary gland: effects of age and gender. *Reproduction* 137:141–150
677. **Wynick D, Small CJ, Bacon A, Holmes FE, Norman M, Ormandy CJ, Kilic E, Kerr NC, Ghatei M, Talamantes F, Bloom SR, Pachnis V** 1998 Galanin regulates prolactin release and lactotroph proliferation. *Proc Natl Acad Sci USA* 95:12671–12676
678. **Moore Jr JP, Cai A, Maley BE, Jennes L, Hyde JF** 1999 Galanin within the normal and hyperplastic anterior pituitary gland: localization, secretion, and functional analysis in normal and human growth hormone-releasing hormone transgenic mice. *Endocrinology* 140:1789–1799
679. **Acs Z, Barna I, Koenig JI, Makara GB** 1997 Age-dependent muscarinic stimulation of β -endorphin secretion from rat neurointermediate lobe in vitro. *Brain Res Bull* 44:719–725
680. **Corcuff JB, Guérineau NC, Mariot P, Lussier BT, Mollard P** 1993 Multiple cytosolic calcium signals and membrane electrical events evoked in single arginine vasopressin-stimulated corticotrophs. *J Biol Chem* 268:22313–22321
681. **Link H, Dayanithi G, Föhr KJ, Gratzl M** 1992 Oxytocin at physiological concentrations evokes adrenocorticotropin (ACTH) release from corticotrophs by increasing intracellular free calcium mobilized mainly from intracellular stores. Oxytocin displays synergistic or additive effects on ACTH-releasing factor or arginine vasopressin-induced ACTH secretion, respectively. *Endocrinology* 130:2183–2191
682. **Tse A, Tse FW** 1998 α -Adrenergic stimulation of cytosolic Ca²⁺ oscillations and exocytosis in identified rat corticotrophs. *J Physiol* 512:385–393
683. **Armstrong J, Childs GV** 1997 Changes in expression of epidermal growth factor receptors by anterior pituitary cells during the estrous cycle: cyclic expression by gonadotropes. *Endocrinology* 138:1903–1908
684. **Jabbour HN, Boddy SC, Lincoln GA** 1997 Pattern and localisation of expression of vascular endothelial growth factor and its receptor flt-1 in the ovine pituitary gland: expression is independent of hypothalamic control. *Mol Cell Endocrinol* 134:91–100
685. **Aguado F, Majó G, Gómez de Aranda I, Ferrer I** 1998 Trk neurotrophin receptor family immunoreactivity in rat and human pituitary tissues. *Neurosci Lett* 243:13–16
686. **Shah BH, Catt KJ** 2004 Matrix metalloproteinases in reproductive endocrinology. *Trends Endocrinol Metab* 15:47–49
687. **Onofri C, Theodoropoulou M, Losa M, Uhl E, Lange M, Arzt E, Stalla GK, Renner U** 2006 Localization of vascular endothelial growth factor (VEGF) receptors in normal and adenomatous pituitaries: detection of a non-endothelial function of VEGF in pituitary tumours. *J Endocrinol* 191:249–261
688. **Ben-Jonathan N, Chen S, Dunckley JA, LaPensee C, Kansra S** 2009 Estrogen receptor- α mediates the epidermal growth factor-stimulated prolactin expression and release in lactotrophs. *Endocrinology* 150:795–802
689. **Kowarik M, Onofri C, Colaco T, Stalla GK, Renner U** 2010 Platelet-derived growth factor (PDGF) and PDGF receptor expression and function in folliculostellate pituitary cells. *Exp Clin Endocrinol Diabetes* 118:113–120
690. **Berridge MJ, Irvine RF** 1989 Inositol phosphates and cell signalling. *Nature* 341:197–205
691. **Taylor CW, Genazzani AA, Morris SA** 1999 Expression of inositol trisphosphate receptors. *Cell Calcium* 26:237–251

692. Marchant JS, Taylor CW 1997 Cooperative activation of IP3 receptors by sequential binding of IP3 and Ca²⁺ safeguards against spontaneous activity. *Curr Biol* 7:510–518
693. Mellor H, Parker PJ 1998 The extended protein kinase C superfamily. *Biochem J* 332:281–292
694. Miyawaki A, Llopis J, Heim R, McCaffery JM, Adams JA, Ikura M, Tsien RY 1997 Fluorescent indicators for Ca²⁺ based on green fluorescent proteins and calmodulin. *Nature* 388:882–887
695. Hofer AM, Schulz I 1996 Quantification of intraluminal free [Ca] in the agonist-sensitive internal calcium store using compartmentalized fluorescent indicators: some considerations. *Cell Calcium* 20:235–242
696. Berridge MJ 1997 Elementary and global aspects of calcium signalling. *J Physiol* 499:291–306
697. Hinkle PM, Nelson EJ, Ashworth R 1996 Characterization of the calcium response to thyrotropin-releasing hormone in lactotrophs and GH cells. *Trends Endocrinol Metab* 7:370–374
698. Carew MA, Mason WT 1995 Control of Ca²⁺ entry into rat lactotrophs by thyrotrophin-releasing hormone. *J Physiol* 486:349–360
699. Leong DA, Thorner MO 1991 A potential code of luteinizing hormone-releasing hormone-induced calcium ion responses in the regulation of luteinizing hormone secretion among individual gonadotropes. *J Biol Chem* 266:9016–9022
700. Mollard P, Kah O 1996 Spontaneous and gonadotropin-releasing hormone-stimulated cytosolic calcium rises in individual goldfish gonadotrophs. *Cell Calcium* 20:415–424
701. Bertram R, Sherman A 2004 Filtering of calcium transients by the endoplasmic reticulum in pancreatic β -cells. *Biophys J* 87:3775–3785
702. Arredouani A, Henquin JC, Gilon P 2002 Contribution of the endoplasmic reticulum to the glucose-induced [Ca²⁺]_i(c) response in mouse pancreatic islets. *Am J Physiol Endocrinol Metab* 282:E982–E991
703. Gilon P, Arredouani A, Gailly P, Gromada J, Henquin JC 1999 Uptake and release of Ca²⁺ by the endoplasmic reticulum contribute to the oscillations of the cytosolic Ca²⁺ concentration triggered by Ca²⁺ influx in the electrically excitable pancreatic B-cell. *J Biol Chem* 274:20197–20205
704. Mollard P, Dufy B, Vacher P, Barker JL, Schlegel W 1990 Thyrotropin-releasing hormone activates a [Ca²⁺]_i-dependent K⁺ current in GH3 pituitary cells via Ins(1,4,5)P₃-sensitive and Ins(1,4,5)P₃-insensitive mechanisms. *Biochem J* 268:345–352
705. Gollasch M, Haller H, Schultz G, Hescheler J 1991 Thyrotropin-releasing hormone induces opposite effects on Ca²⁺ channel currents in pituitary cells by two pathways. *Proc Natl Acad Sci USA* 88:10262–10266
706. Gollasch M, Kleuss C, Hescheler J, Wittig B, Schultz G 1993 Gi₂ and protein kinase C are required for thyrotropin-releasing hormone-induced stimulation of voltage-dependent Ca²⁺ channels in rat pituitary GH3 cells. *Proc Natl Acad Sci USA* 90:6265–6269
707. Simasko SM 1991 Reevaluation of the electrophysiological actions of thyrotropin-releasing hormone in a rat pituitary cell line (GH3). *Endocrinology* 128:2015–2026
708. Stojilkovic SS, Torsello A, Iida T, Rojas E, Catt KJ 1992 Calcium signaling and secretory responses in agonist-stimulated pituitary gonadotrophs. *J Steroid Biochem Mol Biol* 41:453–467
709. Tse A, Tse FW, Hille B 1994 Calcium homeostasis in identified rat gonadotrophs. *J Physiol* 477:511–525
710. Iida T, Stojilkovic SS, Izumi S, Catt KJ 1991 Spontaneous and agonist-induced calcium oscillations in pituitary gonadotrophs. *Mol Endocrinol* 5:949–958
711. Li YX, Stojilkovic SS, Keizer J, Rinzel J 1997 Sensing and refilling calcium stores in an excitable cell. *Biophys J* 72:1080–1091
712. Li YX, Keizer J, Stojilkovic SS, Rinzel J 1995 Ca²⁺ excitability of the ER membrane: an explanation for IP₃-induced Ca²⁺ oscillations. *Am J Physiol* 269:C1079–C1092
713. Li YX, Rinzel J 1994 Equations for InsP₃ receptor-mediated [Ca²⁺]_i oscillations derived from a detailed kinetic model: a Hodgkin-Huxley like formalism. *J Theor Biol* 166:461–473
714. De Young GW, Keizer J 1992 A single-pool inositol 1,4,5-trisphosphate-receptor-based model for agonist-stimulated oscillations in Ca²⁺ concentration. *Proc Natl Acad Sci USA* 89:9895–9899
715. Sneyd J, Tsaneva-Atanasova K, Reznikov V, Bai Y, Sanderson MJ, Yule DI 2006 A method for determining the dependence of calcium oscillations on inositol trisphosphate oscillations. *Proc Natl Acad Sci USA* 103:1675–1680
716. Sherman A, Li YX, Keizer JE 2002 Whole-cell models. In: Fall CP, Marland ES, Wagner JM, Tyson JJ, eds. *Computational cell biology*. New York: Springer
717. Bezprozvanny I, Watras J, Ehrlich BE 1991 Bell-shaped calcium-response curves of Ins(1,4,5)P₃- and calcium-gated channels from endoplasmic reticulum of cerebellum. *Nature* 351:751–754
718. Iino M 1990 Biphasic Ca²⁺ dependence of inositol 1,4,5-trisphosphate-induced Ca release in smooth muscle cells of the guinea pig taenia caeci. *J Gen Physiol* 95:1103–1122
719. Tse FW, Tse A, Hille B 1994 Cyclic Ca²⁺ changes in intracellular stores of gonadotropes during gonadotropin-releasing hormone-stimulated Ca²⁺ oscillations. *Proc Natl Acad Sci USA* 91:9750–9754
720. Eberhard DA, Holz RW 1988 Intracellular Ca²⁺ activates phospholipase C. *Trends Neurosci* 11:517–520
721. Takazawa K, Lemos M, Delvaux A, Lejeune C, Dumont JE, Erneux C 1990 Rat brain inositol 1,4,5-trisphosphate 3-kinase. Ca²⁺(+)-sensitivity, purification and antibody production. *Biochem J* 268:213–217
722. Tsien RW, Tsien RY 1990 Calcium channels, stores, and oscillations. *Annu Rev Cell Biol* 6:715–760
723. Berridge MJ, Galione A 1988 Cytosolic calcium oscillators. *FASEB J* 2:3074–3082
724. Nash MS, Young KW, Challiss RA, Nahorski SR 2001 Intracellular signalling. Receptor-specific messenger oscillations. *Nature* 413:381–382
725. Babcock DF, Hille B 1998 Mitochondrial oversight of cellular Ca²⁺ signaling. *Curr Opin Neurobiol* 8:398–404
726. Friel DD, Tsien RW 1994 An FCCP-sensitive Ca²⁺ store in bullfrog sympathetic neurons and its participation in stimulus-evoked changes in [Ca²⁺]_i. *J Neurosci* 14:4007–4024
727. Werth JL, Thayer SA 1994 Mitochondria buffer physio-

- logical calcium loads in cultured rat dorsal root ganglion neurons. *J Neurosci* 14:348–356
728. **Thayer SA, Miller RJ** 1990 Regulation of the intracellular free calcium concentration in single rat dorsal root ganglion neurones in vitro. *J Physiol* 425:85–115
729. **Lee AK, Tse A** 2005 Dominant role of mitochondria in calcium homeostasis of single rat pituitary corticotropes. *Endocrinology* 146:4985–4993
730. **Kaftan EJ, Xu T, Abercrombie RF, Hille B** 2000 Mitochondria shape hormonally induced cytoplasmic calcium oscillations and modulate exocytosis. *J Biol Chem* 275:25465–25470
731. **Hehl S, Golard A, Hille B** 1996 Involvement of mitochondria in intracellular calcium sequestration by rat gonadotropes. *Cell Calcium* 20:515–524
732. **Fall CP, Keizer JE** 2001 Mitochondrial modulation of intracellular Ca²⁺ signaling. *J Theor Biol* 210:151–165
733. **Bertram R, Sherman A, Satin LS** 2007 Metabolic and electrical oscillations: partners in controlling pulsatile insulin secretion. *Am J Physiol Endocrinol Metab* 293:E890–E900
734. **Stojilkovic SS, Tomic M** 1996 GnRH-induced calcium and current oscillations in gonadotrophs. *Trends Endocrinol Metab* 7:379–384
735. **Stojilkovic SS, Rojas E, Stutzin A, Izumi S, Catt KJ** 1989 Desensitization of pituitary gonadotropin secretion by agonist-induced inactivation of voltage-sensitive calcium channels. *J Biol Chem* 264:10939–10942
736. **Linás R, Sugimori M, Silver RB** 1992 Microdomains of high calcium concentration in a presynaptic terminal. *Science* 256:677–679
737. **Stojilkovic SS, Iida T, Virmani MA, Izumi S, Rojas E, Catt KJ** 1990 Dependence of hormone secretion on activation-inactivation kinetics of voltage-sensitive Ca²⁺ channels in pituitary gonadotrophs. *Proc Natl Acad Sci USA* 87:8855–8859
738. **Rupnik M, Zorec R** 1995 Intracellular Cl[–] modulates Ca²⁺-induced exocytosis from rat melanotrophs through GTP-binding proteins. *Pflugers Arch* 431:76–83
739. **Tse FW, Tse A, Hille B, Horstmann H, Almers W** 1997 Local Ca²⁺ release from internal stores controls exocytosis in pituitary gonadotrophs. *Neuron* 18:121–132
740. **Tse A, Tse FW, Almers W, Hille B** 1993 Rhythmic exocytosis stimulated by GnRH-induced calcium oscillations in rat gonadotropes. *Science* 260:82–84
741. **Tse A, Lee AK** 2000 Voltage-gated Ca²⁺ channels and intracellular Ca²⁺ release regulate exocytosis in identified rat corticotrophs. *J Physiol* 528:79–90
742. **Lee AK** 1996 Dopamine (D₂) receptor regulation of intracellular calcium and membrane capacitance changes in rat melanotrophs. *J Physiol* 495:627–640
743. **Kasai H, Augustine GJ** 1990 Cytosolic Ca²⁺ gradients triggering unidirectional fluid secretion from exocrine pancreas. *Nature* 348:735–738
744. **Gillis KD, Mossner R, Neher E** 1996 Protein kinase C enhances exocytosis from chromaffin cells by increasing the size of the readily releasable pool of secretory granules. *Neuron* 16:1209–1220
745. **Stevens CF, Sullivan JM** 1998 Regulation of the readily releasable vesicle pool by protein kinase C. *Neuron* 21:885–893
746. **Zhu H, Hille B, Xu T** 2002 Sensitization of regulated exocytosis by protein kinase C. *Proc Natl Acad Sci USA* 99:17055–17059
747. **Netiv E, Liscovitch M, Naor Z** 1991 Delayed activation of phospholipase D by gonadotropin-releasing hormone in a clonal pituitary gonadotrope cell line (α T3-1). *FEBS Lett* 295:107–109
748. **Zheng L, Stojilkovic SS, Hunyady L, Krsmanovic LZ, Catt KJ** 1994 Sequential activation of phospholipase-C and -D in agonist-stimulated gonadotrophs. *Endocrinology* 134:1446–1454
749. **Vitale N** 2010 Synthesis of fusogenic lipids through activation of phospholipase D1 by GTPases and the kinase RSK2 is required for calcium-regulated exocytosis in neuroendocrine cells. *Biochem Soc Trans* 38:167–171
750. **Zheng L, Krsmanovic LZ, Vergara LA, Catt KJ, Stojilkovic SS** 1997 Dependence of intracellular signaling and neurosecretion on phospholipase D activation in immortalized gonadotropin-releasing hormone neurons. *Proc Natl Acad Sci USA* 94:1573–1578
751. **Cesnjan M, Zheng L, Catt KJ, Stojilkovic SS** 1995 Dependence of stimulus-transcription coupling on phospholipase D in agonist-stimulated pituitary cells. *Mol Biol Cell* 6:1037–1047
752. **Rao K, Paik WY, Zheng L, Jobin RM, Tomic M, Jiang H, Nakanishi S, Stojilkovic SS** 1997 Wortmannin-sensitive and -insensitive steps in calcium-controlled exocytosis in pituitary gonadotrophs: evidence that myosin light chain kinase mediates calcium-dependent and wortmannin-sensitive gonadotropin secretion. *Endocrinology* 138:1440–1449
753. **Turgeon JL, Waring DW** 2001 Luteinizing hormone secretion from wild-type and progesterone receptor knockout mouse anterior pituitary cells. *Endocrinology* 142:3108–3115
754. **Turgeon JL, Waring DW** 1999 Androgen modulation of luteinizing hormone secretion by female rat gonadotropes. *Endocrinology* 140:1767–1774
755. **Thomas P, Waring DW** 1997 Modulation of stimulus-secretion coupling in single rat gonadotrophs. *J Physiol* 504:705–719
756. **Turgeon JL, Kimura Y, Waring DW, Mellon PL** 1996 Steroid and pulsatile gonadotropin-releasing hormone (GnRH) regulation of luteinizing hormone and GnRH receptor in a novel gonadotrope cell line. *Mol Endocrinol* 10:439–450
757. **Hamill OP, Marty A, Neher E, Sakmann B, Sigworth FJ** 1981 Improved patch-clamp techniques for high-resolution current recording from cells and cell-free membrane patches. *Pflugers Arch* 391:85–100
758. **Tsien RY, Rink TJ, Poenie M** 1985 Measurement of cytosolic free Ca²⁺ in individual small cells using fluorescence microscopy with dual excitation wavelengths. *Cell Calcium* 6:145–157
759. **Brumback AC, Lieber JL, Angleson JK, Betz WJ** 2004 Using FM1-43 to study neuropeptide granule dynamics and exocytosis. *Methods* 33:287–294
760. **Sakmann B, Neher E** 1984 Patch clamp techniques for studying ionic channels in excitable membranes. *Annu Rev Physiol* 46:455–472
761. **Shorten PR, Robson AB, McKinnon AE, Wall DJN** 2000 CRH-induced electrical activity and calcium signaling in pituitary corticotrophs. *J Theor Biol* 206:395–405