

# Joint Problem of Power Optimal Connectivity and Coverage in Wireless Sensor Networks

Malik Magdon-Ismail, Fikret Sivrikaya, Bülent Yener

Department of Computer Science  
Rensselaer Polytechnic Institute  
Troy, NY 12180, USA  
{magdon, sivrif, yener}@cs.rpi.edu

**Abstract**—This work considers a multi-hop sensor network and addresses the problem of minimizing power consumption in each sensor node locally while ensuring two global (i.e., network wide) properties: (i) communication connectivity, and (ii) sensing coverage. A sensor node saves energy by suspending its sensing and communication activities according to a Markovian stochastic process. We show that a power level to induce a coverage radius  $\frac{w(n)}{n}$  is sufficient for connectivity provided that  $w(n) \rightarrow \infty$ . The paper presents a Markov model and its solution for steady state distributions to determine the operation of a single node. Given the steady state probabilities, we construct a non-linear optimization problem to minimize the power consumption. Simulation studies to examine the collective behavior of large number of sensor nodes produce results that are predicted by the analytical model.

**Keywords:** *Stochastic processes/Queueing theory, Mathematical programming/Optimization, Simulations*

## I. INTRODUCTION

This work considers a multi-hop sensor network which is comprised of a large number of sensor nodes communicating with RF links. We assume that sensor nodes are deployed in an ad-hoc fashion to cover a specified area with their sensing capabilities. Sensors monitor, sense and collect data from a target domain, process it and transmit the information back to the specific sites (e.g., headquarters, disaster control centers). There are many potential applications of sensor networks including military, environmental and health related areas. Although the sensor nodes communicate using wireless links, there are fundamental differences between a sensor network and other wireless ad-hoc networks. One important property of a sensor network is *redundancy*. Sensor nodes are usually densely deployed hence the underlying network has high redundancy for sensing and communications [1]. The high density can cause significant inefficiency problems leading to excessive power wastage. Sensor nodes may sense the same event

and try to report it, increasing collisions by redundant data. Collisions require re-transmissions and increase the energy consumption.

Increasing the lifetime of a sensor network is of primary importance. Although data aggregation techniques [2] can help to reduce the traffic that propagates to the control centers, they do not provide a complete solution to the problem. Coordination among sensor nodes requires synchronization based on either a global time reference (e.g. GPS) or clock synchronization algorithms. While equipping each sensor node with a GPS is a possibility for the future, current solutions cannot assume a global time reference. The clock synchronization protocols are based on message (e.g., control packets) exchange [3], [4] and they are costly for sensor networks. Thus, coordination of sensor nodes must be done with local and independent (asynchronous) decisions which motivates the deployment of randomized protocols.

In this work we propose a general probabilistic Markov model in which each sensor node makes an independent decision regarding which state to be in at a given time. We illustrate the general model using a three-state model with a *transmit*, *receive/sense* and *off* state. The analysis we present can be extended to the general setting with minor modifications. A node transitions between states depending on the events that occur in its vicinity. The transitions are governed by a set of parameters. In the simplest case, every node's parameters are equal, however, this restriction can be relaxed in order to accommodate a heterogeneous environment. We are interested in determining the optimal parameters governing the probabilistic transitions of a sensor node so as to minimize power consumption locally while ensuring connectivity and coverage globally.

### A. Our Contributions

This work provides a rigorous analysis and optimization of local decisions for the operation of a sensor node.

The objective is to ensure both connectivity and coverage in the network while minimizing energy consumption at each node. The techniques presented in this work are general and can be applied to other multi-hop ad-hoc networks besides the sensor networks considered here. Furthermore the methodology can be extended to model several variants of the problem.

**Overview of Our Approach.** We model each sensor node as a probabilistic finite state automaton that transitions between various states. To illustrate, we consider a three-state automaton (transmit, sense/receive and off states). In this model a node transitions between sense/receive and off states. While in the sense state, if a sensing or receiving event occurs, then the node transitions to the transmit state, attempts to transmit the event and then transitions to the off or sensing state. In a steady state, the node will visit each of its states according to its steady state distribution. How often every node is in the sensing state determines whether the network is globally connected and whether the area is covered, i.e., whether an arbitrary sensing event will be sensed. We develop sufficient conditions under which the network is connected AND the area is covered. We define connectivity and coverage jointly by requiring that an event at ANY location has a “feasible path” to ANY other location. Further, the energy consumption of the nodes depends on their steady state distribution. We present a methodology to minimize this power consumption while still maintaining the global coverage and connectivity. Our approach is to solve a constrained optimization problem, whose solution defines the local behavior of a node. We name this approach the *Connectivity Assuring Randomized Energy-Saving* (CARES) algorithm.

We assume that the sensor nodes are uniformly distributed in the unit torus and that each node has a sensing radius,  $r_S$  and a transmission radius,  $r_T$  – usually  $r_T \gg r_S$ . We also assume that the sensing events are distributed according to a uniform distribution at each time step. This means that the probability for a node to sense an event is a constant, independent of the node position. Thus, all the nodes will approach the same steady state distribution. We develop the non-linear equations that describe the steady state distribution under the mean-field approximation. Using a fixed point iterative algorithm, we solve these equations to obtain the steady state distribution. Given this steady state distribution, we can compute the energy consumption, which is a function of the transition probabilities of the Markov model. Minimizing the energy with respect to the parameters, we obtain a local, energy minimizing randomized protocol.

If the distribution of events is not uniform, then the

analysis will change. For example, if the event distribution is constant over two regions, then there will be three types of steady state nodes, one for each region and one for the border between regions. Such complications do not change the general methodology, and so we focus on the simple model for expository purposes.

### Related Work

In one of the pioneering works on energy saving in wireless networks, the authors in [9] report that leaving the network interface (NI) idle consumes as much energy as reception. They argue that power aware MAC and transport level protocols should be used. Furthermore [9] reports that it is not the number of packets but the duration of the sending period that correlates with the energy usage. The authors also note that (i) most of the energy is spent while idling, and (ii) in order to decrease the energy consumption the NI should be turned off.

In [10] the authors present two routing protocols BECA and AFECA which have a Markov Model with sleeping, listening and active states. In BECA the sojourn times of the nodes are deterministic. In AFECA they are adaptive, the sleeping time being a random variable that depends on the number of neighbors the node has. The authors show (using simulations) a 50% energy saving over naive ad-hoc routing algorithms. In the simulation study (Section III) we compare our protocol to AFECA.

The GAF routing protocol in [6] aims to extend the lifetime of the network by minimizing the energy consumption and preserving connectivity at the same time. They present a 3-state transition diagram which is a simplified version of ours, and is confined to GAF (Geographic Adaptive Fidelity). Using GAF they discover the locations of redundant nodes. GAF simply imposes a virtual grid on the network. If in any of the grid squares there are more than one node, the redundant nodes are turned off. They also use a protocol called CEC (Cluster-based Energy Conservation) which further eliminates redundant nodes by clustering them. The authors show 40-60% energy saving over other ad-hoc routing algorithms.

While the above approaches address the power control problem at the network layer, the third class of approaches aim to enhance the MAC layer [5], [11], [8]. For example, in [11] the authors propose a modification of the 4-way handshake procedure in the IEEE802.11 protocol for power saving.

In [5] the authors present a MAC protocol PAMAS which saves energy by powering off radios that overhear transmission. PAMAS is a hybrid MAC protocol and provides 10–50% savings.

In [12] the authors propose a MAC protocol for sensor networks in which nodes go into periodic listen and sleep cycles so as to reduce the energy consumption. The sleep and listen periods are implemented using timers. Neighboring nodes listen and go to sleep at the same time thus the scheme requires synchronization among the neighbors. The authors show that the proposed MAC protocol consumes 2-6 times less energy than IEEE 802.11.

In [7] the authors present a distributed randomized algorithm SPAN where each node makes a decision on its own, based on the amount of available energy and the number of its neighbors. Each node either sleeps (802.11 Power Saving mode) or becomes a coordinator (part of the networking backbone). Coordinators forward the messages they receive from the other nodes. A node which has a message to send automatically becomes a coordinator. SPAN is built on the top of 802.11 and it uses both MAC and routing layer protocols to make decisions.

While GAF [6] and SPAN [7] are distributed approaches with coordination among neighbors, in ASCENT a node decides locally whether to be on or off [8].

The pioneering work in [13] provided the first asymptotic results relating the power level to the connectivity. The authors showed, using percolation theory, that in order to have connectivity in a network with randomly placed nodes, the ratio of the number of neighbors to the total number of nodes should be  $(\log n + c)/n$  where  $c$  should go to infinity asymptotically.

In [14] the authors propose an algorithm to adjust the power level in order to ensure a minimum degree constraint on each node. In [15] a similar degree constraint is enforced to ensure a bound on the end-to-end throughput. In [16] COMPOW protocol and its architecture are discussed.

In [17] the authors consider the coverage problem and use Voronoi diagrams generated with delaunay triangulation to calculate the coverage of the network.

Recently, in [18], the joint problem of coverage and connectivity is considered using a grid of sensors each of which can probabilistically fail. The authors find the necessary and sufficient conditions for connectivity and coverage in this type of a sensor network. The main result in [18] is that within the transmission radius the number of active nodes should be a logarithm of the total number of nodes, for the network to have connectivity and coverage. They also show that the diameter of the network is of order  $\sqrt{n/\log n}$ . They cover the network area with disks and use the argument that each disk should contain at least one active node for coverage and

connectivity.

### Organization of the Paper

In the next section we present the model of the sensor network and analyze its steady state behavior including its global connectivity and coverage properties. We formulate power conservation as an optimization problem. In Section III we compare the theoretical analysis with the simulation of sensor networks as well as with AFECA. We end with some concluding remarks in Section IV.

## II. ANALYSIS AND OPTIMIZATION

There are four components to this section. First we discuss the Markov chain that governs the behavior of an individual node. Then we discuss how the properties of this Markov chain affect the connectivity and coverage of the sensor network system. We then discuss optimizing with respect to the parameters of the Markov chain so as to maximize the life time of the sensor network system, or other parameters. Finally, extensions and generalization of the presented approach are investigated in more detail.

### A. The Markov Model

Each node is a three-state Markov chain. The three states are the *off*, **O**, the *sense/receive*, **S**, and the *transmit*, **T**, states. Consider a node. Its transition matrix depends on the state of its environment. The environment of a node can be in one of two states: either a sense/receive event is occurring or no such event is occurring. The Markov state diagram in each of these cases is given below, along with the Markov transition probability matrices,  $\mathbf{M}$  when there is an event and  $\bar{\mathbf{M}}$  when there is no event.

Notice that when a sensing event occurs, the node will always transition to the transmit state. This requirement can be relaxed. There is also an ambiguity if both sensing and receiving events occur. In this case, we can require that the node always attempts to transmit the sensed event rather than the received event. At time  $t$ , there is some probability that the node is in each of its three states. Denote  $p_o, p_s, p_T$  as the respective probabilities of finding the node in the off, sensing/receiving and transmit states, and collect these three probabilities into the vector  $\mathbf{p}(t) = [p_o(t), p_s(t), p_T(t)]$ . Let  $P_E$  be the probability that there is an event. Then the state probabilities for the node at time  $t + 1$  are given by

$$\mathbf{p}(t + 1) = \mathbf{p}(t)[P_E\mathbf{M} + (1 - P_E)\bar{\mathbf{M}}]. \quad (1)$$

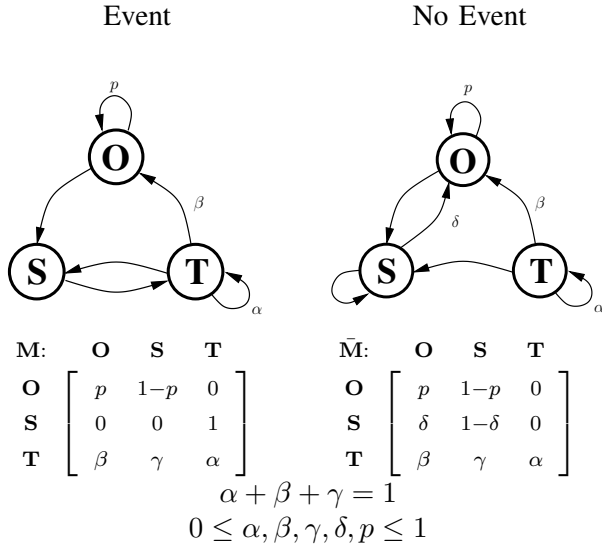

Fig. 1. Markov state diagram and transition probability matrices for CARES

Since an event can be either sensing or receiving, the probability of an event will depend on the probability that a single neighbor is transmitting. We now suppose that the system has equilibrated to a steady state, in which  $\mathbf{p}(t+1) = \mathbf{p}(t) = \mathbf{p}^s$ . We also make the mean field approximation that all the neighbors of the node are in the same steady state and can be treated as independent, in which case we can compute  $P_E$  as follows. Let  $P_{SE}$  be the probability of a sensing event and let  $P_{RE}$  be the probability of a receiving event.  $P_{SE}$  will be related to the sensing radius and the sensing event density.  $P_{RE}$  is the probability that exactly one of the node's neighbors is transmitting. We will assume to a first order approximation that the state probabilities for the neighbors are independent. In this case, if there are  $K$  neighbors, then  $r_K = Kp_T(1-p_T)^{K-1}$ . Note that if the transmit radius is  $r_T$ , then assuming that the disks are in the unit torus, the probability that a node is within transmitting range of our node is  $\pi r_T^2$ , and  $K$  has a Binomial distribution  $\mathbf{P}[K] = B(K; n-1, \pi r_T^2)$ , where  $B(K; N, p) = \binom{N}{K} p^K (1-p)^{N-K}$ . Multiplying  $P_{RE}$  by  $\mathbf{P}[K]$  and summing over  $K$ , we finally arrive at the following expression for  $P_{RE}$ :

$$P_{RE} = (n-1)\pi r_T^2 p_T (1 - \pi r_T^2 p_T)^{n-2}. \quad (2)$$

Notice that  $P_{RE}$  is a function of  $p_T$ . Since the sensing and receiving events are independent,  $P_E = \mathbf{P}[\text{sense or receive}] = P_{SE} + P_{RE} - P_{SE}P_{RE}$ . We can now use this expression for  $P_E$  to solve (1) for the steady state probabilities  $\mathbf{p}^s$ , which leads to the following set

of non-linear equations.

$$\begin{aligned} \mathbf{p}^s &= \mathbf{p}^s [P_E \mathbf{M} + (1 - P_E) \bar{\mathbf{M}}], \\ P_E &= P_{SE} + (n-1)(1 - P_{SE})c(1-c)^{n-2}, \\ 1 &= \mathbf{p} \cdot \mathbf{1} = p_O + p_S + p_T. \end{aligned} \quad (3)$$

where  $c = \pi r_T^2 p_T$  and  $\mathbf{1}$  is a vector of ones. Had  $P_E$  been a constant independent of  $\mathbf{p}$ , it is well known from the theory of finite state Markov chains that a steady state set of probabilities exists, [22]. It turns out that the introduction of this non-linearity does not change the situation.

*Theorem 1:* The set of non-linear steady state equations for  $\mathbf{p}^s$  given in (3) has at least one solution.

*Proof:* Let  $\mathbf{Q}(\mathbf{p}) = [P_E(\mathbf{p})\mathbf{M} + (1 - P_E(\mathbf{p}))\bar{\mathbf{M}}]$  as defined in (3).  $\mathbf{Q}(\mathbf{p})$  is a transition matrix, i.e.,  $Q_{ij} \geq 0$  and  $\sum_j Q_{ij} = 1$  for all  $i$ . Let  $\mathcal{X}$  be the  $m$ -dimensional probability simplex,

$$\mathcal{X} = \{\mathbf{x} : x_i \geq 0, \sum_i x_i = 1\}.$$

$\mathcal{X}$  is compact, and  $f(\mathbf{p}) = \mathbf{Q}(\mathbf{p})^T \mathbf{p}$  maps  $\mathcal{X}$  onto itself.  $P_E(\mathbf{p})$  is a polynomial in  $\mathbf{p}$ , and hence is continuous. Thus,  $f(\mathbf{p})$  is a continuous mapping. Thus the conditions to apply the Brouwer fixed point theorem are satisfied for  $f(\mathbf{p})$  [23], and so  $f(\mathbf{p})$  has a fixed point. ■

While we have hidden the dependence up to now, we explicitly note here that  $\mathbf{p}^s$  is a function of  $\alpha, \beta, \delta, p$  and continue with this dependence being understood.

## B. Connectivity and Coverage

Here we will discuss the coverage and connectivity properties of the system of sensors. There are already some results regarding these issues in the literature, and we add one more that is appealing on account of its elementary probabilistic derivation. Existing results for coverage and connectivity have also dealt with various forms of random graphs ranging from various types of disk graphs, [13], [18], [20], to Bernoulli graphs, [19], to percolation processes, [21].

We assume that the  $n$  sensors are well approximated by points independently and uniformly distributed in the unit torus,  $T = [0, 1] \times [0, 1]$ , where the opposite edges are identified. We use a torus to avoid unnecessary complications due to edge effects. Similar results would hold for the square, with only minor additional technicalities. Let  $r_s$  be the sensing radius and let  $r_T$  be the transmitting radius.

1) *Coverage:* We first consider coverage. We assume that the system has equilibrated to its steady state, and that every node can be treated as independent to first order, with state probabilities given by  $\mathbf{p}^s$ . A point

$\mathbf{x} \in T$  is covered if there is a node in the sensing state within  $r_s$  of  $\mathbf{x}$ . In this case, an event that occurs at  $\mathbf{x}$  will be detected. Thus, the probability that a given node is sensing and within  $r_s$  of  $\mathbf{x}$  is  $\pi r_s^2 p_s$ . Under the independence assumption, the probability that no node can sense an event at  $\mathbf{x}$  is then given by  $(1 - \pi r_s^2 p_s)^n$ , which is the probability that  $\mathbf{x}$  is not covered. Define the coverage function by,

$$f(\mathbf{x}) = \begin{cases} 1 & \mathbf{x} \text{ is not covered,} \\ 0 & \mathbf{x} \text{ is covered.} \end{cases} \quad (4)$$

Then,  $\mathbf{P}[f(\mathbf{x}) = 1] = (1 - \pi r_s^2 p_s)^n$ . Let  $A$  be the area that is not covered, then

$$A = \int d\mathbf{x} f(\mathbf{x}) \quad (5)$$

and so  $E[A] = \int d\mathbf{x} \mathbf{P}[f(\mathbf{x}) = 1] = (1 - \pi r_s^2 p_s)^n$ . Thus we see that the expected area covered is  $1 - E[A] = 1 - (1 - \pi r_s^2 p_s)^n$ , which, after using the fact that  $\log(1 - x) \leq -x$  for  $x < 1$ , leads to the following proposition:

*Proposition 2:* Let  $\pi r_s^2 p_s = \omega(n)/n$ . Then, the expected coverage is given by

$$1 - \left(1 - \frac{\omega(n)}{n}\right)^n \geq 1 - e^{-\omega(n)},$$

(Note:  $\omega(n)/n \leq 1$ .)

Thus, as long as  $\omega(n) \rightarrow \infty$ , the expected coverage approaches 1.  $\omega(n)$  can be interpreted as the expected power used by the sensing nodes. In order to get a concentration result on the coverage, we will use a second moment method, and compute  $\text{var}(A)$ , to which end we would need  $E[A^2]$ . We use the mean field approximation that our nodes are acting independently in the mean field environment of the neighbors. Then, using a second moment method, we have that

*Theorem 3:* Let  $r_s \leq \frac{1}{2\sqrt{2}}$ . Then, for any  $\epsilon > 0$ ,

$$\mathbf{P}[A \geq 2e^{-\frac{(1-\epsilon)}{10\pi}\omega(n)}] < \frac{2\pi \exp\left(-\frac{\epsilon\omega(n)}{5\pi} + \Theta\left(\frac{1}{\omega(n)}\right)\right)}{\omega(n) \left(1 + \Theta\left(\frac{1}{\omega(n)}\right)\right)},$$

where  $\omega(n) = n\pi r_s^2 p_s$ .

*Proof:* We give a proof sketch, and the proof in the appendix. First we observe that the coverage by squares inscribed in the disks cannot be more than the coverage by the disks. Thus it will suffice to show that the coverage by these inscribed squares is large. Proposition 2 gives the expected coverage. We will show that the variance of this coverage goes to zero sufficiently fast so that the actual coverage will not deviate too much from the expectation. The variance is given by a double integral over two two dimensional variables. We compute

this integral as a finite summation, and then bound the variance by bounding this summation. Once we have bound the variance, we can use the Markov inequality to bound the probability of a large deviation from the expected value, and this leads to the result claimed. ■  $\omega(n)$  can be interpreted as the expected total power expended by the sensing nodes. It should be no surprise that as the total sensing power approaches infinity, the coverage approaches 1 not only in expected value, but also with high probability. Theorem 3 also gives a lower bound on the rate at which it approaches one. If  $\omega(n) = \log n + \log \log n + \omega'(n)$  where  $\omega'(n) \rightarrow \infty$ , then it is also the case that  $\mathbf{P}[A = 0] \rightarrow 1$ , [20]. The faster  $\omega(n)$  grows, the faster the convergence to complete coverage. However, this also means that the power consumption at all the nodes will be larger.

2) *Connectivity:* We present here two possible notions of connectivity for a sensor network. The first considers only the topology of the connectivity graph that can be derived from the sensor network. The second is a more stringent condition that also considers contention issues in the network. The existing results use the first definition, which is the tradition we will continue with for the most part, however we will present some heuristics for addressing the second requirement of connectivity. The goal of connectivity can be summarized as follows. Suppose a sensing event fires at some position  $\mathbf{x} \in T$ , and we wish to transmit this occurrence of this event to  $\mathbf{y} \in T$ . We would like to be able to successfully transmit this occurrence with high probability for any  $\mathbf{x}, \mathbf{y}$ . The situation is illustrated below.

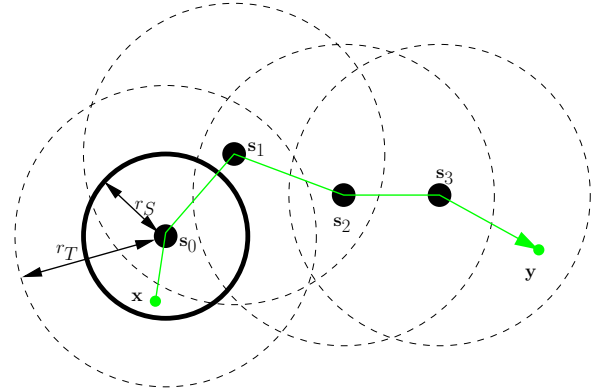

A *path* exists from  $\mathbf{x}$  to  $\mathbf{y}$  if there is a sequence of nodes in the receiving state (which is the same as the sensing state for us) at locations  $\mathbf{s}_0, \mathbf{s}_1, \dots, \mathbf{s}_K$  such that

- P1:  $\|\mathbf{x} - \mathbf{s}_0\| \leq r_s$  ( $\mathbf{x}$  can be sensed);
- P2:  $\|\mathbf{s}_i - \mathbf{s}_{i-1}\| \leq r_T$  for  $i = 1 \dots K$ , hence the event can be transmitted from  $\mathbf{s}_{i-1}$  to  $\mathbf{s}_i$ , and it will be received since  $\mathbf{s}_i$  is in the receiving state); and
- P3:  $\|\mathbf{s}_K - \mathbf{y}\| \leq r_T$  ( $\mathbf{s}_K$  can transmit to  $\mathbf{y}$ ).

We will say that the path above is a  $K$ -hop path. The network is *path connected* if for any  $\mathbf{x}, \mathbf{y}$ , there exists such a path connecting  $\mathbf{x}$  to  $\mathbf{y}$ . Notice that while we have required the existence of this path, we have not required that the path be contention free. In other words, when  $\mathbf{s}_0$  transmits to  $\mathbf{s}_1$ , it must be that  $\mathbf{s}_1$  is in the sensing state *and* no other node that is within transmission range of  $\mathbf{s}_1$  is also attempting to transmit, and similarly for every link  $\mathbf{s}_{i-1}, \mathbf{s}_i$  in the path. If there exists such a contention free path for any  $\mathbf{x}, \mathbf{y}$ , then we say that the sensor network is *transmission connected*. Note that our notions of connectivity implicitly embed the fact that the network covers the area as well. We will focus mostly on path connectivity.

We see that in order to have  $\mathbf{x}$  covered, the sensing nodes need to cover the area with respect to  $r_s$ . However, to guarantee that  $\mathbf{y}$  can be reached, it is necessary that the sensing nodes cover the area with respect to  $r_T$  as well. Thus it suffices to apply the results of the previous section on coverage with  $r_s$  replaced by  $r = \min\{r_s, r_T\}$ . This leads to the following result.

*Proposition 4:* Let  $A'$  be the area that cannot be transmitted to and let  $A$  be the area not covered. Then, for any  $\epsilon > 0$ .

$$\mathbf{P}[A \cup A' \leq 2e^{-\frac{(1-\epsilon)}{10\pi}\omega'(n)}] \geq 1 - O\left(\frac{e^{-\frac{\epsilon}{5\pi}\omega'(n)}}{\omega'(n)}\right),$$

where  $\omega'(n) = n\pi r^2 p_s$ .

*Proof:* The claim follows from Theorem 3 and the observation that if  $r_s \leq r_T$ , then  $A \cup A' \subseteq A$ , otherwise  $A \cup A' \subseteq A'$ . ■

Thus, we see that the coverage results should imply conditions P1 and P3 of path connectivity. We now consider requirement P2. For this requirement, it is sufficient that the disk graph obtained by taking disks with radii  $r_T$  centered at the sensing nodes be connected. Such results were developed in [13] for the case where  $n$  nodes are uniformly scattered on  $T$ , each having radius  $r(n)$ . The minor complication here is that while  $n$  nodes are scattered in our situation, only about  $np_s$  of them are sensing. In [13], the following result is proved.

*Theorem 5 ([13]):* The probability that the random disk graph is connected asymptotically approaches 1 if and only if  $\pi r^2(n) = (\log n + c(n))/n$  where  $c(n) \rightarrow \infty$ .

It is also known that in grid-disk graphs, with unreliable nodes, the results are very similar to the random node placement [18], and in this case it is known that the number of hops required (or the diameter of the graph) is of order  $\sqrt{n/\log n}$ . We expect that such results should hold in our case as well. For our case, the intuition is that we can apply these results with  $n$  replaced by the

number of sensing nodes,  $n_s$ . Thus we have the following theorem,

*Theorem 6:* Let  $r(n) = \min\{r_s(n), r_T(n)\}$ , and for any  $0 < \epsilon < 1$ , let  $n_s(\epsilon) = (1 - \epsilon)np_s$ . Let  $C$  be the area that is path connected. If

- (i)  $\pi r^2(n)np_s \rightarrow \infty$ , and
- (ii)  $\pi r^2(n)n_s(\epsilon) = \log(n_s(\epsilon)) + c(n_s(\epsilon));$

$$\lim_{m \rightarrow \infty} c(m) = \infty,$$

then for any  $\eta > 0$ ,  $\lim_{n \rightarrow \infty} \mathbf{P}[|C| \geq 1 - \eta] = 1$ .

(Note: (i) implies that  $np_s \rightarrow \infty$ .)

*Proof:* We give the proof in the appendix. ■

While we can provide sufficient conditions under which the graph is path connected, let us note here some of the limitations of this result. The first is the assumption of independence of the nodes (the mean field theory approximation). This is not strictly true, since the probability that a node is in the transmit state (say) will be dependent on whether one of its neighbors was in the transmit state one time step earlier, and so the current state of neighboring nodes will exhibit a weak dependence which we have ignored. The extent to which this dependence will affect the analysis will be investigated in the simulations. The second limitation is of course that while there may exist a path, it may not be usable due to contention.

To address the contention, we need to look at the transmission connectivity of the network. However, introducing the constraint that there is no contention along the path introduces significant dependence among the nodes. As a result, analysis is difficult, and we present a heuristic which we refer to as  $\rho$ -flooding. We require that in the event that a node needs to transmit a message, the expected number of recipients will be given by  $\rho > 1$ .

In such a scenario, it is easy to see that the particular message will rapidly flood through the network. In fact, we can expect the message to spread exponentially fast. Since there are  $n_s$  nodes, we can expect that in order of  $\log n_s / \log \rho$  time steps, every member in the network will have received the message. If we simply use  $\rho$ -flooding, the contention in the network will become uncontrollable. To alleviate this problem, we would need to also implement a safety mechanism to prevent such over flooding – one approach might be to bound the maximum number of hops a packet is allowed to make. This can be implemented in practice by adding to each packet a hop counter, and setting its maximum allowed value appropriately. Two possibilities are  $\log E[n_s] / \log \rho$ , the time we expect it takes to flood the whole network, or  $\sqrt{n_s / \log n_s}$ , the expected diameter of the network, [18]. The requirement of  $\rho$ -flooding sets constraints on the allowable parameters in the Markov model, which is what we derive here.

Let's consider the situation when a node is in the transmission state, and let  $\sigma$  be any one of the other  $n-1$  nodes. Let  $Q$  be the probability that you successfully transmit the packet to  $\sigma$  given that  $\sigma$  is within transmission range. Let  $P_{suc}$  be the probability to successfully transmit the packet to  $\sigma$ , then  $P_{suc} = \pi r_T^2 Q$ . To achieve successful transmission given that  $\sigma$  is within transmission range, either the first try was successful, or the first try was not successful, and some try after the first try was successful. Since the process is Markov and since the nodes are independent, the probability that some try after the first one is successful (given that you remain in the transmit state) is also  $Q$ . Let  $Q_1$  be the probability that you were successful on the first try given that  $\sigma$  is within transmission range. Since the probability to remain transmitting is  $\alpha$ , we have that  $Q = Q_1 + (1 - Q_1)\alpha Q$ , or that

$$Q = \frac{Q_1}{1 - \alpha + \alpha Q_1}. \quad (6)$$

Suppose that  $\sigma$  has  $K$  neighbors. Then you are successful on the first try if  $\sigma$  is in the sensing state and no other neighbor of  $\sigma$  is transmitting, which occurs with probability  $p_s(1-p_T)^K$ . Multiplying by  $P(K)$ , summing over  $K$  using the fact that  $K$  has a Binomial distribution  $B(K; n-2, \pi r_T^2)$ , we arrive at  $Q_1 = p_s(1 - \pi r_T^2 p_T)^{n-2}$ . Since there are  $n-1$  nodes to whom you could transmit, the expected number of successful transmissions is given by  $(n-1)P_{suc}$ . Requiring that the expected number of successful transmissions is  $\rho$  then leads to the following constraint,

*Proposition 7:* In order to achieve  $\rho$ -flooding, the following condition must be satisfied,

$$\rho = \frac{(n-1)\pi r_T^2 p_s (1 - \pi r_T^2 p_T)^{n-2}}{1 - \alpha + \alpha p_s (1 - \pi r_T^2 p_T)^{n-2}} \quad (7)$$

### C. Optimizing The Power Consumption

The main goal of this paper is to develop a systematic approach for power conservation in sensor networks. The idea is to select the available parameters in the Markov model so as to minimize the power consumption, while at the same time guaranteeing coverage and connectivity. Accomplishing this involves solving a constrained optimization problem, which we solve numerically, the details being given in the Simulation section.

We assume that the power consumption in each of the three states is given by  $\lambda_o, \lambda_s, \lambda_T$ . Suggested values for these parameters have been given in the literature, [9]. For our purposes, we assume that these are externally supplied parameters, or functional forms that may depend on  $r_s, r_T$ . The expected power consumption per

node in steady state is then given by  $E = \lambda_o p_o + \lambda_s p_s + \lambda_T p_T$ . In order to guarantee path connectivity and coverage, it is sufficient to enforce the conditions in Theorem 6. We are thus led to the following optimization problem:

OPT1: Let  $f_1(n), f_2(n)$  be any two functions that approach infinity in the asymptotic limit, for example  $\log n$  or  $n^a$ . Let  $0 < \epsilon < 1$ .

$$\text{minimize } \lambda_o p_o + \lambda_s p_s + \lambda_T p_T, \\ \alpha, \beta, p, \delta$$

subject to the constraints

$$0 \leq \alpha, \beta, p, \delta \leq 1$$

$$\alpha + \beta \leq 1$$

$$\pi r^2 n p_s \geq f_1(n)$$

$$\pi r^2 n_s(\epsilon) = \log(n_s(\epsilon)) + f_2(n_s(\epsilon))$$

where  $r = \min\{r_s, r_T\}$  and  $n_s(\epsilon) = (1-\epsilon)np_s$ . Here  $n$  and the sensing event density are given, from which  $P_{SE}$ , the probability of sensing an event can be calculated.  $p_o, p_s, p_T$  are the solutions to the steady state equations, (3), which depend on the parameters.

$f_1(n)$  and  $f_2(n)$  can be chosen so that the connectivity and coverage converge to 1 at the desired rate. In order to enforce transmission connectivity, one can incorporate the additional constraint given in Proposition 7. After this constraint has been incorporated, and the power consumption minimized, one can use the additional heuristic of a maximum number of hops to avoid over-flooding the sensor network.

### D. Extensions

There are a number of ways in which the general methodology we have presented may be extended, the most immediate is to consider different Markov models. We have presented a relatively simple Markov model for the state diagram of a single sensor node. We list below several other interesting models. The analysis of these models follows virtually identical lines to the model we have presented, the main difference being the introduction of additional parameters and/or states in the Markov chain of a sensor. The only change in the form of the steady state equations (3) may be a change in the dimensionality of the system and the constant matrices  $\mathbf{M}$  and  $\bar{\mathbf{M}}$ . Otherwise, the entire methodology remains intact, including the constraints for connectivity and coverage. Thus we will not follow through on most of the details, and we leave the further theoretical development and experimental investigation of these models as avenues for future work.

a) *Off/Sensing–Receive–Transmit*: In the state diagram for this Markov model, we combine the off state with the sensing state, and receiving occurs in a separate state. Otherwise, it is very similar to the model we have been describing. This model is basically the model that was used in [10]. We mention it here to demonstrate how their model fits within the general methodology we have developed here. While in [10], the authors develop some reasonably good parameters for the latency times in each state, in the present framework, one can optimize these parameters while at the same time enforcing connectivity and coverage. Figure 2 illustrates the model.

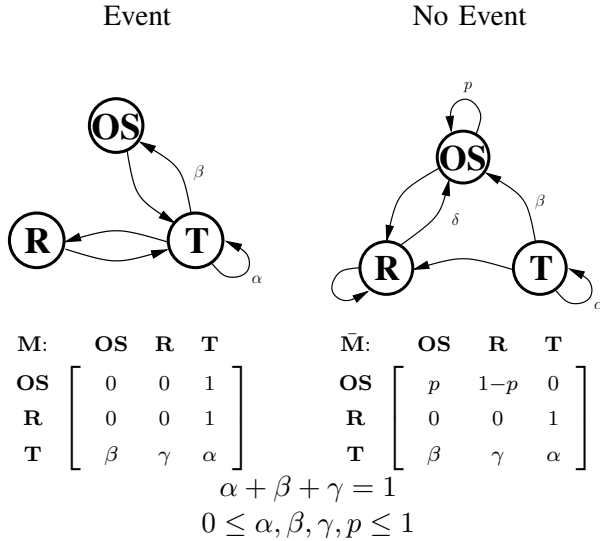

Fig. 2. Off/Sensing–Receive–Transmit

b) *Off–Sensing–Receive–Transmit*: Here, we have a separate state for each of the four possible activities. One possible advantage of this setup is that the asymmetry between sensing and receiving may allow one to preferentially treat one of these events and pay less attention to the other. In fact one could have two classes of nodes, those with a preference for **S** over **R** and those with a preference for **R** over **S**. In this way, one could have “separately” functioning sensing and listening networks. While the analysis to take into account two types of nodes in the ensemble of nodes is slightly more complex, it follows the same general approach. The main difference is that the connectivity would be defined with respect to the “listening” network, and the coverage would be defined with respect to the “sensing” network. Figure 3 illustrates the model.

c) *Back-off*: This is a technique that can be used with any of the previous models and we illustrate this concept here with our original model. The idea is to allow the transmit state one more alternative rather than simply continue transmitting or exit transmitting. One

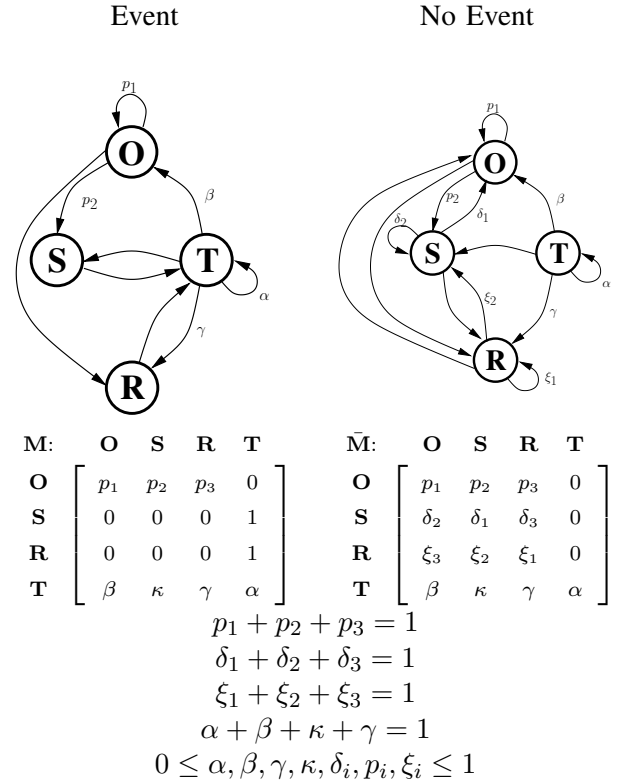

Fig. 3. Off–Sensing–Receive–Transmit.

also allows transmission to “pause” or back-off into the back-off state where the node holds the item to be transmitted, but is not creating contention. Such a model may allow for better contention management. Figure 4 illustrates the model.

### III. SIMULATION STUDY

In this section we basically verify our theoretical analysis by a simulation study. We first describe our methodology to numerically solve the optimization problem, OPT1, given in section II-C. Having solved OPT1 for a given set of parameters, we obtain the optimal values for  $\alpha, \beta, p, \delta$ , which we then feed into the simulation. The simulation program basically takes these transition probabilities as input and then simulates the behavior of each node using our Markov model. We describe the simulation program in more detail later in this section. In the last part of this section we present the numerical results; first demonstrating that the simulation results conform to those of theory regarding the steady-state probabilities, and then showing that the connectivity and coverage is still maintained throughout the network while nodes save energy by turning themselves off according to our Markov model. We also compare our CARES protocol to the similar AFECA protocol in terms of energy savings.



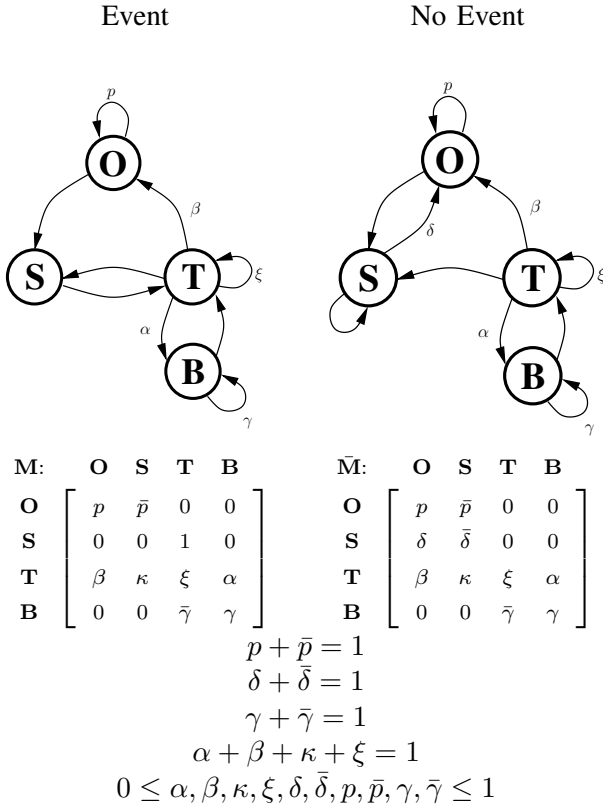

Fig. 4. Back-off

In order to solve the optimization problem described in Section II-C, we first need to solve the Markov model formulation, i.e. find the steady-state probabilities, given transition parameters  $\alpha, \beta, p, \delta$ . We use a numerical technique to do so since it is hard to get an exact algebraic solution to the Markov formulation. Starting from an arbitrary initial state, we iteratively apply equation (3) to find the steady-state probabilities. Next, we use Matlab's constrained minimization function `fmincon` (available in Matlab optimization toolbox [25]) as our optimizer –to solve OPT1. Given a specific network scenario, with an instantiation of  $n, r_T, r_s$  and  $P_{SE}$ , the optimizer returns the Markov model design which minimizes per node power consumption.

The simulation is implemented as follows. We place  $n$  sensor nodes and  $m$  event nodes uniformly at random in a unit torus. The number of event nodes could be some value sufficiently large so that they represent most of the coverage area as possible event locations. For all results presented throughout this section, we set  $m = 1000$ . Moreover, for the simplicity of presentation, we use a common value  $r$  for the transmission and sensing radius, i.e. we set  $r_T = r_s = r$ . At each time step, each event node independently fires an event with probability  $q$ . Note that given  $q$ , the probability that a node senses an event can be calculated as  $P_{SE} = 1 - (1 - q\pi r_s^2)^m$ ,

which is the probability of having at least one active event node in a circle of radius  $r_s$ . Hence given  $P_{SE}$ , we solve for  $q$  to obtain the event firing probability to be used for the simulation;

$$q = \frac{1 - (1 - P_{SE})^{1/m}}{\pi r_s^2}.$$

If an event node fires at some time step, we say that the event node is *active*. All sensor nodes that are in the vicinity of (at most  $r$  units away from) an active event node and that are in the *sense/receive* state sense this event. A node which senses some event at time step  $t$  broadcasts a packet at time step  $t + 1$  (after a transition to the *transmit* state). Instead of assuming a routing protocol on the top, we let each node forward an event that it receives –either a sensing event, or a message received from a neighbor. However, if a node  $u$  receives messages from two or more neighbors at the same time, we assume that those destructively interfere and  $u$  does not forward any messages. Hence some of the packets may be dropped out. This way, we mimic the travelling of packets throughout the network, and ensure that the network does not get heavily loaded with the generation of new events.

Each sensor node follows the Markov model given in figure 1 where the transition probabilities  $\alpha, \beta, p, \delta$  are obtained by the solution of OPT1 and fed into the simulation program. We expect that after certain amount of time, the ratio of the time a node spends in each state will be roughly the same as the steady-state probabilities obtained by theoretical analysis. Moreover, we expect –with high probability– that the connectivity and coverage throughout the network will be maintained at each time step.

We run the simulation for 10,000 discrete time steps and collect statistics at every 100th time step, which we call a *breakpoint*. The statistics collection at each breakpoint consists of updating the steady-state probabilities, and checking for coverage and connectivity. We use a sliding window of size 500 time steps for the steady state-probabilities, which is slid by 100 time steps at every breakpoint. The steady-state probability for each state is calculated as the percentage of time spent in that state throughout the 500 time steps in the window. The *coverage* at breakpoint  $t$  is calculated as the percentage of event nodes that are covered by a sensor node in *sense/receive* state. In other words, at time  $t$ , we check for each event node if there is at least one sensor node in its neighborhood that is in the *sense/receive* state. The overall coverage value is an average over all coverage percentages calculated at every breakpoint. On the other hand, the *connectivity* at time  $t$  can be either 0 or 1.

At each breakpoint  $t$ , we construct a graph induced on the vertices corresponding to all nodes that are in the *sense/receive* state at  $t$ . Then we check if the resulting graph is connected; if so, the connectivity at  $t$  is 1, and 0 otherwise. The overall connectivity value is the average over all these instantaneous connectivity values, i.e. the percentage of breakpoints at which the network is connected.

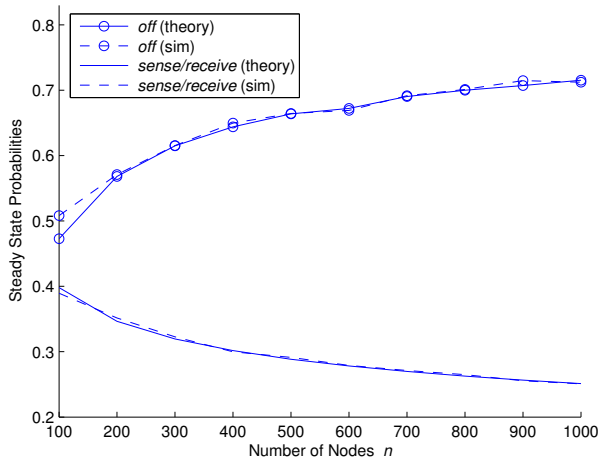

Fig. 5. The steady-state probabilities for different network sizes. The transmission/sensing radius is kept constant at  $r = 0.2$  and the sensing event probability at  $P_{SE} = 0.1$ . The probabilities for *off* state ( $p_o$ ) and *sense/receive* state ( $p_s$ ) are shown only, since the *transmit* state probability is simply  $p_T = p_o - p_s$ .

Figure 5 compares the steady-state probabilities calculated by theoretical analysis and simulation study. The network size is varied from 100 to 1000, and the transmission/sensing radius and the sensing event probability are kept constant as  $r = 0.2$  and  $P_{SE} = 0.1$ , respectively. These results show that the mean field theory and independence assumptions work well in practice. It is not surprising to observe that the sensor nodes remain more and more in the *off* state as the network gets denser –i.e. as the number of nodes increases for a fixed  $r$ .

Figure 6 presents the simulation results for the connectivity and coverage figures using the same set of parameters as in Figure 5. We observe that the overall connectivity and coverage is well maintained especially with the increasing number of nodes. Note that the number of nodes in the *off* state increases as the network size increases (see Figure 5). However the Markov model parameters obtained by the optimizer ensures that the number of *sensing* nodes is high enough so that the connectivity and coverage is maintained with high proba-

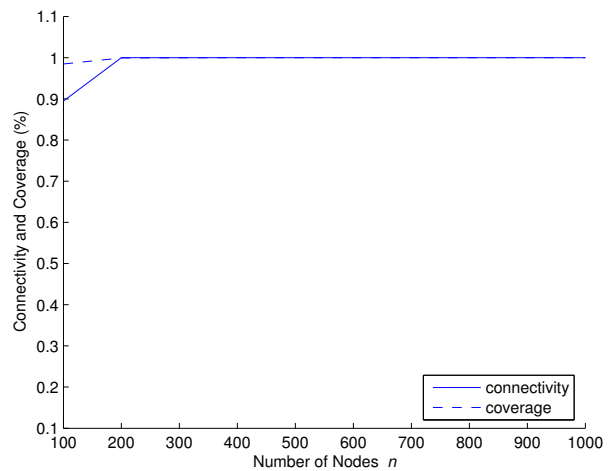

Fig. 6. The connectivity and coverage figures obtained by simulation on networks of different sizes. The transmission/sensing radius is kept constant at  $r = 0.2$  and the sensing event probability at  $P_{SE} = 0.1$ .

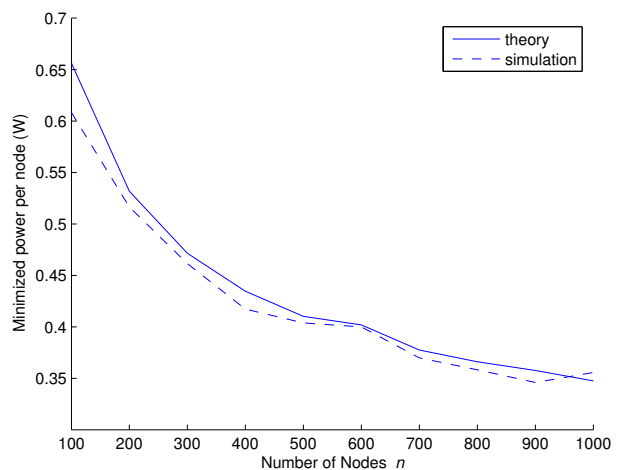

Fig. 7. Minimized power per node, computed using the steady-state probabilities from Figure 5. The transmission/sensing radius is kept constant at  $r = 0.2$  and the sensing event probability at  $P_{SE} = 0.1$ .

bility –asymptotically with probability 1. This theoretical expectation is justified by the simulation results of Figure 6.

Figure 7 demonstrates the power savings by the optimized Markov model. As the network gets denser, increasingly many nodes may be in the *off* state at any time, and hence the power expended per node decreases. The theoretical and experimental results agree on supporting this argument.

We also compare the steady state probabilities of CARES for theory and simulation by varying the sens-

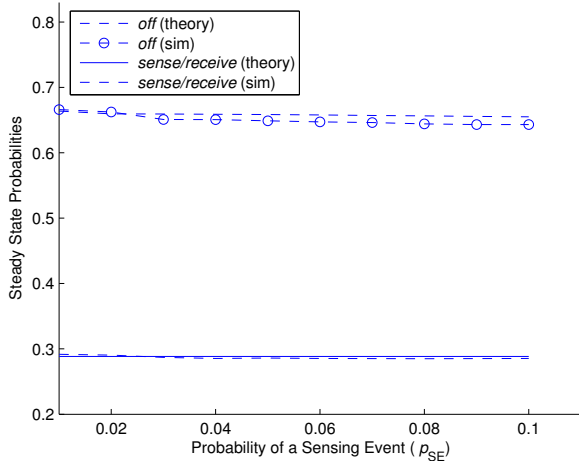

Fig. 8. The steady-state probabilities for different values of sensing event probability, for a network of  $n = 500$  nodes and transmission/sensing radius  $r = 0.2$ .

ing event probability, and keeping the network size and density constant. In Figure 8, it may first seem interesting to note that CARES does not react much to the changes in the event density. The reason is that the constrained optimization ensures that enough nodes are in the *sense/receive* state to ensure connectivity and coverage, regardless of the event density. Thus, the steady state probabilities for the *sense/receive* state does not change much, but as more events are generated, nodes will spend more time in the *transmit* state, hence less time in the *off* state.

We now compare our approach to a similar work, the AFECA protocol [10], in terms of energy savings. AFECA is proposed as an add-on for any underlying routing protocol, and its energy-savings is presented on the AODV protocol by a simulation study in [10]. In AFECA nodes are in one of the three states: *sleeping*, *listening* and *active*. In the *sleeping* state, the radio of a node is turned off for energy savings, but the sensors or other parts of the node may be on. The *listening* state corresponds to our *sense/receive* state, i.e. the node can sense events and receive messages. The *active* state is used to transmit any available data. The main difference of AFECA is that instead of using probabilistic transitions, a node stays in a state for a certain duration and then transitions to another state, as long as there is no interrupt in this duration, such as a sensing event.

The state diagram for AFECA is shown in Figure 9. Starting in the *sleeping* state, node  $i$  may transition into the *active* state if there is a sensing event to be transmitted. Otherwise, if no such event happens in

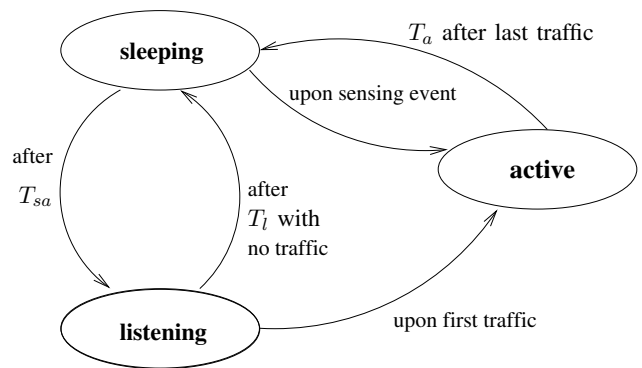

Fig. 9. States and transitions in AFECA

$T_{sa}$  seconds, then it transitions to the *listening* state, where  $T_{sa}$  depends on the number of neighbors of  $i$  –to take advantage of higher node density for more energy savings. More specifically,  $T_{sa} = \text{Random}(1, N_i) \times T_s$ , where  $N_i$  is the number of neighbors of  $i$ , and  $T_s$  is a global parameter of AFECA. While in *listening* state,  $i$  can sense events and forward any received traffic, in which case it transitions to the *active* state. If no such event happens in  $T_l$  seconds then it transitions to the *sleeping* state. Whenever  $i$  goes into the *active* state, it stays so for at least  $T_a$  seconds; if at any time it has not sent or forwarded data in time  $T_a$ , it transitions to the *sleeping* state. Clearly, the performance of AFECA depends on the parameters  $T_s$ ,  $T_l$  and  $T_a$ .

In order to compare with our CARES protocol, we also implement AFECA with the optimal parameters ( $T_s = 10$  sec,  $T_l = 10$  sec and  $T_a = 60$  sec) given in [10]. Note that by varying the event firing probability and allowing the packets to be forwarded and occasionally dropped as described earlier, we mimic the behavior of some random routing protocol each time we run the simulation. Similar to the approach we take for the evaluation of CARES, we compute the ratio of time a node spends in each state of AFECA. We then compute the power consumption per node using these ratios. In AFECA protocol, a node does not transmit for most of the time it is in the *active* state since it stays in the *active* state for  $T_a$  more seconds after the last traffic. Hence we simply use 1.1W as the average power consumed in the *active* state of AFECA, which is a lower bound on the actual value. (Actual value is between 1.1W and 1.6W, and much closer to 1.1W.)

We observe that the AFECA protocol has more energy savings for very low event densities, hence we provide the results for a wide range of values for the sensing event probability. For this purpose we exponentially increase  $P_{SE}$  from  $10^{-6}$  to 0.1, and plot the power values against a logarithmic  $x$ -axis representing the sensing

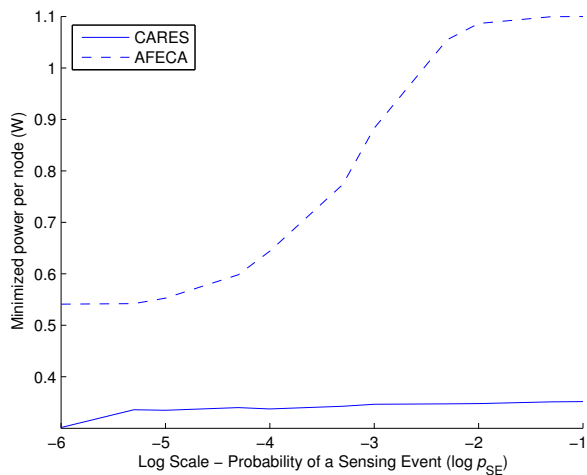

Fig. 10. Power savings for CARES and AFECA for a network of  $n = 1000$  nodes, and transmission/sensing radius  $r = 0.2$ . The probability of a sensing event is varied between  $10^{-6}$  and  $10^{-1}$ .

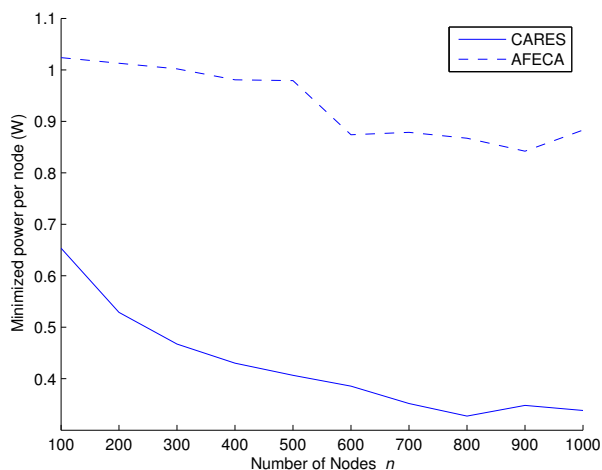

Fig. 11. Power savings for CARES and AFECA for different network sizes, with the transmission/sensing radius  $r = 0.2$  and sensing event probability  $P_{SE} = 0.001$ .

event probabilities. Figure 10 presents the results for a network of size  $n = 1000$  and transmission/sensing radius  $r = 0.2$ . The plot for CARES is shown only for theoretical results since the simulation gives almost identical results. Note that AFECA reacts too much to an increase in the event density and it may not provide any benefit in some settings where CARES can still save more than 60% in energy consumption. AFECA has deterministic parameters (except the randomized sleep periods to account for the node density), and it is not well defined how to adjust these parameters for maximum energy savings. The advantage of our approach is that it can

be optimized in a well defined way for any given settings; the constrained optimization problem OPT1 is solved for a given network size, transmission radius, sensing radius and event sensing probability. The sensing event probability can be approximated for a given application scenario. Then each sensor node can be programmed to follow the Markov model with the optimal transition parameters given as the solution of OPT1.

We also compare the energy savings of the two protocols for various network sizes and a fixed  $r$  and  $P_{SE}$ , in Figure 11. As expected, both CARES and AFECA can save more energy as the network gets denser, however CARES has about two times more energy savings than AFECA on average.

#### IV. CONCLUSIONS

In this work we presented CARES, a randomized algorithm which is run locally at a sensor node to govern its operation. Each node conserves energy by asynchronously and probabilistically turning itself off. The probabilities for staying in off, sense/receive, and transmit states ensure connectivity and coverage in the network. The problem of finding probabilities to maximize energy saving while ensuring both connectivity and coverage is expressed as an optimization problem defined by node parameters. In the simulation study, we also show that the power savings of our protocol outperforms that of the previously known protocols, by as much as an order of magnitude in some cases. In our theoretical analysis we used mean-field theory approximations which have been justified by our simulations. Future work includes extending the analysis to non-homogeneous settings.

#### REFERENCES

- [1] I. F. Akyildiz, W. Su, Y. Sankarasubramaniam, and E. Cayirci, "Wireless sensor networks: A survey," *Computer Networks*, vol. 38, no. 4, pp. 393–422, 2002.
- [2] B. Krishnamachari, D. Estrin, and S. Wicker, "Impact of data aggregation in wireless sensor networks," in *Int. Workshop on Distributed Event-Based Systems*, Vienna, Austria, July 2002.
- [3] Leslie Lamport, "Time, clocks, and the ordering of events in a distributed system," *Communications of the ACM*, vol. 21, no. 7, pp. 558–565, July 1978.
- [4] N. Lynch, *Distributed Algorithms*, Morgan Kaufmann, San Mateo CA, 1996.
- [5] S. Singh and C. S. Raghavendra, "Power efficient mac protocol for multihop radio networks," in *Nineth IEEE ISPIMRC'98*, 1998, pp. 153–157.
- [6] Y. Xu, J. Heidemann, and D. Estrin, "Geography-informed energy conservation for ad hoc networks," in *Proceedings MOBICom'01, 2001*, 2001.
- [7] B. Chen, K. Jamieson, H. Balakrishnan, and R. Morris, "Span: An energy-efficient coordination algorithm for topology maintenance in ad hoc wireless networks,," in *Proceedings of MOBICom'01, 2001*.

- [8] A. Cerpa and D. Estrin, "Ascent: Adaptive self-configuring sensor network topologies," in *Proceedings of INFOCOM'02*, 2002.
- [9] M. Stemm and R. H. Katz, "Measuring and reducing energy consumption of network interfaces in hand-held devices," *IEEE Transactions on Communications*, vol. E80-B, no. 8, pp. 1125–1131, August 1997.
- [10] Y. Xu, J. Heidemann, and D. Estrin, "Adaptive energy-conserving routing for multihop ad hoc networks," Tech. Rep. 527, USC/ISI, Los Angeles, CA, October 12 2000, <http://www.isi.edu/johnh/PAPERS/Xu00a.pdf>.
- [11] J. P. Monks, V. Bhargavan, and W. M. Hwu, "A power controlled multiple access protocol for wireless packet networks," in *Proceedings of INFOCOM'01*, 2001.
- [12] Y. Wei, J. Heidemann, and D. Estrin, "An energy-efficient mac protocol for wireless sensor networks," in *Proceedings INFOCOM 2002*, 2002, vol. 3, pp. 1567–1576.
- [13] P. Gupta and P. R. Kumar, "Critical power for asymptotic connectivity in wireless networks," in *Stochastic Analysis, Control, Optimization and Applications, A Volume in Honor of W.H. Fleming. Edited by W.M. McEneaney, G. Yin, and Q. Zhang*. 1998, pp. 547–566, Birkhauser.
- [14] R. Ramanathan and R. Rosales-Hain, "Topology control of multihop wireless networks using transmit power adjustments," in *Proc. IEEE INFOCOM'00*, 2000.
- [15] T. A. ElBatt, S. V. Krishnamurthy and D. Connors, and S. Dao, "Power management for throughput enhancement in wireless ad hoc networks," in *IEEE ICC'00*, 2000.
- [16] S. Narayanaswamy, V. Kawadia, R.S. Sreenivas, and P. R. Kumar, "Power control in ad-hoc networks: Theory, architecture, algorithm and implementation of the compow protocol," in *European Wireless Conference*, 2002.
- [17] S. Meguerdichian, F. Koushanfar, M. Potkonjak, and M. Srivastava, "Coverage problems in wireless ad-hoc sensor networks," in *Proceedings of IEEE INFOCOM'01*, 2001.
- [18] S. Shakkottai, R. Srikant, and N. Shroff, "Unreliable sensor grids: Coverage, connectivity and diameter," in *Proceedings of IEEE INFOCOM'03*, 2003.
- [19] Béla Bollobás, *Random Graphs, Second Edition*, Cambridge University Press, new york edition, 2001.
- [20] P. Hall, *Introduction to the Theory of Coverage Processes*, John Wiley & Sons, New York, 1988.
- [21] R. Meester and R. Roy, *Continuum Percolation*, Cambridge University Press, Cambridge, UK, 1996.
- [22] Paul G. Hoel, Sifney C. Port, and Charles J. Stone, *Introduction to Stochastic Processes*, Copyright ©1972 by Houghton Mifflin Company, Reissued by Waveland Press Inc., 1987, 1987.
- [23] J. Franklin, *Mathematical Methods of Economics*, Springer Verlag, New York, 1980.
- [24] Rajeev Motwani and Prabhakar Raghavan, *Randomized Algorithms*, Cambridge University Press, Cambridge, UK, 2000.
- [25] MathWorks, "Matlab: The language of technical computing," Available through <http://www.mathworks.com/>.

#### APPENDIX

**Proof of Theorem 3.** We can inscribe a square of side  $\Delta = r_s\sqrt{2}$  in a circle of radius  $r_s$ . The coverage by the disks will then be no less than the coverage by the squares. Let  $S$  be the area not covered by the squares, then  $A \leq S$ . Defining the coverage function  $f_S(\mathbf{x})$  for the squares analogously to (4), we find that  $E[S] = (1 - \Delta^2 p_s)^n$ .  $E[S^2] = \int d\mathbf{x} \int d\mathbf{y} f_S(\mathbf{x})f_S(\mathbf{y})$ . The  $f_S(\mathbf{x})f_S(\mathbf{y})$  term in the integrand is the probability

that both the points  $\mathbf{x}$  and  $\mathbf{y}$  are not covered. Let  $S_{\mathbf{z}}$  denote the square centered at the point  $\mathbf{z} \in T$ . Then the probability that both points  $\mathbf{x}$  and  $\mathbf{y}$  (in the integrand) are not covered is given by the probability that all sensing squares are outside  $S_{\mathbf{x}} \cup S_{\mathbf{y}}$ , so  $E[S^2] = \int d\mathbf{x} \int d\mathbf{y} (1 - p_s |S_{\mathbf{x}} \cup S_{\mathbf{y}}|)^n$ . In the integral, let  $\mathbf{x} = (x_1, x_2)$  and  $\mathbf{y} = (y_1, y_2)$ . If  $|x_1 - y_1| \geq \Delta$  or  $|x_2 - y_2| \geq \Delta$  then  $|S_{\mathbf{x}} \cup S_{\mathbf{y}}| = 2\Delta^2$ . Otherwise,  $|S_{\mathbf{x}} \cup S_{\mathbf{y}}| = 2\Delta^2 - (\Delta - |x_1 - y_1|)(\Delta - |x_2 - y_2|)$ . Fix  $\mathbf{x}$  in the  $\mathbf{y}$  integral. The area over which  $\mathbf{y}$  can range with  $S_{\mathbf{y}}$  disjoint from  $S_{\mathbf{x}}$  is  $1 - 4\Delta^2$ . This area thus contributes  $(1 - 4\Delta^2)(1 - 2\Delta^2)^n$  to the integral. Over the remaining area, changing coordinate in the  $\mathbf{y}$  integral so that its origin lies at  $\mathbf{x}$ , this contribution to the integral (over the area when the two squares overlap) becomes

$$I = 4 \int d\mathbf{x} \int_{0 \leq y_1, y_2 \leq \Delta} d\mathbf{y} (1 - 2p_s \Delta^2 + p_s(\Delta - y_1)(\Delta - y_2))^n.$$

A tedious but elementary computation to perform these integrals then leads to the following result, after adding the contribution from the part of the integral over the region where  $S_{\mathbf{x}}$  and  $S_{\mathbf{y}}$  are disjoint.

$$E[S^2] = (1 - 2p_s \Delta^2)^n \left( 1 + 4p_s \Delta^2 \sum_{i=1}^n \binom{n}{i} \frac{\lambda^i}{(i+1)^2} \right),$$

where  $\lambda = p_s \Delta^2 / (1 - 2p_s \Delta^2)$ . Using the facts that  $\text{var}(S) = E[S^2] - E[S]^2$  and  $E[S]^2 = (1 - 2p_s \Delta^2)^n (1 + p_s \Delta^2 \lambda)^n$ , we arrive at

$$\begin{aligned} \text{var}(A) &= (1 - 2p_s \Delta^2)^n \sum_{i=1}^n \binom{n}{i} \lambda^i \times \\ &\quad \left( \frac{4p_s \Delta^2}{(i+1)^2} - (p_s \Delta^2)^i \right), \\ &\leq 4p_s \Delta^2 (1 - 2p_s \Delta^2)^n \sum_{i=1}^n \binom{n}{i} \frac{\lambda^i}{(i+1)^2}, \\ &\leq 4p_s \Delta^2 e^{-2np_s \Delta^2} \sum_{i=1}^n \binom{n}{i} \frac{\lambda^i}{(i+1)^2}. \end{aligned}$$

Let  $F(i) = \binom{n}{i} \frac{\lambda^i}{(i+1)^2}$ , then we can bound the sum by  $n \max_i F(i)$ , so we bound  $F(i)$ .  $F(i)$  is a very sharply peaked function of  $i$ . Its maximum occurs at  $i^*$  for which  $F(i^*)/F(i^* - 1) \geq 1$  and  $F(i^* + 1)/F(i^*) < 1$ . Since  $F(i+1)/F(i) = \lambda(i+1)(n-i)/(i+1)^2$ , this condition can be solved for  $i^*$  to give  $i^* = n\lambda/(1+\lambda) + \Theta(1/n\lambda)$ . Using the fact that  $\binom{n}{i^*} \leq (en/i^*)^{i^*}$ , we get the following bound,

$$\frac{4p_s \Delta^2 \exp\left(-2n\Delta^2 p_s + \frac{n\lambda(1+\log(1+\lambda))}{1+\lambda}\right) + \Theta\left(\frac{1}{n\lambda}\right)}{\frac{n\lambda}{1+\lambda} \left(1 + \Theta\left(\frac{1}{n\lambda}\right)\right)}$$

Noting that for  $r \leq 1/2\sqrt{2}$ ,  $\Delta \leq \frac{1}{2}$ , hence,  $(1 + \log(1 + \lambda))/(1 - p_s \Delta^2) \leq 9/10$ , we get that

$$\text{var}(S) \leq \frac{4 \exp\left(-\frac{n\Delta^2 p_s}{10} + \Theta\left(\frac{1}{n\Delta^2 p_s}\right)\right)}{n\Delta^2 p_s \left(1 + \Theta\left(\frac{1}{n\Delta^2 p_s}\right)\right)}$$

Since  $n\Delta^2 p_s = \frac{2}{\pi}\omega(n)$ , we have that

$$\text{var}(S) \leq \frac{2\pi \exp\left(-\frac{\omega(n)}{5\pi} + \Theta\left(\frac{1}{\omega(n)}\right)\right)}{\omega(n) \left(1 + \Theta\left(\frac{1}{\omega(n)}\right)\right)}$$

Since  $E[S] \leq e^{-\frac{2}{\pi}\omega(n)} \leq e^{-\frac{(1-\epsilon)}{10\pi}\omega(n)}$ , we can now apply the Markov inequality to  $S$  to get

$$\mathbf{P}[S \geq 2e^{-\frac{(1-\epsilon)}{10\pi}\omega(n)}] < \frac{2\pi \exp\left(-\frac{\epsilon\omega(n)}{5\pi} + \Theta\left(\frac{1}{\omega(n)}\right)\right)}{\omega(n) \left(1 + \Theta\left(\frac{1}{\omega(n)}\right)\right)}$$

Noting that  $P[A \geq z] \leq P[S \geq z]$  for any  $z$ , we get the required bound.  $\blacksquare$

**Proof of Theorem 6.** Conditions P1 and P3 of path connectivity for a large enough area (of size  $\geq 1 - \eta$ ) are implied by condition (i) in the theorem and Proposition 4. It remains to show that the disk graph obtained from nodes in the sensing state is connected with probability 1 in the limit. Let  $n_s$  be the number of sensing nodes (randomly scattered). Then, on account of the independence assumption,  $n_s$  is a binomial random variable,  $B(n_s; n, p_s)$ .  $E[n_s] = np_s$ , and so the Chernoff bound, [24], gives  $\mathbf{P}[n_s < (1 - \epsilon)np_s] < \exp(-np_s\epsilon^2/2)$ . Since  $np_s \rightarrow \infty$ , we have that  $\mathbf{P}[n_s \geq (1 - \epsilon)\mu] \rightarrow 1$ . Let  $\mathbf{P}[P2]$  be the probability that condition P2 holds, and let  $n_s(\epsilon) = (1 - \epsilon)np_s$ . Then,

$$\mathbf{P}[P2] \geq \mathbf{P}[P2 | n_s \geq n_s(\epsilon)] \mathbf{P}[n_s \geq n_s(\epsilon)],$$

$c(n_s) = \pi r^2 n_s - \log n_s \rightarrow \infty$ , because  $n_s \geq (1 - \epsilon)np_s$  and  $np_s \rightarrow \infty$ , and so from Theorem 5, we have that  $\mathbf{P}[P2 | n_s \geq n_s(\epsilon)] \rightarrow 1$ . Since we also have that  $\mathbf{P}[n_s \geq n_s(\epsilon)] \rightarrow 1$ , we then have that  $\mathbf{P}[P2] \rightarrow 1$ . So there is a sufficiently large area for which we have that  $\mathbf{P}[P1] = 1 - e_1(n)$  for that area,  $\mathbf{P}[P2] = 1 - e_2(n)$  and  $\mathbf{P}[P3] = 1 - e_3(n)$  for that area, where  $e_i(n) \rightarrow 0$ . By the union bound,  $\mathbf{P}[\sim P1 \vee \sim P2 \vee \sim P3] \leq e_1(n) + e_2(n) + e_3(n) \rightarrow 0$ , hence we conclude that  $\mathbf{P}[P1 \wedge P2 \wedge P3] \rightarrow 1$  for a sufficiently large area, proving that the network is path connected on a sufficiently large area, with probability 1 in the asymptotic limit.