

Laboratory experiments to test relativistic gravity*

Vladimir B. Braginsky

Physics Faculty, Moscow State University, Moscow, U.S.S.R

Carlton M. Caves[†] and Kip S. Thorne

California Institute of Technology, Pasadena, California 91125

(Received 3 January 1977)

Advancing technology will soon make possible a new class of gravitation experiments: pure laboratory experiments with laboratory sources of non-Newtonian gravity and laboratory detectors. This paper proposes seven such experiments; and for each one it describes, briefly, the dominant sources of noise and the technology required. Three experiments would utilize a high- Q torque balance as the detector. They include (i) an "Ampère-type" experiment to measure the gravitational spin-spin coupling of two rotating bodies, (ii) a search for time changes of the gravitation constant, and (iii) a measurement of the gravity produced by magnetic stresses and energy. Three experiments would utilize a high- Q dielectric crystal as the detector. They include (i) a "Faraday-type" experiment to measure the "electric-type" gravity produced by a time-changing flux of "magnetic-type" gravity, (ii) a search for "preferred-frame" and "preferred-orientation" effects in gravitational coupling, and (iii) a measurement of the gravitational field produced by protons moving in a storage ring at nearly the speed of light. One experiment would use a high- Q toroidal microwave cavity as detector to search for the dragging of inertial frames by a rotating body.

I. INTRODUCTION

Until now, almost all tests of relativistic gravity in the solar system have involved probes of the gravitational fields of the Sun, the Earth, or the Moon.¹ Such probes have included light deflection and quasar radio-wave deflection by the sun, the Shapiro time delay of radio signals passing near the Sun, perihelion shifts of planetary orbits, laser ranging to the Moon in search of the Nordtvedt effect, searches for sidereal periodicities in earth tides, gravitational red-shift in the earth's gravitational field, Eötvös-Dicke experiments in the fields of the Earth and Sun, and others.²

The purpose of this paper³ is to point out that advancing technology will soon make possible a new class of experiments: pure laboratory experiments, with laboratory sources of post-Newtonian gravity and laboratory detectors. The laboratory may be earthbound, or it may be in an earth-orbiting satellite where background noise is much reduced. In either case, the experimenter's control over the source of gravity is the essential new feature in these experiments.

The key advance in technology that will make possible these new experiments is the development of sensing systems with very low levels of dissipation. In Sec. II we describe three such systems that could be used in gravitation experiments: torque-balance systems made, for example, from fused-quartz or sapphire fibers at temperatures $\leq 0.1^\circ\text{K}$, massive dielectric monocrystals cooled to millidegree temperatures, and microwave resonators with superconducting walls. In Sec.

III we briefly review the Nordtvedt-Will⁴ parametrized-post-Newtonian (PPN) formalism for comparing gravitation experiments with theory, and the types of phenomena which occur in post-Newtonian gravity; we argue that because of "noise" from Newtonian gravity, the only post-Newtonian phenomena that look promising for laboratory measurement are magnetic-type gravitation and preferred-frame and preferred-orientation effects; and we present a truncated version of the PPN formalism specially suited to the analysis of magnetic-type gravity. Section IV describes four experiments which one might perform using a sensitive torque balance: (i) a gravitational "Ampère" experiment to measure the spin-spin gravitational coupling of two laboratory bodies ("magnetic-type" gravitational effect), (ii) a search for changes with time of the gravitational constant (non-post-Newtonian experiment), (iii) an improved-precision Eötvös experiment (non-post-Newtonian experiment), and (iv) a measurement of the gravity produced by magnetic stresses and energy (non-post-Newtonian experiment). Section V describes the use of a toroidal microwave resonator to measure the dragging of inertial frames by a rotating body ("magnetic-type" gravitational effect). Section VI describes three experiments that would use cooled dielectric monocrystals: (i) a gravitational "Faraday" experiment to measure the electric-type gravity produced by a time-varying flux of magnetic-type gravity, (ii) experiments to test for the existence of a preferred reference frame and preferred orientations in the universe, and (iii) an experiment to measure the gravitational force pro-

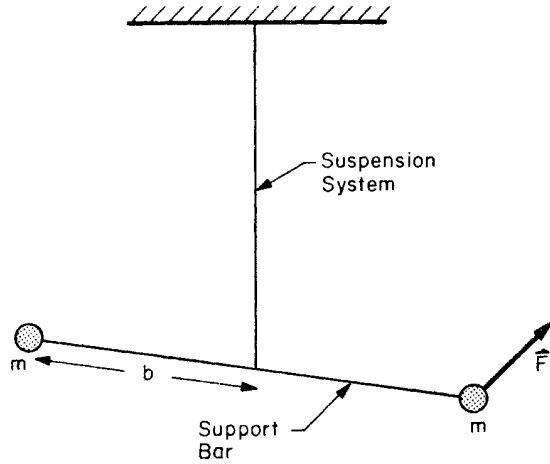

FIG. 1. A torsion oscillator with test masses m , on one of which there acts a post-Newtonian force F at right angles to the support bar. The suspension system could be a support fiber or an electric or magnetic support system with very high Q and very small restoring torque.

duced by particles moving at nearly the speed of light (non-post-Newtonian experiment).

II. SYSTEMS WITH VERY LOW DISSIPATION

A. Torsion oscillator

The typical source of a laboratory post-Newtonian gravitational field might be a mass $M \sim 10^5$ g with equatorial radius $R \sim 20$ cm, rotating with equatorial velocity $v \sim 5 \times 10^4$ cm/sec. Such a generator would produce post-Newtonian gravitational accelerations in its vicinity of magnitude

$$\left(\frac{F}{m}\right)_{\text{Brownian}} \approx \left(\frac{16kT}{m\tau^*\hat{\tau}}\right)^{1/2} \approx 1 \times 10^{-18} \text{ cm/sec}^2 \text{ if } m = 30 \text{ g, } T = 0.1 \text{ }^\circ\text{K, } \hat{\tau} = 10^6 \text{ sec, } \tau^* = 10^{13} \text{ sec.} \quad (2.3)$$

[Equation (2.3) is the Nyquist theorem in a form valid for $\tau_0 \ll \hat{\tau} \ll \tau^*$.] The parameters suggested here are all very reasonable from the viewpoint of present technology except the damping time $\tau^* = 10^{13}$ sec, which corresponds to a mechanical Q of

$$Q = \pi\tau^*/\tau_0 = 3 \times 10^9 \text{ for } \tau^* = 10^{13} \text{ sec, } \tau_0 = 10^4 \text{ sec.} \quad (2.4)$$

We expect that such damping times can be achieved within the next 2 to 5 years. Our reasons are these: (1) The present state-of-the-art result is $\tau^* \sim 10^{10}$ sec. An electrostatic suspension system

$$a_{\text{PN}} \equiv (F/m)_{\text{PN}} \approx (G \frac{1}{5} M/R^2)(v/c)^2 \approx 1 \times 10^{-17} \text{ cm/sec}^2. \quad (2.1)$$

Here F is the force that acts on a sensor, and m is its mass.

One attractive type of sensor for such a small force is a torque balance (torsion oscillator) shown in idealized form in Fig. 1. In a post-Newtonian experiment one would modulate the source of gravity at the eigenperiod τ_0 of the oscillator, thereby producing after a time $\hat{\tau} \gg \tau_0$ (but $\hat{\tau} \ll \tau^*$ \equiv damping time of oscillator) a net change in the oscillation amplitude of the masses

$$(\Delta x_0)_{\text{PN}} = \frac{(F/m)_{\text{PN}} \tau_0 \hat{\tau}}{8\pi} \approx 4 \times 10^{-9} \text{ cm if } \tau_0 \approx 10^4 \text{ sec, } \hat{\tau} \approx 10^6 \text{ sec.} \quad (2.2)$$

Such a displacement of a macroscopic mass ($m \approx 30$ g) can be detected without serious difficulty by a variety of techniques (see Sec. 2 of the book by Braginsky and Manukin,⁵ cited henceforth as BM).

The three most serious problems for a torque-balance sensor of post-Newtonian forces are fluctuational forces (Brownian noise) in the suspension system, time-varying gravity due to motion of nearby people, animals, and vehicles, and seismic "noise" at the eigenfrequency of the torque balance.

The fluctuational forces depend on the temperature T of the torque-producing suspension system, the amplitude damping time τ^* for torsion oscillations, the duration $\hat{\tau}$ over which the forces act ("measurement time"), and the mass m :

constructed by Everitt, Fairbank, and their co-workers for use on board an Earth-orbiting spacecraft has its dominant damping produced by residual gas and is estimated to have $\tau^* \geq 1 \times 10^{10}$ sec,⁶ and the tungsten-wire suspension system used by Braginsky and Panov⁷ in their 1971 room-temperature Eötvös experiment is believed to have had $\tau^* \sim 3 \times 10^9$ sec (though no attempt was made to measure it beyond setting the limit $\tau^* > 6 \times 10^7$ sec). (2) The suspension might be a fiber of fused quartz, for which losses decrease rapidly with decreasing temperature below $T \approx 10$ °K, so that it is not unreasonable to expect $\tau^* \approx 10^{13}$ sec at 0.1 °K. (3) One could use a

thin support fiber cut from a monocrystal of sapphire, for which (a) fundamental-mode oscillations of a 1 kg cylinder at $\omega_0 \approx 10^5 \text{ rad sec}^{-1}$ show $Q \approx 5 \times 10^9$ at 4.3 °K,⁸ (b) losses again decrease rapidly with decreasing temperature, (c) losses decrease with decreasing frequency, (d) losses are lower for torsion oscillations than for the measured compressional oscillations, but (e) losses will be larger for a thin fiber than for a cylinder because of larger surface-area-to-volume ratio. (4) One could use a Meissner-effect suspension

$$\tau^* \approx \left(\frac{\pi}{2\mu k T} \right)^{1/2} \frac{3m}{2nS}$$

$$\approx 1 \times 10^{13} \text{ sec for } m = 30 \text{ g, } S = 20 \text{ cm}^2, \mu = 7 \times 10^{-24} \text{ g, } T = 1 \text{ °K, } n = 1 \times 10^7 \text{ cm}^{-3} \text{ (pressure} = 10^{-12} \text{ torr)}. \quad (2.5)$$

Time-dependent gravity gradients due to the motion of nearby people, animals, and vehicles can be kept below the post-Newtonian signal by (i) using a torsion pendulum whose quadrupole and octupole coupling to gravity gradients is small, and (ii) performing the experiment in a well-isolated place, e.g., in a sealed, animal-free mine. With modest effort one could construct a torsion pendulum with the relevant quadrupole and octupole moments reduced from their usual values of $\sim mb^2$ and $\sim mb^3$, to $\sim 10^{-4}mb^2$ and $\sim 10^{-4}mb^3$, where m is the mass on each arm and b is the length of the arms. The torque-producing acceleration due to an object of mass M will be less than 10 percent of the post-Newtonian acceleration if the object is kept more distant than

$$r \gtrsim \max \left[\left(10^{-4} \frac{GMb}{0.1a_{\text{PN}}} \frac{\tau_0}{\hat{\tau}} \right)^{1/3}, \left(\frac{GMb^3}{0.1a_{\text{PN}}} \frac{\tau_0}{\hat{\tau}} \right)^{1/5} \right] \approx \max \left[(100 \text{ m}) \left(\frac{M}{10^3 \text{ kg}} \right)^{1/3}, (40 \text{ m}) \left(\frac{M}{10^3 \text{ kg}} \right)^{1/5} \right] \text{ for } b = 10 \text{ cm}. \quad (2.6)$$

The first and second terms represent the quadrupole and hexadecapole couplings, respectively, and the factor $\tau_0/\hat{\tau}$ is a bandwidth correction. Thus, for $M \lesssim 1000 \text{ kg}$, an isolation radius of a few hundred meters is adequate.

Seismic "noise" (earth vibrations) at angular frequency $\omega_0 \approx 2\pi/\tau_0$ in the bandwidth $\Delta\omega_0 \approx 1/\hat{\tau}$ will produce accelerations of the torsion oscillator that could mask the post-Newtonian signal. Because of the low frequency of the torsion oscillator, these seismic accelerations cannot be removed by a passive filtering system. The seismic motions can be resolved into floor tilt, floor rotation, horizontal motion, and vertical motion. Tilt is a problem in the case of a fiber suspension system because it displaces the test masses relative to external, spatially varying force fields (electric, magnetic, gravitational), and thereby leads to time-varying torques. Floor rotation will cause angular accelerations of the experimental apparatus that directly mimic the post-Newtonian signal. In a perfect torsion oscillator with vanishing ini-

system for which the attainable Q should be roughly comparable to that in a superconducting microwave cavity at a given frequency ω_0 ($Q \sim 10^{10}$ to 10^{12} for present state of the art⁹), and for which the Q should increase with decreasing ω_0 . (5) Damping due to residual gas in the vacuum chamber can readily be kept under control; the damping time for two spherical test masses m with a total projected area S being buffeted by gas molecules of mass μ , number density n , and temperature T would be

tial amplitude, horizontal and vertical motions would produce no torques; but in any real system such motions will couple to the oscillator through imperfections and through nonlinearities such as Coriolis and centrifugal forces.

The frequency region of interest, $\omega_0 \sim 10^{-3} \text{ rad/sec}$, lies above the frequencies of tides and below the frequencies of the Earth's normal modes. The data on Earth motions in this regime are not very reliable, and presumably the amplitude of the motions varies greatly from one location to another. If we characterize the stochastic component of the rotational, horizontal, and vertical motions by mean-square angular, strain, and acceleration amplitudes per unit angular bandwidth

$$J_{\omega}^{\text{rot}} \equiv \langle (\Delta\phi)^2 \rangle / (\text{rad sec}^{-1}), \quad (2.7a)$$

$$J_{\omega}^{\text{hor}} \equiv \langle (\Delta l/l)^2 \rangle / (\text{rad sec}^{-1}), \quad (2.7b)$$

$$J_{\omega}^{\text{vert}} \equiv \langle (\Delta g)^2 \rangle / (\text{rad sec}^{-1}), \quad (2.7c)$$

then the observational data suggest, for quiet locations,^{10,11}

$$J_{\omega}^{\text{hor}} \sim 4 \times 10^{-18} \text{ sec}(\omega/10^{-3} \text{ sec}^{-1})^{-3} \text{ for } 6 \times 10^{-6} \leq \omega \leq 6 \times 10^{-3} \text{ sec}^{-1} \quad (2.8a)$$

$$J_{\omega}^{\text{vert}} \sim 6 \times 10^{-12} \text{ sec}(\text{cm/sec}^2)^2(\omega/10^{-3} \text{ sec}^{-1})^{-2} \text{ for } 6 \times 10^{-5} \leq \omega \leq 6 \times 10^{-2} \text{ sec}^{-1}. \quad (2.8b)$$

There are no data on J_{ω}^{rot} , but it may be reasonable to assume

$$J_{\omega}^{\text{rot}} \sim J_{\omega}^{\text{hor}}. \quad (2.8c)$$

For the torsion oscillator of Fig. 1 the seismic rotations have the same effect as a sinusoidal force F acting on one of the masses m with amplitude

$$(F/m)_{\text{rot}} = 2b\omega_0^2(2\pi J_{\omega}^{\text{rot}}/\hat{\tau})^{1/2} \sim 1 \times 10^{-16} \text{ cm/sec}^2 \text{ for } b \simeq 10 \text{ cm, } \hat{\tau} \simeq 10^6 \text{ sec, } \omega_0 \simeq 10^{-3} \text{ sec}^{-1}. \quad (2.9a)$$

If μ_{hor} is the dimensionless coupling parameter between horizontal accelerations at frequency ω_0 and torque accelerations F/m , then horizontal seismic motions produce the same effect as a sinusoidal torque acceleration

$$(F/m)_{\text{hor}} = \mu_{\text{hor}}(\lambda_0/2\pi)\omega_0^2(2\pi J_{\omega}^{\text{hor}}/\hat{\tau})^{1/2} \sim 5 \times 10^{-10} \mu_{\text{hor}} \text{ cm/sec}^2 \text{ for } \lambda_0 \simeq 6000 \text{ km, } \hat{\tau} \simeq 10^6 \text{ sec, } \omega_0 \simeq 10^{-3} \text{ sec}^{-1}. \quad (2.9b)$$

Here λ_0 is a characteristic wavelength, and $\lambda_0/2\pi$ is a characteristic coherence length for the horizontal strains of Eq. (2.7b). Clearly λ_0 cannot be much larger than the radius of the Earth (the value chosen above) and it might be much smaller. If we similarly characterize the coupling to vertical seismic motions by a parameter μ_{vert} , then

$$(F/m)_{\text{vert}} = \mu_{\text{vert}}(2\pi J_{\omega}^{\text{vert}}/\hat{\tau})^{1/2} \sim 6 \times 10^{-9} \mu_{\text{vert}} \text{ cm/sec}^2 \text{ for } \hat{\tau} \simeq 10^6 \text{ sec, } \omega_0 \simeq 10^{-3} \text{ sec}^{-1}. \quad (2.9c)$$

These seismic effects appear to be huge compared to the tiny signal $(F/m)_{\text{PN}} \simeq 10^{-17} \text{ cm/sec}^2$ that one wishes to measure. However, one might be able to circumvent them by very careful construction of the apparatus to achieve $\mu_{\text{hor}} \sim \mu_{\text{vert}} \sim 10^{-6}$, together with construction of an active anti-seismic platform that reduces rotational, horizontal, and vertical motions by at least one, two, and three orders of magnitude, respectively. Tilt-induced torques might be circumvented by a combination of antiseismic platform, shielding of the torsion pendulum from external electric and magnetic fields, and adjustment of the distribution of gravitating mass in the nearby laboratory.

This discussion of seismic-induced torques is very incomplete. Any real torsion oscillator has a large number of mechanical degrees of freedom which can be excited by seismic noise, and which are coupled by nonlinearities, imperfections, and external force fields. To keep seismic-induced torques below the post-Newtonian signal, one must understand thoroughly the coupling of these degrees of freedom and bring it under control experimentally.

That one can circumvent seismic "noise" in principle follows from the fact that it is not a true noise, i.e., it is not a stochastically fluctuating force originating in a key element of the apparatus. However, its circumvention on Earth may prove so difficult in practice that one will seek the quieter environment of an Earth-orbiting laboratory.

B. Eigenvibrations of dielectric monocrystals

Accelerations at the laboratory post-Newtonian level, $(F/m)_{\text{PN}} \simeq 1 \times 10^{-17} \text{ cm/sec}^2$, should also be

measurable with massive ($m \sim 10^3$ to 10^5 g) dielectric monocrystals. Monocrystals of sapphire are particularly attractive, but quartz and others might also be suitable. In a post-Newtonian experiment one would modulate the source of gravity at an eigenperiod τ_0 of the crystal's vibrations, thereby producing after a time $\hat{\tau} \gg \tau_0$ (but $\hat{\tau} \ll \tau^*$ = damping time) a net change in the oscillation amplitude of the crystal

$$\begin{aligned} (\Delta x_0)_{\text{PN}} &\simeq \frac{(F/m)_{\text{PN}} \tau_0 \hat{\tau}}{4\pi} \\ &\simeq 5 \times 10^{-16} \text{ cm for } \tau_0 \simeq 6 \times 10^{-4} \text{ sec,} \\ &\quad \hat{\tau} \simeq 10^6 \text{ sec.} \end{aligned} \quad (2.10)$$

This amplitude change is far larger than that which will be measured ($\lesssim 10^{-17} \text{ cm}$) in the second-generation gravitational-wave antennas of the Fairbank-Hamilton group¹² and of the Braginsky group.¹³ Moreover, the eigenfrequencies in the two experiments (post-Newtonian and gravitational-wave) are the same, but in the post-Newtonian experiment one can use a much longer time ($\hat{\tau}_{\text{PN}} \simeq 10^6 \text{ sec}$) to measure the amplitude change than in the gravitational-wave experiments ($\hat{\tau}_{\text{GW}} < 1 \text{ sec}$). Thus, the measurement of the post-Newtonian amplitude changes should present no serious problems. For example, an electromagnetic-resonator sensor for displacements in which the inductance or capacitance is modulated by the crystal vibrations, would produce a fluctuational "back-action" force on the crystal itself of only (BM,⁵ Sec. 5)

$$\left(\frac{F}{m}\right)_{\text{sensor, Brownian}} \approx \frac{4}{\hat{\tau}} \left(\frac{kT_e \omega_0}{m\omega_e}\right)^{1/2} \\ \approx 4 \times 10^{-19} \text{ cm/sec}^2 \text{ for } T_e \approx 4^\circ\text{K}, \omega_e \approx 6 \times 10^{10} \text{ sec}^{-1}, \omega_0 \approx 10^4 \text{ sec}^{-1}, m \approx 10^4 \text{ g}, \hat{\tau} \approx 10^6 \text{ sec.} \quad (2.11)$$

Here T_e is the temperature of the electromagnetic sensor, ω_e is its angular frequency of oscillation, ω_0 is the angular eigenfrequency of the crystal, m is the mass of the crystal, and $\hat{\tau}$ is the measurement time. This back-action force is far smaller than the post-Newtonian force $(F/m)_{\text{PN}} \approx 1 \times 10^{-17} \text{ cm/sec}^2$.

Internal fluctuational forces in the crystal (Brownian-motion feeding of energy back and forth between various eigenmodes) have a magnitude governed by the crystal temperature T_0 , the damping time $\tau^* = \tau_0 Q / \pi$ for crystal vibrations, the time of measurement $\hat{\tau}$, and the mass of the crystal m :

$$\left(\frac{F}{m}\right)_{\text{Brownian}} \approx \left(\frac{8kT_0}{m\hat{\tau}\tau^*}\right)^{1/2} \\ \approx 2 \times 10^{-18} \text{ cm/sec}^2 \text{ if } T_0 \approx 10^{-3}^\circ\text{K}, \tau^* \approx 2 \times 10^7 \text{ sec}, m \approx 10^4 \text{ g}, \hat{\tau} \approx 10^6 \text{ sec.} \quad (2.12)$$

This fluctuating force of $2 \times 10^{-18} \text{ cm/sec}^2$ is adequately below the post-Newtonian level of $1 \times 10^{-17} \text{ cm/sec}^2$. To achieve such a small fluctuating force we envision a 10 kg monocrystal of sapphire with an eigenperiod $\tau_0 \approx 6 \times 10^{-4} \text{ sec}$, cooled to a temperature $T_0 \sim 10^{-3}^\circ\text{K}$ where its Q is $\geq 1 \times 10^{11}$, and a measurement time of $\hat{\tau} \approx 10^6 \text{ sec}$. Such an installation should be achievable within the next 2 or 3 years: (1) Monocrystals of sapphire with mass as large as 25 kg are now available commercially¹⁴; (2) Bagdasarov, Braginsky, and Mitrofanov⁸ have achieved a Q of 5×10^9 for a 1-kg sapphire with $\omega_0 = 2.1 \times 10^5 \text{ sec}^{-1}$ at $T_0 = 4.3^\circ\text{K}$; (3) the Q of this same sapphire (with no improvements in polishing or suspension) should rise rapidly with decreasing temperature (the measured increase between 77°K and 4.3°K was $Q \propto T_0^{-0.8}$); (4) more massive sapphires should have higher Q 's (one expects $Q \propto \omega_0^{-1}$ roughly); (5) the theoretical Q for a pure, dislocation-free, impurity-free, perfectly polished, free-floating sapphire crystal is

$$Q \approx (4C_p^2 \rho) / \kappa T_0 \alpha^2 \omega_0 \\ \sim 3 \times 10^{15} (T_0 / ^\circ\text{K})^{-4} (\omega_0 / 10^4 \text{ sec}^{-1})^{-1} \text{ at } T \leq 10^\circ\text{K}, \quad (2.13)$$

where ρ is the density, C_p is the specific heat at constant pressure, κ is the thermal conductivity, and α is the thermal-expansion coefficient [BM,⁵ Eq. (9.7)]; (6) cooling to millidegree temperatures can be achieved by adiabatic demagnetization of paramagnetic salts (the Fairbank-Hamilton group¹⁵ plan to use this technique to cool a metal gravitational-wave antenna with mass $m \sim 5 \times 10^6 \text{ g}$ to millidegree temperatures).

Seismic "noise" presents no serious problem for such a detector of gravitational forces. At its operating frequency ($\omega_0 \approx 10^4 \text{ sec}^{-1}$) and bandwidth

($\Delta\omega_0 \approx 10^{-6} \text{ sec}^{-1}$) one can filter out the seismic noise. This feature makes such a detector much more attractive than the low-frequency ($\omega_0 \approx 10^{-3} \text{ sec}^{-1}$) torsion oscillators of Sec. IIA.

C. Microwave resonator with superconducting mirrors

A third type of detector for post-Newtonian gravitational fields is a microwave resonator with superconducting mirrors, i.e., a superconducting cavity in which one excites electromagnetic traveling waves or standing waves. In such a detector the gravitational forces act on the electromagnetic waves, pushing them relative to the fixed walls of the cavity.

Because electromagnetic waves are not slow-motion entities (they do not have $v \ll c$), the "post-Newtonian acceleration" $a_{\text{PN}} \approx (G^{\frac{1}{2}} M / R^2)(v/c)^2 \approx 1 \times 10^{-17} \text{ cm/sec}^2$ is not a relevant concept in analyzing their response to gravity. In forthcoming papers, Caves¹⁶ analyzes in detail the interaction of a microwave resonator with gravity, and in Sec. V of this paper we shall describe an experiment which one might hope to perform using a microwave resonator.¹⁷

The key features of superconducting microwave resonators, which make them attractive for gravitation experiments, are these: (i) the very low surface resistances of their walls, $R_s \sim 10^{-8}$ to 10^{-9} ohms ,^{9,18} which leads to near-perfect reflection of electromagnetic waves,

$$1 - \mathcal{R} = R_s / 94 \text{ ohms} \\ \sim 10^{-10} \text{ to } 10^{-11} \text{ for normal incidence,} \quad (2.14)$$

where \mathcal{R} is the reflection coefficient; (ii) the resulting very high Q 's of the resonators, $Q \sim 10^{10}$ to 10^{12} for cavities excited in low modes⁹ (e.g.,

$Q = 5 \times 10^{11}$ for a TE_{011} mode with eigenfrequency 10.5 GHz, in a cylindrical niobium cavity with length and diameter 1.5 in. and temperature 1.3 °K)¹⁹; (iii) their high frequency stability, which has enabled Stein and Turneure²⁰ to construct superconducting-cavity-stabilized-oscillator clocks (SCSO) with short-term stabilities $\Delta\omega/\omega \approx 6 \times 10^{-16}$.

III. POST-NEWTONIAN GRAVITY IN THE LABORATORY

A. General remarks

In the theoretical discussion of many of our experiments (Secs. IV–VI) we shall use the Nordtvedt-Will parametrized-post-Newtonian (PPN) formalism.⁴ In this formalism gravity is described by a general-relativistic-type metric accurate to post-Newtonian order. The metric contains eleven unknown, dimensionless constants called “PPN parameters” and denoted $\gamma, \beta, \alpha_1, \alpha_2, \alpha_3, \xi_1, \xi_2, \xi_3, \xi_4, \xi_w, \eta$. Each “metric theory of gravity” (theory obeying the Einstein equivalence principle), when specialized to the post-Newtonian limit (low velocities and small stresses) is a special case of the PPN formalism corresponding to specific values of the PPN parameters. For gen-

eral relativity $\gamma = \beta = 1$ and all other parameters vanish.

To conserve space we shall not write down the full PPN metric here; instead, we refer the reader to equations (39.32)–(39.34) and Box 39.5 of the book by Misner, Thorne, and Wheeler² (cited henceforth as MTW), and to Eq. (4) of Will’s paper⁴ where the parameter ξ_w is added to the formalism.

Table I contains, for future reference, a brief list of post-Newtonian gravitational phenomena and the PPN parameters which describe them. (For details see, e.g., Refs. 4 and 21.)

Consider a source of gravity with mass M , size L , internal density $\rho \approx M/L^3$, internal energy density $\rho\Pi$, internal stresses p , internal strains s , velocity v of rotation or motion relative to center of mass, and velocity w of motion of center of mass relative to mean rest frame of the universe. For such a source the dimensionless magnitudes of post-Newtonian effects (fractional amounts by which post-Newtonian effects differ from Newtonian effects) are

$$GM/Lc^2, \Pi/c^2, p/\rho c^2, v^2/c^2, vw/c^2, w^2/c^2.$$

When the source of gravity is the Sun

TABLE I. Some post-Newtonian phenomena and their PPN parameters. For details see, e.g., Refs. 4 and 21.

| Description of phenomenon | Parameters |
|--|--|
| 1. Spatial curvature generated by rest mass, $\Delta g_{jk} \approx 2c^{-2}\gamma U\delta_{jk}$ | γ |
| 2. Nonlinearities in superposition of Newtonian gravitational potentials, $\Delta g_{00} = -2c^{-2}\beta U^2$ | β |
| 3. Newtonian-type gravity (Δg_{00}) generated by gravitational energy ($4\beta_2\rho_0 U$) | $\beta_2 = \frac{1}{2}(\xi_2 + 3\gamma - 2\beta + 1)$ |
| 4. Newtonian-type gravity (Δg_{00}) generated by kinetic energy ($4\beta_1\rho_0 v^2$) | $\beta_1 = \frac{1}{4}(\alpha_3 + \xi_1 + 2\gamma + 2)$ |
| 5. The effect of anisotropies in kinetic energy ($\rho_0 v^2$ with \vec{v} directed toward observer rather than transverse) on Newtonian-type gravity (Δg_{00}) | ξ_1 |
| 6. Newtonian-type gravity (Δg_{00}) generated by internal energy ($2\beta_3\Pi\rho_0$) | $\beta_3 = \xi_3 + 1$ |
| 7. Newtonian-type gravity (Δg_{00}) generated by isotropic part of stresses ($6\beta_4 p$) | $\beta_4 = \xi_4 + \gamma$ |
| 8. The effect of anisotropies in stresses (stresses directed toward the observer vs transverse stresses) on Newtonian-type gravity (Δg_{00}) | η |
| 9. Magnetic-type gravity (g_{0j}) generated by momentum ($\Delta_1\rho_0\vec{v}$) | $\Delta_1 = \frac{1}{7}(\alpha_1 - \alpha_2 + \xi_1 + 4\gamma + 3)$ |
| 10. The dependence of strength of momentum-generated gravity (g_{0j}) on direction of momentum (toward observer vs transverse) | $\Delta_2 = \alpha_2 - \xi_1 + 1$ |
| 11. “Preferred-frame effects,” i.e., the influence of matter’s motion relative to universe on the gravity the matter generates | $\alpha_1, \alpha_2, \text{ and } \alpha_3$ |
| 12. “Preferred-orientation effects,” i.e., the gravitational influence of the orientation of the experimental apparatus relative to the external universe | α_2, ξ_w |
| 13. Breakdowns in global conservation laws for energy, momentum, and/or angular momentum | $\xi_1 + 2\xi_w, \xi_2 - \xi_w, \xi_3, \xi_4 + \frac{2}{3}\xi_w, \alpha_1, \alpha_2, \alpha_3$ |

$$\begin{aligned}
GM/Lc^2 &\simeq \Pi/c^2 \simeq p/\rho c^2 \simeq 2 \times 10^{-6}, \\
v^2/c^2 &\simeq 5 \times 10^{-11}, \\
vw/c^2 &\simeq 5 \times 10^{-9}, \\
w^2/c^2 &\simeq 5 \times 10^{-7}.
\end{aligned} \tag{3.1a}$$

By contrast, a reasonable laboratory source of gravity has $\rho \simeq 10 \text{ g/cm}^3$, $L \lesssim 50 \text{ cm}$, $M \lesssim 10^6 \text{ g}$, $v \lesssim 10^5 \text{ cm/sec}$, $(p/\rho)^{1/2} \lesssim 10^5 \text{ cm/sec}$, $s \lesssim 10^{-2}$, $w \lesssim 2 \times 10^7 \text{ cm/sec}$, so that at best

$$\begin{aligned}
GM/Lc^2 &\sim 1 \times 10^{-24}, \\
p/\rho c^2 &\sim v^2/c^2 \sim 1 \times 10^{-11}, \\
\Pi/c^2 &\simeq (v^2/c^2)s \sim 1 \times 10^{-13}, \\
vw/c^2 &\sim 2 \times 10^{-9}, \\
w^2/c^2 &\sim 5 \times 10^{-7}.
\end{aligned} \tag{3.1b}$$

A comparison of the numbers in Eqs. (3.1b) and (3.1a) shows that laboratory experiments to probe nonlinear features of the gravitational field (dimensionless magnitude GM/Lc^2 , PPN parameters β and β_2 , items 2 and 3 of Table I) are hopeless. Similarly, laboratory measurements of the gravity produced by internal energy (dimensionless magnitude Π/c^2 , PPN parameter β_3 , item 6 of Table I) will be exceedingly difficult and perhaps impossible. However, there is hope for laboratory experiments which probe the gravitational influences of velocity and stress (dimensionless magnitudes v^2/c^2 , vw/c^2 , w^2/c^2 , and $p/\rho c^2$, all PPN parameters except $\gamma, \beta, \beta_2, \beta_3$, items 4, 5, and 7–13 of Table I). Whether one can invent a laboratory experiment to measure spatial curvature (PPN parameter γ , item 1 of Table I) is not evident to us (see Sec. V B).

In any experiment one must separate cleanly the post-Newtonian effects from all influences of Newtonian gravitational fields. To achieve this one obviously must modulate the post-Newtonian gravitational fields in time, and guarantee that at the resulting frequency ω_{PN} of the post-Newtonian forces all Newtonian forces are negligible. This will be extremely difficult in general because, *a priori*, the Newtonian forces are larger than the post-Newtonian forces by $\sim c^2/v^2 \sim 10^{11}$, and special positioning of detectors (accuracy $\sim 1 \text{ } \mu\text{m}$ out of $\sim 100 \text{ cm}$) and special orientations (accuracy $\sim 0.3 \text{ arcsec}$) can typically reduce the Newtonian signal by only factors of $\sim 1 \text{ } \mu\text{m}/100 \text{ cm} \sim 0.3 \text{ arcsec}/90^\circ \sim 10^{-6}$. Clearly one must guarantee that Newtonian forces with the frequency ω_{PN} are sensitive only at second order or higher to errors in positions and orientations.

Two types of post-Newtonian effects are especially attractive from this “Newtonian-noise” viewpoint:

(1) *Preferred-frame and preferred-orientation effects.* They can be modulated by rotations of the entire laboratory apparatus relative to inertial space, i.e., relative to the locally preferred directions, induced by solar-system motion through the universe or by the mass distribution of the universe. In such rotations (produced either artificially or by rotation of the Earth) one can maintain with accuracy $\ll 10^{-6}$ the relative positions and orientations of various pieces of the experimental apparatus. Moreover, such rotations performed perfectly will selectively modulate the preferred-frame and preferred-orientation effects without modulating Newtonian effects. Examples of this will be given in Sec. VI B. Such experiments can measure the PPN parameters α_1 , α_2 , α_3 , and ξ_w .

(2) *Magnetic-type gravitational effects*, i.e., effects associated with the g_{0j} metric components. These effects include the dragging of inertial frames by rotating bodies, Lens-Thirring gyroscope precession, gravitational accelerations produced by spin-spin interactions of rotating bodies, and gravitational accelerations due to spin-orbit coupling. The key property which distinguishes magnetic-type effects from all others is their sensitivity to the *direction* of rotation or motion of a laboratory source or detector. As source one could use a rapidly rotating, axially symmetric body and one could slowly modulate its angular velocity

$$\Omega = \Omega_0 \cos(\omega_{\text{mod}} t).$$

Magnetic-type gravitational effects are sensitive to the sign of Ω and therefore are modulated with angular frequency ω_{mod} and its harmonics ($2\omega_{\text{mod}}, 3\omega_{\text{mod}}, \dots$). Newtonian gravitational effects, and all the other “nonmagnetic” effects, are sensitive to Ω^2 (centrifugal distortions of rotating source; etc.) and therefore are modulated with angular frequency $2\omega_{\text{mod}}$ and its harmonics ($4\omega_{\text{mod}}, 6\omega_{\text{mod}}, \dots$). In an ideal experiment there is no Newtonian “noise” at the post-Newtonian frequency ω_{mod} . Examples of this will be given in Secs. IV A, V, and VI A. Such experiments are sensitive only to the parameter $\frac{7}{8}\Delta_1 + \frac{1}{8}\Delta_2 = \frac{1}{8}(\alpha_1 + 4\gamma + 4)$.²²

For other post-Newtonian effects Newtonian noise might remain insurmountable in the near future. However, there are gravitational effects not encompassed by the post-Newtonian approximation which should be measurable by the technology described in this paper. These include (i) the equality of inertial and passive gravitational mass (Eötvös experiment, Sec. IV B), (ii) the time rate of change of the gravitation constant (Sec. IV C), (iii) the gravity produced by electromagnetic stresses (Sec. IV D), and (iv) the gravity produced

by particles that move with nearly the speed of light (Sec. VIC).

B. Formalism for analyzing magnetic-type gravity

In our discussion of experiments to analyze magnetic-type gravity we shall utilize a truncated and rewritten version of the PPN formalism. Our truncation consists of two steps: *First*, we delete from the formalism a number of phenomena that are already absent in general relativity, namely preferred-frame effects (set $w_j = 0$ in Chap. 39 of MTW), preferred-orientation effects (set $\zeta_w = 0$), and anomalies in g_{00} produced by anisotropies of stress and kinetic energy (set $\zeta = \eta = 0$). *Second*, we delete from the formalism all gravitational nonlinearities (set $\beta = \beta_2 = 0$), since there is no hope of measuring them in laboratory experiments, and we treat the Newtonian potential U formally as having magnitude

$$U/c^2 \sim (v/c)^4 \sim (p/\rho c^2)^2 \sim (\Pi/c^2)^2 \ll 1 \quad (3.2)$$

[cf. Eq. (3.1b)]. In rewriting the PPN formalism we replace the gravitational potentials U , Ψ , \vec{V} , and \vec{W} of Chap. 39 of MTW by scalar and vector potentials

$$\Phi = -(U + 2\Psi), \quad \vec{A} = -\frac{7}{2}\Delta_1 \vec{V} - \frac{1}{2}\Delta_2 \vec{W}, \quad (3.3)$$

and we define an "electric-type" gravitational field \vec{g} and a "magnetic-type" gravitational field \vec{H} by

$$\vec{g} = -\vec{\nabla}\Phi - \frac{1}{c} \frac{\partial \vec{A}}{\partial t}, \quad \vec{H} = \vec{\nabla} \times \vec{A}. \quad (3.4)$$

Here the notation is that of flat-space 3-dimensional vector analysis, the coordinates (t, x, y, z) are those of the PPN coordinate frame of Chap. 39 of MTW, and we use cgs units rather than geometrized units.

In terms of the new notation $\Phi, \vec{A}, \vec{g}, \vec{H}$ the metric of spacetime, accurate to post-Newtonian order, becomes

$$\begin{aligned} g_{00} &= -c^2(1 + 2\Phi/c^2), \\ g_{0j} &= A_j/c, \\ g_{jk} &= \delta_{jk}(1 - 2\gamma\Phi/c^2) \end{aligned} \quad (3.5)$$

[cf. Eq. (39.32c) of MTW]. The source equation for the scalar field Φ is

$$\nabla^2 \Phi = 4\pi G \rho_0 (1 + 2\beta_1 \vec{v}^2/c^2 + \beta_3 \Pi/c^2 + 3\beta_4 p/\rho_0 c^2) \quad (3.6)$$

[Eqs. (39.34a, d) of MTW combined with Eq. (3.3) above]. The vector potential in the chosen PPN gauge has nonzero divergence

$$\vec{\nabla} \cdot \vec{A} = \left(-\frac{7}{2}\Delta_1 + \frac{1}{2}\Delta_2\right) \frac{1}{c} \frac{\partial \Phi}{\partial t} \quad (3.7a)$$

[Eqs. (3.3) above, and (39.27), (39.34b), and (39.15a) of MTW]. The Laplacian of the vector potential is

$$\nabla^2 \vec{A} = \left(\frac{7}{2}\Delta_1 + \frac{1}{2}\Delta_2\right) 4\pi G \rho_0 \frac{\vec{v}}{c} + \Delta_2 \frac{1}{c} \frac{\partial}{\partial t} \vec{\nabla} \Phi \quad (3.7b)$$

[Eqs. (3.3) above, and (39.27), (39.34b) of MTW]. By combining Eqs. (3.6) and (3.7) with definitions (3.4) of \vec{g} and \vec{H} , and by making use of standard vector-analysis identities, one can derive the following Maxwell-type equations for the electric-type and magnetic-type gravitational fields:

$$\begin{aligned} \vec{\nabla} \cdot \vec{g} &= -4\pi G \rho_0 \left(1 + 2\beta_1 \frac{\vec{v}^2}{c^2} + \beta_3 \frac{\Pi}{c^2} + 3\beta_4 \frac{p}{\rho_0 c^2}\right) \\ &\quad + \left(\frac{7}{2}\Delta_1 - \frac{1}{2}\Delta_2\right) \frac{1}{c^2} \frac{\partial^2}{\partial t^2} \Phi, \end{aligned} \quad (3.8a)$$

$$\vec{\nabla} \times \vec{g} = -\frac{1}{c} \frac{\partial \vec{H}}{\partial t}, \quad (3.8b)$$

$$\vec{\nabla} \cdot \vec{H} = 0, \quad (3.8c)$$

$$\vec{\nabla} \times \vec{H} = \left(\frac{7}{2}\Delta_1 + \frac{1}{2}\Delta_2\right) \left(-4\pi G \frac{\rho_0 \vec{v}}{c} + \frac{1}{c} \frac{\partial}{\partial t} \vec{g}\right). \quad (3.8d)$$

Throughout these equations $\gamma, \beta_1, \beta_3, \beta_4, \Delta_1$, and Δ_2 are PPN parameters, ρ_0 is the density of rest mass in the local rest frame of the matter, \vec{v} is the ordinary (coordinate) velocity of the rest mass relative to the PPN coordinate frame, Π is specific internal energy, and p is pressure (see Chap. 39 of MTW).

When combined with the standard mathematics of general relativity truncated to post-Newtonian order, Eqs. (3.4)–(3.8) are a complete set of tools for analyzing the "near-zone" region of systems satisfying Eq. (3.2). For example a test mass, with 4-velocity $u^\alpha = dx^\alpha/d\tau$ and ordinary velocity $\vec{v} = d\vec{x}/dt = \vec{u}/u^0$, experiences a gravitational force \vec{F} which one can derive from the geodesic equation. After some algebra that geodesic force reduces to the Lorentz-type expression

$$\frac{\vec{F}}{m} \equiv \frac{d\vec{u}}{dt} = \frac{d}{dt} (u^0 \vec{v}) = u^0 \left(\vec{g} + \frac{\vec{v} \times \vec{H}}{c} - \gamma \frac{\vec{v}^2}{c^2} \vec{v} \right). \quad (3.9)$$

[In deriving this expression one must make the approximation $e^{2\gamma\Phi/c^2} (d/dt) (e^{-2\gamma\Phi/c^2} u^0 \vec{v}) = (d/dt) (u^0 \vec{v})$, an approximation which is valid for all conceivable laboratory-type experiments.] In this paper attention will focus on experiments where the detectors, like the sources, have velocities $|\vec{v}| \leq 1 \times 10^5$ cm/sec $\ll c$. Under these circumstances the gravitational force acting on a unit mass reduces to

$$\frac{\vec{F}}{m} = \left[1 + \frac{1}{2}(2\gamma + 1)\right] \frac{\vec{v}^2}{c^2} \vec{g} + \frac{\vec{v} \times \vec{H}}{c}. \quad (3.10)$$

Equations (3.4)–(3.10) express the law of laboratory, post-Newtonian physics in Maxwell-type language. An analogous formalism for weak-field general relativity has been used previously by Forward²³ in a discussion of conceivable gravitation experiments.

IV. EXPERIMENTS USING TORQUE BALANCES

In this section we describe several laboratory gravitation experiments which one might perform using a torque-balance detection system. Throughout we assume that the laboratory is earthbound, though one may prefer to perform the experiments in space to circumvent seismic “noise” (see Sec. IIA).

A. Gravitational Ampère experiment

One post-Newtonian experiment that may be feasible in the next few years is a gravitational analog of Ampère’s experiment,²⁴ which demonstrated magnetic forces between current-carrying spiral-shaped wires. Such an experiment is of great theoretical interest because it detects magnetic-type gravitational forces. Magnetic-type gravity *must* exist according to general relativity and most (but not all) other relativistic theories of gravity, but nobody has ever detected such a force. Before describing our proposal for an Ampère-type experiment, we shall review previous ideas and efforts to search for magnetic-type gravity.

The Everitt-Fairbank gyroscope experiment⁶ is designed to detect the magnetic-type gravitational torque produced on a gyroscope by the rotation of the Earth. Van Patten and Everitt²⁵ have proposed an experiment to measure the magnetic-type gravitational force which the Earth’s rotation exerts on a satellite orbit. Chapman²⁶ has proposed an experiment to detect the magnetic-type force of the Earth’s electric-type gravity acting on the orbital motion of spinning hoops (force proportional to orbital velocity \vec{v} and angular momentum of hoop \vec{S} , spin-orbit coupling). None of these experiments (Everitt-Fairbank, Van Patten-Everitt, or Chapman) is of a “laboratory type” since they all rely on the Earth as the source of gravity. Also, all three experiments require expensive Earth-orbiting facilities.

Laboratory-type experiments to detect magnetic-type gravity have been suggested by a number of people,²⁷ but in all cases either the originator of the ideal or his critics²⁸ have concluded that with state-of-the-art technology the experiment was not feasible.²⁹ The spin-spin coupling experiment described below looks more favorable thanks, primarily, to the high- Q technology of near-future

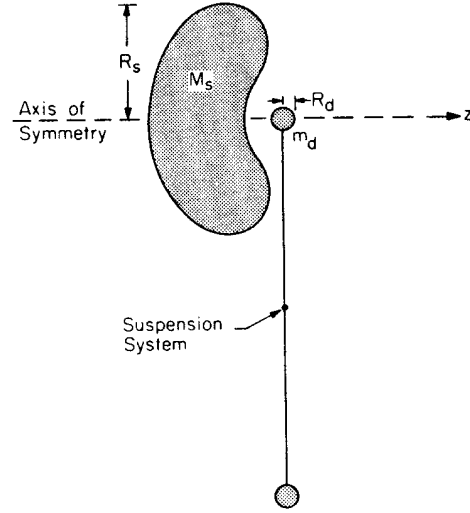

FIG. 2. Experimental configuration for a gravitational Ampère experiment (measurement of spin-spin coupling), as viewed from above. The source mass M_s and detector mass m_d both rotate about the source’s axis of symmetry (z axis).

torsion oscillators.

The experimental setup which we envision involves as source an axially symmetric body of mass M_s , density ρ_s , and outermost radius R_s , which rotates rigidly about its axis of symmetry (z axis of Fig. 2). The rotational angular velocity Ω_s is modulated at a frequency $\omega_0 \sim 10^{-3} \text{ sec}^{-1}$

$$\Omega_s = \Omega_0 \cos \omega_0 t. \quad (4.1)$$

The detector is a small sphere of mass m_d and radius R_d which is located on the z axis and rotates about that axis with constant angular velocity Ω_d . This detecting sphere is one mass of a torque-balance system of the type discussed in Sec. IIA (see Fig. 2). The frequency ω_0 of source modulation is chosen to coincide with the eigenfrequency of the torque balance. When the source is rotating in the same direction as the detector (i.e., when $\cos \omega_0 t > 0$), its magnetic-type gravitational force repels the detector; when the source rotates in the opposite direction, its magnetic-type force attracts the detector. This oscillating force on the detector $[\vec{F}/m_d = (\vec{v}/c) \times \vec{H}$ with \vec{H} produced by the source and \vec{F} integrated over the detector] is given by

$$\frac{F}{m_d} = \left(\frac{7}{8} \Delta_1 + \frac{1}{8} \Delta_2 \right) \alpha G \rho_s R_d (\Omega_0 R_s) (\Omega_d R_d) c^{-2} \cos \omega_0 t; \quad (4.2)$$

[cf. Eqs. (3.8c), (3.8d) with $\partial \vec{g}/\partial t$ negligibly small]. Here α is a dimensionless constant which depends on the precise shape of the source and location of the detector, but which is of order unity

if $M_s \sim \rho_s R_s^3$, $R_d \ll R_s$, and (source-detector separation) $= r \sim R_s$. One can compute α for any given source-detector configuration by applying the standard techniques of magnetostatics to Eqs. (3.8c), (3.8d). If the source is a sphere, then $\alpha(r/R_s)^4 = 96\pi/75 \approx 4$.

The amplitude of the oscillating acceleration (4.2) is the quantity which enters into the torque-balance discussion of Sec. IIA. In general relativity ($\Delta_1 = \Delta_2 = 1$) it is

$$(F/m_d) \approx 1 \times 10^{-17} \text{ cm/sec}^2$$

$$\text{for } \rho_s = 8 \text{ g/cm}^3, R_d = 2 \text{ cm}, \quad (4.3)$$

$$\Omega_0 R_s = \Omega_d R_d = 5 \times 10^4 \text{ cm/sec}, \alpha = 4.$$

These parameters are reasonable for steel. The types of ceramics and fibers being developed for use on superflywheels³⁰ would have lower densities but higher maximum angular velocities, thereby yielding similar values of F/m ; the chief advantage of such materials is that, because of their lower density, the Newtonian acceleration produced by the source is smaller than for steel, so that both types of Newtonian noise discussed below are re-

$$(F/m)_N = +\frac{1}{2} (\vec{\xi} \cdot \vec{\nabla})^2 g_N \approx \frac{1}{2} (\xi/R_s)^2 (GM_s/R_s^2)$$

$$\approx 1 \times 10^{-18} \text{ cm/sec}^2 \text{ for } \xi = 1 \times 10^{-5} \text{ cm}, R_s = 30 \text{ cm}, M_s = 3 \times 10^5 \text{ g}.$$

If a horizontal stability of $\xi \approx 10^{-5}$ cm seems excessive, one can shape the source so that $\partial_z^2 g_N \ll g_N/R_s^2$ and then relax the constraint on ξ .

In an ideal experiment, with $\Omega_d \equiv \Omega_0 \cos \omega_0 t$, the centrifugal deformation of the source would oscillate with frequency $2\omega_0$ and would produce no Newtonian force whatsoever on the detector at frequency ω_0 . But in any real experiment small deviations $\delta\Omega_0$ between amplitude of "positive" rotation and of "negative" rotation will produce a Newtonian signal at frequency ω_0 :

$$\left(\frac{F}{m}\right)_N \approx \Delta g_N \frac{\delta\Omega_0}{\Omega_0},$$

where Δg_N is twice the amplitude of centrifugal-flattening-induced oscillation of g_N at frequency $2\omega_0$. If one designs the source shape so that not only is $\partial_z g_N = 0$, but also $\Delta g_N \lesssim 10^{-6} GM_s/R_s^2$ for $\Omega_0 R_s \approx 5 \times 10^4$ cm/sec,³¹ then

$$\left(\frac{F}{m}\right)_N \approx \frac{GM_s}{R_s^2} \times 10^{-6} \frac{\delta\Omega_0}{\Omega_0}$$

$$\approx 2 \times 10^{-18} \text{ cm/sec}^2 \text{ for } \delta\Omega_0/\Omega_0 \approx 1 \times 10^{-7}.$$

(4.5)

duced.

The considerations of Sec. IIA suggest that a torque system to detect the force (4.3) can be built, but that in an earthbound laboratory seismic noise will not be overcome easily.

Noise from Newtonian (electric-type) gravity should not be an insurmountable problem in the above experiment. The Newtonian gravitational field will be constant in time, except for small-amplitude modulations due to time-changing centrifugal deformation of the source sphere, and jitter in the source location.

The jittering displacement $\vec{\xi}(t)$ of the source's center of mass produces a jitter

$$(F/m)_N = - [(\vec{\xi} \cdot \nabla) - \frac{1}{2} (\vec{\xi} \cdot \nabla)^2 + \dots] g_N \quad (4.4)$$

in the Newtonian acceleration of the detector. Here g_N is the longitudinal component (z component) of the acceleration at the center of mass of the detector in the absence of jitter. Since the detector sits on the axis of symmetry of the source, $\partial_x g_N = \partial_y g_N = 0$. By appropriately shaping the source and positioning the detector one can also guarantee that $\partial_z g_N = 0$. This is approximately so for the configuration of Fig. 1. In this case

Thus, a modulation precision of $\delta\Omega_0/\Omega_0 \approx 10^{-7}$ is then adequate to keep the Newtonian signal well below the post-Newtonian signal. However, it may not be easy to design a source which has $\partial_z g_N$ and Δg_N as small as desired while still keeping the spin-spin coupling coefficient α reasonably large.

B. Improved Eötvös experiment

A torque-balance system and antiseismic platform of the type needed in the above experiment could also be used in three other gravitational experiments: a new high-precision Eötvös experiment, an experiment to search for time changes in the gravitation constant, and an experiment to measure the gravity produced by magnetic stresses.

An Eötvös experiment of the Dicke³² type would search for periodic torques in the torsion balance due to rotation of the Earth relative to the Sun's gravitational field. The frequency of modulation, $\omega_0 \approx 2\pi/(24 \text{ h}) \sim 10^{-4} \text{ sec}^{-1}$ is a factor 10 lower than that contemplated for the Ampère experiment (see above and see Sec. IIA). As a result, seismic noise will present more serious difficulties here

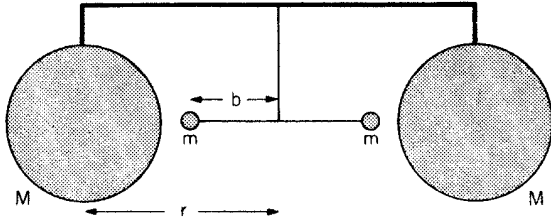

FIG. 3. Experimental configuration for measuring a time change of the gravitation constant.

than there, and we think it reasonable to aim for an acceleration sensitivity of $F/m \sim 10^{-14}$ or 10^{-15} cm/sec² rather than 10^{-17} . However, this sensitivity would yield a test of the weak-equivalence principle at the level

$$\frac{\delta g}{g} = \frac{a_1 - a_2}{a} \sim 10^{-14} \text{ or } 10^{-15}, \quad (4.6)$$

where a_1 is the acceleration of one material toward the Sun, a_2 is the acceleration of another material toward the Sun, and a is the mean acceleration toward the Sun. This is an improvement by a factor 100 to 1000 over the best present experiment,⁷ but it is a factor 100 to 1000 worse than the 10^{-17} precision which one might expect for Eötvös experiments performed in Earth-orbiting laboratories.³³ At present, however, there is no strong theoretical motivation for performing an Eötvös experiment with precision 10^{-14} , 10^{-15} , or even 10^{-17} . The current accuracy⁷ of 10^{-12} is adequate to check the gravitational coupling of all nongravitational forms of energy, including even weak-interaction energy,³⁴ and 10^{-17} is ten orders of magnitude too poor for checking the gravitational coupling of gravitational energy.³⁵ (The self-gravitational energy of a 10 g laboratory test mass is only $\sim 10^{-27}$ of its rest mass-energy.)

C. Time dependence of the gravitation constant

A search for time changes of the gravitation constant could be performed using the same type of installation as Eötvös³⁶ used for measuring the absolute value of the gravitation constant (see Fig. 3). The two large masses M produce, by their Newtonian gravity, a restoring torque that greatly exceeds the intrinsic torque of the torsion balance. The result is small-amplitude torsional oscillations with angular frequency

$$\omega = (\omega_g^2 + \omega_0^2)^{1/2} \simeq \omega_g \left[1 + \frac{1}{2} (\omega_0/\omega_g)^2 \right], \quad (4.7a)$$

$$\omega_0 \lesssim 1 \times 10^{-4} \text{ sec}^{-1}, \quad (4.7b)$$

where ω_0 is the intrinsic eigenfrequency of the gravity-free torque balance,

$$\omega_g = \left\{ \frac{GM}{r^2 b} \left[\frac{r^3}{(r-b)^3} - \frac{r^3}{(r+b)^3} \right] \right\}^{1/2}$$

$$\simeq 1 \times 10^{-3} \text{ sec}^{-1}$$

$$\text{for } M \simeq 10^5 \text{ g, } r \simeq 50 \text{ cm, } b \simeq 25 \text{ cm.}$$

(4.7c)

If the gravitation constant changes with time there will be a corresponding time change of the oscillation frequency

$$\dot{\omega}/\omega \simeq \frac{1}{2} \dot{G}/G. \quad (4.8)$$

Changes in the dimensions r and b of the apparatus and in the intrinsic eigenfrequency ω_0 will also produce changes in ω ("noise"):

$$\dot{\omega}/\omega = -2.6(\dot{r}/r) + 1.1(\dot{b}/b) + (\omega_0/\omega)^2 (\dot{\omega}_0/\omega_0) \quad \text{for } r = 2b. \quad (4.9)$$

Such changes can be induced by temperature fluctuations or material aging. One can probably keep them negligibly small by making the entire apparatus, including the torque-balance support system, out of monocrystal sapphire, by cooling the apparatus to $T \simeq 2^\circ\text{K}$ where sapphire has a thermal-expansion coefficient $\alpha_T \simeq (5 \times 10^{-12}/^\circ\text{K}) \times (T/2^\circ\text{K})^{-3}$, and by maintaining the temperature constant to within $\Delta T \simeq 0.01^\circ\text{K}$ so that thermal-expansion effects produce

$$\Delta\omega/\omega \simeq \frac{3}{2} \alpha_T \Delta T \simeq 1 \times 10^{-13}. \quad (4.10)$$

Whether such an installation would have negligible aging effects one cannot be sure; direct measurements of sapphire aging are needed. However, aging is likely to be far less than the $\dot{b}/b \sim 10^{-9}/\text{yr}$ of quartz, since quartz has a far lower Debye temperature than sapphire (470°K vs 1040°K).

With such an installation it seems reasonable to measure ω to a precision $\Delta\omega/\omega \simeq 1 \times 10^{-12}$ by data collection for one week ($\simeq 100$ oscillation periods), and to thereby obtain during one month of measurements a limit on (or value for) \dot{G}/G at the level $\sim 1 \times 10^{-12}/\text{month} \simeq 1 \times 10^{-11}/\text{yr}$. With greater effort one might even achieve $1 \times 10^{-12}/\text{yr}$. For comparison, Shapiro's monitoring of planetary orbits (the best current method of measuring \dot{G}) has given a limit of $1 \times 10^{-10}/\text{yr}$ (Ref. 37) and may well achieve $1 \times 10^{-11}/\text{yr}$ before the end of this decade. Most theories of gravity, but not general relativity, predict \dot{G}/G in the range $10^{-12}/\text{yr}$ to $10^{-10}/\text{yr}$.

D. Experiment to measure the gravity produced by magnetic fields

Although general relativity predicts that gravity should be produced by stress as well as by mass-energy (item 7 of Table I), at present there is no

experimental proof that this is so (the PPN parameter β_4 could be zero). Such a proof is particularly important for astrophysics because, according to general relativity, stress-produced gravity plays an important, perhaps crucial role in the maximum mass of neutron stars.³⁸

A promising way to test whether and how much stress gravitates is to measure the gravity produced by a magnetic field. A magnetic field has the advantage that its stresses are equal to its energy density. In this section we describe briefly an experiment to measure magnetically-generated gravity.

Our experiment would make use of a DC magnetic field which is slowly turned on and off at the eigenfrequency ω_0 of a torque-balance detector. For example, one could set up a magnetic field of strength $B_0 \approx 2 \times 10^5$ G (the current state of the art) in a long cylindrical or toroidal pipe (inner diameter $b \approx 10$ cm); and one could set up a torsion oscillator with one of its masses near the pipe. One would turn the magnetic field on and off at the eigenfrequency of the torsion oscillator, $\omega_0 \approx 10^{-3}$ sec⁻¹, and watch to see whether gravity due to the oscillating magnetic stress energy produces a change in the amplitude and phase of the oscillator.

If only the energy of the magnetic field, and not its stress, were to gravitate, then the amplitude of the oscillating force would be

$$(F/m) \approx 2(G/c^2)(B_0^2/8\pi)\pi b \approx 7 \times 10^{-18} \text{ cm/sec}^2, \quad (4.11)$$

which is measurable with the techniques of Sec. IIA providing seismic noise can be controlled. On the other hand, in general-relativity theory the gravitational acceleration is produced by the energy density plus the trace of the stress tensor, which means that for the idealized case of an infinitely long pipe

$$(F/m) = 2(G/c^2)b^{-1} \left[\int (T^{00} + T^{JJ})_{\text{mag}} 2\pi r dr + \int_{\text{walls of pipe}} T^{JJ} 2\pi r dr \right].$$

The last term is the gravity produced by stresses that build up in the walls to counteract the magnetic pressure. Total stress balance, $T^{jk}_{,k} = 0$, enables one to re-express this as

$$(F/m) = 2(G/c^2)b^{-1} \int_0^b (T^{00} + T^{zz})_{\text{mag}} 2\pi r dr = 0, \quad (4.12)$$

where $T^{zz} = -B^2/8\pi = -T^{00}$ is the longitudinal component of the stress. Thus, in general relativity

there is no oscillating force, except the Newtonian "noise" associated with stress-induced changes $\delta\rho$ in the mass density ρ of the walls. Although

$$(F/m)_N = 2Gb^{-1} \int_{\text{walls}} \delta\rho 2\pi r dr = 0 \quad (4.13)$$

for idealized case of an infinitely long pipe, for any real solenoid the Newtonian "noise" will be nonzero.

The toughest part of this experiment would probably be designing and monitoring the pipe walls and the other laboratory-mass distributions, so as to keep the Newtonian noise negligible. It would probably help to rotate the pipe about its central axis with an angular velocity $\Omega \gg \omega_0$.

V. EXPERIMENTS USING MICROWAVE RESONATORS

A. The Davies frame-dragging experiment

Davies³⁹ has proposed an experiment, which might be performed in the 1980's or later, to measure the post-Newtonian "dragging of inertial frames" by the rotation of the Sun, and to thereby determine the Sun's total angular momentum. The technique is to send two electromagnetic signals around the Sun along the same path, but in opposite directions, and to measure the excess travel time for the signal which travels "against" the rotation compared with that which travels "with" the rotation. In this section we propose a laboratory variant of the Davies experiment.

The dragging of inertial frames, like spin-spin coupling, is a magnetic-type gravitational effect. It is most easily analyzed in terms of the vector potential \vec{A} produced by the rotation of a gravitating body. Consider an axially symmetric body rotating rigidly about the z axis of a cylindrical coordinate system (t, r, z, ϕ) . The body's velocity \vec{v} is entirely in the ϕ direction,

$$\begin{aligned} v^\phi &= \Omega_\zeta = (\text{angular velocity of rotation}), \\ v^{\hat{\phi}} &= \Omega_\zeta r = (\text{physical component of velocity}). \end{aligned} \quad (5.1)$$

In this case symmetry dictates that the vector potential \vec{A} have only a ϕ component. The new notation

$$\Omega_D \equiv -c^{-1}A^\phi = -(rc)^{-1}A^{\hat{\phi}} \quad (5.2)$$

enables one to express in a simple form the influence of the vector potential A^ϕ on the metric [Eq. (3.5)]:

$$ds^2 = -c^2 dt^2 + r^2 (d\phi - \Omega_D dt)^2 + dz^2 + dr^2. \quad (5.3)$$

Equations (3.7b) with $\partial\Phi/\partial t = 0$, (5.1), and (5.2) give us the following expression for Ω_D :

$$\Omega_D(r, z) = \left(\frac{7}{8}\Delta_1 + \frac{1}{8}\Delta_2\right) \frac{4\Omega_S}{r} \int_{\text{source}} \frac{(G/c^2)\rho_0(r', z')r'^2 \cos\phi' dr' d\phi' dz'}{[r^2 + r'^2 - 2rr' \cos\phi' + (z - z')^2]^{3/2}}. \quad (5.4)$$

The quantity Ω_D is called "the angular velocity of dragging of inertial frames," or, sometimes, "the angular velocity of a locally nonrotating observer."⁴⁰ The reason for this name is evident from Eq. (5.3): Place two ideal light beams of infinitesimal wavelength in a thin toroidal waveguide (resonator) centered on the rotation axis of the source (Fig. 4). Adjust the angular velocity of rotation of the waveguide until the two beams require identically the same time for travel once around the guide. Equation (5.3), with $ds^2 = 0$ for the photon world lines, then guarantees that the waveguide must be rotating, relative to the coordinate system, and hence relative to inertial frames far from the gravitating source, with angular velocity $d\phi/dt = \Omega_D$. If instead the waveguide is kept at rest relative to distant inertial frames, the standing-wave pattern made by the two traveling waves in the guide will move relative to the guide with angular velocity Ω_D .

Although the above conclusions are deduced assuming waves that travel with the speed of light (geometric optics limit, wavelength of waves infinitesimal compared with circumference of waveguide), one can show¹⁶ that they remain true for any standing-wave modes of any perfectly smooth, perfectly reflecting toroidal microwave resonator which surrounds the source and is at rest relative to distant inertial frames. The standing-wave pattern will always move relative to the resonator (waveguide) with angular velocity

$$\Omega_{sw} = \bar{\Omega}_D, \quad (5.5)$$

where $\bar{\Omega}_D$ is an appropriate average¹⁶ of Ω_D over

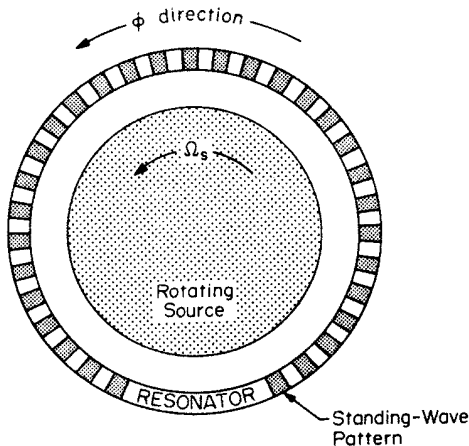

FIG. 4. Experimental configuration for measuring the dragging of inertial frames.

the interior of the resonator.

This motion of the standing-wave pattern can be regarded as due to a feeding of electromagnetic quanta from one normal mode, which has azimuthal dependence " $\cos m\phi$," to another normal mode with dependence " $\sin m\phi$." In an ideal resonator these two modes are degenerate and lossless, so the feeding proceeds smoothly. However, in any real resonator, wall imperfections split the degeneracy and induce losses, thereby producing normal modes which respond in a complicated manner to frame dragging. One of us (C.M.C.) analyzes that complicated response in another paper.¹⁶ From his analysis it appears that the cleanest frame-dragging experiment might be one in which (i) one of the two (nearly degenerate) normal modes of the resonator is driven into *steady-state* excitation at its eigenfrequency $\omega_1 \approx 10^{12}$ sec⁻¹, (ii) the angular velocity Ω_S of the rotating source of gravity, and hence also the frame-dragging angular velocity $\bar{\Omega}_D$, is modulated with frequency $\omega_{\text{mod}} = \omega_1 - \omega_2$ (frequency split between resonator's normal modes) $\geq 10^5$ sec⁻¹:

$$\bar{\Omega}_D = \bar{\Omega}_{D0} \cos(\omega_{\text{mod}} t), \quad (5.6)$$

(iii) the modulation of $\bar{\Omega}_D$ pumps electromagnetic quanta from the driven mode to the undriven mode, producing an angular oscillation of the standing-wave pattern in the resonator with frequency ω_{mod} and amplitude

$$\Delta\phi \approx \bar{\Omega}_{D0} \tau^* / 2, \quad (5.7)$$

where τ^* is the damping time of the normal modes. [Formula (5.7) can be derived either classically or quantum mechanically.]

If the rotating source of gravity has mass $M \approx 5 \times 10^6$ g and equatorial radius $R \approx 50$ cm, and if it rotates with equatorial velocity $\Omega_{S0} R \approx 10^5$ cm/sec, then Eq. (5.4) gives

$$\bar{\Omega}_{D0} \approx 0.5(GM/Rc^2)\Omega_{S0} \approx 6 \times 10^{-21} \text{ rad/sec.} \quad (5.8a)$$

It is conceivable that a damping time $\tau^* \approx 10^5$ sec can be achieved with some years of technological effort (see below). If so, then the amplitude of standing-wave oscillation will be

$$\Delta\phi \approx 3 \times 10^{-16} \text{ rad.} \quad (5.8b)$$

One way to measure the oscillation effect would be this: Place a small "porthole" in the wall of the resonator at a location where the standing-wave intensity has its steepest gradient, and extract

signal from that hole at just such a rate as to modestly degrade the Q of the resonator (50% of photons extracted in one resonator damping time $\tau^* \approx 10^5$ sec). Then " \sqrt{N} " fluctuations in the signal extracted will lead to an uncertainty in the intensity oscillation amplitude of

$$(\Delta I/I)_{\text{noise}} = (\frac{1}{2} 0.5 \mathcal{N} \hat{\tau} / \tau^*)^{-1/2}, \quad (5.9)$$

where \mathcal{N} is the total number of quanta in the resonator and $\hat{\tau} \geq \tau^*$ is the measurement time. For comparison, the frame-dragging-induced intensity oscillation is

$$\begin{aligned} \mathcal{N} &\approx (2\pi^2 a^2 R)(B_0^2/8\pi)(hc/\lambda_e)^{-1} \\ &\approx 4 \times 10^{24} \text{ for } a \approx 10 \text{ cm, } R \approx 50 \text{ cm, } \lambda_e \approx 0.2 \text{ cm, } B_0 \approx 1000 \text{ G } (4 \times 10^9 \text{ erg of excitation energy}). \end{aligned} \quad (5.11)$$

For these parameters the standing-wave oscillation (5.8b) corresponds to the transfer of approximately one quantum from the driven mode to the undriven mode during each damping time; and the measured signal and noise at the steepest gradient of the standing-wave pattern [Eqs. (5.10) and (5.9)] are

$$(\Delta I/I)_{\text{signal}} \approx 1 \times 10^{-12}, \quad (\Delta I/I)_{\text{noise}} \approx 3 \times 10^{-13} \quad (5.12)$$

for $\Delta\phi \approx 3 \times 10^{-16}$ rad, $\hat{\tau} \approx 10^6$ sec, $\tau^* \approx 10^5$ sec. Thus, the signal is detectable in one experiment of duration 10^6 sec ≈ 2 weeks. Of course, one can strengthen the signal by measuring for a longer time or performing a number of 2-week experiments.

The above parameters for the resonator ($B_0 \approx 1000$ G, $\lambda_e \approx 0.2$ cm, $R \approx 50$ cm, $a \approx 10$ cm, $\tau^* \approx 10^5$ sec) are rather extreme, but might be achievable with some years of developmental work. The main problem is the very long damping time τ^* , corresponding to a Q of

$$Q = \pi c \tau^* / \lambda_e \approx 5 \times 10^{16}. \quad (5.13)$$

One can make a very rough estimate of the achievable Q in terms of the reflection coefficient \mathcal{R} for microwaves normally incident on the mirror walls:

$$Q \sim \frac{\pi R / \lambda_e}{1 - \mathcal{R}} \approx 5 \times 10^{16} \text{ if } 1 - \mathcal{R} \approx 2 \times 10^{-14}. \quad (5.14)$$

Reflection coefficients of $1 - \mathcal{R} \sim 10^{-11}$ are the state of the art for the best superconducting cavities with $\lambda_e \approx 1$ cm, excited in very low modes ($R \sim \lambda_e$) (see Sec. IIC). Thus a Q as high as 5×10^{16} is not totally out of the question, but it will require major advances in superconducting technology.

$$(\Delta I/I)_{\text{signal}} = I^{-1} (dI/d\phi)_{\text{max}} \Delta\phi = (4\pi R/\lambda_e) \Delta\phi, \quad (5.10)$$

where $R \approx 50$ cm is the radius of the cavity and λ_e is the azimuthal wavelength of the standing-wave pattern ($\lambda_e = 2\pi R/m$). Clearly we want λ_e as small as possible and \mathcal{N} as large as possible. The minimum λ_e and maximum magnetic field strength B_0 that one can put into a resonator without breaking the superconductivity of its walls are $\lambda_e \approx 0.2$ cm, $B_0 \approx 1000$ G. If the resonator has large radius R and small radius a , then the number of quanta is

Rather than using a closed toroidal cavity, it may be better to use an open electromagnetic resonator with several, e.g., six carefully shaped mirrors that bounce the beam from one to another to another around the rotating source of gravity. With appropriate mirror shapes and a sufficiently large Fresnel parameter, it should be possible to keep diffraction losses negligibly small.⁴¹

To keep the signal clean and big one needs very high relative-frequency stability between the driving oscillator (frequency ω_e) and the eigenfrequencies of the resonator (ω_1 and ω_2). Their relative phases must not drift substantially during the resonator damping time τ^* ; i.e., their relative frequencies must remain stable to a precision

$$\Delta\omega/\omega \sim 1/\omega_1 \tau^* \sim 1 \times 10^{-17}. \quad (5.15)$$

For comparison, absolute-frequency stability of 6×10^{-16} has been achieved by Turneaure,²⁰ except for an extrapolatable drift which he is now trying to get rid of. Thus, the necessary oscillator stability might be achievable. However, unless one can devise a monitoring and feedback scheme to stabilize the eigenfrequencies of the resonator, the experiment will be impossible to perform.

Seismic noise would also be a very serious problem for this experiment. Any rotation of the cavity relative to nearby inertial frames will produce a counter-rotation of the standing-wave pattern relative to the cavity walls. The 24-h rotation of the Earth can be, and must be, counteracted by a rotation of the cavity relative to the laboratory. However, seismic-induced rotations will remain. At the eigenfrequency of the experiment ω_{mod} , and in its bandwidth $1/\hat{\tau}$, these rotations will drive an oscillation of the standing-wave pattern with amplitude

$$\begin{aligned}
(\Delta\phi)_{\text{rot}}^{\text{seismic}} &= \omega_{\text{mod}} \tau^* (2\pi J_{\omega}^{\text{rot}} / \hat{\tau})^{1/2} \\
&\simeq (5 \times 10^{-10} \text{ rad}) (\omega_{\text{mod}} / 10^{-3} \text{ sec}^{-1})^{-1/2} \text{ for } \tau^* \simeq 10^5 \text{ sec}, \hat{\tau} \simeq 10^6 \text{ sec}
\end{aligned}
\tag{5.16}$$

[cf. Eqs. (2.7), (2.8), and (5.7)]. This amplitude is so large that it will swamp the signal (3×10^{-16} rad) unless some way is found to monitor and subtract it with high accuracy. Perhaps the best monitor technique would be to construct two toroidal resonators and attach them to each other rigidly, with one encircling the 1-m-diameter rotating mass and the other perhaps 1 m above that mass. The frame-dragging effect falls off roughly as $1/r^3$ [Eq. (5.4)], so in the upper resonator it would be roughly $\frac{1}{10}$ as large as in the lower resonator; whereas the rotation-induced effects should be the same in the two resonators. By subtracting the signals from the two resonators one should obtain the frame-dragging effect; and, as a check, one can verify that the signal's phase has the correct relationship to the modulation phase of the rotating mass.

Because of the need for a long damping time ($\tau^* \sim 10^5$ sec), enormous relative-frequency stability ($\Delta\omega/\omega \sim 10^{-17}$), and huge antiseismic compensation ($\sim 10^6$), this experiment may well be the most difficult one described in our paper. Nevertheless, it may be worth pursuing for reasons of technological spinoff; the toroidal cavity needed for the experiment is essentially an electromagnetic gyroscope, and even if the desired precision of 10^{-15} rad/ 10^5 sec $\simeq 10^{-20}$ rad/sec is never achieved, the more modest gyroscope produced by the effort could have technological uses.

B. "Light-deflection" experiment

At first sight it looks attractive to attempt a measurement of "light" deflection, and thereby of the PPN parameter γ , using a microwave resonator: Let an idealized beam of electromagnetic waves bounce back and forth inside an idealized, perfect, cylindrical microwave cavity of radius b . Place the cavity in a quadrupole gravitational field generated by masses M , as shown in Fig. 5. The gravitational force (light-deflection effect) will cause the orientation of the beam to oscillate with angular frequency

$$\begin{aligned}
\Omega &\simeq (1 + \gamma)^{1/2} (GM/b^3)^{1/2} \\
&\simeq 10^{-3} \text{ sec}^{-1} \text{ for } M \simeq 10^6 \text{ g}, b \simeq 50 \text{ cm}.
\end{aligned}
\tag{5.17}$$

As indicated above [Eq. (5.14) and associated discussion], one can hope to maintain the beam in the cavity for a time $\hat{\tau} \gg 10^{-3}$ sec, so the experiment looks promising.

Unfortunately, it is not. The simple light-de-

flection description is valid only so long as geometric optics is valid, i.e., only so long as the beam does not spread over the interior of the cavity, i.e., only for a time

$$\begin{aligned}
\tau_{\text{max}} &\simeq \frac{b}{v_{\text{spread}}} \simeq \frac{b}{c\lambda/2\pi b} \simeq \frac{2\pi b^2}{c\lambda} \\
&\simeq 3 \times 10^{-6} \text{ sec for } b \simeq 50 \text{ cm}, \lambda \simeq 0.2 \text{ cm}.
\end{aligned}
\tag{5.18}$$

Over this period of time, no measurable effect can be built up. Over longer periods the only effect of the static quadrupole gravitational field is to produce a frequency splitting

$$\Delta\omega/\omega \simeq (1 + \gamma)(GM/bc^2) \simeq 10^{-24}
\tag{5.19}$$

between various otherwise degenerate normal modes of the cavity, a splitting so small that it is hopeless to measure. [Note: the pendulum effect of Eq. (5.17) can be described in terms of mode splitting. For $\tau_{\text{max}} = 2\pi b^2/c\lambda \gtrsim 1/\Omega \simeq (b^3/GM)^{1/2}$, the pendulum angular frequency satisfies $\Omega/\omega \lesssim GM/bc^2$; and therefore, it can be produced by superpositions of many normal modes with the gravitational splittings (5.19).]

Taking account of wave-packet spreading, i.e., using normal-mode analyses of the resonator, we have not been able to invent a viable experimental configuration which uses a microwave resonator to measure the PPN parameter γ .

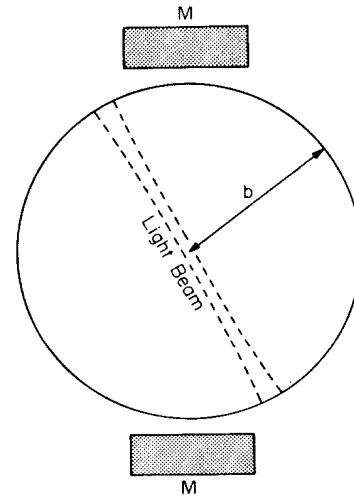

FIG. 5. Experimental configuration for an impossible measurement of the deflection of light.

VI. EXPERIMENTS USING MASSIVE DIELECTRIC CRYSTALS

The authors have previously suggested³ that one might perform post-Newtonian experiments of the following type: Rapidly varying post-Newtonian and Newtonian accelerations are produced by a massive ($M \approx 1 \times 10^5$ g), rotating or vibrating, non-symmetrical body, e.g., a prolate spheroid of iron rotating end-over-end. The linear velocity of rotation would be $v \approx 10^5$ cm/sec and the angular velocity $\omega \approx 5 \times 10^3$ sec⁻¹; and the Newtonian and post-Newtonian fields would vary with $\omega_0 = 2\omega$ and its harmonics, i.e., with a period $\tau_0 \approx 6 \times 10^{-4}$ sec. At typical locations near the source the Newtonian and post-Newtonian accelerations would have amplitudes

$$(F/m)_N \approx 10^{-6} \text{ cm/sec}^2, \quad (F/m)_{PN} \approx 10^{-17} \text{ cm/sec}^2. \quad (6.1)$$

These oscillating accelerations would be detected with a dielectric monocrystal (e.g., sapphire) in the manner of Sec. II B. It was our idea³ to separate the post-Newtonian accelerations from the Newtonian "noise" by some suitable combination of the following: (1) careful choice of shape and orientation of source, and of location and orientation of detector so that the Newtonian acceleration would not couple to the normal mode of the detector being used, (2) modulation of the orientation of the detector with angular frequency ω_{mod} and with amplitude designed to move the post-Newtonian force on the normal mode to a frequency, e.g., $\omega_0 + \omega_{\text{mod}}$, at which there was no Newtonian force.

It seemed to us at first that with so many parameters free for adjustment it should be easy to invent viable experimental configurations. However, our expectations were naive: As noted in Sec. III A, the necessity to reduce the Newtonian signal by $\geq 10^{12}$ means that the Newtonian signal produced by errors in typical parameters must be second order in all the errors, e.g.,

$$\frac{(F/m)_N}{10^{-8} \text{ cm/sec}^2} \sim \left(\frac{\text{error in location of detector}}{\text{size of apparatus}} \right)^2 + \left(\frac{\text{size of defects in source}}{\text{size of source}} \right)^2 + \dots \quad (6.2)$$

This places so many constraints on the experimental design that we have been able to invent only two apparently viable sets of post-Newtonian experiments that use a crystal detector: (i) gravitational "Faraday" experiments to detect the electric-type fields induced by time-changing magnetic-type gravity, and (ii) experiments to detect preferred-frame and preferred-orientation effects. These experiments are described below, along

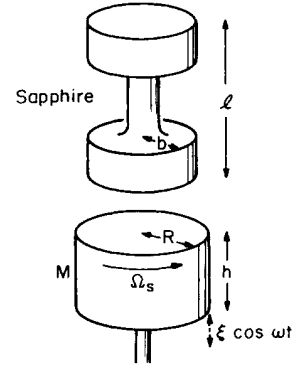

FIG. 6. Experimental configuration for detecting the gravitational analog of Faraday's law of induction.

with (iii) a (non-post-Newtonian) experiment to measure the gravity of high-velocity particles using a crystal detector.

A. Gravitational Faraday experiments

Equation (3.8b) implies that time-changing magnetic-type gravity \vec{H} produces a gravitational "electromotive force" (EMF) in any ring of matter \mathcal{C} :

$$\oint_{\mathcal{C}} \vec{g} \cdot d\vec{l} = -\frac{1}{c} \frac{d}{dt} \int_{\mathcal{S}} \vec{H} \cdot d\vec{S}. \quad (6.3)$$

Here \mathcal{S} is any surface bounded by \mathcal{C} . This is the gravitational analog of Faraday's⁴² law of induction.

As a special application of this law, consider a (nearly) nonrotating body at rest in a (nearly) homogeneous magnetic-type gravitational field. Let the field change by an amount $\Delta\vec{H}$. It is easy to show from Eq. (6.3) that this change will induce a change

$$\Delta\vec{\Omega} = -\frac{1}{2}c^{-1}\Delta\vec{H} \quad (6.4)$$

in the body's angular velocity.

The following analog of one of Faraday's original experiments⁴² would seek to detect this gravitational Faraday effect: A cylinder of mass M , radius R , and height $h \lesssim R$ is set into uniform rotation with angular velocity Ω_s (see Fig. 6). This rotating cylinder is then moved up and down, along its rotation axis, with amplitude ξ and frequency ω . Coaxial with this source is an appropriately shaped, axially symmetric sapphire crystal, which is threaded by the source's magnetic-type gravitational field. The motion of the source produces an oscillating gravitational EMF [Eq. (6.3)] in the sapphire, and this EMF drives torsional oscillations of the crystal with eigenfrequency equal to the frequency ω of source motion. If the maximum radius b and height l of the sapphire are less than or of order the radius R of the source, then the driving force in the sapphire is

$$\frac{F}{m} \approx \left(\frac{GM}{R^2}\right) \left(\frac{b}{R}\right) \left(\frac{l}{R}\right) \left(\frac{\Omega_s R}{c}\right) \left(\frac{\omega \xi}{c}\right)$$

$$\approx 1 \times 10^{-18} \text{ cm/sec}^2 \text{ for } b \approx l \approx R \approx h \approx 10 \text{ cm, } M \approx 3 \times 10^4 \text{ g, } \xi \approx 2 \text{ cm, } \omega \approx 500 \text{ sec}^{-1},$$

$$\omega \xi \approx 10^3 \text{ cm/sec, } \Omega_s R \approx 5 \times 10^4 \text{ cm/sec.}$$
(6.5)

Brownian noise in the crystal can be kept well below this level if the crystal has $Q \geq 10^{13}$ [$\tau^* \geq 10^{10}$ sec, cf. Eq. (2.12)]. Seismic "noise" can be filtered out at the high frequency ($\nu \approx 100$ Hz) of the crystal's oscillations. "Noise" from Newtonian-type gravity can be kept negligible if one can achieve a 10^{-7} perfection in the alignment and uniformity of crystal and generator. (Newtonian coupling requires imperfections of both generator and sensor, and it is proportional to the product of those imperfections.) This required perfection may be difficult to achieve, and it may also prove difficult to construct a sensor that measures the required amplitude change in the detector ($b\delta\phi \approx 1 \times 10^{-15}$ cm), without producing so much asymmetry on the detector that the Newtonian coupling of detector to generator becomes excessive.

In response to a preliminary version of this paper which contained no mention of any Faraday-type experiment, Ronald Drever (private communication) has suggested an experiment similar to this one. The key difference is that his generator would be a cylinder driven into torsional oscillations at the eigenfrequency of the crystal. To prevent breaking the generator one might have to keep its oscillation amplitude low enough that the post-Newtonian signal would be $F/m \approx 10^{-19}$ cm/sec, rather than $F/m \approx 10^{-18}$ cm/sec².

It might prove feasible to measure the induction effect [Eq. (6.4)] by a technique similar to the Everitt-Fairbank-Schiff gyroscope experiment.⁶ One would place a nonrotating sphere in an Earth-orbiting satellite with polar orbit and search for an angular oscillation of the sphere about the Earth's polar axis. The oscillation would be relative to the distant stars, not relative to gyroscopes located in the satellite. The oscillation frequency would be twice the orbital frequency, and the amplitude would be

$$\Delta\phi \approx \left(\frac{GM_E}{c^2 R_E}\right) \frac{\Omega_E}{(GM_E/R_E^3)^{1/2}} \approx 4 \times 10^{-11} \text{ rad.}$$
(6.6a)

Here M_E , R_E , and Ω_E are the mass, radius, and angular velocity of the Earth. The amplitude $\Delta\phi$ could be increased by using a high- Q resonant detector, e.g., a torsion oscillator of the type described in Sec. IIA with eigenfrequency twice the orbital frequency. For such an oscillator the Faraday-induced change in amplitude after a time $\hat{\tau}$

$\ll \tau^*$ = (damping time) would be

$$\delta(\Delta\phi) \approx \frac{1}{2} \left(\frac{GM_E}{c^2 R_E}\right) \Omega_E \hat{\tau} \approx 5 \times 10^{-8} \text{ rad for } \hat{\tau} \approx 10^6 \text{ sec.}$$
(6.6b)

It would be extremely difficult, but perhaps not impossible, to decouple such an oscillator from other sources of angular motion, e.g., aberration of the positions of reference stars.

Some day one might find a binary pulsar in which the induction effect is important. For a neutron star in a polar orbit of radius r around a maximally rotating Kerr black hole of mass M , the star's rotational angular velocity would be modulated with amplitude

$$\Delta\Omega \approx \frac{c^3}{GM} \left(\frac{GM}{c^2 r}\right)^3$$

$$\approx 1 \times 10^{-11} \text{ sec}^{-1} \text{ if } M \approx 3M_0 \text{ and } r \approx 1 \times 10^{11} \text{ cm.}$$
(6.7)

This is too small to measure at present in the known binary pulsar,⁴³ but too small by only a factor 1000. In a binary pulsar with a 10^{10} -cm orbital radius the induction effect might be measurable, but we have not attempted to determine whether one could separate it cleanly from other effects.

B. Preferred-frame and preferred-orientation experiments

We turn now to experiments which would use sapphire crystals to search for preferred-frame and preferred-orientation effects (see Sec. III). The experimental configuration is shown schematically in Fig. 7(a): The source, perhaps a prolate spheroid of mass M and largest radius R , rotates around its shortest principal axis, the z axis, with angular velocity $\omega \approx 6 \times 10^3 \text{ sec}^{-1}$. The detector, a cylindrical monocrystal of length b , is placed near the source with its axis of symmetry on the z axis (coincident with the rotation axis of the source). The rotation of the Earth causes the entire experiment to rotate with angular velocity $\Omega \approx 7 \times 10^{-5} \text{ sec}^{-1}$ relative to inertial space; and it might prove desirable to produce a more rapid rotation $\Omega \approx 10^{-2} \text{ sec}^{-1}$ by mounting the entire experiment on a rotating platform. Due to the motion of the solar system and galaxy, the laboratory moves with linear velocity \vec{w} ($|\vec{w}| \sim 2 \times 10^7 \text{ cm/sec}$) relative to the mean rest frame of the universe.

The central regions of the galaxy, with mass $M_G \approx 1 \times 10^{11} M_\odot$, distance from Earth $R_G \approx 10$ kpc, and direction from Earth \vec{k} , reach into the laboratory gravitationally to produce preferred-orientation effects.

Consider a particular element of mass $\rho d^3x'$ inside the source at location \vec{x}' . It moves relative to the center of mass of the detector with linear

velocity

$$\vec{v} = (\text{velocity due to source rotation } \omega) + (\text{velocity due to platform rotation } \Omega). \quad (6.8)$$

At a point \vec{x} inside the detector this mass element produces the following accelerations due to preferred-frame and preferred-orientation effects:

$$\begin{aligned} \left(\frac{\vec{F}}{m}\right)_{\text{PN}} = (-\Gamma_{00}^j \vec{e}_j)_{\text{PN}} = \frac{G\rho d^3x'}{c^2 r^2} \{ & -\alpha_2(\vec{w} \cdot \vec{n})\vec{v} + [(\frac{1}{2}\alpha_1 - \alpha_2)(\vec{v} \cdot \vec{n}) - \alpha_2(\vec{w} \cdot \vec{n})]\vec{w} - 2\zeta_w(GM_G/R_G)(\vec{k} \cdot \vec{n})\vec{k} \\ & + [3\alpha_2(\vec{v} \cdot \vec{n})(\vec{w} \cdot \vec{n}) + (\frac{1}{2}\alpha_1 - \alpha_2 - \alpha_3)(\vec{w} \cdot \vec{v}) \\ & + \frac{1}{2}(\alpha_1 - \alpha_2 - \alpha_3)\vec{w}^2 + \frac{3}{2}\alpha_2(\vec{w} \cdot \vec{n})^2 + 2\zeta_w(GM_G/R_G) + 3\zeta_w(GM_G/R_G)(\vec{k} \cdot \vec{n})^2]\vec{n}\} \quad (6.9) \end{aligned}$$

[cf. Eqs. (39.32b, c) of MTW² and Eq. (21) of Will's paper⁴]. Here r is the distance and \vec{n} is the direction between source point and field point

$$r \equiv |\vec{x} - \vec{x}'|, \quad \vec{n} \equiv (\vec{x} - \vec{x}')/r,$$

$\alpha_1, \alpha_2, \alpha_3$ are preferred-frame PPN parameters, and ζ_w is the Whitehead preferred-location PPN parameter. Simple geometric considerations show that the force (6.9), integrated over all parts of the source and all parts of the detector, will couple to several different normal modes of the detector. By careful selection of the rotational angular velocity of the source ω , the experimenter can produce a resonant, secular driving of any one of those normal modes, and can thereby measure, or place experimental limits on, the combination of PPN parameters which couple to that mode.

As an example, consider the acceleration

$$\left(\vec{F}/m\right)_{\text{PN}} = (G\rho d^3x'/r^2 c^2) [\frac{3}{2} \alpha_2(\vec{w} \cdot \vec{n})^2 + 3\zeta_w(GM_G/R_G)(\vec{k} \cdot \vec{n})^2] \vec{n}. \quad (6.10)$$

Geometric considerations show that it couples to the fundamental vibrational mode of the detector [Fig. 7(b)] with frequency

$$\omega_{\text{PN}} = 2(\omega \pm \Omega) \quad (6.11a)$$

and with amplitude

$$\begin{aligned} (F/m)_{\text{PN}} &\approx \left(\frac{1}{10} GM/R^2\right)(b/R) [\alpha_2 \vec{w}^2/c^2 + 2\zeta_w(GM_G/R_G c^2)] \\ &\approx \left(1 \times 10^{-12} \frac{\text{cm}}{\text{sec}^2}\right) \left[\alpha_2 \left(\frac{\vec{w}}{2 \times 10^7 \text{ cm/sec}}\right)^2 + 2\zeta_w \right] \text{ for } M \approx 10^5 \text{ g and } R \approx b \approx 20 \text{ cm}. \quad (6.11b) \end{aligned}$$

In the experiment feedback would be used on the source to keep ω_{PN} equal to the measured eigenfrequency ω_0 of the detector's fundamental mode, i.e., to keep the phase relations between the fundamental mode and the acceleration (6.10) constant to within $\delta\phi \lesssim 10^0$ over the time $\hat{\tau} \approx 10^6$ sec of the measurement. The techniques of Sec. II B would be used to measure the influence of this post-Newtonian force on the amplitude of the detector's vibrations.

As a second example, consider the acceleration

$$\left(\vec{F}/m\right)_{\text{PN}} = (G\rho d^3x'/r^2 c^2) (\frac{1}{2} \alpha_1 - \alpha_2 - \alpha_3) (\vec{v} \cdot \vec{w}) \vec{n}. \quad (6.12)$$

Geometric considerations show that it couples to the $m = 1$ (dipole) normal mode of the detector shown in Fig. 7(c) with frequency

$$\omega_{\text{PN}} = 2\omega \pm \Omega \quad (6.13a)$$

and with amplitude

$$\begin{aligned} (F/m)_{\text{PN}} &\approx \frac{1}{10} (\frac{1}{2} \alpha_1 - \alpha_2 - \alpha_3) (GM/Rc^2) (b/R) \omega |\vec{w}| \\ &\approx (3 \times 10^{-15} \text{ cm/sec}^2) (\frac{1}{2} \alpha_1 - \alpha_2 - \alpha_3) |\vec{w}| / (2 \times 10^7 \text{ cm/sec}) \\ &\text{for } M \approx 10^5 \text{ g, } R \approx b \approx 20 \text{ cm, } R\omega \approx 10^5 \text{ cm/sec}. \quad (6.13b) \end{aligned}$$

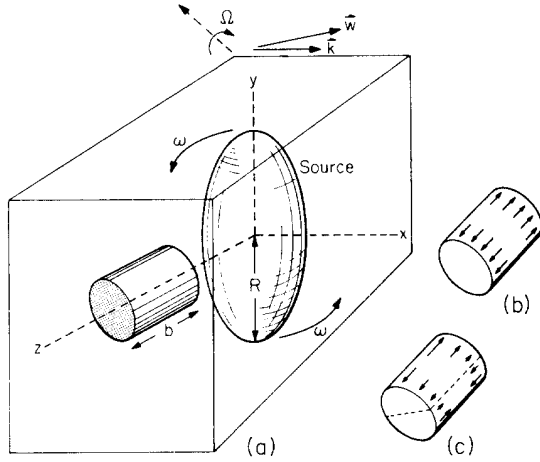

FIG. 7. (a) Experimental configuration for a set of preferred-frame experiments. (b) Motions of the detector excited in its fundamental mode; the type of excitation produced by the preferred-frame forces of Eq. (6.10). (c) Motions of the detector excited in a dipole mode; the type of excitation produced by the preferred-frame force of Eq. (6.12).

Newtonian "noise" is not a serious problem for these experiments. If the apparatus were perfectly constructed and aligned, there would be no Newtonian coupling whatsoever to either the fundamental mode or the dipole mode [Figs. 7(b), 7(c)] of the detector. Imperfections will lead to a coupling with amplitude and frequency

$$(F/m)_N \lesssim 10^{-12} \text{ cm/sec}^2, \quad \omega_N = 2\omega. \quad (6.14)$$

If the Ω rotation is produced by the Earth's rotation, there is no way to get any remotely significant Newtonian signal at the post-Newtonian frequencies (6.11a), (6.13a). If the apparatus is placed on a rotating platform, there will be some Newtonian signal at ω_{PN} , owing to deformations of the source caused by gravitational fields of objects in the external, non- Ω -rotating laboratory. However, simple estimates show that this Newtonian signal is far below the accuracy $F/m \approx 3 \times 10^{-18} \text{ cm/sec}^2$ that one might hope to achieve in the experiment.

From such experiments, performed with various orientations of the apparatus, one could hope to achieve limits of

$$\left| \alpha_2 \left(\frac{\vec{w}}{200 \text{ km/sec}} \right)^2 + 2\xi_w \right| \lesssim 3 \times 10^{-6}, \quad (6.15)$$

$$\left| \frac{1}{2} \alpha_1 - \alpha_2 - \alpha_3 \right| \frac{|\vec{w}|}{200 \text{ km/sec}} \lesssim 1 \times 10^{-3},$$

or, conceivably, positive measurements in violation of general relativity. It is worth noting that α_1 , α_2 , α_3 , and ξ_w are known from previous ex-

periments⁴⁴ to lie in the ranges

$$\begin{aligned} |\alpha_1| &\lesssim 0.07, & |\alpha_2| &\lesssim 0.002, \\ |\alpha_3| &\lesssim 2 \times 10^{-5}, & |\xi_w| &\lesssim 0.001, \end{aligned} \quad (6.16)$$

assuming that $|\vec{w}| \approx 200 \text{ km/sec}$. Consequently, the above two variants of the experiment can be regarded as new, improved measurements of α_1 , α_2 , and ξ_w .

The "magnetic-type" experiments described in Secs. IV A and V A are aimed at measuring

$$\frac{7}{8} \Delta_1 + \frac{1}{8} \Delta_2 = 4\gamma + 4 + \alpha_1. \quad (6.17)$$

γ is known to be unity to within ≈ 2 percent⁴⁵ and will likely be determined to within ≈ 0.3 percent by time-delay measurements on the Viking spacecraft. Consequently, the magnetic-type experiments, like one of the above preferred-frame experiments, are attempts to measure α_1 . The preferred-frame experiment should be much easier to perform than the magnetic-type experiments, and can place a much tighter limit on α_1 ($\lesssim 0.001$ vs $\lesssim 0.3$). Thus, if one believed that the PPN formalism embodied all possibilities for post-Newtonian gravity (which we do *not*), then one would put one's efforts into the preferred-frame experiment. On the other hand, if one wants to "see" magnetic-type gravitational forces for the first time in history, one will prefer the more difficult magnetic-type experiments.

C. Gravity at high velocities

Consider a point particle of mass m_0 which flies past a stationary observer with velocity v and impact parameter b . If gravity is a spin-two classical field as described by general relativity, the particle's gravity will give the observer an impulse

$$J_2 \equiv \int_{-\infty}^{+\infty} \left(\frac{F}{m} \right) dt = \frac{2Gm_0}{\gamma vb} (1 + 2\gamma^2 v^2/c^2), \quad (6.18)$$

where $\gamma \equiv (1 - v^2/c^2)^{-1/2}$. If gravity were an attractive spin-one field (analog of electromagnetism, Exercise 7.2 of MTW²), the impulse would be

$$J_1 \equiv \int_{-\infty}^{+\infty} \left(\frac{F}{m} \right) dt = \frac{2Gm_0}{vb}, \quad (6.19)$$

and if gravity were a spin-zero field (scalar field, Exercise 7.1 of MTW²), the impulse would be

$$J_0 \equiv \int_{-\infty}^{+\infty} \left(\frac{F}{m} \right) dt = \frac{2Gm_0}{\gamma vb}. \quad (6.20)$$

At low velocities the impulses are indistinguishable, but for $\gamma \gg 1$ they are very different— $J_2:J_1:J_0 = 2\gamma^2:\gamma:1$. There may be other ways of theorizing about the γ dependence of the impulse, but these

elementary considerations already show that it is of some interest.

It may be possible to test the γ dependence using as a source protons that circulate around a storage ring, and as a detector a monocrystal of sapphire sitting just outside the beam pipe. In such an experiment one would bunch the protons so they all fly past the crystal during a time interval Δt short compared to the crystal's eigenperiod τ_0 ; and one would adjust τ_0 to equal the proton circuit time in the storage ring,

$$\tau_0 = \mathcal{C}/c = (3 \times 10^{-6} \text{ sec})(\mathcal{C}/1 \text{ km}), \quad (6.21)$$

where $\mathcal{C} \equiv$ ring circumference. Then the gravitational acceleration would occur over and over again at the same phase of the crystal oscillation and (hopefully) would produce a measurable change in the crystal's amplitude and phase.

If I is the total beam current in the ring, e is the proton charge, and b is the distance from the center of the beam pipe to the crystal, then the time-averaged gravitational acceleration is

$$\begin{aligned} (F/m)_{\text{avg}} &\equiv (1/\tau_0) \int_0^{\tau_0} (F/m) dt = (I/e)J \\ &= \frac{2G(m_p/e)I}{\gamma v b} (1 + 2\gamma^2 v^2/c^2) \text{ for general relativity} \\ &\approx 1 \times 10^{-19} \text{ cm/sec}^2 \text{ for } \gamma m_p c^2 \approx 1000 \text{ GeV, } I \approx 10 \text{ A, } b \approx 10 \text{ cm.} \end{aligned} \quad (6.22)$$

This time-averaged acceleration, hitting impulsively at fixed phase, will produce the same long-term amplitude change in the crystal as a sinusoidal acceleration of amplitude

$$(F/m)_{\text{eff}} = 2(F/m)_{\text{avg}} = 2 \times 10^{-19} \text{ cm/sec}^2 \quad (6.23)$$

for above parameters. For comparison, the intersecting storage rings now operating at CERN have $\gamma m_p c^2 \approx 30 \text{ GeV}$, $I \approx 20 \text{ A}$, $\mathcal{C} \approx 1 \text{ km}$, the POPAE storage rings proposed for Fermilab would have $\gamma m_p c^2 \approx 1000 \text{ GeV}$, $I \approx 5 \text{ A}$, $\mathcal{C} \approx 5.5 \text{ km}$, and the ISABELLE storage rings proposed for Brookhaven would have $\gamma m_p c^2 \approx 200 \text{ GeV}$, $I \approx 10 \text{ A}$, $\mathcal{C} \approx 2.7 \text{ km}$. Thus, an experiment with $(F/m)_{\text{eff}} \approx 1 \times 10^{-19} \text{ cm/sec}^2$ does not seem unreasonable; and it may be possible to operate the storage rings at somewhat higher beam currents, thereby strengthening the signal.

This experiment would face serious, but perhaps surmountable problems from fluctuational forces in the crystal [Eq. (2.12)] and back-action forces of the sensor on the crystal [Eq. (2.11)]. For the POPAE design parameters with a 10-A current rather than 5 A, the signal strength and crystal eigenfrequency are $(F/m)_{\text{eff}} \approx 2 \times 10^{-19} \text{ cm/sec}^2$, $\omega_0 = 2\pi c/\mathcal{C} \approx 3.4 \times 10^5 \text{ sec}^{-1}$. A sapphire crystal with this ω_0 would have length $b \approx 10 \text{ cm}$, and with a radius $a \approx 10 \text{ cm}$, its mass would be $m \approx 10^4 \text{ g}$. To keep the internal fluctuational forces below $5 \times 10^{-20} \text{ cm/sec}^2$ during a measurement time $\hat{\tau} \approx 3 \times 10^6 \text{ sec}$ at a crystal temperature $T_0 \approx 1 \times 10^{-3} \text{ K}$, one must achieve a crystal damping time of $\tau^* \approx 1 \times 10^{10} \text{ sec}$ [Eq. (2.12)]. This corresponds to $Q = \pi \tau^*/\tau_0 \approx 2 \times 10^{15}$. Such a Q is easily compatible with theoretical limits on sapphire crystals [cf. Eq. 2.13]; however, several years of

crystal development and experimentation are needed before one can know how hard it will be to achieve such a Q in practice.

For the above parameters and for the sensor described by Eq. (2.11), the fluctuational back-action force of the sensor on the crystal would be $F/m \approx 7 \times 10^{-19} \text{ cm/sec}^2$. This is a factor 3 larger than the signal. Thus, unless a substantial improvement in beam current were achieved, thereby raising the signal substantially, one would have to devise a sensor better than that of Eq. (2.11). That one can do so, at least in principle (but just barely), without resorting to "quantum nondemolition techniques,"⁴⁶ is evident from the following: The signal $(F/m)_{\text{eff}} \approx 2 \times 10^{-19} \text{ cm/sec}^2$ produces an amplitude change in the crystal

$$\Delta x_0 = \frac{1}{2} (F/m)_{\text{eff}} \hat{\tau} / \omega_0 \approx 9 \times 10^{-19} \text{ cm} \quad (6.24)$$

which satisfies the constraint for "quantum-demolition" sensors⁴⁷

$$\frac{1}{2} m (\omega_0 \Delta x_0)^2 / (\hbar \omega_0) \approx 1.3 > 1. \quad (6.25)$$

These stringent requirements on the Q of the crystal and the performance of the sensor would be much alleviated (i) if there existed storage rings of circumference $\mathcal{C} \gg 5 \text{ km}$ (thus permitting lower ω_0 and larger m for the crystal), or (ii) if a ring with $\mathcal{C} \approx 5 \text{ km}$ could achieve a beam current $I \gg 10 \text{ A}$.

It appears to us that this experiment need not encounter serious problems with Newtonian gravitational noise due to flexing of the beam tube as the protons pass and other motions of macroscopic masses. Nor should electromagnetic forces of the passing protons be a problem if the crystal is reasonably shielded.

However, a very serious problem is the bombardment of the crystal by particles produced in collisions of the proton beam with residual gas in the beam tube. The most serious effect of such particles might be heating of the crystal with consequent degradation of the Q of its fundamental mode. To circumvent this one would have to continually remove thermal energy from the crystal, perhaps through a wire by which it is suspended. Also serious might be the damage of the crystal by particles passing through it, and direct excitation of its fundamental mode. It is impossible to assess these effects reliably without experimental tests. Our crude estimates suggest that with reasonable amounts of shielding one *might* prevent them from seriously degrading the experiment; but we would not be surprised if they were so serious as to make this experiment even more difficult than the Davies frame-dragging experi-

ment (Sec. VA).

VII. CONCLUSIONS

None of the experiments described in this paper would be easy to perform. They all stretch the limits of current technology. However, most of them are close to those limits, and may turn out to be within those limits if the experimenter is sufficiently clever and dedicated. We suggest that now is the time for experimenters to begin work on detailed feasibility studies and design studies for these experiments, and for others that use similar technology.

ACKNOWLEDGMENTS

For helpful discussions we thank John Dick, David Douglass, Ronald Drever, Richard Feynman, and John Turneure.

*This paper draws upon work which was supported in part by the Ministry of Higher Education, U.S.S.R., and upon work supported in part by the National Aeronautics and Space Administration under Contract No. NGR-05-002-256 and the National Science Foundation under Grant No. AST75-01398 A01.

†Work supported in part by a National Science Foundation Predoctoral Fellowship and a Feynman Fellowship.

¹An important exception involving laboratory generators of gravity and laboratory detectors was the experiment to test the equality of active and passive gravitational mass by L. B. Kreuzer, *Phys. Rev.* **169**, 1007 (1968).

²For details and references see, e.g., Chap. 40 of C. W. Misner, K. S. Thorne, and J. A. Wheeler, *Gravitation* (Freeman, San Francisco, 1973), cited henceforth as MTW.

³Preliminary versions of the material in this paper have been presented at meetings of the American Physical Society: see V. B. Braginsky, C. M. Caves, and K. S. Thorne, *Bull. Am. Phys. Soc.* **20**, 98 (1975); **20**, 1488 (1975).

⁴C. M. Will and K. Nordtvedt, Jr., *Astrophys. J.* **177**, 757 (1972); Chap. 39 of MTW (Ref. 2); and C. M. Will, *Astrophys. J.* **185**, 31 (1973).

⁵V. B. Braginsky and A. B. Manukin, *Measurement of Small Forces in Physical Experiments: Techniques and Fundamental Limitations* (Nauka, Moscow, 1974) (English translation in preparation by Univ. of Chicago Press).

⁶C. W. F. Everitt, in *Experimental Gravitation, Proceedings of Course 56 of the International School of Physics "Enrico Fermi"*, edited by B. Bertotti (Academic, New York, 1974), p. 331. See especially Eq. (26) and associated discussion; and note that the damping time is independent of the spin velocity of the ball.

⁷V. B. Braginsky and V. I. Panov, *Zh. Eksp. Teor. Fiz.* **61**, 873 (1971) [*Sov. Phys.—JETP* **34**, 463 (1972)].

⁸Kh. S. Bagdasarov, V. B. Braginsky, and V. P. Mitrofonov, results reported at International Symposium on Experimental Gravitation, Pavia, Italy, 1976 (unpub-

lished); for earlier results see paper by the same authors in *Kristallografiya* **19**, 883 (1974) [*Sov. Phys.—Crystallogr.* **19**, 549 (1975)].

⁹H. Pfister, *Cryogenics* **16**, 17 (1976).

¹⁰ J_{ω}^{hor} comes from Fig. 1 of J. Berger and J. Levine, *J. Geophys. Res.* **79**, 1210 (1974).

¹¹ J_{ω}^{vert} comes from the following references: Fig. 1 of R. J. Warburton, C. Beaumont, and J. M. Goodkind, *Geophys. J. R. Astron. Soc.* **43**, 707 (1975); Fig. 2 of J. Weber and J. V. Larson, *J. Geophys. Res.* **71**, 6005 (1966); and the ambient spectrum of Figs. 3 and 4 of B. Block, J. Dratler, Jr., and R. D. Moore, *Nature (London)* **226**, 343 (1970).

¹²H. Paik, in *Experimental Gravitation, Proceedings of Course 56 of the International School of Physics "Enrico Fermi"* (Ref. 6), p. 515.

¹³V. B. Braginsky, in *Gravitational Radiation and Gravitational Collapse, IAU Symposium No. 64*, edited by C. Morette-DeWitt (Reidel, Dordrecht, 1974); also, V. B. Braginsky, in *Proceedings of the International School of Cosmology and Gravitation, Course 4: Gravitational Waves*, edited by J. Weber (Plenum, New York, to be published).

¹⁴See, e.g., F. Schmid and D. J. Viechnicki, *Solid State Technol.* **16**, 45 (1973).

¹⁵W. M. Fairbank, S. P. Boughn, H. Paik, M. S. McAshan, J. E. Opfer, R. C. Taber, W. O. Hamilton, B. Pipes, T. Bernat, and J. M. Reynolds, in *Experimental Gravitation, Proceedings of Course 56 of the International School of Physics "Enrico Fermi"* (Ref. 6), p. 294.

¹⁶C. M. Caves, papers in preparation.

¹⁷See also K. S. Thorne and V. B. Braginsky, *Astrophys. J. Lett.* **204**, L1 (1976) for a brief discussion of the use of superconducting-cavity stabilized oscillators as clocks in Doppler-tracking searches for gravitational waves.

¹⁸See, e.g., J. P. Turneure, in *Proceedings of the 8th International Conference on High Energy Accelerators* (CERN, Geneva, 1971), p. 51.

- ¹⁸M. A. Allen, Z. D. Farkas, H. A. Hogg, E. W. Hoyt, and P. B. Wilson, *IEEE Trans. Nucl. Sci.* **18**, 168 (1971).
- ²⁰S. R. Stein and J. P. Turneaure, *IEEE Proc.* **63**, 1249 (1975).
- ²¹C. M. Will, in *Experimental Gravitation Proceedings of Course 56 of the International School of Physics "Enrico Fermi"* (Ref. 6), p. 1; D. L. Lee, A. P. Lightman, and W.-T. Ni, *Phys. Rev. D* **10**, 1685 (1974).
- ²²This fact follows from Eq. (39.27) of MTW (Ref. 2).
- ²³R. L. Forward, *Proc. IRE* **49**, 892 (1961); see also references cited therein.
- ²⁴In a series of experiments performed in 1820, Ampère explored the magnetic interactions of electric currents. Ampère described his results in readings presented to the Académie Royale des Sciences on September 18 and 25, 1820 [A.-M. Ampère *Ann. Chim. Phys.* **15**, pp. 59–76, 177–208 (1820); English translations of portions of these papers can be found in R. A. R. Tricker, *Early Electrodynamics: The First Law of Circulation* (Pergamon, New York, 1965)]. In addition to his famous experiment investigating the magnetic forces between parallel conductors, Ampère also demonstrated that two current-carrying spiral-shaped wires attract and repel each other like permanent magnets.
- ²⁵R. A. Van Patten and C. W. F. Everitt, *Phys. Rev. Lett.* **36**, 629 (1976).
- ²⁶P. K. Chapman, paper presented at the 26th Congress of the International Astronautical Federation, Lisbon, 1975 (unpublished).
- ²⁷W. W. Salisbury, *Nature (London)* **224**, 783 (1969); E. Frehland, *Nature (London)* **230**, 11 (1971); J. Jaffe, *Gen. Relativ. Gravit.* **6**, 49 (1975).
- ²⁸R. F. O'Connell and S. N. Rasband, *Nature (London)* **232**, 193 (1971); Jaffe, Ref. 27.
- ²⁹An exception is an unpublished proposal by S. N. Rasband, 1974, for an experiment to measure the gravitational spin-spin force using a monocrystal of sapphire as a detector. This experiment might conceivably be performable, but it looks much less promising to us than the experiments described in Secs. IV A and VI A of this paper.
- ³⁰See, e.g., R. F. Post and S. F. Post, *Sci. Am.* **229**, 17 (1973); also D. W. Rabenhorst, Applied Physics Laboratory, Johns Hopkins Univ., papers presented at various engineering meetings (unpublished).
- ³¹One can readily construct an idealized example of such a source using two thin rings.
- ³²P. G. Roll, R. Krotkov, and R. H. Dicke, *Ann. Phys. (N.Y.)* **26**, 442 (1964).
- ³³P. W. Worden, Jr. and C. W. F. Everitt, in *Experimental Gravitation, Proceedings of Course 56 of the International School of Physics "Enrico Fermi"* (Ref. 6), p. 381.
- ³⁴M. P. Haugan and C. M. Will, *Phys. Rev. Lett.* **37**, 1 (1976).
- ³⁵The coupling of gravitational energy has been checked using as test masses the Earth and Moon (Nordtvedt effect) by J. G. Williams *et al.*, *Phys. Rev. Lett.* **36**, 551 (1976); and by I. I. Shapiro, C. C. Counselmann III, and R. W. King, *ibid.* **36**, 555 (1976).
- ³⁶R. von Eötvös, *Ann. Phys. Chem.* **59**, 354 (1896).
- ³⁷I. I. Shapiro, result reported in Washington, D.C. meeting of American Association for the Advancement of Science, 1976 (unpublished). For earlier results from the same type of experiment, see I. I. Shapiro, W. B. Smith, M. E. Ash, R. P. Ingalls, and G. H. Pettingill, *Phys. Rev. Lett.* **26**, 27 (1971).
- ³⁸See, e.g., the discussion of "self-regeneration" of pressure on p. 605 of MTW; also see R. V. Wagoner and R. C. Malone, *Astrophys. J. Lett.* **189**, L75 (1974).
- ³⁹R. W. Davies, in *Experimental Gravitation, Proceedings of Course 56 of the International School of Physics "Enrico Fermi"* (Ref. 6), p. 331.
- ⁴⁰J. M. Bardeen, *Astrophys. J.* **162**, 71 (1970). The relevant part of this reference is summarized in Exercise 33.3 of MTW.
- ⁴¹See, e.g., G. Birnbaum, *Optical Masers* (Academic, New York, 1964), Chap. 6.
- ⁴²M. Faraday, *Phil. Trans.* (1832), p. 125.
- ⁴³J. H. Taylor, R. A. Hulse, L. A. Fowler, G. E. Gull-ahorn, and J. M. Rankin, *Astrophys. J. Lett.* **206**, L53 (1976).
- ⁴⁴K. Nordtvedt, Jr. and C. M. Will, *Astrophys. J.* **177**, 775 (1972); M. G. Rochester and D. E. Smylie, *J. Geophys. Res.* **79**, 4948 (1974); R. J. Warburton and J. M. Goodkind, *Astrophys. J.* **208**, 881 (1976).
- ⁴⁵E. B. Fomalant and R. A. Sramek, *Phys. Rev. Lett.* **36**, 1475 (1976).
- ⁴⁶V. B. Braginsky and Yu. I. Vorontsov, *Usp. Fiz. Nauk.* **114**, 41 (1974) [*Sov. Phys.—Usp.* **17**, 644 (1975)]; also V. B. Braginsky, Yu. I. Vorontsov, and V. D. Krivchenkov, *Zh. Eksp. Teor. Fiz.* **68**, 55 (1975) [*Sov. Phys.—JETP* **41**, 28 (1975)].
- ⁴⁷See, e.g., R. Giffard, *Phys. Rev. D* **14**, 2478 (1976); or Eq. (3.17) of V. B. Braginsky, *Physics Experiments with Test Bodies* (Nauka, Moscow, 1970), English translation published as Report No. NASA-TT F762, available from National Technical Information Service, Springfield, Virginia.