

## Laboratory study of soil-nail interaction in loose, completely decomposed granite

S.M. Junaideen, L.G. Tham, K.T. Law, C.F. Lee, and Z.Q. Yue

**Abstract:** The technique of soil nailing is seldom used in stabilizing loose fill slopes because there is a lack of understanding of the interaction behaviour of nails in loose fills. A large-scale laboratory apparatus has been built to study the soil-nail interaction in loose fill materials. Pullout tests were performed in a displacement-rate-controlled manner on steel bars embedded in loose, completely decomposed granitic soils. The load-displacement curves have distinct peak values followed by a sharp decrease in the pullout force. The test results also show that the normal stress acting on the nail changes because of the volume-change tendency and arching effect of the soil being sheared around the nail. The post-peak decrease in the pullout force is mainly due to the reduction in the normal stress caused by the arching effect of soil around the nail. The conventional method of analysis tends to give a low interface friction angle and high interface adhesion. The correct interface parameters can be determined by taking the changes in the normal stress acting on the nail into account.

**Key words:** arching effect, interface friction angle, laboratory test, loose fill, pullout resistance, soil-nail interaction.

**Résumé :** La technique de clouage du sol est rarement utilisée pour stabiliser les talus de remblai meuble parce qu'on comprend mal le comportement de l'interaction des clous dans les remblais meubles. Des essais d'arrachement ont été réalisés à taux de déplacement contrôlé sur des barres d'acier enfouies dans des sols granitiques meubles complètement décomposés. Les courbes charge-déplacement ont des valeurs de pic nettes suivies par une diminution abrupte de la force d'arrachement. Les résultats d'essais montrent également que la contrainte normale agissant sur les clous change à cause de la tendance au changement de volume et à l'effet d'arc-boutement du sol qui se cisaille autour du clou. La diminution post-pic de la force d'arrachement est due principalement à la réduction de la contrainte normale causée par l'effet d'arc-boutement du sol autour du clou. La méthode conventionnelle d'analyse tend à donner un faible angle de frottement et une valeur élevée de l'adhésion à l'interface. Les bons paramètres d'interface peuvent être déterminés en prenant en compte les changements de la contrainte normale agissant sur le clou.

**Mots clés :** effet d'arc-boutement, angle de frottement à l'interface, essai de laboratoire, remblai meuble, résistance à l'arrachement, interaction sol-clou.

[Traduit par la Rédaction]

### Introduction

Rapid economic growth in Hong Kong in the 1950s and 1960s resulted in significant construction activity, and flat lands were extended to provide platforms for buildings, roads, and other infrastructures. This frequently required cutting of slopes and filling of valleys. Fill slopes were constructed based on empirical experience with lack of geotechnical supervision. Many fill slopes were formed by end tipping without proper compaction. This has led to the po-

tential formation of thousands of loose fill slopes. It is projected that there could be about 6000 pre-1977 fill slopes (Sun 1999). According to the current standards, many of the pre-1977 fill slopes are considered to be substandard and require upgrading.

Decomposed granites and volcanics are generally used as fill materials in Hong Kong. The fill slope materials are mostly completely decomposed granite (CDG), which is commonly described as silty sand with some fine gravel. The past laboratory tests (Government of Hong Kong 1976; Ng and Lumb 1980; Law et al. 1997) on loose CDG materials exhibited significant volumetric compression upon shearing. Loose fill slopes comprise partially saturated soils and maintain suction. When water ingress into the slope occurs, the suction decreases in a drained manner. The strength of the soil decreases and shear stress increases slightly as a result of an increase in the weight of the soil. At a condition when the shear strength of the soil is no longer able to sustain equilibrium, shear strain begins to increase, causing a further reduction in shear strength of the soil. This will require load transfer to the surrounding soil, which will spread

Received 29 August 2002. Accepted 7 November 2003.

Published on the NRC Research Press Web site at <http://cgj.nrc.ca> on 8 April 2004.

S.M. Junaideen, L.G. Tham,<sup>1</sup> C.F. Lee, and Z.Q. Yue.

Department of Civil Engineering, The University of Hong Kong, Pokfulam Road, Hong Kong.

K.T. Law. Department of Civil and Environmental Engineering, Carleton University, 1125 Colonel By Drive, Ottawa, ON K1S 5B6, Canada.

<sup>1</sup>Corresponding author (e-mail: [hrectlg@hkucc.hku.hk](mailto:hrectlg@hkucc.hku.hk)).

the failure zone. The failure could occur on a rupture surface by sliding or in a zone of significant thickness within which the soil can flow due to static liquefaction.

There have been failures of loose fill slopes in Hong Kong. The failure types observed can be classified as sliding, washout, and static liquefaction. Wong et al. (1998) reported that 45% of the major fill slope failures ( $>50 \text{ m}^3$ ) involved major washout and 10% involved static liquefaction. The major loose fill failures that caused loss of lives and damage to properties are attributed to heavy seasonal rainfalls and it is understood that they involved static liquefaction.

A recompaction method with the provision of surface and subsurface drainage has been conventionally used to upgrade the old loose fill slopes. This method has practical limitations, however. Temporary cuttings in loose fill slopes during the recompaction work make the slopes unstable and pose risks. Construction time required for the remedial work is often long, and it has not always been possible for contractors to complete the work within the dry season. This method is also not suitable for congested sites. In many cases, it is difficult to implement the recompaction work due to the presence of existing services and mature trees. Thus, there are large numbers of potentially substandard fill slopes that remain untreated and there is a need to search for alternative methods to enhance the stability of loose fill slopes.

One possible and economical way to stabilize these slopes is through the use of soil nails. Soil nailing is a technique for reinforcing slopes and earth-retaining walls using closely spaced subhorizontal nails. Soil nailing is used extensively in Hong Kong in soil cut slopes and retaining walls; however, the technique is seldom used in loose fill slopes, as there is a lack of understanding of the interaction behaviour of soil nails in loose fills. The Geotechnical Division of the Hong Kong Institution of Engineers (HKIE) completed a preliminary study on the possibility of using soil nails in loose fill slopes (HKIE 1998). It has been shown that it is theoretically possible to use soil nails in the loose CDG fills. There are some practical concerns, however.

Soil nails can be installed passing through the identified potential failure surface or zone. The combined resistance of the nail and soil can provide the required factor of safety if the nail can pick up adequate resistance in the active zone (the zone above the potential failure surface). Soil nails are passive elements, and soil movement in the active zone will mobilize stresses on the nails. The available resistance in the resisting zone (the zone below the potential failure surface) can never exceed the total resistance mobilized in the active zone, which is a combination of nail resistance in the active zone and resistance provided by the nail head. Pullout failure in the active zone is not normally considered in soil nailing designs, but it should be given serious consideration in loose fill slope stabilization.

It is of concern that the soil on either side of the failure surface may be too weak to provide enough anchorage for the nails to mobilize forces, and in the wet condition of the fill the resistance provided by the nails could be very low. Quantitative understanding of nail resistance in loose fill materials is important to assess the nail forces mobilized and the consequences.

A research program is currently in progress at the University of Hong Kong to study soil–nail interaction in loose fill materials. A large-scale laboratory setup consisting of a test box, two loading frames, and a pulling apparatus has been used to conduct pullout tests in a displacement-rate-controlled manner. The results of the tests performed on three types of steel bars embedded in loose CDG are presented here.

## Review of previous works

In soil nailing designs, limit equilibrium methods are commonly employed to estimate the total nail force required to maintain a specified global factor of safety. Nail density and length are assumed based on the estimation of pullout resistance of the nails. Generally, a factor of safety of 1.5 or 2 is used against the estimated pullout resistance, and the contribution of bending and shear resistance of nails is ignored. The nail resistance estimated by analytical or empirical means is validated during construction by field pullout tests.

Some designers consider that soil–nail resistance is directly correlated with overburden pressure both for driven nails and for nails installed in drilled holes. In one of the earliest published soil nailing works, Shen et al. (1981) assumed that the maximum bond stress is governed by the Coulomb failure criterion. Jewell (1990) presented the following formula to estimate the pullout resistance:

$$[1] \quad T = \pi D L_a \sigma'_r f_b \tan \phi'$$

where  $T$  is the pullout force,  $D$  is the nail diameter,  $L_a$  is the anchorage length,  $\sigma'_r$  is the average normal effective stress ( $1 \geq \sigma'_r / \sigma'_v \geq 0.7$  for steep slopes with lightly overconsolidated soils, where  $\sigma'_v$  is the vertical effective stress),  $f_b$  is the bond coefficient (1.0 for a fully rough interface and 0.2–0.4 for a smooth interface), and  $\phi'$  is the effective angle of internal friction.

Cartier and Gigan (1983) correlated the pullout resistance of driven nails in granular soil with vertical stress and the apparent coefficient of friction ( $\mu^*$ ) to make a comparison with the design values of  $\mu^*$  used in reinforced earth structures. It appears that this correlation as given by eq. [2] has been adopted by the practicing engineers in Hong Kong (Powell and Watkins 1990) and in other countries (e.g., Seto et al. 1992) for grouted nails. This semiempirical approach with  $\mu^* = \tan \phi'$  as an upper limit and soil cohesion  $c' = 0$  as a lower limit seems widely accepted, probably because of its simplicity and conservatism:

$$[2] \quad P = \theta c' + 2D \sigma_v \mu^*$$

where  $P$  is the pullout force per metre of buried length of the nail,  $\theta$  is the perimeter of the reinforcing nail,  $D$  is the width of the equivalent flat reinforcement strip, and  $\sigma_v$  is the theoretical vertical stress at the mid-depth of the reinforcing nail.

Some designers, however, consider that the methods of installation destroy the influence of the overburden pressure and the soil–nail resistance is independent of depth. Gassler (1983, 1992) argued that in medium-dense or dense soils the

shear resistance mobilized along the reinforcing members depends, apart from the overburden pressure and the angle of internal friction, on the effects on restrained dilatancy in the shear zone between nail and soil. Moreover, with any kind of drilling system, the initial stress conditions are changed in the ground surrounding the reinforcing members. Guilloux and Schlosser (1982) reported the results of pullout tests carried out by Cartier and Gigan (1983) on driven angle bars in silty sand which showed the maximum shear stress mobilized is not heavily dependent on depth. They explained the results by the restrained dilation of the soil, an idea extended from observations on reinforced earth walls. At shallow depths, during the mobilization of tensile force, the soil in the vicinity of the reinforcement tends to increase in volume under the effects of shearing stresses. This tendency is restrained by the surrounding soil, thereby causing an increase in the normal stress acting on the nail. The dilative tendency will decrease with depth, but the pullout resistance will be more or less the same with depth, since the effect will be compensated by the increase of vertical stress.

Therefore, some designers tend to use the databank compiled from previous pullout test results to estimate the pullout resistance. Elias and Juran (1991) provided a summary of ultimate pullout stress as a function of soil type and installation technique. Attempts have also been made to correlate pullout resistance with soil properties obtained from commonly used *in situ* tests. Ortigaó and Palmeira (1997) reported the correlation used in Brazil between pullout resistance and *N* values from the standard penetration test. Based on the results of pullout tests in residual soils, Heymann et al. (1992) proposed that the ultimate shear stress between nail and residual soil can be limited to  $2N$  (kPa). Schlosser (1993) provided preliminary design charts to estimate pullout resistance for gravity grouted and driven nails in various types of soils.

There is no consensus on the methods used to estimate pullout resistance. In loose fills it could be expected that the pullout resistance of nails would be small due to the loose nature and possible collapse behaviour of the soil. A large-scale laboratory study would be helpful to improve the understanding of the interaction behaviour of nails in loose fill materials.

Field pullout tests and laboratory tests have been used to study pullout resistance. Large numbers of field pullout tests were carried out by the French National Research Project Clouterre (Schlosser 1993), and the results were empirically correlated with the pressure limit  $P_1$  measured with the pressuremeter. The measured pullout resistance in the field is often high for several reasons: (i) ground conditions and effective nail size can be different from the assumed situation, (ii) stress changes in the ground during installation, and (iii) stress changes around the nail during the pullout test. It has been difficult to establish reliable analytical methods from field pullout test results. Furthermore, pullout testing procedures are not yet standardized. Barley et al. (1997) presented a review of the current field-testing methods. Force-controlled pullout tests are widely used to verify the design values, hence sometimes the nail is not loaded up to failure and therefore compilation of such pullout test data is of little use to establish any analytical methods.

There have been efforts to study soil–nail interaction us-

Fig. 1. The test apparatus.

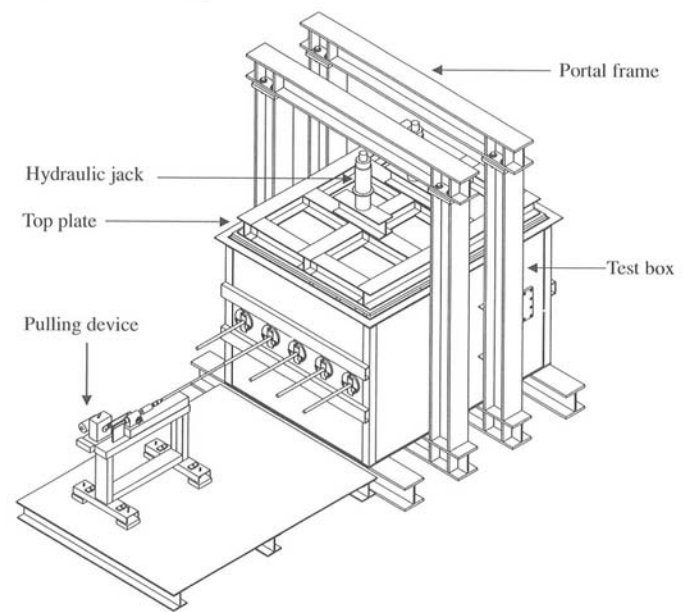

ing a large direct shear box (Barr et al. 1991; Davies et al. 1992) and laboratory pullout tests (Milligan et al. 1997; Franzen 1998). Milligan et al. (1997) attempted to study the effects of initial stress in the soil, grouting pressure, and stress changes during the pullout test on the pullout resistance by directly measuring the soil–nail contact stresses with innovative instrumentation. Some preliminary results have been reported. Franzen (1998) used a large laboratory setup to study the pullout resistance of driven nails in dry, poorly graded, fine sand.

Jewell (1983) pointed out that there is an important difference between (i) soil deforming and straining under self-weight or applied loading and reacting to the presence of the reinforcement in the soil, and (ii) soil at rest with reinforcement being displaced and pulled out from the soil. It is therefore questionable if such a high resistance could be mobilized under field conditions. The pullout test is used by designers and researchers, however, because it is the best and simplest test available.

### Details of the laboratory setup

An overview of the laboratory apparatus is shown in Fig. 1. The apparatus consists of three major parts: a large box (2 m long  $\times$  1.6 m wide  $\times$  1.4 m high) to accommodate soil samples and nails, two portal frames (2.4 m high  $\times$  2.4 m wide) straddling the box for the application of vertical pressure, and a pulling device to pull the nails at a constant rate.

#### Test box

The box is built of steel and rigid enough for a vertical loading range up to 150 kPa, which is equivalent to the overburden pressure of 6 to 7 m of fill. The inside is lined with stainless steel sheet to minimize side friction. Steel angles are used to join the steel plates, and the box is waterproof. Five holes in the front wall allow the nails to stick out for pulling. The size and number of nails can be limited to avoid the influence of the boundary and the interaction between

the nails induced when the pullout test is being carried out. The zone of influence reported in the literature for piles and vertical cylindrical anchors (e.g., Hsu and Liao 1998) varies from two to five times the diameter from the centre. In the present study, a minimum horizontal distance of 10 times the diameter was allowed between the nails, and this was found to be more than adequate.

### Application of vertical pressure

Fluid-filled rubber cushion is commonly used to apply confining pressures (Milligan et al. 1997; Franzen 1998). Pressure is generated by pumping air or water to the fluid-filled cushion placed between the boundary on which the pressure is to be applied and a rigid wall. There are at least two concerns about the use of fluid-filled cushions in this testing program: (i) settlement during application of the vertical pressure due to the loose nature of the fill, and (ii) the larger area (2.0 m × 1.6 m) to be covered by the cushion. It was therefore decided to apply the vertical pressure using two jacks mounted on a rigid steel plate sitting on top of the fill. Capacity and stroke of the jacks are 500 kN and 160 mm, respectively. The jacks act against the portal frames straddling the box. Columns of the portal frames also act as stiffeners to the box. The top steel plate is 25 mm thick and is stiffened by a set of steel sections. The applied vertical load is measured by two load cells positioned between the jacks and the top plate. Five linear variable differential transducers (LVDTs) installed at the four corners and at the middle of the top plate are used to measure settlement of the top plate during application of the vertical pressure.

### Pullout device

A direct shear box machine was modified as the pullout device. The device permits the pullout test to be conducted in a displacement-rate-controlled manner (0.025–1.300 mm/min). A displacement-rate-controlled test allows the measurement of the load–displacement characteristics throughout the peak and post-peak states of shearing. The device is aligned with the longitudinal direction of the nail and is fixed to a base that is firmly secured to the strong floor in the laboratory. A load cell installed between the nail and the pulling device is used to measure the pullout force. Displacement of the nail is measured by an LVDT when the nail is being pulled out horizontally. A universal joint is used to connect the load cell and the nail to reduce the influence of any misalignment.

### Test materials and procedures

The material used in the test is a CDG soil excavated from a hillside slope in Shau Kei Wan, Hong Kong. Approximately 6 m<sup>3</sup> of soil was taken from the site at depths of 0.5–2.0 m. Figure 2 presents the particle-size distribution of the soil. The soil has 14%–17% fines and can be classified as reddish brown, silty, fine, gravelly sand. The maximum dry density is 1600 kg/m<sup>3</sup> according to the standard Proctor test, and the optimum moisture varies between 18% and 22%. Isotropically consolidated undrained triaxial tests were carried out on loose specimens prepared at 82% relative compaction under consolidation pressures ranging from 30 to 200 kPa. The steady state friction angle is 38°, and the peak

Fig. 2. Particle-size distribution of the CDG.

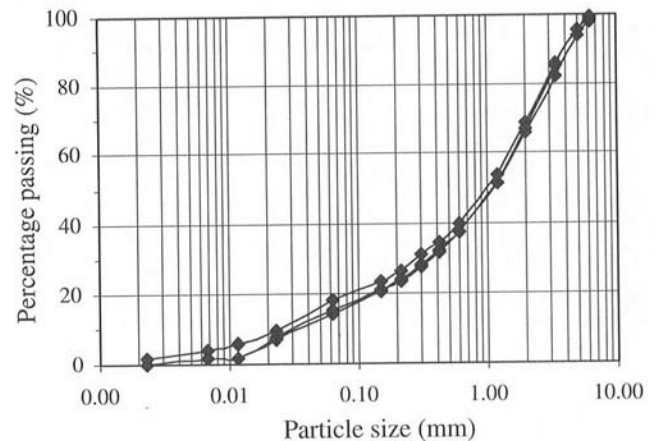

Table 1. Physical properties of the soil used (CDG).

Gravel (%)	33
Sand (%)	51
Silt (%)	14–17
Clay (%)	0
$D_{10}$ (mm)	0.028
$D_{30}$ (mm)	0.300
$D_{60}$ (mm)	1.500
Coefficient of uniformity ( $D_{60}/D_{10}$ )	54
Liquid limit (%) <sup>a</sup>	48
Plastic limit (%) <sup>a</sup>	36
Plasticity index (%) <sup>a</sup>	12
Specific gravity	2.62
Maximum dry density (kg/m <sup>3</sup> )	1600
Optimum moisture content (%)	18–22

<sup>a</sup>For material passing the 425  $\mu$ m sieve.

states can be represented by 28° and 3.8 kPa. Table 1 presents the physical properties of the soil.

Three types of 2 m long steel bars were used in the tests: ribbed bar, knurled tube (roughened surface), and round smooth bar. The steel bars are shown in Fig. 3.

The relative compaction of the old fills typically ranges from 70% to 90% (Sun 1999). The fill sample was prepared to a density corresponding to 80% relative compaction by filling the box in a series of 50 mm lifts. The amount of soil mass needed for each 50 mm lift to achieve the required density was weighed. The mass was poured and spread in the box. If required, the lift was slightly and manually compacted. Uniformity of the sample was checked at the depths in the vicinity of nails just after the placement of soil layers and found to be satisfactory. Moisture content was between 8% and 12% during filling. The steel bars were embedded in the fill horizontally during the placement of the fill to avoid stress changes in the fill due to the installation process. This would allow establishing reliable interface parameters with the measurements of stress changes occurring around the bar during the pullout test. The box was filled up to 1350 mm, leaving 50 mm at the top for the steel plate. Clearance between the top plate and the walls of the box was 5 mm.

The first pullout test was carried out with the self-weight of the top steel plate. For the test series, the displacement

Fig. 3. Types of nails used.

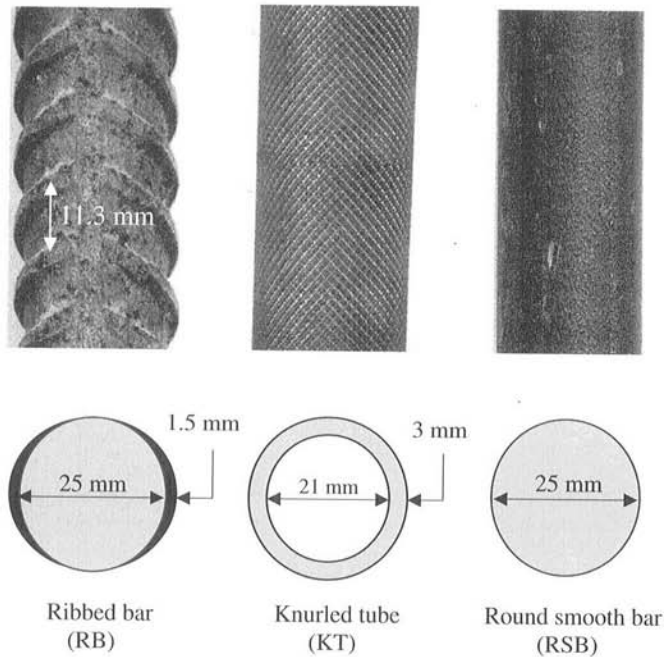

rate was 1.3 mm/min. The pullout force, displacement, and readings of the other sensors were recorded every 5 s by a data-acquisition system. Overburden pressure was then increased by loading the jacks. A minimum period of 2 days was allowed after the increase of overburden pressure so that pullout tests could be conducted under stable stress conditions.

Increase of overburden pressure and pullout tests were repeated as necessary. The maximum settlement of the fill measured for the intended overburden pressure range was about 50 mm. This amount of settlement would cause about 4% increase in the overall density of the fill. At the end of the test, while excavating the fill, in situ density was measured at each 100–150 mm depth by sand replacement tests. A typical set of results showing the variation of void ratio determined from the sand replacement tests with depth is presented in Fig. 4. The average void ratio (1.05) was still within the intended range. Hence, the pullout test results could be considered as a single set, neglecting the density change during the application of overburden pressure.

## Test results

Tests were carried out on 25 mm diameter ribbed bars to evaluate the performance of the experimental setup and refine the test procedures. The tests with different overburden pressures indicated a significant influence of ribs on the pullout resistance, which imposed difficulties in estimating the interface parameters. Different types of bars were therefore included in the following tests.

Two ribbed bars and one round, smooth bar were used in case 1. Pullout tests were carried out under four different vertical pressures: 12.0, 51.5, 66.5, and 91.5 kPa. The results are presented in Fig. 5a. Three types of steel bars were used in case 2: two ribbed bars, two knurled tubes, and one round smooth bar. Pullout tests were carried out at vertical pressures of 12.0, 45.5, 73.5, and 109.5 kPa. The load–

Fig. 4. Void ratio of the fill (case 1).

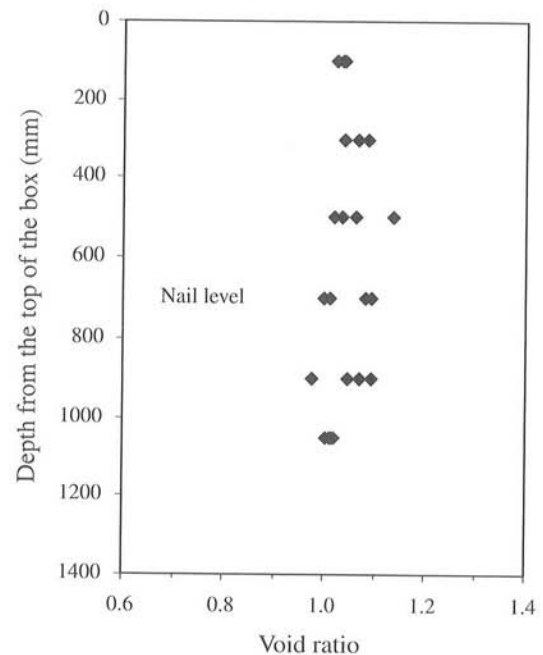

displacement curves are presented in Fig. 5b. The buried length of the nail gradually reduces during the pullout test, and the initial buried length is different for each pullout test. The pullout force per unit length is calculated from the measured pullout force and the corresponding buried length at that instant. The initial buried length of the nails is 1.8 m; note that the results presented in Fig. 5 are for a unit length of the nail.

The pullout resistance of the round smooth bar and knurled tube increased consistently with an increase in overburden pressure, and the results of the ribbed bars were different from those of the round smooth bar and the knurled tube. The important aspect of the test results is that almost all the load–displacement curves have a distinct peak value followed by a decrease in pullout force. In some cases, the pullout force at large displacements is down to 50% of the peak value.

In case 2, six 50 mm diameter KDE-200 earth pressure transducers (EPTs) were installed in the fill 50 mm above the nails to measure the vertical pressures generated in each stage of the test (see Fig. 6). The proximity of the transducers to the nails allowed the measurement of pressure changes during the pullout test. The readings of the pressure transducers taken during the pullout tests are presented in Fig. 7. The applied vertical pressures estimated from the jack forces and dead loads, assuming that the pressure distribution is uniform, are also shown in the Fig. 7. Note that the readings of all the pressure transducers continued to decrease in the post-peak states.

## Interpretation

### Load–displacement characteristics

For the range of stresses used in the tests, the nails can be considered as rigid and inextensible. It can therefore be assumed that the applied pulling force will mobilize uniform bond stress along the nail length, as the relative displace-

Fig. 5. Pullout load – displacement curves: (a) case 1; (b) case 2.

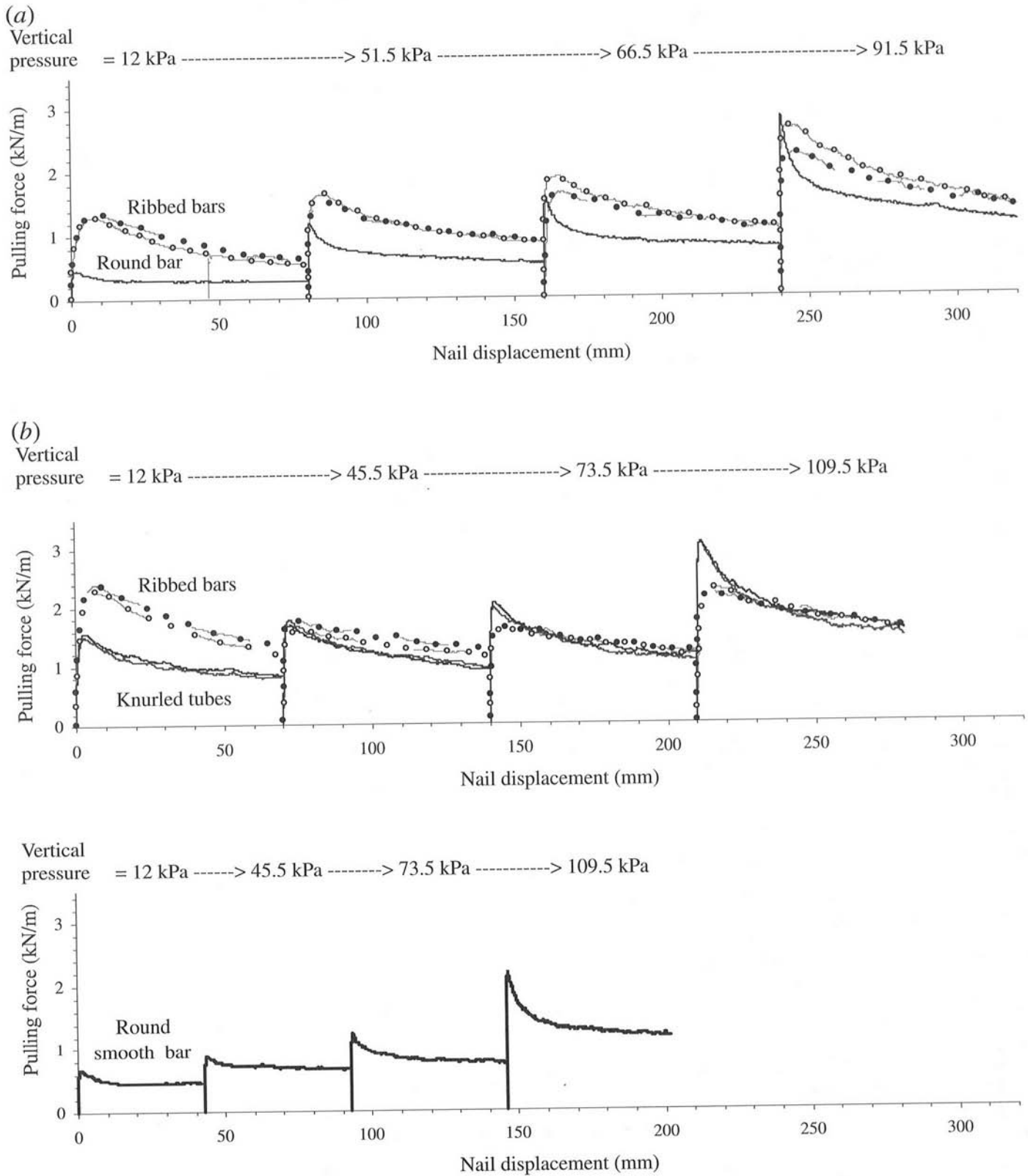

ment between the nail and soil will be the same along the length of the nail at a given point in time. The axial force will therefore decrease linearly along its length to a value of zero at the nail tip. The strains measured along the nail

length in some of the tests confirmed the linear variation of axial force (Junaideen 2001).

Probably the most significant aspect of the test results is that almost all the load–displacement curves have a distinct

Fig. 6. Layout of the earth pressure transducers (EPTs): (a) plan through the EPTs; (b) section through knurled tube KT-1.

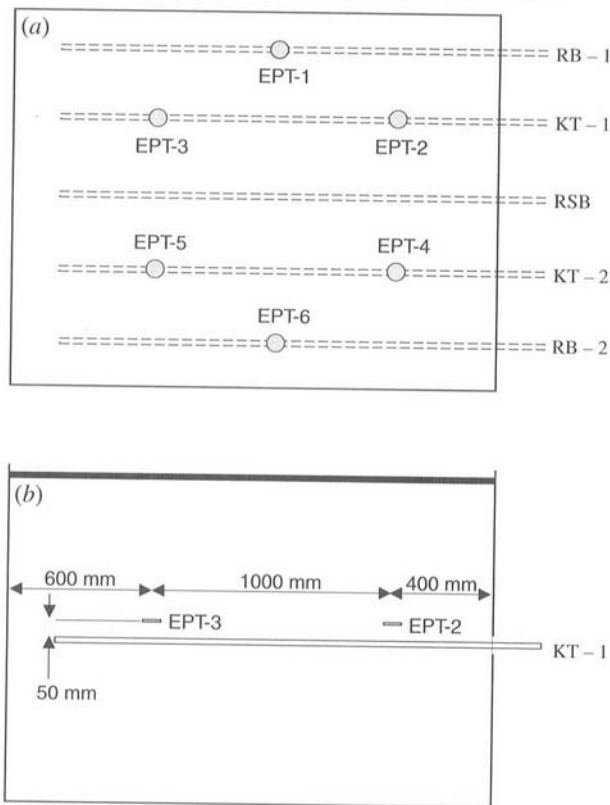

peak value followed by a sharp decrease in the pullout load despite the loose nature of the fill. The readings of the EPTs show that stresses around a nail change when it is being pulled out. The decrease in the pullout force at large displacements can be attributed to the decrease in the confining normal stress acting on the nail,  $\sigma'_n$ . This is discussed further in the next section.

Load–displacement curves obtained for the three types of bars in stage 1 of case 2 are considered in Fig. 8. The lower resistance of the round bar is due to its relatively smooth surface. Pullout resistance of ribbed bars is high due obviously to the ribs. The peak pullout force was reached at a displacement of 1.0 mm for the round bar, 3.8 mm for the knurled tube, and 6.3 mm for the ribbed bar. Note that portions AB<sub>1</sub> of the round bar and AB<sub>2</sub> of the knurled tube coincide with the load–displacement of the ribbed bar. The common portions of the load–displacement curves suggest that, within the displacement values of B<sub>1</sub> and B<sub>2</sub>, full bond between the nail and soil exists and the load–displacement behaviour is governed by elastic properties of the soil. Commencement of slip for the round bar and the knurled tube could start approximately at the points from which the curve deviates from the common portion. Therefore, the slip starts at B<sub>1</sub> for the round bar and at B<sub>2</sub> for the knurled tube. For the ribbed bar, slip could start at a larger displacement than at B<sub>2</sub>. The peak pullout force defines the failure points denoted by C<sub>1</sub>, C<sub>2</sub>, and C<sub>3</sub>.

**Variation of  $\sigma'_n$  during the pullout test**

Based on the results of the EPTs presented in Fig. 7,  $\sigma'_n$  can be expected to vary as shown in Fig. 9 during the

pullout test in different stress states. The points A, B, and C correspond to the points denoted in Fig. 8.

The pre-slip behaviour (AB) can be modeled as a rigid inclusion in an elastic material, assuming full bond between the inclusion and material. In an isotropic linear elastic material, shear strain is decoupled from volumetric strain; hence, there would be no volume change during the application of pure shear stress. The soil could exhibit linear elastic behaviour within small nail displacements, and if the soil is also assumed to be isotropic, in the pre-slip state of pulling, there would be no volumetric strain and no change in  $\sigma'_n$ .

In the pre-peak frictional slip (BC), the soil being sheared around the nail will tend to dilate or contract, depending on the density of the soil and the magnitude of the confining stress. If the soil around the nail tends to dilate, the surrounding soil will restrain such a tendency. This will result in an increase of  $\sigma'_n$ . In this case, the pullout force needs to increase beyond the value at B' to reach the peak state at C. If the soil around the nail tends to contract, the surrounding soil will tend to relax. This relaxation may decrease the value of  $\sigma'_n$ , causing the failure at C where the pulling force will be less than that at B'.

In the post-peak state, the soil around the nail would collapse. Note that the pullout test was conducted in a displacement-rate-controlled manner and therefore further displacement of the nail will allow the collapsed soil particles to rearrange through relative movements and rotations. These conditions will develop an “arching effect” that will decrease the stress around the nail, necessitating stress redistribution at some distance away from the nail. This reduction in  $\sigma'_n$  with any effect of strain softening due to the continued displacement of the nail will decrease the pullout force.

**Pullout resistance of the nails**

In the post-slip states of shearing, the pullout force per unit length of the nail ( $P$ ) will depend on the confining normal stress acting on the nail, which is a function of  $\alpha$  as shown in Fig. 10a, nail diameter ( $D$ ), interface friction angle ( $\delta'$ ), and interface adhesion ( $a'$ ). Based on the Mohr–Coulomb failure criterion and taking the initial normal stress at angle  $\alpha$  as  $\sigma'_{n\alpha}$  and the change in the normal stress during the pullout as  $\Delta\sigma'_{n\alpha}$ , the following is obtained:

$$[3] \quad P = \int_0^{2\pi} [a' + (\sigma'_{n\alpha} + \Delta\sigma'_{n\alpha}) \tan \delta'] \frac{D}{2} d\alpha$$

In the peak state, say  $a' = a'_p$ ,  $\delta' = \delta'_p$ ,  $\Delta\sigma'_{n\alpha} = \Delta\sigma'_{n\alpha p}$ , and  $P = P_p$ , where the subscript p denotes the peak state:

$$[4] \quad P_p = \pi D a'_p + \left( \int_0^{2\pi} \sigma'_{n\alpha} \frac{D}{2} d\alpha + \int_0^{2\pi} \Delta\sigma'_{n\alpha p} \frac{D}{2} d\alpha \right) \tan \delta'_p$$

$$[5] \quad P_p = \pi D a'_p + (AD \sigma'_{vo} + BD \Delta\sigma'_{vp}) \tan \delta'_p$$

where

$$[6] \quad A = \frac{1}{2\sigma'_{vo}} \int_0^{2\pi} \sigma'_{n\alpha} d\alpha$$

Fig. 7. Readings of the pressure transducers (case 2): (a) ribbed bar 1; (b) ribbed bar 2; (c) knurled tube 1; (d) knurled tube 2.

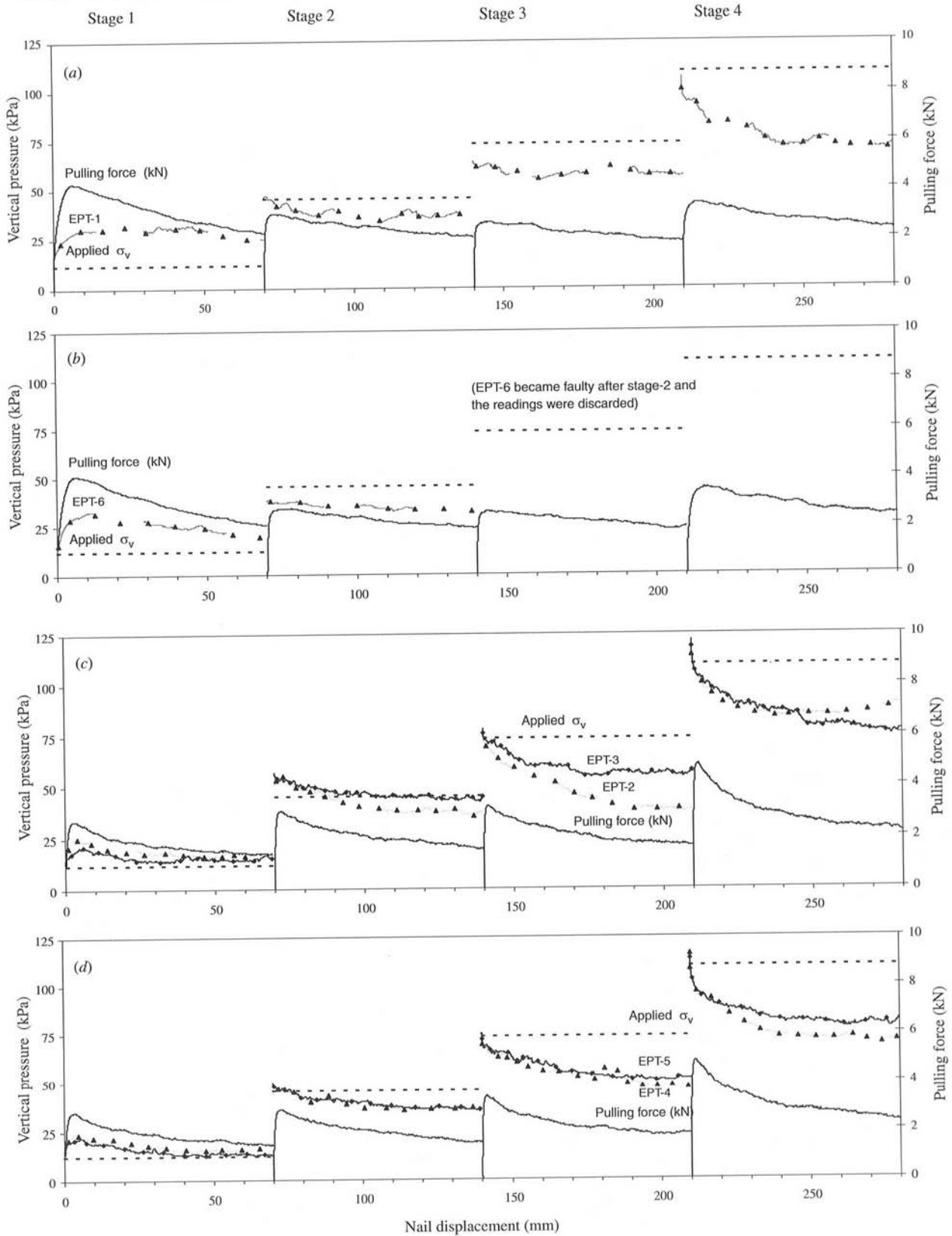

$$[7] \quad B = \frac{1}{2\Delta\sigma'_{vp}} \int_0^{2\pi} \Delta\sigma'_{n\alpha p} d\alpha$$

in which  $\sigma'_{v0}$  is the initial vertical stress acting on the nail, and  $\sigma'_{vp}$  is the change in vertical stress in the peak state.

Parameter A represents the initial stress distribution around the nail perimeter. Figure 10b shows the forces



Fig. 8. Load–displacement curves of the three bars (stage 1, case 2).

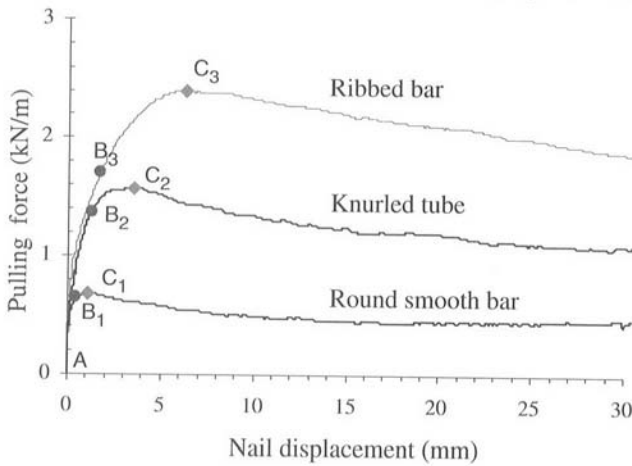
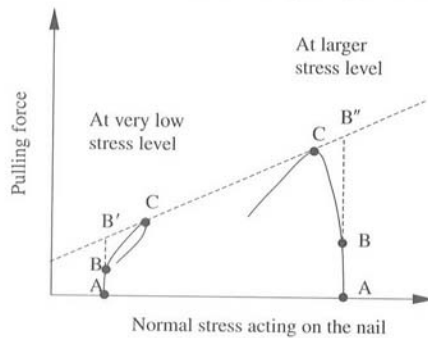

Fig. 9. Variation of normal stress with pulling force.



acting on an element O adjacent to the nail as shown in Fig. 10a, assuming that the inclined plane AB has unit length. Since the box walls are relatively smooth, the shear stresses induced on the sidewalls will be small. Therefore, the vertical and horizontal planes passing through the element can be assumed to be principal planes and have no shear stresses acting on them. At equilibrium,

$$[8] \quad \sigma'_{n\alpha} \cos \alpha - \tau_\alpha \sin \alpha - \sigma'_{ho} \cos \alpha = 0$$

$$[9] \quad \sigma'_{n\alpha} \sin \alpha + \tau_\alpha \cos \alpha - \sigma'_{vo} \sin \alpha = 0$$

where  $\sigma'_{ho}$  is the initial horizontal stress. Solving eqs. [8] and [9],

$$[10] \quad \sigma'_{n\alpha} = \left( \frac{\sigma'_{vo} + \sigma'_{ho}}{2} \right) - \left( \frac{\sigma'_{vo} - \sigma'_{ho}}{2} \right) \cos 2\alpha$$

From eqs. [6] and [10],

$$[11] \quad A = \frac{\pi}{2} \left( \frac{\sigma'_{ho}}{\sigma'_{vo}} + 1 \right) = \frac{\pi}{2} (K_0 + 1)$$

where  $K_0$  is the coefficient of earth pressure at rest. If the value of  $K_0$  is taken as  $1 - \sin \phi'$  (Jaky 1948), the magnitude of parameter A will be in the range of 2.36–2.13 for a  $\phi'$  value of 30°–40°. In this case, its magnitude can be well approximated to be 2 as conventionally used in eq. [2], in which the projected area of the nail is used with the vertical stress acting on the nail. Hence,

$$[12] \quad P_p = \pi D a'_p + (2D\sigma'_{vo} + BD\Delta\sigma'_{vp}) \tan \delta'_p$$

Parameter B depends on the distribution of  $\Delta\sigma'_{n\alpha}$  around the nail in the peak state. If this distribution in the peak state is assumed to be uniform around the nail, it will yield  $B = \pi$ . If  $\Delta\sigma'_{vp}$  and the projected area of the nail are used, the magnitude of B can be taken as 2.

Interface parameters  $a'_p$  and  $\delta'_p$  can be determined by plotting  $P_p/D$  against  $(2\sigma'_{vo} + B\Delta\sigma'_{vp})$ . It requires correct estimation of  $B\Delta\sigma'_{vp}$ , which is not considered in the conventional method of analysis. In that case, the equation can be written with apparent interface parameters ( $a^*$ ,  $\delta^*$ ) and  $B = 0$ :

$$[13] \quad P_p = \pi D a^* + 2D\sigma'_{vo} \tan \delta^*$$

Equation [13] is used to estimate the apparent interface parameters of all the nails. Equation [12] is used to estimate the interface parameters of the knurled tubes, where the measurements of vertical pressure during the pullout test are available. Unfortunately, no pressure transducer was used for the round bar to measure the stress changes during the pull-out.

Moreover, the magnitudes of parameters A and B used here may not represent the real situation in stage 1, where the fill was in as-placed state and exhibited dilative behaviour. The slight compaction applied while preparing the fill would have effects on the pullout resistance, so the pullout test results are excluded from the analysis.

**Round bar**

Figure 11 presents the values of  $P_p/D$  versus  $2\sigma'_{vo}$ ; here,  $\sigma'_{vo}$  is the applied vertical pressure estimated at the nail level. In case 1, the jack forces were released at the completion of one stage and reloaded to increase the overburden pressure for the following stage of the pullout tests; in case 2, the jack forces were not released. The correct  $K_0$  values that incorporate the loading history would therefore be high in case 1, and the parameter A could be larger than the assumed value of 2. Hence, the results of case 1 presented in Fig. 11 tend to yield an interface friction angle higher than that in case 2.

The average apparent friction angle  $\delta^*$  is 20°, and apparent adhesion  $a^*$  is 2.2 kPa. From shear box tests in which the lower part of the shear boxes was replaced by a smooth steel plate, Franzen (1998) found that the smooth steel – loose sand interface friction angle was  $0.50 \tan \phi'$ . From the current pullout test results, the apparent interface friction angle is found to be  $0.47 \tan \phi'$ ; here,  $\phi'$  is 38°, which was determined from isotropically consolidated undrained triaxial tests. The round bar is relatively smooth, and the interface adhesion can be expected to be small. The values estimated from the results seem to be more or less the same as the interface friction values  $a'_p$  and  $\delta'_p$ . It can also be noted in Fig. 8 that points B<sub>1</sub> and C<sub>1</sub> are within a very narrow range of displacements, i.e., the peak pullout force is reached immediately after the slip. These suggest that the change in normal stress around the round bar in the pre-peak state would not be significant.

**Knurled tube**

The test results for the knurled tubes are shown in Fig. 12, where  $\sigma'_{vo}$  is the measured vertical pressure at the beginning of the pullout test. The average values of apparent friction

Fig. 10. States of stresses around a nail: (a) normal stress around a nail; (b) forces on soil element O.

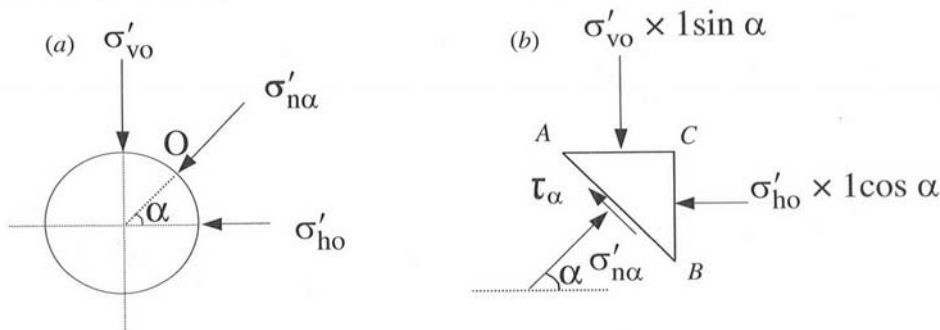
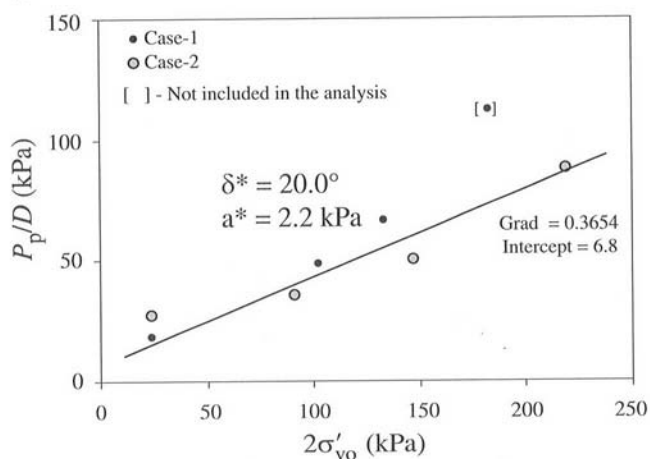

Fig. 11. Results for the round bar.



angle and adhesion (corresponding to  $B = 0$ ) are  $20.8^\circ$  and  $7.2$  kPa, respectively. The apparent friction angle is quite low for the knurled tube, which has a rough surface.

The vertical stress change ( $\Delta\sigma_v$ ) measured by the pressure transducers  $50$  mm above the nail reflects to some degree the change in the normal stress at the soil–nail interface (Fig. 7). In stage 1 where the confining pressure is low, the soil around the nail tends to dilate in the pre-peak states, resulting in an increase in the normal stress. The decrease in the vertical pressure in the pre-peak states is negligible in stage 2 but significant in stages 3 and 4. The vertical stress changes at the soil–nail interface could be even higher than the value measured by the pressure transducers. At the soil–nail interface, however, the stress change in other directions around the perimeter of the nail could be smaller than that in the vertical direction, so the readings of the pressure transducers could be taken to approximate the average value around the perimeter of the nail. The interface parameters defined in eq. [12] are estimated by plotting  $\Delta\sigma_v$  with  $B = \pi$  in Fig. 12c. For comparison, the results are also shown for the  $B$  value of  $2$  in Fig. 12b. Note that the magnitude of  $B$  corresponds to the peak state and could be slightly different in the post-peak states; however, the value is used to plot the stress changes.

As the surface of the knurled tube is very rough, the peak interface friction angle could be expected to be close to the friction angle of the soil. The stress paths corresponding to  $B = 2$  underestimate both the peak and post-peak interface friction angles. Figure 12c better represents the stress changes occurring around the nails. The post-peak reduction

of the pullout force could be due to the combined effects of the decrease in the normal stress and strain softening of the material. The pressure readings suggest that the reduction is due principally to the decrease in the normal stress, however, because the post-peak interface friction angle seems very close to the peak interface friction angle of  $31.3^\circ$ .

The tests were carried out in a multistage manner. After the virgin shearing during the stage 1 pullout test, the soil particles around a nail will be rearranged by the successive increases in overburden pressure and pullout tests repeatedly. Therefore in other stages the degree of cohesion of the soil particles around the nail will be less compared with that of the initial condition of stage 1. It is therefore likely that the effect of interface adhesion on the pullout force would be less in stages 2–4 than in stage 1, which is reflected in the value of interface adhesion obtained from Fig. 12c. In other words, if the interface parameters are estimated from a set of individual tests that are not carried out in a multistage manner, it would yield higher interface adhesion; however, the value of interface friction angle could be expected to be close to the value obtained in these tests.

### Ribbed bars

The test results of the ribbed bars except stage 1 of case 2 are similar: the increase in pullout resistance with an increase in applied vertical pressure was not as great as that of the other bars. Figure 13a shows  $P_p/D$  versus  $2\sigma'_{vo}$ , where  $\sigma'_{vo}$  is the vertical pressure at the nail level in the beginning of the pullout test. The values of apparent friction angle and adhesion are  $13.7^\circ$  and  $10.8$  kPa, respectively.

Figures 13b and 13c depict the readings of the pressure transducers installed above the ribbed bars. For comparison, the envelope of the peak resistance of knurled tubes is also shown in the figures. In stage 1, the pullout resistance and the pre-peak increase in the vertical pressure are much higher compared with the corresponding results for knurled tubes. Ribs can influence the pullout force in two ways: passive resistance can be mobilized against the ribs, and the zone of soil being sheared around the nail can be expanded by the presence of ribs. These will in turn increase the pullout force. In stage 2, the pre-peak change in vertical stress is insignificant, and the pullout resistance is lower than that of stage 2 but close to the corresponding resistance of the knurled tube. It seems that the soil around the nail which underwent shearing in stage 1 and was rearranged by the following increase in overburden pressure did not feel the presence of ribs.

Fig. 12. Results for the knurled tubes: (a)  $B = 0$ ; (b)  $B = 2$ ; (c)  $B = \pi$ .

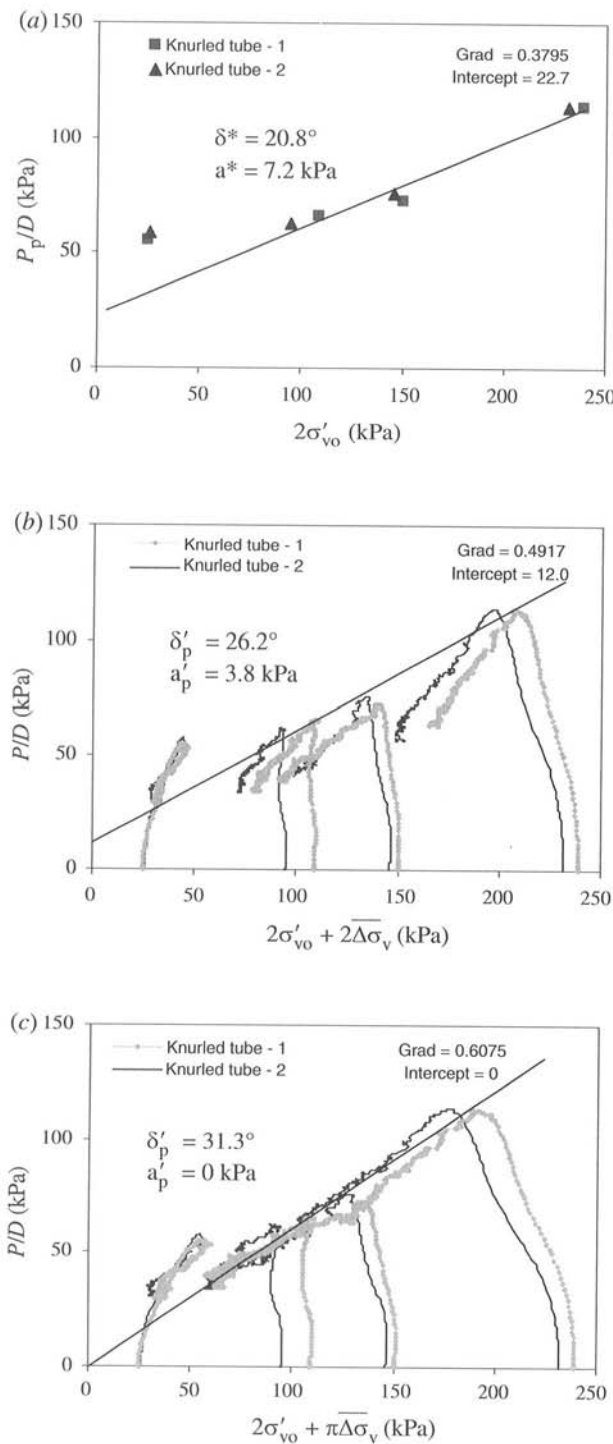
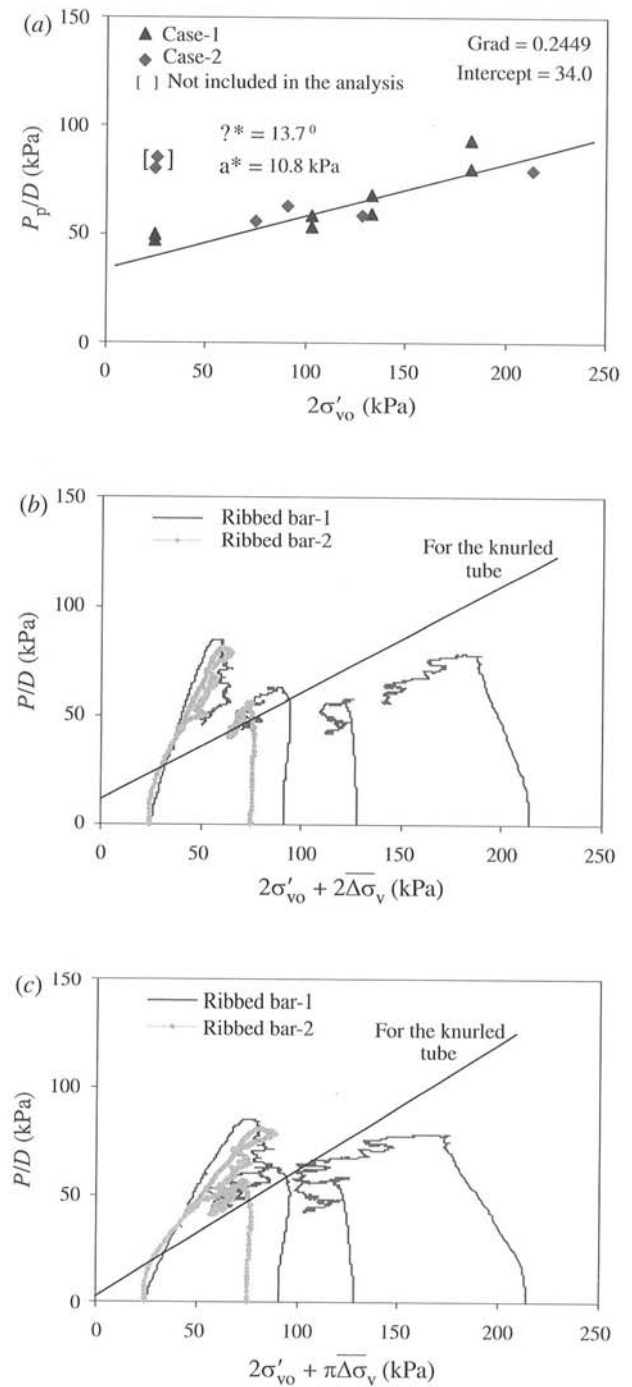

Fig. 13. Results for the ribbed bars: (a)  $B = 0$ ; (b)  $B = 2$ ; (c)  $B = \pi$ .



EPT-6 installed above ribbed bar 2 became faulty after stage 2 and the readings were discarded (Fig. 7). After stage 1 the readings of EPT-1 and EPT-6 were generally lower than those from the other EPTs. Residual effects of the stress changes that occurred in the preceding pullout test would be considerable in the case of the ribbed bars. Moreover, in these stages, the measured stress by the transducers may not correctly reflect the stress states at the interface. Results of stages 3 and 4 shown in Figs. 13b and 13c sug-

gest that the vertical stress at the interface could be lower than the measured value, which results in lower pullout resistance; note that the pattern of the stress paths in stages 3 and 4 is not similar to those of other stages. In the stress range of stages 3 and 4, if a ribbed bar is pulled out for the first time (i.e., virgin shearing), it would yield much higher resistance than the values obtained here. Such an increase in the pullout force was observed in some of the virgin tests, which were carried out separately under different stress levels.

The complexities stem from the influence of ribs combined with the mode of tests that are carried out in a multistage manner. A set of pullout tests performed on ribbed bars as virgin tests at different overburden pressures would give better insight into the problem. Other factors such as rib pattern and orientation of the ribs with respect to the pulling direction will also have influence on the pullout resistance. Quantifying the influence of the ribs on the pullout resistance is outside the scope of this paper.

## Discussion

It has been difficult to estimate the correct soil–nail interface parameters, even from relatively well controlled laboratory pullout tests, because of the uncertainty involved in the estimation of in situ normal stress acting on the nails. Stress states around the nail can change by dilative–contractive tendency and (or) by arching effects of the soil being sheared around the nail during the pullout test. Normal stress acting on the nail is not generally monitored or measured in many cases, and the interpretation of results is limited to the apparent parameters or empirical correlations. The change in the normal stress should be incorporated in the estimation of soil–nail interface parameters.

The pullout tests were carried out in a multistage manner. In the first stage, the confining pressure at the nail level is very low, and the soil behaves in a dilative manner during shear. Such a phenomenon could occur in the field at shallow depths in a slope stabilized with nails, but its contribution to slope stability would be insignificant.

It is likely that, after the virgin pullout test, the tests performed in stages 2–4 would yield lower resistance values than those of virgin tests at the corresponding vertical stresses. The comparison of the stress path of stage 1 to the stress paths of other stages presented in Fig. 12c suggests that the degree of cohesion of the soil particles around a nail could be reduced considerably after virgin shearing. Hence, the interface parameters determined from the results of stages 2–4 would be conservative.

In a slope stabilized with soil nails, the nail force is mobilized due to the relative displacement between the soil and the nail caused by the soil movement in the active zone. The relative displacement is the result of soil movement in the active zone and the nail movement in the resisting zone. The laboratory results show that the peak pullout forces are mobilized within a few millimetres of relative displacement. In the field condition, grouted nails can also be expected to mobilize a great portion of the pullout capacity in response to a very small ground movement. In loose fill slopes, however, the pullout resistance can be limited by the possible collapse of the material at the peak state and by the arching effect at the post-peak states. The degree of collapse of the material and the resulting decrease in the pullout resistance could be dependent on surface characteristics of nails, relative displacement rate, moisture content of the fill, size of the nail, in situ stress conditions, etc. Therefore tests on grouted nails, particularly in the saturated condition of the fill, need to be carried out to estimate lower bounds of pullout resistance, which can be possibly taken as the residual state pullout resistance.

## Conclusions

Pullout tests were conducted in a displacement-rate-controlled manner on three types of steel bars embedded in loose CDG under different overburden pressures. The pullout load – displacement curves have distinct peak values followed by a sharp reduction. The results show that the normal stress acting on the nail increases (decreases) due to the dilative (contractive) tendency of the soil being sheared in the pre-peak states and decreases due to the arching effect of the soil in the post-peak states. The peak pullout forces are mobilized at a few millimetres of nail displacement. The post-peak reduction in the pullout force is due mainly to the decrease in normal stress acting on the nail.

The conventional method of analysis in which the change in normal stress during the pullout is not taken into account tends to give a low interface friction angle and high interface adhesion. The correct interface parameters can be determined by incorporating the changes in the normal stress acting on the nail.

The ribs have a significant influence on the pullout resistance. The results of pullout tests carried out in a multistage manner show that the increase in pullout resistance of the ribbed bars is not significant with an increase in the applied overburden pressures.

The test program is in progress, and future tests will be carried out on grouted nails installed in drilled holes. Pullout tests will also be carried out at different speeds in the saturated fill to investigate the influence of pulling rate on the pullout resistance. The vertical and horizontal stresses and pore pressures will be measured at different distances from the nails to establish the pattern of changes in the effective stress at the soil–nail interface.

## Acknowledgements

The authors wish to acknowledge the financial support of the Research Grant Council of Hong Kong SAR Government and the Hong Kong Jockey Club Charities Trust. The assistance of the staff of the Department of Civil Engineering, the University of Hong Kong, in fabricating the laboratory setup is gratefully acknowledged.

## References

- Barley, A.D., Davies, M.C.R., and Jones, A.M. 1997. Review of current field testing methods for soil nailing. *In* Ground Improvement Geosystems: Proceedings of the 3rd International Conference, London, U.K., 3–5 June 1997. *Edited by* M.C.R. Davies and F. Schlosser. Thomas Telford, London, UK. pp. 477–483.
- Barr, B.I.G., Davies, M.C.R., and Jacobs, C.D. 1991. A large direct shear box — some initial results of tests on soil nails. *Ground Engineering*, 24(2): 44–50.
- Cartier, G., and Gigan, J.P. 1983. Experiments and observations on soil nailing structures. *In* Improvement of Ground: Proceedings of the 8th European Conference on Soil Mechanics and Foundation Engineering, Helsinki, Finland, 23–26 May 1983. *Edited by* H.G. Rathmayer and K.H.O. Saari. A.A. Balkema, Rotterdam, The Netherlands. pp. 473–476.
- Davies, M.C.R., Jacobs, C.D., and Bridle, R.J. 1992. An experimental investigation of soil nailing. *In* Retaining Structures: Pro-

- ceedings of the Conference on Retaining Structures Organized by the Institution of Civil Engineers, Cambridge, U.K., 20–23 June 1992. *Edited by* C.R.I. Clayton. Thomas Telford, London, UK. pp. 587–598.
- Elias, V., and Juran, I. 1991. Soil nailing for stabilization of highway slopes and excavations. Publication FHWA-RD-89-193, U.S. Federal Highway Administration, Washington, D.C.
- Franzen, G. 1998. Soil nailing — a laboratory and field study of pullout capacity. Doctoral thesis, Department of Geotechnical Engineering, Chalmers University of Technology, Göteborg, Sweden.
- Gassler, G. 1983. Discussion on ground movement analysis of earth support system. *Journal of the Geotechnical Engineering Division, ASCE*, **109**(GT3): 488–490.
- Gassler, G. 1992. Discussion leader's report: slopes and excavations. *In Earth Reinforcement Practice: Proceedings of the International Symposium on Earth Reinforcement Practice*, Fukuoka, Kyushu, Japan, 11–13 Nov. 1992. *Edited by* H. Ochiai, S. Hayashi, and J. Otani. A.A. Balkema, Rotterdam, The Netherlands. pp. 955–960.
- Government of Hong Kong. 1976. Report of the independent review panel on fill slope. Hong Kong Government Printer, Hong Kong.
- Guilloux, A., and Schlosser, F. 1982. Soil nailing: practical applications. *In Recent Development in Ground Improvement Techniques: Proceedings of the International Symposium held at the Asian Institute of Technology, Bangkok, Thailand, 29 Nov. – 3 Dec. 1982*. *Edited by* A.S. Balasubramaniam, J.S. Younger, S. Chandra, F. Prinz, and D.T. Bergado. A.A. Balkema, Rotterdam, The Netherlands. pp. 389–397.
- Heymann, G., Rohde, A.W., Schwartz, K., and Friedlaender, E. 1992. Soil nail pullout resistance in residual soils. *In Earth Reinforcement Practice: Proceedings of the International Symposium on Earth Reinforcement Practice*, Fukuoka, Kyushu, Japan, 11–13 Nov. 1992. *Edited by* H. Ochiai, S. Hayashi, and J. Otani. A.A. Balkema, Rotterdam, The Netherlands. pp. 487–492.
- HKIE. 1998. Soil nails in loose fill — a preliminary study. Geotechnical Division of the Hong Kong Institution of Engineers (HKIE), Hong Kong.
- Hsu, S.T., and Liao, H.J. 1998. Uplift behaviour of cylindrical anchors in sand. *Canadian Geotechnical Journal*, **35**: 70–80.
- Jaky, J. 1948. Earth pressure in soils. *In Proceeding of the 2nd International Conference on Soil Mechanics and Foundation Engineering*, Rotterdam, The Netherlands. pp. 103–107.
- Jewell, R.A. 1983. Pressure and friction in reinforced earth. *In Improvement of Ground: Proceedings of the 8th European Conference on Soil Mechanics and Foundation Engineering*, Helsinki, Finland, 23–26 May 1983. *Edited by* H.G. Rathmayer and K.H.O. Saari. A.A. Balkema, Rotterdam, The Netherlands. pp. 1187–1190.
- Jewell, R.A. 1990. Review of theoretical models for soil nailing. *In Performance of Reinforced Soil Structures Proceedings of the International Reinforced Soil Conference*, Glasgow, UK, 10–12 Sept. 1990. *Edited by* A. McGown, K.C. Yeo, and K.Z. Andrawes. Thomas Telford, London, UK. pp. 265–275.
- Junaideen, S.M. 2001. The design and performance of a pressure chamber for testing soil nails in loose fill. M.Phil. thesis, The University of Hong Kong, Hong Kong.
- Law, K.T., Lee, C.F., Luan, M.T., and Zhai, Y. 1997. Laboratory investigation of fundamental behaviour of loose fill under shear. Report to the Geotechnical Engineering Office, Hong Kong SAR Government, Hong Kong.
- Milligan, G.W.E., Chang, K.T., and Morris, J.D. 1997. Pullout resistance of soil nails in sand and clay. *In Ground Improvement Geosystems: Proceedings of the 3rd International Conference*, London, U.K., 3–5 June 1997. *Edited by* M.C.R. Davies and F. Schlosser. Thomas Telford, London, UK. pp. 415–422.
- Ng, B.W.Y., and Lumb, P. 1980. Compaction requirement for fill slopes. *Hong Kong Engineer*, **8**(9): 27–29.
- Ortigao, J.A.R., and Palmeira, E.M. 1997. Optimized design for soil nailed walls. *In Ground Improvement Geosystems: Proceedings of the 3rd International Conference*, London, UK, 3–5 June 1997. *Edited by* M.C.R. Davies and F. Schlosser. Thomas Telford, London, UK. pp. 369–374.
- Powell, G.E., and Watkins, A.T. 1990. Improvement of marginally stable existing slopes by soil nailing in Hong Kong. *In Proceedings of the International Reinforced Soil Conference*, Glasgow, U.K., 10–12 Sept. 1990. *Edited by* A. McGown, K.C. Yeo, and K.Z. Andrawes. Thomas Telford, London, UK. pp. 241–247.
- Schlosser, F. (Editor). 1993. Recommendations Clouterre 1991 — soil nailing recommendations 1991. Presses de l'École Nationale des Ponts et Chaussées, Paris. [English translation NTIS No. PB94-109980, U.S. Federal Highway Administration, Washington, D.C.]
- Seto, P., Won, G.W., and Choi, K.Y. 1992. Use of soil nailing in stabilization of a freeway embankment. *In Earth Reinforcement Practice: Proceedings of the International Symposium on Earth Reinforcement Practice*, Fukuoka, Kyushu, Japan, 11–13 Nov. 1992. *Edited by* H. Ochiai, J. Otani, and S. Nayashi. A.A. Balkema, Rotterdam, The Netherlands. pp. 537–542.
- Shen, C.K., Bang, S., and Herrman, L.R. 1981. Ground movement analysis of earth support system. *Journal of the Geotechnical Engineering Division, ASCE*, **107**(GT12): 1609–1624.
- Sun, H.W. 1999. Review of fill slope failures in Hong Kong. GEO Report 96, Geotechnical Engineering Office, Hong Kong.
- Wong, H.N., Ho, K.K.S., Pun, W.K., and Pang, P.L.R. 1998. Observations from some landslide studies in Hong Kong. *In Slope Engineering in Hong Kong: Proceedings of the Annual Seminar on Slope Engineering in Hong Kong*, Hong Kong, 2 May 1997. *Edited by* K.S. Li, K.K.S. Ho, and J.N. Kay. A.A. Balkema, Rotterdam, The Netherlands. pp. 277–286.