

Lightning Electromagnetic Field Coupling to Overhead Lines: Theory, Numerical Simulations, and Experimental Validation

Mario Paolone, *Member, IEEE*, Farhad Rachidi, *Senior Member, IEEE*, Alberto Borghetti, *Senior Member, IEEE*, Carlo Alberto Nucci, *Fellow, IEEE*, Marcos Rubinstein, *Member, IEEE*, Vladimir A. Rakov, *Fellow, IEEE*, and Martin A. Uman, *Fellow, IEEE*

(Invited Paper)

Abstract—The evaluation of electromagnetic transients in overhead power lines due to nearby lightning return strokes requires accurate models for the calculation of both the incident lightning electromagnetic pulse (LEMP) and the effects of coupling of this field to the line conductors. Considering also the complexity of distribution networks in terms of their topology and the presence of power system components and protection devices, the implementation of the LEMP-to-transmission-line coupling models into software tools used to represent the transient behavior of the entire network is of crucial importance. This paper reviews the most significant results obtained by the authors concerning the calculation of lightning-induced voltages. First, the theoretical basis of advanced models for the calculation of LEMP-originated transients in overhead power lines is illustrated; then, the relevant experimental validation using: 1) reduced-scale setups with LEMP and nuclear electromagnetic pulse (NEMP) simulators and 2) full-scale setups illuminated by artificially initiated lightning are reported. Finally, the paper presents comparisons between simulations and new experimental data consisting of measured natural lightning-induced voltages on a real distribution network in northern Italy, correlated with data from lightning location systems.

Index Terms—Electromagnetic transients, electromagnetic transient program (EMTP), insulation coordination, lightning-induced transients, power quality.

I. INTRODUCTION

THE ACCURATE evaluation of lightning-induced overvoltages on distribution networks is essential for: 1) the estimation of the lightning performance curves of overhead

lines [1]–[3]; 2) the optimal choice of the characteristics, number, and location of protective/mitigation devices (surge arresters, shielding wires, and relevant groundings) [1], [4]–[7]; and 3) the analysis of possible correlations between lightning events—detected by lightning location systems—and voltage dips and/or interruptions [8]–[13].

Transients in overhead power lines due to lightning can be caused by both direct and indirect events [1]. However, in view of the modest height of medium and low voltage distribution lines compared to that of structures in their vicinity, indirect lightning return strokes are much more frequent events than direct strokes [14], and for this reason, although direct strokes have a high probability of producing an insulation flashover, the paper focuses on indirect lightning events as they are the more frequent ones.

Concerning the calculation of indirect lightning-induced transients, two approaches are proposed in the literature. The first is based on the use of approximate analytical formulas, while the second is based on the numerical calculation of the lightning electromagnetic pulse (LEMP) and its electromagnetic coupling with the overhead line conductors.

As opposed to simple analytical formulas (such as the popular formula by Rusck [15] and the one proposed by Darveniza [16]), which are restricted to unrealistically simple configurations, more elaborate models (e.g., see [17]–[19]) allow for an accurate treatment of realistic line and network configurations. The complexity of these models calls for an implementation into computer codes since, in general, they require a numerical integration of the relevant equations.

There is also an approach based on the finite-difference time-domain (FDTD) method for solving the Maxwell's equations (e.g., see [20] and [21]) but it has been applied only to simple configuration lines.

This paper deals with the theoretical basis of advanced models for the calculation of lightning-induced voltages on realistic overhead distribution networks. The paper also describes the numerical implementation of these models together with their validation carried out by using experimental data obtained by means of reduced-scale setups with LEMP and nuclear electromagnetic pulse (NEMP) simulators and also with data obtained by using natural and artificially initiated triggered lightning on full-scale installations and distribution networks.

Manuscript received October 17, 2008; revised March 9, 2009. First published August 7, 2009; current version published August 21, 2009. This work was supported in part by the Swiss National Science Foundation under Grant 200021-122457 and by the Centro Elettrotecnico Sperimentale Italiano (CESI) and Italian National Research Council (CNR).

M. Paolone, A. Borghetti, and C. A. Nucci are with the Department of Electrical Engineering, University of Bologna, Bologna 40124, Italy (e-mail: mario.paolone@unibo.it; alberto.borghetti@unibo.it; carloalberto.nucci@unibo.it).

F. Rachidi is with the Ecole Polytechnique Federale de Lausanne, Lausanne CH-1015, Switzerland (e-mail: farhad.rachidi@epfl.ch).

M. Rubinstein is with the School of Engineering and Management of the Canton of Vaud, University of Applied Sciences of Western Switzerland, Delémont CH-2800, Switzerland (e-mail: marcos.rubinstein@heig-vd.ch).

V. A. Rakov and M. A. Uman are with the Department of Electrical and Computer Engineering, University of Florida, Gainesville, FL 32611 USA (e-mail: rakov@ece.ufl.edu; uman@ece.ufl.edu).

Digital Object Identifier 10.1109/TEMC.2009.2025958

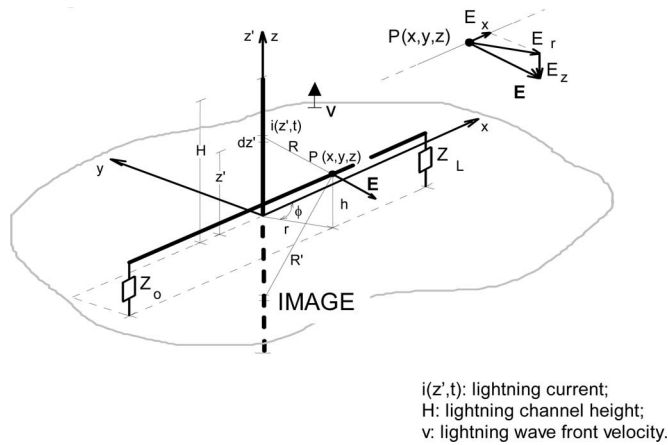

Fig. 1. Geometry of the problem.

The paper is organized as follows. Section II reviews the models for the calculation of lightning-induced transients. Section III illustrates the experimental validation of the field-to-transmission-line coupling model, suitably extended to the case of complex networks, using data obtained on reduced and full-scale setups illuminated by LEMP/NEMP simulators and natural/triggered lightning. Finally, Section IV contains concluding remarks.

II. MODELS FOR THE CALCULATION OF LIGHTNING-INDUCED TRANSIENTS IN OVERHEAD POWER LINES

The evaluation of lightning-induced overvoltages is generally performed in the following ways.

- 1) The lightning return-stroke electromagnetic field change is calculated at a number of points along the line employing a lightning return-stroke model, namely a model that describes the spatial and temporal distribution of the return stroke current along the channel. To this end, the return stroke channel is generally considered as a straight, vertical antenna (see Fig. 1).
- 2) The evaluated electromagnetic fields are used to calculate the induced overvoltages making use of a field-to-transmission-line coupling model which describes the interaction between the LEMP and the line conductors [22]–[24].

A. Return-Stroke Models

Return-stroke current models have been the subject of some reviews in the literature, e.g., [25]–[31]. Lightning return-stroke models are categorized into four classes in [31]: 1) the gas dynamic models; 2) the electromagnetic models; 3) the distributed circuit models; and 4) the engineering models. A general description of the four classes of models can be found in [32]. In the studies dealing with lightning-induced disturbances on power lines, engineering models have been adopted almost exclusively, essentially for two reasons. First, engineering models are characterized by a small number of adjustable parameters, usually only one or two besides the specified channel-base current. Second, engineering models allow the return-stroke current

TABLE I
 $P(z')$ AND v^* FOR DIFFERENT RETURN-STROKE MODELS (ADAPTED FROM [32])

Model	$P(z')$	v^*
Bruce and Golde – BG	1	∞
Traveling Current Source – TCS	1	$-c$
Transmission Line – TL	1	v
Modified Transmission Line Linear – MTLL	$1 - z'/H_{tot}$	v
Modified Transmission Line Exponential – MTLE	$\exp(-z'/\lambda)$	v

at any point along the lightning channel to be simply related to a specified channel-base current. Rakov and Uman [32] expressed several engineering models by the following generalized current equation:

$$i(z', t) = u\left(t - \frac{z'}{v}\right) P(z') i\left(0, t - \frac{z'}{v}\right) \quad (1)$$

where $u(t)$ is the Heaviside function equal to unity for $t \geq z'/v$ and zero otherwise, $P(z')$ is the height-dependent current attenuation factor, v is the upward-propagating return-stroke front speed, and v^* is the current-wave propagation speed. Table I summarizes $P(z')$ and v^* for five engineering models.

Note that, as in most studies on lightning-induced voltages, the excitation source is considered as only due to the return-stroke electric field change, neglecting any field changes prior to it.¹ In some cases, and for very close strikes, the electric field change due to the preceding downward leader phase may have a significant influence on the amplitude and shape of the induced voltages [33].

B. LEMP Calculation

The LEMP calculation, which requires the specification of the lightning return-stroke current along the channel [34], [35], can be performed in either the time or the frequency domain. However, a direct solution in the time domain is sometimes preferable because it allows the handling, in a straightforward manner, of nonlinear phenomena such as corona, changes in the network configuration (opening of circuit breaker, etc.), and the presence of nonlinear protective devices at the line terminals (such as surge arresters).

Two approaches have been adopted for the LEMP calculation, namely the so-called dipole and monopole techniques [36]. By making reference to the dipole technique¹ and to the geometry shown in Fig. 1, the expressions for the electromagnetic field radiated by a vertical dipole of length dz' at a height z' along the lightning channel, assumed as a vertical antenna over a perfectly conducting plane, can be derived by solving Maxwell's equations in terms of retarded scalar and vector potentials (e.g., see [37] and [38]).

For distances not exceeding a few kilometers, the assumption of a perfectly conducting ground can be considered as reasonable for the calculation of the vertical component of the electric field and for the horizontal component of the magnetic

¹Such an approach has been adopted to carry out the simulation results of Section III.

field [39], [40]. On the other hand, the horizontal component of the electric field is appreciably affected by the finite conductivity of the ground. Although the intensity of the horizontal field component is generally much smaller than that of the vertical one, within the context of certain coupling models, it plays an important role in the coupling mechanism [41] and, hence, it has to be determined accurately. Methods for the calculation of the horizontal field using the exact Sommerfeld integrals are inefficient from the point of view of computer time, although dedicated algorithms have been proposed in some recent studies [42]. A simplified expression has been proposed independently by Rubinstein [43] and Cooray [44], which is discussed by Wait [45] and improved by Cooray [46]. It has been shown that the Cooray–Rubinstein formula is able to reproduce satisfactorily the horizontal electric field at close, intermediate, and distant ranges and for typical ground conductivities (e.g., see [47] and [48]).²

Note finally that, as discussed in [49], LEMP calculation can also be performed using numerical solutions of Maxwell's equations. Two methods have been widely used for this purpose, namely the method of moment (e.g., see [50]–[54]) and the FDTD technique (e.g., see [55]–[58]).

C. Field-to-Transmission-Line Coupling Equations

To solve the coupling problem, i.e., the determination of voltages and currents induced by an external field on a conducting system, use could be made of antenna theory, the general and rigorous approach based on Maxwell's equations [59]. Due to the length of typical overhead line installations, together with the need for also modeling other components (e.g., power transformers, surge arresters, general line terminations), the use of such theory for the calculation of lightning-induced overvoltages is not straightforward and implies long computing times.

Another possible approach is the use of the transmission-line theory. The basic assumptions of this approximation are that the response of the line is quasitransverse electromagnetic (quasi-TEM) and that the transverse dimensions of the line are much smaller than the minimum significant wavelength. The line is represented by an infinite series of elementary sections to which, by virtue of the earlier assumptions, the quasistatic approximation applies. Each section is illuminated progressively by the incident electromagnetic field so that longitudinal propagation effects are taken into account.

Different and equivalent coupling models based on the use of the transmission-line approach have been proposed in the literature (e.g., see [22]–[24]) and, in what follows, we shall make reference to the Agrawal *et al.* coupling model [23]. That model presents the notable advantage of taking into account in a straightforward way the ground resistivity in the coupling mechanism and it is the only one that has been thoroughly tested and validated using experimental results, as will be discussed next.

With reference to the geometry shown in Fig. 2, the coupling equations for the case of a multiconductor system along the x -

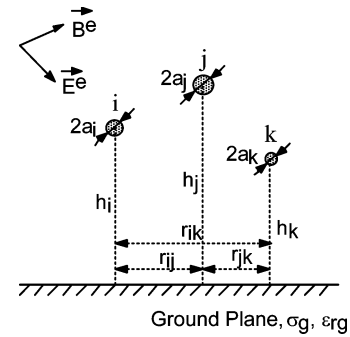

Fig. 2. Cross-sectional geometry of a multiconductor line in the presence of an external electromagnetic field.

axis above an imperfectly conducting ground and in the presence of an external electromagnetic excitation are given by [60]

$$\frac{d}{dx} [V_i^s(x)] + j\omega [L'_{ij}] [I_i(x)] + [Z'_{gij}] [I_i(x)] = [E_x^e(x, h_i)] \quad (2)$$

$$\frac{d}{dx} [I_i(x)] + [G'_{ij}] [V_i^s(x)] + j\omega [C'_{ij}] [V_i^s(x)] = [0] \quad (3)$$

where $[V_i^s(x)]$ and $[I_i(x)]$ are, respectively, the frequency-domain scattered voltage and current vectors along the i th line conductor, $[E_x^e(x, h_i)]$ is the exciting electric field vector tangential to the line conductor located at height h_i above ground, $[0]$ is the zero-matrix (all elements are equal to zero), $[L'_{ij}]$ is the per-unit-length line inductance matrix.

Assuming that the distance r_{ij} between conductors i and j is much larger than their radii, the general expression for the mutual inductance between the two conductors is given by [61]

$$L'_{ij} = \frac{\mu_o}{2\pi} \ln \left(\frac{d^*}{d} \right) = \frac{\mu_o}{4\pi} \ln \left(\frac{r_{ij}^2 + (h_i + h_j)^2}{r_{ij}^2 + (h_i - h_j)^2} \right) \quad (4)$$

where d is the distance between conductor i and conductor j , and d^* is the distance between conductor i and the image of conductor j .

The self-inductance for conductor i is given by

$$L'_{ii} = \frac{\mu_o}{2\pi} \ln \left(\frac{2h_i}{r_{ii}} \right) \quad (5)$$

$[C'_{ij}]$ is the per-unit-length line capacitance matrix. It can be evaluated directly from the inductance matrix using the following expression [61]

$$[C'_{ij}] = \epsilon_o \mu_o [L'_{ij}]^{-1} \quad (6)$$

$[G'_{ij}]$ is the per-unit-length transverse conductance matrix. The transverse conductance matrix elements can be evaluated starting either from the capacitance matrix or the inductance matrix using the following relations

$$[G'_{ij}] = \frac{\sigma_{\text{air}}}{\epsilon_o} [C'_{ij}] = \sigma_{\text{air}} \mu_o [L'_{ij}]^{-1} \quad (7)$$

However, for most practical cases, the transverse conductance matrix elements G'_{ij} are negligible in comparison with $j\omega C'_{ij}$ and can therefore be neglected in the computation.

²The Cooray–Rubinstein formula has been adopted to carry out the simulation results of Section III.

Finally, $[Z'_{g_{ij}}]$ is the ground impedance matrix. The general expression for the mutual ground impedance between two conductors i and j derived by Sunde is given by [62]

$$Z'_{g_{ij}} = \frac{j\omega\mu_0}{\pi} \int_0^\infty \frac{e^{-(h_i+h_j)x}}{\sqrt{x^2 + \gamma_g^2 + x}} \cos(r_{ij}x) dx. \quad (8)$$

In a similar way as for the case of a single-wire line, an accurate logarithmic approximation has been proposed by Rachidi *et al.* [60], which is given by

$$Z'_{g_{ij}} \cong \frac{j\omega\mu_0}{4\pi} \ln \left[\frac{(1 + \gamma_g((h_i + h_j)/2))^2 + (\gamma_g r_{ij}/2)^2}{(\gamma_g((h_i + h_j)/2))^2 + (\gamma_g r_{ij}/2)^2} \right]. \quad (9)$$

Note that, in (2) and (3), the terms corresponding to the wire impedance and the so-called ground admittance have been neglected. Indeed, for typical overhead lines and for the typical frequency range of interest (below 10 MHz), disregarding these parameters is a reasonable approximation [47], [63].

The boundary conditions for the two line terminations in the case of lumped linear impedances are given by

$$[V_i^s(0)] = -[Z_A][I_i(0)] + \left[\int_0^{h_i} E_z^e(0, z) dz \right] \quad (10)$$

$$[V_i^s(L)] = [Z_B][I_i(L)] + \left[\int_0^{h_i} E_z^e(L, z) dz \right]. \quad (11)$$

A time-domain representation of coupling equations is sometimes preferable, as explained in Section II-B. However, frequency-dependent parameters, such as the ground impedance, need to be represented using convolution integrals, which require considerable computation time and memory storage.

The two transmission-line coupling equations of the model of Agrawal *et al.*, expressed in the time domain for a multiconductor overhead line above a lossy ground are

$$\begin{aligned} \frac{\partial}{\partial x} [v_i^s(x, t)] + [L'_{ij}] \frac{\partial}{\partial t} [i_i(x, t)] \\ + [\xi'_{g_{ij}}] \otimes \frac{\partial}{\partial t} [i_i(x, t)] = [E_x^e(x, h_i, t)] \end{aligned} \quad (12)$$

$$\frac{\partial}{\partial x} [i_i(x, t)] + [C'_{ij}] \frac{\partial}{\partial t} [v_i^s(x, t)] = 0. \quad (13)$$

Here, \otimes denotes the convolution product and the elements of the matrix $[\xi'_{g_{ij}}]$ are given by the inverse Fourier transform of the ground impedance matrix $[Z'_{g_{ij}}]$

$$[\xi'_{g_{ij}}] = F^{-1} \left\{ \frac{Z'_{g_{ij}}}{j\omega} \right\}. \quad (14)$$

The general expression for the ground impedance matrix terms in the frequency domain does not have an analytical inverse Fourier transform. Thus, the elements of the transient ground resistance matrix in time domain have to be, in general, determined using a numerical inverse Fourier transform algorithm. However, the following analytical expressions have been shown to be reasonable approximations to the numerical values

obtained using an inverse fast Fourier transform (FFT) [64]:

$$\begin{aligned} \xi_{g_{ii}} = \min \left\{ \frac{1}{2\pi h_i} \sqrt{\frac{\mu_0}{\varepsilon_0 \varepsilon_{rg}}}, \frac{\mu_0}{\pi \tau_{g_{ii}}} \left[\frac{1}{2\sqrt{\pi}} \sqrt{\frac{\tau_{g_{ii}}}{t}} \right. \right. \\ \left. \left. + \frac{1}{4} \exp\left(\frac{\tau_{g_{ii}}}{t}\right) \operatorname{erfc}\left(\sqrt{\frac{\tau_{g_{ii}}}{t}}\right) - \frac{1}{4} \right] \right\} \end{aligned} \quad (15)$$

$$\begin{aligned} \xi_{g_{ij}} = \min \left\{ \frac{1}{2\pi \hat{h}} \sqrt{\frac{\mu_0}{\varepsilon_0 \varepsilon_{rg}}}, \frac{\mu_0}{\pi T_{ij}} \right. \\ \times \left[\frac{1}{2\sqrt{\pi}} \sqrt{\frac{T_{ij}}{t}} \cos\left(\frac{\theta_{ij}}{2}\right) + \frac{1}{4} \exp\left(\frac{T_{ij} \cos(\theta_{ij})}{t}\right) \right. \\ \times \cos\left(\frac{T_{ij} \sin(\theta_{ij}) - \theta_{ij}}{t}\right) - \frac{1}{2\sqrt{\pi}} \sum_{n=0}^{\infty} \alpha_n \left(\frac{T_{ij}}{t}\right)^{(2n+1)/2} \\ \left. \left. \times \cos\left(\frac{2n+1}{2} \theta_{ij}\right) - \frac{\cos(\theta_{ij})}{4} \right] \right\} \end{aligned} \quad (16)$$

in which

$$\tau_{g_{ii}} = \hat{h}_i^2 \mu_0 \sigma_g \quad (17)$$

and T_{ij} and θ_{ij} are defined as follows:

$$\hat{\tau}_{g_{ij}} = \hat{h}_{ij}^2 \mu_0 \sigma_g = \left(\frac{h_i + h_j}{2} + j \frac{r_{ij}}{2} \right)^2 \mu_0 \sigma_g = T_{ij} e^{j\theta_{ij}} \quad (18)$$

and erfc is the complementary error function.

Similar expressions have also been proposed by Araneo and Cellozi [65]. More discussion on the validity of the approximate analytical expressions can be found in [66].

D. FDTD Numerical Solution of Field-to-Transmission-Line Coupling Equations

As mentioned earlier, most studies on lightning-induced voltages on overhead power lines use a direct time-domain analysis because of its relative simplicity in dealing with insulation coordination problems and because of its ability to handle nonlinearities that arise in presence of protective devices such as surge arresters or the corona effect.

One of the most popular approaches to solve the coupling equations in the time domain is the FDTD technique (e.g., see [67]).

Such a technique was already used by Agrawal *et al.* [23] where partial time and space derivatives were approximated using a first-order FDTD scheme. Instead, the use of a second-order FDTD scheme based on the Lax–Wendroff algorithm [69], [70] was proposed in [68]. The second-order FDTD scheme shows much better stability compared to its first-order counterpart, especially when analyzing complex systems involving nonlinearities [68], [71].

The second-order discretized solutions for the line current and scattered voltage are given by

$$\begin{aligned}
[v_i]_k^{n+1} &= [v_i]_k^n - \Delta t [C'_{ij}]^{-1} \left(\frac{[i_i]_{k+1}^n - [i_i]_{k-1}^n}{2\Delta x} \right) \\
&\quad - \frac{\Delta t^2}{2} [[L'_{ij}] [C'_{ij}]]^{-1} \\
&\quad \times \left(\frac{[Eh_i]_{k+1}^n - [Eh_i]_{k-1}^n}{2\Delta x} \right. \\
&\quad \quad \left. - \frac{[v_i]_{k+1}^n + [v_i]_{k-1}^n - 2[v_i]_k^n}{\Delta x^2} \right) \\
&\quad + \frac{\Delta t^2}{2} [[L'_{ij}] [C'_{ij}]]^{-1} \left(\frac{[v'_{gi}]_{k+1}^n - [v'_{gi}]_{k-1}^n}{2\Delta x} \right)
\end{aligned} \tag{19}$$

$$\begin{aligned}
[i_i]_k^{n+1} &= [i_i]_k^n - \Delta t [L'_{ij}]^{-1} \left(\frac{[v_i]_{k+1}^n - [v_i]_{k-1}^n}{2\Delta x} \right) \\
&\quad - [Eh_i]_k^n + [v'_{gi}]_k^n \\
&\quad + \frac{\Delta t^2}{2} [[C'_{ij}] [L'_{ij}]]^{-1} \left(\frac{[i_i]_{k+1}^n + [i_i]_{k-1}^n - 2[i_i]_k^n}{\Delta x^2} \right) \\
&\quad + \frac{\Delta t^2}{2} [[C'_{ij}] [L'_{ij}]]^{-1} \left([C'_{ij}] \frac{[Eh_i]_k^{n+1} - [Eh_i]_k^{n-1}}{2\Delta t} \right) \\
&\quad - \frac{\Delta t^2}{2} [[C'_{ij}] [L'_{ij}]]^{-1} \left([C'_{ij}] \frac{[v'_{gi}]_k^n - [v'_{gi}]_k^{n-1}}{\Delta t} \right)
\end{aligned} \tag{20}$$

where Δx is the spatial integration step, Δt is the time integration step, $k = 0, 1, 2, \dots, k_{\max}$ is the spatial discretization index ($k_{\max} = (L/\Delta x) + 1$, where L is the line length), $n = 0, 1, 2, \dots, n_{\max}$ is the time discretization index ($n_{\max} = (T/\Delta t) + 1$, where T is the adopted time window), $[v_i]_k^{n+1}$ is the vector of the scattered voltages corresponding to the spatial and time integration indexes k and $n + 1$, respectively, $[i_i]_k^{n+1}$ is the vector of the conductors currents corresponding to the spatial and time integration indexes k and $n + 1$, respectively, and $[v'_{gi}]_k^n = \sum_{h=0}^n [\xi'_{gi}]_k^{n-h} ([i_i]_k^n - [i_i]_{n-1}^k) / \Delta t$.

E. Extension to Complex Networks

As mentioned in Section I, the inherent complexity of distribution networks in terms of topology and the presence of different components and protection devices, calls for an extension of LEMP-to-transmission-line coupling models initially developed for a single line.

The LEMP-to-transmission-line coupling equations deal with the case of multiconductor lines with resistive terminations. In principle, such a model can be suitably modified, case by case, in order to take into account the presence of the specific type of terminations, line discontinuities (e.g., surge arresters across the line insulators along the line), and of complex system topologies. This procedure requires that the boundary conditions for the transmission-line coupling equations be properly rewritten

case by case, as discussed by Nucci *et al.* [72]. However, as proposed by other authors [18], [19], [72]–[80], it has been found more convenient to link such a model with the electromagnetic transient program (EMTP) in order to take advantage of the large available library of power components.

The approach adopted in this paper is the one illustrated by Nucci *et al.* [72], Paolone [71], Borghetti *et al.* [19], and recently improved by Napolitano *et al.* [79] in which the LEMP-coupled network is viewed as an illuminated group of lines connected to each other through shunt admittances. The LEMP-to-transmission-line coupling model computes the response of the various lines composing the network, while the EMTP solves the boundary condition.

III. EXPERIMENTAL VALIDATION

Rigorously, testing a coupling model requires the knowledge of the incident electromagnetic field and of the induced voltages or currents induced by the field on a given experimental line. The fields and voltages need to be obtained experimentally. Using the measured exciting incident field as an input to the coupling model under test, one has to evaluate the voltage or current induced on the line as predicted by the model and to compare the resulting calculated wave shape with the measured one.

A number of experimental installations have been set up in different research centers in the world with such an aim. The exciting field can come from different sources, such as the field radiated by natural or triggered lightning [81]–[89], by NEMP simulators [19], [90]–[93], or by vertical antennas simulating a reduced-scale lightning channel [94]–[96].

As a general comment, it can be observed that the use of lightning is complicated by the intrinsic difficulty in performing a controlled experiment, although triggered lightning is clearly a better technique in this respect. More controlled conditions can be achieved using the aforementioned EMP simulators or reduced-scale models. In what follows we give a brief description of the results that have been obtained using these techniques with the aim of testing the coupling models.

A. Reduced-Scale Model Tests by Means of NEMP and LEMP Simulators

As known, a NEMP simulator is a facility able to radiate within its so-called working volume an electromagnetic wave with very short rise time (of the order of some nanoseconds) and with electric field intensity of some tens of kilovolts per meter. The main components of an EMP simulator are a pulse generator and an antenna (of guided-wave type, conical, etc.) excited by the generator. With an EMP simulator it is possible, in principle, to avoid contaminations of the incident field due to wire scattering, as might be the case when the field and the induced voltages are measured simultaneously (e.g., for lines illuminated by natural lightning fields). In this respect, the repeatability of the pulse generator output is crucial, in that the electromagnetic field that is measured within the working volume in absence of the victim must be essentially unaltered when the victim is put within the working volume.

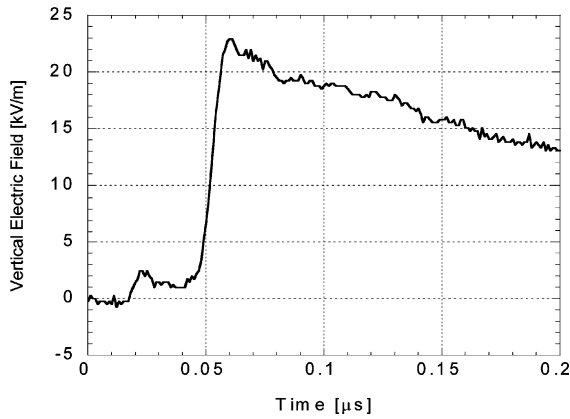

Fig. 3. Vertical electric field inside the working volume in absence of the line.

Comparisons between calculated results and measurements obtained using the SEMIRAMIS EMP simulator of the Swiss Federal Institute of Technology of Lausanne [91] have been presented by Guerrieri *et al.* [92], [93]. SEMIRAMIS is of the bounded-wave, vertically polarized type, with a working volume of $3\text{ m} \times 1\text{ m} \times 1\text{ m}$. A measurement record of the waveform of the electric vertical field inside the working volume, performed in the absence of a line, is presented in Fig. 3. The field has a rise time of about 8 ns and a decay time of about 150 ns. An example of comparison for a Y-shaped victim network is presented in Fig. 4. The procedure used for the validation was based on the measurement of the electric field generated in the simulator in absence of the line and of the induced currents measured at different line terminations of reduced-scale line models placed in the working volume. The measured incident field was then used as an input to the modified Agrawal *et al.* model computer code and the computed induced currents were compared with measured waveforms.

Several other reduced-scale line models reproducing single and multiconductor line configurations were also used by Paolone *et al.* [7] for testing the coupling equations of Agrawal *et al.*

Results have been obtained for a single-conductor configuration with a shielding wire grounded at the line extremities, as shown in Fig. 5, and a vertically configured three-conductor line with a shielding wire grounded at line extremities and at the line center represented in Fig. 6.

For the configuration with a single conductor, the shielding wire was placed successively above and under the phase conductor at two different heights, namely 18 or 22 cm (as shown in Fig. 5). Fig. 7 shows, for the single-conductor configuration, a comparison between measurements and simulations of the current in the phase conductor line terminations with and without the shielding wire.

It can be seen that the numerical results agree well with the experimental data. In addition, as expected, the shielding wire is more efficient in mitigating the induced voltages when it is placed above the phase conductor.

For the three-phase configuration, the shielding wire was placed above the highest phase conductor (as indicated in Fig. 6). Fig. 8 shows comparisons between measured and simulated

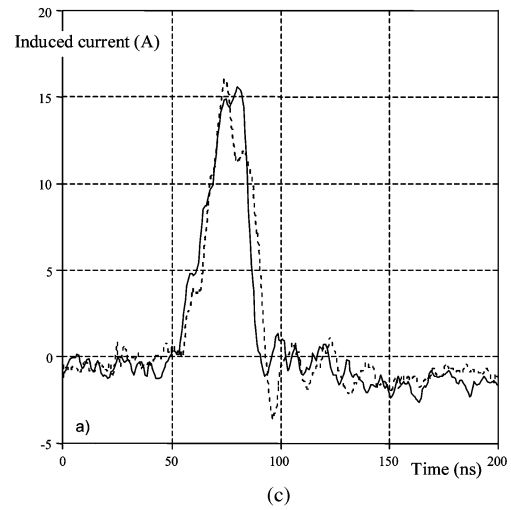
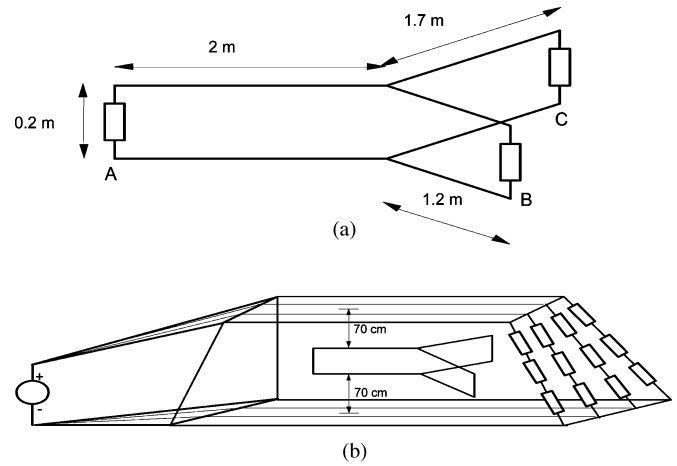

Fig. 4. Example of a comparison performed using the EMP simulator of the Federal Institute of Technology of Lausanne (SEMIRAMIS) between calculated (using the Agrawal *et al.* model) and measured induced currents on a Y-shaped test structure: (a) test structure; (b) arrangement of the Y-shaped structure within the working volume of the simulator; (c) measured (solid line) and calculated (dotted line) induced currents at point A of the structure (adapted from Guerrieri *et al.* [92], [93]).

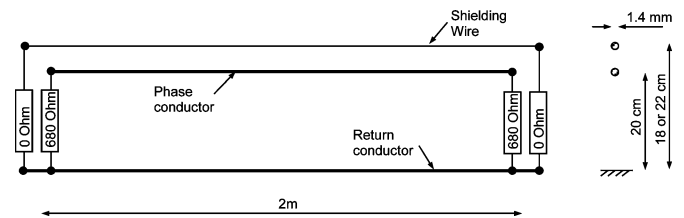

Fig. 5. Reduced-scale line model composed of a single conductor and a shielding wire grounded at the line extremities, used for the experiment carried out with the SEMIRAMIS EMP simulator.

currents in the middle line conductor (with and without the shielding wire) and between measurements and simulations of the induced current in the shielding wire. Also for this case, the numerical simulations are in excellent agreement with measurements.

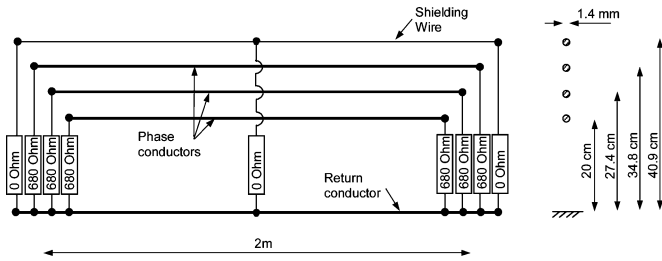

Fig. 6. Reduced-scale line model composed by three conductors and a shielding wire grounded at the line extremities and at the center, used for the experiment carried out with the SEMIRAMIS EMP Simulator.

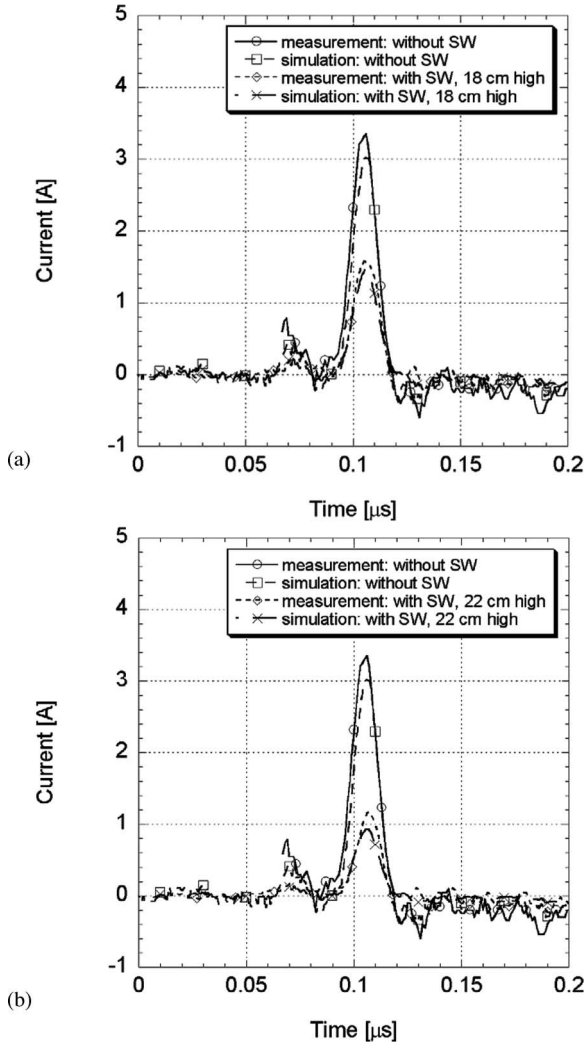

Fig. 7. Comparison between experimental results and simulations relevant to the line configuration of Fig. 5. Current induced in the phase conductor. (a) Height of shielding wire: 18 cm. (b) Height of shielding wire: 22 cm.

Tests using a more elaborate and complex network consisting of 27 branches (see Fig. 9) illuminated by the electromagnetic field generated by the Swiss Defence Procurement Agency EMP simulator (called VERIFY) have also been performed. The network actually represents a simple model for a car cable harness, flattened on the ground plane. The wire used to construct the harness has a stranded multiconductor core with an insulating

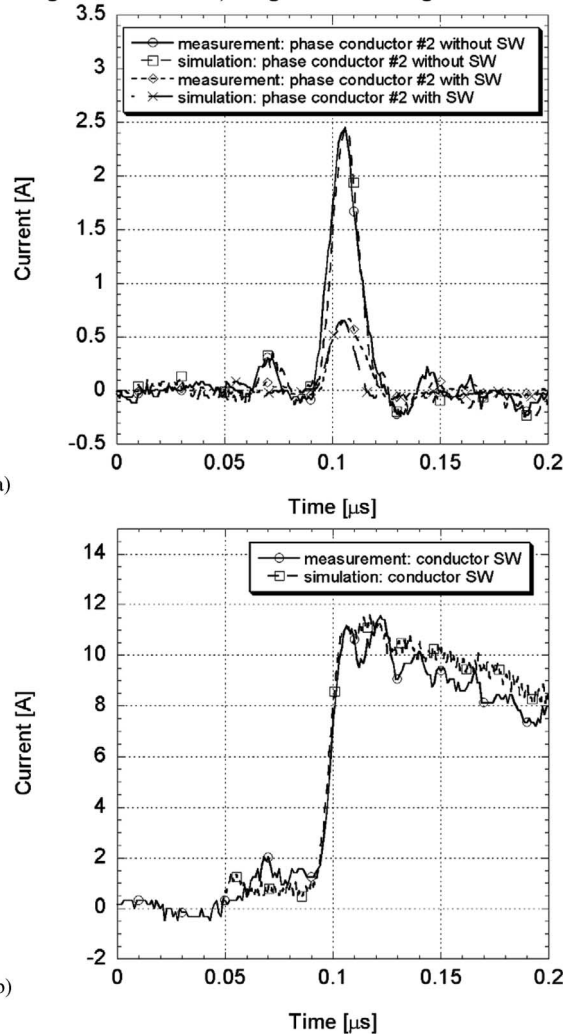

Fig. 8. Comparison between experimental results and simulations relevant to the line configuration of Fig. 6. (a) Current induced on line conductor #2 (middle phase conductor). (b) Current induced on the shielding wire.

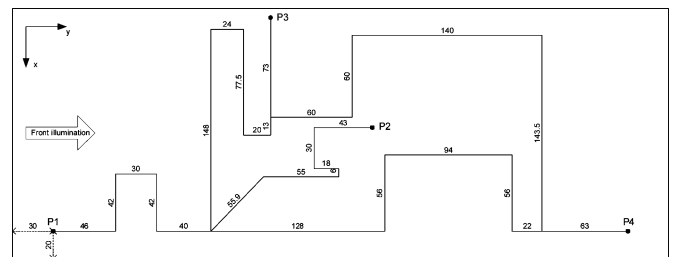

Fig. 9. Top view of the layout of an experimental network over a ground plane for EMP measurements and simulations (drawing to scale, all dimensions are in centimeters).

sheath. The diameter of the conductor for the wire is approximately 1 mm, while that for the insulation is 2.5 mm. The height of the wire over the ground plane was 20 mm.

The NEMP simulator VERIFY generates a vertically polarized electric field with a rise time of 0.9 ns and a full-width at half-maximum (FWHM) of 24 ns. The working volume

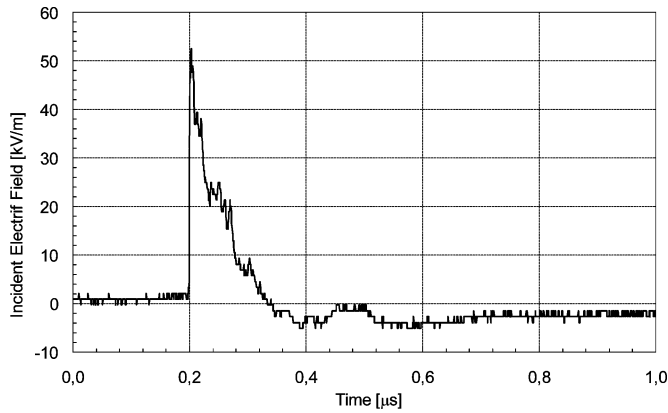

Fig. 10. Vertical electric field generated by VERIFY measured in the absence of the network, in the middle of the working volume.

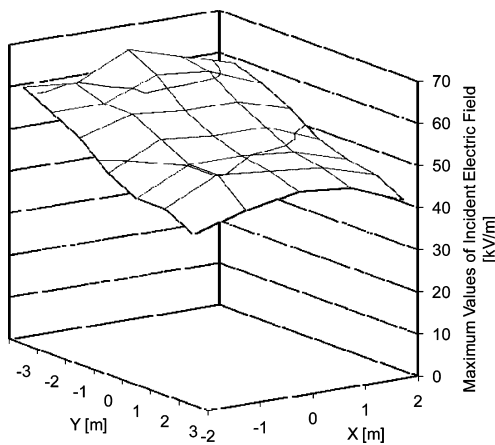

Fig. 11. Three-dimensional field distribution in the active area of the EMP simulator.

is $4 \times 4 \times 2.5 \text{ m}^3$ and the maximum E-field amplitude is 100 kV/m.

Fig. 10 presents the vertical incident field produced by the EMP simulator, measured in the absence of the network.

A map of the E-field generated by the simulator was created by performing measurements at 1 m above the ground and at squared intervals of 1 m in order to check the homogeneity of the field inside the working volume of the simulator. Fig. 11 shows the peak electric field value as a function of the position inside the working area.

Fig. 12 presents comparisons between experimental data and computer simulations for different load configurations of the reduced-scale model network. It can be seen that the numerical simulations are in good agreement with the measurements.

Experimental validation based on the use of LEMP simulator measurements has been realized by means of the experimental results obtained by Piantini and Janiszewski [95]. The measurements have been performed on reduced-scale models designed and realized at the University of Sao Paulo in Brazil, which reproduce a typical overhead distribution system (main feeder plus branches), including surge arresters, neutral grounding, T-junctions (between line branches), and shunt capacitors aimed at modeling distribution transformers. The surge arresters are simulated by means of a combination of diodes and resistances [97].

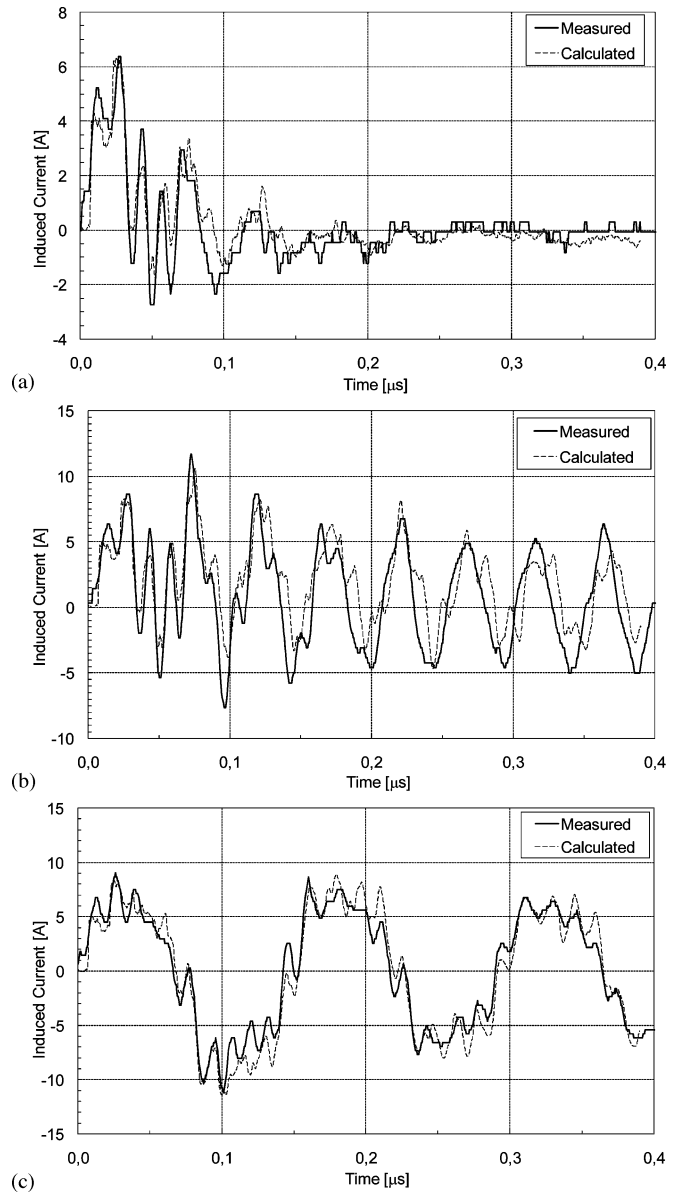

Fig. 12. Comparison between calculations and measurements of induced current for different terminations of the experimental network of Fig. 9 (SC: short circuit, OC: open circuit). (a) Induced current at P1 (P1, . . . , P4 = 50Ω). (b) Induced current at P1 (P1, . . . , P4 = SC). (c) Induced current at P1 (P1 = SC, P2, P3, P4 = OC).

The system that simulates the lightning current generates a current wave shape that can be approximated with a triangular profile. By making reference to real-scale quantities, the equivalent lightning characteristics are: time-to-peak value $2 \mu\text{s}$, time-to-half value $85 \mu\text{s}$, return-stroke speed $0.33 \times 10^8 \text{ m/s}$, channel height 600 m, and return stroke represented by means of the TL model.

Different LEMP-illuminated distribution network topologies have been considered [97]. One of the comparisons that makes reference to the topology of Fig. 13(a) is reported here.

For the considered topology, the four-conductor line geometry (three-phase plus neutral) is shown in Fig. 13(b). The connection types of the line terminations are illustrated in Fig. 13(c). Fig. 14 shows a comparison between the measured and the calculated

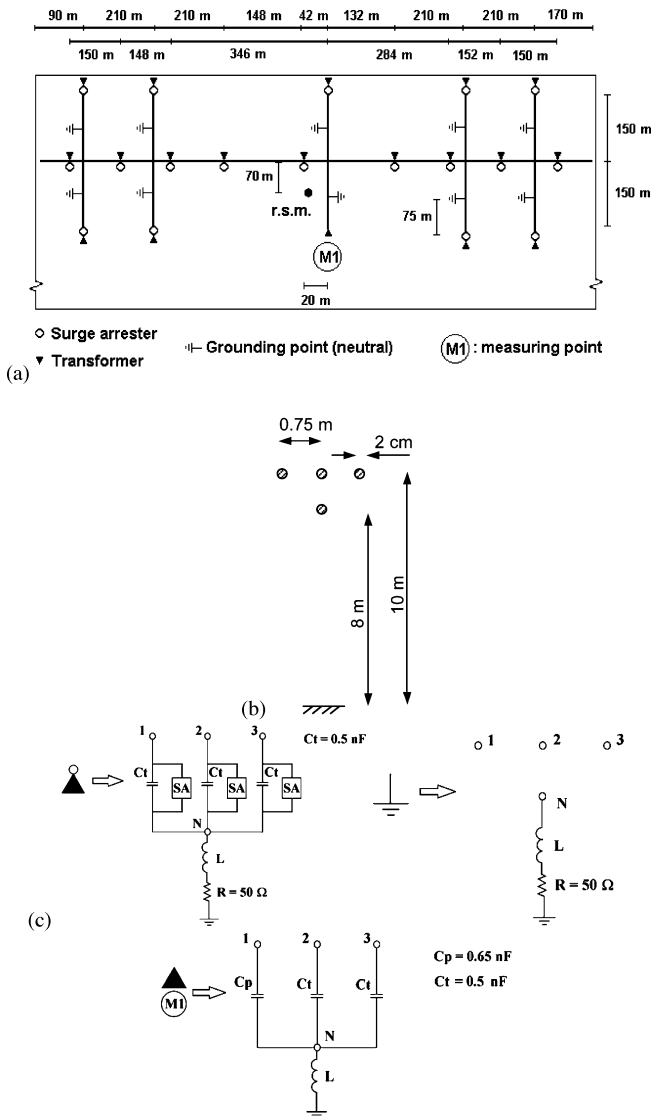

Fig. 13. Geometry adopted for the reduced-scale LEMP simulator measurements. (a) Network topology. (b) Overhead lines cross section showing the conductors arrangement. (c) Line terminations.

phase induced voltages at node M1 [see Fig. 13(a)] for a stroke current with a peak amplitude of 34 kA, time-to-peak equal to 2 μ s, and time-to-half value equal to 85 μ s. The measurement and simulation were made on the phase conductor closest to the stroke location.

As in the previously presented studies, this comparison shows a very good agreement between measurements and simulations.

B. Natural and Triggered Lightning

A large number of experimental recordings has been published by Yokoyama *et al.* [81]–[83] using an experimental three-conductor, 820-m-long, unenergized overhead line. The overvoltages measured by Yokoyama *et al.* were induced by lightning strokes having a known impact point, a 200-m-high chimney at a 200 m distance from the closest point of the line. Both current and overvoltages were recorded, but the corresponding fields were not. Indeed, Yokoyama *et al.* used their

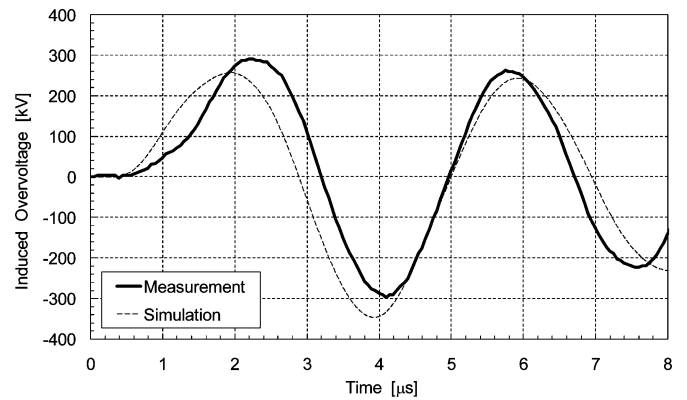

Fig. 14. Comparison between measurement and simulation for the network configuration of Fig. 13 corresponding to observation point M1.

experimental data to test the model by Rusck in its complete form [15], which uses as input the lightning current and gives as output the induced voltage. In this respect, the results by Yokoyama *et al.* cannot be used to test the coupling model as specified at the beginning of this section, but they provide an indication on the adequacy of the Rusck model.

The first simultaneous measurements of lightning electric and magnetic fields, and the power-line voltages induced by these fields were performed by Master *et al.* in the Tampa Bay area of Florida during the Summer of 1979 [84], [98]. Voltage measurements were made at one end of a 500-m unenergized overhead distribution line. Comparison of voltages calculated according to the Agrawal *et al.* coupling model and voltages measured on the line yielded reasonably good agreement in the wave shapes, but the magnitudes of the theoretical amplitudes were systematically about a factor of four smaller than the measurements [84], [98]. Then, a series of experiments was carried out in the following years by the University of Florida research group [85], [86] in which some corrections were made on the first experiment procedure and in which, overall, a better agreement between theory and experimental results concerning voltage wave shapes was reached, although the agreement between amplitudes was not always satisfactory. Possible causes for the disagreement can be calibration errors, imperfect determination of the angle of incidence of the electromagnetic wave, uncertainties about the ground conductivity value, and the presence of trees and other objects in the vicinity of the line that may cause a field distortion.

De la Rosa *et al.* [87] presented measurements of voltages at one end of 13-kV three-phase overhead line of standard construction type in Mexico. The line was 2.8 km long and nearly 10 m high. The three line conductors were bound together to a common point at both line ends, used to take a connection down to the voltage divider and matching resistor placed at ground level at both ends of the line. The amplitude, polarity, and wave shape of the voltage at one end of the Mexican line were found to be a strong function of the position of lightning with respect to the line (in general quite distant from the line) and of ground conductivity. Their results were used by Cooray and De la Rosa [88], who found good agreement between measured voltages and those calculated using the Agrawal *et al.* model.

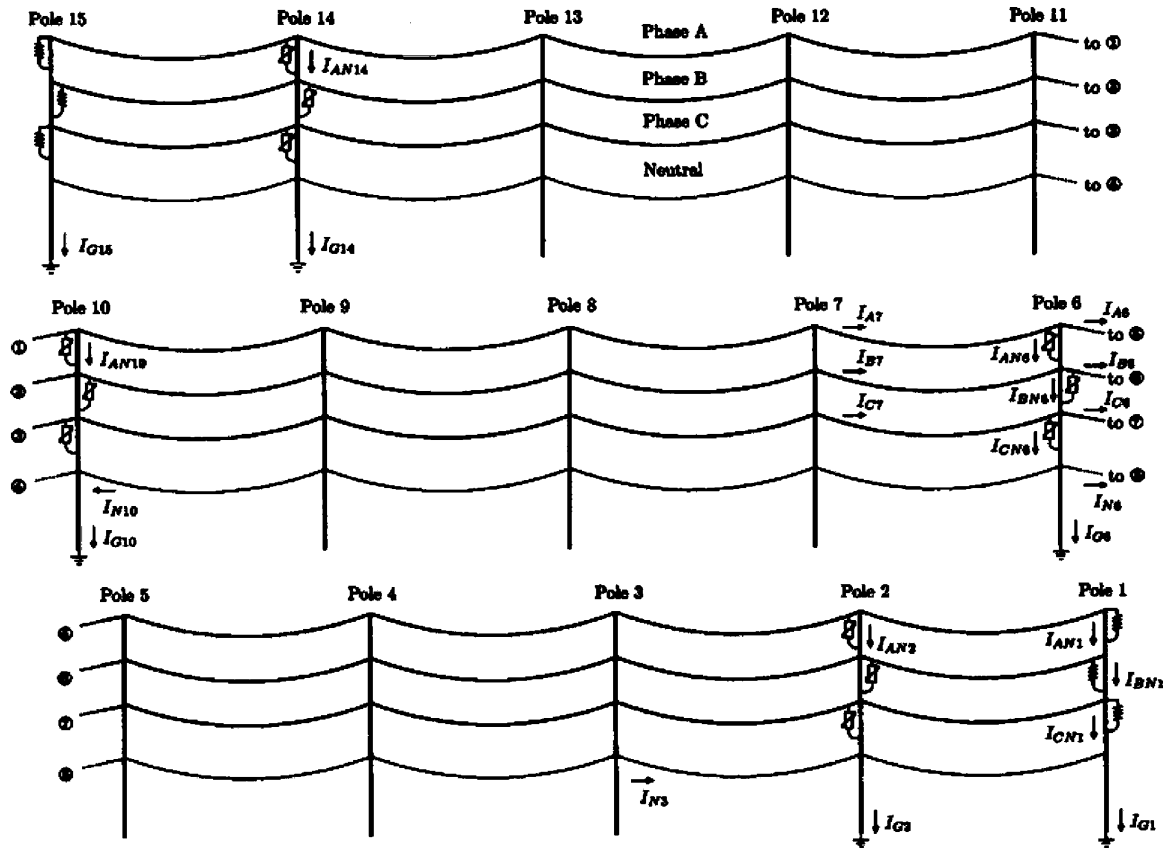

Fig. 15. Experimental overhead distribution line installed at the ICLRT. The indicated quantities are the measured lightning-induced currents.

Barker *et al.* [89] published the results of a study carried out at Camp Blanding in Florida to characterize lightning-induced voltage amplitudes and wave shapes. They tested the Rusck simplified formula (see [17] for a discussion on Rusck model and formula) and the Agrawal *et al.* model, finding reasonable agreement between theory and measurements. The comparison presented in [89] is, however, affected by the assumption of a perfectly conducting ground, which was not the case in the field experiment.

Adopting a simple model for the leader and the return stroke, Rachidi *et al.* [33] computed overvoltages induced by nearby lightning on a 500 m line using the electric fields due to both the dart leader and the return stroke. Their results show that, for stroke locations that are approximately along the line prolongation, the dart leader electric field change contributes significantly to the amplitude and wave shape of the induced voltages calculated at the line terminations. For stroke locations that are perpendicular to the line, for the same observation points, the leader effect is less appreciable. Their computed results have been compared to experimental data from close triggered lightning obtained on a test line at the NASA Kennedy Space Center and improved agreement has been found (compared to the results based on the return-stroke electric field change only).

1) *Comparison With Triggered Lightning Data:* In this section, the results obtained on a 0.75-km-long line installed at the International Center for Lightning Research and Testing (ICLRT [29], [99], [100]) operated by the University of Florida are pre-

sented. The line is composed of four conductors (three-phase conductors plus neutral, grounded at six locations) and equipped with surge arresters. The distance between poles is roughly 60 m and the line terminations consist of 500- Ω resistors that connect each phase conductor to the ground. Groundings of the neutral conductor are placed at poles 1, 2, 6, 10, 14, and 15. The arresters (Ohio-Brass PDV100 type 213615) are connected between each phase conductor and the neutral at poles 2, 6, 10, and 14. Fig. 15 shows the configuration of the line in detail. The indicated quantities are the measured lightning-induced currents along the line. The ground conductivity, experimentally measured in a position close to the overhead line is 1.7×10^{-3} S/m [101].

During the Summer of 2003, lightning flashes were triggered at two different positions.

As an example, in what follows a comparison between the experimental data and numerical computations carried out for the sixth return stroke of the triggered lightning flash #336, recorded on August 2, 2003 is presented. The strike location was 15 m away from the line facing the pole #4.

The following model assumptions are made in the simulations.

- 1) In view of the short line length and close distance to the lightning, the finite ground conductivity was considered only in the calculation of the horizontal electric field.
- 2) According to recommendations of the IEEE Fast Front Transients Task Force [102], the surge arresters are modeled using only the $V-I$ nonlinear characteristics.

The groundings of the neutral conductors, composed of vertical cylindrical rods are modeled adopting a lumped parameter approach [62], [103]–[105]. The geometrical data adopted to infer the parameters of this model are the ones reported in [106].

Fig. 16 presents comparisons between measured and computed currents at different locations of the line and the groundings.

As can be seen, the numerical results obtained using the proposed approach, are in good agreement with the measured data with small differences observed in the amplitudes and in the periods of the oscillatory tails of the waveforms.

Possible reasons for disagreement can be ascribed to the imperfect knowledge of the soil conductivity and its possible non homogeneity, and to the $V-I$ characteristic of the surge arresters provided by the manufacturer, determined for a standard $8/20 \mu\text{s}$ pulse, which clearly differ from the induced current wave shapes.

2) *Comparison With Natural Lightning Data:* This section makes reference to data obtained during the experimental campaign reported in [13] aimed at correlating cloud-to-ground lightning discharges with relay operations of a real distribution network. This study makes use of: 1) data recorded by means of a distributed measurement system (DMS) installed in a real distribution network located in the northern region of Italy; 2) data coming from the Italian Lightning Location System (CESI-SIRF); and 3) data coming from a monitoring system of relay operation.

In order to appropriately compare the DMS-measured and simulated lightning-induced voltages, the events that did not produce a line flashover have been selected. Such a choice is based on the fact that the flashover position along the lines is unknown, and that the superposition of the lightning-originated transients and the travelling waves associated with the flashover itself makes the comparison less straightforward.

Fig. 17 shows the location of the second stroke of the flash #43735 detected by CESI-SIRF on August 20, 2007, used to compare the measured induced voltages with the calculated ones. The stroke is characterized by an estimated current peak of 29.1 kA and, considering that the event is a subsequent stroke, a $2 \mu\text{s}$ time-to-peak has been assumed [107], [108].

Additionally, the following assumptions have been adopted in the simulations.

- 1) Constant value of the ground conductivity assumed equal to 1 mS/m according to the Italian average ground conductivity map.
- 2) Stroke location assumed as the one estimated by the CESI-SIRF lightning location system.
- 3) Lightning current waveform characterized by a trapezoidal wave shape.
- 4) Straight lightning channel perpendicular to the ground plane.
- 5) For the return-stroke current time-space distribution, the so-called MTLE model [109], [110] has been used for LEMP calculation.
- 6) Return-stroke speed assumed equal to $1.5 \times 10^8 \text{ m/s}$.
- 7) Concerning the electrical network, power transformers installed in secondary substations, located in correspon-

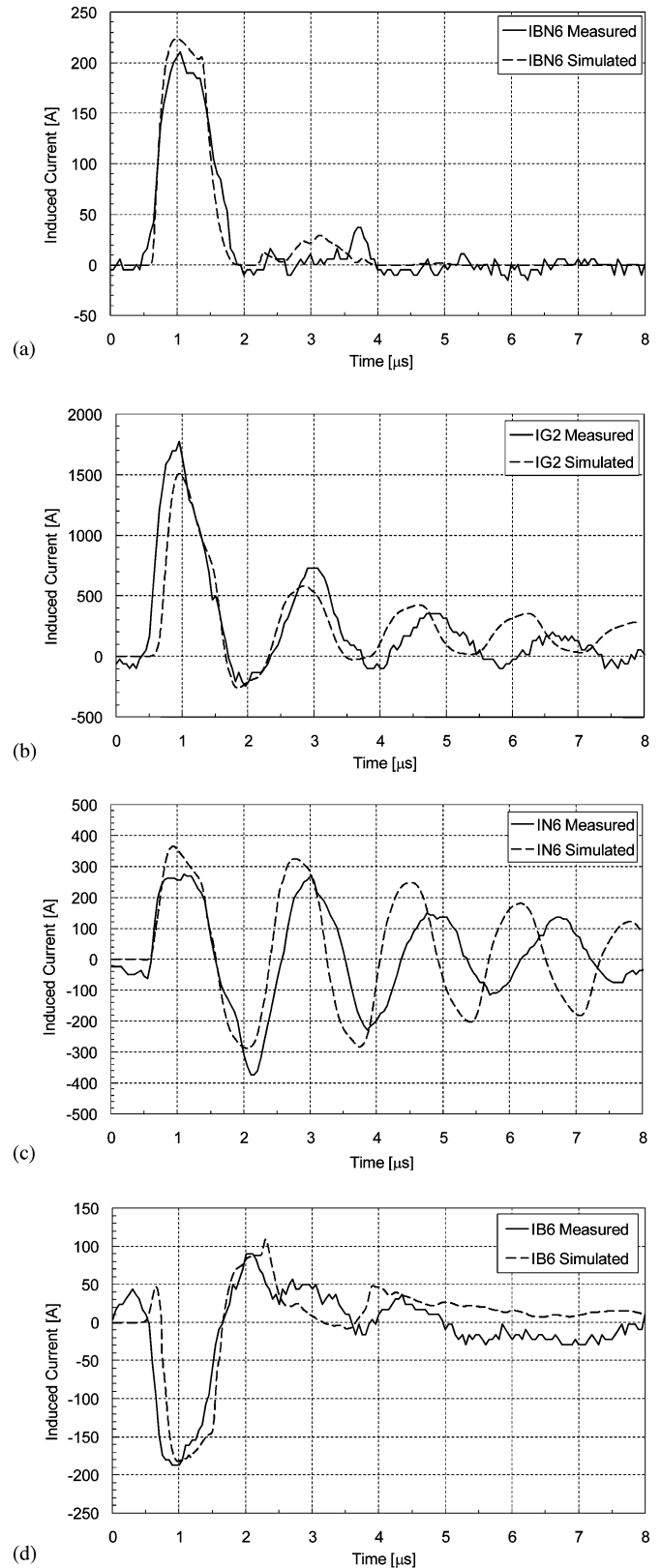

Fig. 16. Comparison between measured and simulated lightning-induced currents along the experimental overhead distribution line of Fig. 15. (a) Induced current flowing through the arrester located at pole 6 phase B. (b) Induced current flowing through the grounding of pole 2. (c) Induced current flowing through the neutral conductor at pole 6. (d) Induced current flowing through the phase B at pole 6.

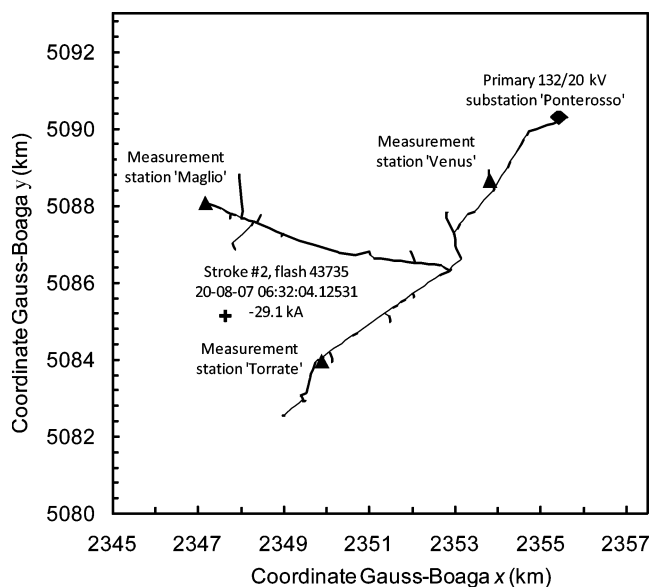

Fig. 17. Location of the second stroke of the three-stroke flash number #43 735 recorded by CESI-SIRF on August 20, 2007. Estimated current amplitude: 29.1 kA, negative polarity.

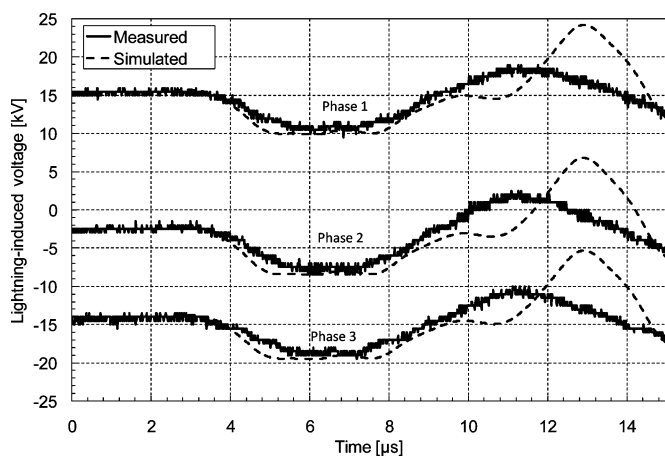

Fig. 18. Example of a comparison between measured and simulated induced overvoltage in correspondence of the event reported in Fig. 17 for the measurement station “Maglio.”

dence with the line terminations, have been modeled by means of a Π circuit of capacitances in order to represent, to a first approximation, their response to transients characterized by a frequency range around 100 kHz. The value of the equivalent capacitance of the MV side has been inferred from measurements performed on typical distribution transformers and chosen equal to 250 pF [111].

- 8) The power transformers installed in the considered network are assumed to be protected by means of 20-kV rated surge arresters with a $V-I$ characteristic obtained using a standard 8/20 μ s pulse [112].

Fig. 18 shows the comparison between the calculated and measured voltages for the measurement station “Maglio” shown in Fig. 17. It can be noted that within the limits of the simplifying assumptions that have been adopted and the complexity of the considered network, the comparison can be considered satisfactory.

IV. CONCLUSION

A survey of the theoretical bases of recently developed models for the calculation of LEMP-originated transients in overhead power lines was presented. The models take into account multiconductor lines above a lossy ground and the presence of a multibranch power system network, including components and protection devices (e.g., grounded conductors, surge arresters).

Special emphasis was placed on the experimental validation of the field-to-transmission-line coupling models. Two types of experimental data have been used for this purpose, namely: 1) reduced-scale setups with LEMP and NEMP simulators and 2) full-scale setups illuminated by artificially initiated lightning. Comparisons between simulations and experimental data obtained using the above techniques have in general shown fairly good agreement.

The paper has also presented comparisons with new data obtained on a real-world distribution network on which natural lightning-induced voltages were measured and correlated with data from a lightning location system. The good agreement between measurements and simulations demonstrates the applicability of the described models to the analysis of lightning transients on real distribution networks, in, for example, insulation coordination and lightning-to-fault correlation studies.

ACKNOWLEDGMENT

The authors thankfully acknowledge years of collaborations and profitable discussions with Prof. M. Ianoz, Prof. C. Mazzetti, Dr. M. Bernardi, Dr. S. Guerrieri, Dr. F. Napolitano, and Dr. E. Petrace.

REFERENCES

- [1] *IEEE Guide for Improving the Lightning Performance of Electric Power Overhead Distribution Lines*, IEEE Standard 1410, 2004.
- [2] *CIGRE-CIRED JWG C4.4.02: Protection of MV and LV Networks Against Lightning. Part I: Common Topics*, Int. Council Large Electr. Syst. (CIGRE), Paris, France, CIGRE Tech. Brochure No. 287, 2006.
- [3] A. Borghetti, C. A. Nucci, and M. Paolone, “An improved procedure for the assessment of overhead line indirect lightning performance and its comparison with the IEEE Std. 1410 method,” *IEEE Trans. Power Del.*, vol. 22, no. 1, pp. 684–692, Jan. 2007.
- [4] S. Yokoyama, K. Yamamoto, and H. Kinoshita, “Analogue simulation of lightning induced voltages and its application for analysis of overhead-ground-wire effects,” *Proc. Inst. Electr. Eng.*, vol. 132, pp. 208–216, 1985.
- [5] S. Yokoyama, “Distribution surge arrester behavior due to lightning induced voltages,” *IEEE Trans. Power Del.*, vol. PWRD-1, no. 1, pp. 171–178, Jan. 1986.
- [6] T. A. Short and R. H. Ammon, “Monitoring results of the effectiveness of surge arrester spacings on distribution line protection,” *IEEE Trans. Power Del.*, vol. 14, no. 3, pp. 1142–1150, Jul. 1999.
- [7] M. Paolone, C. A. Nucci, E. Petrace, and F. Rachidi, “Mitigation of lightning-induced overvoltages in medium voltage distribution lines by means of periodical grounding of shielding wires and of surge arresters: Modelling and experimental validation,” *IEEE Trans. Power Del.*, vol. 19, no. 1, pp. 423–431, Jan. 2004.
- [8] K. L. Cummins, E. P. Krider, and M. D. Malone, “The US national lightning detection network (TM) and applications of cloud-to-ground lightning data by electric power utilities,” *IEEE Trans. Electromagn. Compat.*, vol. 40, no. 4, pp. 465–480, Nov. 1998.
- [9] G. Diendorfer, “Correlation of power line failures and lightning location data,” presented at the 5th Int. Workshop Phys. Lightning, Nagoya, Japan, 2001.

- [10] J. Kosmač and V. Djurica, "Use of lightning stroke information for overhead line fault location," presented at the CIGRE, Paris, France, 2002.
- [11] M. Bernardi, C. Giorgi, and V. Biscaglia, "Medium voltage line faults correlation with lightning events recorded with the Italian LLP system CESI-SIRF," in *Proc. 24th Int. Conf. Lightning Prot.*, Birmingham, U.K., 1998, pp. 187–192.
- [12] A. Borghetti, C. A. Nucci, M. Paolone, and M. Bernardi, "A statistical approach for estimating the correlation between lightning and faults in power distribution systems," in *Proc. 9th Int. Conf. Probabilistic Methods Appl. Power Syst.*, Stockholm, Sweden, 2006, pp. 1–7.
- [13] A. Borghetti, F. Napolitano, C. A. Nucci, M. Paolone, M. Bernardi, F. Rachidi, and K. Yamabuki, "Correlation of lightning events and faults in distribution power networks: A joint research project," presented at the CIGRE, Paris, France, 2008.
- [14] S. Rusck, "Protection of distribution systems," in *Lightning*, vol. 2, R. H. Golde, Ed. New York: Academic, 1977.
- [15] S. Rusck, "Induced lightning overvoltages on power transmission lines with special reference to the overvoltage protection of low voltage networks," *Trans. Roy. Inst. Technol. Stockholm*, vol. 120, 1958, pp. 1–118.
- [16] M. Darveniza, "A practical extension of Rusck's formula for maximum lightning induced voltage that accounts for ground resistivity," *IEEE Trans. Power Del.*, vol. 22, no. 1, pp. 605–612, Jan. 2007.
- [17] C. Nucci and F. Rachidi, "Interaction of electromagnetic fields generated by lightning with overhead electrical networks," in *The Lightning Flash*, V. Cooray, Ed. London, U.K.: IEE Press, 2003, pp. 425–478.
- [18] H. K. Hoidal, "Calculation of lightning-induced voltages in MODELS including lossy ground effects," presented at the Int. Conf. Power Syst. Transient IPST 2003, New Orleans, LA.
- [19] A. Borghetti, A. Gutierrez, C. A. Nucci, M. Paolone, E. Petrache, and F. Rachidi, "Lightning-induced voltages on complex distribution systems: Models, advanced software tools and experimental validation," *J. Electrostatics*, vol. 60, pp. 163–174, 2004.
- [20] Y. Baba and V. A. Rakov, "Voltages induced on an overhead wire by lightning strikes to a nearby tall grounded object," *IEEE Trans. Electromagn. Compat.*, vol. 48, no. 1, pp. 212–224, Feb. 2006.
- [21] H. M. Ren, B. H. Zhou, V. A. Rakov, L. H. Shi, C. Gao, and J. H. Yang, "Analysis of lightning-induced voltages on overhead lines using a 2-D FDTD method and Agrawal coupling model," *IEEE Trans. Electromagn. Compat.*, vol. 50, no. 3, pp. 651–659, Aug. 2008.
- [22] C. D. Taylor, R. S. Satterwhite, and C. W. Harrison, "The response of a terminated two-wire transmission line excited by a nonuniform electromagnetic field," *IEEE Trans. Antennas Propag.*, vol. AP-13, no. 6, pp. 987–989, Nov. 1965.
- [23] A. K. Agrawal, H. J. Price, and S. H. Gurbaxani, "Transient response of multiconductor transmission lines excited by a nonuniform electromagnetic field," *IEEE Trans. Electromagn. Compat.*, vol. 22, no. 2, pp. 119–129, May 1980.
- [24] F. Rachidi, "Formulation of the field-to-transmission line coupling equations in terms of magnetic excitation fields," *IEEE Trans. Electromagn. Compat.*, vol. 35, no. 3, pp. 404–407, Aug. 1993.
- [25] C. A. Nucci, G. Diendorfer, M. Uman, F. Rachidi, M. Ianoz, and C. Mazzetti, "Lightning return stroke current models with specified channel-base current: A review and comparison," *J. Geophys. Res.*, vol. 95, pp. 20395–20408, 1990.
- [26] R. Thottappillil and M. A. Uman, "Comparison of lightning return-stroke models," *J. Geophys. Res.*, vol. 98, pp. 22903–22914, 1993.
- [27] C. Nucci, "Lightning-induced voltages on overhead power lines. Part I: Return stroke current models with specified channel-base current for the evaluation of the return stroke electromagnetic fields," *Electra*, vol. 161, pp. 74–102, 1995.
- [28] R. Thottappillil, V. Rakov, and M. Uman, "Distribution of charge along the lightning channel: Relation to remote electric and magnetic fields and to return-stroke models," *J. Geophys. Res.*, vol. 102, pp. 6987–7006, 1997.
- [29] V. A. Rakov, M. A. Uman, K. J. Rambo, M. I. Fernandez, R. J. Fisher, G. H. Schnetzer, R. Thottappillil, A. E. Berard, J. P. Berlandis, P. Lalonde, A. Bonamy, P. Laroche, and A. B. Clergeries, "New insights into lightning processes gained from triggered-lightning experiments in Florida and Alabama," *J. Geophys. Res.*, vol. 103, pp. 14117–14130, 1998.
- [30] C. Gomes and V. Cooray, "Concepts of lightning return stroke models," *IEEE Trans. Electromagn. Compat.*, vol. 42, no. 1, pp. 82–96, Feb. 2000.
- [31] V. A. Rakov, "Lightning return stroke modeling: Recent developments," presented at the Int. Conf. Grounding Earthing—GROUND 2002, Rio de Janeiro, Brazil.
- [32] V. A. Rakov and M. A. Uman, "Review and evaluation of lightning return stroke models including some aspects of their application," *IEEE Trans. Electromagn. Compat.*, vol. 40, no. 4, pp. 403–426, Nov. 1998.
- [33] F. Rachidi, M. Rubinstein, S. Guerrieri, and C. A. Nucci, "Voltages induced on overhead lines by dart leaders and subsequent return strokes in natural and rocket-triggered lightning," *IEEE Trans. Electromagn. Compat.*, vol. 39, no. 2, pp. 160–166, May 1997.
- [34] V. A. Rakov and M. A. Uman, *Lightning: Physics and Effects*. Cambridge, MA: Cambridge Univ. Press, 2003.
- [35] V. Cooray, "Mathematical modeling of return strokes," in *The Lightning Flash: Physical and Engineering Aspects*, V. Cooray, Ed. London, U.K.: IEE Press, 2003.
- [36] R. Thottappillil, "Computation of electromagnetic fields from lightning discharge," in *The Lightning Flash: Physical and Engineering Aspects*, V. Cooray, Ed. London, U.K.: IEE Press.
- [37] M. Master and M. A. Uman, "Transient electric and magnetic fields associated with establishing a finite electrostatic dipole," *Amer. J. Phys.*, vol. 51, pp. 118–126, 1983.
- [38] M. Rubinstein and M. A. Uman, "Methods for calculating the electromagnetic fields from a known source distribution: Application to lightning," *IEEE Trans. Electromagn. Compat.*, vol. 31, no. 2, pp. 183–189, May 1989.
- [39] P. Degauque, "Current and voltage induced on telecommunications cable by a lightning return stroke," in *Lightning Electromagnetics*, R. L. Gardner, Ed. New York: Hemisphere, 1990, pp. 377–440.
- [40] M. Rubinstein, "An approximate formula for the calculation of the horizontal electric field from lightning at close, intermediate, and long range," *IEEE Trans. Electromagn. Compat.*, vol. 38, no. 3, pp. 531–535, Aug. 1996.
- [41] C. A. Nucci and F. Rachidi, "Interaction of electromagnetic fields generated by lightning with overhead electrical networks," in *The Lightning Flash*. London, U.K.: IEE Press, 2003, pp. 425–478.
- [42] F. Delfino, R. Procopio, and M. Rossi, "Lightning return stroke current radiation in presence of a conducting ground: 1. Theory and numerical evaluation of the electromagnetic fields," *J. Geophys. Res.*, vol. 113, pp. D05110-1–D05110-10, 2008.
- [43] M. Rubinstein, "An approximate formula for the calculation of the horizontal electric field from lightning at close, intermediate, and long range," *IEEE Trans. Electromagn. Compat.*, vol. 38, no. 3, pp. 531–535, Aug. 1996.
- [44] V. Cooray, "Horizontal fields generated by return strokes," *Radio Sci.*, vol. 27, pp. 529–537, 1992.
- [45] J. R. Wait, "Concerning the horizontal electric field of lightning," *IEEE Trans. Electromagn. Compat.*, vol. 39, no. 2, p. 186, May 1997.
- [46] V. Cooray, "Some considerations on the 'Cooray–Rubinstein' approximation used in deriving the horizontal electric field over finitely conducting ground," in *24th Int. Conf. Lightning Protection*, Birmingham, U.K., 1998, pp. 282–286.
- [47] F. Rachidi, C. A. Nucci, M. Ianoz, and C. Mazzetti, "Importance of losses in the determination of lightning-induced voltages on overhead lines," presented at the Int. Symp. Electromagn. Compat. (EMC 1996 ROMA). Univ. Rome 'La Sapienza', Rome, Italy, vol. 2.
- [48] F. Delfino, R. Procopio, M. Rossi, F. Rachidi, and C. A. Nucci, "Lightning return stroke current radiation in presence of a conducting ground: 2. Validity assessment of simplified approaches," *J. Geophys. Res.*, vol. 113, pp. 1–11, 2008.
- [49] V. A. Rakov and F. Rachidi, "Overview of recent progress in lightning research and lightning protection," *IEEE Trans. Electromagn. Compat.*, this issue, 2009.
- [50] A. S. Podgorski and J. A. Landt, "Three dimensional time domain modelling of lightning," *IEEE Trans. Power Del.*, vol. PWRD-2, no. 3, pp. 931–938, Jul. 1987.
- [51] R. Moini, B. Kordi, G. Z. Rafi, and V. A. Rakov, "A new lightning return stroke model based on antenna theory," *J. Geophys. Res.*, vol. 105, pp. 29693–29702, 2000.
- [52] Y. Baba and M. Ishii, "Numerical electromagnetic field analysis of lightning current in tall structures," *IEEE Trans. Power Del.*, vol. 16, no. 2, pp. 324–328, Apr. 2001.
- [53] E. Petrache, F. Rachidi, M. Paolone, C. Nucci, V. A. Rakov, and M. A. Uman, "Lightning-induced voltages on buried cables. Part I: Theory," *IEEE Trans. Electromagn. Compat.*, vol. 47, no. 3, pp. 498–508, Aug. 2005.
- [54] A. Shoory, R. Moini, S. H. H. Sadeghi, and V. A. Rakov, "Analysis of lightning-radiated electromagnetic fields in the vicinity of lossy ground,"

- IEEE Trans. Electromagn. Compat.*, vol. 47, no. 1, pp. 131–145, Feb. 2005.
- [55] C. A. F. Sartori and J. R. Cardoso, “An analytical-FDTD method for near LEMP calculation,” *IEEE Trans. Magn.*, vol. 36, no. 4, pp. 1631–1634, Jul. 2000.
- [56] C. Yang and B. Zhou, “Calculation methods of electromagnetic fields very close to lightning,” *IEEE Trans. Electromagn. Compat.*, vol. 46, no. 1, pp. 133–141, Feb. 2004.
- [57] Y. Baba and V. A. Rakov, “On the mechanism of attenuation of current waves propagating along a vertical perfectly conducting wire above ground: Application to lightning,” *IEEE Trans. Electromagn. Compat.*, vol. 47, no. 3, pp. 521–532, Aug. 2005.
- [58] A. Mimouni, F. Rachidi, and Z. Azzouz, “A finite-difference time-domain approach for the evaluation of electromagnetic fields radiated by lightning to tall structures,” *J. Electrostatics*, vol. 866, pp. 504–513, 2008.
- [59] F. M. Tesche, “Comparison of the transmission line and scattering models for computing the HEMP response of overhead cables,” *IEEE Trans. Electromagn. Compat.*, vol. 34, no. 2, pp. 93–99, May 1992.
- [60] F. Rachidi, C. A. Nucci, and M. Ianoz, “Transient analysis of multiconductor lines above a lossy ground,” *IEEE Trans. Power Del.*, vol. 14, no. 1, pp. 294–302, Jan. 1999.
- [61] F. M. Tesche, M. Ianoz, and T. Karlsson, *EMC Analysis Methods and Computational Models*. New York: Wiley-Interscience, 1997.
- [62] E. D. Sunde, *Earth Conduction Effects in Transmission Systems*. New York: Dover, 1968.
- [63] F. Rachidi, C. A. Nucci, and I. M. C. Mazzetti, “Influence of a lossy ground on lightning-induced voltages on overhead lines,” *IEEE Trans. Electromagn. Compat.*, vol. 38, no. 3, pp. 250–264, Aug. 1996.
- [64] F. Rachidi, S. Loyka, C. A. Nucci, and M. Ianoz, “A new expression for the ground transient resistance matrix elements of multiconductor overhead transmission lines,” *Electr. Power Syst. Res. J.*, vol. 65, pp. 41–46, 2003.
- [65] R. Araneo and S. Cellozi, “Direct time domain analysis of transmission lines above a lossy ground,” *Inst. Electr. Eng. Proc. Sci. Meas. Technol.*, vol. 148, pp. 73–79, 2001.
- [66] N. Theethayi and R. Thottappillil, “Surge propagation and crosstalk in multiconductor transmission lines above ground,” in *Electromagnetic Field Interaction with Transmission Lines. From Classical Theory to HF Radiation Effects*, F. Rachidi and S. Tkachenko, Eds. Billerica, MA: WIT Press, 2008.
- [67] A. Tafflove, *Computational Electrodynamics: The Finite Difference Time Domain Method*. Norwood, MA: Artech House, 1995.
- [68] M. Paolone, C. A. Nucci, and F. Rachidi, “A new finite difference time domain scheme for the evaluation of lightning induced overvoltages on multiconductor overhead lines,” presented at the 5th Int. Conf. Power Syst. Transients, Rio de Janeiro, Brazil, 2001.
- [69] P. D. Lax and B. Wendroff, “System of conservation laws,” *Comm. Pure Appl. Math.*, vol. 13, pp. 217–237, 1960.
- [70] S. R. Omick and S. P. Castillo, “A new finite difference time-domain algorithm for the accurate modeling of wide-band electromagnetic phenomena,” *IEEE Trans. Electromagn. Compat.*, vol. 35, no. 2, pp. 215–222, May 1993.
- [71] M. Paolone, “Modeling of lightning-induced voltages on distribution networks for the solution of power quality problems, and relevant implementation in a transient program,” Ph.D. dissertation, Dept. Electr. Eng., Univ. Bologna, Bologna, Italy, 2001, p. 117.
- [72] C. A. Nucci, V. Bardazzi, R. Iorio, A. Mansoldo, and A. Porrino, “A code for the calculation of lightning-induced overvoltages and its interface with the electromagnetic transient program,” presented at the 22nd Int. Conf. Lightning Protection (ICLP), Budapest, Hungary, 1994.
- [73] D. Orzan, P. Baraton, M. Ianoz, and F. Rachidi, “Comparaison entre deux approches pour traiter le couplage entre un champ EM et des réseaux de lignes,” presented at the 8ème Colloque Int. sur la Compat. Electromagn., Lille, France, 1996.
- [74] D. Orzan, “Couplage externe et interne entre un champ électromagnétique et un réseau de lignes multifilaires,” Ph.D. thesis, Ecole Polytech. Federale Lausanne, Lausanne, Switzerland, 1998.
- [75] H. K. Hoidalén, “Lightning-induced overvoltages in low-voltage systems,” Ph.D. thesis, Norwegian Univ. Sci. Technol., Trondheim, Norway, 1997.
- [76] H. K. Hoidalén, “Calculation of lightning-induced overvoltages using MODELS,” presented at the Int. Conf. Power Syst. Transients. Budapest, Hungary, 1999.
- [77] H. K. Hoidalén, “Analytical formulation of lightning-induced voltages on multiconductor overhead lines above lossy ground,” *IEEE Trans. Electromagn. Compat.*, vol. 45, no. 1, pp. 92–100, Feb. 2003.
- [78] E. Perez, A. Delgado, D. Urrutia, and H. Torres, “Optimizing the surge arresters location for improving lightning induced voltage performance of distribution network,” in *Proc. IEEE PES Gen. Meeting*, 2007, pp. 1–6.
- [79] F. Napolitano, A. Borghetti, C. A. Nucci, M. Paolone, F. Rachidi, and J. Mahserjian, “An advanced interface between the LIOV code and the EMTP-RV,” presented at the 29th Int. Conf. Lightning Protection (ICLP), Uppsala, Sweden, 2008.
- [80] R. Montano, N. Theethayi, and V. Cooray, “An efficient implementation of the Agrawal *et al.* model for lightning-induced voltage calculations using circuit simulation software,” *IEEE Trans. Circuits Syst. I: Reg. Papers*, vol. 55, no. 9, pp. 2959–2965, Oct. 2008.
- [81] S. Yokoyama, K. Miyake, H. Mitani, and A. Takahashi, “Simultaneous measurement of lightning induced voltages with associated stroke currents,” *IEEE Trans. Power App. Syst.*, vol. PAS-102, no. 8, pp. 2420–2429, Aug. 1983.
- [82] S. Yokoyama, K. Miyake, H. Mitani, and N. Yamazaki, “Advanced observations of lightning induced voltage on power distribution lines,” *IEEE Trans. Power Del.*, vol. 1, no. 2, pp. 129–139, Apr. 1986.
- [83] S. Yokoyama, K. Miyake, and S. Fukui, “Advanced observations of lightning induced voltages on power distribution lines (II),” *IEEE Trans. Power Del.*, vol. 4, no. 4, pp. 2196–2203, Oct. 1989.
- [84] M. J. Master, M. A. Uman, W. Beasley, and M. Darveniza, “Lightning induced voltages on power lines: Experiment,” *IEEE Trans. Power App. Syst.*, vol. PAS-103, no. 9, pp. 2519–2529, Sep. 1984.
- [85] M. Rubinstein, A. Y. Tzeng, M. A. Uman, P. J. Medelius, and E. M. Thomson, “An experimental test of a theory of lightning-induced voltages on an overhead wire,” *IEEE Trans. Electromagn. Compat.*, vol. 31, no. 4, pp. 376–383, Nov. 1989.
- [86] N. Georgiadis, M. Rubinstein, M. A. Uman, P. J. Medelius, and E. M. Thomson, “Lightning-induced voltages at both ends of a 448-m power-distribution line,” *IEEE Trans. Electromagn. Compat.*, vol. 34, no. 4, pp. 451–460, Nov. 1992.
- [87] F. De la Rosa, R. Valdivia, H. Pérez, and J. Loza, “Discussion about the inducing effects of lightning in an experimental power distribution line in Mexico,” *IEEE Trans. Power Del.*, vol. 3, no. 3, pp. 1080–1089, Jul. 1988.
- [88] V. Cooray and F. De la Rosa, “Shapes and amplitudes of the initial peaks of lightning-induced voltage in power lines over finitely conducting earth: Theory and comparison with experiment,” *IEEE Trans. Antennas Propag.*, vol. AP-34, no. 1, pp. 88–92, Jan. 1986.
- [89] P. P. Barker, T. A. Short, A. Eybert-Berard, and J. B. Berlandis, “Induced voltage measurements on an experimental distribution line during nearby rocket triggered lightning flashes,” *IEEE Trans. Power Del.*, vol. 11, no. 2, pp. 980–995, Apr. 1996.
- [90] C. E. Baum, “EMP Simulators, for various types of nuclear EMP environment: And interim categorization,” *IEEE Trans. Electromagn. Compat.*, vol. EMC-20, no. 1, pp. 35–53, Feb. 1978.
- [91] F. Arreghini, M. Ianoz, P. Zwiackner, D. V. Giri, and A. Tehori, “SEMI-RAMIS: An asymmetrical bounded wave EMP simulator with a good confinement inside the transmission line,” presented at the 10th Int. Zurich Symp. Electromagn. Compat., Zurich, Switzerland, 1993.
- [92] S. Guerrieri, F. Rachidi, M. Ianoz, P. Zwiackner, A. Borghetti, and C. A. Nucci, “Effet d’une impulsion électro-magnétique sur des réseaux électriques à plusieurs branches. Modélisation et validation expérimentale,” presented at the 7ème Colloque Int. sur la Compatibilité Electromagnétique, Toulouse, France, 1994.
- [93] S. Guerrieri, F. Rachidi, M. Ianoz, P. Zwiackner, and C. A. Nucci, “A time-domain approach to evaluate induced voltages on tree-shaped electrical networks by external electromagnetic fields,” presented at the 11th Int. Zurich Symp. Electromagn. Compat., Zurich, Switzerland, 1995.
- [94] M. Ishii, K. Michishita, Y. Hongo, and S. Ogume, “Lightning-induced voltage on an overhead wire dependent on ground conductivity,” *IEEE Trans. Power Del.*, vol. 9, no. 1, pp. 109–118, Jan. 1994.
- [95] A. Piantini and J. M. Janiszewski, “An experimental study of lightning induced voltages by means of a scale model,” in *Proc. 21st Int. Conf. Lightning Protection (ICLP)*, Berlin, Germany, 1992, pp. 195–199.
- [96] C. A. Nucci, A. Borghetti, A. Piantini, and W. Janischewskyj, “Lightning-induced voltages on distribution overhead lines: Comparison between experimental results from a reduced-scale model and most recent approaches,” in *Proc. 24th Int. Conf. Lightning Protection (ICLP)*, Birmingham, U.K., 1998, pp. 314–320.
- [97] A. Piantini, J. M. Janiszewski, A. Borghetti, C. A. Nucci, and M. Paolone, “A scale model for the study of the LEMP response of complex power distribution networks,” *IEEE Trans. Power Del.*, vol. 22, no. 1, pp. 710–720, Jan. 2007.

- [98] M. J. Master and M. A. Uman, "Lightning induced voltages on power lines: Theory," *IEEE Trans. Power App. Syst.*, vol. PAS-103, no. 9, pp. 2502–2518, Sep. 1984.
- [99] V. A. Rakov, "Lightning discharges triggered using rocket-and-wire techniques," *Recent Res. Devel. Geophys.*, vol. 2, pp. 141–171, 1999.
- [100] V. A. Rakov, M. A. Uman, D. Wang, K. J. Rambo, D. E. Crawford, and G. H. Schnetzer, "Lightning properties from triggered-lightning experiments at Camp Blanding, Florida (1997–1999)," in *Proc. 25th Int. Conf. Lightning Prot. (ICLP)*, Rhodes, Greece, 2000, pp. 54–59.
- [101] M. Paolone, E. Petrache, F. Rachidi, C. A. Nucci, V. A. Rakov, M. A. Uman, D. Jordan, K. Rambo, J. Jerauld, M. Nyffeler, and J. Schoene, "Lightning-induced voltages on buried cables. Part II: Experiment and model validation," *IEEE Trans. Electromagn. Compat.*, vol. 47, no. 3, pp. 498–508, Aug. 2005.
- [102] "IEEE Fast Front Transients Task Force: Modeling guidelines for fast front transients," *IEEE Trans. Power Del.*, vol. 11, no. 1, pp. 493–506, Jan. 1996.
- [103] R. Rudenberg, *Electrical Shock Waves in Power System*. Cambridge, MA: Harvard Univ. Press, 1968.
- [104] S. Bourq, B. Sacepe, and T. Debu, "Deep earth electrodes in highly resistive ground: Frequency behavior," in *Proc. IEEE Int. Symp. Electromagn. Compat.*, 1995, pp. 584–589.
- [105] L. Grech and M. Popov, "On high-frequency circuit equivalents of a vertical ground rod," *IEEE Trans. Power Del.*, vol. 20, no. 2, pp. 1598–1603, Apr. 2005.
- [106] C. Mata, "Interaction of lightning with power distribution lines," Ph.D. thesis, Univ. Florida, Gainesville, 2003.
- [107] R. B. Andersson and A. J. Eriksson, "Lightning parameters for engineering application," *Electra*, vol. 69, pp. 65–102, 1980.
- [108] CIGRE WG 01 of SC 33, "Guide to procedures for estimating the lightning performance of transmission lines," Int. Council Large Electr. Syst. (CIGRE), Paris, France, CIGRE Publication 63, 1991.
- [109] C. A. Nucci, C. Mazzetti, F. Rachidi, and M. Ianoz, "On lightning return stroke models for LEMP calculations," presented at the 19th Int. Conf. Lightning Protection (ICLP), Graz, Austria, 1988.
- [110] F. Rachidi and C. A. Nucci, "On the master, uman, lin, standler and the modified transmission line lightning return stroke current models," *J. Geophys. Res.*, vol. 95, pp. 20389–20394, 1990.
- [111] A. Borghetti, A. S. Morched, F. Napolitano, C. A. Nucci, and M. Paolone, "Lightning-induced overvoltages transferred through distribution power transformers," *IEEE Trans. Power Del.*, vol. 24, no. 1, pp. 360–372, Jan. 2005.
- [112] M. Bernardi, A. Borghetti, C. A. Nucci, F. Napolitano, M. Paolone, F. Rachidi, R. Vitale, and K. Yamabuki, "Lightning-correlated faults in power distribution networks," presented at the 2007 IEEE Power Tech., Lausanne, Switzerland, 2007.



Mario Paolone (M'07) was born in Campobasso, Italy, in 1973. He received the Electrical Engineering (Hons.) and Ph.D. degrees from the University of Bologna, Bologna, Italy, in 1998 and 2002, respectively.

He is currently a Research Fellow in the Power Systems Group, University of Bologna. His research interests include power system transients, with particular reference to lightning electromagnetic pulse interaction with electrical networks, power systems dynamics, power system protection, and distributed

generation.

Dr. Paolone is a member of the IEEE Working Group on lightning performance of distribution lines and of the joint International Council on Large Electric Systems–International Conference on Electricity Distribution (CIGRE–CIREN) Working Group "Protection of MV and LV networks against Lightning" and Cochairperson of the Technical Program committee of the 2009 edition of the *International Conference on Power Systems Transients*.



Farhad Rachidi (M'93–SM'02) received the M.S. degree in electrical engineering and the Ph.D. degree from the Swiss Federal Institute of Technology, Lausanne, Switzerland, in 1986 and 1991, respectively.

Until 1996, he was at the Power Systems Laboratory, Swiss Federal Institute of Technology, where he is currently the Head of the Electromagnetic Compatibility (EMC) Laboratory. In 1997, he joined the Lightning Research Laboratory, University of Toronto, Toronto, ON, Canada. From April 1998 until September 1999, he was with Montena EMC, Switzerland. He is the Deputy Editor-in-Chief of the *Journal of Lightning Research*. He is the author or coauthor of more than 250 scientific papers published in reviewed journals and presented at international conferences.

Dr. Rachidi is the President of the International Conference on Lightning Protection, the Vice-Chair of the European Cooperation in Science and Technology (COST) Action on the physics of lightning flash and its effects, and an Associate Editor of the IEEE TRANSACTIONS ON ELECTROMAGNETIC COMPATIBILITY. In 2005, he was the recipient of the IEEE Technical Achievement Award and the International Council on Large Electric Systems (CIGRE) Technical Committee Award. He was awarded the 2006 Blondel Medal from the French Association of Electrical Engineering, Electronics, Information Technology, and Communication (SEE).



Alberto Borghetti (M'97–SM'03) was born in Cesena, Italy, in 1967. He received the M.Sc. (with honors) degree in electrical engineering from the University of Bologna, Bologna, Italy, in 1992.

Since then he has been with the Power System Group, University of Bologna, where he was appointed as a Researcher in 1994 and an Associate Professor of electric power systems in 2004. His current research interests include power system analysis, with particular reference to voltage collapse, power system restoration after blackout, electromagnetic transients, and optimal generation scheduling.



Carlo Alberto Nucci (M'91–SM'02–F'07) was born in Bologna, Italy, in 1956. He received the Electrical Engineering degree (Hons.) from the University of Bologna, Bologna, in 1982.

He is currently a Professor of electrical power systems in the Department of Electrical Engineering, University of Bologna. He is the author or coauthor of more than 200 scientific papers published in reviewed journals or presented at international conferences. His current research interests include power systems transients and dynamics, with particular reference to lightning impact on power lines, system restoration after blackout, and distributed generation. Since 2005, he has been a Regional Editor of the *Electric Power System Research Journal* for Africa and Europe.

Prof. Nucci is a member of the IEEE Working Group "Lightning performance of distribution lines." In the International Council on Large Electric Systems (CIGRE), he is the Chairman of the Study Committee C4 "System Technical Performance." He is also a Fellow of the Institution of Engineering and Technology (IET).



Marcos Rubinstein (M'84) received the Bachelor's degree in electronics from the Universidad Simon Bolivar, Caracas, Venezuela, and the Master's and Ph.D. degrees in electrical engineering from the University of Florida, Gainesville.

He was at the Venezuelan Engineering Research Institute, Caracas, where he was engaged in hybrid circuit manufacturing technology. In 1992, he joined the Swiss Federal Institute of Technology, Lausanne, Switzerland, where he was involved in the fields of electromagnetic compatibility and lightning in close cooperation with the former Swiss PTT. In 1995, he joined Swisscom, where he was involved in numerical electromagnetics and electromagnetic compatibility (EMC) in telecommunications. He was the Manager of an EMC in Telecommunications Research Program, where he led a number of coordinated projects covering the fields of EMC, numerical electromagnetics, and biological effects of electromagnetic radiation. In 2001, he joined the University of Applied Sciences of Western Switzerland, Delemont, where he is currently a Professor in telecommunications and a member of the ICT Institute team. His current research interests include EMC in telecommunication systems, programmable logic controller (PLC), wireless technologies, and layer-2 network security. He is the author or coauthor of more than 100 scientific publications in reviewed journals and international conferences.

Prof. Rubinstein is the recipient of the best Master's Thesis award from the University of Florida and the Corecipient of the National Aeronautics and Space Administration's (NASA's) recognition for innovative technological work. He is also a member of the Swiss Academy of Sciences and of the International Union of Radio Science.



Vladimir A. Rakov (SM'96–F'03) received the M.S. and Ph.D. degrees in electrical engineering from Tomsk Polytechnical University (Tomsk Polytechnic), Tomsk, Russia, in 1977 and 1983, respectively.

From 1977 to 1979, he was an Assistant Professor of electrical engineering at Tomsk Polytechnic. From 1978, he was engaged in lightning research at the High Voltage Research Institute (a division of Tomsk Polytechnic), where he was the Director of the Lightning Research Laboratory from 1984 to 1994. He is currently a Professor in the Department of Electrical and Computer Engineering, University of Florida, Gainesville, where he is also a Co-Director of the International Center for Lightning Research and Testing (ICLRT) and Chair of Electromagnetics and Energy Systems Division. He is the lead author of one book *Lightning: Physics and Effects*, and has authored or coauthored more than 500 other publications on various aspects of lightning with over 160 papers being published in reviewed journals. He is an Editor or an Associate Editor of four technical journals.

Dr. Rakov is the Chairman of the Technical Committee on Lightning of the Biennial International Zurich Symposium on Electromagnetic Compatibility, a Co-Chairman of the International Union of Radio Science (URSI) Working Group (WG) E.4 "Lightning Discharges and Related Phenomena," and the Convener of the International Council on Large Electric Systems (CIGRE) WG C4-407 "Lightning Parameters for Engineering Applications." He is a Fellow of the American Meteorological Society (AMS) and the Institution of Engineering and Technology (formerly IEE).



Martin A. Uman (F'88) received the Ph.D. degree from Princeton University, Princeton, NJ, in 1961.

He is currently a Distinguished Professor in the Department of Electrical and Computer Engineering, University of Florida, Gainesville. He has written five books on the subject of lightning, as well as a book on plasma physics, and has authored or coauthored over 180 papers in reviewed journals. He holds six patents, five in the area of lightning detection and location. From 1961 to 1964, he was an Associate Professor of electrical engineering at the University of Arizona, Tucson. After working for seven years as a Fellow Physicist at Westinghouse Research Laboratory, Pittsburgh, in 1971, he joined the Faculty of the University of Florida. He was a Cofounder and was the President of Lightning Location and Protection, Inc. (LLP), from 1975 to 1985.

Dr. Uman is the recipient of the 1996 IEEE Heinrich Hertz Medal for outstanding contributions to the understanding of lightning electromagnetics and its application to lightning detection and protection and the 2001 American Geophysical Union (AGU) John Adam Fleming Medal for original research and technical leadership in geomagnetism, atmospheric electricity, space science, aeronomy, and related sciences: for outstanding contribution to the description and understanding of electricity and magnetism of the Earth and its atmosphere. He is a Fellow of the AGU and the American Mathematical Society.