

Title	Magnetic Control of Plasma Arc Welding
Author(s)	Arata, Yoshiaki; Maruo, Hiroshi
Citation	Transactions of JWRI. 1(1) P.1-P.9
Issue Date	1972-09
Text Version	publisher
URL	<a href="http://hdl.handle.net/11094/11838">http://hdl.handle.net/11094/11838</a>
DOI	
rights	本文データはCiNiiから複製したものである
Note	

*Osaka University Knowledge Archive : OUKA*

<https://ir.library.osaka-u.ac.jp/>

Osaka University

# Magnetic Control of Plasma Arc Welding<sup>†</sup>

Yoshiaki ARATA\* and Hiroshi MARUO\*\*

## Abstract

*When the cusp magnetic field is imposed upon the plasma arc, arc column is deformed into high energetic elliptical plasma column. In this report, some experimental results is described on welding stainless steel plate with use of magnetically controlled plasma arc.*

*Electromagnets for the plasma arc welding torch were designed so as to produce strong magnetic field in the vicinity of plasma arc. Magnetic constriction of the plasma arc is seemed to be much effective, but the deformation of arc plasma is not so extensively as observed in case of TIG arc.*

*Welding stainless steel plate with magnetically controlled plasma arc is performed in a Key-hole method. Bead-on-plate test shows that the bead width become much narrower than those in ordinary plasma arc process.*

*Shape and cross-section of weld bead is discussed in relation to welding parameters selected, and also to the bead formation mechanism.*

## 1. Introduction

In many practical applications of fusion welding, it is effective to use a welding heat source having a high energy density, as was obvious from the welds by an electron beam welding. If it would be possible to constrict the welding arc by some means, narrow and deep penetrated weld bead may also be formed at a relatively high welding speed on the same principle.

The problem of magnetic control of welding arc is of great interest not only from view points of controlling the welding arc, but also of achieving such distinctive weld bead. Considerable works<sup>1-5)</sup> have been carried out in the past toward the use of magnetic field for the improvements of welds and related phenomena, but almost of them were concerned with the unidirectional field such as transverse, parallel or longitudinal fields with respect to the arc.

The authors have previously reported some effects of cusp-type magnetic field upon a tungsten inert gas arc (TIG arc)<sup>6)</sup>. When the cusp magnetic field was applied to the TIG arc, arc column was changed into a high energetic elliptical column and current density in it increased markedly as a result of reduction in a crosssectional area.

By virtue of this magnetic constriction of TIG arc, weld bead was found to be reduced in width and to be increased in penetration. Formation of these weld beads was understood well by assuming that the arc under the influence of cusp magnetic field yields similar characteristics to surface heat source distributed

linearly along the welding direction.

As for the control of plasma arc, similar effect was not seemed to be so feasible as observed in the TIG arc, because plasma arc column has already constricted to some extent by the water-cooled metallic nozzle through which plasma arc was sustained.

Present investigation was initiated to ascertain whether magnetic constriction of plasma arc is feasible or not. A set of special magnetic pole piece was constructed for the test, and cusp type magnetic field was applied to the plasma arc column, in a similar manner as described in a previous report.

The plasma arc column between the torch and work piece was compressed well toward its central part by applying cusp magnetic field, and its deformation became strong as the field strength was increased. It was also observed the arc voltage to rise according as the magnetic field became stronger. The ratio of heat delivered to the workpiece against the electrical input was found to be remained around 75%, which was a similar value as obtained in case of TIG arc.

Practical welding tests were carried out for 304 type stainless steel plate, 6 mm in thickness, without the addition of filler metal.

It should be noted that all of the weld with applied cusp magnetic field were carried out in a Key-hole method, as well as ordinary process, and width of weld beads made by such a controlled plasma arc was fairly narrow comparing with those by a conventional plasma welding method. Furthermore welding range to give a satisfactory welds could be expanded

<sup>†</sup> Received on May 31, 1972

\* Professor

\*\* Associate Professor, Dep. of Welding Engineering, Faculty of Engineering, Osaka University

markedely by an application of cusp magnetic field. These distinctive features were seemed to be a results of change in shape and size of weld pool in which the weld metal solidified. Flow of molten metal and its temperature were also varied in accordance with the variation of current distribution in the weld pool.

Another advantage of magnetically controlled plasma arc welding process was that the undercut free weld bead could be obtained even in the case it would be sure to form if no magnetic field was applied.

**2. Experimental Equipments and Materials**

(1) Electromagnet

An elementary cusp type magnetic field is produced with two set of electromagnet in such an alignment as the magnetic flux made by each pole piece is equal in magnitude and opposit in direction to each other. In order to intensify a magnetic constriction against the plasma arc column between the torch and workpiece, three types of pole pieces were designed and examined.

Details of each pole piece are as shown in Fig. 1. Pole pieces (b) and (c) types in Fig. 1 were designed

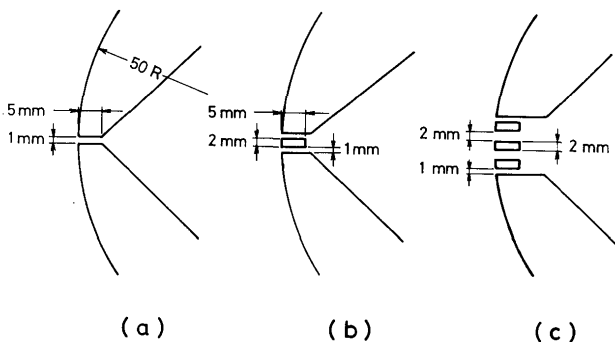

Fig. 1. Various types of magnetic pole piece.

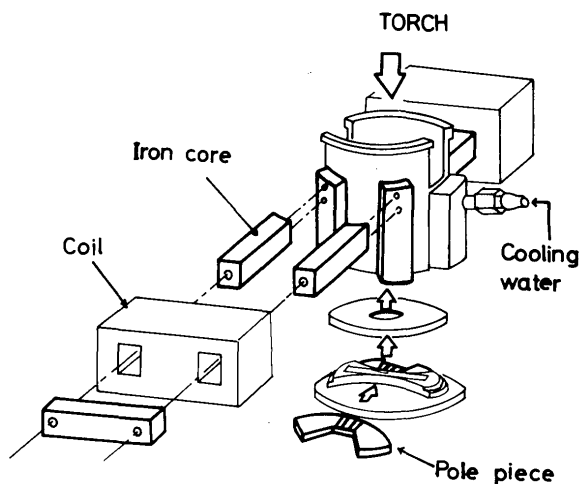

Fig. 2. Assembly of electromagnet.

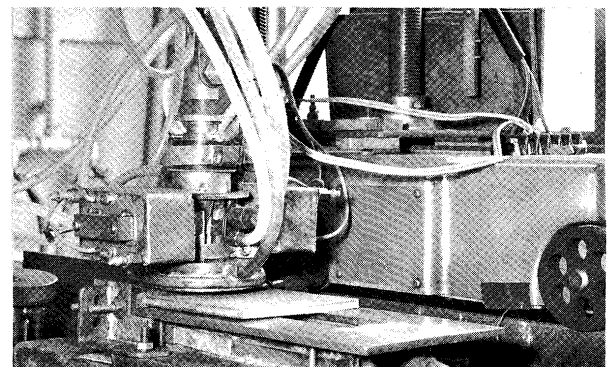
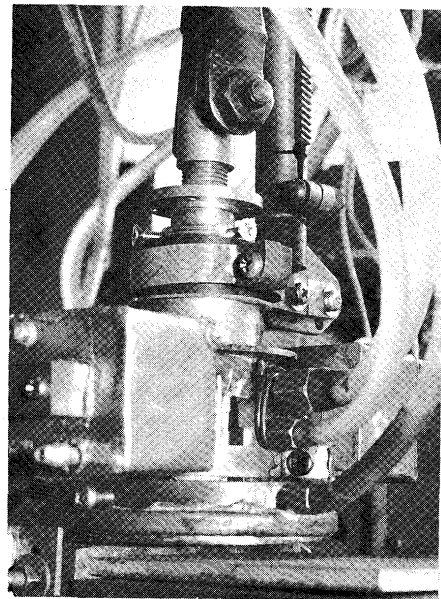

Photo. 1 Experimental equipment for magnetic control of plasma arc.

so as to maintain highly a compressive component of magnetic flux over an wide range as can as possible, and one or three soft iron pieces were inserted into the air gap region.

Figure 2 illustrates the method how to assembly the electromagnet. All of the core and pole piece of electromagnet are made of soft iron available commercially. Pole pieces are covered with copper plate and water-cooled to protect them from a thermal damage of plasma arc. Iron cores, coils and pole pieces were fastened together, and suitably attached to the brass cylinder in which plasma torch was installed coaxially.

(2) Plasma welding equipments

Plasma torch used in this study was designed in our laboratory, and is of similar structure to a conventional plasma torch. Rating capacity of out put of the torch was approximately 10 KW. The torch was installed in the cylindrical magnet holder with a rubber tube so as to insulate them from each other. Two kinds of orifices were employed in this experiment;

one was of 4 mm in diameter used for the observation of plasma arc in the magnetic field, another was 3 mm used for the welding experiment.

Arc current was changed over a range from 100 A to 200 A. Argon was used for plasma working gas through the whole experiments and its flow rate tested was in a range from 2 l/min to 8 l/min. In the welding tests, auxiliary shielding cover was equipped outside the electromagnet holder, and workpiece is protected with a little amount of argon flows. The plasma arc torch and electromagnet were fixed to the arms on a carriage and traversed above the workpiece. The power supply used was a conventional 500A DC arc welder of constant current type. Arrangements of the plasma torch and magnet were shown in Fig. 3 and Photo. 1.

(3) Material

The material used in this investigation was 304 type stainless steel plate, which was selected because of its non-magnetic property.

3. Experimental Results and Discussion

(1) Magnetic fields made by different pole pieces

Cusp magnetic fields made by different pole pieces were measured using Gaussmeter with transverse Hall probe. Probe was mounted on a support and could be moved vertically and horizontally with fine adjustment screw.

As described previously, pole piece of type (a) is the most simplest one, and type (c) is complicated multi-gap typed. Distributions of magnetic flux density when (a) or (c) types of pole piece were installed are as shown in Fig. 4 and Fig. 5, where  $B_x$  and  $B_y$  show the components of magnetic flux density in the direction of X axis and Y axis respectively.

As is obvious from these results, when the multi-gap pole piece was employed, magnetic field strength along the X axis,  $B_x$ , could be maintained at relatively high level over an wide range of 10 mm or more. When the pole piece of type (a) was used, it is

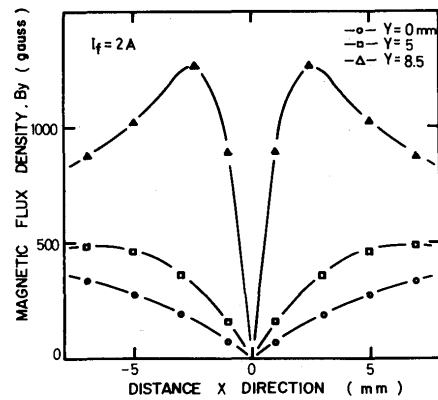
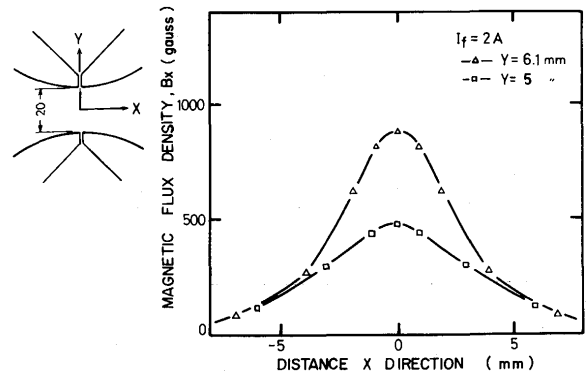

Fig. 4. Distribution of magnetic field strength made by single-gapped pole piece.

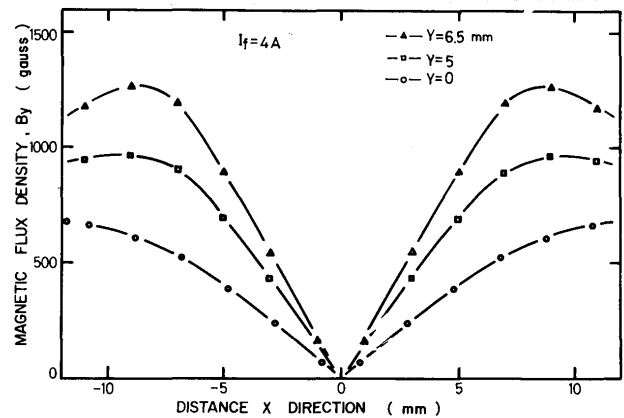
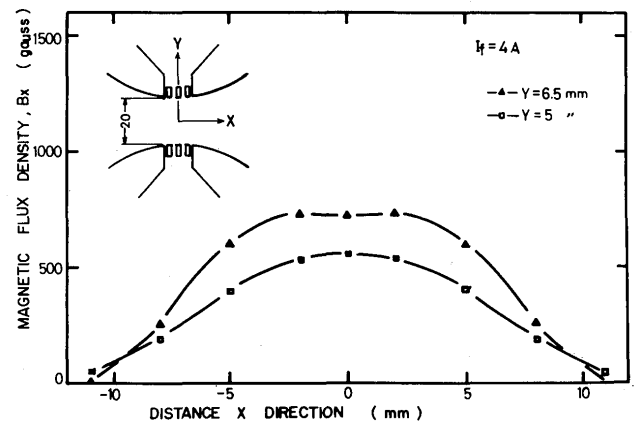

Fig. 5. Distribution of magnetic field strength made by multi-gapped pole piece.

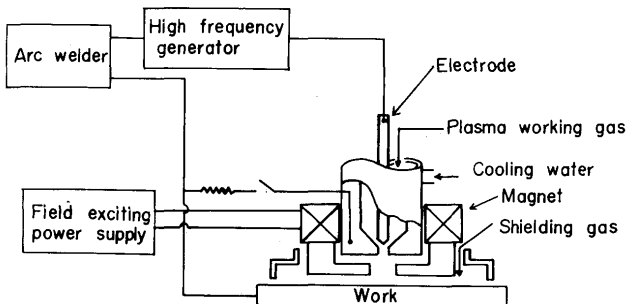

Fig. 3. Experimental equipments for the magnetic control of plasma arc.

difficult to find such a plateau on a curve of  $B_x$  as obtained for the multi-gap typed.

As for the magnitude of flux density in these cases, it is, of course, adjustable by controlling coil current. Magnetic field strength for a particular coil current with the single-gap pole piece is, in general, somewhat higher than that of multi-gap typed, but these trend can be understood easily, since field strength near by the air gap of pole piece varies inversely as its length for a particular magnetic motive force.

In the magnetic control of welding arc by applying the cusp magnetic field, field component  $B_x$ , if its direction was selected suitably according with Ampere's law, has an effect to constrict the arc from both sides towards the central portion. Then  $B_y$  component interacts with arc current so as to stretch the arc column in the direction of X axis.

For the purpose to enhance the magnetic constriction it is requested not only to increase the  $B_x$  component but also to maintain it over an whole arcing zone. Furthermore, as can be seen from figures, when the multi-gapped pole piece was employed  $B_x$  component at the central area is not so strong as observed in single gapped one. Component  $B_y$  increases with the distance from the center, but its rate of increase is fairly low compared with those of single gapped one. As an whole result, it seemed adequate to use a multi-gapped pole piece in order to develop the feasibility of magnetic control of plasma arc.

Strength of magnetic field is hereinafter represented as the magnitude of field coil current, because cusp field strength is not uniform at an arcing zone. Field strength is, however, not proportional exactly to the coil current exceeds 5 A, due to magnetic saturation of pole pieces.

(2) Magnetic control of plasma arc

2-1 Appearance of plasma arc in the cusp field

Typical deformations of plasma arc in a various strength of cusp type magnetic field are given in **Photo. 2**, each picture of which was taken at the same moment from the both direction along the X axis and Y axis respectively. It will be found easily that the plasma arc column was constricted from both sides and expanded to some extent in a perpendicular direction.

Although these deformations are not so extensive as observed in case of TIG arc, it should be noted that the plasma arc, which was concentrated already by the constricting nozzle and/or flow of working gas, could be further constricted by applying the cusp magnetic field.

The changes which took place in the diameter of plasma arc column with varying magnetic field are

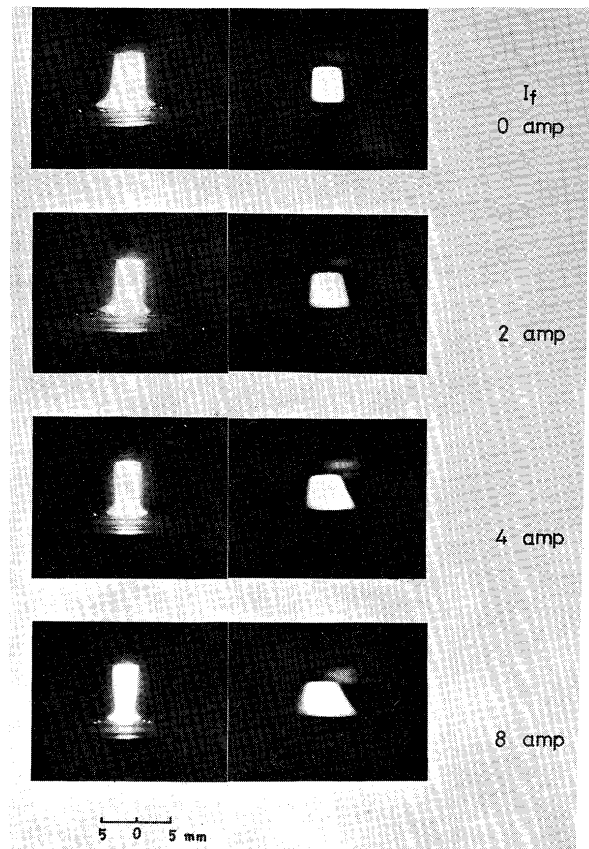

Photo. 2. Appearances of plasma arc in the various strengthes of cusp magnetic field. Arc current 150 A, Argon flow rate 4 l/min, Nozzle diam. 4 mm.

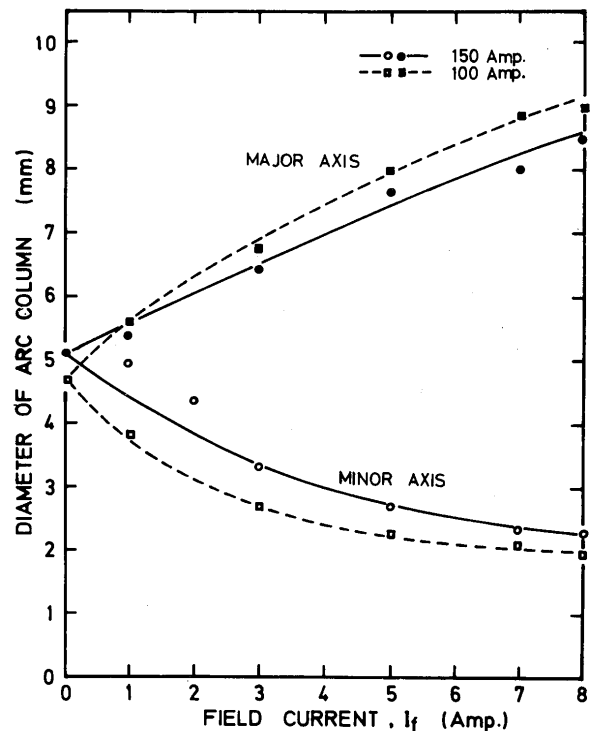

Fig. 6. Change in dimension of plasma arc column in a various strength of cusp magnetic field. Nozzle diam. : 4 mm, Arc length : 10 mm, Argon flow rate: 4 l/min.

shown in Fig. 6. In this case, actual diameter of plasma column was assumed approximately as a half-value width of lateral intensity distribution obtained in a microphotometry of photographic film. Errors due to this approximation is seemed less than 20 %.

In a compressive direction, plasma arc diminished its diameter as the magnetic field becomes stronger, and reached to the one half or less of initial diameter. At the same time, plasma arc expands along the tensile direction, but its rate of increase is, in general, not so large as compared with the rate of decrease in minor axis.

It may be possible to consider that the plasma deforms its cross-section into a elliptical one when the cusp field is applied. As mentioned later, shape of melted area of the workpiece may be understood well if arc current flows into the workpiece through the elliptical column. These facts indicate that the cross-sectional area of the plasma arc decreases under the influence of cusp magnetic field.

2-2 Variation of arc voltage and heat delivered to the works

Figure 7 shows an example of the variation of arc voltage for the plasma arc with field strength. The change in arc voltage was not so severe as appeared in case of TIG arc. It may be accounted for this matter that the plasma arc column subjected to the magnetic constriction is limited at relatively small portion outside the torch. Accordingly arc voltage had not so increased even if the potential gradient in the column outside the torch was increased by an application of magnetic field.

Calorimetric measurement of heat delivered to the works from the plasma arc in a different strength of magnetic field was also carried out with the results as

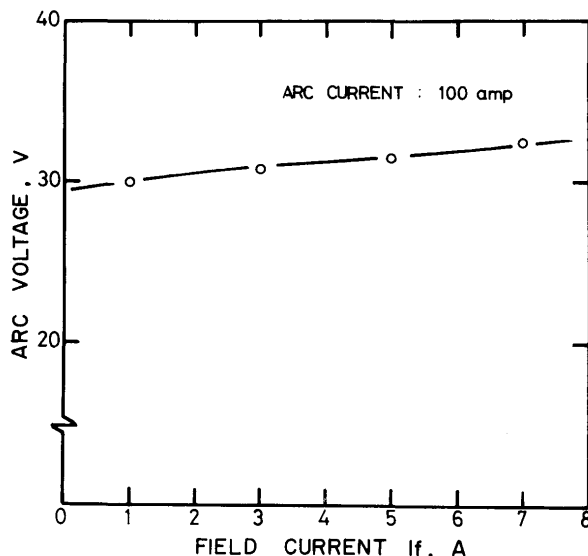

Fig. 7. Effect of field strength on arc voltage.

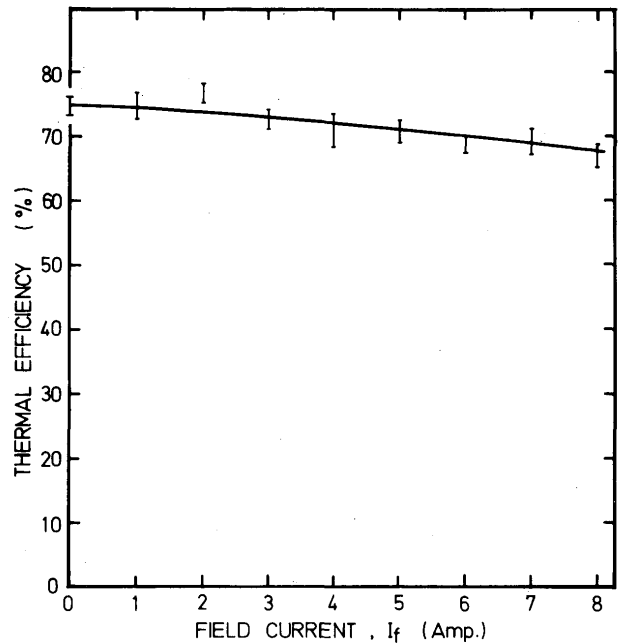

Fig. 8. Thermal efficiency of magnetized plasma arc. 150 A, 4 l/min, Nozzle diam. 7 mm, Arc length 10 mm.

shown in Fig. 8. It was found that the thermal efficiency (ratio of heat delivered to the works against the electrical input) has a tendency to fall slightly with the magnetic field. This fall may be arisen from a little amount of dispersion of plasma flame in a direction of its major axis, but is so small that can be ignored.

(3) Welding by the magnetically controlled plasma arc

3-1 Welding procedure

In an ordinary plasma welding, key-hole method is widely used for medium thick materials. Prior to set forward the application of magnetically controlled plasma arc, preliminary trial was carried out in order to know whether key-hole technique is possible to use or not, and its result was satisfactory.

Various investigations were made successively and its major aim was to obtain satisfactory weld bead at each plasma working gas flow rate and travel speed under the influence of cusp magnetic field. Most the welds were of bead on plate type, made on the austenitic stainless steel plate. For each combination of arc current and plasma gas flow rate, increasing travel speed were tested in succession. Flat butt welding the same material was carried out with a set of adequate parameters determined in above bead on plate type trial. Distance between the torch and works were maintained at around 6 mm.

In all the cases, the cusp magnetic field brought about the arcing zone was such as to compress the plasma arc column in the direction being perpendicular to that of traveling. Accordingly major axis of cross

section of plasma arc coincide with the seam, in case of practical welding.

3-2 Appearance of weld beads

Typical appearances of welds made with an application of cusp magnetic field are shown in **Photo. 3**. Although weld made without any magnetic field was accompanied with undercut on one side possibly due to unsymmetrical stream of plasma. Similar trend would be frequently observed more or less in an ordinary plasma welding. Weld beads made with the cusp magnetic field had a smooth surface and is free from undercut. This fact may suggest that the weld metal solidifies evenly and continuously during the welding. The other weld bead without a magnetic field seems to have been solidified in somewhat irregular manner.

It may firstly be concluded that the bead appearance was improved extensively by virtue of application of cusp field, and difficulties such as formation of undercut could be eliminated to a great extent.

As can be seen from **Photo. 4**, it can also be pointed out that the width of weld beads made with cusp magnetic field are apparently narrower than that of non-magnetic field. Typical change in top bead width in accordance with the strength of magnetic field is given in **Fig. 9**. This effect was very obvious for all cases, as represented in **Photo. 5**. Width of weld beads will vary naturally depending upon the heat input per unit length of welds. **Figure 10** shows the top bead width under different level of heat input. At any level of heat input bead width was found to be reduced by two-thirds of conventional one as an effect of cusp magnetic field.

As for the bottom bead width, it was not appreciably altered by the cusp magnetic field as can be seen **Fig. 11**. It may, however, be found out from **Photo. 3** that weld metal was drooping deeply from the back of plate whenever no magnetic field was applied.

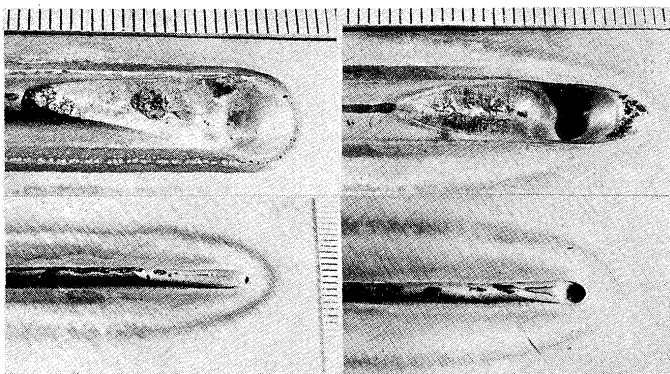

Photo. 3. Bead appearances of the welds on type 304 stainless steel plate, 6 mm in thickness. The left weld was made without external magnetic field, 150 A, 32 V, 21 cm/min, 5.5 l/min, and right one was made with a cusp magnetic field,  $I_f$  5 A, 150 A, 34 V, 21 cm/min, 5.5 l/min.

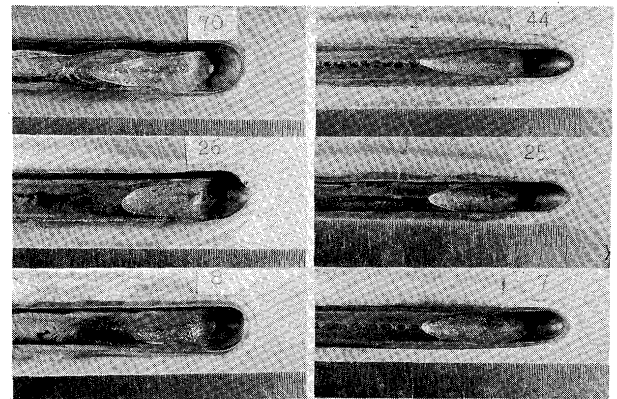

Photo. 4. Bead appearances of the welds made at different traveling speeds. Arc current 150 A, Argon flow rate 5.5 l/min. The left welds were made without magnetic field and the right were with cusp magnetic field,  $I_f$  5 A. Traveling speeds were 24 cm/min (top beads), 20 cm/min (middle) and 18 cm/min (bottom) respectively.

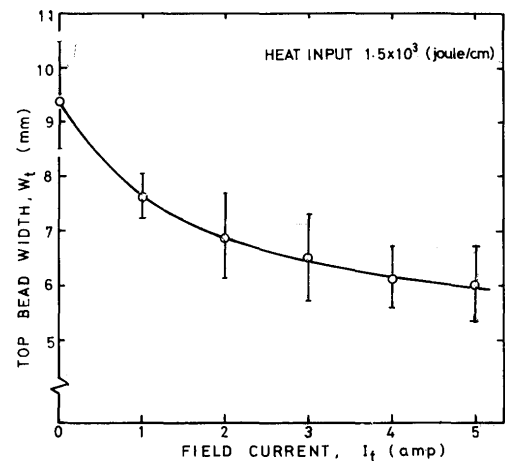

Fig. 9. Effect of magnetic field on the top bead width made on stainless steel plate, 6 mm. 150 A, 5.5 l/min.

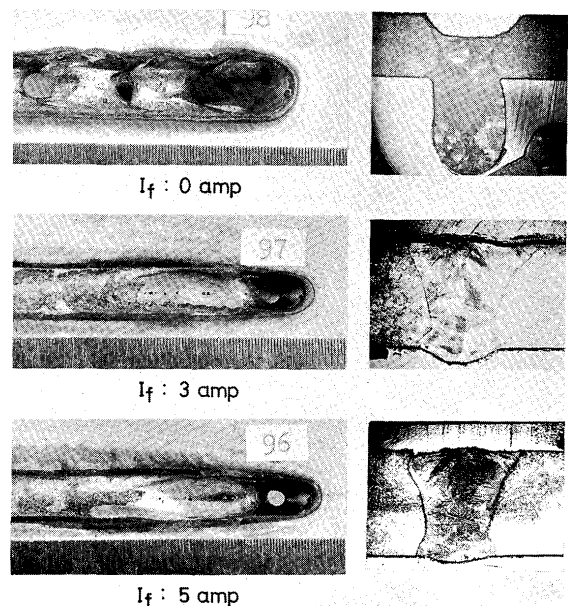

Photo. 5. Change in bead appearance and cross section of welds with applied magnetic field. 160 A, 46 V, 8 l/min and 26 cm/min.

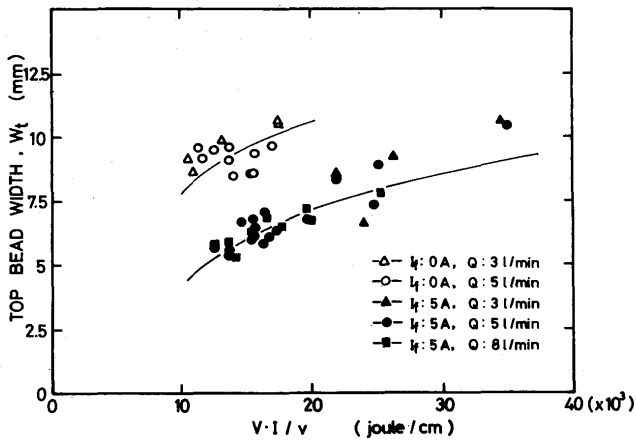

Fig. 10. Change in top bead width made at various heat input per unit length of welds. Arc current: 150 A.

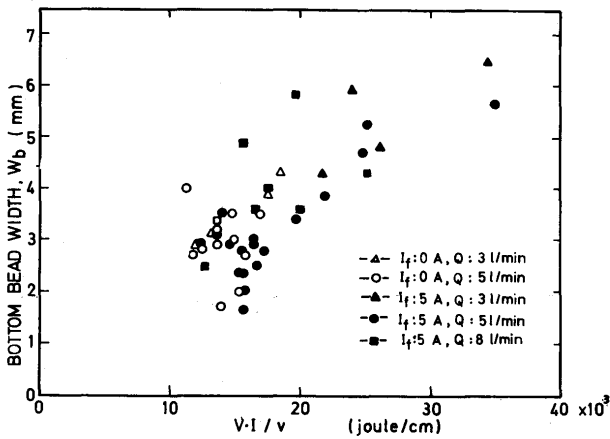

Fig. 11. Change in bottom bead width made with various heat input per unit length of welds. Arc current: 150 A.

### 3-3 Feasible range of welding conditions

In a plasma welding, welding parameters which could be applied to produce satisfactory welds had to be determined carefully. At a particular arc current and working gas flow rate, for example, if travel speed is set too much higher, insufficiently penetrated weld beads will be resulted. If working gas flow rate exceeds certain magnitude, molten metal will in some cases be thrown out of the bead producing gouge, or discontinuous weld beads will appear, as shown in the top of **Photo. 5**.

As can be seen from the change of bead appearance and its cross section of **Photo. 5**, normal weld bead can be obtained by the application of cusp field even at relatively higher working gas flow rate with which burn through weld bead should be formed whenever no magnetic field is applied.

As described previously, weld bead width decreases with a magnetic field. One of reasons why drooping of weld metal disappear by an application of

magnetic field may be considered as the effective increase of surface tension of weld metal at the bottom of plate due to the reduction in bead width, but the bottom bead width was found to increase rather than to be remained unchanged. Other possible reasons may be considered as the fall of temperature of molten metal and also as the reduction of stagnation pressure of plasma stream during the welding. Both of them are considered to be affected strongly by the change of current distribution inside the column due to the magnetic restriction.

The feasible range of available data regarding travel speed and working gas flow rate for a particular plasma current should be reevaluated with a magnetic field. **Figure 12** is an example of feasible ranges of welding conditions for stainless steel plate, 6 mm thickness, obtained in this experiment. It may easily be understood that the extremely wide range of welding conditions is available in the magnetically controlled plasma arc welding. This is to be regarded as a prominent advantage in practical uses.

### 3-4 Variation of Keyhole

The difference in Keyhole or crater at the end of bead was one of the major differences observed between both welds with and without application of magnetic field. So far as observed in present study, the shape of crater converted to the elliptical puddle mode from a tear drop shaped one by an application of magnetic field as shown in **Photo. 4** and **Photo. 5**. Slope of front surface of the keyhole became more gentle as the magnetic field became strong. Molten metal was, however, always swept away completely towards the rear portion of crater so as to form

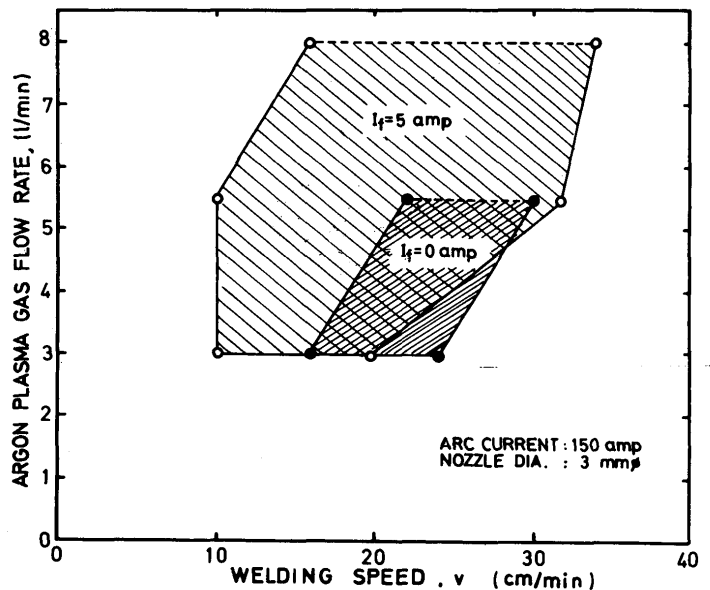

Fig. 12. Feasible range of welding operation for both plasma arc welding procedures.



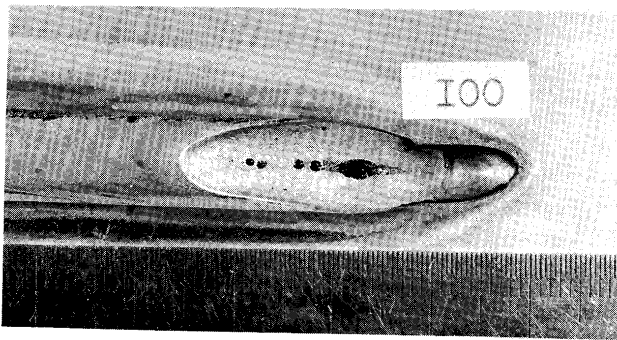

Photo. 6. Bead appearance made at relatively low gas flow rate and low traveling speed with cusp magnetic field. Ir 5 A, 160 A, 36 V, 3 l/min and 14 cm/min.

a puddle, in a similar manner as observed in conventional keyhole process.

**Photograph 6** was given so as to indicate clearly the shape of crater when the cusp magnetic field was used. This weld was made at relatively low traveling speed and with low flow rate of plasma working gas. As can be seen from picture, width of kerf made by key-hole action at the front side is not so broad, and resultant bead width was decided at the rear portion of weld puddle. This expansion of weld puddle can not be understood to be arisen only from the convective flow of molten metal in a weld pool. It may be possible to explain this phenomena assuming that there must be exist some welding heat sources on this weld pool, since arc current is flowing through the oval cross section of plasma column when the magnetic field is applied. Distribution of arc current during the welding in a cusp magnetic field was not determined yet owing to experimental difficulties.

### 3-5 Solid-Liquid interfaces during the welding

For the purpose to make clear the differences between both weld beads made with or without cusp magnetic field, decanting method was employed. Molten metals in the crater were removed by impinging heavy weighted hammer at the end of plate so as to rotate the workpiece quickly around the pin hinged axis fixed at the other end.

**Photograph 7** shows the appearances of welds after molten metal was removed. Quite little quantities of metal were left on its surface, but they were easily distinguished from the metal already solidified. The weld crater made with magnetic field is longer than another without magnetic field, and is narrower as similary as observed previously.

It should be noted that the long tailed crater was hardly observed on the back of bead when the magnetic field was applied. This fact proves that molten metal at the bottom of keyhole does not flows backwards so extensively if magnetic field was applied.

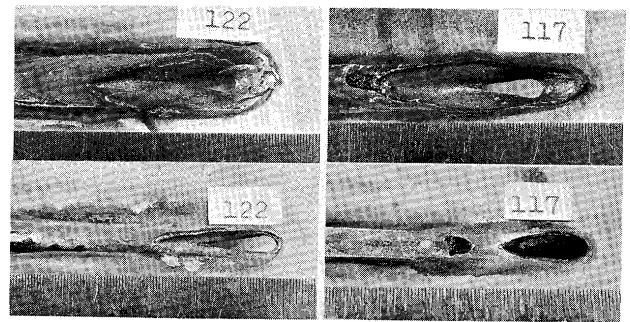

Photo. 7. Change in appearance of Solid-Liquid interface during plasma arc welding, 160 A, 5.5 l/min and 20 cm/min. The left bead was made without manetic field and right was with cusp magnetic field, Ir 3 A.

Shape and size of these solid-liquid interface were precisely measured. Longitudinal and transverse cross section are as shown in **Fig. 13**. **Figure 14** is stereographic illustrations of both solid-liquid interfaces during the welding. Macrophotographs of longitudinal cross section of weld bead made with different strength of magnetic field are as shown in **Photo. 8**.

These results suggest that the controlling the current distribution has also significant effect upon the flow of molten metal, which was believed previously to being affected strongly by the plasma stream only.

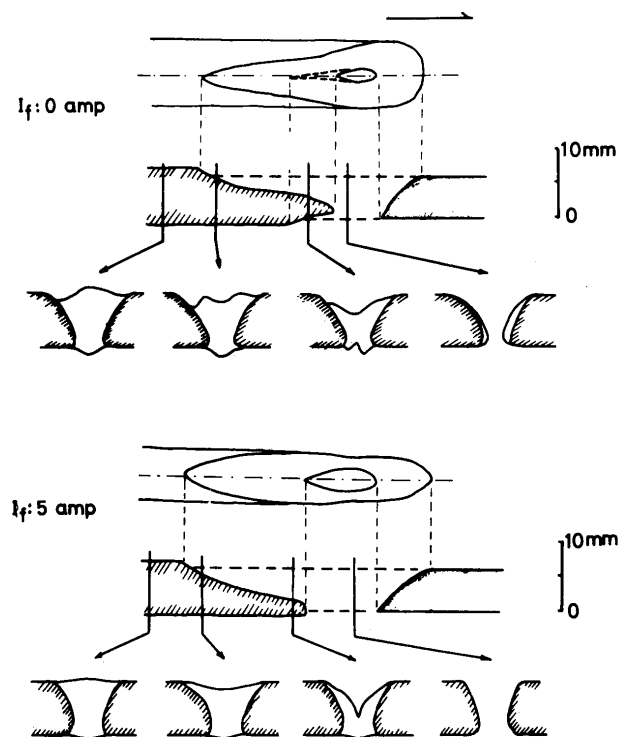

Fig. 13. Comparison of solid-liquid interface for both plasma arc welding methods. Arc current 150 A, Argon flow rate 5.5 l/min, Travelling velocity 22 cm/min.

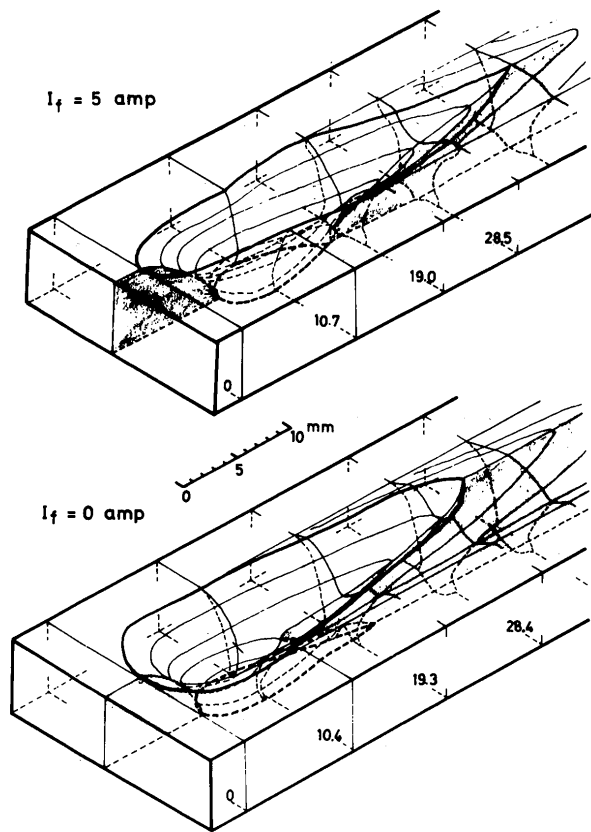

Fig. 14. Stereographic illustration of solid-liquid interfaces during both plasma arc weldings. Arc current 160 A, Argon flow rate 5.5 l/min, Traveling velocity 28 cm/min.

#### 4. Conclusions

Experimental results obtained in this study are summarized as follows.

- (1) Plasma arc column changes its appearance by the application of cusp magnetic field. Its cross section varied to elliptical in a similar manner as observed in TIG arc.
- (2) Multi-gapped pole piece was developed in order to enhance the magnetic constriction of plasma arc.
- (3) Arc voltage of plasma arc increases as the magnetic field becomes stronger, but the ratio of heat delivered to the works against the electrical input decreases slightly.
- (4) Keyhole method was found feasible to weld stainless steel plate with applied cusp magnetic field.
- (5) Various effects of magnetic field on the weld beads were investigated. By virtue of cusp magnetic field, difficulties such as formation of undercut could be eliminated to a great extent.
- (6) Bead width became narrower as the magnetic field became stronger.
- (7) Variation in the shape and size of weld crater was made clear. Solid-liquid interface was also investigated.

#### References

- 1) G. K. Hicken and C. E. Jackson, "The Effect of Applied Magnetic Field on Welding Arc", *Welding Journal*, Nov. 515s-524s (1966).
- 2) I. A. Bachelis, "Magnetic Control of a Welding Arc" *Svar. Proiz. (Russian)* No. 1 17-19 (1965) Trans. BWRA.
- 3) I. M. Kovalev, "Deflection of a Welding Arc in a Transverse Magnetic Field", *Svar. Proiz. (Russian)* No. 10 4-6 (1965) Trans. BWRA.
- 4) A. I. Akulov L. K. Martinson and I. M. Kovalev, "The Deflection of Arc in Transverse Magnetic Field", *Svar. Proiz. (Russian)* No. 11 43-45 (1969) Trans. BWRA.
- 5) Serdyuk, G. B. and Kornienko, A. N., "The Welding Arc in an Alternating Transverse Magnetic Field", *Automatic Welding*, 16 (10), 7 to 13 (1963).
- 6) Y. Arata and H. Maruo, "Magnetic Control of Arc Plasma and Its Application for Welding", I.I.W. Document IV-53-71 (1971).

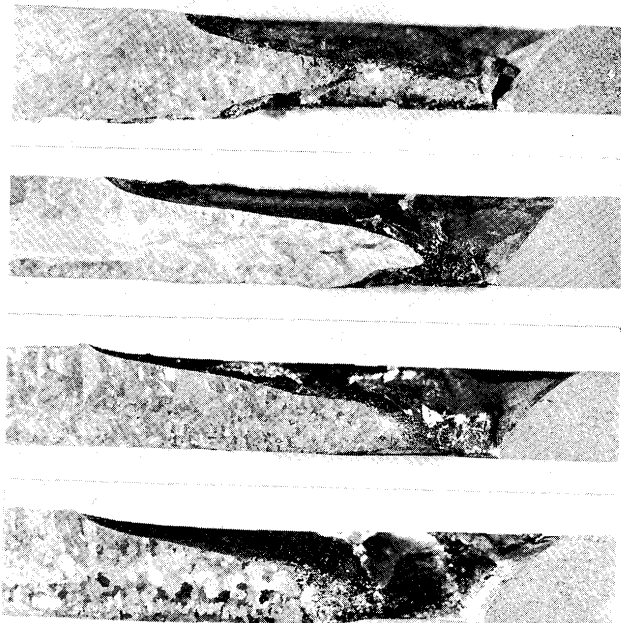

Photo. 8. Change in longitudinal cross section of bead welds after molten metal was removed. 160 A, 40 V, 5.5 l/min and 20 cm/min.

Top bead	:	No magnetic field applied
Middle upper bead	:	Cusp magnetic field, $I_f$ 1 A
Middle lower bead	:	" " 3 A
Bottom bead	:	" " 5 A