

Magnetic surface states on Ni(100)

E. W. Plummer and W. Eberhardt

*Department of Physics and Laboratory for Research on the Structure of Matter,
University of Pennsylvania, Philadelphia, Pennsylvania 19104*

(Received 9 February 1979)

Angle-resolved photoelectron spectra, utilizing polarized synchrotron radiation, from Ni(100) reveal a narrow surface-sensitive peak at the Fermi energy. This structure exists near the surface-Brillouin-zone edges in both the [10] and [11] directions. The symmetry of this state is odd (even) with respect to the (100) [(110)] mirror plane. Projections of the bulk bands onto the surface Brillouin zone show that these surface-sensitive energy levels exist in regions of the surface Brillouin zone where there are gaps in only one spin band. The very narrow energy width of these states indicates that they are surface states and consequently magnetic.

I. INTRODUCTION

The history of surface states or resonances on metal surfaces is brief. The first observation of a metallic surface state was by Swanson and Crouser in a field-emission energy distribution from W(100) in 1966.¹ They interpreted the structure in their spectra as due to the bulk band structure. It was not until 1970 that these measurements were redone and interpreted as a surface state in a spin-orbit gap in W.² The claim that the structure observed in the field-emission spectrum was due to a surface state was based upon the extreme sensitivity of this feature to surface contamination.³

The theoretical concept of surface states on metals was introduced in a paper by Pendry and Forstmann⁴ in 1970. They showed that surface states can exist in the hybridization gap of the *s* and *d* bands of *d*-band metals, like Ni and Cu. The important observation in this paper was that surface states can exist in partial gaps (gaps which are of a given symmetry and may exist in only specific portions of the surface Brillouin zone). This theoretical paper furnished the impetus for the experimental interpretation of the W(100) data.²

Many new metallic surface states have been documented experimentally since the early field-emission observations on W(100). Most of these observations were made using photoelectron spectroscopy (primarily angle resolved). Three surface-state bands are now known to exist on W(100) and Mo(100).⁵ The original interpretation of a surface state in the spin-orbit gap has been proven incorrect by photoemission symmetry measurements,⁵ but all three surface-state bands now seem to be theoretically understood.^{6,7} A surface state has been found in the neck of Cu, Ag, and Au on the (111) face.⁸ Theory reproduces the experimental observations.⁹ Also the experimental¹⁰ and theoretical¹¹ results for the surface state on

Al(100) are in excellent agreement. Himpsel and Eastman recently reported the existence of a non-magnetic Λ_1 -symmetry surface state on the (111) face of Ni.¹² We report in this paper evidence for surface states on Ni(100), which exist near the surface-Brillouin-zone (SBZ) edges at the Fermi energy. Their symmetry is such that if they are surface states they must be magnetic.

The observation of magnetic surface states on the (100) face of Ni near the Fermi energy has special importance due to the photoelectron spin-polarization reversal observed near threshold on Ni(100).¹³ Eib and Alvarado¹³ found that the polarization of photoemitted electrons from Ni(100) was negative at threshold but changed sign 0.1 eV above threshold.¹³ Dempsey, Grise, and Kleinman¹⁴ have proposed that this effect can be explained by the presence of a surface state in the majority bands slightly below the Fermi energy located in the center of the surface Brillouin zone. Himpsel *et al.*¹⁵ argue from their determination of the exchange splitting in Ni that one does not need a surface state to explain the spin polarization, because the majority spin gap at the Γ point of the surface Brillouin zone (SBZ) is ~ 0.1 eV. A recent spin-polarized photoemission calculation for Ni(100) by Moore and Pendry¹⁶ shows good agreement with the experiment of Eib and Alvarado.¹³ In this calculation the exchange splitting is taken to be 0.33 eV,¹⁵ and there is no surface-state contribution.

This paper is organized into the following sections. Section II will describe the experimental procedure used in this work. Section III presents the data and interpretation for the observed structure in the angle-resolved photoelectron spectra which satisfy all of the criteria we establish for identifying surface states. We require: (i) The structure in the photoelectron energy distribution be sensitive to the surface conditions (perfection and cleanliness); (ii) The structure at a fixed value of parallel momentum (with

respect to surface) have no dispersion as the perpendicular component of the momentum is changed; and (iii) The energy and parallel momentum of the structure be such that it lies within a gap of the bulk band structure projected onto the surface Brillouin zone.

Section IV will discuss structure observed in the photoelectron spectra which is surface sensitive but can not be attributed to a surface state because all of the above tests are not satisfied.

II. EXPERIMENTAL PROCEDURE

All of these measurements were made at the 240 MeV storage ring at the Synchrotron Radiation Center of the Physical Sciences Laboratory of the University of Wisconsin, using an angle-resolved detector.¹⁷ The radiation from the storage ring is dispersed by a monochromator. During these measurements we used two monochromators, a 1-m vertically mounted Seya-Namioka and a grazing incidence grasshopper.¹⁸ The photoelectron spectra were measured using a 180° spherical energy analyzer with an angular acceptance of $\pm 2.5^\circ$ and complete freedom to be moved to any collection angle.¹⁷ The total resolution of the monochromator and analyzer was normally maintained at 0.3–0.4 eV, but could be improved with subsequent loss of signal.

Figure 1 shows schematically the angular variables at our disposal in this experiment. All angles refer to Cartesian coordinates where the z axis is perpendicular to the surface and the y axis is along the surface component of the vector potential \vec{A} of the incident light. θ_I is the angle of incidence of the incident light. We obtain s -polarized light when $\theta_I = 0^\circ$. $\vec{A}_{||}$ denotes the direction of the surface component of the polarization vector \vec{A} with respect to crystal axes. For example in this experiment $A_{||}[10]$ means that the [10] direction in the Ni(100) surface is along the y axis and in the plane of polarization. The collection angles are denoted by θ and ϕ . θ measures the angle with respect to the surface normal and ϕ denotes the azimuthal angle with respect to the normal to the plane of incidence. Our notation is that $\phi = 270^\circ$ is back towards the incident light direction in the plane of incidence.

Much of the analysis we present will be based upon simple symmetry selection rules utilizing the polarization of the light.¹⁹ These rules can be easily understood from the photoemission matrix element

$$P_{if} \propto \langle \psi_f | \vec{A} \cdot \vec{P} | \psi_i \rangle, \quad (1)$$

where ψ_i and ψ_f are the initial and final states of the system and \vec{P} is the momentum operator. If we always collect the outgoing electron in a mirror plane, then only even final states can contribute to the detected current, since an odd final wave function is

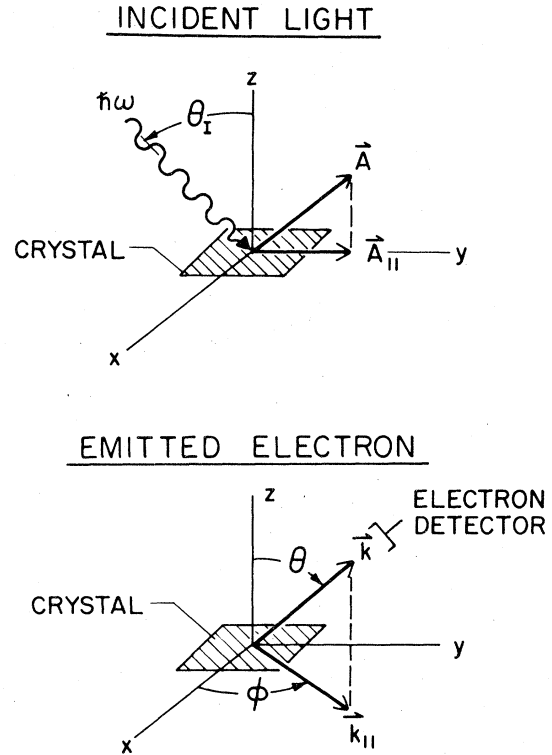

FIG. 1. Schematic drawing of the geometry of the angle-resolved photoemission measurements.

0 in the mirror plane. The whole matrix element must be even under reflection about the mirror plane. The dipole operator $\vec{A} \cdot \vec{P}$ is even (odd) if A is parallel (perpendicular) to the collection mirror plane. Therefore only even (odd) initial states can be observed. For example if we use p -polarized light ($\theta_I \neq 0^\circ$) with $A_{||}$ in a mirror plane then any measurement in the plane of incidence ($\phi = 90^\circ$ or 270°) looks only at even initial states. In contrast if $A_{||}$ is perpendicular to the mirror plane of collection ($\phi = 0^\circ$ or 180°) we will see both even and odd initial states. In this geometry $\vec{A}_{||} \cdot \vec{P}$ is odd with respect to the mirror plane so it couples odd initial states to the even final state. $\vec{A}_\perp \cdot \vec{P}$ is even and excites even initial states.

Figure 2 shows characteristic spectra from Ni(100) which illustrates the salient features that will be discussed in Secs. III and IV. The curves on the left were recorded at a collection angle of 30° along the [11] surface direction ([110] direction in the bulk) using s -polarized light. The top curve is for a collection parallel to \vec{A} , i.e., only initial states even with respect to the [11] mirror plane, are observed. The bottom set of curves are also for collection in the [11] mirror plane, but perpendicular to the mirror plane of the polarization, i.e., only odd initial states

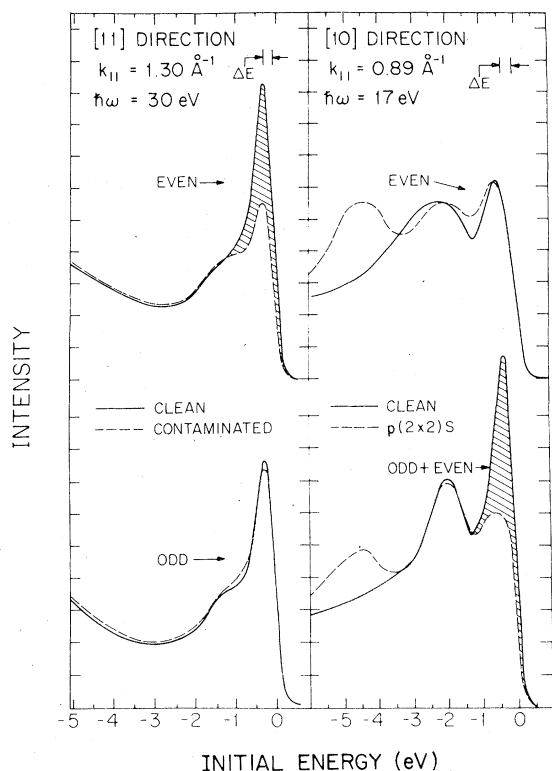

FIG. 2. Angle-resolved photoelectron spectra from Ni(100). The spectra on the left are taken at $\hbar\omega = 30$ eV using *s*-polarized light [$\theta_I = 0^\circ$]. The collection angle is $\theta = 30^\circ$ [$k_{\parallel} = 1.30 \text{ \AA}^{-1}$]. \vec{A} is always in [11] direction. The curves marked odd (even) are for collection perpendicular (parallel) to a \vec{A} . The spectra on the right are in the [10] direction for $\hbar\omega = 17$ eV, $\theta = 30^\circ$ [$k_{\parallel} = 0.89 \text{ \AA}^{-1}$] and *p*-polarized light [$\theta_I = 45^\circ$]. The curves marked "even" are for a collection geometry in the plane of incidence ($\varphi = 90^\circ$). The "odd plus even" denotes collection perpendicular to the plane of incidence.

are observed. The shaded region shows the signal which is lost upon adsorption of air. At this k_{\parallel} there is a surface-sensitive peak which has even symmetry. The right-hand side curves show that along the [10] direction ([100] direction in the bulk) there is a surface-sensitive peak at the Fermi energy which has odd symmetry. In these curves $p(2 \times 2)S$ is used to "contaminate" the surface. We have used chemisorbed adsorbates in this study. The surface sensitivity seems to be independent of the chemical identity or degree of order of the adsorbate.

The energy position of the surface-sensitive peaks shown in Fig. 2 is ~ 0.25 eV below the Fermi energy, where the Fermi energy is defined as the 50% point of the leading edge. The resolution is proportional to the energy difference between the 10 and 90% points of this edge. This ΔE is ~ 0.35 eV for the spectra of

Fig. 2. The measured full width at half maximum (FWHM) of the surface-sensitive peaks is ~ 0.4 eV. When the system resolution ΔE is decreased both the energy position and width of the surface-sensitive peak decrease. For a $\Delta E \approx 0.15$ eV the peak position is ~ 0.17 eV with a width of 0.25 eV. Extrapolating to $\Delta E = 0$ gives an energy position of 0.05 ± 0.05 eV. The inherent width of the peaks is 0.17 ± 0.03 eV.

There are several examples in the literature showing that the energy position depends upon the resolution. Heimann and Neddermeyer²⁰ and Page *et al.*²¹ have published spectra of Ni(100) and evaporated Ni, respectively, which are very similar to ours shown in Fig. 2. They point out that the narrow peak near the Fermi energy is probably a surface state. Heimann and Neddermeyer²⁰ quote a resolution of 0.06 eV and a peak position of 0.15 eV below the Fermi energy. Page *et al.*²¹ with an effective resolution of ~ 0.2 eV quote a position for the surface peak of ~ 0.3 eV, i.e., the apparent binding energy depends upon the resolution.

III. EXPERIMENTAL RESULTS AND INTERPRETATION

The three tests employed to decide if a given peak in a photoelectron spectrum is due to a surface state were briefly discussed in the Introduction. Here we will elaborate on the meaning of each test and the implementation of the test.

(i) *Surface sensitivity.* This is historically the only test used to observe surface states in a field-emission spectrum.² The concept is that the existence of an intrinsic surface state is sensitive to the surface potential. This potential can be changed by adsorbing foreign atoms or molecules or by disordering the surface. There is no proof that every adsorbate should remove a specific surface state. We already know that an ordered overlayer of Au on W(100) does not remove the surface state on this face.²² Therefore the surface-sensitivity test should be performed with several different adsorbates, preferably with different degrees of order.

(ii) *Two dimensionality of state.* This test is used to show that the specific state does not have a dispersion in energy with respect to the perpendicular component of momentum (k_{\perp}). This is accomplished in an angle-resolved photoemission experiment by sweeping the photon energy keeping k_{\parallel} fixed. If the measured binding energy of the peak in question is independent of $\hbar\omega$ then there is no dispersion with k_{\perp} . Direct interband transitions can be ruled out by comparison with the bulk band structure.

(iii) *Projection of bulk band structure.* Any structure in a photoelectron spectrum which passes both of the above tests can be characterized as due to surface photoemission, i.e., a surface state or resonance. A

surface-sensitive peak is not due to surface state unless it lies in a gap in the projection of the bulk band structure onto the surface Brillouin zone. The odd and even parity components of the bulk bands must be separately projected onto the SBZ along the symmetry directions of the crystal face. For ferromagnetic Ni the majority and minority spin bands must also be separately projected onto the SBZ. This section describes the results of applying the tests discussed above to the surface-sensitive structures shown in Fig. 2 as a function of k_{\perp} . We will show that the logical conclusion of this procedure is that we are observing surface states in gaps in specific spin bands of Ni, i.e., magnetic surface states. Section IV will discuss other possible explanations as well as propose experiments to test our model.

Tests No. (i) and No. (ii) must be carried out simultaneously in an angle-resolved photoelectron experiment. The surface sensitivity and parity of a specific peak in the photoelectron spectra are determined for a given value of parallel momentum by conducting experiments like those shown in Fig. 2. These experiments must be repeated for a wide range of $\hbar\omega$ values keeping k_{\parallel} fixed to satisfy the second test. The value of k_{\parallel} is changed and the complete procedure is repeated. Using this procedure the regions of k_{\parallel} space in the surface Brillouin zone can be identified where a specific parity surface-sensitive peak exists which satisfies test No. (ii).

We have attempted to map out the regions of k_{\parallel} along the two symmetry directions of the Ni(100) surface where surface-sensitive peaks exist which also satisfy test No. (ii). This is especially difficult for the states shown in Fig. 2, since they lie at or near the Fermi energy. This is the energy region in Ni where there exists very intense bulk transitions.^{12,15} Note in Fig. 2 that the energy distributions after adsorption or in the symmetry direction where there is little surface sensitivity still exhibit a peak at the energy position of the proposed surface state. This non-surface-sensitive peak in general also satisfies test No. (ii), it does not disperse with changing k_{\perp} .

Almost all other surface states which have been experimentally documented have been states which exist at an energy and momentum where the bulk background emission is very innocuous. The noble-metal surface states are in the neck in the [111] direction. The Al(100) surface state appears in the gap at the X point in the bulk zone and the background emission is smooth and weak, even if it is not understood. Even the surface states on W(100) and Mo(100) appear in a portion of the spectrum where there are not major bulk peaks. The surface state observed on Ni(111) by Himpsel and Eastman¹² and the proposed state in the d bands of Cu(100)²³ are the only examples where an attempt has been made to separate surface-state emission from intense bulk emission at the same energy. The states on Ni(100)

are of this type, they are mixed in with the high density of states d -band region of Ni.

The value of k_{\parallel} used in Fig. 2 in the [11] direction was 1.30 \AA^{-1} . This is close to the SBZ edge at 1.26 \AA^{-1} . A photon energy sweep at this value of k_{\parallel} shows that the peak in the even symmetry geometry of Fig. 2 does not change in binding energy. Figure 3 shows a photon sweep for the same geometry but with a different value of k_{\parallel} (0.96 \AA^{-1}). The initial-state energy of the surface peak does not move with photon energy. There is a slight apparent motion of the peak to higher binding energy with increasing photon energy. This is a consequence of the decreasing resolution as the photon energy increases (fixed slits). The peak at higher binding energy [$\sim -2 \text{ eV}$] illustrates the effects of a direct transition. It clearly moves in energy.

The surface-sensitive peak in the [11] direction of even symmetry can be observed for $0.85 \leq k_{\parallel} \leq 1.6 \text{ \AA}^{-1}$. For values of k_{\parallel} either larger or smaller we have trouble identifying a surface peak. There are strong direct transitions in this region. It is possible that the surface peak broadens and/or disperses for

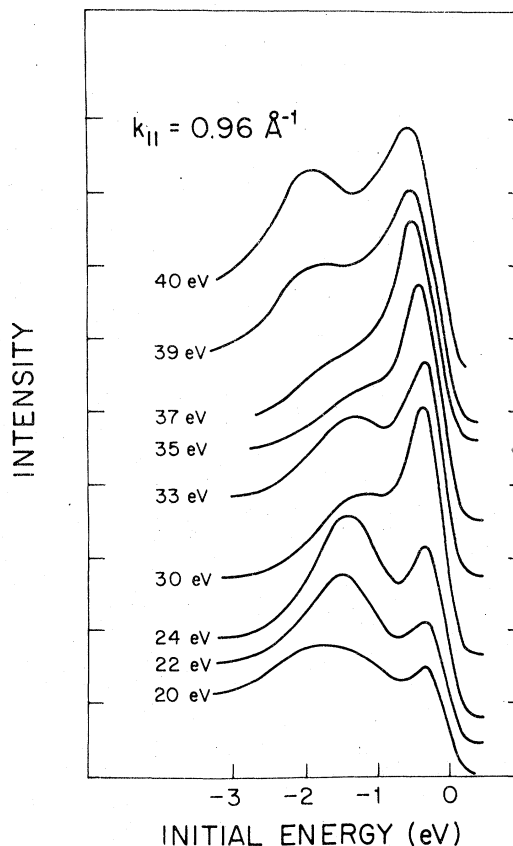

FIG. 3. Photon energy sweep for fixed k_{\parallel} in [11] direction. s polarized light in the "even" geometry used in Fig. 2.

$k_{||}$ values outside of this range, but the peak at the Fermi energy does not exist. The major experimental observation is that the narrow surface-sensitive peak at the Fermi energy is not observable for values of $k_{||}$ outside the above limits. These limits are symmetric about the zone edge at $k_{||} = 1.26 \text{ \AA}^{-1}$.

Figure 4 compares clean Ni to Ni with a $p(2 \times 2)S$ overlayer for four photon energies and a range of $k_{||}$ values, the measurement geometry is the same as

that shown in the bottom right panel of Fig. 2. We see both even and odd states.²⁴ The shaded regions show the portion of each clean spectrum which is of odd symmetry,²⁵ peaked at the Fermi energy and surface sensitive. This odd symmetric state exists for all four photon energies for $k_{||} \geq 0.8 \text{ \AA}^{-1}$ while it appears at 0.6 \AA^{-1} in the 17 eV spectrum and 0.7 \AA^{-1} in the 21 eV spectrum. Figure 4 also shows that there is a large attenuation of a clean spectrum at normal em-

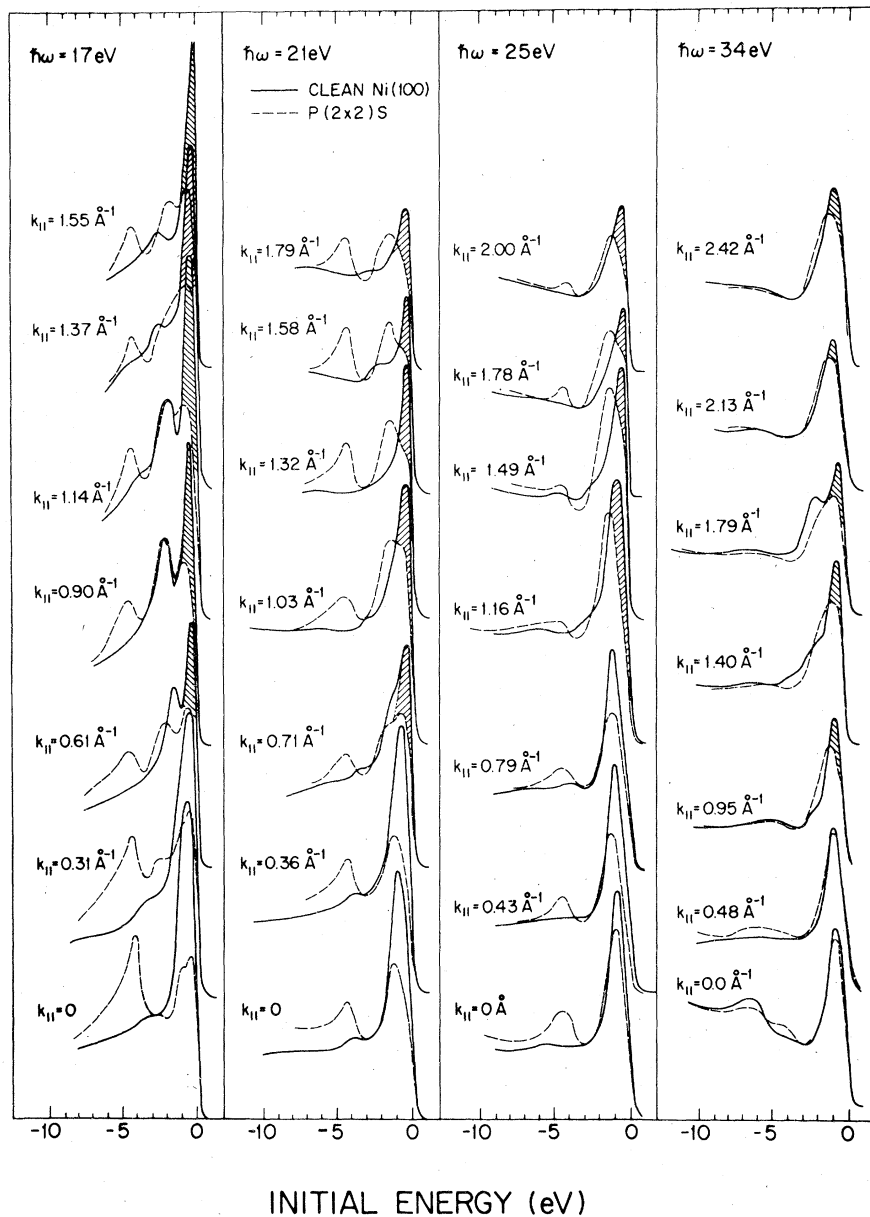

FIG. 4. Comparison of photoelectron spectra of clean Ni and Ni with $p(2 \times 2)S$ overlayer for four photon energies and several values of $k_{||}$. The measurement geometry is the "even plus odd" geometry of Fig. 2, with $k_{||}$ along the [10] direction.

ission [$k_{\parallel}=0 \text{ \AA}^{-1}$] upon adsorption. This normal emission data will be discussed in Sec. IV because it fails to satisfy the second test, i.e., the surface-sensitive peak appears to move with photon energy.

Figures 2, 3, and 4 show that the photoionization cross section of the proposed even surface state in the [11] direction is larger at higher-photon energies than the odd surface state in the [10] direction, relative to the Ni d bands. As an example, when the experiments shown on the left of Fig. 2 at $\hbar\omega=30 \text{ eV}$ were carried out in the [10] direction nothing changed in the "even" geometry and the loss in signal was only $\sim 20\%$ in the odd geometry. The equivalent loss of signal in the [11] direction at $\hbar\omega=30 \text{ eV}$ is $\sim 40\%$.

The third and only remaining test for a surface state is to project the bulk bands onto the SBZ. Figure 5 shows at the top the SBZ with the two symmetry directions indicated. Directly below is the bulk Brillouin zone with the two projection planes [(100) and (110)] shaded. We have used the bulk bands calculated by Wang and Calloway²⁶ scaled to fit the Fermi surface²⁶ and the critical points measured by Himpsel *et al.*¹⁵ We also use the experimental value for the exchange splitting of 0.31 eV obtained by Eastman *et al.*²⁷ Figure 6 shows the projection of the odd (even) majority and minority bulk bands onto the [10] ([11]) directions of the SBZ. This figure also shows that the observed surface-sensitive energy levels lie in regions of the SBZ where band

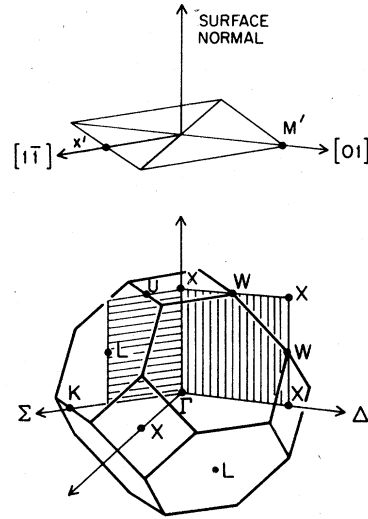

FIG. 5. Surface Brillouin zone at the top and bulk Brillouin zone at the bottom. The (100) and (110) planes are shown in the bulk zone.

gaps exist. This state in the [10] direction lies in a gap in the majority bands and the state in the [11] direction fits very nicely into the minority band gap at the zone edge.

We have not yet proven that the surface-sensitive peaks in the photoelectron spectra from Ni(100) are

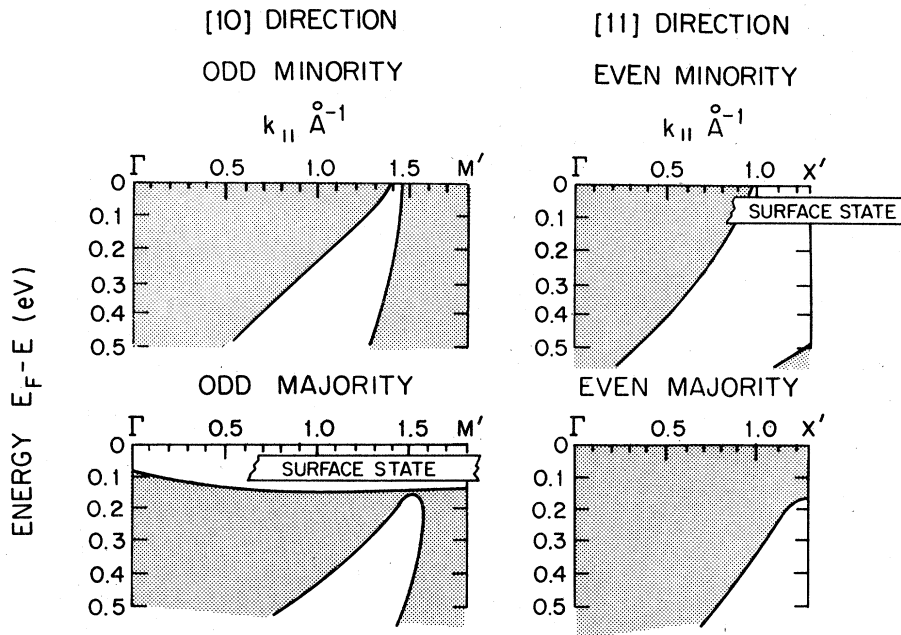

FIG. 6. Projection of the bulk bands onto the two symmetry directions of the surface Brillouin zone. The odd majority and minority bands are projected onto the [10] direction (Γ to M'). The even bands are projected onto the [11] direction (Γ to X').

due to surface states. The experimental data coupled with the bulk band projection in Fig. 6 leave three possible explanations. To illustrate these possibilities consider the surface-sensitive peak in the [11] direction, (a) it can be a surface state in the even minority bands, (b) it can be a surface resonance in the majority bands, and (c) it can be a degenerate surface state and surface resonance. The first two possibilities lead to magnetic states.

The last explanation is unlikely. It would require an energy splitting between the surface state and surface resonance of less than ~ 0.07 eV.²⁸ This is much smaller than the measured exchange splitting (~ 0.3 eV) for the bulk bands of Ni near the Fermi energy.²⁷ The concept of a magnetically "dead" layer at the surface seems to have died.^{16,29,30}

We are left with only two reasonable explanations of the data, surface resonances or surface states. Either one of these possibilities would produce magnetic states. Experimentally we do not know how to separate surface states from surface resonances. In principle we should be able to tell resonances from states by measuring the energy width. Resonances should be wide and surface states very narrow. The unanswered question is how wide. All surface states will have a width due to lifetime effects. In Fig. 7 we have plotted the FWHM of all of the surface states reported in the literature. We present data only for systems where it is clearly demonstrated that the structure is a surface state and where the inherent width can be calculated. The FWHM is ~ 0.15 eV for a state within 0.1 eV of the Fermi energy and increases to 0.4 eV for a state 1.0 eV below the Fermi

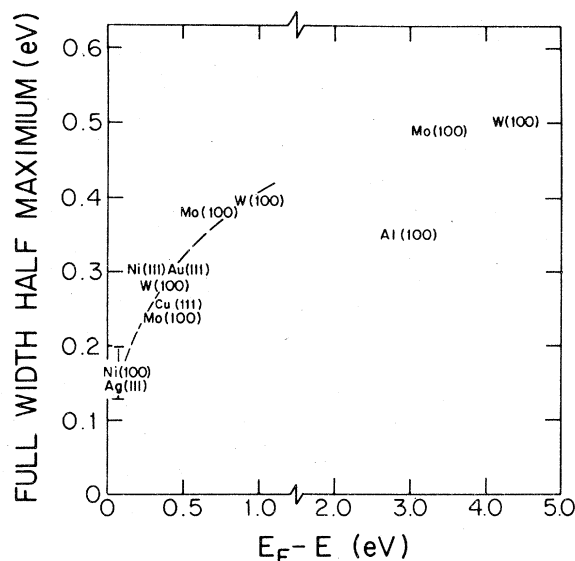

FIG. 7. Full width at half maximum (FWHM) of surface states on metals. Ag(111), Au(111), and Cu(111), Ref. 8; W(100) and Mo(100), Ref. 5; Al(100), Ref. 31; and Ni(111) Ref. 12.

energy. The width at 4.0 eV below the Fermi energy has not increased significantly from 1.0 eV below the Fermi energy. Our Ni(100) data is placed on this figure, showing that it falls in the correct energy range for a surface state at the Fermi energy. What is needed to accompany this figure is the equivalent plot for surface resonances. There is very little data on surface resonances. The W surface states become resonances off of the symmetry directions, but the coupling to the bulk bands is so weak that the increase in width would be unnoted. In the next section we will describe normal emission data where a surface resonance may be present approximately 0.5 eV below the Fermi energy. It has a width of 0.6 eV, which is about twice the value shown in Fig. 7 for this energy.

The most consistent explanation is that we have observed magnetic surface states.

Finally, we have limited experimental data about these surface states off of the symmetry directions. Two types of experiments were performed. In the first the crystal was fixed with respect to the polarization of the light and the detector direction was rotated in azimuthal angle (Fig. 1) keeping the polar angle fixed. If we start at the zone boundary in the [11] direction ($X', k_{\parallel} = 1.26 \text{ \AA}^{-1}$) using the even geometry described in the top left of Fig. 2, and rotate the azimuthal angle of the detector, then we can observe the extent of the "even" [11] state into the SBZ. This state seems to disappear within $20\text{--}30^\circ$ of the [11] direction. When the crystal is rotated 45° and the detector is perpendicular to the polarization only the odd [10] surface state is seen. In this geometry the signal disappears within 20° of the [10] direction.

The second type of experiment fixed the collection direction relative to the polarization vector, using a polarized light and rotated the crystal. This procedure is very sensitive to the crystal orientation. When the collection direction is parallel to the polarization direction there is a sharp maximum in the [11] direction and a minimum in the [10] direction, i.e., even and odd states. The width in azimuthal angle for the maximum [11] or minimum [10] was approximately 20° (FWHM).

IV. DISCUSSION

In this section we will first discuss the surface-sensitive structure in normal emission, and then explore alternate explanations of the data presented in Sec. III. Experiments will be proposed to test our explanation. We will also compare our results with the calculations of Dempsey, Grise, and Kleinman.¹⁴

The photoelectron spectra presented in Fig. 4 showed that there was a surface-sensitivity peak in the normal emission spectra. For a specific value of photon energy this surface-sensitive peak exhibited a

larger width (~ 1 eV) and a binding energy larger than either the [10] or [11] surface states discussed previously. Measurements in the plane of incidence (top of Fig. 2 for [10] direction) coupled with normal emission plots as a function of the angle of incidence showed that this structure near normal has even parity. This even surface-sensitive structure exists from $k_{\parallel}=0$ to 0.4 \AA^{-1} in the [10] direction, but it fails two of the three tests for a surface state. It moves or disperses with changing $\hbar\omega$ and it does not lie in a gap in the SBZ.

Figure 8 shows more energy distributions for normal emission on the left and difference curves on the right. The arrows indicate the problem, the shape and energy position changes as a function of photon energy. Therefore this structure fails the second test. There could be two or more competing effects causing this movement, but the structure in the difference curves looks just like the structure in the clean curves. This moving structure (with photon energy) has been used by Himpsel *et al.* to plot out the initial-state band structure in the [100] direction.¹⁵ Our guess is that the peak at low- and high-photon energies positioned 0.5 eV below the Fermi energy (FWHM ~ 0.6 eV) could be a surface resonance.

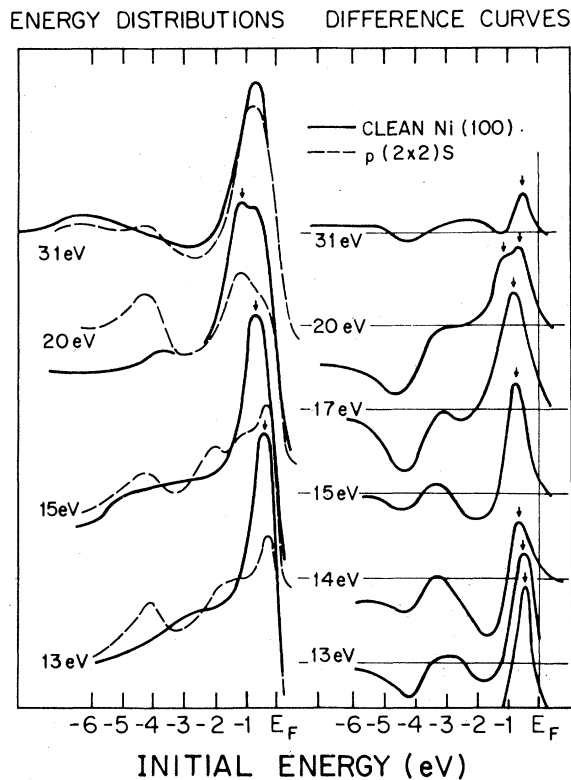

FIG. 8. Photoelectron spectra for normal emission for Ni(100), using p -polarized light. The curves on the right are difference spectra [clean $p(2 \times 2)S$].

The structure which starts to disperse at 14 eV is the direct transition from the Δ_1 band. The ordered S layer must preferentially scatter this signal. This type of scattering can be seen in selected curves in Fig. 4. Note that the curves taken near the zone boundary ($k_{\parallel}=1.79 \text{ \AA}^{-1}$) show dramatic difference in the region ~ 2 eV below the Fermi energy. The $\hbar\omega=21$ and 25 eV curves show a peak 1.5 eV below the Fermi energy induced by the S adsorption. The $\hbar\omega=34$ eV curve shows a peak 2 eV below the Fermi energy which is destroyed by the S adsorption. This latter peak in the clean spectrum must be a direct excitation from near the W_3 point in the Ni band structure. The appearance or disappearance of this structure upon adsorption may result from umklapp process.

Now we turn our attention to alternate explanations of the data of Sec. III. The surface sensitivity of the peaks seen in the photoelectron spectra of Fig. 2 has been assumed to be a consequence of changes in the initial state upon adsorption. Let us investigate other possibilities. The excitation matrix element from the initial state ψ_i to a final state ψ_f is given by

$$P_{if} \propto \langle \psi_i | \vec{A} \cdot \vec{P} + \vec{P} \cdot \vec{A} | \psi_f(\vec{k}) \rangle$$

The surface-sensitive structures in Fig. 2 have been proven to be excited by A_{\parallel} , the component of the electric field parallel to the surface. If we neglect surface roughness, then as shown by classical electrodynamics, A_{\parallel} is continuous across the surface. Thus the dipole operator $\vec{A} \cdot \vec{P} + \vec{P} \cdot \vec{A}$ is not changed upon adsorption if we regard only the A_{\parallel} term. This leaves changes in the final state upon adsorption as the only alternate explanation. If we view $\psi_f(\vec{k})$ as a scattering state containing both elastic and inelastic scattering, the surface sensitivity could result from changes upon adsorption of the elastically scattered wave, i.e., the scattering potentials change. If this were the case it would be hard to imagine that these changes would not be quite sensitive to the energy of the outgoing state. The value of k_{\parallel} that is surface sensitive should depend upon the energy. Alternately the loss of signal in the d -band region of the Ni spectrum could result from changes in the inelastic scattering upon adsorption. This is the explanation commonly used to explain attenuation of d -band peaks. The excited electrons from the Ni are attenuated passing through the adsorbate layer. The data shown in Figs. 2, 3, and 4 show that neither of these explanations can explain the surface-sensitive peaks shown in Fig. 2. First the range of k_{\parallel} where the surface states are observed is relatively independent of photon energy; second both states are observed over a wide range of photon energies. Finally Fig. 2 clearly proves it can not be inelastic scattering. The electrons in the top and bottom panels are coming out of the crystal with the same energy and vector momentum, therefore

they should both be attenuated by the same amount. Stated in another way the inelastic scattering by the overlayer only depends upon the vector momentum of the scattering electron.

We are back to our original conclusion, that the surface-sensitive peaks in Fig. 2 are surface states or surface resonances. There are two additional experiments which immediately suggest themselves. (i) Angle- and energy-resolved spin-polarization measurements. Figure 2 shows that for $k_{\parallel} = 1.30 \text{ \AA}^{-1}$ in the [11] direction in the even geometry the net spin at the Fermi energy should be approximately 0, for a surface state. A surface resonance would produce a large majority spin. (ii) If the surface states are magnetic the effect of the temperature-dependent exchange splitting should be observable.

Much of the burden of proving or disproving the explanation offered in this paper will rely upon theoretical calculation. The only relevant calculation at present is that of Dempsey, Grise, and Kleinman.¹⁴ They have developed a method for fitting a bulk energy-band-structure calculation in a linear combination of atomic orbitals (LCAO) scheme. They then calculate the energy bands of an n layer film in what they describe as an internally consistent method. Their calculation is fit to Wang and Calloway's²⁶ band-structure calculation which as previously explained has a different exchange splitting and d -band width than the measured values.^{15,27} Therefore we should not expect quantitative agreement. Their calculation is in qualitative agreement with our results. By this we mean that everywhere we find a surface state they have one in the same gap and approximately at the same energy. The problem is that this calculation shows many more surface

states than we find. For example, there is an odd state from Γ to X' in the gap of the majority band. We do not see this state, so presumably it will be shoved above the Fermi energy when a smaller exchange splitting is used in the calculation. This calculation also predicts that the even surface state shown in the gap in [11] direction in Fig. 6 should disperse downward and follow the band edge as k_{\parallel} decreases. They also predict that we should have seen another even surface state along the [11] direction in the majority band gap approximately 0.2 eV below the minority surface state. This calculation does predict that the odd surface state in the Γ to M' direction should mix into the odd majority bands at $k_{\parallel} \sim 1 \text{ \AA}^{-1}$, but it also crosses the Fermi energy at $k_{\parallel} \approx 1.5 \text{ \AA}^{-1}$. The calculated and measured surface states agree well enough to justify redoing the calculation, fitting to the measured band structure. With the new predictions we should go back and look with higher resolution for the states predicted by the calculation, but not reported in this paper.

ACKNOWLEDGMENTS

We would like to thank S. Weeks and G. Loubriel for assisting us in these experiments and Paul Soven for his guidance and patience. We also thank Leonard Kleinman for several useful discussions concerning the work. This work was supported by the NSF through the Materials Research Laboratory Program under Grant No. DMR 76-80994 and NSF Grant No. DMR 73-02656. The University of Wisconsin Synchrotron Radiation Center was supported by NSF Grant No. 74-15098.

¹L. W. Swanson and L. C. Crouser, Phys. Rev. Lett. **16**, 389 (1966).

²E. W. Plummer and J. W. Gadzuk, Phys. Rev. Lett. **25**, 1493 (1970).

³The sensitivity of a structure in an electron energy distribution to adsorption is a necessary (but not sufficient) condition to identify a surface state.

⁴F. Forstmann and J. B. Pendry, Z. Phys. **235**, 75 (1970); J. B. Pendry and F. Forstmann, J. Phys. C **3**, 59 (1970).

⁵Shang-Lin Weng, E. W. Plummer, and T. Gustafsson, Phys. Rev. B **18**, 1718 (1978).

⁶G. P. Kerker, K. M. Ho, and M. L. Cohen, Phys. Rev. Lett. **40**, 1593 (1978).

⁷J. E. Inglesfield, Surf. Sci. **76**, 379 (1978) and unpublished.

⁸P. Heimann, H. Neddermeyer, and Roloff, J. Phys. C **10**, L17 (1977); P. O. Gartland and B. J. Slagsvold, Phys. Rev. B **12**, 4047 (1975).

⁹J. B. Danese and P. Soven, Phys. Rev. B **16**, 706 (1977).

¹⁰P. O. Gartland and B. J. Slagsvold, Solid State Commun. **25**, 489 (1978); G. V. Hansson and S. A. Flodstrom, Phys.

Rev. B **18**, 1562 (1978).

¹¹E. Caruthers, L. Kleinman, and G. P. Alldredge, Phys. Rev. B **8**, 4570 (1973); J. B. Pendry and J. F. L. Hopkinson, J. Phys. (Paris), Colloq. **39**, C4-142 (1978).

¹²F. J. Himpsel and D. E. Eastman, Phys. Rev. Lett. **41**, 507 (1978).

¹³W. Eib and S. F. Alvarado, Phys. Rev. Lett. **37**, 444 (1976).

¹⁴D. G. Dempsey, W. R. Grise, and L. Kleinman, Phys. Rev. B **18**, 1270 (1978).

¹⁵F. J. Himpsel, J. A. Knapp, and D. E. Eastman, Phys. Rev. B **20**, 624 (1979).

¹⁶I. D. Moore and J. B. Pendry, J. Phys. C **11**, 4615 (1978).

¹⁷C. L. Allyn, T. Gustafsson, and E. W. Plummer, Rev. Sci. Instrum. **49**, 1197 (1978).

¹⁸F. C. Brown, R. Z. Bachrach, S. B. M. Hagstrom, N. Lien, and C. H. Pruett, in *Vacuum Ultraviolet Radiation Physics*, edited by E. E. Koch, R. Haensel, and C. Kunz (Pergamon, New York, 1974).

¹⁹M. Scheffler, K. Kambe, and F. Forstmann, Solid State Commun. **25**, 93 (1978).

- ²⁰P. Heimann and H. Neddermeyer, *J. Phys. F* **6**, L257 (1976).
- ²¹P. J. Page, D. L. Trimm, and P. M. Williams, *J. C. S. Faraday I* **70**, 1769 (1974).
- ²²L. Richter and R. Gomer, *Phys. Rev. Lett.* **37**, 763 (1976); R. L. Billington and T. N. Rhodin, *Phys. Rev. Lett.* **41**, 1602 (1978).
- ²³J. G. Gay, J. R. Smith, and F. J. Arlinghaus, *Phys. Rev. Lett.* **42**, 332 (1979).
- ²⁴The curves for each $\hbar\omega$ are for polar angles 0° , 10° , 20° , 30° , 40° , 50° , and 60° . The light is *p* polarized [$\theta_l = 45^\circ$], A_{\parallel} is in [100] direction and the detection is perpendicular to A_{\parallel} [$\varphi = 0^\circ$].
- ²⁵The shaded regions do not appear in the even geometry of Fig. 2.
- ²⁶C. S. Wang and J. Callaway, *Phys. Rev. B* **15**, 298 (1977).
- ²⁷D. E. Eastman, F. J. Himpsel, and J. A. Knapp, *Phys. Rev. Lett.* **40**, 1514 (1978).
- ²⁸Attempts to fit the high-resolution data with two Gaussian peaks showed clear shoulders for an energy separation of 0.07 eV. A separation of 0.1 eV resulted in two peaks.
- ²⁹C. S. Wang and A. J. Freeman (unpublished).
- ³⁰O. Jepsen, *Bull. Am. Phys. Soc.* **24**, 440 (1979).
- ³¹H. Levinson, E. W. Plummer, and P. J. Feibelman (unpublished).