

Manufacturing System Design: Flexible Manufacturing Systems and Value Stream Mapping

by

Rhonda A. Salzman

B.S. Mechanical Engineering
Massachusetts Institute of Technology, 2000

SUBMITTED TO THE DEPARTMENT OF MECHANICAL ENGINEERING IN
PARTIAL FULFILLMENT OF THE REQUIREMENTS FOR THE DEGREE OF

**MASTER OF SCIENCE IN MECHANICAL ENGINEERING
AT THE
MASSACHUSETTS INSTITUTE OF TECHNOLOGY**

JUNE 2002

© 2002 Massachusetts Institute of Technology
All rights reserved

Signature of Author: _____
Department of Mechanical Engineering
May 15, 2002

Certified by: _____
Timothy G. Gutowski
Professor of Mechanical Engineering/Associate Department Head
Thesis Supervisor

Certified by: _____
John T. Shields
Program Manager, Lean Aerospace Initiative
Thesis Reader

Accepted by: _____
Ain A. Sonin
Professor of Mechanical Engineering
Chairman, Committee for Graduate Students

Manufacturing System Design: Flexible Manufacturing Systems and Value Stream Mapping

By

Rhonda Salzman

Submitted to the Department of Mechanical Engineering
on May 15, 2001 in Partial Fulfillment of the
Requirements for the Degree of Master of Science in
Mechanical Engineering

Abstract

Manufacturing system design cannot be considered a science with formal principles and equations. The methodology used here to expand the knowledge of manufacturing system design is two-fold and includes an in-depth manufacturing system redesign and an investigation into the current uses, limitations, and appropriateness of value stream mapping (VSM). The case study shows why the given system was lacking in efficiency and what could be learned to improve its design. The analysis found the machinist to be a critical, yet overextended, resource for smooth production flow. Using multiple tools, a mismatch was identified between the current goals and system. A future system was designed that could manage both the system parameters and the expected changes in these inputs within the lifetime of the system. In the second part of the thesis, value stream mapping was studied through a mixture of case studies, interviews, and a survey. The principal result is that the success of a value stream mapping event is correlated with the environment in which it is run. This analysis shows the necessity for companies to rethink the capacity of VSM to benefit a particular system. A worksheet is proposed which can be used to determine the appropriateness of VSM.

Thesis Supervisor: Timothy G. Gutowski

Title: Professor of Mechanical Engineering/Associate Department Head

Acknowledgements

SUPPORT

I am grateful to Heidelberg Web Systems, Inc. and the Lean Aerospace Initiative for giving me the chance to do research that directly affects industry, works with real problems, and allows me the chance to experience manufacturing. The members of the LAI Consortium companies were always helpful and made a special effort to answer my questions and discuss my theories. I am also grateful to the employees of Heidelberg who were willing to share with me the details of their jobs and discuss ideas of how to improve them, and to Juergen Krebs and Bruno Posset whose thirst for knowledge and dedication to determine root cause drove this study. I would also like to thank the National Science Foundation for allowing me the privilege of attending graduate school and the freedom to choose my own research.

GUIDANCE

I would like to thank my research team, who has helped lead me through the journey of graduate research: Prof. Timothy Gutowski, whose guidance, patience, and expertise has guided me through all of the research contained in this document, and allowed me to learn from his enormous range of knowledge. Dr. Stanley Gershwin, who helped to keep me grounded to fundamental principles, and whose insights were always helpful and sometimes groundbreaking in my research. Tom Shields, whose advice and support helped me to gain a broader perspective on my research and who always looked out for my best interests. Prof. Ken McKay, whose constant questioning kept me thinking about new problems and new solutions. I would also like to thank the other students in my lab group whose constant thoughts and critiques were always helpful and uplifting, Mandy Vaughn and Pradeep Fernandes.

FRIENDS AND FAMILY

The work here is dedicated to my loving family, without whose push I would never have made it to graduate school and would have been too afraid to try. To my fiancé, Michael Altman, whose support has been necessary for my success and whose kindness has made me a better person. Seth Berman, whose outlook on graduate school helped remind me why I was at MIT, and helped me become excited again about learning and knowledge in general. Jim Chase, who answered my constant badgering of questions and always patiently waited for a break in the conversation to reply.

This thesis is dedicated to those who have helped to shape its work, directly or indirectly.

*I've done it, I've done it!
Guess what I've done!
Invented a light that plugs into the sun.
The sun is bright enough,
The bulb is strong enough,
But, oh, there's only one thing wrong...
The cord ain't long enough.*

INVENTION by Shel Silverstein

Table of Contents

<i>Abstract</i>	3
<i>Acknowledgements</i>	5
<i>Table of Contents</i>	7
<i>List of Figures</i>	10
<i>List of Tables</i>	12
Chapter 1 Introduction and Executive Summary	13
1.1 Flexible Manufacturing System Case Study	14
1.2 Value Stream Mapping	17
Chapter 2 Introduction to Manufacturing System Design	20
2.1 Manufacturing Systems Team and the Lean Aerospace Initiative	20
2.2 Manufacturing System	22
2.3 Manufacturing System Design	23
References	26
PART ONE IN-DEPTH CASE STUDY	27
Chapter 3 Methodology for Manufacturing System Design - Case Study	28
3.1 Manufacturing System Design Framework	28
3.2 Manufacturing Strategy by Miltenburg	29
3.3 Case Study Methodology	31
References	32
Chapter 4 Case Study Current System Analysis	33
4.1 Case Study Background	33
4.2 Characterization of the Problem	35
4.3 Pie Chart Data	38
4.4 Improvement Opportunities	39
4.5 Analysis of Current System	41
4.6 Conclusions	42
References	43
Chapter 5 Case Study System Redesign	44
5.1 Competitive Goals	44
5.2 Benchmarking	45

5.2.1	A Case Study Analysis of Flexible Manufacturing Systems _____	45
5.2.2	Lean Aerospace Initiative’s Flow Efficiency _____	48
5.3	Redesign Methodology _____	49
5.3.1	Miltenburg’s Manufacturing Strategy Worksheet _____	49
5.3.2	Conclusion _____	50
5.4	System Redesign _____	51
5.4.1	Recommendations _____	51
5.4.2	Backup Information _____	54
5.5	Simulation _____	57
5.5.1	Simulation Basics _____	57
5.5.2	Model Procedure _____	58
5.6	Conclusion _____	66
	References _____	66
	<i>PART ONE CONCLUSION _____</i>	68
	<i>PART TWO VALUE STREAM MAPPING _____</i>	71
Chapter 6	<i>Background and Problem Definition for VSM _____</i>	72
6.1	Lean History _____	72
6.2	Lean Principles _____	73
6.3	Value Stream Mapping _____	75
6.3.1	Current State _____	75
6.3.2	Future State _____	77
6.3.3	Implementation Plan _____	78
6.3.4	Value Stream Mapping at Heidelberg _____	78
6.3.5	Summary of VSM _____	79
6.4	Summary _____	80
6.5	Problem Statement _____	80
	References _____	80
Chapter 7	<i>Value Stream Mapping Environment _____</i>	82
7.1	Hypothesis & Purpose _____	82
7.2	Methodology for Research/Experimental Design _____	83
7.2.1	Methodology _____	83
7.2.2	Develop Hypotheses _____	84
7.2.3	Survey Organization _____	89
7.3	Results _____	92
7.3.1	Main results _____	92
7.3.2	Data Verification _____	94
7.3.3	Additional Results from Survey _____	96
7.4	Proposed Value Stream Mapping Worksheet _____	99

7.4.1	Implementation	99
7.4.2	Value Stream Matrix	100
7.5	Additional Insights	103
7.6	Improvement Opportunities	104
	References	105
<i>PART TWO CONCLUSION</i>		106
Chapter 8	<i>Conclusion and Recommendations</i>	107
8.1	Flexible Manufacturing System Case Study	107
8.2	Value Stream Mapping	108
	References	109
Appendix A	<i>Manufacturing System Design References</i>	110
Appendix B	<i>Case Study Framework Description</i>	111
B.1	Analysis of the Current System	111
B.2	Goals – selection of criteria	113
B.3	System Selection	114
B.4	Initial Design	115
Appendix C	<i>Simulation</i>	118
C.1	Stochastic Model Parameters	118
C.2	Configuration and Input Changes	120
Appendix D	<i>Value Stream Mapping Survey</i>	121
D.1	Survey	121
D.2	Glossary	125
D.3	Informed Consent	125

List of Figures

Figure 1-1 Thesis Outline	13
Figure 1-2 Heidelberg's Flexible Manufacturing System	14
Figure 1-3 Manufacturing System Design Methodology	15
Figure 1-4 Effects of Setup, Variation in Cycle Time, and Other Factors on System Utilization	15
Figure 1-5 Hybrid System Proposal.....	16
Figure 1-6 The Effect of Environmental Characteristics on Implementation.....	18
Figure 1-7 VSM Matrix	18
Figure 1-8 Comparison of Environmental Characteristics to Success.....	19
Figure 2-1 Manufacturing System Design Framework (Fernandes, 2001;Vaughn, 2002)	21
Figure 2-2 Definition of Manufacturing System (J T. Black, 1991)	22
Figure 2-3 Hierarchy of System Objectives (Hopp & Spearman, 1996).....	25
Figure 3-1 Manufacturing System Design Framework (Fernandes, 2001; Vaughn, 2002)	29
Figure 3-2 Miltenburg's Manufacturing Strategy Worksheet (Miltenburg, 1995)	30
Figure 3-3 Generalized Methodology for System Design	31
Figure 4-1 Heidelberg Maxim Cell.....	34
Figure 4-2 System Data Leading to Study	35
Figure 4-3 Utilization vs. Lot Size.....	36
Figure 4-4 Spindle Uptime compared to Productive Time	37
Figure 4-5 Effects of Setup, Variation in Cycle Time, and Other Factors on System Utilization	38
Figure 4-6 Pie Chart Data Obtained in 1997	38
Figure 4-7 Machinist Matrix	41
Figure 5-1 Comparison of Different Types of Manufacturing Systems (Black, 1991)....	48
Figure 5-2 Flow Shop and Job Shop regimes on a Flow Efficiency Plot (Shields, 1996)	49
Figure 5-3 Manufacturing Strategy Worksheet-Partial (Miltenburg, 1995).....	50
Figure 5-4 System Elements used for System Redesign	51
Figure 5-5 Hybrid System Proposal.....	52
Figure 5-6 Transition States.....	53
Figure 5-7 Current Machinist Job Wheels	54
Figure 5-8 New Machinist Job Wheel	55
Figure 5-9 Simulation Modeled System Components	57
Figure 5-10 Simulation Current System Model.....	59
Figure 5-11 Comparison of Simulation with Historic Data.....	60
Figure 5-12 Simulation Utilization Trend Comparison to Historic Data	60
Figure 5-13 Machine-Operator Configurations Modeled in Simulation	61
Figure 5-14 Utilization of Different Machine Configurations Using Simulation.....	62
Figure 5-15 Utilization Map Comparing Machine Configuration and Part Inputs.....	63
Figure 5-16 50% Change in Machine Failures	65
Figure 5-17 50% Change in All Setup Quantities	65
Figure 6-1 Steps of Lean Thinking (Womack, 1996).....	74
Figure 6-2 Current Value Stream Map (Rother, 1999).....	76
Figure 6-3 Future Value Stream Map (Rother, 1999).....	78

Figure 7-1 Simplification of Ten Inputs for VSM Environment	86
Figure 7-2 How Costs, Quantity, Quality, and Humanity are Improved by the Toyota Production System (Monden, 1998)	89
Figure 7-3 VSM Matrix	90
Figure 7-4 Hierarchy of success	91
Figure 7-5 Comparison of Environmental Characteristics to Success.....	93
Figure 7-6 Original Survey Responses	94
Figure 7-7 Comparison of Surveys to Discussions.....	95
Figure 7-8 Investment compared to Organization	96
Figure 7-9 Complexity versus Capability	97
Figure 7-10 Comparison of reduced set of Characteristics and Success	98
Figure 7-11 Product and Process Characteristics versus Organizational Characteristics.	99
Figure 7-12 The Effect of Environment Characteristics on Implementation	100
Figure 7-13 Impact versus Implementation Difficulty	104
Figure A-1 Manufacturing System Design References	110
Figure B-1 Generalized Framework for System Design.....	111

List of Tables

Table 1-1 Five Environmental Characteristic Definitions	17
Table 4-1 Improvements within Other Factors, Variation in Cycle Time and Setup	40
Table 5-1 Benchmarking System Characteristics Summary	45
Table 5-2 Simulation Model Parameters	58
Table 5-3 Change Effect Matrix	64
Table 6-1 Typical Value Stream Metrics (Millard, 2001)	76
Table 7-1 Ten Manufacturing System Design Inputs (Fernandes, 2001)	83
Table 7-2 Research Methodology for VSM	84
Table 7-3 Question for Stage 1 of VSM Research	84
Table 7-4 Value Stream Mapping Survey Questions	91
Table 7-5 Description of Cases from Figure 7-5	93
Table 7-6 VSM Matrix	102
Table B-1 Framework Questions for System Design	111
Table B-2 Subsystems that Constitute a Production System (Miltenburg, 1995)	116
Table C-1 Description of Model Parameter Distributions for Setup	118
Table C-2 Description of Model Parameters for Breakdowns	119
Table C-3 50% Change in Setup Parameters	119
Table C-4 50% Change in Maintenance Parameters (MTBF)	119
Table C-5 Simulation Data Generated from Configuration and Input Changes	120

Chapter 1 Introduction and Executive Summary

Currently, manufacturing system design cannot be considered a science with formal principles and equations. This work will study the process of design through a manufacturing system redesign as well as to gain insight into the use of one design tool, value stream mapping.

This thesis will be split into two parts (Figure 1-1). Part 1 will focus on a case study performed over a one-year period. In the case study, the author will analyze and design a system within a manufacturing plant. This will be done to better understand the problems and obstacles of manufacturing system design through an in-depth study. The analysis of the current system and the design of the future system will be explored. With each step of the design, methodologies and tools will be used and each will be discussed in reference to the design. The case study can be used by the thesis reader to explore tools in manufacturing design or to compare his or her current framework for designing to the one used here, in an attempt to improve designing skills.

Part 2 of this thesis will take the opposite approach to exploring manufacturing system design. One tool, value stream mapping, is chosen as the subject and an in-depth study of its impact and uses is performed. This tool is explored for its benefits, limitations, and current use through multiple case studies and a survey. From this study, the reader can gain insight into where to use it, why to use it, and how to use it.

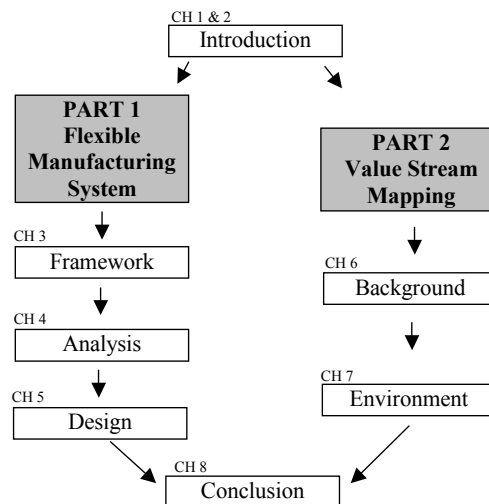

Figure 1-1 Thesis Outline

1.1 Flexible Manufacturing System Case Study

Heidelberg Web Systems, Inc. produces printing presses in the commercial and newspaper web offset regime. This study will focus on the division of Heidelberg Web Systems that fabricates the parts necessary to produce these presses. Another division of the organization assembles the presses. Heidelberg's Flexible Manufacturing System is not producing the necessary number of standard hours required by the company.

Therefore, it was requested that a study be performed to determine for what reasons the system was not producing as necessary and to make recommendations for future system requirements as the funding has been acquired for the system's replacement. The system, which can be seen in

Figure 1-2, is made up of five CNC Milling Machines connected by a computer controlled "rover" which distributes universal pallets, on which the parts are located, to all the machines and to the setup stations. The parts produced are mostly aluminum castings with a volume of 20 in³ or less.

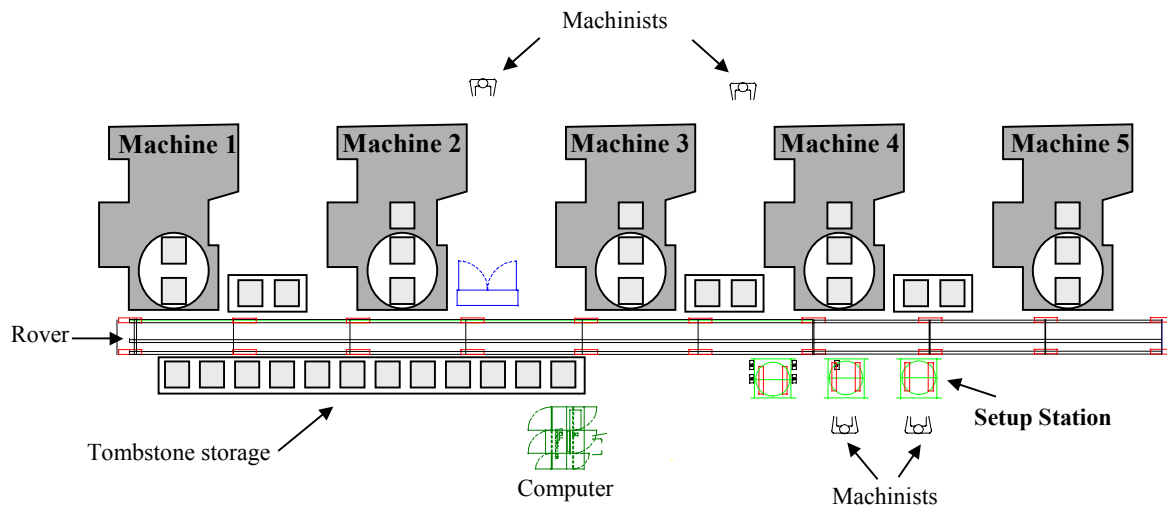

Figure 1-2 Heidelberg's Flexible Manufacturing System

An in-depth study of the current system was performed to determine the reasons it was not producing as expected. Once overarching themes and problems of the current system were determined, a high level study of the production system was performed followed by an in-depth look at the initial design stages of the new manufacturing system. Figure 1-3 shows the outline of this methodology.

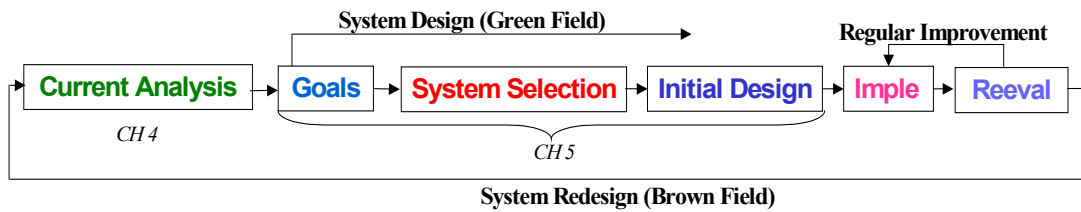

Figure 1-3 Manufacturing System Design Methodology

In performing the current system analysis, a relationship was found between the average lot size of products and the utilization, or spindle uptime, of the machinery. This encouraged the team to study the possible reasons for this phenomenon, which led to breaking down these reasons mathematically into: setup time, variation in cycle time from the minimum production time, and other factors which could not be easily separated. Figure 1-4 shows the separation of each of these factors and the estimated improvement in utilization that could be expected from an elimination of each of these factors individually from the system, in an attempt to determine root cause.

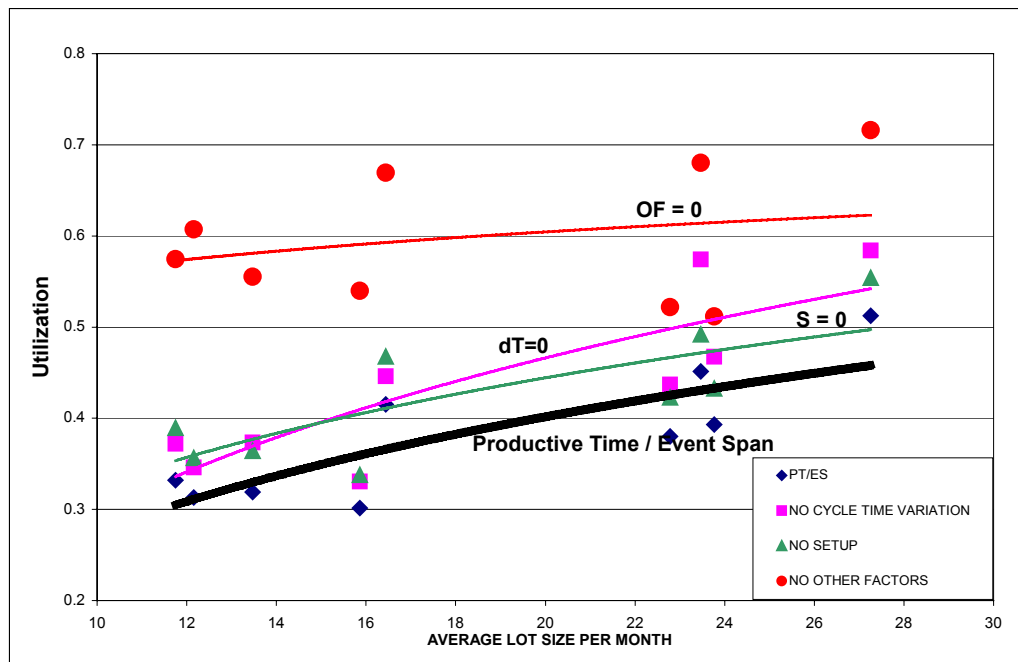

Figure 1-4 Effects of Setup, Variation in Cycle Time, and Other Factors on System Utilization

This analysis led to an exploration into the use of the machinist, where it was found that the machinist was a necessary resource for the resolution of all disruptions and was being overloaded by the disruptions. It is, therefore, necessary to consider the

machinist in any redesign that occurs, as it is understood that as lot size decreases the demands on the machinist increase, causing the reduction in machine utilization.

Using multiple manufacturing design tools and methodologies (Miltenburg's Manufacturing Strategy Worksheet, LAI Flow Efficiency Diagram, and benchmarking) to verify the determination, it was shown that the current production system was not appropriate for the current system parameters (volume, mix, and new parts per year) and was not meeting all of the system goals necessary for the happiness of the company (cost, quality, flexibility, and innovativeness).

From the lessons learned from the current system analysis and the insights from the system selection, a hybrid system (Figure 1-5) was determined to be the most appropriate system to meet the identified manufacturing goals. The hybrid system separates the product into groups allowing the immature, high maintenance products not to affect production of the high volume mature ones. The hybrid system machine organization can be modified to deal with the possibilities of mismatched goals that might occur over time. The benefits of these changes were shown through the use of a computer simulation. The simulation allowed study of the affects of both the shift in machinist task requirement and changes in model stochastic parameters.

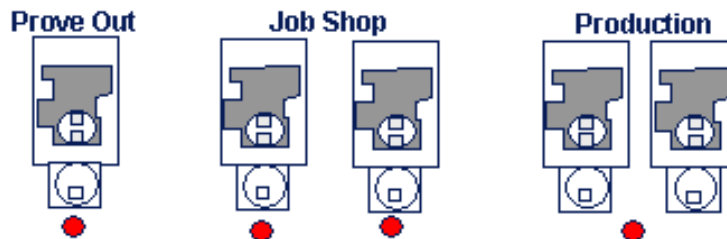

Figure 1-5 Hybrid System Proposal

Flexible Manufacturing Systems can produce a large array of different parts and can drastically reduce the time required to produce a part because of the movement to external setup. For these reasons, many companies are moving toward the use of FMS systems without realizing the possible dangers that can occur if they are placed in environments with the wrong characteristics. It was seen here that the system flexibility has caused the system to be greatly underutilized due to the inherent inability to measure

and find root cause. The system shift that occurs with the redesign may limit flexibility in order to allow the quicker, more standard response to system disruptions and elimination.

1.2 Value Stream Mapping

Value stream mapping is an improvement tool that has been used as an integral part of lean transformations. It has been shown to yield vast improvements in lead-time throughout manufacturing, including the aerospace industry, and beyond the factory floor. A value stream mapping exercise was performed at Heidelberg. The activity outlined possible improvement opportunities and helped identify the impact of the system being studied on both the upstream and downstream operations. It has also been seen that in some cases VSM is being used in what were not considered its initial appropriate environments. It was, therefore, the goal of this study to explore under what conditions (environmental) is it most appropriate to be performed and determine what insights could be given about VSM to aid in its success for the user.

In order to determine the appropriate conditions under which VSM should be performed, multiple case studies were completed. From these cases, a theory was developed about VSM. This theory was converted to a survey, which was used to capture the experiences of those doing VSM in the manufacturing sector of the aerospace industry.

It was seen that the five environmental characteristics (Table 1-1): ability to pick a representative part, capability, complexity, type of organization, and investment, could be used to explain the appropriateness of value stream mapping. These characteristics are organized in Figure 1-6 showing how they affect VSM. Three of the factors affect the success of the event itself, while two others affect the implementation of the new map.

Representative	Product that has similar process steps to the majority of the products that go through the system. The category also includes the time to obsolescence of the map due to product or process changes.
Capability	Level of difficulty associated with the production of a part.
Complexity	Technological ability to repeatedly assemble something with minimal intervention and minimal disruptions (scrap, rework, shortages).
Organization	Level of innovativeness (change) supported on the factory floor.
Investment	Availability of money and labor to make change.

Table 1-1 Five Environmental Characteristic Definitions

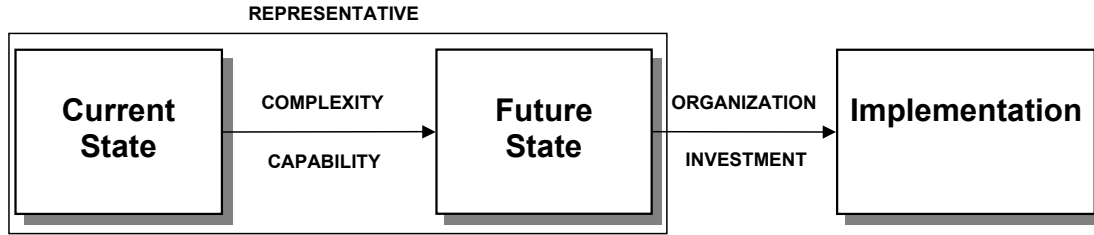

Figure 1-6 The Effect of Environmental Characteristics on Implementation

Using this organization of the five characteristics, a VSM Matrix has been created which is structured similar to Figure 1-6. The VSM Matrix, shown in Figure 1-7, can be used to determine how a company, or VSM area, fits into each category. By determining where the company fits in, from most appropriate for value stream mapping to inappropriate, leadership can see how effective VSM will be by studying the tradeoffs of different categories.

Environmental Characteristics					Success
Pick a Representative Part	Product Complexity	System Capability	Type of Organization	Investment	
				➔	

↑ VSM appropriate

Figure 1-7 VSM Matrix

The validity of the matrix was tested using a survey. Each environmental factor was scored on a one to five scale, with five being most appropriate. Figure 1-8 shows that the total of these scores correlates to the success of the VSM event.

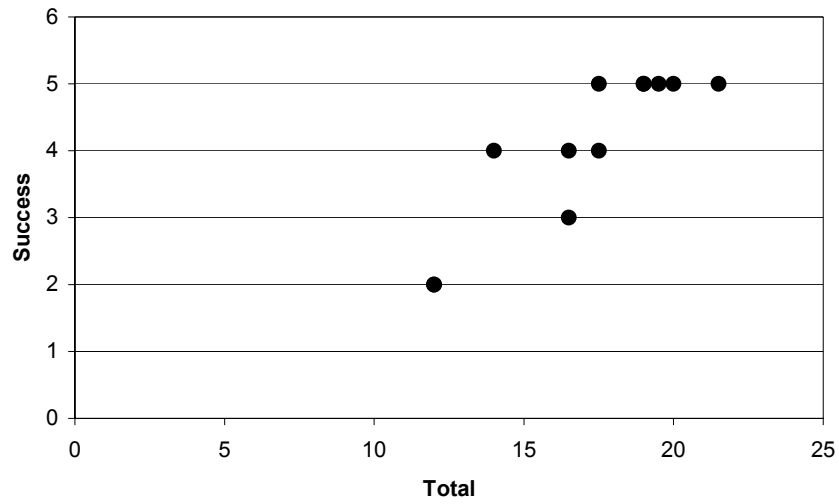

Figure 1-8 Comparison of Environmental Characteristics to Success

It has been shown that the five identified environmental characteristics do correlate with the success of the value stream mapping event. It is, therefore, recommended that future studies be performed to isolate the affect of each factor, and verify that additional factors are not needed. This theory could also be taken beyond value stream mapping to include other improvement tools.

Chapter 2 Introduction to Manufacturing System Design

This chapter will review the background of the Manufacturing Systems Team of the Lean Aerospace Initiative, the lab group under which the following research was conducted. It will also discuss the recent products of the team and show the motivation for this research.

2.1 Manufacturing Systems Team and the Lean Aerospace Initiative

The work seen here was conducted as part of the Manufacturing Systems Research Team, a division of the Lean Aerospace Initiative (LAI). LAI, a consortium of academic institutions, government organizations, and industrial partners, was started with the objective of studying lean principles and their relevance within the aerospace industry. This unique group allows for considerable information transfer and learning from what was previously considered a non-sharing industry. Some of the unique research products of this group include a “Production Operations Level Transition-To-Lean Roadmap” (Crabill, 2000) and a recent book, *Lean Enterprise Value* (Murman, 2002).

The initial goal of the Manufacturing Systems Research Team was to study implementation efforts that led to significant performance improvements in manufacturing systems. The efforts were focused on understanding the manufacturing operation and developing a broad knowledge base, which could be passed on to consortium members. This was done through exploratory surveys and case studies, including an inventory survey whose findings were used to make operation recommendations in dealing with inventory in the defense aerospace industry. The work also included multiple case studies used to “highlight the enablers, barriers and results (LAI, 2001)” in the pockets of lean occurring in the aerospace industry. (LAI, 2001)

The latest phase of the research focused on answering key system level questions, as it was found that manufacturing was larger than just a factory.

These questions included:

- (1) *What are the high level goals of the manufacturing system?*
- (2) *What is the best manufacturing system for a given set of conditions?*
- (3) *At what point does it make sense to redesign the manufacturing system?*

The first attempt at answering these questions was done by exploring the system level literature and creating a framework showing the “scope of manufacturing system design and the importance of a manufacturing system for the long-term success of a corporation” (Fernandes, 2001). This framework can be seen in Figure 2-1. As part of the current Manufacturing System Research Team’s efforts, this framework was being tested for validity by multiple case studies of aerospace companies. The results showed a correlation between fulfilling this framework and meeting the goals set out by the redesign. The research has shown a correlation between the presence of each phase in the framework, the timing of the phases in reference to each other, and their breadth across functional groups (Vaughn, 2002).

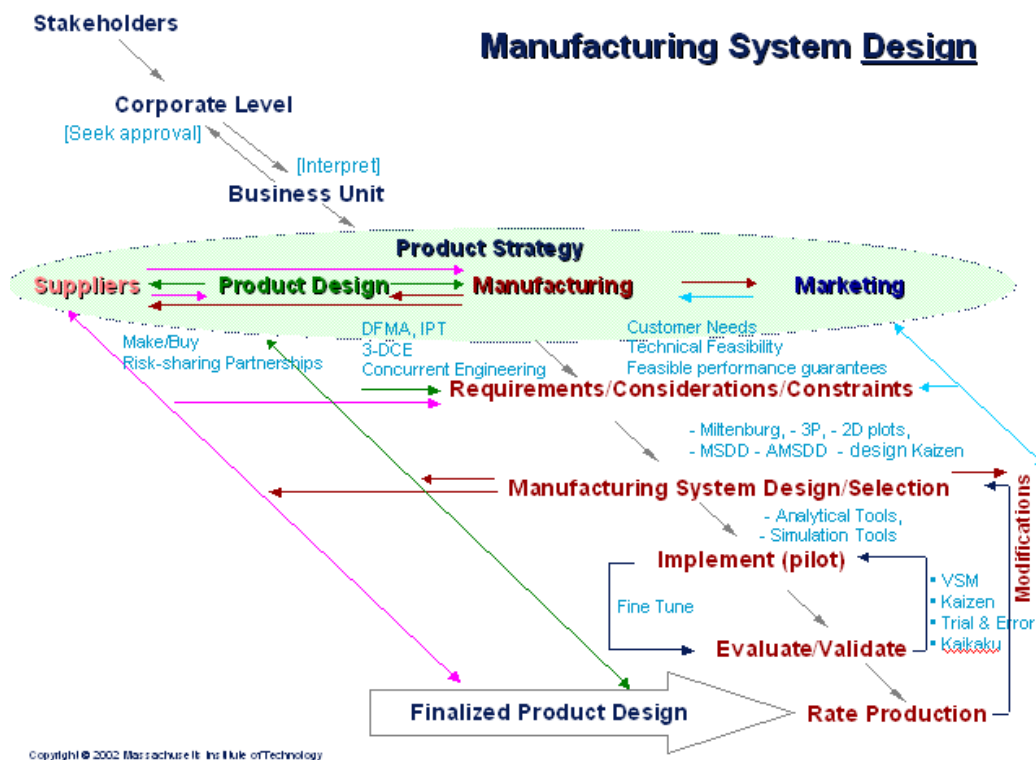

Figure 2-1 Manufacturing System Design Framework (Fernandes, 2001; Vaughn, 2002)

The research discussed in this document looks specifically at the factory operations and system design. The objective was to dig deep into one system design in an effort to understand the tools used to do system design and the possible roadblocks and areas of improvement. This study fits into the redesign/modification loop of the Manufacturing System Design Framework seen in Figure 2-1 with some time spent on determining the requirements, considerations, and constraints of the system design.

The other aspect of this research was to investigate one popular and successful design tool, VSM, and study its application. Value stream mapping can be seen listed on the chart within the improvement loop. The tool will be evaluated for its appropriateness at this level, and possible improvement opportunities for companies using VSM in their redesigns. The benchmarking of multiple companies using VSM will give insight into its use.

2.2 Manufacturing System

It is necessary to first define *manufacturing system* and then *manufacturing system design* as these are the main topics of this document.

In J T. Black's *A Factory with A Future*, a manufacturing system is defined as "a collection or arrangement of operations and processes used to make a desired product(s) or component(s). The manufacturing system includes the actual equipment composing the processes and the arrangement of those processes [and people]." Figure 2-2 explains this definition.

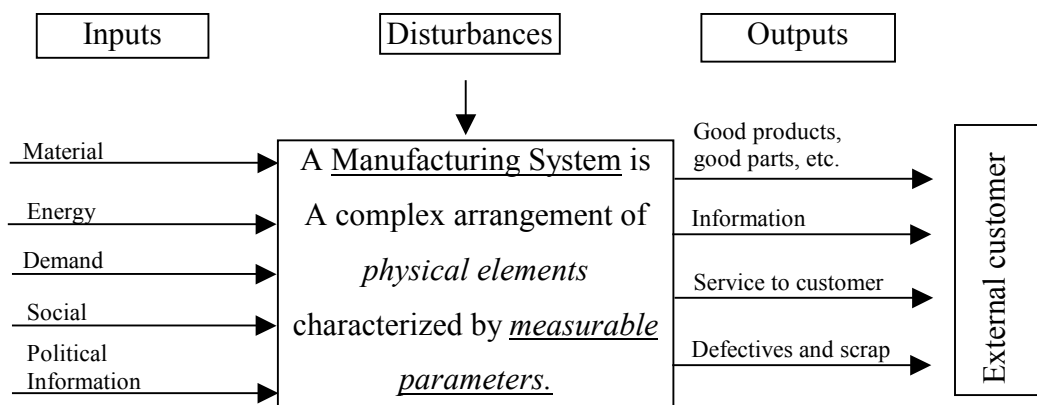

Figure 2-2 Definition of Manufacturing System (J T. Black, 1991)

The Manufacturing Systems Team believes manufacturing systems are larger than just the factory floor and includes all the organizations that can affect how the floor operates, along with the workers, suppliers, processes and management necessary to produce the chosen products. Through the work of the Manufacturing Systems Team of LAI the following definition of manufacturing systems has been presented:

A manufacturing system is an objective oriented network of people, entities, and processes that transform inputs into desired products and other outputs; all managed under an operating policy.

The underlines words are described below:

Objective: The ultimate objective of the manufacturing system should be to help satisfy corporate goals.

Entities: Machines, tools, floor space, software, transport equipment, suppliers, etc.

Inputs: Raw materials, energy, and information.

Outputs: Desired products, wasted materials, wasted energy, and knowledge.

Operating Policy: A set of rules that determine how people, system entities, and the processes are interconnected, added, removed, used and controlled.

This definition is an enhanced version of the definition that appears in *Factory Physics*, that was discussed and improved at the *Manufacturing System Industry Meeting, February 2001* and has been presented with discussion in *A Framework For A Strategy Driven Manufacturing System Design In An Aerospace Environment* written by Pradeep Fernandes.

2.3 Manufacturing System Design

Manufacturing system design consists of “not only physical hardware but also people who manage and operate this hardware and who must communicate information within the manufacturing system” (Cochran, 2000). The job of a manufacturing system designer includes making decisions about equipment selection, physical arrangement of

equipment, work design (manual and automatic), standardization, design of material, and information flow. Manufacturing system design is considered difficult because, unlike mechanical design, there is no ability to visualize the entire system at once since it is made up of physical hardware, people, and communications throughout the company's supply chain. (Cochran, 2000)

Currently, little information exists on manufacturing system design, although many authors who give bits of insight into the subject. *Factory Physics* attempts to describe manufacturing system behavior using fundamental relationships such as Little's Law and Economic Order Quantity. *Lean Thinking: Banish Waste and Create Wealth in your Corporation* describes the key principles of lean thinking necessary to guide actions to implement lean and includes specific examples of lean implementation. *Systematic Layout Planning*, a worksheet based book, gives a step-by-step plan for the design of a system, including worksheets. These three show the broad range of books that exist. Appendix A gives an outline of books related to manufacturing system design. This list represents some of the sources used in this research as well as others that the author has found useful.

Current research done on manufacturing system design attempts to determine the impact of the low level decisions on the manufacturing system objectives. Such work includes Hopp and Spearman's hierarchy of manufacturing objectives, Figure 2-3, which shows the necessary need for tradeoffs as conflicting low level objectives are determined from the same high level objective. Monden attempts a similar framework, by connecting the improvement tools of the Toyota Production System to higher-level goals; a copy of this framework is located in Chapter 7. Cochran's *Manufacturing System Design Decomposition* attempts to "communicate how low level design decisions will affect performance" through a decomposition of the high level objective, return on investment, into the lower level functional requirements necessary to achieve it. Through the use of axiomatic design, Cochran develops a matrix type chart, which includes the relationships between his requirements, not only to higher-level objectives but also to each other.

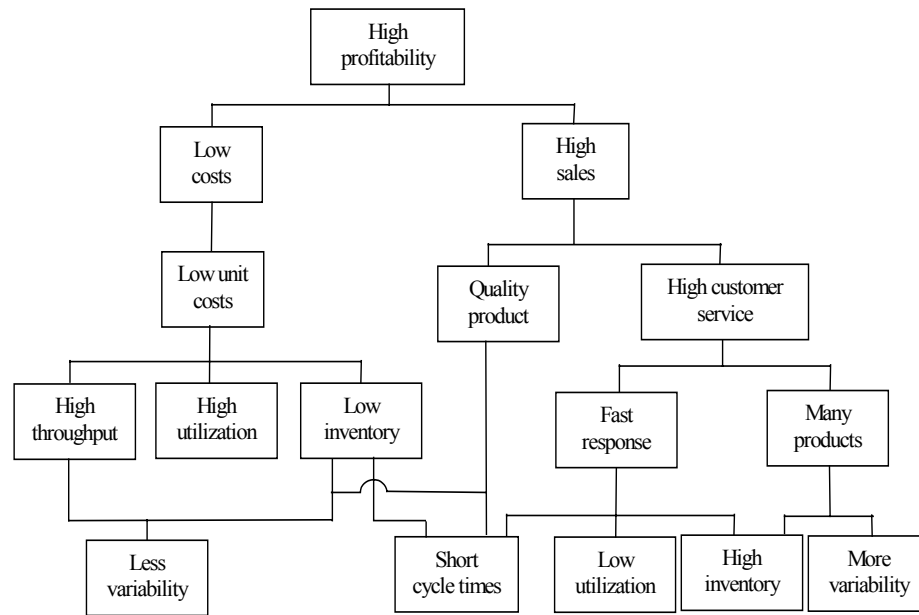

Figure 2-3 Hierarchy of System Objectives (Hopp & Spearman, 1996)

Although there are many books on manufacturing system design, it is not currently considered a science. The definition of a science is a “department of systematized knowledge as an object of study (Merriam-Webster, 2002).” The knowledge base around manufacturing systems cannot yet be considered systematized, as we have no scientific method for determining the optimal system design or considering tradeoffs. And the information that exists is in many cases only part of the entire issue. In many ways manufacturing system design can be considered an art “a skill acquired by experience, study or observation (Merriam-Webster, 2002).” The LAI Manufacturing Systems Team attempts to aid in converting this art into to a science, as all of the authors mentioned have done, through systematic research, which continues to shape and broaden our understanding and construction of principles to guide us.

In many cases the examples discussed in this document can be considered *system redesigns*. A system redesign can be defined as the production of a system design for an area that already produces products. In some cases, a redesign might include simple, low cost reorganization of workers, slightly higher cost options such as reorganization of machines or products, or total redesign, which includes the purchase of new equipment and change in system type.

References

Black, J T. *The Design of the Factory with a Future*. New York: McGraw-Hill. 1991

Cochran, David S., Jorge F. Arinez, James W. Duda, Joachim Linck. "Decomposition Approach for Manufacturing System Design." A Collection of Papers Published by Professor David S. Cochran. MIT. September 2000.

Crabill, John, et al. "Production Operations Level Transition-To-Lean Roadmap Description Manual." MIT. June 2000. <<http://lean.mit.edu>>.

Fernandes, Pradeep. "A Framework for a Strategy Driven Manufacturing System Design in an Aerospace Environment - Design Beyond Factory Floor." Masters Thesis. MIT. Cambridge, 2001.

Fernandes, Pradeep. "Manufacturing System Design Framework." *Manufacturing Systems Team Meeting*. Gilbert, Arizona. February 2001. <<http://lean.mit.edu>>.

Hopp, Wallace J. and Mark L. Spearman. *Factory Physics: Foundations of Manufacturing Management*. Boston: Irwin, 1996.

Lean Aerospace Initiative. MIT. 2001. <<http://lean.mit.edu>>.

Merriam-Webster's Collegiate Dictionary, Merriam-Webster Online, 2002. <<http://www.m-w.com/home.htm>>.

Monden, Yasuhiro. *Toyota Production System: An Integrated Approach to Just-In-Time*, Norcross, GA: Engineering and Management Press, 1998.

Murman, Earll et al. *Lean Enterprise Value*. New York: Palgrave Publishers Ltd., 2002.

Vaughn, Amanda. "A Holistic Approach to the Design of Assembly Operations in the Defense Aerospace Industry," Masters Thesis. MIT. Cambridge, 2002.

PART ONE

IN-DEPTH CASE STUDY

In order to better understand the methodology of manufacturing system design, including problems and barriers, an in-depth case study will be explored. By completing a manufacturing system design, parts of the manufacturing system design framework can be investigated in more detail. Chapter 3 will first look at the necessary background for this case study with a description of the methodology used in completing the design. Chapter 4 will then describe in detail the analysis of the Flexible Manufacturing System at Heidelberg Web Systems, Inc. and Chapter 5 will present in detail the design of the future system.

Chapter 3 Methodology for Manufacturing System Design - Case Study

This chapter describes the Manufacturing System Design Framework created by LAI in more detail. A detailed discussion of *Miltenburg's Manufacturing Worksheet* will also be conducted to further understand the background used in the following case study. The details of this worksheet were used extensively in developing the new system design and, therefore, need greater explanation. The final section will outline the methodology used in the case study described in Chapter 4 and 5.

3.1 Manufacturing System Design Framework

The Manufacturing System Design Framework, designed by the Manufacturing Systems Team of LAI, can be seen in Figure 3-1. The framework demonstrates the importance of the manufacturing system within the corporation and the corporate objectives. Past research has shown manufacturing system design limited to the factory floor. Within the framework it is discussed from a strategy driven systems point of view. It is believed that in mature industries (with dominant product designs), including the aerospace industry, manufacturing is the necessary competitive weapon for success. It is, therefore, necessary to have a manufacturing system based on a product strategy. The framework shows the stakeholders, executive management and middle management, as part of the decision making body that determines the product strategy. The product design strategy is a coherent plan determined by all of the core competencies of the company that coordinates the link between manufacturing and the rest of the enterprise. Major components include suppliers, product design, manufacturing and marketing. After the completion of the product strategy, also known as the infrastructural design, the structural design may take place. This includes the detailed design of the factory floor. The framework also recommends existing design tools and the level at which they make the most appropriate contribution. (Fernandes, 2001)

The case study corresponds to the modification loop shown in Figure 3-1. It was found necessary to redefine the requirements, considerations, and constraints in order to use the tools shown to aid manufacturing system design and selection. Discussions

include use of some of the tools identified in the diagram, including Miltenburg, 2D plots, simulation tools, and value stream mapping.

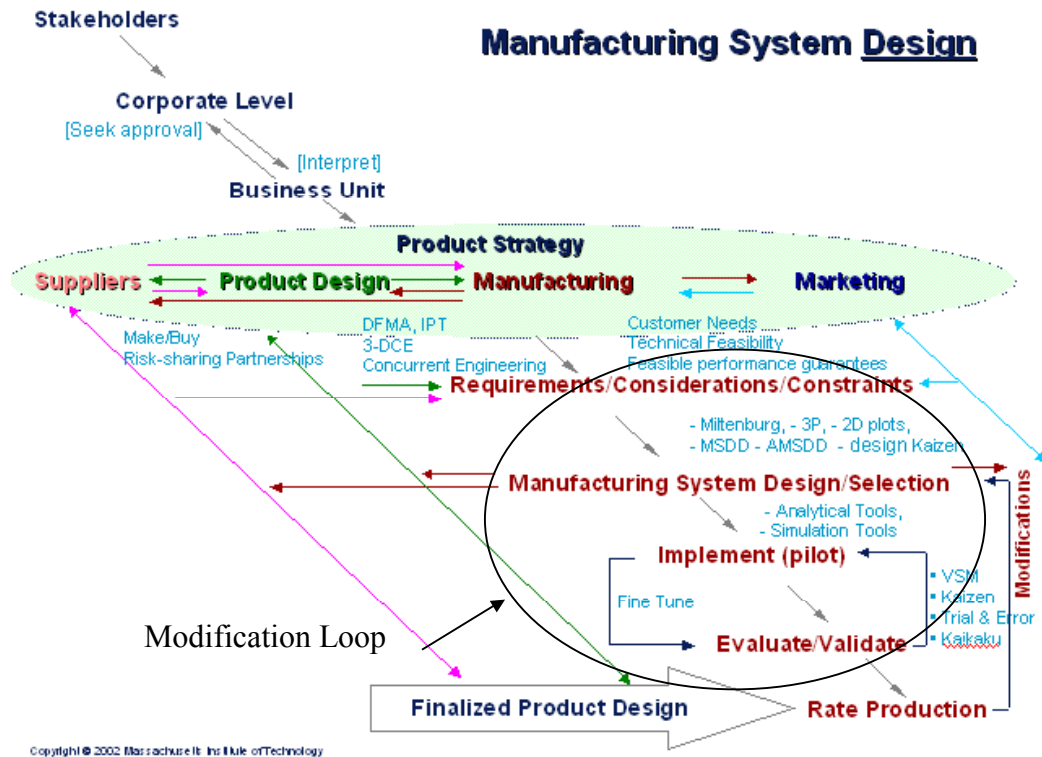

Figure 3-1 Manufacturing System Design Framework (Fernandes, 2001; Vaughn, 2002)

3.2 Manufacturing Strategy by Miltenburg

This case study uses many of the components of the methodology developed by John Miltenburg and shown in *Manufacturing Strategy*. He shows a systematic method for evaluating the optimal production system based on the system goals. This methodology provides a step-by-step approach to system selection decisions and required infrastructure improvement.

What makes Miltenburg's methodology unique is his use of multiple elements to make a manufacturing system selection determination. The Miltenburg chart compares the production system not only in terms of product structure (volume and mix) and process structure (functional, cellular, line), but does an effective job of distinguishing

each system's ability to meet the six different manufacturing goals (delivery, cost, quality, performance, flexibility, and innovativeness).

The methodology goes on to discuss six manufacturing levers (human resources, organization structure, sourcing, production planning, process technology, and facilities) that can be adjusted to make the necessary infrastructure improvements. Miltenburg's methodology is compiled in the worksheet shown in Figure 3-2. The worksheet will be used in Chapter 5 to determine the appropriate production system.

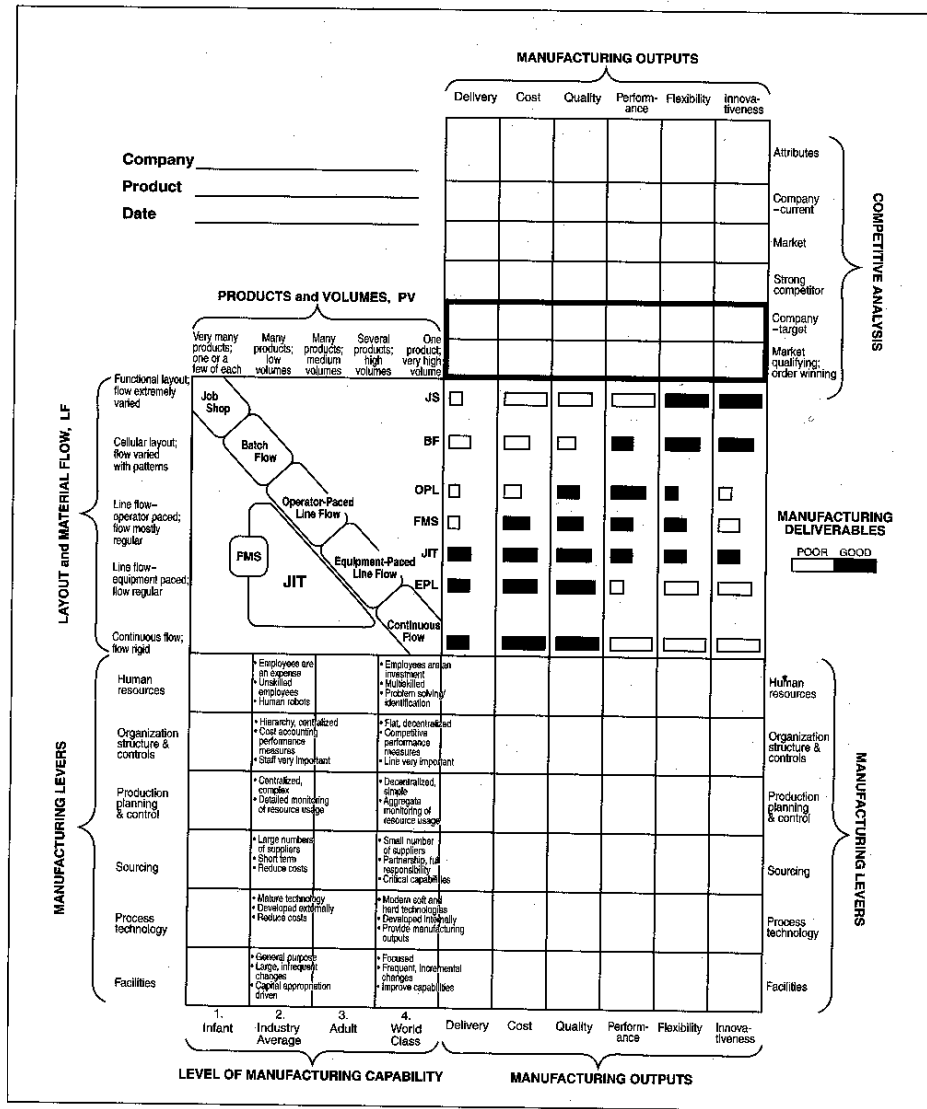

Figure 3-2 Miltenburg's Manufacturing Strategy Worksheet (Miltenburg, 1995)

The steps of the Miltenburg methodology using the worksheet are as follows:

Where am I?

- Determine current location in terms of product and process structure.
- Assess current level of capability for each manufacturing lever.

Where do I want to be?

- Determine market qualifying and order winning outputs that must be provided.
- Determine the production system that best provides the manufacturing outputs.

How will I get there?

- Adjust the manufacturing levers to provide the outputs at target levels.

The worksheet encourages selection of a system based on strategy and market requirements and, therefore, promotes organized, systematic decision making in manufacturing system design.

(Miltenburg, 1995)

3.3 Case Study Methodology

The system design methodology used in the following case study is shown in Figure 3-3. The main principles underlying these steps are similar to those of Miltenburg's Manufacturing Worksheet. The methodology is explained here as a simplification of the total system design. The reader can compare his current method to the one outlined here, and used in Chapters 4 and 5, to improve his own process.

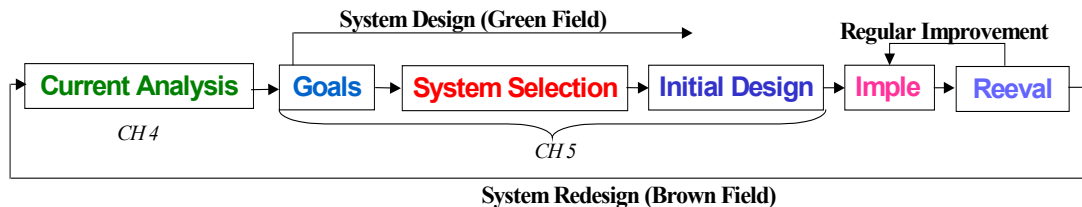

Figure 3-3 Generalized Methodology for System Design

The four main steps are: (1) current system analysis, (2) system goals, (3) system selection, and (4) initial design. Implementation and revaluation were not explored in this research.

1. **Current Analysis**-includes an investigation into the root causes of system problems and determination that a system redesign is necessary.
2. **System Goals**-attempts to quantify the parameters provided to the customer, as these will be the main system selection criteria.
3. **System Selection**-determines the type of production system that is appropriate. The type of production system chosen will determine those system goals that will be provided at the highest levels.
4. **Initial design**-includes determination of specific machine types, operator job descriptions and priorities, and possible effects on infrastructural groups.

The determination of goals and system selection steps are developed from Miltenburg's Manufacturing Strategy Worksheet with insertion of additional tools. Initial design uses the ideas of structural and infrastructural elements from Miltenburg but goes beyond the detail given in the book. Additional detail on this generalized methodology, used in this case study, can be found in Appendix B, and including the questions asked within each section.

References

Fernandes, Pradeep. "A Framework for a Strategy Driven Manufacturing System Design in an Aerospace Environment - Design Beyond Factory Floor." Masters Thesis. MIT. Cambridge, 2001.

Miltenburg, John. *Manufacturing Strategy: How to Formulate and Implement a Winning Plan*. Portland: Productivity Press, 1995.

Chapter 4 Case Study Current System Analysis

This chapter will present the analysis of the current system at Heidelberg Web Systems, Inc. The analysis includes a study of utilization in order to determine improvement opportunities. A discussion of both system flexibility and machinist responsibilities will also be included in order to determine the root cause of system faults. Improvement opportunities for the current system will be described and overarching themes will be determined. The information acquired here will be used also in Chapter 5 the future system design.

4.1 Case Study Background

Heidelberg Web Systems, Inc. is a subsidiary of Heidelberger Druckmaschinen AG, a German headquartered printing press company. The group has 18 sites worldwide used to produce their solutions including all steps of the process: prepress, press, and postpress. Heidelberg Web Systems, Inc. is one division of Heidelberg whose main product solutions are in the web offset regime, including commercial web offset and newspaper web offset. A web solution is one that produces product from a roll, or web, of paper that is then cut and folded during postpress, as opposed to printing directly onto sheets of paper. The company is a leader in its field of manufacturing printing presses that are highly reliable products with innovative features. The division of Heidelberg Web Systems studied here fabricates parts for the presses for assembly. (Heidelberg, 2002)

Heidelberg Web Systems asked MIT to study its MAXIM cell, a five horizontal milling machine system with an automated rover. The current system can be seen in Figure 4-1, and it includes five machines, three setup stations, and four machinists. An automated pallet changer is used to move the parts from the setup station to the machines. The cell is running three shifts a day. Two of the machinists work at the setup stations and two at the machines. There are approximately 2,000 active part types in the cell, 811 of these were produced in 1999. Of the 811, 30% were new parts that year. The average production of the system is 5.9 parts/hour or slightly more than one part per machine per hour.

The cell can be considered a Flexible Manufacturing System (FMS). FMS's are known for their ability to run unattended for long periods of time. The systems are usually made up of computer controlled machinery (horizontal mills) and automatic parts delivery systems (rover). The computer controlled machinery allows production of many different, and sometimes complex, parts on the same machinery. The mill can be used to drill, mill, hog, shape, cut and finish a part through the use of many different tools. In a horizontal mill the spindle is turning parallel to the ground and has the ability to move up/down, left/right, and into the piece which is usually held perpendicular to the ground.

The cell is currently not producing the number of standard hours (similar to number of parts produced) that were envisioned by the company. A relationship will be found between machine utilization and product lot size. An attempt will be made to determine root cause of utilization decrease by association with setup, cycle time variation, and other factors.

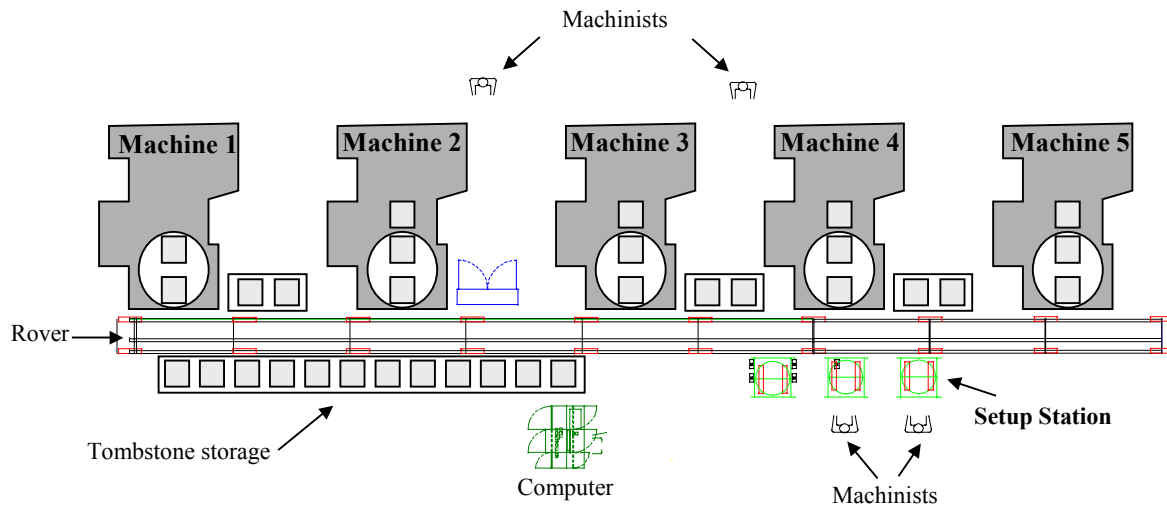

Figure 4-1 Heidelberg Maxim Cell

Heidelberg determined that a study of the MAXIM cell was necessary due to a large drop in the productivity of the machines in Fiscal Year 2000, which corresponded to the addition of a new product to their line. This trend can be seen in Figure 4-2.

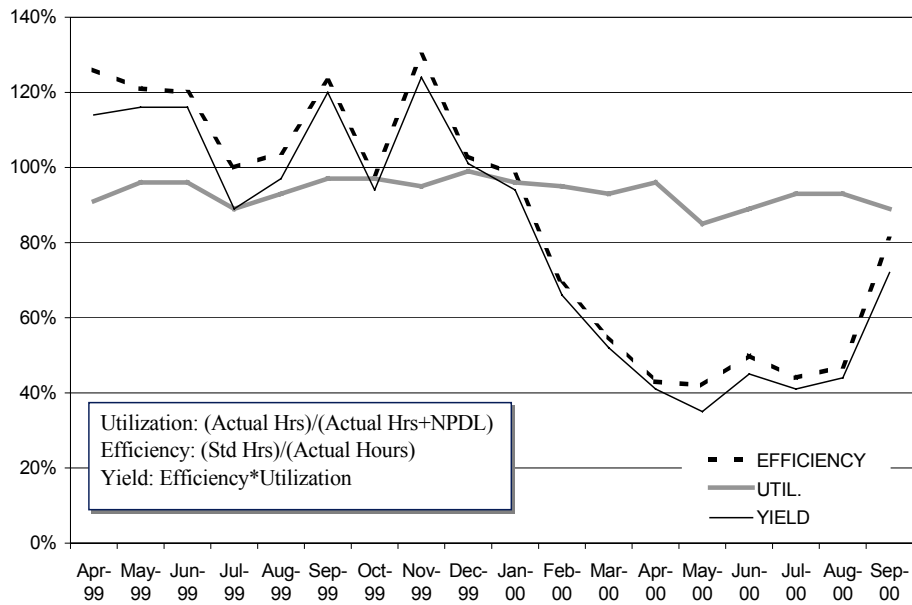

Figure 4-2 System Data Leading to Study

4.2 Characterization of the Problem

The following analysis will show a relationship between utilization of the machines (similar to spindle uptime), and product lot size. It will also be shown that this decrease in utilization can be attributed to multiple factors and developed into improvement opportunities.

In this analysis, utilization has been defined as spindle uptime as compared to available time. Because the Maxim Cell runs on three shifts, the available time is considered twenty-four hours a day, five days a week. Spindle uptime is the amount of time the machine is working on a part.

$$\text{Utilization} = \frac{\text{Spindle Uptime}}{\text{AvailableTime}}$$

Spindle uptime for a lot of N parts and a cycle time of T per part,

$$\text{Spindle Uptime} = NT .$$

Using data acquired from the cell’s computer system (Cincron) to estimate spindle uptime and product lot size, we were able to compile the following graph of utilization compared to lot size, which shows that there is a strong correlation.

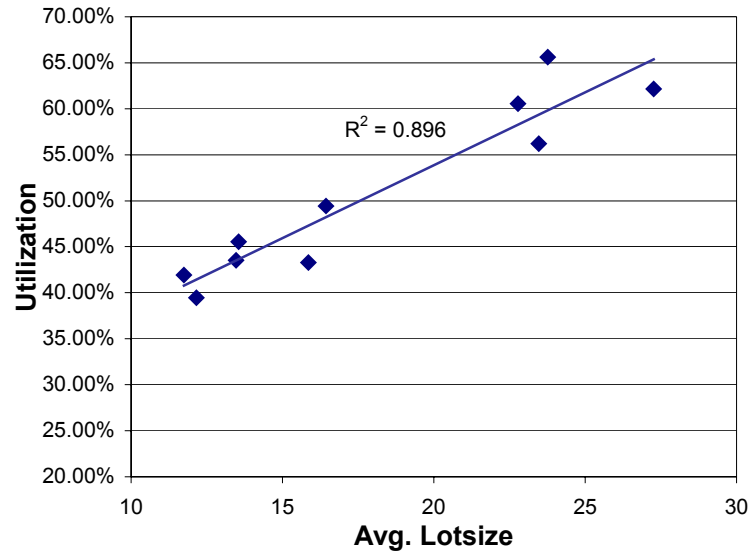

Figure 4-3 Utilization vs. Lot Size

Using the data from the Cincron (1997-1998), we are able to separate available time into three categories: spindle uptime, NT, internal setup time, S, and Other Factors, OF,

$$\text{AvailableTime} = S + NT + OF.$$

Using spindle uptime as compared to available time for utilization above, assumes all spindle uptime is productive time, that no time is wasted when the spindle is turning. In the case of the current system, the computer system only records when a program starts and when a program stops. Therefore, there is a chance that the machine could have stopped during a program due to a system fault and this would still be considered as “spindle uptime.” In order to estimate this difference, the cycle time of individual runs of the same part were compared looking for deviations from the minimum. Consequently, the addition of the variation in time, dT , has been separated from NT. A comparison of the “spindle uptime utilization” and the “productive uptime utilization” can be seen in the figure. There is a large gap between what was perceived as productive time for the system and what actually is.

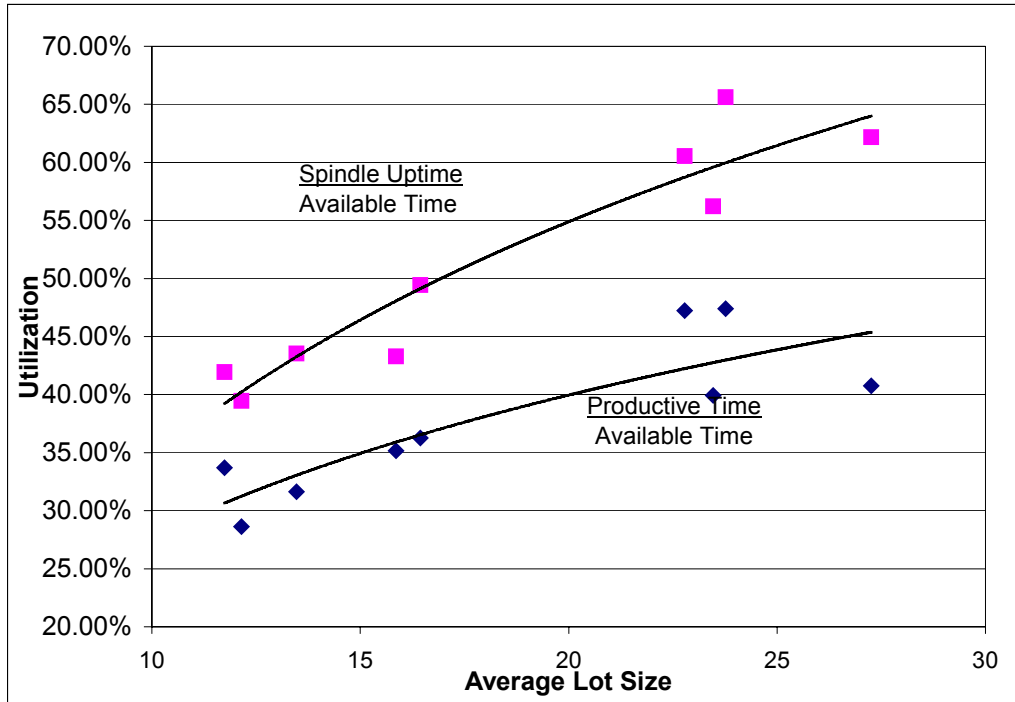

Figure 4-4 Spindle Uptime compared to Productive Time

Using the new definition of available time, utilization becomes:

$$\text{Utilization} = \frac{NT_{\text{prod}}}{S + N(T_{\text{prod}} + dT) + OF}$$

It can be seen from this formula that as lot size is changed, there will be a change in utilization. If NT is large, then this ratio approximates one since S and OF are small in comparison, but as NT is reduced, S and OF become larger and the ratio approaches zero. This change in lot size causes a change in the number of setups necessary to produce the same number of total parts; therefore utilization decreases with smaller lot sizes.

Using the Cincron data we were able to take the utilization formula and, assuming 100% improvement in each of these factors individually, see the difference it would make on productivity. Therefore S , OF , and dT have each been independently eliminated (reduced to zero) and graphed to see the impact on utilization. It can be observed in Figure 4-5 that Other Factors is the biggest area for improvement. It is necessary to determine what makes up Other Factors in order to determine improvement methods. It can be observed in Figure 4-5 that with an improvement or elimination of Other Factors, the curve levels off and would, therefore, have a more predictable and even response.

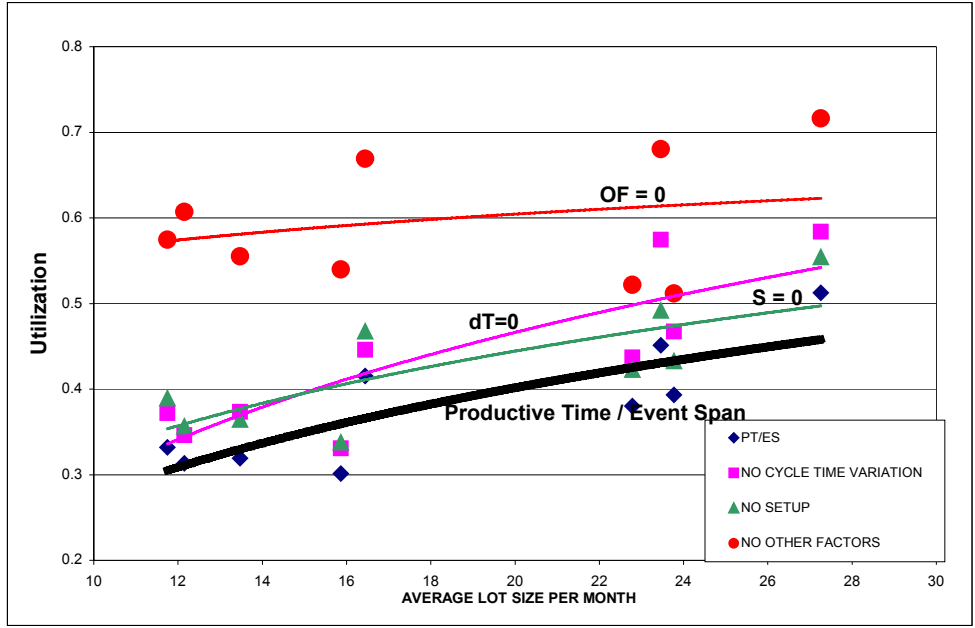

Figure 4-5 Effects of Setup, Variation in Cycle Time, and Other Factors on System Utilization

4.3 Pie Chart Data

The trends obtained from the cell controller data were not able to provide information about root cause. A more in-depth understanding is necessary to determine how to improve the system. Figure 4-6 shows the data, which was obtained in 1997 by human observation and note taking at two machines for 208 hours. This data separates S, OF, and dT into more categories and quantifies them.

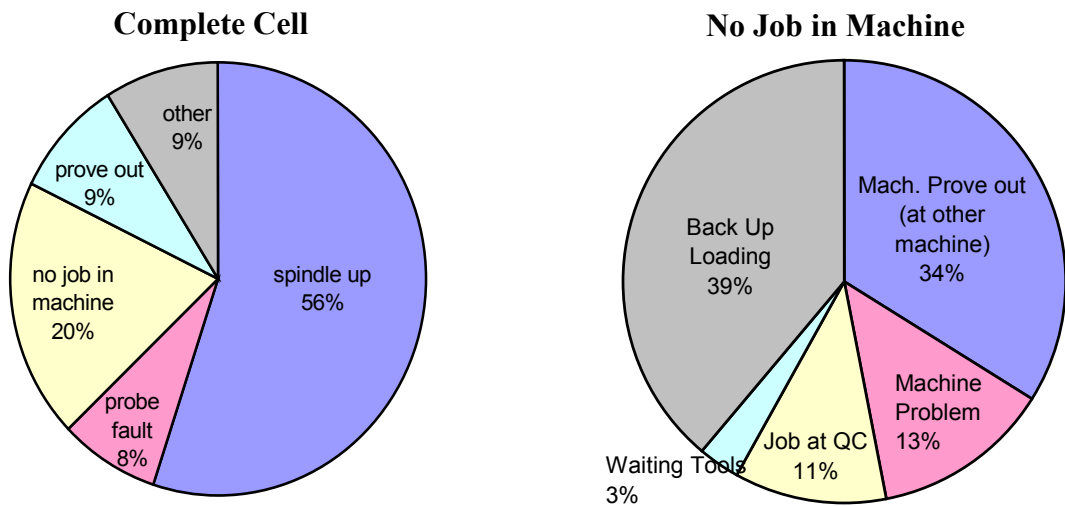

Figure 4-6 Pie Chart Data Obtained in 1997

Setup

In the case of the cell, much of the setup, including the setup of fixtures, and changing of parts, can be done externally, and therefore, is not included in the estimation of setup time.

The internal setup is made up of:

- Tool change - time required to swap tools from previous jobs with those for next job.
- Load program - retrieval of the program from the mainframe computer to the individual machine.
- Prove out - the machinist checks the program's functionality during the first part.

Variation in Cycle Time

Variation in part cycle time, as discussed, is largely made up of probe faults. These occur when the program calls for the checking of a dimension using an automated probe and the dimension is determined unsatisfactory by the machine. The machine then stops and awaits the machinist's approval. Therefore, this is the cause of a large variation in operator availability.

Other Factors

Other Factors, the total makeup of which is not known, was estimated by subtracting setup, productive time and variation in cycle time from total available time. Using the observations, Other Factors include:

- Machine problems – machine maintenance
- Job at quality control – determination of satisfactory dimensions by a separate group
- Machine awaiting tools from preset – necessary for current job
- Backup loading - internal resource unavailability, includes not enough tombstones or space in tool cartridge to run jobs
- Other - lunch, meeting, edit program

4.4 Improvement Opportunities

In the table below suggestions for improvements to each part of Other Factors, setup and variation in part cycle time, are listed and corresponded with the appropriate factor they will affect. This list contains improvements that can be made to the current system that will also affect any future system put in place.

Other Factors	Backup loading	Scheduling of resources
		Purchase of additional resources
		Simplify system
		Focus resources by families of parts
	Operator at other machine prove out	Standardize procedures for parts will reduce prove out time
		Have programmer at prove out for quicker response
		Separate immature jobs from mature jobs so as not to affect production
	Machine Problem	Initiate program of preventive maintenance
		Assign clear responsibilities
		Find root cause to prevent repetitive problems
	Job at QC	Make QC available
		Improve quality of parts produced
Waiting on Tooling	<i>Similar to Backup loading</i>	
Variation in cycle time	Machine stops	Fix root cause (probe fault) of repetitive errors
	Waits for attention	Make visible so machinist knows the problem
		Free up operator to deal better with problems
Needs action	Make resources available so problems can be quickly fixed	
Setup	Prove out	Standardize procedures
		Have programmer at prove out
		Separate activity from rest of jobs (mature versus immature)
	Tool Change	Externalize as much as possible
		Reduce number of tools required
Load Program	Standardize procedures	

Table 4-1 Improvements within Other Factors, Variation in Cycle Time and Setup

The underlying principle of the system redesign includes simplification of the system in order to solve problems caused by system flexibility. This simplification involves the focusing of resources including the machinist, tools, and machine, to particular part families. This will help to identify root cause and standardize procedures. Other ways to simplify the system include separation of prove out from production parts,

by assigning a machinist and a developmental machine to do this task, so as not to allow production parts to be delayed by the long prove outs of immature parts.

The machinist matrix, Figure 4-7, shows that the operator is the necessary resource to deal with all problems. Due to constant disruptions they have neither the time nor the ability to improve root cause. It is necessary to reduce the need for the operator by reducing disruptions or add an operator so these problems can be dealt with more quickly. The more free time he has, the more he can be dealing with improvements to the system. It is necessary for the operator to have clear responsibilities within the system so as to use his time more efficiently.

Necessary Resources for Repair

Reasons for Machine Down	Pre-set	Engineer	Program	QC	Maint	Machinist	Tombstone	Tool cart	Machine
	Backup Load					X	X	X	
	Mach. Prove Out		X			X			X
	Machine Problem					X			X
	Job at QC				X	X			
	Waiting Tods	X					X		

External
Internal

Figure 4-7 Machinist Matrix

4.5 Analysis of Current System

A major theme seen in this analysis is flexibility. Flexibility can hinder improvements in productivity. In this case, the increased flexibility has led to the machinists being overloaded by many small and disruptive tasks, which make improvement to the system difficult.

The system employed in this case study allows complete flexibility in part production by using generic horizontal milling machines. Because of flexibility in the machines and in the operations, it is the job of the programming department to determine a process plan and, within the process plan, the order of operations. This lack of standardization allows the programmers to produce programs using different methods.

This can lead to the use of different tooling on similar parts, as well as different feeds, speeds and tool paths.

Due to the multiple types of materials and different types of possible cuts, it is possible for a tool to wear unevenly. This uneven wear may affect its ability to produce as expected on the next job. This flexibility in tooling contributes to the inability to use the machines in an autonomous way. The machines are frequently in need of the attention of the operator because of measurement errors, torque overloads, and other types of probe faults, which can be caused by tool issues.

This flexibility is increased by the lack of machine, or product, ownership by the machinists. No learning occurs from common parts and repetitive errors are not recognized. Because of the constant interruptions caused by the system flexibility, the machinists are overloaded. As was seen in the Figure 4-7, all problems and machine stoppages require the machinist to attend to the machine. This causes continuous delays and exceptions to the machinist's required work pattern. This constant chaos also results in minimal documentation and, therefore, poor resolution of the problems and determination of root cause.

As a result of the flexibility of the system, the relationship between other departments and the cell are not standard and, therefore, bring about varying quality of the inputs into the system. These inputs include: tool selection, tool paths (programs), tool sharpness, quality control, and maintenance speed and reliability. Because of the large variation in parts that go through the system, and the large influx of new parts, operating with a certain measure of decreased flexibility is the only way to stabilize the system. This can be done by considering part families, a method by which standardization can occur, and separation of machinery to allow dedication of workers to machines, allowing quicker root cause analysis of problems.

4.6 Conclusions

It was difficult to determine root cause in this system; this is believed to be an inherent problem built into Flexible Manufacturing Systems. The CNC machines allow the running of multiple jobs on a machine at one time, causing the inability to directly assign fault of a machine breakdown to one part. Machines connected with a shared

resource, such as a rover, allow shared responsibility by machinists, which can lead to problems identifying repetitive errors. Due to the system construction it is difficult to study the machinist's work pattern, as many of his responsibilities cannot be measured.

The underlying principles for improvement that can be seen in the utilization analysis include simplified flow, focused resources and standardization of work. Simplified flow will allow for more focused attention on a job, quick response to problems and better determination of root cause. By focusing resources they can be more clearly assigned to part families and, therefore, cut down on flexibility. Standardization of work for the machinist will allow him to better deal with his assigned duties and quickly resolve problems. Standardization of parts and part families will allow quicker prove out time and fewer probe faults because of thoroughly tested part methods. Each of these areas is necessary to make the system more productive and manageable.

Utilization of machine was investigated in an effort to improve productivity of the cell. Studying machine utilization has led to insights about machinist responsibilities. It was determined that the machinist was overloaded with small disruptive tasks, due to machine quality problems, and in order to improve productivity these disruptions must be reduced.

In some cases, it is believed that utilization is not the appropriate factor to employ in order to improve the system. High utilization usually necessitates high inventory and large lead-time. In the current system utilization is the most reliable information that could be obtained from the system. The system is also not able to produce all required parts causing Heidelberg to outsource parts. Therefore, utilization is still the most important measure since it is directly related to productivity of the system.

References

Heidelberg. Heidelberger Druckmaschinen AG. 2002 <<http://www.heidelberg.com/>>

Chapter 5 Case Study System Redesign

In this chapter we focus on a new design for Heidelberg's Maxim Cell. Many of our insights for the new design are drawn from the analysis of the current system in Chapter 4.

Summary of Chapter 4 findings:

1. Total standard production hours strongly correlate with lot size- A relationship between the cell utilization and lot size was seen by analysis of the cell data.
2. Small lot sizes increase demands on machinists - As lot size decreases, production time decreases and setup and other factors become more frequent.
3. Enormous variability in part types and lot sizes make it difficult to plan standard work – Unexpected machine failures cause volatility in machinists' tasks.
4. All tasks that reduce machine efficiency occupy the machinist - A matrix of machine failures and their necessary resources show a correlation between the need for the machinist and any type of breakdown.

This section will be a review the competitive goals determined by Heidelberg, followed by an analysis of a benchmarking exercise to compare multiple sites, all using similar Flexible Manufacturing Systems. Miltenburg's *Manufacturing Strategy Worksheet* will also be used, including its implications on future system design. This will be followed by a description of the system recommendations and a simulation used to validate the recommendations.

5.1 Competitive Goals

The competitive goals of the manufacturing system chosen for the redesign were to increase *productivity* while retaining *flexibility* and making the system *manageable* and *reliable*.

Productivity – Ability to produce a certain number of parts within a time period. It can be measured as standard hours of parts produced, or utilization.

Flexibility – Ability to successfully respond to variation mostly in parts related parameters (implies variation within an expected range that can be handled as routine).

Possible measures of flexibility include: production volume, lot size, parts variety (predefined), and quickness of introduction of newly developed parts.

Manageability – Ability to handle infrequent events that require redirection of resources. Implies that intervention of management is required, hence, beyond the usual range of variation, often applies to problems with resources and infrastructure, as well as large changes in parts parameters.

Reliability – Elimination of variability in machines, work tasks and support response.

5.2 Benchmarking

5.2.1 A Case Study Analysis of Flexible Manufacturing Systems

In order to study under what conditions a FMS Horizontal Machining Cell would perform best; we visited two companies with the same FMS as Heidelberg. The results show a higher satisfaction with the FSM at the two companies visited. The main difference was in the characteristics of products produced. In Site 2, the small part type count has been exploited to not only improve utilization, but to allow for a low machinist to machine ratio, as well. Table 5-1 is a summary of the different system characteristics for the three sites.

	Heidelberg	Site 2	Site 3
Machines	5	6	2
Machinists/Shift	4	2	2
Programmers	5	1	1
Part Types	2000	9	200
Part Types/Year	811	9	--
New Part Types/Year	~240	2	6-12
Average Part Runtime	22min	5hours	23min
Material Types	8	1	2
Parts/Hour	5.9	0.317	2.65
Total Produced/Year	35,000	1716	10,000
Utilization	44%	70%-80%	System meets capacity goals

Table 5-1 Benchmarking System Characteristics Summary

History of Benchmarked Systems

Site 2 started the cell six years ago with the introduction of two 4-axis machining centers. After that, two more machines were added in 1996 and then the last two were added in 1999. All of the parts that are completed by the cell are titanium forgings. An FMS system was used because of the complex part and part fixturing, long processing time, and high necessary tolerances. There are other machining cells and machining centers within the facility. These centers are producing parts of similar complexity and volume, but made of different materials. The current system has two setup stations, but only one is primarily used. From this station, four of the machines are easily accessible without long walking distances. Due to a low percentage of new parts a year, the system runs smoothly with only one programmer and two machinists per shift for six machines.

Site 3 used the FMS cell to replace two of six, older stand-alone Hydrotell machines, approximately five years ago. They were replaced by the two machines that make up the FMS, in order to increase capacity as well as by a conscious decision to improve technology within the factory. There are still four of the older machines in the factory. Most parts in the cell are produced from aluminum plate; some are from aluminum forgings. The cell makes medium sized parts, the four older machines produce larger parts, and a Tsugami machining center is used to produce parts of smaller size. The goal of the current system is not high utilization; it is a system to produce the necessary parts. Two machinists and one programmer manage the two-machine system. In some cases of large fluctuation of new parts into the system, more programmers have been known to participate.

System Characteristics at Heidelberg

Heidelberg has a considerably larger number of new parts per year than Sites 2 and 3 (almost one every day). This increases the necessary number of programmers for the system and inhibits the system from reaching a steady state production mode. In comparison, at Site 2, because of the low frequency of new parts, the programs can become mature and error free, allowing the machinist to gain the benefit of the machine's ability to run autonomously.

At Site 2, the number of workers to machines was greatly improved over a one-man one-machine situation, with two workers running six machines. The major factor that caused this large improvement over the other systems is the low total product mix and longer cycle times. The benefit of the low product mix is that the fixtures do not come off of the tombstones, allowing for essentially one-piece flow as internal setup is eliminated.

Summary

In the case of Site 2 and Site 3, the product mix and frequency of new parts fits the system requirements better. Site 2 is the only one with a large savings in labor, with two machinists running six machines. Site 3 does not acquire this savings, with two machinists for two machines because of a lower total volume and, perhaps, part complexity.

To improve the Heidelberg system requires a reorganization of resource management. In both Site 2 and Site 3 there is only one programmer. This eliminates much of the need for standardized programs, tooling, and procedures. In Heidelberg, with five programmers and four machinists, there is a necessity to improve information transfer and success of new programs by implementing standards and procedural guides.

An FMS may not be the most effective system to meet Heidelberg's needs: large mix, large frequency of new parts, and short cycle times. The following chart, taken from *A Factory with a Future* by J T. Black, has been used to visually compare the three systems studied. It shows that in order to more closely match the attributes of the FMS system, Heidelberg must reduce part variation to the system. In Heidelberg, the current system equipment is an FMS but the current part characteristics (mix and volume) place the production in the job shop regime. This shows the mismatch between the system and the system parameters. Included also on the chart are the two other systems compared to Heidelberg. In order to more closely match the attributes of the FMS system, Heidelberg must reduce part variation to the system and move into the regimes that the other systems are currently in.

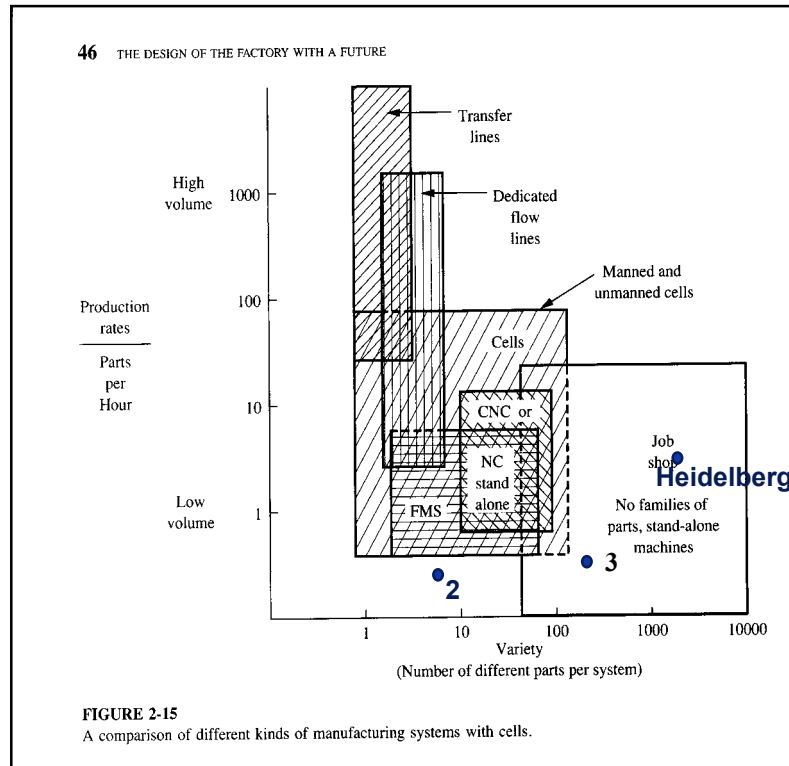

Figure 5-1 Comparison of Different Types of Manufacturing Systems (Black, 1991)

5.2.2 Lean Aerospace Initiative’s Flow Efficiency

The Lean Aerospace Initiative of MIT was able to acquire a measure of flow efficiency for a variety of manufacturing systems. This data can be used to benchmark the current system. Flow efficiency is the ratio of actual or “value added” production time of one part to the total lead-time of the batch. To determine the following efficiency of the cell an average production time was calculated which is the average time for any part that is produced to spend in the machine. The lead time of the batch is the time from initiation of the first part into the cell to completion of the last part of the batch. Figure 5-2 shows that in order to increase flow efficiency, or increase the productive time ratio, it is necessary to leave the job shop regime and enter the flow shop one. (Shields, 1996)

$$FlowEfficiency = \frac{Avg. Prod Time}{Lead Time} = \frac{0.67hrs}{48hrs} = 0.014$$

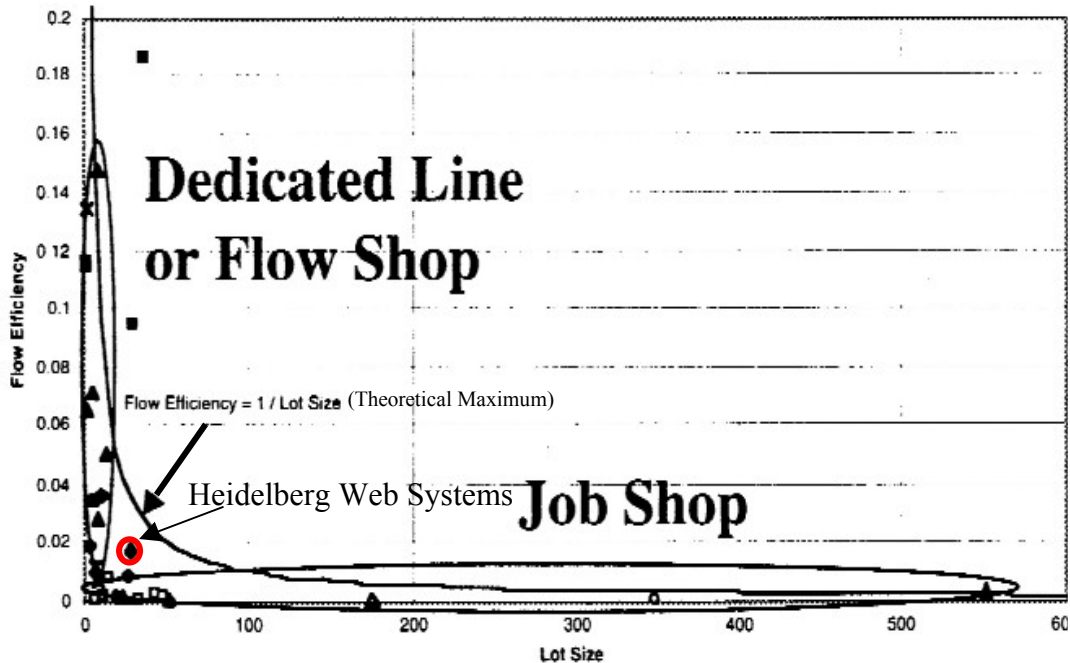

Figure 5-2 Flow Shop and Job Shop regimes on a Flow Efficiency Plot (Shields, 1996)

5.3 Redesign Methodology

In this section we follow a methodology taken from *Manufacturing Strategy* by John Miltenburg. A summary of the results from the analysis are presented here.

5.3.1 Miltenburg's Manufacturing Strategy Worksheet

The essence of Miltenburg's approach to manufacturing system design is summarized in a single worksheet which allows one to go from system goals, to manufacturing system types, to the required infrastructure improvements (called manufacturing levers by Miltenburg). The core of this worksheet, which is reproduced in Figure 5-3, allows one to go from manufacturing output requirements to manufacturing system types. According to Miltenburg "manufacturing provides six manufacturing outputs; cost, quality, flexibility, performance, delivery and innovativeness-to its customers. Some outputs will be provided at higher levels than others because no single production system can provide all outputs at the highest possible levels." (Miltenburg, 1995) A more in-depth summary of Miltenburg's theory, including a reproduction of the entire Manufacturing Strategy Worksheet, can be found in Chapter 3 Section 2.

Heidelberg’s new Manufacturing Outputs fall into four critical areas:

Cost - Cost of material, labor, overhead and other resources to produce a product.

Quality - The extent to which materials and operations conform to specifications and customers expectations.

Flexibility - The extent to which the volumes of existing products can be increased or decreased.

Innovativeness - The ability to quickly introduce new products or make design changes to existing products.

Miltenburg’s Manufacturing Strategy Worksheet (Figure 5-3) shows that the FMS can generally provide high levels of response to the cost and quality criteria, but the best type of system to meet the flexibility and innovativeness criteria is a job shop. This explains the discrepancy in the way the current system was built and the way it is managed, and agrees with the analysis of the J T. Black chart and Flow Efficiency figure. It shows that no one system can meet all of the criteria and the product and volume requirements.

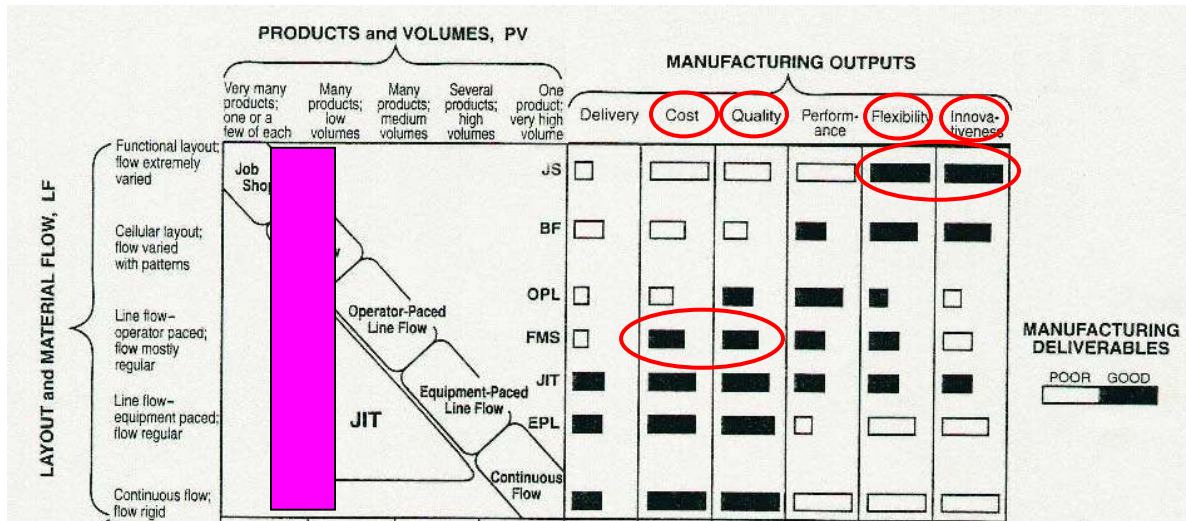

Figure 5-3 Manufacturing Strategy Worksheet-Partial (Miltenburg, 1995)

5.3.2 Conclusion

The results of our previous analysis (Figure 5-1 and Figure 5-2), our benchmark comparisons (Table 5-1) and the Miltenburg methodology (Figure 5-3) all point in the same direction. The current system is overwhelmed by the large number of part types,

large number of new parts and relatively short run times. The needs of the system have changed causing an inability of the current system to meet the current market requirements. The Miltenburg methodology clearly shows that no one system can meet all of the system performance requirements. Any new system must consider the possibility of a hybrid design to meet the diverse and possibly changing needs. In the next section we will present our proposal for a new system design.

5.4 System Redesign

In this exercise, we divided the manufacturing system into three main elements, (1) part flow, (2) cell elements, and (3) infrastructure, seen graphically in Figure 5-4.

- (1) *Part flow*: includes part organization inside and outside the cell.
- (2) *Cell elements*: includes machines, resource allocations (machinists, tombstones, tools), arrangements, and machinists' tasks.
- (3) *Infrastructure*: includes the interaction with other organizations and cell performance measures.

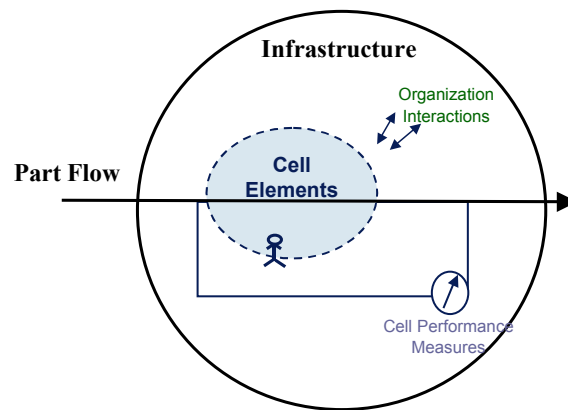

Figure 5-4 System Elements used for System Redesign

5.4.1 Recommendations

A summary of our recommendations for each of the system elements is given below. Figure 5-5 shows the fundamental layout suggested. The summary is followed by necessary backup information.

(1) Part Flow

- **Part Families can help improve productivity of the system.**

Currently there are 2,000 active part numbers in the cell, 811 of them were run in 1999 alone. The use of part families allows reduction in the total part variety and will shift the system characteristics closer to the regime of the flow shop system. Part families allow production to benefit from the knowledge of the worker by allowing him ownership for a family of parts, which increases improvement opportunities and problem recognition. Ultimately, a machinist and a programmer should have ownership of a family, in order to allow for improved quality of programs. Through an initial study, such benefits have already been seen in a family of parts with the reduction in castings from 86 to 7.

- **A hybrid system is necessary to meet the manufacturing goals.**

A hybrid system, shown in Figure 5-5, is proposed to meet the diverse needs of Heidelberg. Prove out parts and immature parts, are dedicated to one machine and one machinist. In this way, these jobs cannot disrupt the production jobs. The most knowledgeable machinist would be placed on the prove out machine, ultimately improving the programs for these new parts. The machine organization can be changed to deal with changes in market requirements.

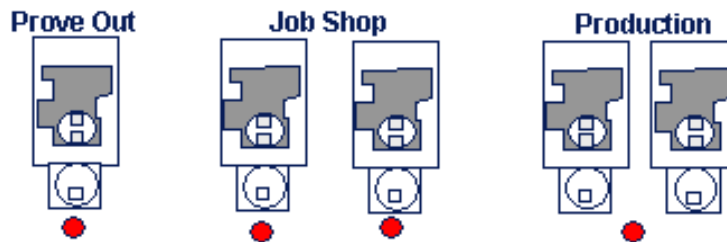

Figure 5-5 Hybrid System Proposal

(2) Cell Elements

- **Stand-alone machines allow improved machinist job characteristics and root cause analysis.**

Allowing a machinist complete control over a job from initiation to completion allows him not only ownership but also feedback from the system by completing both the setup and the machining. It now becomes necessary for the machinist to have knowledge of both setup and machining.

The cell currently exhibits constant job delays and waiting. In a stand-alone system, each machine would only have two jobs running, and the setup station would not be separated from the machine providing for less travel time and queuing time. Stand-alone machines would also allow better tracking of jobs for root cause analysis and observation of the system. To reduce the risk of a bad job inhibiting production, it is suggested that the new system be designed with adequate “set-aside” space next to each machine. Set-aside space would enable the removal of a bad job from the system.

- **A Transition State is necessary to reduce the risk of switching to stand-alones.**

In this way, the system can slowly improve in machine reliability and program reliability without risking a large drop in productivity during the change. It is recommended to start with a one man one machine scenario and transition to a one man two machine scenario as improvements occur.

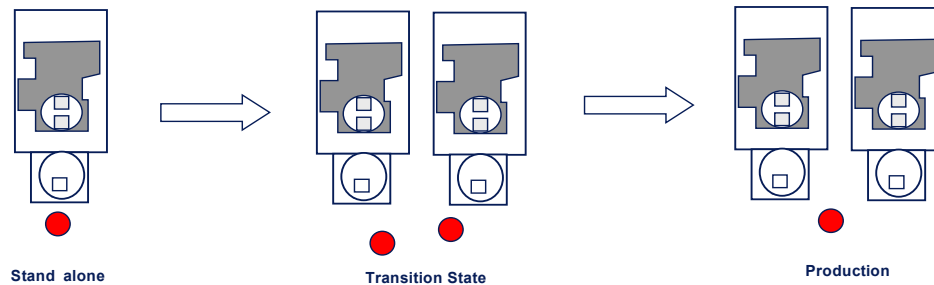

Figure 5-6 Transition States

(3) Infrastructure

- **Dispatch information must be expanded in depth and breadth.**

With the separation to stand-alone machines, the dispatcher will now need to send jobs to individual machines requiring more information about maturity, lot size, and part family. Some cross training will be necessary to allow some flexibility in assigning jobs to machines.

- **Quick response from all organizations is necessary.**

The new system requires the CNC programs to have a zero defect rate so as not to severely decrease utilization. It is advisable to reevaluate the way these groups are situated, in order to improve the response time. Possibilities for this include moving programming next to the cell and assigning a maintenance person sole responsibility for

the machines in the cell. It is recommended that other parts of the organization make use of the part families determined.

5.4.2 Backup Information

In this section we go into more detail concerning: 1) machinists' tasks which are captured in the "Machinist Wheel," 2) part families based upon an examination of the "pork chop" family, and 3) dispatch which will be more challenging with the new system design.

Machinist Wheel

It is easiest to think of the machinist's tasks as a wheel, or pie chart. The wheel represents a machinist's total day. In the current system, there are two types of machinists, the setup machinist and the prove-out machinist. Each of these machinists takes 2.5 machines under his priority (the current system has 4 machinists, 5 machines, each with 2 tasks). Figure 5-7 shows the distribution for the two machinists.

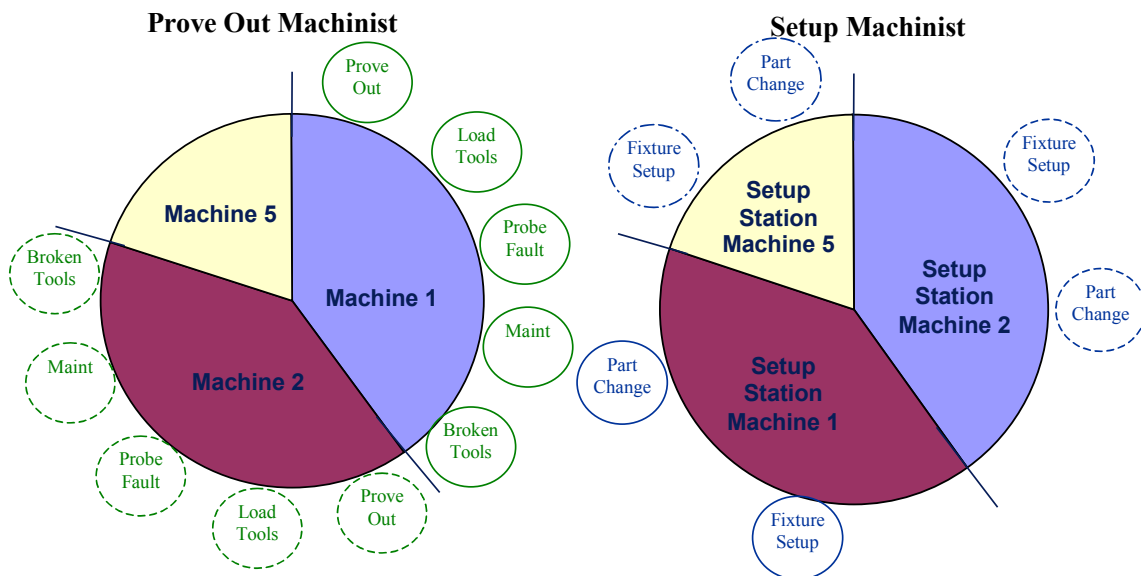

Figure 5-7 Current Machinist Job Wheels

It is imperative when designing a machinist's work that it includes standard and repetitive work with feedback about the system. Note that in the case of a disturbance to the current system, such as a machine failure, there is no feedback of such occurrences inherent in the setup machinist's work. In the case of long running proven out parts, this

machinist would have little to do as all of his responsibilities deal with machine breakdown.

A beneficial change would be to move to a layout that includes standard setup jobs and machine responsibilities for each machinist. This is possible through the use of stand-alone machinery. In the machinist's wheel in Figure 5-8 we have shown that, and have reduced the machinist's responsibility to only one machine in order to give him time to determine the root causes of the errors and eliminate them. This switch to stand-alone machines allows the machinists ownership of a job from initiation within the cell to completion. The automated pallet system separates the machines from the setup causing the disjunction in work making this change impossible in the current system.

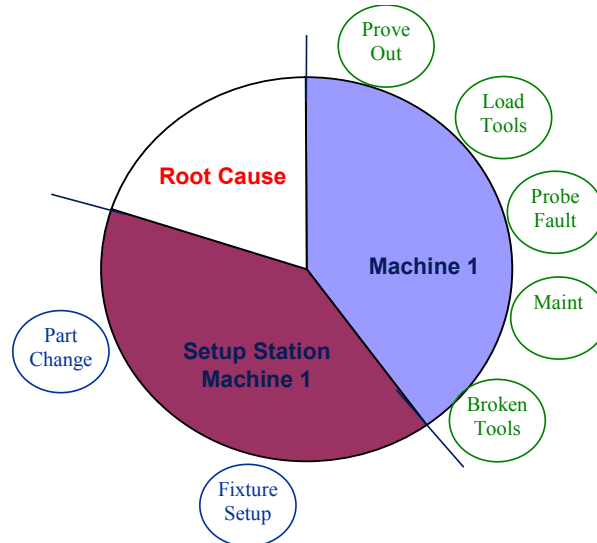

Figure 5-8 New Machinist Job Wheel

Part Family Example - Pork chops

It was seen from a study of a family of parts called the pork chop family (Sanchez, 2001) that by considering the parts as one family it is possible to reduce the number of castings from 86 individual castings (each needing individual patterns at the foundry, and each needing to be ordered and stocked) to seven castings.

This change should lead to a significant reduction in lead-time to obtain a casting, since a more standard casting can be kept in stock eliminating the pattern-making step. This also eliminates investment associated with new casting production, as a current

standard pattern is already available. The standard castings will also significantly reduce the number of fixtures necessary on initial machining steps.

A universal casting will weigh more than its current counterpart due to extra material to accommodate more parts and, therefore, each casting will be more expensive to purchase from the foundry. Due to this extra material, there will also be an increase in machining time to cut it away.

It has been shown that it will take between two and three years before there is a return on the initial investment in the new patterns necessary to switch to common castings. (Sanchez, 2001) This analysis assumes 8 new castings would be needed per year in the current system, and accounts for the additional cost in the weight of the common castings. It does not take into account the additional machining costs or fixture costs, and was not able to determine a monetary amount associated with the savings in lead-time. It is believed such improvements can be seen with other part types as well, not only in casting costs, but also in quicker program production, better use of fixtures, and reduction in scrap and rework. (Sanchez, 2001)

Dispatch

Dispatch is a critical part of system utilization. It is important that the person in charge of dispatch understand the resources and steps necessary for assigning jobs. The policies used to dispatch parts to the cell can affect part flow and work management.

Dispatch for the cell, in the current system, is done mainly by prioritizing project due dates. The process is done manually and requires some knowledge of the parts. In order to be prepared for production, the dispatcher will check for complete programs and request tools and fixtures. The dispatcher manually writes down the fixtures and tools necessary on cards and determines how much in advance these need to be submitted in order to be ready in time for production. He must check on their arrival before allowing production to start on the job.

Stand-alone machines require different dispatching needs. Instead of dispatching to the cell as a whole, it is necessary to dispatch per machine to take advantage of the knowledge gained by the machinist and the resources. It is also more important not to overload one machine and to allow balance in types and cycle times of parts produced.

In order to allow such a change, it is necessary to add depth and breadth to the information made available to the dispatcher. He has no current knowledge of the maturity of a program except through his own experience with the part. It is also necessary to have a clearer understanding of the resources necessary, such as top tooling, to allow those to factor into the decision. The change also brings with it the risk of machine starvation when a part family is not being produced. It is, therefore, necessary to consider cross training of workers to multiple part families.

5.5 Simulation

In an effort to determine how the proposed changes would affect the system a simulation was performed to study the affects of (1) part characteristics, (2) system configurations, and (3) worker assignments on machine utilization and machinist utilization. Hence, system simulation provided a tool to assess the proposed system redesign as well as other system changes and reconfigurations. The models were created in Taylor ED 2000 Version 3.4, produced by Enterprise Dynamics. This software was chosen over other similar software because of the ease of creating unique simulation components using a straightforward programming language.

5.5.1 Simulation Basics

In order to make the problem manageable, a simplification of the real system was used as shown in, Figure 5-9.

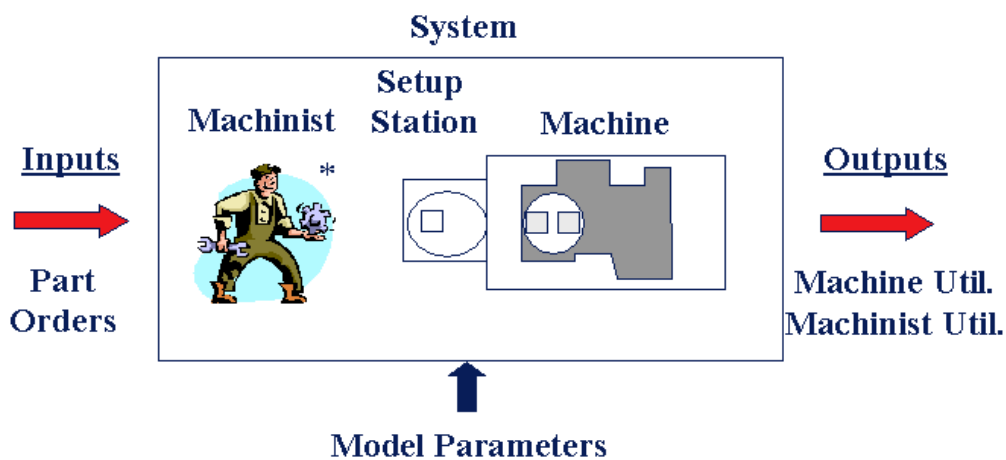

Figure 5-9 Simulation Modeled System Components

The basic system is made up of the machinist, the setup station and the machine. Run times for events at the setup station and machine are given as model parameters and depend strongly upon the part order inputs and the machinist's availability. The machinist's actions depend upon a task priority system and the physical arrangement of machines and machinists. Table 5-2 gives in outline form the basic parameters for the model. Detailed description of the distributions used and the underlying assumptions can be found in Appendix C.

Initial parameter values were chosen for each item based on personal experience within the factory. Included also were breaks and lunch for the operator. For each new job into the system, one prove out and one fixture setup were performed. For each subsequent part no prove out or fixture setup was performed. Each part was subject to a part change on the fixture. When multiple tasks requested the operator's assistance, the priority order used was 1) machine down, 2) prove out time, 3) part change, then 4) fixture setup. Each machine was allowed two active tombstones at a time, therefore, allowing two active jobs at a time.

Inputs	Setup Station	Machine	Outputs
Part Orders <i>Cycle Time</i> <i>Lot Size</i>	Setup Time*	Prove Out Time*	Machine Utilization
	Part Change Time*	Machine Down* <i>Maintenance</i> <i>Tool Break</i> <i>Probe Fault</i>	Machinist Utilization

* Requires Machinist

Table 5-2 Simulation Model Parameters

5.5.2 Model Procedure

A comparison of the model to the current system was conducted using historic data to verify the assumptions and simplifications described. Using this model, the stochastic model parameters can be modified until verification is met.

Once the model is confirmed, new system implications can be studied for their affects on the system. This will be divided into 3 categories: (1) machine configurations, (2) part inputs, and (3) sensitivity to stochastic parameters.

Comparison of model with historic data

The first model simulates the current system layout that can be seen in Figure 5-10. In the model, one team of machinists has main ownership of two machines and shares the ownership of a third machine. One machinist is in charge of setup responsibilities and the other, machine responsibilities. In the current system there are two such teams, which share the responsibility of a fifth machine.

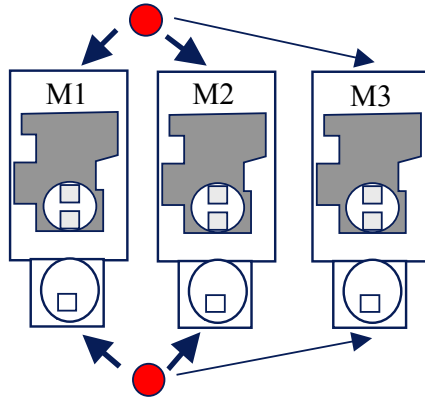

Figure 5-10 Simulation Current System Model

Figure 5-11 shows a comparison between the simulation results and data for a specific month in 1997 (based upon 20 hours of human observation). In comparing the pie charts of Figure 5-11 simulation generated “busy” is directly related to the observed “spindle up” time. In the simulation model, “setup” is made up of prove out, which can be directly compared between the two pie charts. Machine “down” is made up of the three types of downtime: maintenance, tool break, and probe fault. Therefore, probe fault cannot be separated in order to compare. But it should be noted that part of what is believed to be associated with “probe fault” in the observation would be considered “waiting for operator” by the simulation. Therefore, the simulation agrees with the 1997 observation in all categories that can be directly compared.

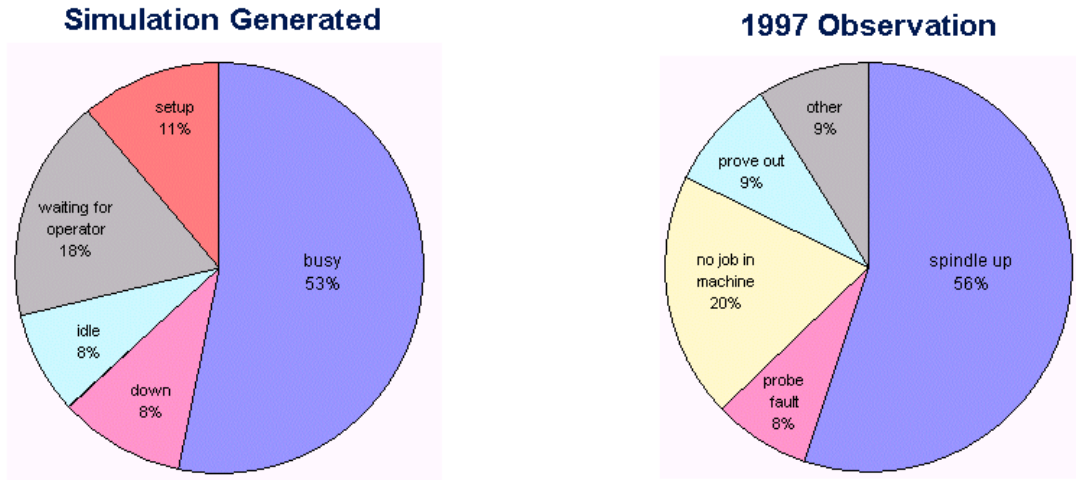

Figure 5-11 Comparison of Simulation with Historic Data

The model was also used to generate “utilization curves.” Data of varying cycle time and lot size was used and these results were compared with data generated from 1997/1998 data. As can be seen in Figure 5-12, these trends match the data generated in that report. The difference in slope is hypothesized to be attributed to a variation in cycle time from month to month of the actual system.

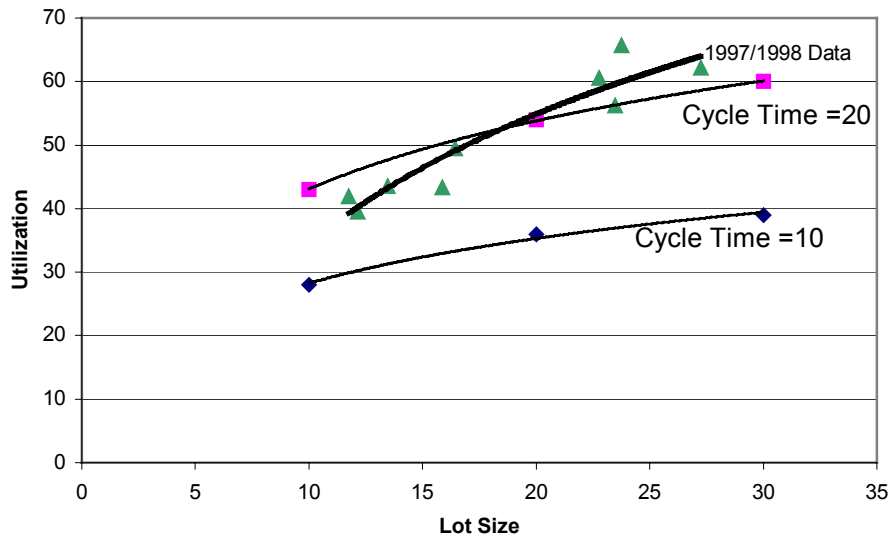

Figure 5-12 Simulation Utilization Trend Comparison to Historic Data

Change in Machine Configuration

Multiple machine configurations were then tested to see their affect on machine and operator utilization. In each configuration shown in Figure 5-13 there is a change in the operator job description varying from setup, machine tasks or both. The dots used to signify the machinists, indicate the machinist job assignments.

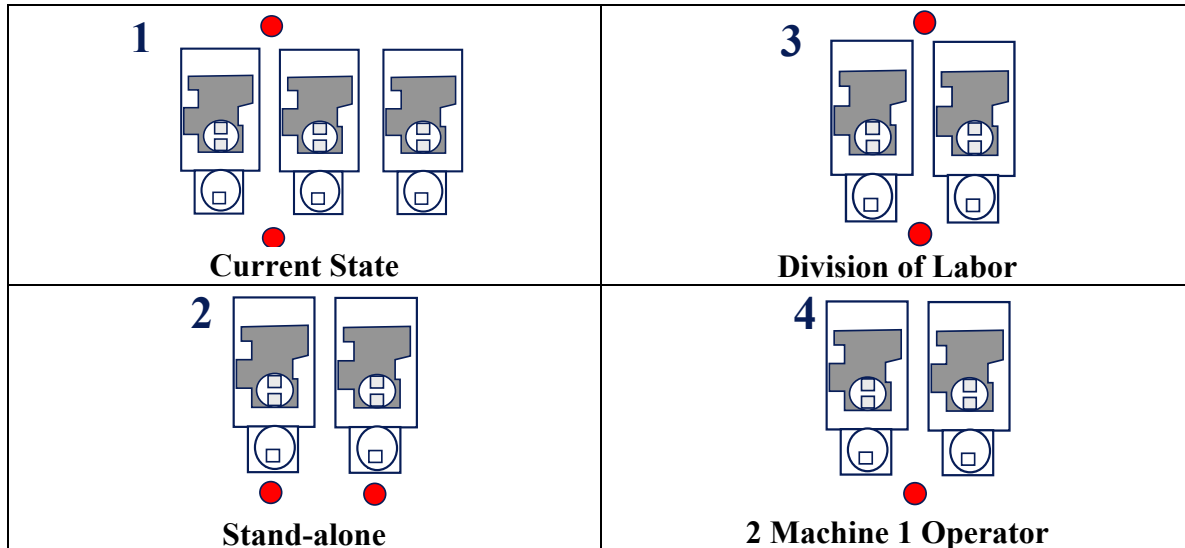

Figure 5-13 Machine-Operator Configurations Modeled in Simulation

The machine utilization and operator utilization for each of the cases above are shown in Figure 5-14. The data used to generate this chart can be found in Appendix C Table C-5. In the case of different utilizations within the same configuration, an average was taken. A change in configuration has a large effect on both machine and operator utilization. As seen in Figure 5-14 reorganization to stand-alone equipment (Configuration 2) with one machinist in charge of each machine has the highest expected machine utilization. The simulation also shows that a decrease to a one machinist, two machine configuration (Configuration 4) could have a large negative impact on the machine utilization that must be compared to the cost savings it allows before such a decision is made.

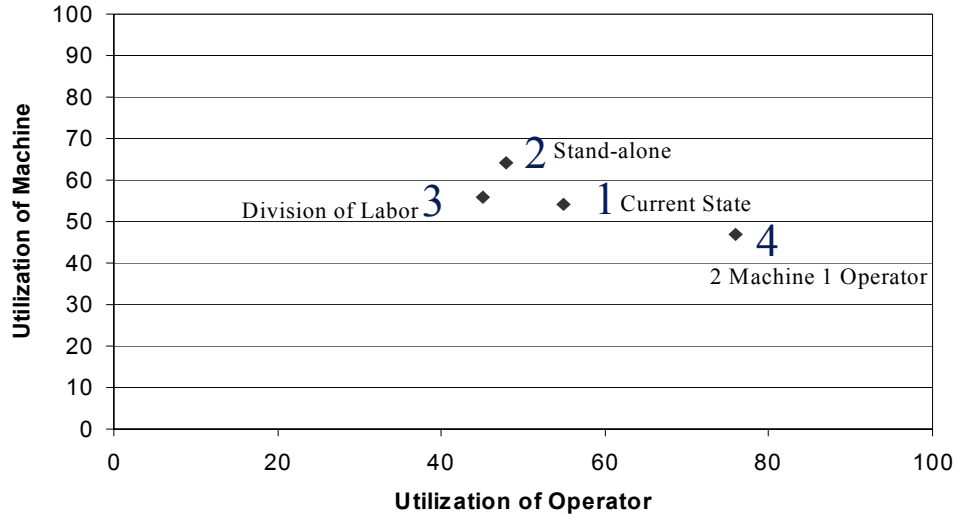

Figure 5-14 Utilization of Different Machine Configurations Using Simulation

Production of Different Part Inputs

With the new system design there is also an expected shift in part input characteristics. It is expected that more of the simple parts will be outsourced and the more complex ones with longer prove out times and run times will be held in house. Based upon these observations, a set of representative future part times was developed. Using the same four system configurations, the simulation was run with the new input data. As can be seen in Figure 5-15, there is a considerable change in the utilization of both the machine and the machinist with the changes in input. This can be associated with an increase in both average lot size and average cycle time by 2.5 times. The data used to generate this chart can be found in Appendix C Table C-5.

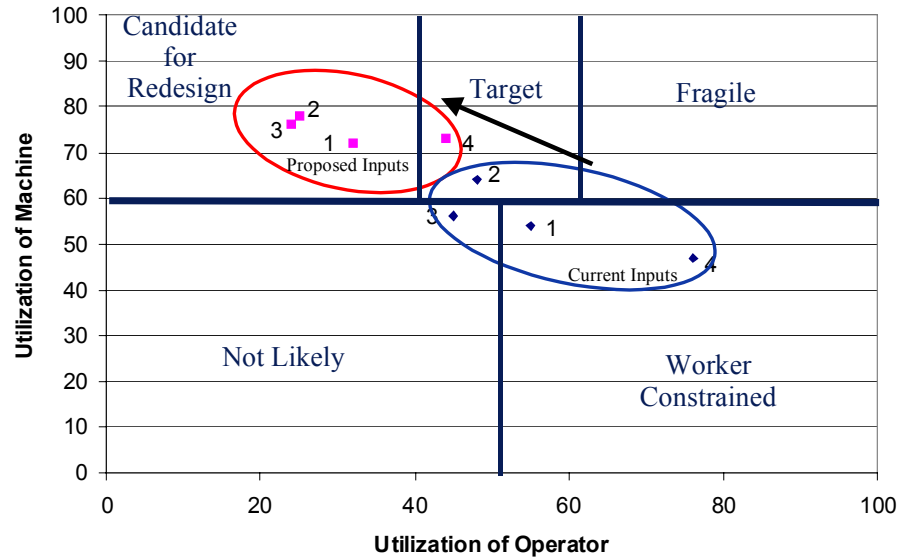

Figure 5-15 Utilization Map Comparing Machine Configuration and Part Inputs

Overlaid on Figure 5-15 are five categories of systems operation. High machine utilization is desired, but if there is high machine utilization and operator utilization, the system may be considered “fragile” because a slight increase in the operator utilization will probably have a huge negative affect on the machine utilization. A low machinist utilization and high machine utilization indicated possible “redesign” efforts that would combine workers keeping the system production high and reducing the operational cost. The “target” regime is one with a high machine utilization and approximately 50% operator utilization, which causes the operator to be busy and yet also available for quick response to problems and root cause analysis.

In this case, the target regime can be met in multiple ways. The first is through a system redesign to one machinist and one machine. It is also possible to accomplish it with one machinist and two machines, assuming the changes in part inputs. Figure 5-15 also shows that the current system is in the “operator constrained” regime, which verifies the previous hypothesis made in Chapter 4.

Sensitivity analysis to stochastic parameters

In this section we look at the sensitivity of our results to variation in input parameters, in particular setup, prove out and machine failure times. Each of these in

turn is related to the three biggest changes Heidelberg expects in the near future. These are:

- A **Configuration** change is expected to decrease machine failures by allowing the machinist more ownership of his machine. This allows him to see both repetitive program errors and machine failures sooner, improving root cause.
- An increased **Part Complexity** is associated with the increased production time in the future parts. With this change in part complexity comes an increase in fixture setup time and prove out time due to the inherent increased features of more complex parts.
- **Part Families** aid the identification of products, therefore, causing improvements in prove out times, design of the fixtures, and probe faults.

The stochastic parameters have been grouped into two categories, as seen in the matrix below. The two parameter groups are: setup quantities (fixture setup, prove out, and part change) and machine failures (maintenance, probe fault, and tool break). These parameter groups can be changed individually to understand the effects of the system changes on them. Appendix C Table C-3 and Table C-4 show the distribution changes made.

	Setup and Prove Out	Machine Failures
Configuration		X -
Part Complexity	X +	
Part Families	X -	X -

Table 5-3 Change Effect Matrix

Figure 5-16 and Figure 5-17 show how a 50% change, both negative and positive, in these two categories (setup and machine failures), would affect the systems. The analysis was done for both Configuration 3 and 4 (Figure 5-13) in order to verify the trends. The impact of these changes is shown with 'x' in the figure.

In Figure 5-16, we see that the change in machine failures exhibits a larger affect on the future data set than the current set. The future input is in a machine constrained regime and, therefore, a change in a machine parameters directly affects utilization. In the current data set, the system is operator constrained, therefore, the affect of the failures is smaller.

With a 50% change in setup times, the current input data exhibits a larger change in machine utilization than the proposed input data. The current input lies in the machinist constrained region and such a change in setup time is directly related to the machinist time, causing the large affect on operator and machine utilization. Most of the setup is external to the machine cycle time, therefore, when the machine is the constrained resource, there is a much smaller effect.

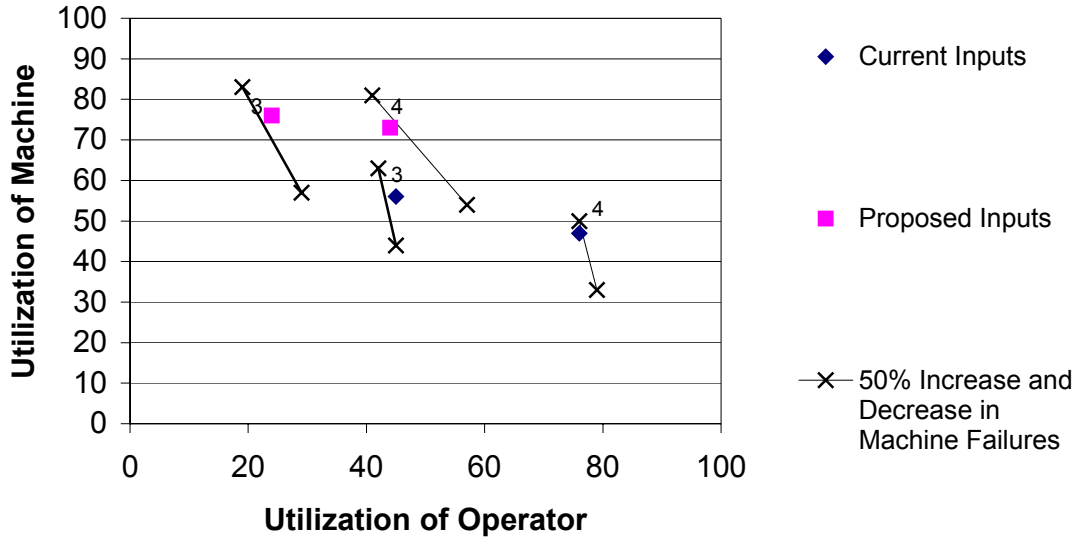

Figure 5-16 50% Change in Machine Failures

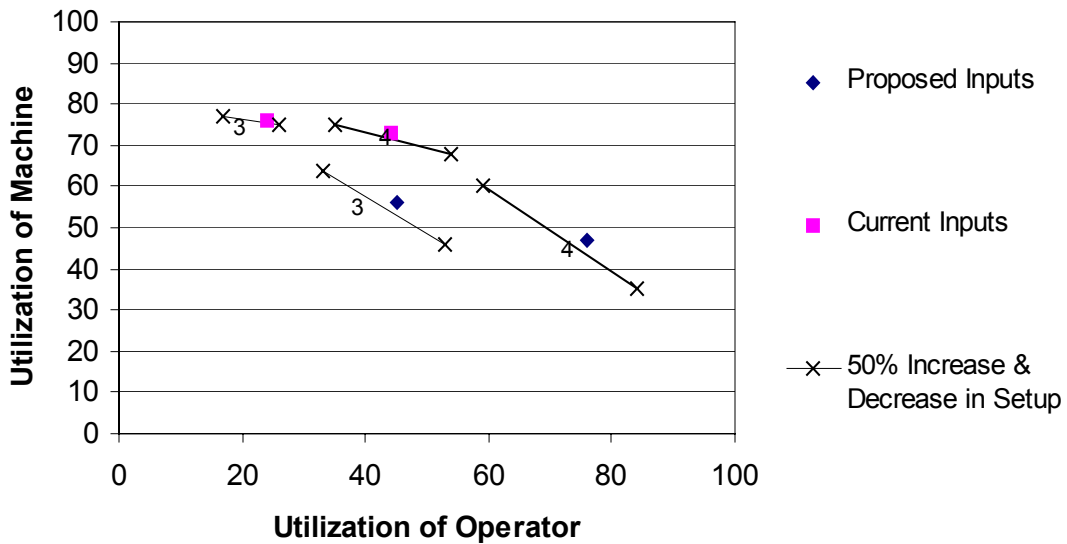

Figure 5-17 50% Change in All Setup Quantities

5.6 Conclusion

These results strongly suggest that a change in system type is necessary. This study explored possible system regimes and showed that the current system is not operating in the regime it was intended. This could be caused by a shift in market conditions since the system was first put in place. The current part characteristics caused the system to run as a job shop, although the equipment is that of an FMS. This analysis was confirmed with the use of Miltenburg's Manufacturing Worksheet on manufacturing strategy, LAI's flow efficiency analysis, Black's system comparison, and benchmarking of other companies running the same system. It has been suggested that a change to stand-alone machines will improve productivity and allow for root cause analysis in order to continue to move toward the target regime. The simulation allowed estimates of this improvement with (1) changes of operator and machine configuration, (2) changes of part characteristics and (3) improvement of machine and setup characteristics. The structural and infrastructure system elements were discussed and improvement plans, including possible transition states and hybrid systems, were determined. Possible risks associated with such a change were also discussed.

Wickham Skinner proposed the idea of *focused factories* in his book *Manufacturing: The Formidable Competitive Weapon*. It states that by separating parts into families and dedicating resources to them we are creating factories within bigger factories. The hybrid system proposed is similar to these focused factories and will be used to help reduce variation and increase recognition of parts. The system is also a dynamic one that can be flexible to change with changes in market conditions.

References

Black, J T. *The Design of the Factory with a Future*. New York: McGraw-Hill, 1991.

Miltenburg, John. *Manufacturing Strategy: How to Formulate and Implement a Winning Plan*. Portland: Productivity Press, 1995.

Sanchez, Nathan. "Group Technology and the Application of Process Planning in a Flexible Manufacturing System." Bachelors Thesis. MIT. Cambridge, 2001.

Shields, J. Thomas. "Factory Flow Benchmarking Report." Lean Aerospace Initiative Report RP96-06-61. MIT. Cambridge, 1996.

Skinner, Wickham. *Manufacturing: The Formidable Competitive Weapon*. New York: John Wiley & Sons, 1985.

PART ONE CONCLUSION:

CASE STUDY ANALYSIS AND DESIGN

The case study discussed in Part One has improved our understanding of manufacturing system design and has shown some repetitive overarching themes that will be reviewed here. It is from this experience that we recommend the consideration of these themes when determining the appropriate use of an FMS in a manufacturing facility.

It can be stated that those themes discussed all relate to the flexibility, as discussed in Chapter 4. The increased flexibility that was designed into the system is causing many of the repetitive errors to go unidentified and causes the reduction in quality.

- **Focused Resources**

It was observed that there was constant competition and waiting for resources. It is suggested that by focusing these resources, using part families, this waiting can be minimized.

With 2000 part numbers possible in the cell, the system can be considered a job shop. By considering the use of part families, which will reduce the possible varieties of parts, to a smaller list of families, the system can move out of the job shop regime and start to perform more productively. Part families will allow a reduction in the varieties that must be learned by the machinists and programmers, allowing the possibility for improved quality of programs and parts because learning can be carried from one part to the next. By considering all the pork chop parts as a family, a large reduction in necessary tooling, and casting variations was identified. A standardization of the tooling path was also found which will improve performance within the cell.

- **Simplified Flow**

With dedication of setup station, machinist, and machine we can create a simplified flow path for parts, allowing for more focused attention on a job, quicker response to problems, and better determination of root cause. In the case of the cell discussed, a

stand-alone machine allows for a reduction in the number of current jobs the machinist must have knowledge of.

- **Standardization**

Standardized work for the machinist will help him better deal with his assigned duties and be available to resolve problems quickly. Standardization of tool lists and programming principles, will help improve the quality of other departments by reducing prove outs, probe faults, and helping to determine root cause. It is also necessary to standardize relationships with other departments with clear rules and interfaces to avoid miscommunication and to promote quick responsiveness to problems.

Conclusion

As was seen in the analysis shown, a Flexible Manufacturing System is not appropriate in all circumstances. In some cases of product mix, volume, and rate of new products, an FMS can cause a system to be in constant chaos. Such a system can be made productive with considerable planning and scheduling. But in this case, there is no way to make a predictable schedule since the production time estimates are not reliable and the programs are of low quality.

In determining the appropriate production system, it is necessary to consider the system goals and system parameters. It has been seen here that not all types of production systems will work well in all types of situations. A current mismatch was found between the parameters, goals, and the Flexible Manufacturing System that was in place. A hybrid system has been discussed to meet a wide variety of different and possibly changing system goals and system parameters. The machine organization can also be easily modified to deal with the changing performance goals and market requirements.

PART TWO

VALUE STREAM MAPPING

The goal of Part Two of this report is to discuss in-depth an improvement tool. Value stream mapping was chosen as the subject matter. The purpose of the current project will be to study a cross section of those companies using value stream mapping and to compare and contrast the success of the multiple activities.

Chapter 6 will review the background of lean manufacturing and describe how value stream mapping fits into the lean principles. Chapter 7 will attempt to answer the questions defined in the Chapter 6 problem statement about the use of value stream mapping.

Chapter 6 Background and Problem Definition for VSM

Lean manufacturing, is the philosophy of eliminating waste within a process; looking to isolate the value added activities and place them in a form of continuous flow to better meet customer demand. Many industry leaders, in order to improve their processes toward the ultimate lean production system, are using value stream mapping (VSM). VSM allows a simple two-dimensional representation that separates the value added steps from the non-value added ones. As seen in the case study discussed previously, value stream mapping is a great tool to help determine wasted steps, reduce total lead-time, and provide a valuable door-to-door perspective on the entire process.

First the history of lean will be discussed, including the five key principles, and its implementation in the US. This will be followed by a detailed discussion of value stream mapping, since it is from these five key principles that value stream mapping was developed.

6.1 Lean History

Lean is a term coined by The MIT International Motor Vehicle Program to describe the Toyota Production System (TPS), in their publication *The Machine That Changed The World*. The goal of this publication was to characterize the performance differences between companies operating with traditional mass manufacturing systems and those using TPS (Cochran, 2000). This book revolutionized the way people thought about the automotive industry.

The Toyota Production System, now known also by the terms “lean” or *Just-in-Time (JIT)*, was developed based on the cultural, geographic and economic history of Japan in the 1950s. The Japanese believe more strongly in conservation of material than our US “throw-away society” does, making it easier to adapt tight material control policies. Due to a more systems-oriented culture, policies that cut across individual workstations, such as cross training of floating workers and total quality management, were easier to adapt. The location of suppliers also made it feasible to have more frequent deliveries. The possible impending doom of the automotive industry in Japan without an increase in efficiency and productivity fueled the ability to make drastic changes (Hopp

and Spearman, 1996). Working under the desperation that this created, the theories and principles of lean manufacturing were developed.

Lean has been implemented in a diverse set of environments including aerospace, consumer products, metals processing, and industrial products (Spear and Bowen, 1999). Contrary to Toyota's open atmosphere about its practices, "few manufacturers have managed to imitate Toyota successfully" (Spear and Bowen, 1999). The decomposition of the Toyota Production System is difficult because many of the control functions, tools, and practices (pull system, kanban, andon lights, pokayoke checks) are being confused with the system. TPS is not just the implementation of these tools, there are principles that underlie it. Although lean has spread throughout the manufacturing section of most businesses, it is only now spreading towards other sectors of the business, including product development where it has only been attempted in 20% of the activities (Chase, 2001).

Using the principles of lean manufacturing, which were developed in the automotive industry, considerable system improvements have been seen in the aerospace industry. Lockheed Martin obtained large savings on the F-16 project, including a 50% reduction in floor space and a 60-80% improvement in cycle time (Lewis, Norris, & Warwick, 2000). Using the principles of lean, General Electric saw an improvement to 100% on-time deliveries (Murman, 2002). The Delta IV launch vehicle was able to reduce floor space from four million square feet to 108,900 square feet, a reduction of 97.3%, as well as the reduction from twenty crane moves to four (Murman, 2002). These are just examples of a long list of substantial improvements seen in the aerospace industry through the use of lean principles and lean improvement tools.

6.2 Lean Principles

In *Lean Thinking*, Womack and Jones define lean thinking as "a way to specify value, line up value-creating actions in the best sequence, conduct these activities without interruption whenever someone requests them, and perform them more and more effectively." It follows from this that there are five key principles vital to lean thinking, these are: specify *value*, identify the *value stream*, make value *flow*, organize customer *pull*, and pursue *perfection*. These principles are expected to be addressed in order, with

each one building on the one before it, as shown in Figure 6-1. Within this framework of lean principles, this research will concentrate on the identification of the value stream and the identification of the value adding actions.

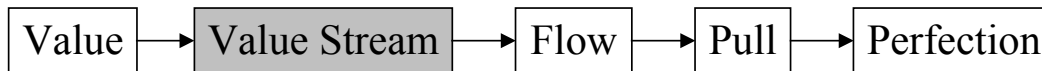

Figure 6-1 Steps of Lean Thinking (Womack, 1996)

Specify Value - Value is expressed in terms of a specific product or service, delivered at a specific price at a specific time, which meets the needs defined by the customer.

Identify the Value Stream – Value stream is a look at the entire door-to-door perspective of a production, from raw materials to product delivery. It includes the determination of all actions necessary to produce a product, and the separation of these necessary activities from the identified non-value added steps. This includes, not only the physical transformation of the product from raw materials, but also the information system necessary to produce the right quantity at the right time.

Flow – Once waste has been eliminated, ‘flow’ can be accomplished. Flow, the opposite of batch production, requires the movement of products from one value-creating step to the next with no waiting or scrap.

Pull - The production of only what the customer wants when the customer wants it. Instead of pushing products from raw materials to the customer, information travels upstream from the customer signaling production only when a need is shown.

Perfection – This step is a reminder that there is no end to reducing waste. Continuous improvement of a system is vital to perfection, where waste is constantly being eliminated.

It is necessary to understand that lean is not a specific control tool, improvement tool, floor layout, or principle. It is the methodology or framework that focuses on the ideas of value, waste, and meeting customer demand. From this, it is clear why value stream mapping came about as a way of determining where the value and waste are located and aiding in the reduction of lead-time to help make the right product at the right time.

6.3 Value Stream Mapping

Identifying the value stream, the second principle in lean thinking, includes a study of the entire production process and separation of value added from non-value added process steps. This can be accomplished through the use of value stream mapping, a simplification tool, where a highly complex real system can be represented in a simpler two-dimensional format. Value stream mapping is the process of compiling all actions that go into the design, order and production of a product into a door-to-door diagram from which a future vision can be created, through the implementation of lean concepts such as flow and pull.

VSM allows the separation of actions into three categories: (1) value added, (2) non-value added but necessary, and (3) non-value added. The non-value added actions should be addressed first and be eliminated. It should be possible to complete this step in a short span of time under current operating procedures. This is followed by elimination of those non-value added but necessary steps, which may require considerable restructuring of the system.

Rother and Shook's *Learning to See*, which devised value stream mapping in its present form, recommends that value stream mapping be done in three phases; current value stream, future value stream, and determination of an implementation plan. In many cases, value stream mapping is done in a workshop type atmosphere which brings together engineering, manufacturing control, machinists, and maintenance personnel, where the current state, future state, and implementation plan are all created during a three to five day period. This format brings together all of those people affected by changes to the system. It achieves a method for obtaining their collective buy-in for the changes, a sense of ownership of the improvements, and an increased team camaraderie for all involved.

6.3.1 Current State

A current value stream map, seen in Figure 6-2, is read from left to right with the first production step being placed in the bottom left corner and shipping usually in the bottom right corner. In the top left corner the supplier can be found, and the top right is the customer. The bottom of the chart is reserved for production steps, and the top for

information flow between the company, the individual production steps, the customer, and the supplier.

Learning to See states that the current value stream should be made as a snapshot of current findings and include such information as inventory levels, total lead-time, machine uptime, and machine reliability. Table 6-1 shows the typical metrics included for a specific process box on a value stream map. A current value stream map allows someone to see the flow of the entire production process from supplier to customer, something many people within the process do not know. People then understand how their job or function affects the critical path operation. Through the use of the common symbols, a common language is available to understand the situation.

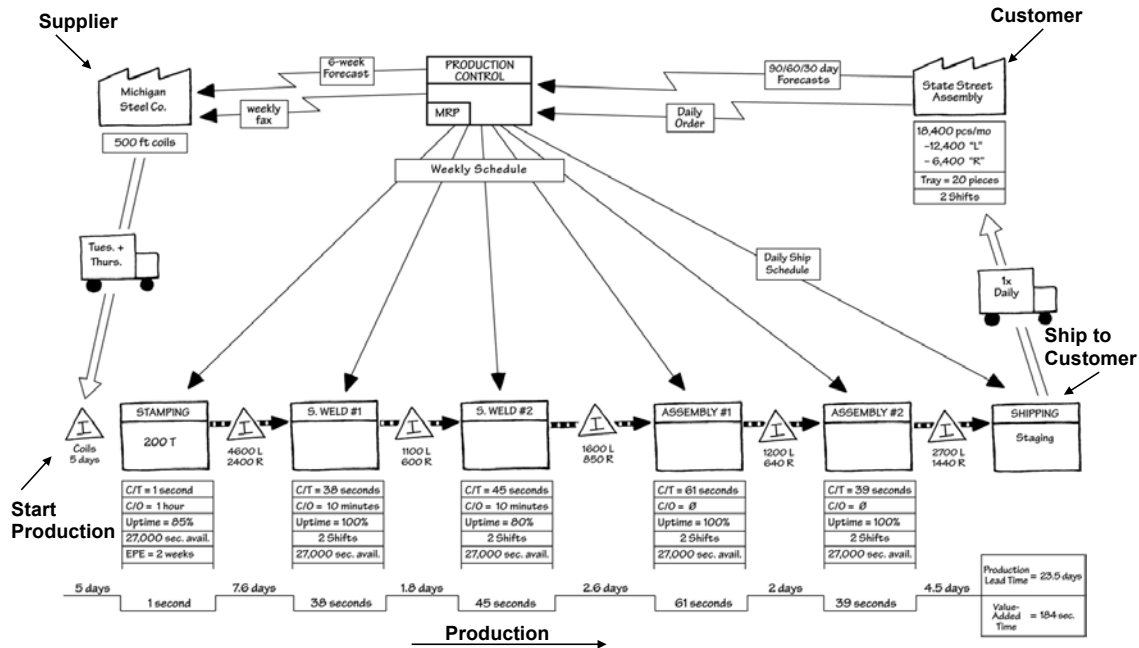

Figure 6-2 Current Value Stream Map (Rother, 1999)

Metric	Description
Cycle Time	Time required to complete a process
Changeover Time	Time required to change a process from one product to another
Uptime	Percentage of time station is processing parts
Available Time	Amount of time machines and employees are free to work
Batch Size	Number of same part that goes through a process step at one time
Yield	Percentage of good parts produced in a process

Table 6-1 Typical Value Stream Metrics (Millard, 2001)

6.3.2 *Future State*

After a current value stream is made, the next phase is a future value stream. Using the principles of lean manufacturing and a set of important questions vital to lean manufacturing, supplied by *Learning to See*, a future state is drawn. These eight questions, which can be seen below, should be answered in the following order for a system perspective.

Questions seen in *Learning to See*:

1. What is the takt time?
2. Will we ship directly to the customer, or to a finished goods warehouse?
3. Where can we use continuous flow?
4. Where will we need supermarket pull systems?
5. Where will our pacemaker be?
6. How will we level the production mix at the pacemaker?
7. What increments of work will you consistently release and take away at pacemaker?
8. What process improvements will we need to achieve our future state design?

It should be noted that these questions link to the ideas of flow and pull mentioned in the lean principles, and shows how making a value stream map is vital to determining where you can improve your processes. Figure 6-3 shows a future state that has been developed using the principles of lean. A pull system from shipping has been implemented through the use of kanban cards and supermarkets. The welding steps and assembly steps have been combined for a continuous flow cell. Through these identified improvements, there is a change in lead-time from 23.5 days to 4.5 days in this example.

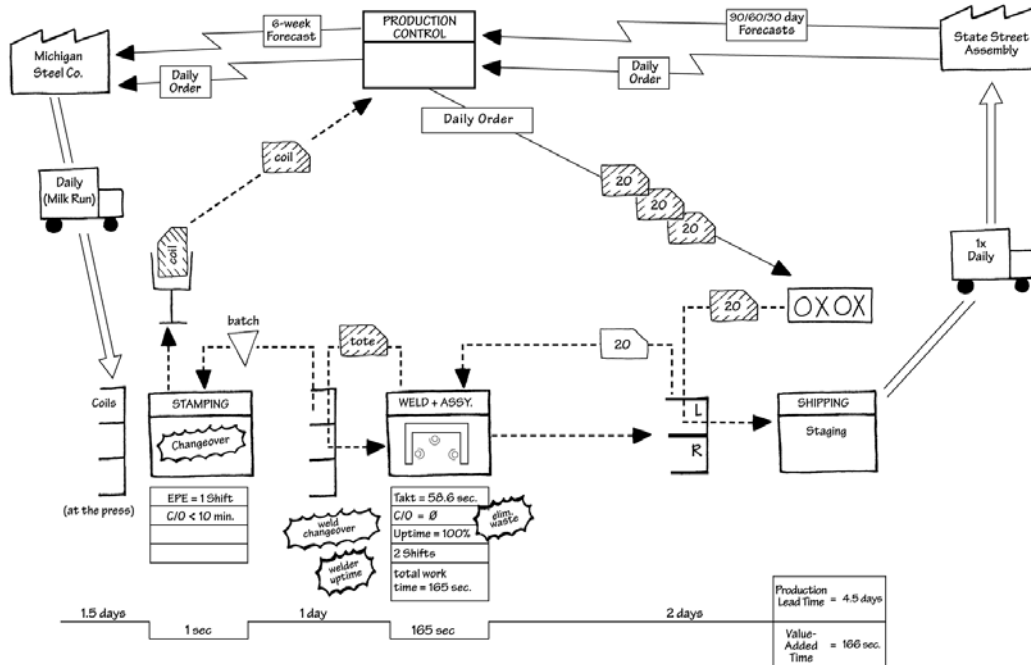

Figure 6-3 Future Value Stream Map (Rother, 1999)

6.3.3 Implementation Plan

The final step of value stream mapping is creating an Implementation Plan to help achieve the future state from the current state. *Learning to See* suggests the use of a value stream plan worksheet and a review worksheet (Rother, 1999).

It is recommended that follow up meetings, once every week to two weeks, are necessary to continue to update and make progress on the implementation plan. This regular meeting format stresses the importance of the initial value stream mapping event and the actions that were identified. Making people accountable for certain action items will also help speed along the process.

6.3.4 Value Stream Mapping at Heidelberg

A value stream mapping exercise was performed at Heidelberg to obtain a better understanding of where the currently discussed cell fits into the bigger production system and as verification for the needed changes. In hindsight, such a map should have been made in advance of discussion of any changes.

The value stream workshop was run to improve the lead-time of the pork chop family throughout the entire plant. The pork chop was chosen because it is a high

volume product family, with a large number of steps and a large lead time. The workshop found many opportunities for improvement of the system including improvement in the supplier delivery of castings. It also suggested the elimination of unnecessary machining steps where the value added could be moved to an already necessary machining step, therefore eliminating the necessary queuing time and machinist setup time associated with having two steps.

Within the entire flow of the product, the cell adds a great deal to the lead time because the parts do not only come to the cell once, but on complex parts many come through the cell multiple times. Therefore, any inventory savings or cycle time reduction for the cell would have a large impact on the system, showing that this was indeed the step to be concentrated on.

Within the cell, the important opportunities include reduction in prove out time to allow for smaller batch sizes, reduction in manual deburr to free up the operator, review of the programs in order to eliminate the Non-Conformance Documents, and improvement in the reliability to eliminate inventory. Each of these areas consumes a different amount of time depending on the job and the program. Methods of improving prove out time have been discussed above and include determination of part families to help improve the quality of the programs and to allow for standards.

6.3.5 *Summary of VSM*

As has been shown, the value stream mapping tool includes not only a standardization of symbols and mapping technique but is famous for its format of production of a current state, future state, and implementation plan through the answering of eight fundamental questions. It is, therefore, necessary to acknowledge that other symbolic representations are used and can accomplish the same fundamental objectives. Such tools as process flow diagrams (Galloway, 1994) have been used in the same format for comparable improvements. It is advisable to pick the mapping technique, which meets the attributes most important to the system. Refer to “Value Stream Analysis and Mapping for Product Development” (Millard, 2001) for a comparison of process flow mapping with value stream mapping. From observation it is also seen that companies

will create their own version, which combines only their necessary attributes, and refer to it as value stream mapping.

6.4 Summary

The main principles of lean manufacturing have been reviewed. It has been seen that it is from these five main lean principles that value stream mapping was developed. Value stream mapping plays an important role in developing a system wide look at the problem and determining ways of eliminating waste. The steps to creating a value stream map have also been discussed in order to understand the tool in-depth. Our analysis on its appropriateness in the aerospace industry is discussed in the next chapter.

6.5 Problem Statement

Value stream mapping is a common design tool used in the manufacturing industry to redesign systems. It helps to bring together different expertise and creativity, and allows easy identification of system goals. The purpose of the current project will be to study a cross section of those using value stream mapping in their companies and compare and contrast the success of the methods used. Certain questions will be addressed including:

- Is there an environment in which value stream mapping is more appropriate or less appropriate?
- How do you measure the success of value stream mapping?
- What are the limitations of value stream mapping?

References

Black, J T. *The Design of the Factory with a Future*. New York: McGraw-Hill,1991.

Chase, James. "Value Creation in the Product Development Process." Masters Thesis. MIT. Cambridge, 2001.

Cochran, David S. Design and Control of Manufacturing Systems Lecture Notes. MIT. Cambridge, 2000.

Galloway, Dianne. *Mapping Work Processes*. Milwaukee: ASQC Quality Press, 1994.

Hopp, Wallace J. and Mark L. Spearman. *Factory Physics: Foundations of Manufacturing Management*. Boston: Irwin, 1996.

Lean Enterprise Institute. *Seventh Annual Lean Manufacturing Conference: A 21st Century Look at Lean Manufacturing*. Detroit. May 2001.

Lewis, Paul, Guy Norris, and Graham Warwick. "Manufacturing Technology: Building to Win." *Flight International*. July 25-31, 2000.

Millard, Richard. "Value Stream Analysis and Mapping for Product Development." Masters Thesis. MIT. Cambridge, 2001.

Murman, Earll et al. *Lean Enterprise Value*. New York: Palgrave Publishers Ltd., 2002.

Rother, Mike and John Shook. *Training to See: A Value Stream Mapping Workshop Participant Guide*. Brookline, MA: Lean Enterprise Institute, 2000.

Rother, Mike and John Shook. *Learning To See: Value Stream Mapping to Add Value and Eliminate Muda*. Brookline, MA: Lean Enterprise Institute, 1999.

Spear, Steven and H. Kent Bowen. "Decoding the DNA of the Toyota Production System" *Harvard Business Review*. September-October 1999.

Womack, James P. and Daniel T. Jones. *Lean Thinking: Banish Waste and Create Wealth in Your Corporation*. New York: Simon & Schuster, 1996.

Womack, James P., Daniel T. Jones, and Daniel Roos. *The Machine that Changed the World: The Story of Lean Production*. New York: Harper Perennial, 1990.

Chapter 7 Value Stream Mapping Environment

The purpose of this research is to determine how to increase the success of a value stream mapping event. The goal of this section is to develop an understanding of what some of the factors are that affect VSM and help to determine if these can be used to improve the tool's success. This chapter will first explore the proposed characteristics and their expected affect on value stream mapping. These hypotheses will then be tested using a survey. The insights obtained will be used to design a value stream matrix, which can be utilized by companies to consider the appropriateness of VSM in a production area.

7.1 Hypothesis & Purpose

The effectiveness of a value stream mapping event has certain necessary preconditions or factors. This chapter will explore possible factors that might affect the success of value stream mapping.

It is believed that the set of factors can be determined from the system design inputs developed by LAI. In a previous LAI study, ten inputs to manufacturing system design were determined, seen in Table 7-1 (Fernandes, 2001). These are the major factors used when considering what type of system to put in place. Currently, such a determination of system type is usually made through trial and error or through experience. This list, though not exhaustive, identifies those main factors that are believed to directly affect system design. It is proposed that from this list a reduced set of factors that affect value stream mapping can be identified and it can be understood how these factors interact to increase the success of VSM.

Market Uncertainty	Demand fluctuations for product including both short-term random variability and long-term step/cyclical variability
Product Volume	Number of products to be manufactured over a time period
Product Mix	Number of different products to be manufactured
Frequency of Changes	The anticipated possible types of changes that will affect the production facility
Complexity	Level of difficulty associated with fabricating or assembling a part.
Process Capability	Generalized technological ability to repeatedly make something with minimal intervention
Type of Organization	Level of innovativeness supported on the factory floor
Skill Level	Overall skill level of both factory management and hourly workforce available to the factory
Investment	Amount of financial resources required for the manufacturing system design activity
Time to first part	Length of time allotted from start of manufacturing system design to full rate production of the first part

Table 7-1 Ten Manufacturing System Design Inputs (Fernandes, 2001)

7.2 Methodology for Research/Experimental Design

This section will first review the methodology used for the research, followed by an in-depth look at the experimental design for both phases of the study. The goal of this section will be to develop hypotheses about the necessary preconditions for a successful value stream mapping event and design a survey in order to test the hypotheses.

7.2.1 Methodology

A two-stage research plan will be implemented to create a survey of possible factors that affect VSM. Table 7-2 shows these two stages and the method by which data will be obtained. The research will be a mixture of case studies, which usually include a site visit, phone, and email correspondence. The site visits allow discussions with many of the people involved in the project in order to obtain a better understanding of the events that transpired from various viewpoints. The survey, whose method will be described in detail in the following sections, is a less in-depth process, but includes more formal questionnaire techniques.

	Goal	Methodology
Stage 1	Determine reduced factor list	Case Studies
Stage 2	Develop relationship between factors	Survey

Table 7-2 Research Methodology for VSM

7.2.2 Develop Hypotheses

Multiple case studies were performed to discuss specific value stream mapping events. The format was informal, made up of interviews, which centered on the maps themselves. The attempt was to acquire a relatively large array of different information, since the specific factors that affect the mapping had not yet been determined. This included questions on goals, methodology, and failures of the VSM process. The major question areas are listed in Table 7-3. At each case study a facilitator and at least one participant in the event was interviewed. Four main case studies were performed with information acquired from additional site facilitators.

Area	<i>Primary Interview Questions</i>
Goals of Mapping Event	<ul style="list-style-type: none"> • What are the goals for the VSM event (map production)? • Why was the exercise of making the map initiated?
Procedural Tasks/ Methodology	<ul style="list-style-type: none"> • Describe the format of your VSM event? • What background was necessary when organizing the VSM event? • Were there multiple maps produced in this product area before?
Success	<ul style="list-style-type: none"> • What is your definition of success? For the workshop? For the map • What factors do you think affected the success of this VSM event?
Failure of VSM	<ul style="list-style-type: none"> • In which decisions is VSM lacking from giving you complete advice? • How have you modified VSM from its original version in <i>Learning to See</i>?
Additional Tools	<ul style="list-style-type: none"> • What other tools are used or visualizations are needed in making decisions?

Table 7-3 Question for Stage 1 of VSM Research

The interviews performed led to a reduction in the inputs to only those that are believed to affect value stream mapping. It was found that the methodologies used in multiple companies were similar in content and organization to those in *Learning to See* (Rother and Shook, 1999). Major modifications have not been seen in the methodology used for VSM in order to improve its success. Since the essential VSM tool had not been modified, there must be other environmental factors, which can have an influence on the

success. It was found from the interviews performed that the part chosen to be mapped had a big effect on the types of improvements identified. With products that were simple the recommendations were usually lower cost improvements. The complex product recommendations were usually higher cost and required longer time spans in order to make the proposed changes. In the complex products the solutions seen were within the sublevels, or process boxes of the map and didn't address the interactions between process boxes. It was identified at all case studies that buy-in from management is important to improvement. The idea of motivation was also identified and was believed to be linked to the support of management.

Figure 7-1 shows the hypothesized simplification of the ten inputs to the five considered vital to the implementation of value stream mapping. The importance of motivation and support of the organization identified through the case studies directly correlates to the factors of organization and investment. The difference in identified improvement opportunities between complex products and simple products can be explained through the factors of product complexity and process capability.

Further explanation of some of the concepts in Figure 7-1 is required. Market uncertainty and frequency of changes relate to value stream map obsolescence, which is included in "representative part". Product volume and mix relate to the discussion of which part, within a chosen area, should be value stream mapped in order identify important issues occurring in the chosen area. System process capability, the ability to produce a part in a repetitive fashion, indirectly includes skill level because worker ability can affect a system's yield and cycle time variation. Time to first part, has been eliminated from this analysis because in many cases value stream mapping is being performed on current systems, not for initial system design, which is where that input comes into play.

		5 Environmental Factors Used in This Study				
10 Factors Used to Determine Manufacturing System Design (Fernandes, 2001)		Representative	Complexity	Capability	Organization	Investment
	Market Uncertainty	✓				
	Product Volume	✓				
	Product Mix	✓				
	Frequency of Changes	✓				
	Complexity		✓			
	Process Capability			✓		
	Type of Organization				✓	
	Skill Level			✓		
	Investment					✓
	Time to First Part					

Figure 7-1 Simplification of Ten Inputs for VSM Environment

Using the identified factors it is now important to determine how they affect the success of a VSM event. The definitions and hypotheses that were created for each of the chosen characteristics are located below. These hypotheses will be tested through the use of a survey.

Ability to pick a representative part

A representative part is one that has similar process steps to the majority of the products that go through the system and deals with similar issues (transportation, information exchange, dispatching, etc.) as the majority of the parts. The category also includes the time to obsolescence of the map due to product or process changes.

- **If the map does not represent the problems of the area then it will solve the wrong problems.**

In some cases there are many different part types that go through an area. If the part chosen has a considerably different production sequence from all others that go through the area, or is not a considerably high volume part, then improvements in its processes will not significantly affect the system as a whole. In selecting a part to value stream map is it necessary to pick one that deals with the appropriate issues of the majority of the parts with the most common steps. It is also necessary to be sensitive to the lifetime of your value stream map in reference to the life cycle of the current status of a product.

Product Complexity

Level of difficulty associated with production of a part. Usually measured by estimation of total production man-hours and difficulty of necessary tasks to perform including serial and parallel processing.

- **Less differentiation between value added and non-value added can be seen on the value stream map with increased product complexity.**

In producing a door-to-door value stream map for a product that has a high level of complexity, each box represents a larger portion of manufacturing process than one with a low level of complexity. In the case of assembling a door to a car, a map can be made of the entire car assembly, which shows door assembly as a value added process box. If a map is made of only the door assembly step, sub processes will be shown on the map. These sub-processes include testing, bolting, and tightening. A map made of a complex product causes only representation at a level too simple to differentiate value added from non-value added, it is necessary to go into more detail to allow more information to be seen.

System Capability

Generalized technological ability to repeatedly assemble something with minimal intervention and minimal disruptions (scrap, rework, shortages).

- **If the steps are unreliable there will be no ability to use continuous flow.**

One of the main purposes of value stream mapping is reduction of lead-time by elimination of inventory between steps and, wherever possible, using the ideas of continuous flow (Question 3 of the VSM questions Chapter 6). If the processes

themselves are not reliable, including variable processing time or production of scrap, it is not possible to eliminate all inventory (and make continuous flow) as it is necessary to first make the system run smoothly. Therefore, the full benefits of value stream mapping to aid in combining steps cannot be seen; instead much of the time will be spent on improving reliability of individual steps and trying to eliminate the waste within them. In this case activities, such as a “kaizen blitz” (Pyzdek, 2000), should be much more effective at addressing improvement to the individual process steps than VSM. These improvement methods allow a more detailed study of the process steps, which are usually not detailed in a value stream map.

This observation, that reliability is a prerequisite for continuous flow, agrees with Monden’s theories (Monden, 1998) and the Manufacturing System Design Decomposition (Cochran, 2000). Monden’s relationship between goals and subgoals, Figure 7-2, shows how the elements and improvement tools of lean interact to support the implementation of the high-level goals. An upward flow of activities shows the order in which they are to be completed. It can be seen that cutting inventory, which is required for continuous flow is not an initial step, but requires a tremendous amount of prerequisite improvements. The Manufacturing System Design Decomposition (Cochran, 2000) separates the requirements of system design into six main parameters, which are to be addressed in order: process quality, identifying and resolving problems, predictable output, delay reduction, cost and investment. It can be seen from this list, that in order to improve delay reductions (lead time) it is necessary to first improve quality and disruptions, which are the main types of variability. This may lead to the assumption that VSM should not be the first step in all improvement exercises, as variability in processing steps must first be eliminated before continuous flow can be achieved.

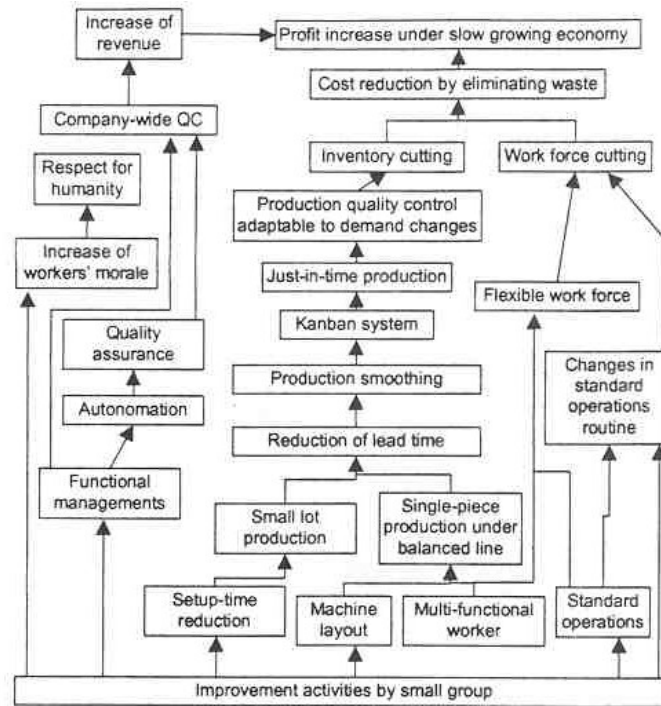

Figure 7-2 How Costs, Quantity, Quality, and Humanity are Improved by the Toyota Production System (Monden, 1998)

Type of Organization & Investment

Level of innovativeness (change) supported on the factory floor.

Availability of money and labor to make change.

- **Even with a good map, without the availability of money, labor, and leadership to support the change no implementation will occur.**

Even in circumstances of identification of innovative improvements, an implementation of them cannot occur if a barrier of leadership involvement and lack of financial involvement of the company occurs. A good map, or reasonable map is one that includes improvements that can be done in the time frame chosen.

7.2.3 Survey Organization

It is necessary to determine the relationships of those factors identified through the case study. It is the goal of this research to use these five factors and correlate them with value stream mapping success. It is proposed that a possible use for this information is to create a matrix (Figure 7-3). The matrix takes the form of an advice tool where a company can determine at which level they meet each of the characteristics and it can

help them to determine how well VSM fits their needs. It is envisioned that under each of the five characteristics, there is a description of levels at which each characteristic can be met. A company should be able, under each, to determine where the product being discussed fits and this will lead to a level of success that can be reached with VSM.

Environmental Characteristics					Success
Pick a Representative Part	Product Complexity	System Capability	Type of Organization	Investment	
				➔	

↑ VSM appropriate

Figure 7-3 VSM Matrix

Success

Before performing a survey to test the relationships it is necessary to determine the possible levels of success to which value stream mapping should be correlated. In order to determine the affects of these hypotheses on VSM, it is necessary to develop the possible hierarchical levels of success that can occur from a value stream mapping event. In many cases, the objective of running a value stream mapping event is to design a future state system and to implement the designed system. This is the most common reason to use value stream mapping, to make a change. In some cases while attempting to implement these changes the company finds they have implemented some isolated pieces of the identified improvements, but that no performance improvement can be seen by the customer.

There are other possible outcomes of running a value stream mapping event. In some cases, value stream mapping is a simplistic way of introducing new lean principles to a company. This knowledge can be used in later designs or in other areas, but does not lead to immediate improvement in this area. Figure 7-4 shows a hierarchy of proposed success levels, from the lowest (learning only) to the highest (performance improvement). These five levels will be used to measure the success of the VSM exercise.

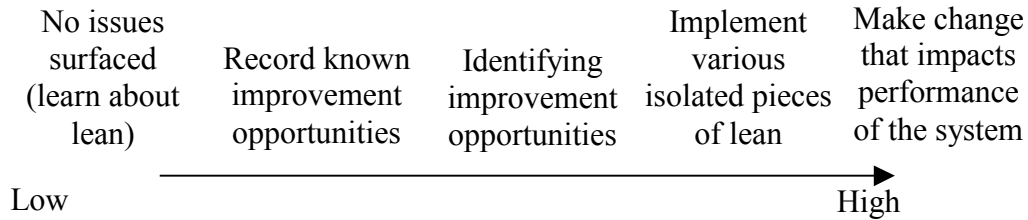

Figure 7-4 Hierarchy of success

A survey was administered to attempt to correlate the hypotheses above with success of a value stream mapping exercise. The survey was created directly from the factors and theories already discussed. The questions, which are separated by environmental factors, are shown in Table 7-4. The survey is located in Appendix D. All of the questions were based on a five-point scale, where a five is assumed to be the best agreement between the factor and value stream mapping. Included after each question in the table the five point and one point answers have been indicated. In scoring the survey the questions were weighted equally so that each of the five environmental characteristics was ranked on a separate, but equal, five point scale. Those surveyed included facilitators and participants and were identified through company points of contact. The survey was placed on the web and allowed anonymous responses.

Identified Factor	Number of Survey Questions
Representative	1. Choose which of the following best describes the <u>products</u> that go through the area depicted in the map: (all products/only the one mapped) 2. Which of the following statements describes the area mapped in the value stream event, assuming no process improvements have been initiated: (will never change/processes will change next week)
Complexity	3. The average number of tasks <u>within</u> a <u>process box</u> in the value stream is? (10 steps or less/too many to count) 4. Would you classify the <u>process boxes</u> as having: (serial/parallel processes)
Capability	5. Disruptions (scrap, rework, shortages, etc) throughout the value stream mapped area: (never happen/are a fact of life) 6. For the <u>product</u> mapped in the value stream: (variation in cycle time is negligible/impossible to predict)
Type of Organization	7. Please pick which of the following best explains the environment in which your <u>VSM</u> event was run: (leaders foster improvement/check box exercise)
Investment	8. Please pick which of the following best explains the environment in which the <u>VSM</u> event was run: money and labor are (in abundance/impossible to get)
Success	9. Please pick which of the following best describes your experiences while implementing improvements towards the future state: (an improvement was seen in the performance of the customer /did not surface any issues)

Table 7-4 Value Stream Mapping Survey Questions

7.3 Results

The following section will present the results of the survey through graphs generated by data comparison. This will include trends seen in the data through addition of factors and will compare different factors. The data was combined using multiple techniques but addition was found to be the most indicative because it allowed no single factor to outweigh the others. The results of the survey were discussed with selected participants to clarify any questions related to the survey.

7.3.1 Main results

The following section will review the results obtained through the survey described in the last section. Figure 7-5 shows a trend between the addition of the environmental factors and the success of value stream mapping event. A score of twenty-five is the highest possible total environmental factors score, showing an activity that would be most appropriate for VSM. The highest success score is a five, correlated with making changes that can be seen by the customer. Each hypothesis cannot be verified individually using this survey method, but the trends shown in this section verify the combined effect of the hypotheses. There is a correlation between the sum of the environmental factors and the success of the VSM event. Table 7-5 describes the circumstances of points located in the Figure 7-5 in order to give more insight into the information within the graph.

$$Total = \sum_{i=1}^5 EnvironmentalCharacteristic_i$$

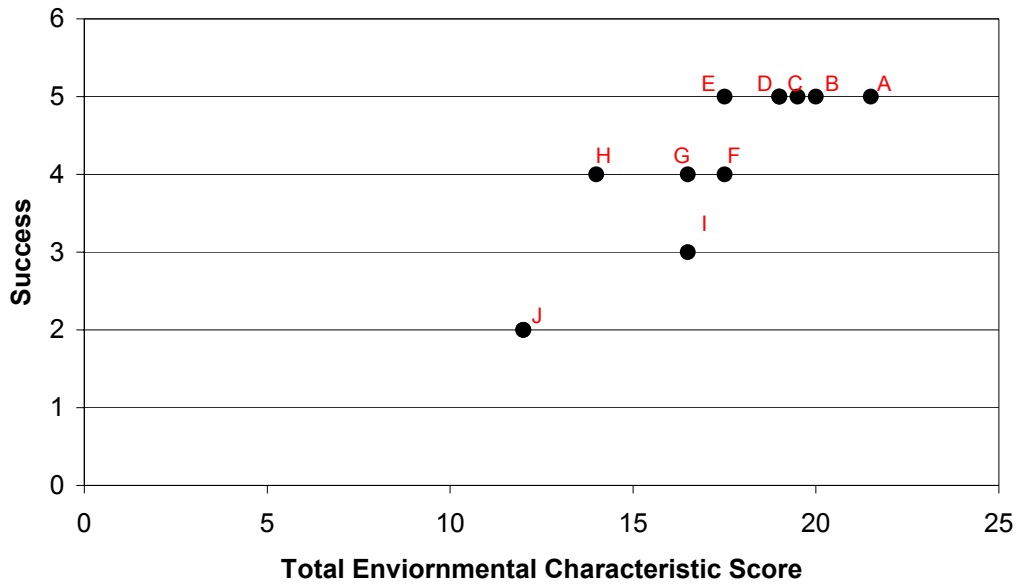

Figure 7-5 Comparison of Environmental Characteristics to Success

Case	Description
A	Shown to use the tool repeatedly on the same area demonstrating the continuous value in the tool and proving its appropriateness in this situation.
B	Event was performed on a simple part where value was easily differentiated, and combination of stations for more continuous flow was possible.
C	Improvements identified included elimination of unnecessary steps like extra crane moves. VSM was done at a level where value added could be differentiated, but the area was not mature enough for continuous flow.
D	Event was able to identify improvements including reduction of testing and inspection. The improvements have taken a longer time frame than anticipated due to the changing of priorities by the company.
E	The changes can all be considered low hanging fruit. In this case standardized procedures did not exist and the VSM helped to identify them.
F	In order to make a dramatic reduction in cycle time a large investment was necessary but it was not received.
G	The activity did enumerate improvement opportunities, but impact on the bottom line did not occur because of the loss of budgetary funds.
H	Due to high motivation the activity was relatively successful even though the product was very complex.
I	This event was subjected to a change in organizational requirements and vision for lean. The change shifted priority away from the VSM event.
J	The event was run on a product that was too complex to see value added and non-value added. The event was also run as a check the box type of activity.

Table 7-5 Description of Cases from Figure 7-5

7.3.2 Data Verification

This section presents the techniques used to validate the survey results. The survey data was checked to make sure it fit the designed restrictions. Problems were found with some responses to the survey and these were eliminated before data correlation began.

The reasons fit into three categories:

1. The survey was filled out by those using value stream mapping in a non-manufacturing environment.
2. The survey described, not an individual event but the survey respondents' experiences as a whole.
3. VSM was not being used in the correct event format. This includes not producing all three steps of a value stream mapping event as well as the use of a secondary tool to identify improvements.

The responses of the participants who did not meet any of the categories mentioned above can be seen in Figure 7-6.

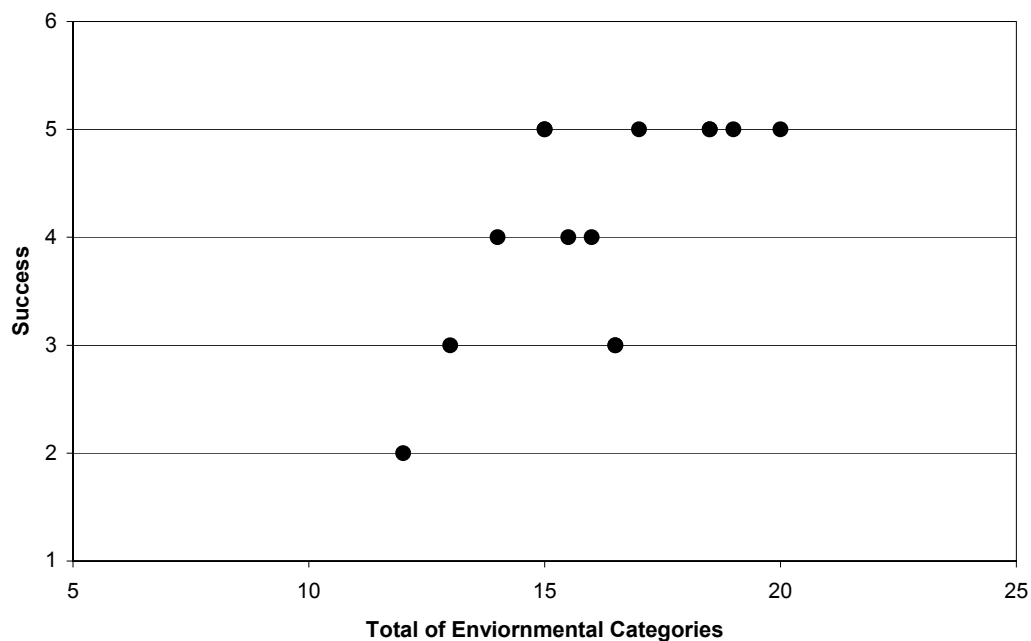

Figure 7-6 Original Survey Responses

In order to verify the ability of the survey to capture the data necessary many of the responses were further investigated and verified by follow up activities. The results

were slightly modified by the survey respondent and the author after a discussion of the event. Figure 7-7 shows the original and new placement of the verified points. It can be seen that the majority of them moved to the right, giving them a better score than originally. One point did change success level. This movement was because the changes recorded in the VSM event had been suggested before VSM and they had not notated that in the results. This disparity is differentiated between a success level of two and three.

The main reason survey cases improved in total score (moved to the right) had to do with the representative part category, which was misunderstood by most survey participants. This category attempts to capture how representative the product chosen was for the entire mapped area. It was seen that in almost all surveys recorded, the area mapped was a good representation, but the grasping and ranking of this category seemed difficult for survey participants, perhaps the question was not clearly stated in the survey. Other cases also included misrepresentations of capability and organization. There were no trends in these misrepresentations.

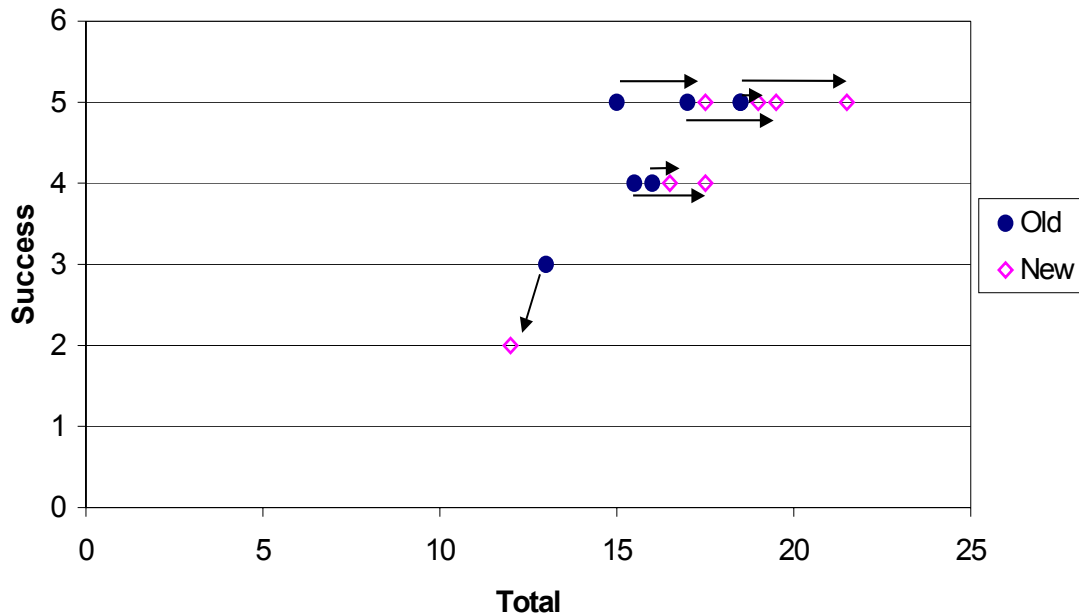

Figure 7-7 Comparison of Surveys to Discussions

Figure 7-7 shows the change in results after follow up surveys. Because we believe that this data more accurately represents our original intention, it will be used for all analysis. This chart was shown in Figure 7-5.

7.3.3 Additional Results from Survey

The following section will review additional trends and relationships found from the survey results. These graphs will compare the environmental factors. Some of these trends identified have impact beyond value stream mapping. These relationships exist above and beyond the VSM exercise.

Investment vs. Organization

Figure 7-8 compares the support of the organization (leadership commitment) to the investment (monetary and labor allocations) to make the implementations suggested at the VSM event. The trend seen here indicates that as support for value stream mapping goes up, the investment in subsequent activities also goes up. This trend leads to the recommendations that the combination of these two factors should be considered. The direct relationship supports the idea that when management of an organization supports change they reflect that by investing money and support in that change.

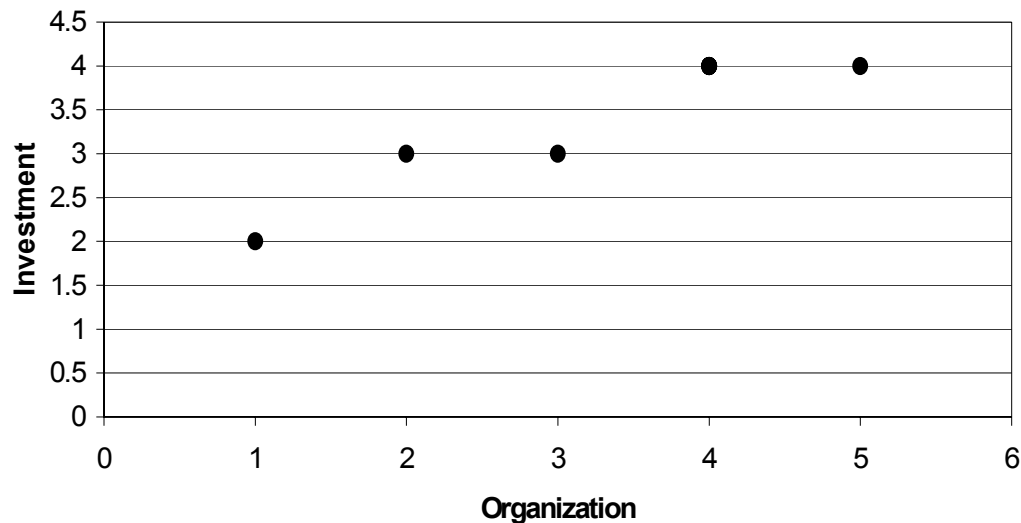

Figure 7-8 Investment compared to Organization

Capability vs. Complexity

The relationship between complexity and capability can be seen in Figure 7-9, where a highly complex part is associated with a score of one. With an increase in system capability there is a trend toward reduced complexity of products. It is speculated that in many cases a decrease in system capability forces a system to increase its complexity. An example of this phenomenon occurs when a process is not capable.

Correcting this might lead to testing, or checking, or even the addition of more assembled parts to improve the quality. This increases the assembly complexity in order to guarantee reduced overall defects. Because of this relationship perhaps one of these factors is a predictor for the other.

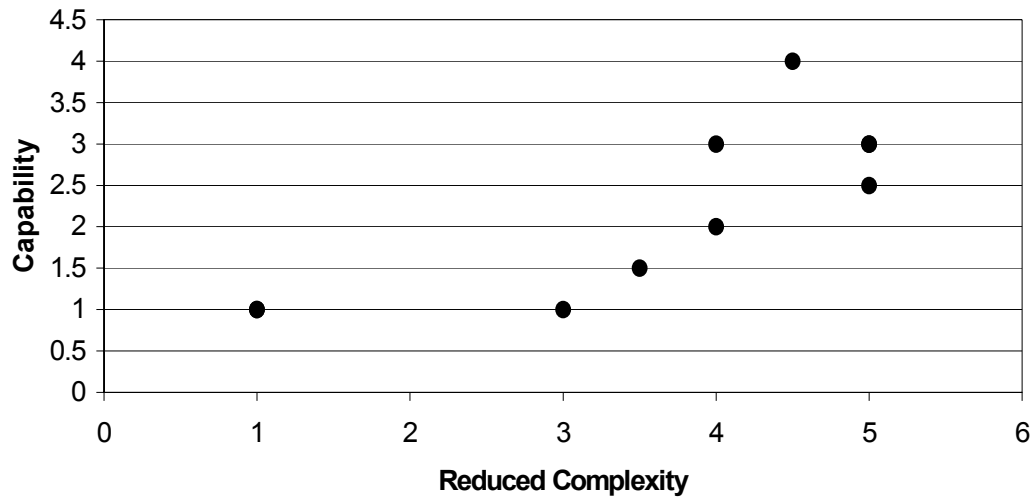

Figure 7-9 Complexity versus Capability

Reduced Set of Factors

Figure 7-9 and Figure 7-11 suggests a possible reduced set of factors, which can be used to predict the success of VSM. This suggests that we should see a correlation between one characteristic from the first set discussed (organization and investment) and one characteristic from the second set (capability and complexity). The two more sensitive factors were chosen and graphed against success. Figure 7-10 shows the relationship and verifies that their combination is a predictor for success.

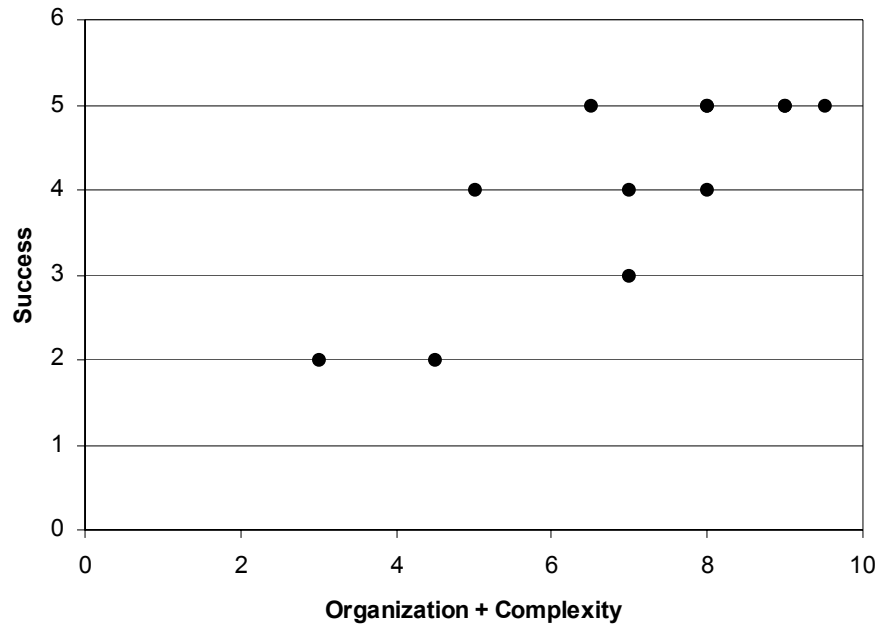

Figure 7-10 Comparison of reduced set of Characteristics and Success

Factor Combinations

Figure 7-11 shows the relationship between the sum of score of the three product and process categories (ability to pick a representative part, product complexity, and process capability) and the sum of the score of the organization categories (type of organization and investment). There is no trend shown in the diagram. This supports the hypothesis that the two sets of characteristics are independent of each other and both categories must be included as predictors of the success of value stream mapping.

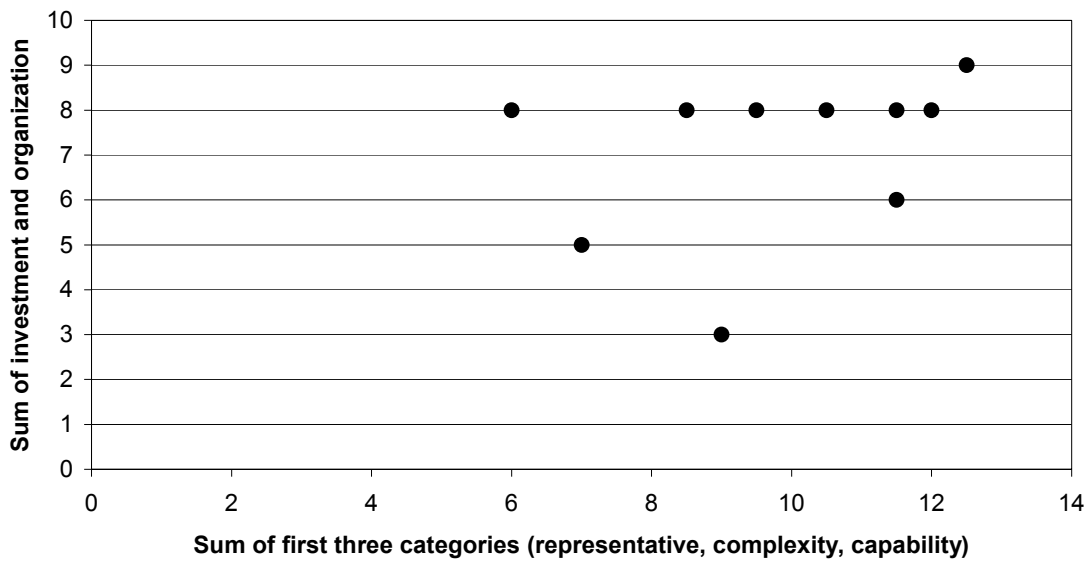

Figure 7-11 Product and Process Characteristics versus Organizational Characteristics

7.4 Proposed Value Stream Mapping Worksheet

From the survey respondents and the case studies many lessons were learned about how the characteristics affect the success of value stream mapping. Each factor plays a different role in the process between current state map production, future state map production and implementation. This relationship will be explored in this section. From this verification of the relationship between the factors and success, an advice matrix has also been created which will be presented within this section.

7.4.1 Implementation

In Figure 7-12, the proposed affect of each factor on the VSM process is shown. It is not necessary, in order to have a positive outcome from VSM, that all five factors are met. For companies who want to use VSM as an exercise to learn about lean principles or the flow of their product it might only be necessary to produce current and future state maps. Production of the current state and future state make up the value stream mapping event noted in the figure. The successful use of VSM in this case is only affected by the

first three characteristics noted. If, in order to evaluate the project as a success, you must implement change, then it is necessary to include the last two factors in your evaluation.

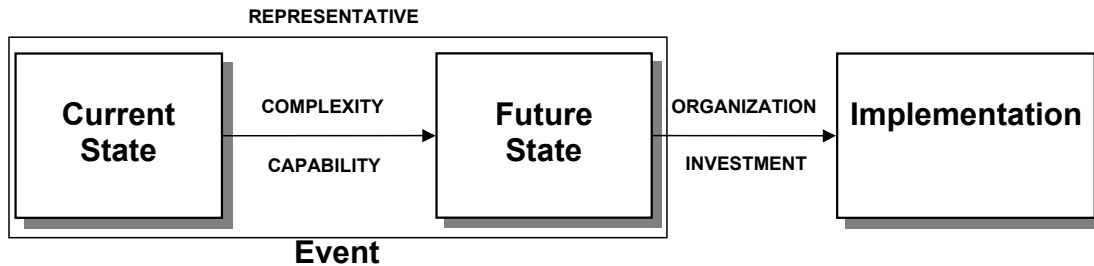

Figure 7-12 The Effect of Environment Characteristics on Implementation

It is hypothesized that complexity and capability affect the ability to draw a future state map from a current state. The ability to pick the appropriate representative parts affects whether this event identifies the correct opportunities for success. This is why “representative” is shown on the box that encircles the current state and the future state. These three factors affect the making of a map that identifies new improvements. Once the map is made, and the event is complete, it can be shown that without the support of the organization and the investment necessary for change, there is no ability to implement it. This format, which is also shown graphically in Figure 7-12, supports the observations seen in the case studies. It is interesting to note that the three characteristics that affect the event can be considered physical product/process characteristics while the two characteristics that affect the success of the implementation are people oriented choices which are, therefore, more controllable by those attempting to use value stream mapping.

7.4.2 Value Stream Matrix

The matrix proposed is shown in Table 7-6 and can be used to determine the appropriateness of a VSM event. Using the five environmental characteristics, and the insights discussed about each, a company can rank itself and determine what factors need improvement in order to make value stream mapping more successful or to determine for what purpose it can be run. The matrix should be filled out in reference to an individual VSM event.

The matrix is designed in a similar format as Figure 7-12 with the first three columns associated with the value stream mapping event, the next two with the ability to implement change, and the last one shows the correlation between these factors and the success expected for value stream mapping, from recording already known improvement opportunities to making a measurable change. An environmental characteristic score can be developed from the matrix to determine whether value stream mapping will be a valuable tool. This matrix describes similar criteria to those addressed in the survey and is organized in a proposed format that can be used by those determining improvement opportunities.

Pick a Representative Part ¹	Product Complexity	System Capability	Type of Organization	Investment	Success ⁷
All products go through the process depicted and the process drawn will not be changed ²	Tasks per process box is 10 steps or less and all processes are serial ⁴	Disruptions ⁶ almost never happen and variation in cycle time of a process box is negligible.	Senior leaders reinforce transition and foster improvement throughout the VSM.	Money and labor are in abundance	1 An improvement was seen in the performance of the mapped area
The majority of the products go through the process depicted and they will not change before improvements can be made (1 year)	Tasks per process box is greater than 10 steps and most processes are serial	Disruptions are low enough not to impede flow and variation does not impact flow	The organization promotes changes and improvements	Money, and labor are available but limited	2 Improvements were made using additional projects, but not enough were initiated to see an improvement
Half the products go through the process depicted and the process drawn might change in less than a year.	Tasks per process box is greater than 100 and the processes are a mixture of serial and parallel	Occasionally disruptions force out of sequence work and variation in cycle time impacts flow	Level of commitment among management is variable	Money and labor can be made available but an extensive justification process exists	3 The event helped to recognize new opportunities but no implementation occurred
A few of the products go through the process depicted and the process drawn might change in the next few months	Tasks per process box is greater than 1000 and most processes are parallel ⁵	Disruptions and variation in cycle time are barriers to continuous flow	VSM was initiated by upper management with no lower management support, or visa versa	Money and labor are hard to come by even if justified	4 The event was a good way to record improvements that have already been suggested
Only the product mapped goes through the process shown and the processes drawn might change next week, making the map obsolete. ³	Tasks per process box is too many to count and all processes are parallel	Disruptions are a fact of life and cycle time of a process box is nearly impossible to predict	The VSM event was perceived as a check the box exercise	Money and labor are impossible to get	5 The VSM event did not help surface any issues

Table 7-6 VSM Matrix

¹Ability to pick a Representative Part- within the products that go through the mapped area²Assuming no process improvements are initiated³Assumes multiple products go through the area, if only one product goes through assume answer of all.⁴Serial- only one task is occurring on the product at one time⁵Parallel- multiple items of the product are being worked on at one time⁶Disruptions – scrap, rework, shortages⁷Improvements are seen in reference to the customer

7.5 Additional Insights

The companies visited all used slightly different varieties of value stream mapping. These differences are due to the history of value stream mapping in the company and the types of products that are produced. Though there is no knowledge of which method of using value stream mapping is most appropriate, this section will explore some additional tools and variations that companies have developed to use in conjunction with value stream mapping and some additional opportunities identified through this study.

Diagramming Techniques

Companies have been seen to add both color and alternative symbols to their value stream maps. Color-coding has been seen to aid differentiation of value added from non-value added. In other activities color differentiates operations from testing, and in others it shows ownership of steps by departments, supervisors or machinists. One company believes that learning an entire symbol language in order to understand value stream maps is not necessary. Therefore, they have limited their language to more universal symbols including a stop sign for waiting and an arrow for movement. With these symbols, waste is very clear.

Additional Tools

In determining which improvement opportunities to attempt first, different methods of ranking have been used. One company uses pie charts to measure various aspects of the system. These charts determine how much of a resource is used at each step, such as money spent or value added. This tool allows someone to look at the steps in terms of different factors.

It has also been seen that companies try multiple ways of measuring and graphing the difficulty inherent in each of the suggested implementations against the possible impact that they will have (Figure 7-13). They then use this information to rank importance of different identified improvement opportunities.

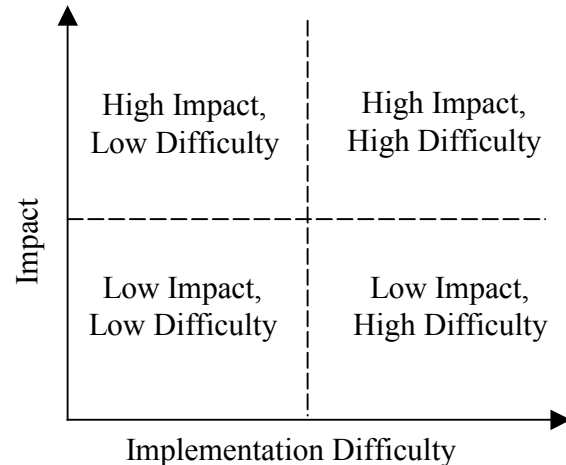

Figure 7-13 Impact versus Implementation Difficulty

Tools Identified by the Study

Value stream mapping is seen as a thought-provoking tool that permits tremendous leeway in its methodology to allow development of future states using the creativity of those involved. Some new areas for possible development have been identified from the case studies. These include increased guidelines on necessary inventory levels between steps. There is a need to develop “back of the envelope” calculations that can be used quickly in the exercise to determine the appropriate inventory level. Similar to this decision is also the trade-offs between lead time and cost that occurs when choosing the pacemaker. A tool can easily be developed to graph these different measurements depending on the pacemaker, if information about the system can be obtained from the system designers.

7.6 Improvement Opportunities

As previously seen the survey highlights some interesting trends about the relationship between the environmental factors and the possible outcomes of the VSM event. The survey results and telephone conversations have led to a few suggestions of improvement opportunities for the matrix of environmental factors (Table 7-6), the survey, and the analysis.

It is suggested that the term success be changed to positive outcome, and the descriptions be changed accordingly. This change is made because it must be understood

that if the goal of the workshop is to learn about lean principles then this can be the positive outcome of the exercise. Implementation must not always be the goal.

There are more dimensions to the idea of a positive outcome, or success than just whether it occurs. It is recommended to find a way to represent the time it takes to fix the system and include that in success. It is necessary in acquiring data to acquire information on success from multiple angles; it is therefore recommended that the section in the survey to measure the outcomes of the event be expanded to include additional questions.

Many circumstances can make VSM a beneficial activity. In future studies it is recommended that separation occur between those in low hanging fruit cases from those in more mature situations. This is recommended, since it is believed that VSM can be beneficial for low hanging fruit situations at a different environmental score value than with mature situations.

Many companies do not use VSM alone, making it difficult to measure the benefits of VSM in the context of other improvement tools and activities. There is a need to devise a way of separating them in order to measure the effects of only VSM.

References

Cochran, David S., Jorge F. Arinez, Jamer W. Duda, Joachim Linck. "Decomposition Approach for Manufacturing System Design." A Collection of Papers Published by Professor David S. Cochran. MIT. September 2000.

Fernandes, Pradeep. "A Framework for a Strategy Driven Manufacturing System Design in an Aerospace Environment - Design Beyond Factory Floor." Masters Thesis. MIT. Cambridge, 2001.

Monden, Yasuhiro. *Toyota Production System: An Integrated Approach to Just-In-Time*, Norcross, GA: Engineering and Management Press, 1998.

Pyzdek, Thomas. *The Six Sigma Handbook: A Complete Guide for Greenbelts, Blackbelts, and Managers at all levels*. New York: McGraw Hill, 2000.

Rother, Mike and John Shook. *Learning To See: Value Stream Mapping to Add Value and Eliminate Muda*. Brookline, MA: Lean Enterprise Institute, 1999.

PART TWO CONCLUSION:

IMPLEMENTATION IN YOUR COMPANY

Value stream mapping is being widely used within companies to make improvements to existing facilities. Through a survey of those using VSM it has been seen that it is being used as a way of organizing and determining improvement opportunities. It was not observed that the tool is being used in the designing of manufacturing systems. The tool is also very popular for use in understanding current systems. Companies like to use it as a discussion point, and the determination of where they are now. Many are then using other tools to develop future improvements. This validates the placement of the tool within the implementation and modification loops on the Manufacturing System Framework described in Chapter 3.

The study performed here showed a relationship between the five identified environmental factors and the success of the value stream mapping event. It is, therefore, recommended that before performing a value stream mapping event the company should consider what its goals, objectives, and necessary positive outcome for the event are, in order to ensure success. The company should then use the tool to identify the appropriateness of value stream mapping in consideration of its and determine if another tool would be more appropriate.

The survey results showed other interesting general lessons addressing the fundamental relationships between environmental factors. The correlated relationships shown test the need for the individual inputs, both in the VSM factors, and in the introduced 10 inputs to a manufacturing system. This shows the need for more work on these factors and their relationships to better understand their effects on manufacturing system design.

In many companies value stream mapping is seen as a tool that can be used in all circumstances. The study performed exhibited proof that value stream mapping is not successful everywhere and, therefore, its appropriateness must be considered in advance of performing a value stream mapping event.

Chapter 8 Conclusion and Recommendations

This thesis studied manufacturing system design through an in-depth look into the case study of a Flexible Manufacturing System and an investigation of the appropriateness of a common improvement tool, value stream mapping. This section will review the conclusions of these studies and make recommendations for future research.

8.1 Flexible Manufacturing System Case Study

A case study of Heidelberg Web Systems Flexible Manufacturing System was performed that included an analysis of the current system as well as the proposed design for the future system. The goal of this research was to understand the problems and obstacles of manufacturing system design. An in-depth analysis was performed at each step of the process and was presented with reference to the methodology and tools used. Presented also was the framework used to complete the system design.

In the first step of the process it was found that the system in place was not meeting the needs of the company. A relationship between utilization and lot size was found which led to determination of root cause. It was identified through this study that the machinist was an overextended resource who was required to deal with all disruptions.

As the second step, a system selection exercise was performed. It has been shown that a Flexible Manufacturing System is not appropriate in the circumstances for which it is being used. There is a mismatch between the system parameters and goals and the Flexible Manufacturing System. Since the inception of the current system the required system parameters have shifted, causing the system to become inappropriate. An FMS cannot be easily modified to deal with such changes.

As part of the initial system design, a hybrid system is proposed which allows the system to be divided into subsystem to allow high volume jobs not to be interrupted by low volume ones. The hybrid system proposed is a dynamic system that can be modified to deal with changes in the parameters and goals. Through the use of stand-alone machines reallocation of labor can be used to modify the system type dynamically at low investment.

It is recommended that in determining future systems, possible dynamic changes in market requirements be considered. Future insights into the boundaries of the tools

used in system design is necessary through future case studies. The limitations of Miltenburg's methodology are not known and would be considered valuable research.

8.2 Value Stream Mapping

Value stream mapping is being used in many different circumstances including manufacturing environments (fabrication and assembly) and other areas of business (product development, procurement, and purchasing). Value stream mapping is a simple to learn mapping tool that has helped many to identify possible opportunities that could not be seen without the door-to-door perspective it allows. Although the tool has been shown to improve some systems considerably, it has also been seen to fail to reach implementation in others.

It was hypothesized that certain preconditions affect the success of a value stream mapping event. The environmental factors identified in this document, derived from case studies and confirmed through the use of a survey, are a valuable methodology for evaluating the appropriateness of value stream mapping for a specific area. It has been verified that success is correlated with the addition of: ability to pick a representative part, product complexity, system capability, type of organization, and investment. The results were presented in an advice matrix form, which can be used to determine the appropriateness of VSM in a production area.

It is recommended that additional work be done in this area of study to verify and expand the knowledge acquired here. This study was performed to show a possible trend. Now that this trend has been established, it is necessary to do a more in-depth analysis to guarantee that additional categories have not been overlooked and to better understand the pattern that occurred.

It has been seen that VSM, like many other tools, is being used in many situations for which it is not fully appropriate. In general there is no understanding of what tools are appropriate in what circumstances. Therefore, it is believed that the type of analysis performed here should be done for additional tools. Guidance on the limitations and uses of improvement tools is required in order to increase success of the improvement opportunities. The method of organizing the tool's appropriateness around the ten system design inputs has been shown to be valuable in this study. Another methodology, which

has been successful, is to organize different improvement tools around different types of waste that can be present in the system. This methodology has been used in the supply chain improvement efforts. It was seen to be valuable in identifying the appropriate uses of different improvement tools and the needed for additional tools (Hines, 1997).

References

Hines, Peter and Nick Rich. "The Seven Value Stream Mapping Tools." *International Journal of Operations and Production Management*. 1997.

Appendix A Manufacturing System Design References

Hopp and Spearman (1996)	<i>Factory Physics</i>	Description of manufacturing system behavior using fundamental relationships such as Little's Law and Economic Order Quantity.
Skinner (1985)	<i>Manufacturing: The Formidable Competitive Weapon</i>	Written for top management, discussion of manufacturing strategy including focused factories
Miltenburg (1995)	<i>Manufacturing Strategy</i>	Outlines possible goals of the manufacturing system, and what production system meets those goals. Compares system characteristics to these goals, and even attempts to give levers for system change.
Gershwin (1994)	<i>Manufacturing Systems Engineering</i>	Explains mathematical phenomenon of manufacturing systems behavior and includes description of line analysis and CONWIP.
Womack and Jones (1996)	<i>Lean Thinking: Banish Waste and Create Wealth in your Corporation</i>	Lean thinking-key principles that should guide actions to implement lean. Includes specific examples of lean implementation.
Womack, Jones, and Roos (1991)	<i>The Machine that Changed the World: The Story of Lean Production</i>	Provides benchmarking data comparing mass production and lean production in the car industry.
J T. Black (1991)	<i>The Design of the Factory with a Future</i>	Presents a step-by-step strategy on the implementation of the Integrated Manufacturing Production System (JIT).
Suri (1998)	<i>Quick Response Manufacturing: A Company wide Approach to Reducing Lead Times</i>	Description of QRM: a company-wide strategy for cutting lead times in all phases. The book also reviews POLKA, an alternative to kanban for material control.
Rother and Shook	<i>Learning to See</i>	Value stream mapping tool explanation includes symbols and questions to ask
Muther (1973)	<i>Systematic Layout Planning</i>	Step by step plan for design of a system, including worksheets
Cochran (2000)	<i>A Decomposition Approach for Manufacturing System Design</i>	Decomposition of general objectives and means for repetitive manufacturing systems. High-level functional requirement (ROI) is broken down into lower level functional requirements and design parameters.

Figure A-1 Manufacturing System Design References

Appendix B Case Study Framework Description

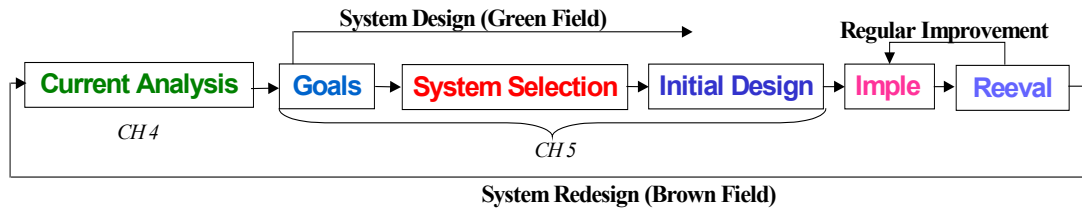

Figure B-1 Generalized Framework for System Design

Analysis of Current System	Goals	System Selection	Initial Design
<ul style="list-style-type: none"> ❑ What triggered a study? (symptom) ❑ What is the root cause of the symptom? (problem) ❑ Is this the bottleneck? ❑ Is the problem solvable without <u>total</u> system redesign? ❑ Determine system parameters. 	<ul style="list-style-type: none"> ❑ What are the goals of the system? 	<ul style="list-style-type: none"> ❑ Do the goals match the current system? ❑ Does the current system match the system parameters? ❑ Comparison to others for benchmarking. ❑ Pick a system type. 	<ul style="list-style-type: none"> ❑ Determine structural and infrastructural elements. ❑ Determine how each element can be designed to fit into the chosen system type. ❑ What are the tradeoffs of certain decisions? ❑ Determine expected benefits and measurements. ❑ Determine how the system fits into its supplier and customer.

Table B-1 Framework Questions for System Design

B.1 Analysis of the Current System

The goal of the first step of this methodology is to make sure all necessary identification of mistakes, pitfalls and problems from the current system is transferred to the design of a new system. It also compels the demonstration that a new system is necessary. The questions below highlight some of the information, which is necessary to obtain when reflecting on the current system. If the design effort has no preceding

system that it is replacing, then this step can be skipped. To obtain answers to the questions, it might be necessary to collect data on the system. A suggested multi-day observation of the system is recommended as well as interviews with those who are in the system daily.

What triggered a study? (symptom)

It might not be clear as to why the system redesign is being performed. In some cases, a decline in performance is the reason. Try to pinpoint one reason why the study is being conducted. This will help you to determine the goals of the future system. Do not forget to ask those working in the system. In many cases, they can help to describe the problematic occurrences in the system, and what influences them.

What is the root cause of the symptom? (problem)

The problem cannot be fixed until it is determined why that problem is occurring. In some cases, the answer may be easy, such as a communication issue, reliability of machinery, or the missing of standardized work. But it may also be more complex, such as a mismatch between the system parameters and the system put in place. Of course, there may be multiple causes for each symptom. It might be necessary to do some data collection or experimentation to fully discern the problem. Every problem should be articulated using a few fundamental concepts because when the list is too extensive, a simplified resolution will never be found.

Is this the bottleneck?

In some redesign efforts, considerable money and time are spent fixing an area that has a considerable amount of waste or lead-time associated with it. Sometimes this occurs because it was simpler to pinpoint the problem and the solution for one area, than to determine its role in the entire product or program view. If cycle time reduction is the enterprise level objective and the area you are focusing on is not on the critical path of production, then your efforts are improperly focused. Such efforts may reduce cost of the product, but, if it does not meet the competitive strategy, then that time has been misused and could have been used in a process on the critical path of production.

One method for determining the appropriate areas for improvement is to use value stream mapping to study the entire flow of the product. From the value stream map you can compare the mismatch between the final production rate and the area you are

studying. If the redesign of an area has not yet been identified, looking at the value stream map will help to identify possible improvement areas, and to see their effects on your company's measurable quantities. If lead time is not your business objective, value stream mapping may not be the appropriate tool to determine if the area chosen is the bottleneck. Detailed guidance and evaluation of value stream mapping can be seen in Chapters 6 and 7.

Is the problem solvable without total system redesign?

If the questions addressed above uncover improvements that can be made within the current system structure and the performance of the system can be improved to within acceptable measures for management, then those problems should be addressed without the large investment of an entire system redesign. Such possible changes include redistribution of other resources including people, and restructuring of parts into groups.

Determine system parameters and performance measures

In order to determine the appropriate type of system, it is necessary to acquire a general set of system characteristics. Studying these factors will allow you to verify reasons why the current system is not performing as required.

System parameters include: market conditions, product mix, product volume, frequency of changes, product complexity, system process capability, type of organization, and skill level. These include those external, or not under control of the design, and internal, within control of the factory. (Fernandes, 2001)

Possible performance measures include machine utilization, machinist utilization, lead-time, and system output. Performance measures are how the system will be evaluated on its operation.

B.2 Goals – selection of criteria

Determining the goals of the system help to crystallize what the needs and competitive advantage of the manufacturing system are. The goals of the system will impact the system selection part of the design.

What are the goals of the system?

The competitive goals of the system can be thought of as the system traits that are provided for the customer (Miltenburg, 1995). Possible goals include: flexibility, manageability, productivity, cost, delivery, innovativeness and quality. The goals

directly correlate to the competitive advantage of the product. In a manufacturing system, “some goals will be provided at higher levels than others because no single production system can provide all outputs at the highest possible levels.” Therefore, it is important to consider wisely the necessary system goals; and determine their importance. (Miltenburg, 1995)

B.3 System Selection

The main goal of system selection is to determine the type of production system that is appropriate. The type of system chosen will determine those system goals that will be provided at high levels. Possible system types include: job shop, continuous flow shop, flexible manufacturing system, and just in time. As stated earlier, the system parameters will play an important role in this step. Within the initial design step, it will be very important to have chosen a correct system type, since that will be the basis for all initial design decisions. As will be described, the system type will be chosen primarily to meet the system goals, but must match system parameters as well. Miltenburg’s Manufacturing Strategy Worksheet, seen in Chapter 3, can be used to accomplish this step.

Do the goals match the current system?

Consider the type of system currently used, is it not performing well because it was intended to deal with other types of goals? Literature exists to aid this comparison. Miltenburg’s Manufacturing Strategy identifies how the manufacturing outputs (in our terms goals) vary with system type. Each type of system is ranked on each goal and its ability to meet that goal.

An example of such a situation occurs when putting a job shop in place if your main goal is quick delivery. A job shop is known for being very flexible to new and varying parts. But its system in many cases has large setup times associated with it and, therefore, it generates a long delivery time.

Does the current system match the system parameters?

In some cases, the problem associated with production is that the current system does not match the current system parameters. Many authors have included charts that compare systems types to system parameters. The most common comparison is product volume and mix. An example of this type of chart can be seen in J T. Black’s *The*

Factory of the Future seen in Chapter 5. These charts are useful to help align your manufacturing system with your system parameters.

Comparison to others for benchmarking

When possible, it can be very beneficial to test your hypothesis by visiting other systems, either similar to your current or your future ideas. See what their system parameters and system goals are and how their system is performing. Also, ask questions about how they are managing the system. This should verify that your current system is not performing as requested due to parameters outside of your control, and that the redesign is necessary and will make improvements.

Pick a system type

As stated, the outcome of this step is a system type that best fits both your goals and your system parameters. Also consider in this decision if there are any constraints that will not allow you to choose the most optimal system type, such as timeline for redesign and investment. Although you should not allow these, or any of the system parameters, to limit your possibilities, they must be strongly considered when weighing the risks of a radical change.

B.4 Initial Design

It is now necessary to design the details of the system. These include specific machine types, operator job descriptions and priorities, and possible effects on dispatch and engineering. In designing a system, it is recommended that you determine the possible elements of the system and distinguish between the structural and infrastructure elements; this will help to guarantee that all aspects of the design are considered.

Within this step, different system types will warrant addressing different issues and using different tools. General guidelines that can be used no matter what the design is will be discussed to aid all manufacturing system designers.

Determine structural and infrastructural elements

The splitting of system design into two types of elements, structural and infrastructural allows dealing with important issues in an organized framework. These can be split in many ways, and should be divided in a manner, which makes the most sense for the project at hand. It is necessary to check the completeness of your list, and

this can be done by checking it against some of those determined by other authors, Table B-2. Each of these areas must be discussed and addressed within the final system design.

Type of Decision Area	Miltenburg (1995)	Skinner (1974)
Structural	<ul style="list-style-type: none"> • Facilities • Process technology • Sourcing (suppliers and vertical integration) 	<ul style="list-style-type: none"> • Plant and equipment
Infrastructural	<ul style="list-style-type: none"> • Production planning and control • Organization structure and controls • Human resources 	<ul style="list-style-type: none"> • Production planning and control • Organization and management • Labor and staffing • Product design and engineering

Table B-2 Subsystems that Constitute a Production System (Miltenburg, 1995)

Determine how each element can be designed to fit into the chosen system type

Once the system elements have been determined, it is necessary to address each element. It is important that you align the elements to the traits of the chosen production system. In this case, it is advised that you study the chosen production system type through current literature, as infrastructural change is very important yet it can be complex. Possible sources include industrial handbooks and system specific books.

What are the tradeoffs of certain decisions?

Once the system type has been chosen, study the performance measures and determine any tradeoffs that might occur. In order to do this it is suggested that you make a simplified representation of the system, using simulation, analytical solutions or typical trends depending on the complexity of your system and the necessary level or detail. Determine how the decisions made about worker jobs, machine orientation, automation, and any other important system specific topics will affect system performance.

Determine expected benefits and measurements.

This should lead to the tradeoff determination, but it must be made clear that it is important to determine expected improvement levels, not just trends and tradeoffs. Specific utilization expectations, productivity output and cost should be determined so

that the system can be evaluated on its ability to improve the problems and make the company more profitable within a specified time frame.

Determine how the system fits into its supplier and customer

Check flow and consistency of upstream and downstream processes to your system, can you function in the current infrastructure? This includes operating on the current information system. It is suggested that you consider studying this effect of the system by shadowing the dispatcher if there is one, or spending some time at both the upstream and downstream steps.

Appendix C Simulation

C.1 Stochastic Model Parameters

The distributions of the parameters described in Table 2 of Section 5.5.1 were based on the experience of the author and were validated by historic data in Section 5.5.2.1. The chosen distribution functions were hypothesized using mathematical knowledge of the random occurrences they represent. It was seen, using a sensitivity test, that the chosen distribution function does not significantly affect the results of this model.

The charts below show the distributions and ranges chosen for all stochastic parameters. Table C-1 and Table C-2 show the distributions used in the first three models; the comparison to historic data, machine configuration, and part input models. Table C-3 and Table C-4 show the modifications to these parameters used in the fourth model which checks the sensitivity to stochastic parameters by modifying the setup and machine breakdowns by 50% both negatively and positively.

Parameter	Distribution Type	Distribution
Prove Out	Negative Exponential	
Setup	Square	
Part Change	Triangular	

Table C-1 Description of Model Parameter Distributions for Setup

Parameter	Distribution Type	MTBF (Mean Time Before Failure)	MTTR (Mean Time To Repair)
Maintenance	Normal/ Negative Exponential	 10 Time (hr)	 40 Time (min)
Tool Break	Normal/ Normal	 8 Time (hr)	 15 Time (min)
Probe Fault	Normal/ Negative Exponential	 100 Time (min)	 3 Time (min)

Table C-2 Description of Model Parameters for Breakdowns

Parameter	Increase	Decrease
Part Change	triangular(mins(37.5),mins(22.5), mins(52.5))	triangular(mins(12.5),mins(0), mins(27.5))
Setup	uniform(mins(8.75),mins(13.75))	uniform(mins(1.25),mins(6.25))
Prove Out	negexp(105)	negexp(35)

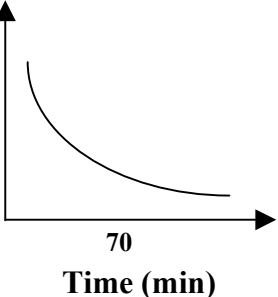
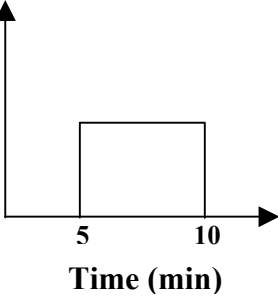
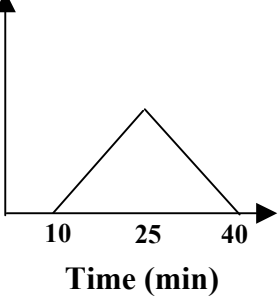
Table C-3 50% Change in Setup Parameters

Parameter	Increase	Decrease
Probe Fault	normal(mins(150),mins(5))	normal(mins(50),mins(5))
Maintenance	normal(hr(15),hr(4))	normal(hr(5),hr(4))
Tool Break	normal(hr(12),hr(2))	normal(hr(4),hr(2))

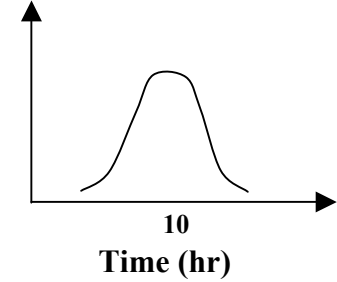
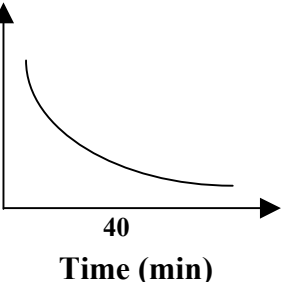
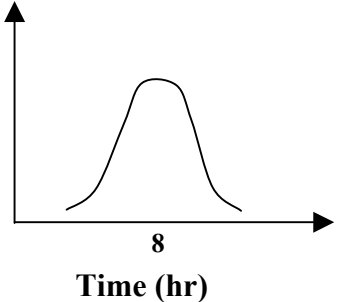
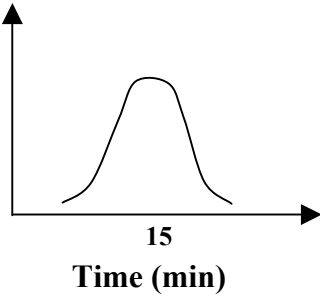
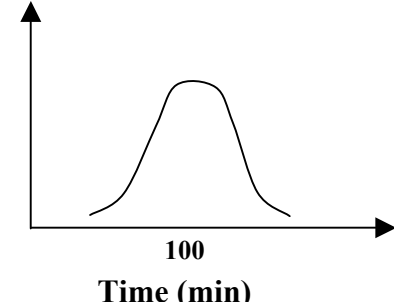
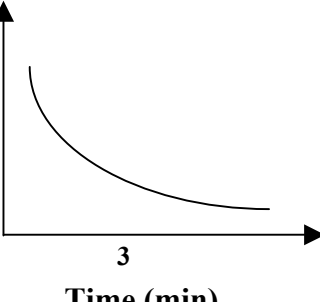
Table C-4 50% Change in Maintenance Parameters (MTBF)

C.2 Configuration and Input Changes

Table C- shows the recorded simulation data on machinist utilization (M) and worker utilization (W) acquired for the four machinist configurations tested in Section 5.5.2. It also includes a comparison of these utilizations to those acquired for the proposed data.

	Current Data	Proposed Data
1 	M ₁ =53% W _S =57 M ₂ =55 W _m =53 M ₃ =37	M ₁ =73% W _S =29 M ₂ =73 W _m =35 M ₃ =69
2 	M ₁ =61% W _S =47 M ₂ =66 W _m =50	M ₁ =80% W _S =22 M ₂ =77 W _m =27
3 	M ₁ =56% W _S =46 M ₂ =56 W _m =43	M ₁ =77% W _S =23 M ₂ =75 W _m =24
4 	M ₁ =47% W=76 M ₂ =48	M ₁ =73% W=44 M ₂ =72

Table C-5 Simulation Data Generated from Configuration and Input Changes

Appendix D Value Stream Mapping Survey

D.1 Survey

Welcome! The following survey is part of a research project to evaluate appropriate conditions for performing value stream mapping. The results of the survey will be used to develop a decision matrix to evaluate the possible success of value stream mapping on an area. The survey should be filled out by someone who participated in a value stream mapping event (creation of current state, future state, and implementation plan) and has knowledge of the product characteristics and event results.

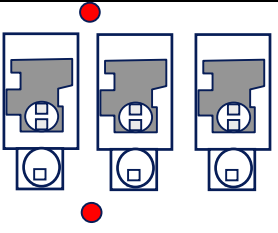
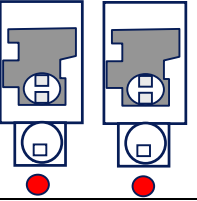
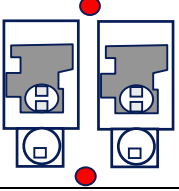
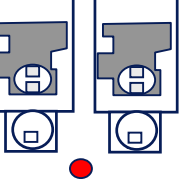
If you have attended multiple value stream mapping events please fill the survey out individually for each event.

Before you continue with the survey please read the [informed consent document](#) and agree to its conditions.

Yes I agree: No I do not agree:

In case of multiple choice, pick answer that best fits the situation

Background

Name (optional):

Company:

If you are interested in a copy of the survey results being sent to you at the completion of the research please leave your email address:

Value Stream Mapping was performed on (please fill out the survey for only ONE event at a time):

When was this VSM event performed?

January	▼	1996	▼
---------	---	------	---

What defines the beginning and end of the value stream (supplier and customer) as defined on your map?

Do you feel the value stream map is a good representation of the real system (information system, product flow, transportation, inventory levels, processing times, system yield, demand, etc)? Please give a few examples.



Why did you do this VSM event?



Ability to Generalize

Choose which of the following best describes the products that go through the area depicted in the map:

- All products go through the processes depicted in the value stream map.
- The majority of the products go through the processes depicted in the value stream map.
- Half the products go through the process depicted in the value stream map.
- A few of the products go through the processes depicted in the value stream map.
- Only the product mapped goes through the process shown on the value stream map.
- Only one product exists in the value stream mapped area, therefore it is the only process that the value stream map represents.

Other? Please Explain: 

Which of the following statements describes the area mapped in the value stream event, assuming no process improvements have been initiated:

- The processes drawn in the VSM might change next week, making the map obsolete.
- The processes drawn in the VSM might change in the next few months.
- The processes drawn in the VSM might change in less than a year.
- The processes drawn in the VSM will not change before improvements to the system can be made (1 year).
- The processes drawn in the VSM will never change.

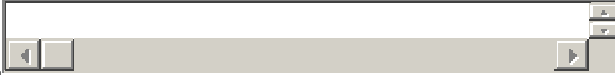
Other? Please Explain: 

Map Characteristics

The average number of tasks within a process box in the value stream is:

- 10 steps or less.
- Greater than 10.
- Greater than 100.
- Greater than 1000.
- Too many to count.

Other? Please explain:

Would you classify the process boxes as having:

- All serial processes where only one task is occurring on the product at one time.
- Mostly serial processes where only one task is occurring on the product at one time.
- A half and half mixture of serial and parallel process steps.
- Mostly parallel processes where multiple items of the product are being worked on at one time.
- All parallel processes where multiple items of the product are being worked on at one time.

Other? Please explain:

System Characteristics

Disruptions (scrap, rework, shortages, etc) throughout the value stream mapped area:

- Almost never happen.
- Are low enough not to impede flow.
- Occasionally forces out of sequence activity.
- Are a barrier to continuous flow.
- Are a fact of life.

Other? Please Explain:

For the product mapped in the value stream:

- The variation in cycle time of a process box is negligible.
- The variation in cycle time of a process box exists but does not impact flow.
- The variation in cycle time of a process box occasionally impacts flow.
- The variation in cycle time of a process box is a barrier to continuous flow.

The cycle time of a process box is nearly impossible to predict.

Other? Please Explain:

Organization

Please pick which of the following best explains the environment in which your VSM event was run:

The VSM event was perceived as a check the box exercise.

VSM was initiated by upper management with no lower management support, or VSM was initiated at lower management with no upper management support.

Level of commitment among management is variable.

The organization promotes changes and improvements.

Senior leaders reinforce transition and foster improvement throughout the VSM.

Other? Please Explain:

Resources

Please pick which of the following best explains the environment in which the VSM event was run:

Money and labor are in abundance.

Money and labor are available but limited.

Money and labor can be made available but an extensive justification process exists.

Money and labor are hard to come by even if justified.

Money and labor are impossible to get.

Other? Please Explain:

Value Stream Mapping Impact

Please pick which of the following best describes your experiences while implementing improvements towards the future state.

The VSM activity did not help surface any issues.

The VSM activity was a good way to record improvements that have already been suggested.

The VSM activity helped to recognize new improvement opportunities, but no implementation occurred.

Improvements were made using additional projects, but not enough projects were initiated so that the VSM customer could see an improvement.

An improvement was seen in the performance of the value stream mapped area customer.

Other? Please Explain:

What do you think was the biggest factor that affected your success/failure? Was it something that was not mentioned above? Please explain.



General Comments

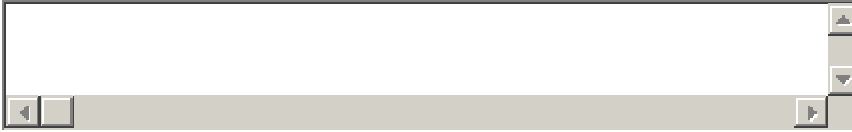

Thank you for taking the time to fill out the survey!

Please email rsalzman@mit.edu if there are any questions or problems.

D.2 Glossary

Value Stream Mapping Event

Allows the separation of actions into three categories: (1) value added, (2) non-value added but necessary, and (3) non-value added using a simplification mapping technique. VSM is defined as the process of making a (1) current state, (2) future state, and (3) implementation plan.

Product

Object produced in a value stream map for the defined customer.

Process Box Action noted in the value stream map by a square box. Actions are usually separated by movement of material.

D.3 Informed Consent

We would like to emphasize that participation in this research is completely voluntary. You are free to refuse to answer any question you are either uncomfortable with or uncertain about. You are also free to withdraw your participation at any time. We understand that you may have concerns about confidentiality. Several measures will be taken to ensure that your responses will remain confidential.

All analysis of the data will be represented in the form of aggregated statistics. Excerpts from the individual results may be made part of the research results, but under no circumstances will your name or any identifying characteristics be included. Furthermore, no individual program will be identified in the analysis or reporting of the responses. We understand that the success of any research depends upon the quality of the information on which it is based, and we take seriously our responsibility to ensure that any information you entrust to us will be protected.

For any additional information contact:

Researcher: Rhonda Salzman rsalzman@mit.edu
Advisor: Tom Shields shields@mit.edu

Lean Aerospace Initiative
MIT Room 41-205

77 Massachusetts Ave.
Cambridge, MA 02139
Phone: (617) 253-0308
Fax: 617-258-7845

Thank you for your participation in this research!