

CONF-86114--3

Received by STI

OCT 06 1986

Los Alamos National Laboratory is operated by the University of California for the United States Department of Energy under contract W-7405-ENG-36

LA-UR--86-3111

DE87 000138

TITLE MATERIALS TECHNOLOGY APPLIED TO NUCLEAR ACCELERATOR TARGETS

AUTHOR(S) Barry L. Barthell, MST-7

SUBMITTED TO Ninth Conference on the Application of Accelerators in Research and Industry, Texas Western University, Denton, Texas November 10-12, 1986 To be published in the American Physical Society

DISCLAIMER

This report was prepared as an account of work sponsored by an agency of the United States Government. Neither the United States Government nor any agency thereof, nor any of their employees, makes any warranty, express or implied, or assumes any legal liability or responsibility for the accuracy, completeness, or usefulness of any information, apparatus, product, or process disclosed, or represents that its use would not infringe privately owned rights. Reference herein to any specific commercial product, process, or service by trade name, trademark, manufacturer, or otherwise does not necessarily constitute or imply its endorsement, recommendation, or favoring by the United States Government or any agency thereof. The views and opinions of authors expressed herein do not necessarily state or reflect those of the United States Government or any agency thereof.

By acceptance of this article, the publisher recognizes that the U.S. Government retains a non-exclusive, royalty-free license to publish or reproduce the published form of this contribution, or to allow others to do so, for U.S. Government purposes.

The Los Alamos National Laboratory requests that the publisher identify this article as work performed under the auspices of the U.S. Department of Energy.

MASTER

Los Alamos Los Alamos National Laboratory Los Alamos, New Mexico 87545

F. M. B.

DISTRIBUTION OF THIS DOCUMENT IS UNLIMITED

MATERIALS TECHNOLOGY APPLIED TO NUCLEAR ACCELERATOR TARGETS

BARRY L. BARTHELL

MATERIALS SCIENCE AND TECHNOLOGY DIVISION

LOS ALAMOS NATIONAL LABORATORY

LOS ALAMOS, NM 87545

THE CONTINUING REQUESTS FOR BOTH SHAPED AND FLAT, VERY LOW AREAL DENSITY METAL FOILS HAVE LED TO THE DEVELOPMENT OF METALLURGICAL QUALITY, HIGH STRENGTH PRODUCTS. THE INTENT OF THIS PAPER IS TO SHOW METHODS OF FORMING STRUCTURES ON VARIOUS SUBSTRATES USING PERIODIC VAPOR INTERRUPTIONS, ALTERNATING ANODES, AND MECHANICAL PEENING TO ALTER OTHERWISE UNACCEPTABLE GRAIN MORPHOLOGY WHICH BOTH LOWERS TENSILE STRENGTH AND CAUSES HIGH STRESSES IN THIN FILMS.

FIGURE 1 IS A CROSS-SECTION OF SUCH A FOIL, IT SHOWS AN Al/Al_xO_y LAMALLER STRUCTURE OF ~ 50 nm THICK AL LAYERS WITH AN INTERFACE OF Al_xC_y THAT IS ROUGHLY 5-10 ATOMIC PERCENT OXYGEN. THE YIELD STRENGTH OF THIS FOIL IS APPROXIMATELY 408 MPa, AS COMPARED WITH 22 MPa FOR A FILM DEPOSITED WITH NO OXYGEN. THE STRENGTHENING EFFECT ALSO IS PARTLY DUE TO THE CONTINUOUS SHIFTING OF NUCLEATION SITES AT THE GROWTH PLANE. THE PROPERTIES OF THIS FOIL WERE WELL PREDICTED AND FOLLOW THE HALL-PETCH RELATION FOR YIELD STRENGTHS VERSUS LAYER SPACINGS AS SHOWN BY R.W. SPRINGER, D.S. CATLETT, THIN SOLID FILMS, 54 (1978) 197-205. THERE IS LITTLE DOUBT THAT MANY OTHER MATERIALS COULD BE FORMED

IN THIS MANNER, HOWEVER, ALUMINUM HAS BEEN, BY FAR, THE MOST REQUESTED MATERIAL, AND LITTLE DEVELOPMENT HAS BEEN DONE WITH ANYTHING ELSE. THE HIGH YIELD STRENGTH OF THESE FOILS ALLOW VERY THIN SHAPED STRUCTURES TO BE PRODUCED, SUCH AS THE ONE SHOWN IN FIGURE 2. THE FOIL IS 2 CM HIGH, WITH A 2 CM RADIUS. THE THICKNESS IS $0.2 \mu\text{m}$ ($54 \mu\text{GM}/\text{CM}^2$). THESE FOILS ARE USED BY THE AIR FORCE WEAPONS LABORATORY IN THE SHIVA STAR ACCELERATOR IN LARGE RADII, THE SANDIA NATIONAL LABORATORY IN THE PROTO II ACCELERATOR SMALLER RADII AND BY LOS ALAMOS IN AN EXPLOSIVELY DRIVEN TRAILMASTER, PULSED POWER DEVICE. THE PROCESS FOR MAKING THEM IS DESCRIBED BY D. DUCHANE AND B. BARTHELL, THIN SOLID FILMS, 107 (1983) 373-378, AND IN US PAT. NO. 4,481,999 AND CA PAT. NO. 1,196,469. GOLD FOILS, FIGURE 3, CAN BE PRODUCED WITH THINNER CROSS-SECTIONS ($0.1 \mu\text{m}$) WITHOUT LAMINATION. THESE FOILS ARE ALL FORMED ON A POLYVINYL ALCOHOL SUBSTRATE (FIGURE 4) WHICH IS WATER SOLUBLE, AND IS SUBSEQUENTLY REMOVED, LEAVING AN UNBACKED FOIL.

EXTREMELY SMOOTH, DEFECT FREE SUBSTRATES ARE VITAL TO THE MANUFACTURE OF THESE FOILS. A PROCESS FOR SMOOTHING POLY METHYL METHACRYLATE (LUCITE) (FIGURE 5) IS DESCRIBED BY D. DUCHANE, J. VAC. SCI. TECHNOL. 18 (3) APRIL 1981, AND IN U.S. PAT. NO. 4,376,751 POLYMER SUBSTRATES SMOOTHED BY THIS TECHNIQUE WERE USED TO FORM SMALL TUBES (SODA STRAWS) OF ALUMINUM THAT INCORPORATE A 200\AA LAYER OF COPPER INSIDE (FIGURE 6). THE NEED TO MAKE THESE FOILS BIMETALLIC PRECLUDED THE STANDARD METHOD OF FORMING THE SUBSTRATE FOR THE PRODUCTION OF SMALL-DIAMETER, TUBULAR ALUMINUM FOILS. NORMALLY A COPPER FOIL IS DEPOSITED ON GLASS TUBING AND

THE GLASS IS DISSOLVED IN HYDROFLUORIC ACID LEAVING A SUPER SMOOTH COPPER SUBSTRATE. THE COPPER IS COATED WITH ALUMINUM AND THEN SUBSEQUENTLY SELECTIVELY LEACHED AWAY ITSELF.

FLAT ALUMINUM SHAPES ARE FORMED ON MANDRELS PRODUCED USING SINGLE POINT DIAMOND KNIFE MACHINING SUCH AS THESE BEAM STRIPPERS (PAC MANS) AND ALIGNMENT RIBBONS (HARPS) (FIGURE 7) AND SIEVES (FIGURE 8) USED IN LOS ALAMOS MESON ACCELERATOR. THE SURFACES OF ALL THESE FLAT MANDRELS ARE COATED WITH $\sim 250\text{\AA}$ OF CESIUM IODIDE WHICH IS WATER SOLUBLE AND ALLOWS THE SHAPED FOILS TO BE FLOATED OFF IN WATER. ANOTHER METHOD MAKES USE OF PHOTOLITHIOGRAPHY TO FORM THE MANDREL (FIGURE 9) BY ETCHING COMPLEX FLAT FORMS SUCH AS THIS 97.5% TRANSPARENT SUPPORT GRID, $5\ \mu\text{M}$ THICK, USED AS THE SUPPORT FOR ULTRATHIN STRIPPER FOILS OF CARBON OR ALUMINUM. FIGURE 10 SHOWS A BEAM COLLIMATING SLIT ARRAY FOIL. THESE DEVELOPMENTAL STRUCTURES SUCH AS A 600\AA FOIL ON A 1 CM SQUARE, $\sim 97\%$ TRANSPARENT MESH (FIGURE 11) AND A 600\AA ALUMINUM FOIL ON AN 87% TRANSPARENT MESH (FIGURE 12) WILL BE USED AS NEUTRALIZER FOILS FOR NEUTRAL PARTICLE BEAM ACCELERATORS AT LOS ALAMOS AND AT THE WHITE SANDS MISSILE RANGE. THESE THIN FILMS ARE BEING DEVELOPED BY G. REEVES AND WILL ULTIMATELY BE 250\AA TO 400\AA THICK AND 1 METER IN DIAMETER.

IN OUR EFFORTS TO FABRICATE LASER ACCELERATOR TARGETS, A METAL COATED FOAM STRUCTURE WAS DEVELOPED BY DEPOSITING A LAYER OF POLYVINYL ALCOHOL OR HYDROXYPROPYL CELLULOSE ON A LOW DENSITY, OPEN CELL, POLYMETHYL PENTENE FOAM TO FORM AN EXTREMELY SMOOTH, CONTINUOUS FILM. THIS WAS COATED WITH $5\ \mu\text{M}$ OF ALUMINUM TO PRODUCE THE SURFACE SHOWN IN FIGURE 14. THIS PROCESS IS

DESCRIBED BY B. BARTHELL AND D. DUCHANE, J. VAC. SCI. TECHNOL 20 (4) APRIL 1982 AND IN US PAT. NO. 4,555,313.

THIN ($60 \mu\text{GM}/\text{CM}^2$) LARGE (1 METER BY 30 CM) POLYMER FILMS WERE PRODUCED BY DIPPING A POLISHED STAINLESS STEEL, CYLINDRICAL FORMING RING INTO A SOLUTION OF POLYVINYL ALCOHOL, DRYING, AND THEN DIPPING THE RING INTO A DILUTE SOLUTION OF POLYVINYL FORMAL (FORMVAR) AND STRIPPING THE COMPOSITE FILM FROM THE RING WHEN DRY. THE BILAYER SHEET WAS THEN MOUNTED ON A FRAME TO FORM A LARGE PELLICLE. AFTER THE FILM WAS IN PLACE THE WATER SOLUBLE P.V.A. WAS WASHED AWAY, LEAVING THE ULTRATHIN FORMVAR WINDOW. THE PROCESS IS DESCRIBED IN US PAT. NO. 4,448,662.

A HIGH PRESSURE TRITIUM TARGET (FIGURE 15) WAS MANUFACTURED ELECTROCHEMICALLY BY FIRST COATING AN ALUMINUM MANDREL WITH COPPER AND TIN LEAD SOLDER, ALONG WITH THE TARGET END CAPS AND JOINING THEM TOGETHER THERMALLY (FIGURE 16) AND COATING THE ASSEMBLY WITH NICKEL COBALT 125NM THICK (FIGURE 17). THE ALUMINUM MANDREL WAS REMOVED AS DESCRIBED BY P. BALO, AND R. BRAMLETT IN LOS ALAMOS UNCLASSIFIED REPORT, LA-CP-86-26. THE YIELD STRENGTHS WERE NOMINALLY 1161 MPA U.T.S. WERE 1901 MPA.

FIGURE 16 SHOWS THE LAMALLER STRUCTURE FORMED BY THE NICKEL COBALT BATH WHICH USES TWO SEPARATE ANODES. THE PLATED PART IS ROTATED PAST EACH ONE FORMING THE LAYERED STRUCTURE.

CHEMICAL VAPOR DEPOSITION (PVD) IN A FLUID BED (FIGURE 17) IS USED TO FORM TUNGSTEN CYLINDERS ON MOLYBDENUM MANDRELS WHICH ARE SELECTIVELY DISSOLVED AWAY. BECAUSE OF THE PEENING ACTION OF THE BED THE GRAIN SIZE IS MARKEDLY REDUCED (FIGURE 18) AS SHOWN IN COMPARISON WITH C.V.D. DONE WITHOUT A FLUIDIZED BED. FIGURE

19 SHOWS A CROSS-SECTION OF THIS FINE STRUCTURE. FIGURE 20 IS A SCANNING ELECTRON MICROGRAPH AGAIN SHOWING THE STRUCTURE COMPARISON. THE PRODUCT IN THIS CASE (FIGURE 21) IS A FREE CYLINDRICAL FOIL WHICH HAS BEEN MADE WITH A WALL THICKNESS OF 0.6 μM AND $>0.1 \mu\text{M}$ VARIATION AS SHOWN BY D. CARROLL, AND W. MCCREARY, J. VAC. SCI. TECHNOL. 20 (4) APRIL 1982.

IN SUMMARY THE THREE TECHNOLOGIES, PHYSICAL VAPOR DEPOSITION, ELECTROCHEMISTRY, AND CHEMICAL VAPOR DEPOSITION AND THEIR THIN FILM PRODUCTS CAN BENEFIT FROM THE USE OF LAMINATE TECHNOLOGY AND CONTROL OF GRAIN STRUCTURE MORPHOLOGY THROUGH THE USE OF MATERIALS RESEARCH AND TECHNOLOGY.



80 nm
Figure 1



Figure 2

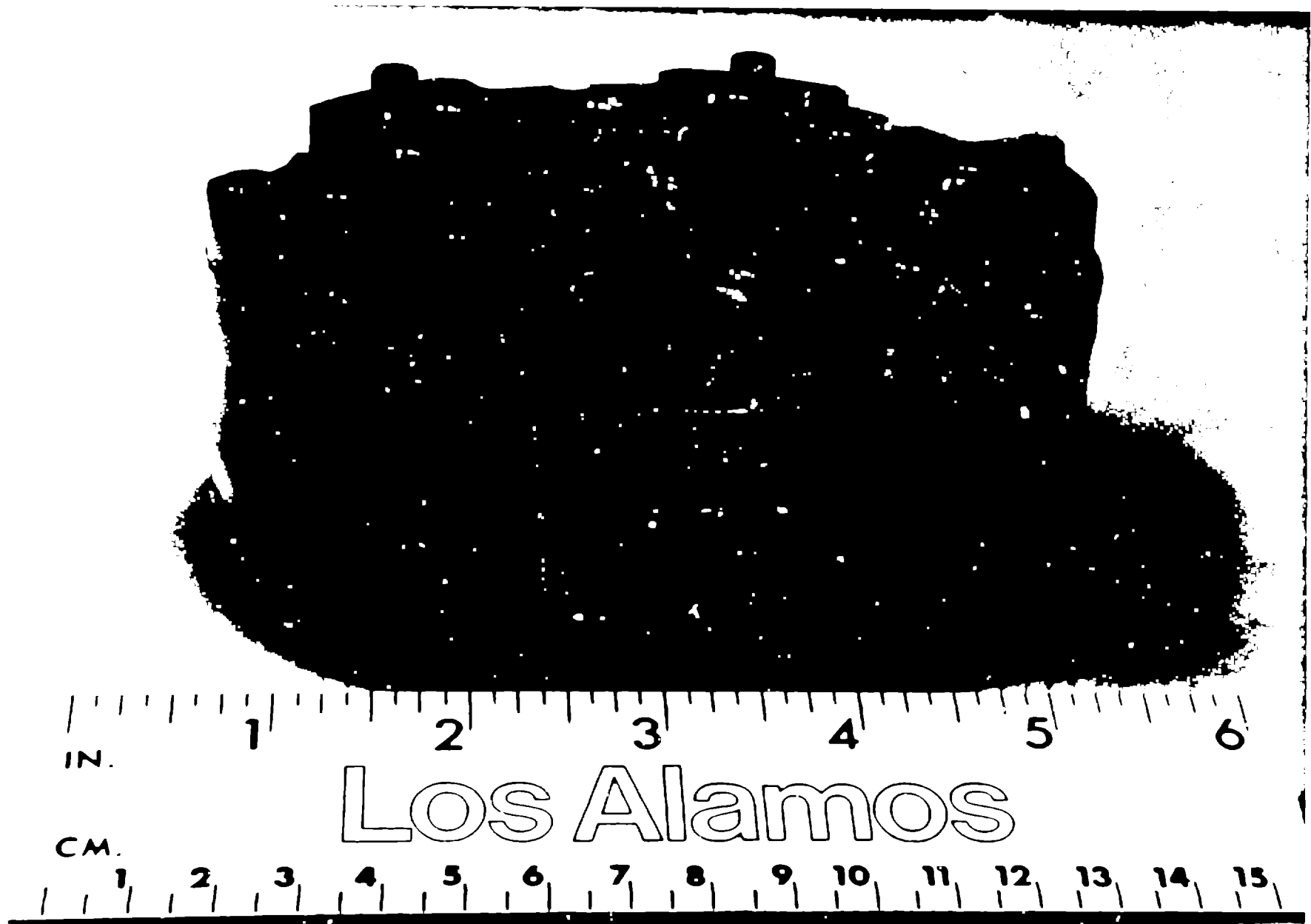

Figure 3

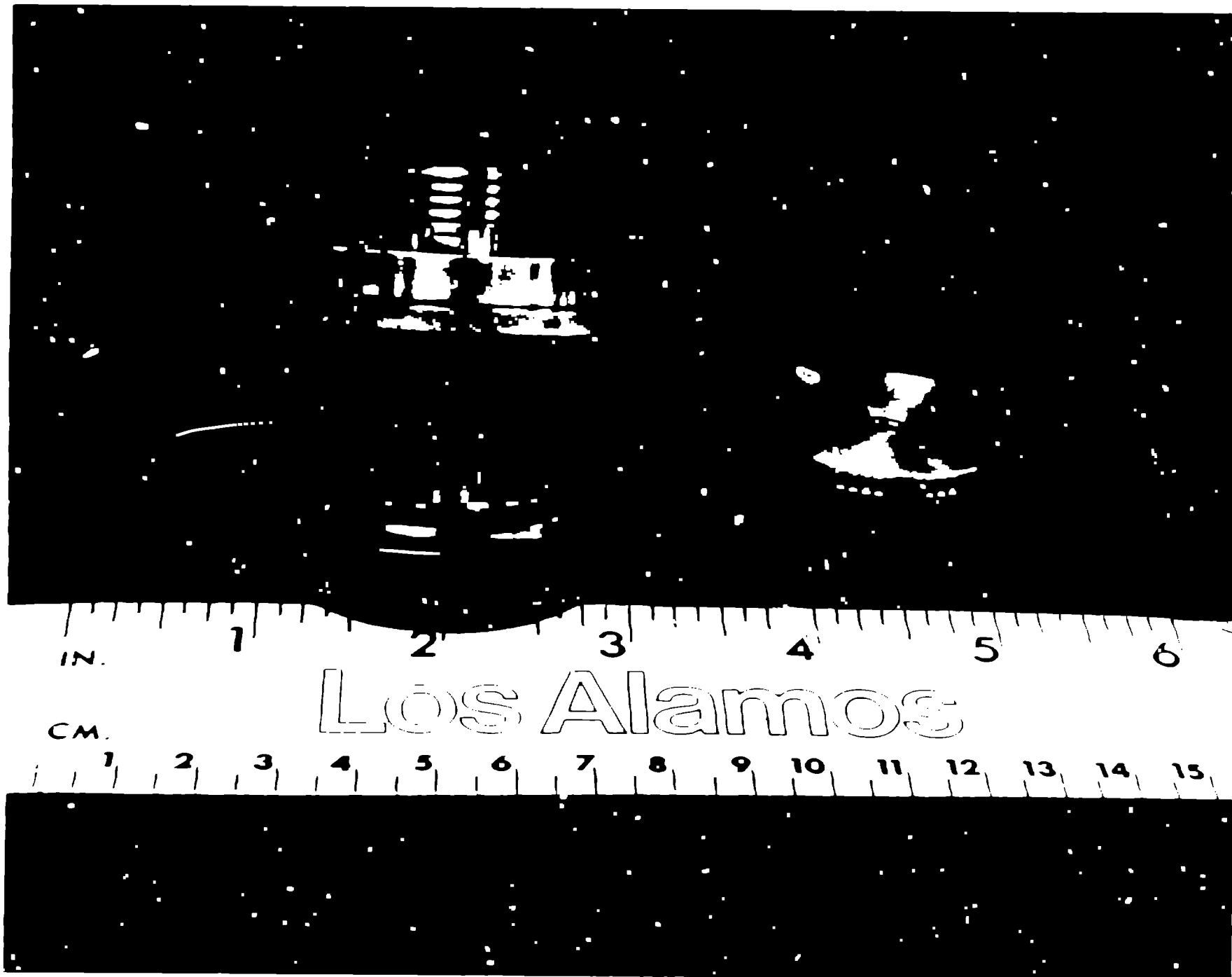

Figure 4

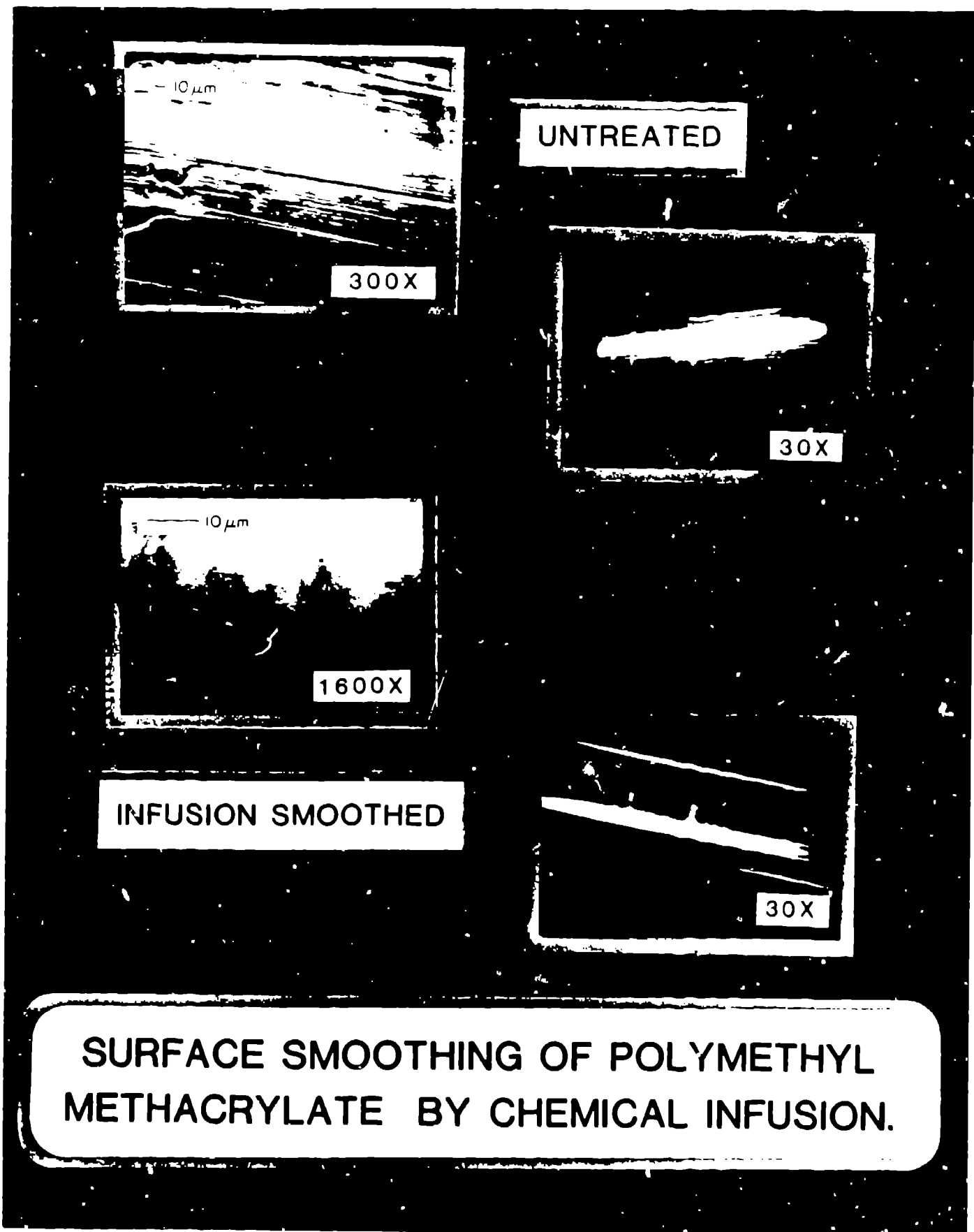

Figure 5

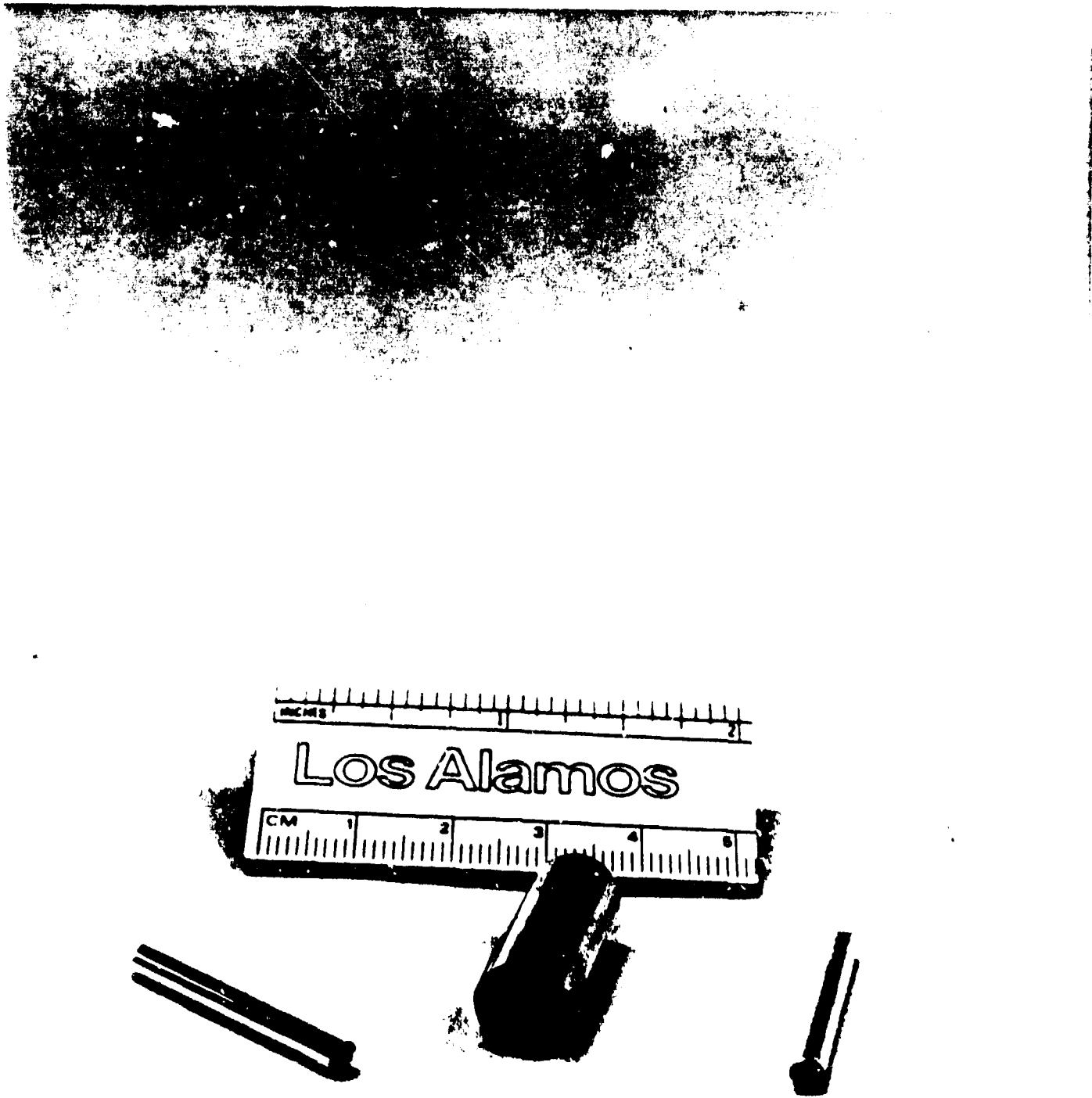

Figure 6

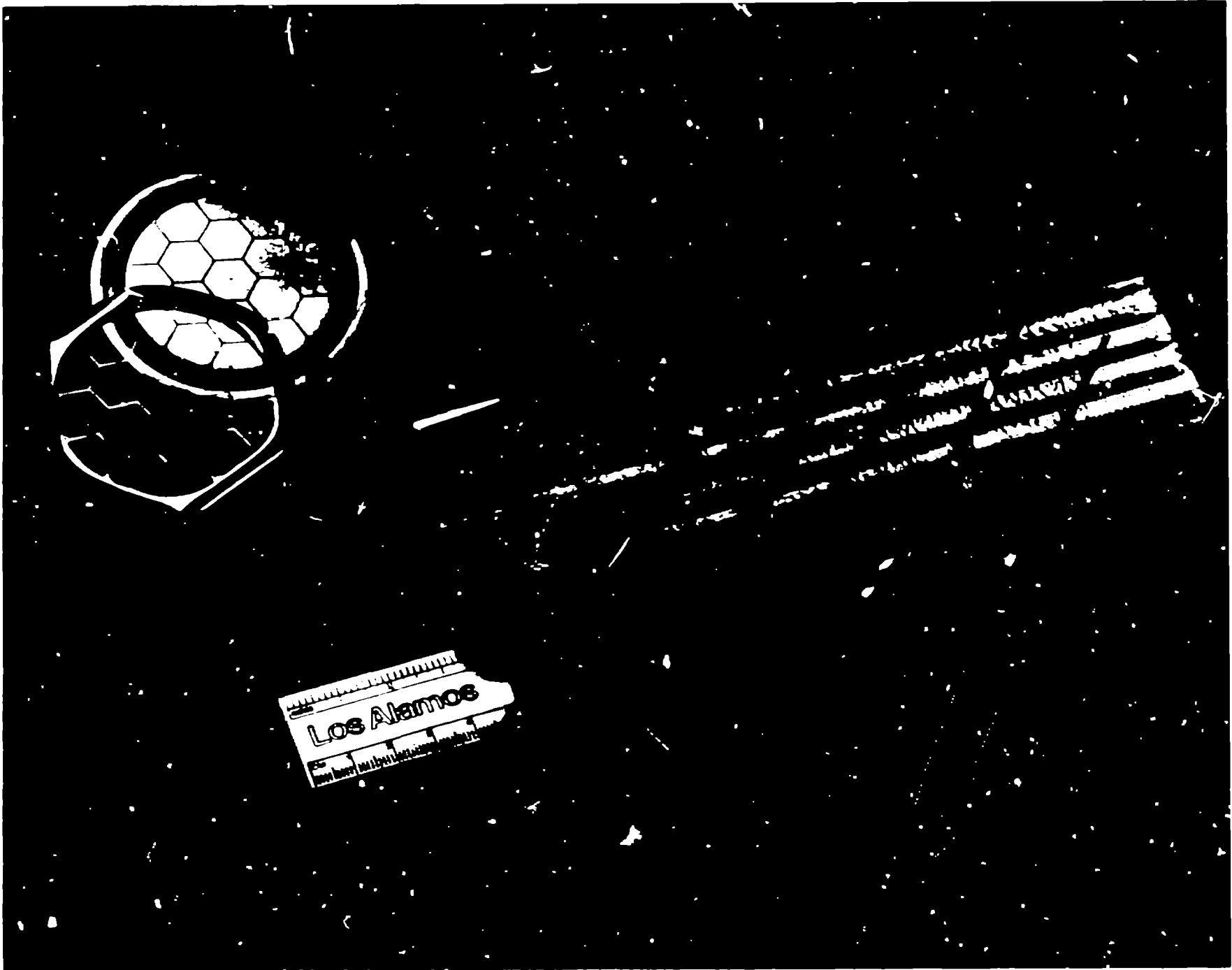

Figure 7

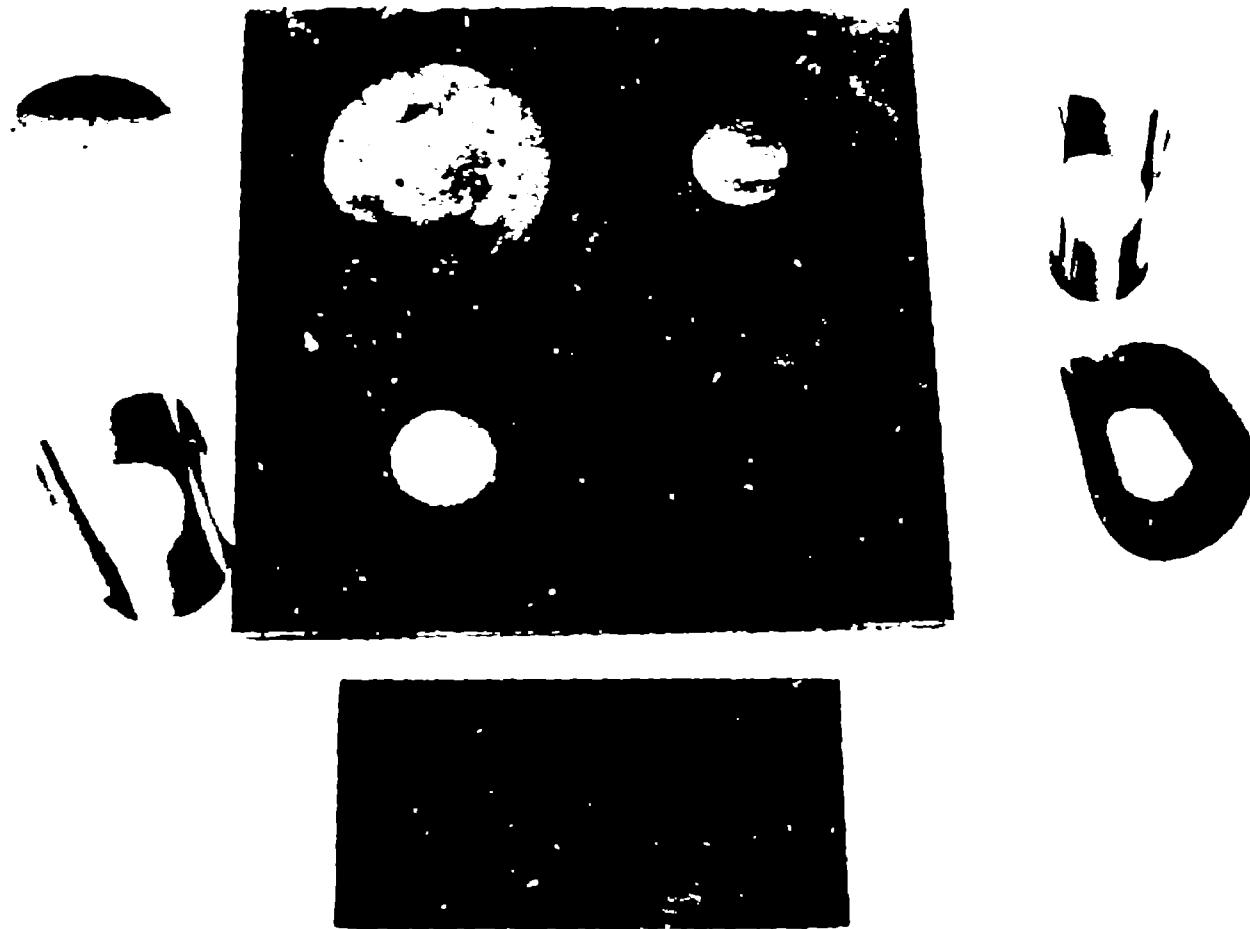

Figure 8

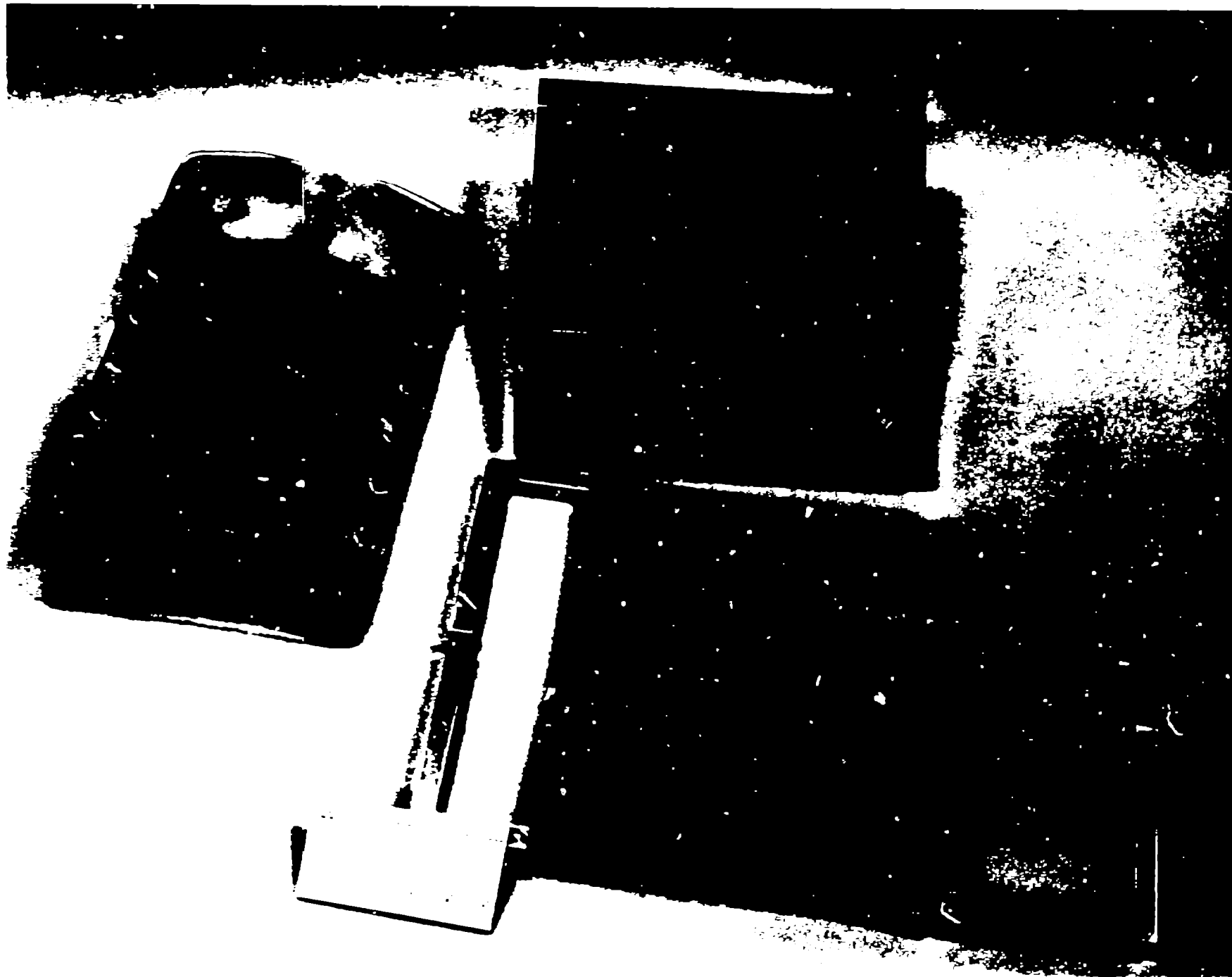

Figure 9

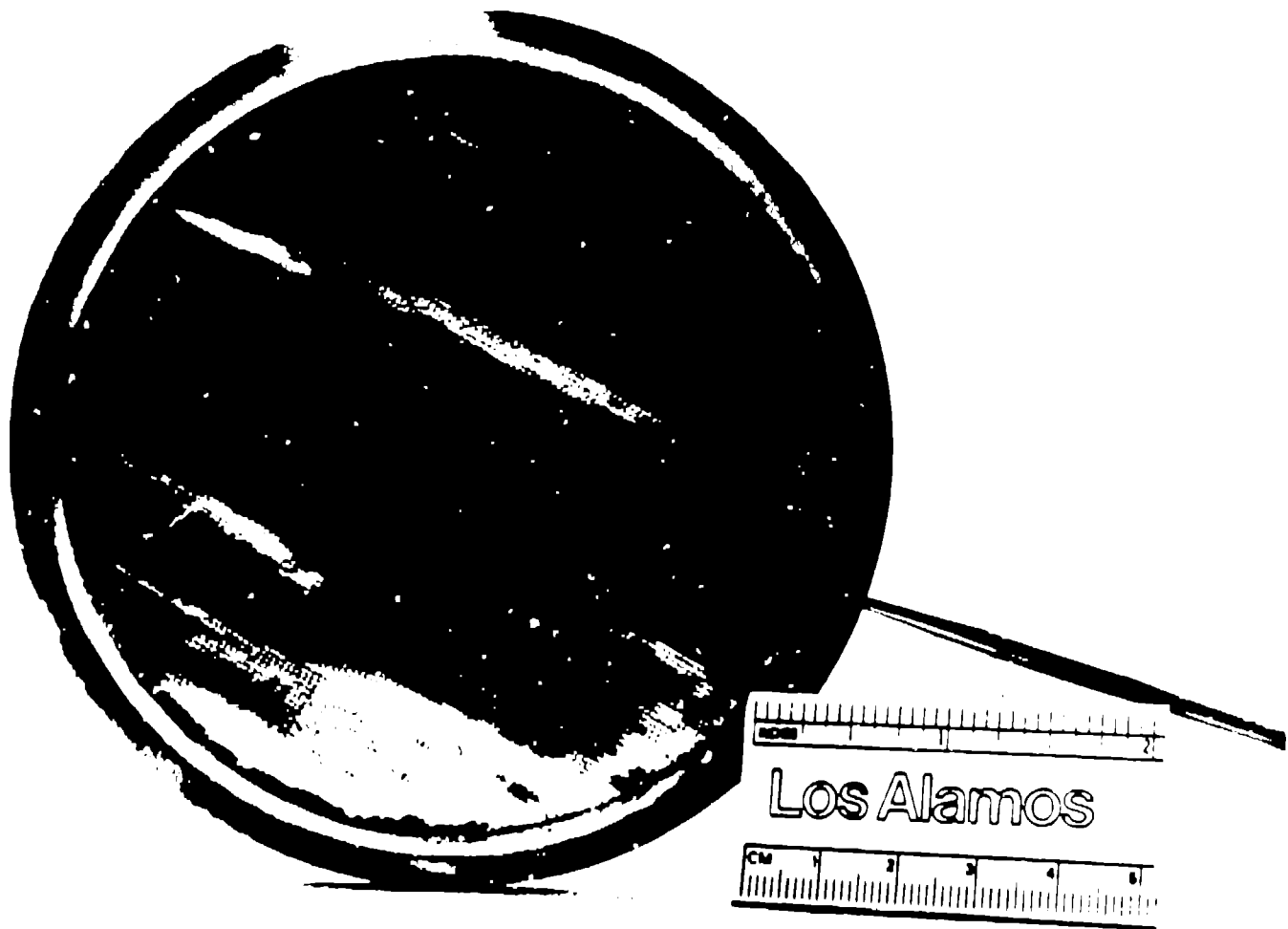

Figure 10

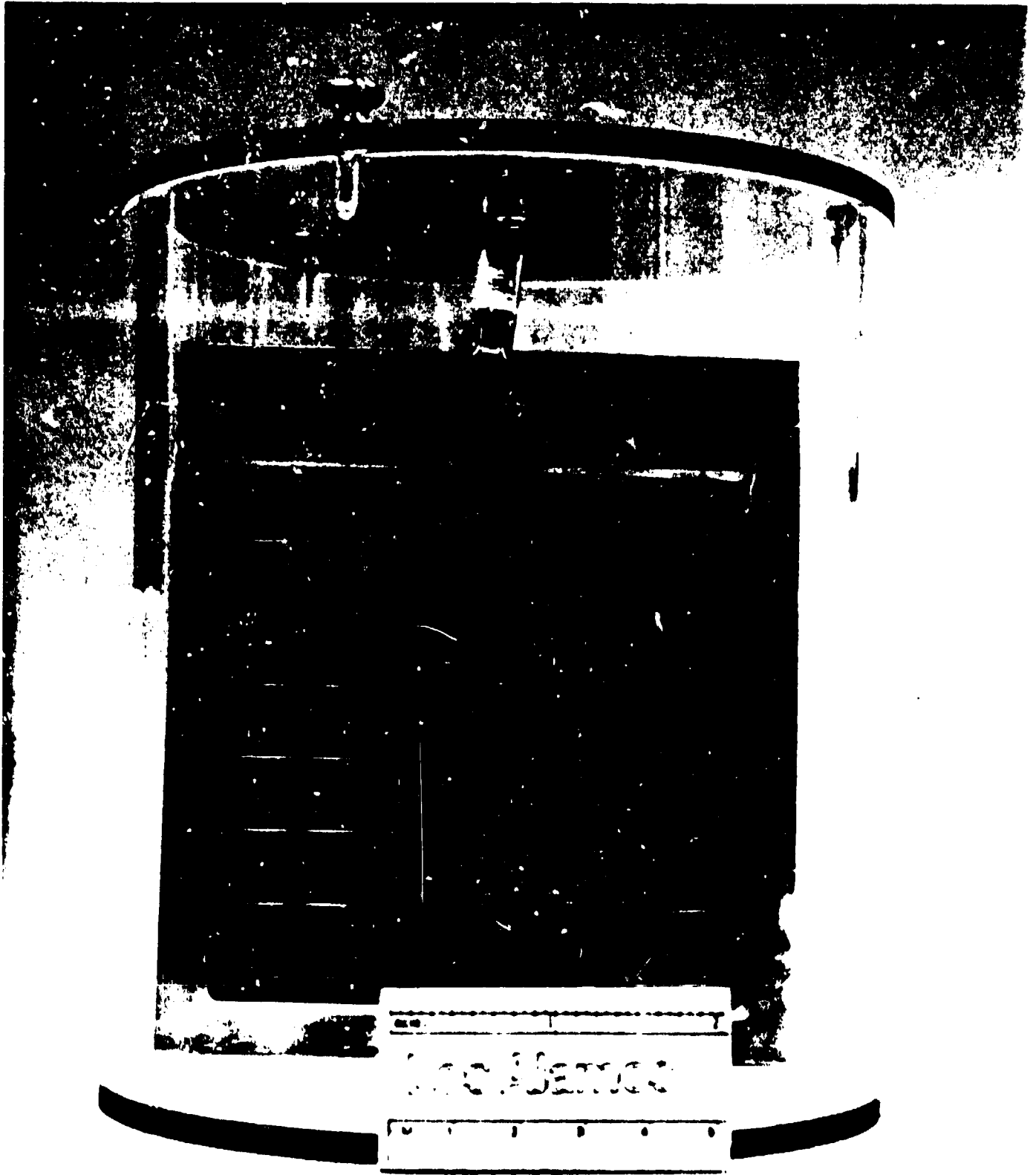
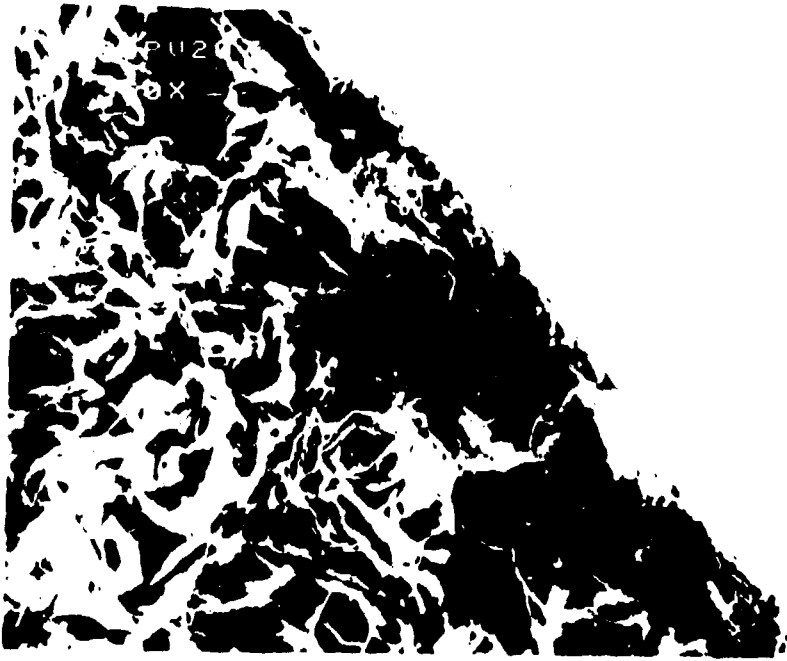
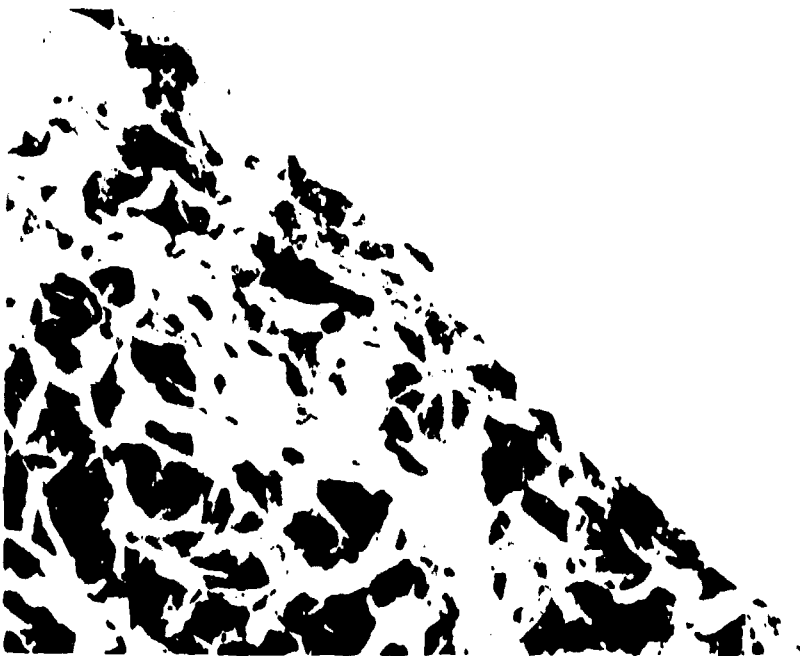

Figure 11



PVA
On
TPX

50 μm



Klucel
On
TPX

50 μm

Figure 12



PTX/PVA/Al

1 μm

Figure 13



Figure 14



Figure 15

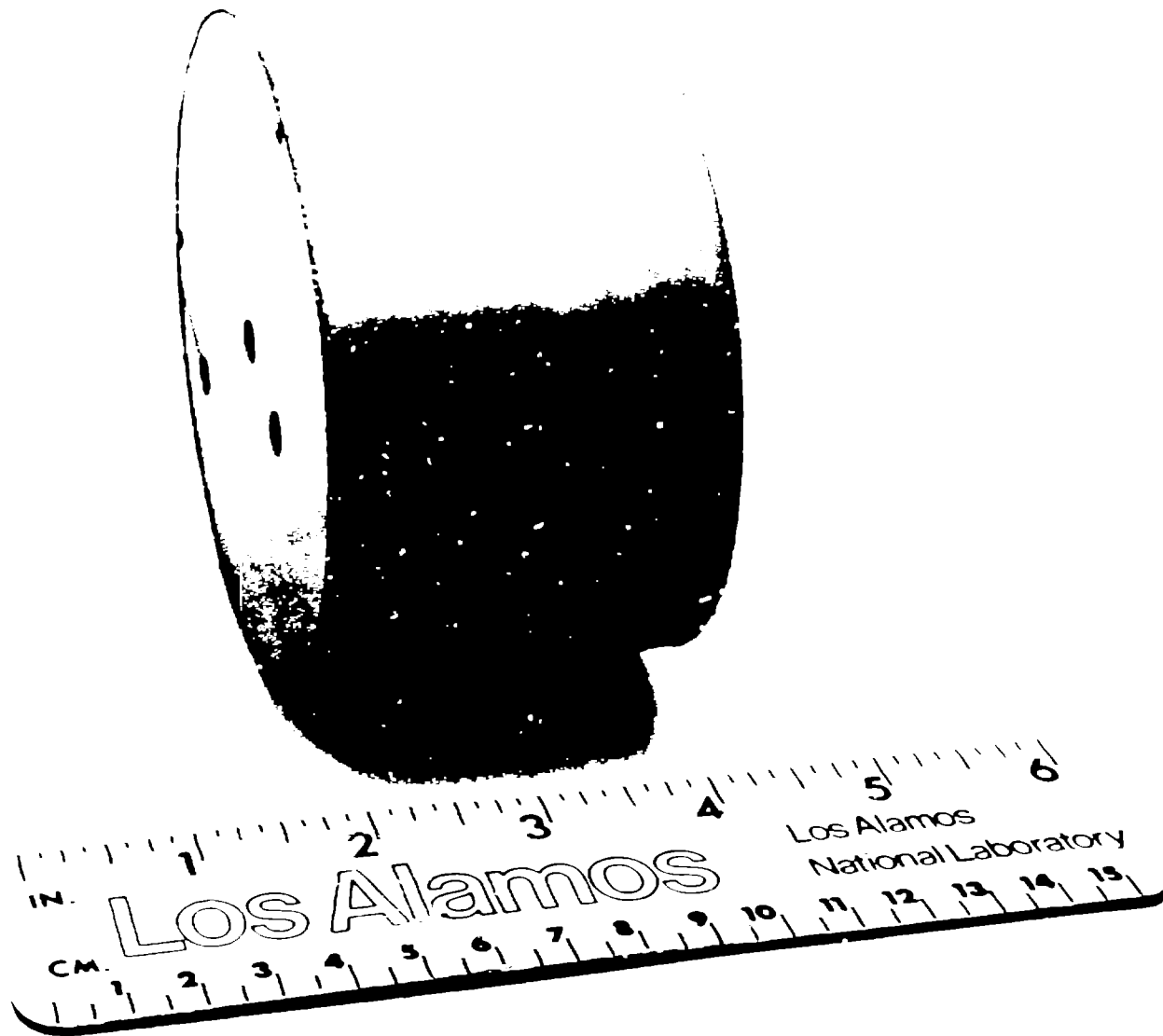
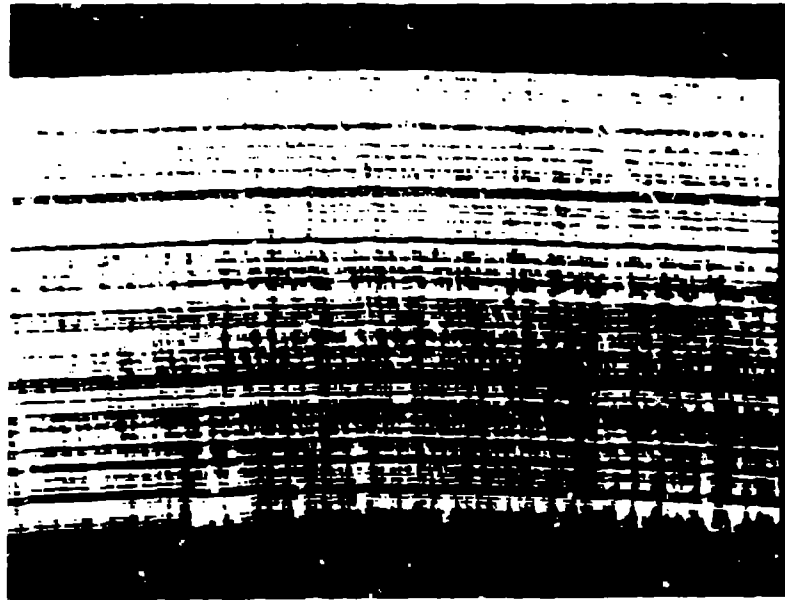

Figure 16



001

5-176-10

Figure 17

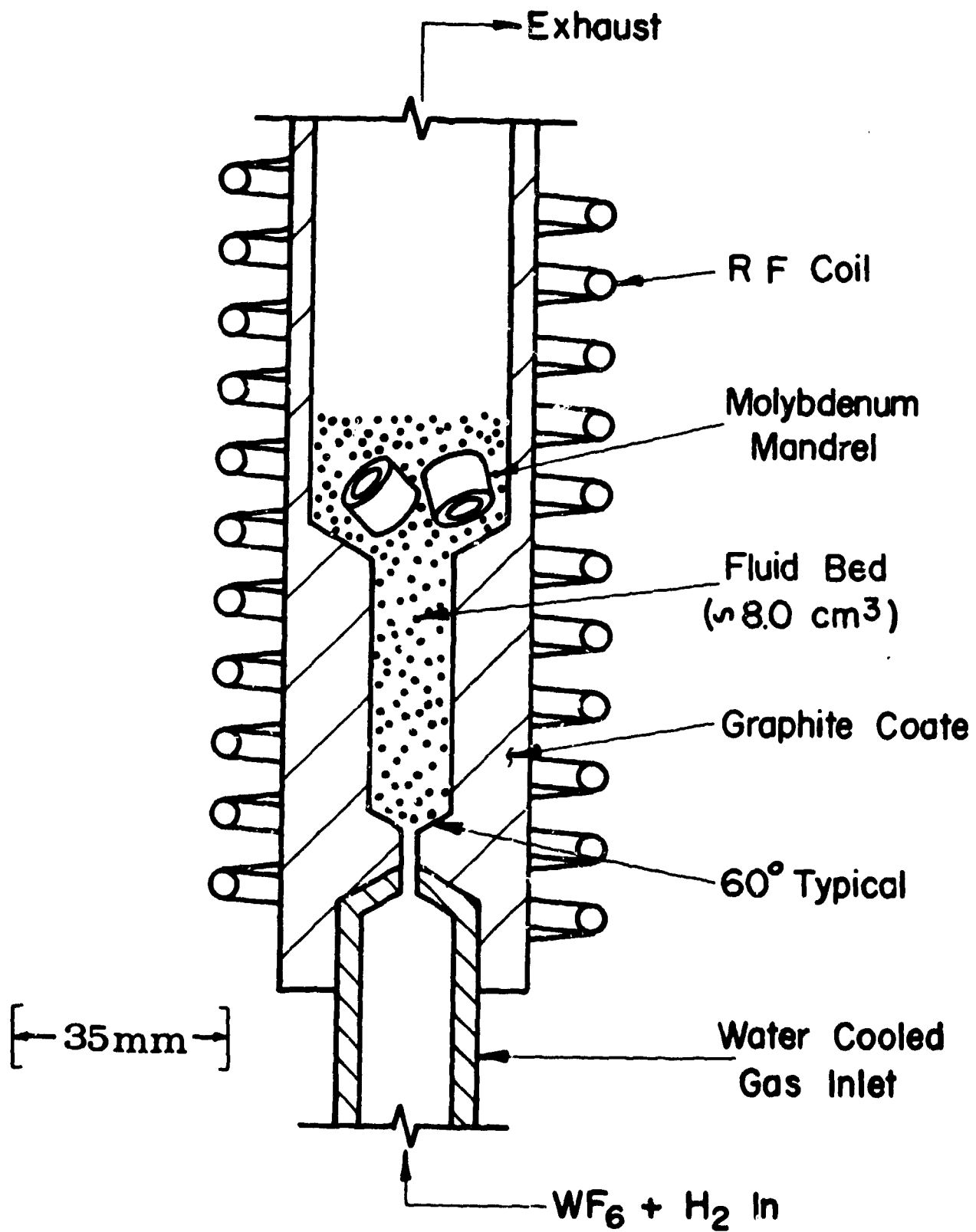
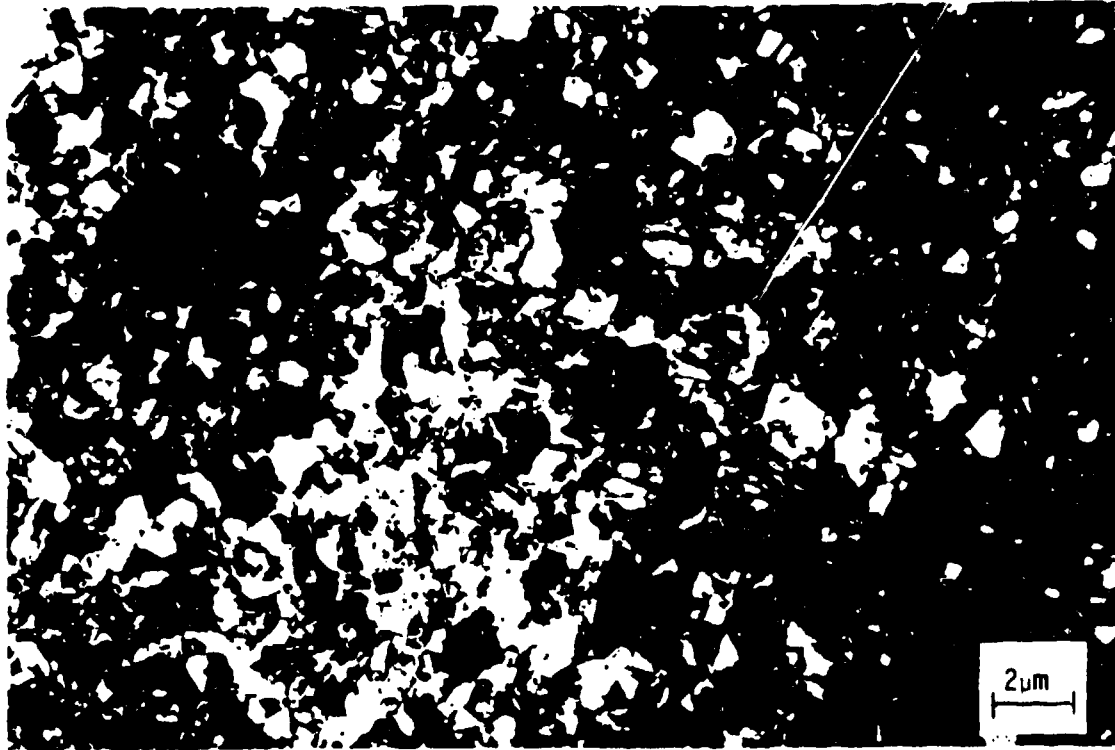
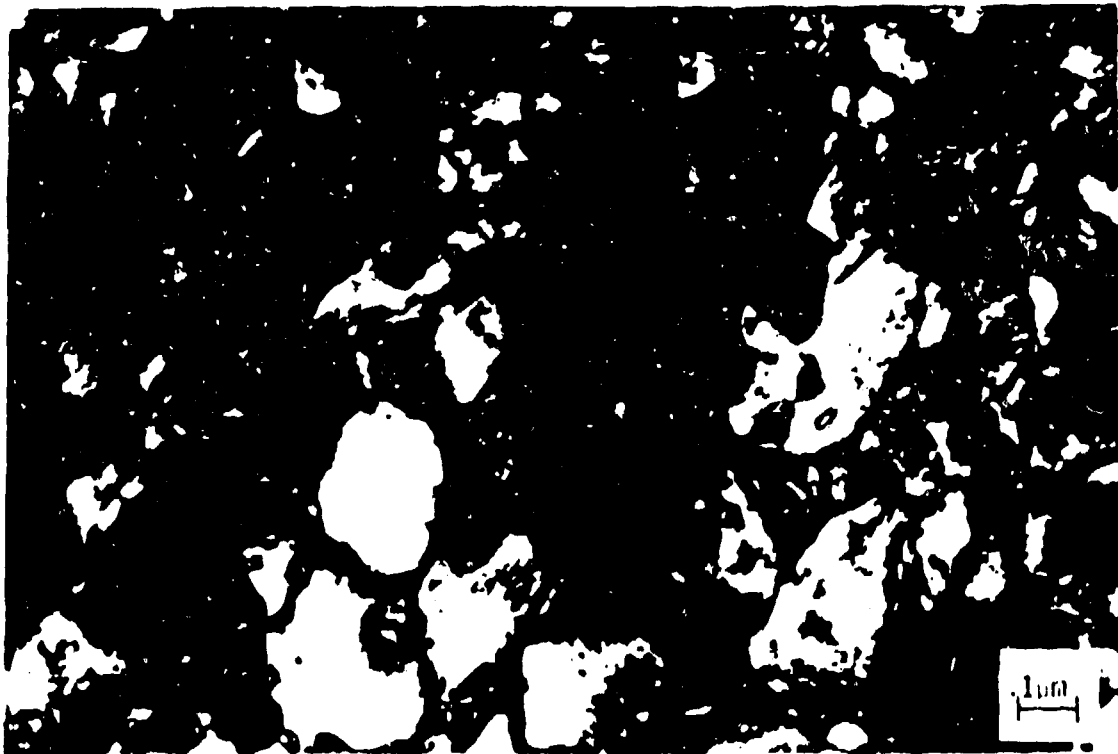

Figure 18



A. TEM OF A 2- μm TUNGSTEN FILM

5.4KX



B. TEM OF A 2- μm TUNGSTEN FILM

84KX

Figure 19



A. 250x



B. 250x

—] [50 μm

Figure 20

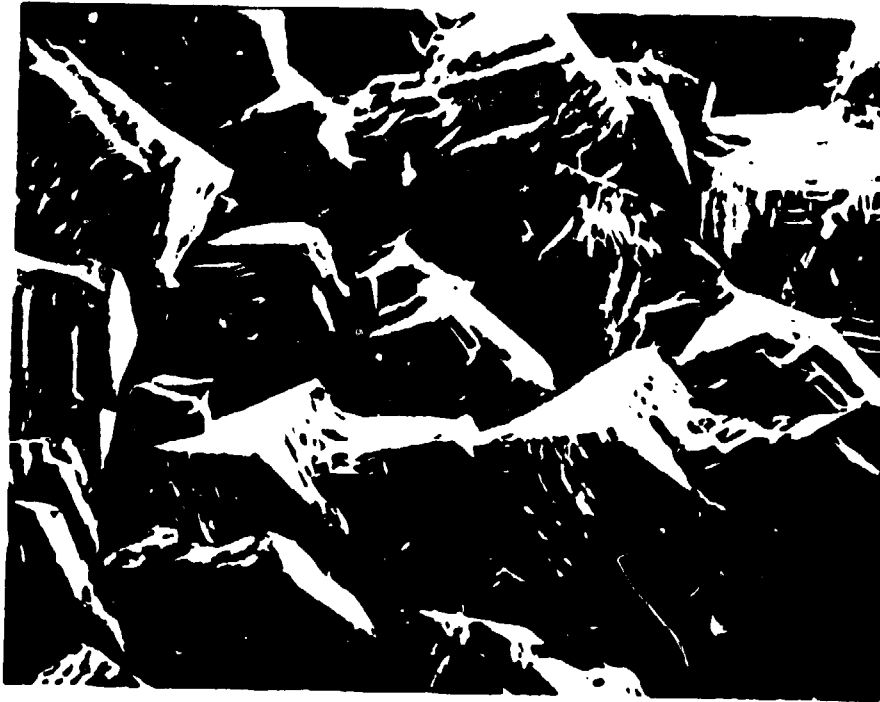

A. 1000x

[←25μm→]

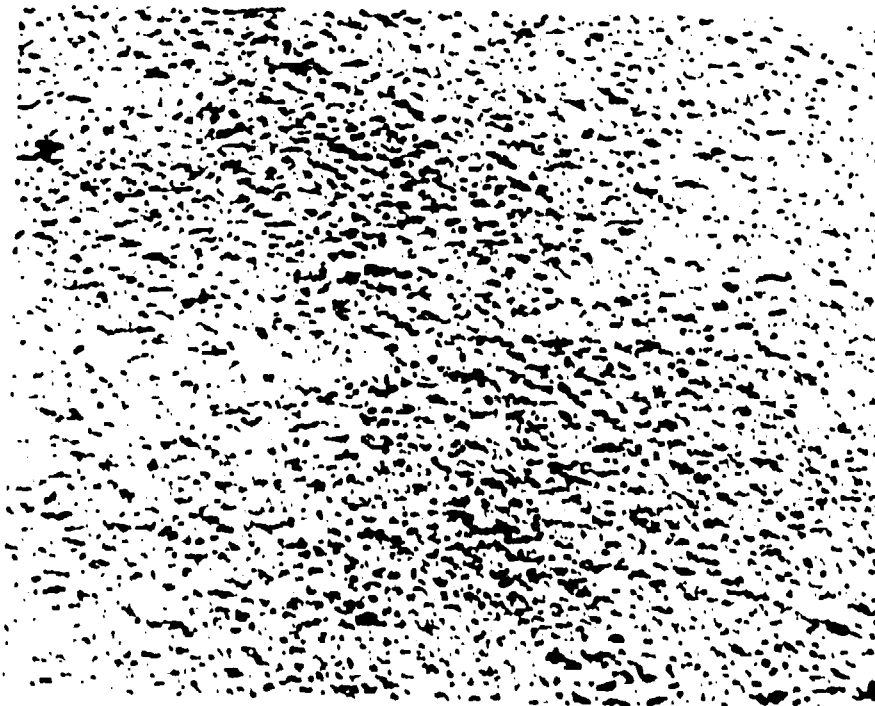

B. 3000x

[←8μm→]

Figure 21

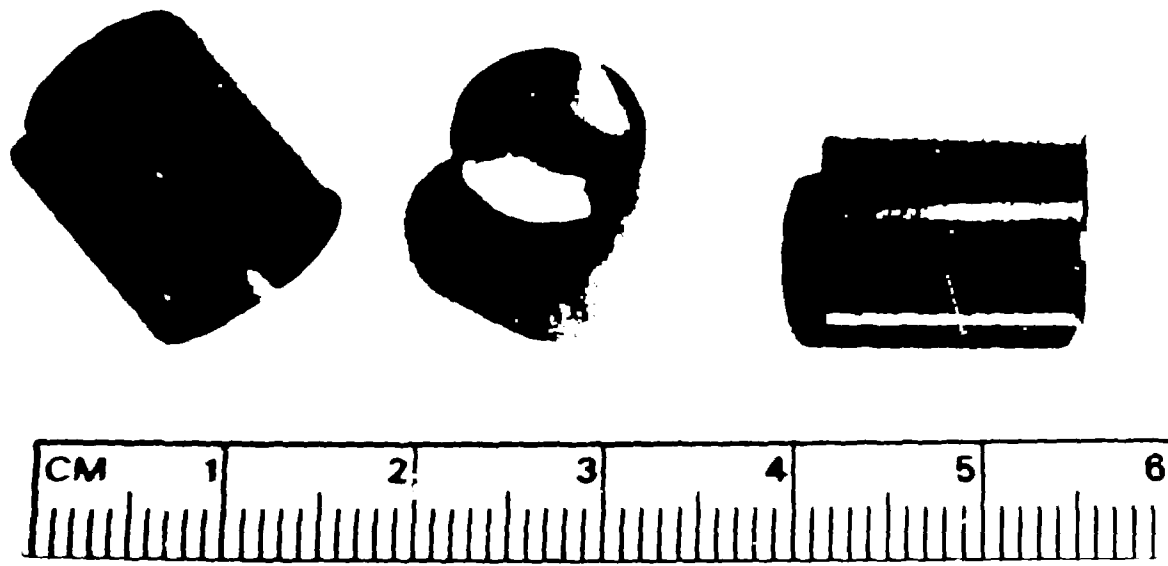

FREESTANDING TUNGSTEN CYLINDERS
3.0 μm WALL THICKNESS
1.0 cm DIAM X 1.36 cm LONG
Los Alamos

Figure 22