

Lawrence Berkeley National Laboratory

Recent Work

Title

MECHANICAL TRANSPORT AND POROUS MEDIA EQUIVALENCE IN ANISOTROPIC FRACTURE NETWORKS

Permalink

<https://escholarship.org/uc/item/6tz4x1fq>

Authors

Endo, H.K.

Witherspoon, P.A.

Publication Date

1985



Lawrence Berkeley Laboratory

UNIVERSITY OF CALIFORNIA

RECEIVED

LAWRENCE
BERKELEY LABORATORY

MAR 26 1985

EARTH SCIENCES DIVISION

LIBRARY AND
DOCUMENTS SECTION

Presented at the 17th International Congress of
the International Association of Hydrogeologists
Tucson, AZ, January 7-12, 1985

MECHANICAL TRANSPORT AND POROUS MEDIA
EQUIVALENCE IN ANISOTROPIC FRACTURE NETWORKS

H.K. Endo and P.A. Witherspoon

January 1985

TWO-WEEK LOAN COPY

*This is a Library Circulating Copy
which may be borrowed for two weeks.*

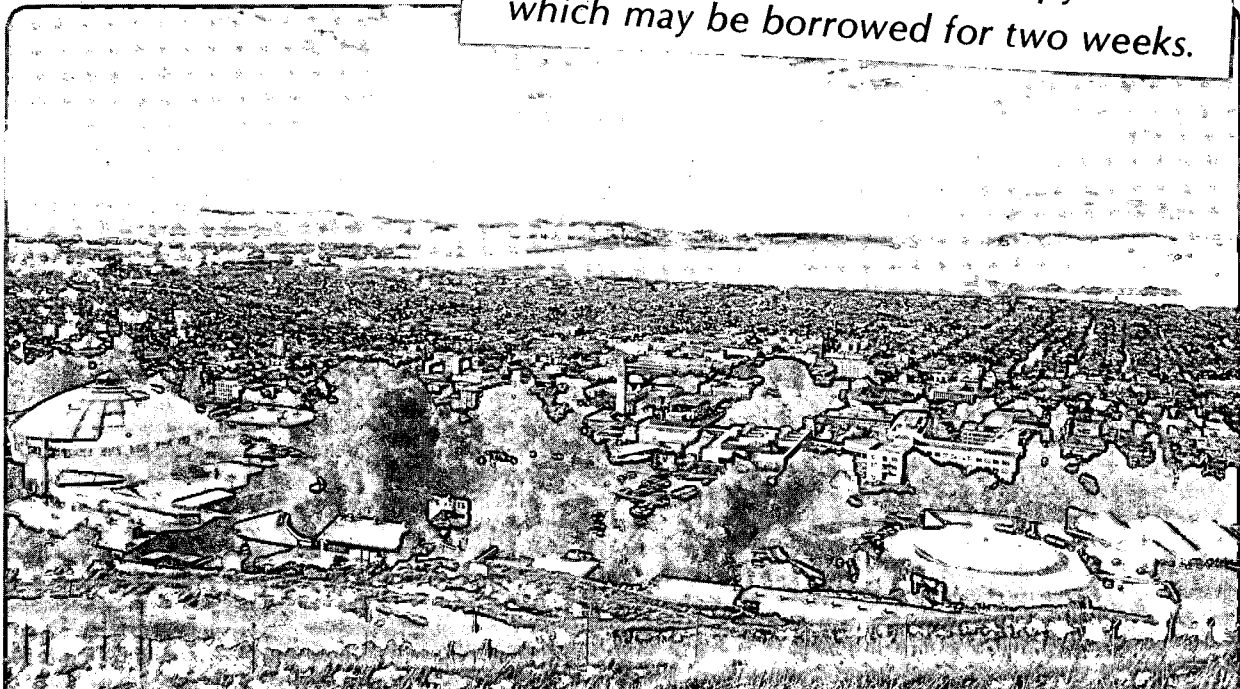

LBL-18565

DISCLAIMER

This document was prepared as an account of work sponsored by the United States Government. While this document is believed to contain correct information, neither the United States Government nor any agency thereof, nor the Regents of the University of California, nor any of their employees, makes any warranty, express or implied, or assumes any legal responsibility for the accuracy, completeness, or usefulness of any information, apparatus, product, or process disclosed, or represents that its use would not infringe privately owned rights. Reference herein to any specific commercial product, process, or service by its trade name, trademark, manufacturer, or otherwise, does not necessarily constitute or imply its endorsement, recommendation, or favoring by the United States Government or any agency thereof, or the Regents of the University of California. The views and opinions of authors expressed herein do not necessarily state or reflect those of the United States Government or any agency thereof or the Regents of the University of California.

MECHANICAL TRANSPORT AND POROUS MEDIA EQUIVALENCE IN ANISOTROPIC FRACTURE NETWORKS

Howard K. Endo* and Paul. A. Witherspoon
Earth Sciences Division, Lawrence Berkeley Laboratory
University of California, Berkeley, California 94720

Abstract

The objective of this work is to investigate the directional characteristics of hydraulic effective porosity in an effort to understand porous medium equivalence for continuous and discontinuous fracture systems. Continuous systems contain infinitely long fractures. Discontinuous systems consist of fractures with finite lengths. The distribution of apertures (heterogeneity) has a major influence on the degree of porous medium equivalence for distributed continuous and discontinuous systems. When the aperture distribution is narrow, the hydraulic effective porosity is slightly less than the total porosity for continuous systems, and greater than the rock effective porosity for discontinuous systems. However, when heterogeneity is significant, the hydraulic effective porosity is directionally dependent and greater than total porosity for both systems. Non-porous medium behavior was found to differ for distributed continuous systems and for continuous systems with parallel sets. For the latter systems, hydraulic effective porosity abruptly decreases below total porosity in those particular directions where the hydraulic gradient and the orientation of a fracture set are orthogonal. The results for the continuous systems with parallel sets also demonstrate that a system that behaves like a continuum for fluid flux may not behave like a continuum for mechanical transport.

INTRODUCTION

The storage of radioactive waste deep underground has stimulated interest in understanding fluid flow and transport in rocks of low-permeability. In many of these systems, the major channels of transport are fractures. Conventional porous media concepts may not be appropriate for analyzing fluid flow and transport in such situations.

In porous media, the size, shape, and degree of interconnection of the pores regulate the rate of transport. The scale of these voids is small and for most purposes the medium may be treated as a continuum in which the macroscopic transport properties are considered without regard to the actual flowpaths of the individual fluid particles. In a fractured rock, however, the scale of the voids can be large enough that the continuum approach is not appropriate for all applications. In such cases, the behavior of networks of individual fractures must be analyzed to understand the macroscopic transport properties.

Techniques for evaluating porous medium equivalence for fluid flow in fracture networks have been developed. Research by Long (1983) has established the conditions for equivalent porous medium behavior for fluid flux. This paper presents a technique for evaluating porous medium equivalence for the ratio of fluid flux to mean transport velocity. This ratio will be termed hydraulic effective porosity, ϕ_H .

*currently with M & E Pacific, Honolulu, Hawaii

A numerical model which simulates mechanical transport is used in this research to measure hydraulic effective porosity. Mechanical transport is the component of transport that is simply due to the movement of fluid within the flow paths. We assume that fluid flow is restricted to planar fractures within an impermeable rock matrix. Mechanical transport is simulated by tracing fluid movement within steamtubes that connect the inflow and outflow boundaries of a fracture system. A model has recently been developed by Endo et al. (1984) that can be used for this purpose.

Fracture systems can be grouped into continuous and discontinuous systems. Continuous systems consist of fractures that are very long compared to the region under study. Snow (1969) demonstrated the techniques that can be used to evaluate the porous medium flow properties of continuous systems. Discontinuous systems consist of finite length fractures. These systems are more difficult to analyze than continuous systems because it is not known whether the behavior of the system will converge to that of an equivalent porous medium. Both types of fracture systems will be investigated in this paper.

THEORETICAL AND MODEL DEVELOPMENT

An experimental procedure will be described to measure hydraulic effective porosity. First, the measurement of hydraulic effective porosity in a given direction will be presented. Next, it will be shown how the directional measurement of hydraulic effective porosity can be used to investigate porous medium equivalence.

Hydraulic effective porosity is used to express the relationship between flux and mean velocity for an equivalent porous medium and is defined as the ratio of specific discharge, q , to average linear velocity. The average linear velocity is the straight or linear travel length divided by the mean flow travel time. In evaluating hydraulic effective porosity for an equivalent continuum, mean travel time is the only parameter that needs to be measured if specific discharge and linear travel length are held constant. We use this technique to measure ϕ_H by maintaining the proper flow field in a fracture system such that when the system behaves like an equivalent porous medium hydraulic effective porosity can be measured.

Figure 1 illustrates these boundary conditions which are designed to create a uniform specific discharge if the medium behaves as an anisotropic, homogeneous continuum. First, as shown in Figure 1a, constant hydraulic heads of H and 0 respectively, are fixed on Sides 2 and 4 of the flow region. Then, constant hydraulic gradients are maintained along Sides 1 and 3. A constant hydraulic gradient in the flow field is needed to assure that \vec{q} will be uniform throughout the flow region in accordance with Darcy's law. The uniform flow field for this anisotropic medium is shown in Figure 1c.

The remaining condition is for the linear length of travel to be constant within the region where hydraulic effective porosity is measured. This condition is maintained within the cross-hatched zone in Figure 2 where fluid flows continuously between Sides 2 and 4 with an angle of flow θ . Thus, once the boundary conditions have been established as illustrated in Figure 1a, a test section is defined where specific discharge and linear travel length will be constant for fracture systems behaving as equivalent porous medium and the hydraulic effective porosity can be determined simply by measuring mean travel time within this test section.

The directional nature of hydraulic effective porosity is investigated to evaluate porous medium equivalence. In an anisotropic porous medium, the ratio of flux to velocity is assumed to be independent of direction and equal to the porosity. Since porosity is independent of direction in an

equivalent continuum, hydraulic effective porosity should be constant in all directions. Thus, the test for equivalent porous medium behavior is to investigate the directional stability of hydraulic effective porosity.

The steps used to investigate the directional nature of hydraulic effective porosity, ϕ_H are described below. In the first step, an orientation of the medium is selected for study (Figure 3a). Next, the hydraulic boundary conditions shown in Figure 1a are applied to a flow region aligned in this direction to create the desired uniform flow field. In the second step, mean travel time is measured by monitoring the detailed movement of fluid within the cross-hatched test section shown in Figure 2. The numerical model is used to simulate mechanical transport in this step. The measurement of hydraulic effective porosity corresponds to a particular direction of flow B_1 (Figure 3b).

The directional characteristics of hydraulic effective porosity are investigated in step 3. In this step, the orientation of the medium is rotated as shown in Figure 3c and a second set of measurements are made by repeating steps 1 and 2 for the new direction of flow B_2 (Figure 3b). Next, step 3 is systematically repeated for selected orientations until a representative sample of hydraulic effective porosity is obtained. These steps constitute the execution of the set of numerical experiments needed to evaluate the directional nature of ϕ_H .

Investigation of Continuous Fracture Systems

Continuous fracture systems consist of fractures which are very long compared to the region under study. The void region is totally connected in continuous systems and there are no dead end zones. In the first investigation of networks with continuous fractures, the system consisted of two sets of parallel fracture oriented at 0° and 30° , as illustrated in Figure 4. All fractures had an aperture of 0.002 cm, and the spacing between fractures was a constant value of 10 cm.

Figure 5 shows the plot of $(q/\cos\theta)^{1/2}$, which in this case is equal to the permeability in the direction of flow divided by 100, versus direction of flow. It may be seen that the specific discharge curve is an ellipse with directions of maximum and minimum permeabilities near 15° and 105° , respectively. The ellipse is symmetric about the two principal directions which shows that this particular network of continuous fractures has the same flow behavior as a porous medium.

Having demonstrated that this system of continuous fracture behaves like a porous medium for fluid flow, we next investigated equivalent porous medium behavior for ϕ_H . For comparison, one needs the total porosity, ϕ , of the fracture system. The porosity of each set is 0.0002, which is simply the 0.002 cm aperture divided by the 10 cm spacing, and therefore the total porosity for the two sets is 0.0004.

Figure 6 is a plot of the hydraulic effective porosity versus direction of flow. Near directions 30° and 130° there is a dramatic reduction in ϕ_H . At either direction one set of fracture becomes nonconductive because the orientation of the hydraulic gradient is perpendicular to that particular set. Consequently ϕ_H is equal to $\phi/2$ in either flow direction. The directional dependence of hydraulic effective porosity shows that this fracture system does not behave like an equivalent porous medium. The results demonstrate that a fracture system which behaves as a continuum for fluid flux may not necessarily behave as a continuum for mechanical transport.

Distributed continuous fracture systems were studied next. A system is distributed when the three fracture geometric parameters of orientation, aperture, and location in the generation region are

probabilistically simulated. The focus of this study with distributed continuous systems was to investigate how the distribution of apertures (degree of heterogeneity) influences the directional characteristics of hydraulic effective porosity.

Two fracture systems were used. The fracture locations and orientations were simulated in the generation region using the same procedure for both systems. Fracture orientations were probabilistically simulated using a Gaussian distribution. For set 1, a mean orientation of 0° and a standard deviation of 30° were used in the probabilistic simulation. For set 2, a mean orientation of 90° and a standard deviation of 35° were used. The locations of fractures were randomly distributed along a scan line which passed through the center of the generation region and was aligned perpendicular to the mean orientation of the set. Figure 7 shows the fracture pattern in the generation region for one realization.

The distribution of apertures was different for the two systems. The apertures in each set for the first system were lognormally distributed with a ratio of the standard deviation to mean aperture, called the coefficient of variation, ν , equal to 0.3. The apertures for the second system were distributed using a value of $\nu = 1.0$.

Figure 8 shows the polar plot of hydraulic effective porosity for the first system ($\nu = 0.3$) after five realizations. The polar plot of ϕ_H is nearly circular, and thus, this fracture system exhibits the characteristics of an equivalent porous medium. The mean value for ϕ_H of 0.0000187 is slightly less than the mean total porosity of 0.0000192 because a fracture in a continuous system such as this becomes nonconductive and incapable of fluid transport when the hydraulic gradient is perpendicular to the orientation of the fracture.

Figure 9 shows a polar plot of hydraulic effective porosity after 25 realizations for the system with $\nu = 1.0$. The jagged shape of the polar plot indicates that ϕ_H is directionally dependent. This system does not exhibit the characteristics of an equivalent porous medium. The mean directional ϕ_H of 0.000016 is larger than the mean total porosity of the system which is 0.000011.

Non-porous medium behavior for this distributed system differs from that of the continuous fracture systems with parallel sets. For the systems with parallel sets, hydraulic effective porosity abruptly decreased well below the total porosity in certain directions where the orientation of the fracture set was orthogonal to the direction of the hydraulic gradient. By contrast, for this distributed fracture system, hydraulic effective porosity was larger than total porosity. The difference in transport behavior between the two types of systems is due to the configuration of the fracture pattern and the distribution of apertures (degree of heterogeneity). As heterogeneity increases, travel times through fractures with small apertures become very large, and this causes the mean travel time and subsequently hydraulic effective porosity to increase.

Investigation of Discontinuous Systems

Discontinuous systems consist of fractures with finite length. Mechanical transport will differ in continuous and discontinuous systems because of the structure of the void region. The void region for discontinuous systems consists of dead-end zones, isolated zones, and conductive zones. In continuous systems, no dead-end or isolated zones exist. However, part of the void region in continuous systems may become nonconductive due to the orientation of the hydraulic gradient.

The first discontinuous system studied consisted of 2 sets of fractures. The first set had a mean orientation of 0° and a standard deviation of 5° . The second set had a mean orientation of 60° and a standard deviation of 5° . Fracture lengths were lognormally distributed using a mean of 40 m and a standard deviation of 4 m. Apertures were lognormally distributed using a mean of 0.00002 m and a standard deviation of 0.00002 m.

Figure 10 shows the polar plot of mean square root of permeability in direction of flow, $\sqrt{K_f}$. This plot can be approximated by an ellipse with directions of maximum and minimum permeabilities near 30° and 120° , respectively. This curve is nearly symmetric about the direction of minimum permeability, and the ratio of K_{max} to K_{min} is about 2.4. The elliptic shape of the $\sqrt{K_f}$ curve shows that the directional flow characteristics for this fracture system are essentially those of an equivalent porous medium.

Total porosity, hydraulic effective porosity, and rock effective porosity are each plotted against direction of flow in Figure 11. Rock effective porosity, ϕ_R , is defined as the conductive void volume per volume of rock. Total porosity and rock effective porosity were both stable with direction. Mean directional hydraulic effective porosity was slightly larger than ϕ_R . Hydraulic effective porosity showed a slight directional dependence, with minimum ϕ_H occurring near the direction of maximum permeability. However, the mean hydraulic effective porosity of 0.00073 is a fair estimate of ϕ_H in all directions. Thus, we can conclude that this fracture system can be treated like an equivalent porous medium for transport.

Hydraulic effective porosity was larger than ϕ_R but less than ϕ . Thus q/ϕ_R would overestimate the average linear velocity for this system. Hydraulic effective porosity was larger than ϕ_R because small aperture fractures have a greater control on mechanical transport than large aperture fractures. A fluid stream flows through a series of fractures of different apertures in a fracture network, and the cubic law states that the flow rate is proportional to the cube of the aperture. Consequently, the flow rate in a series of fractures is governed by the fracture with the smallest aperture, so that small aperture fractures will negate the large fluid flux capabilities of fractures with large aperture. Flow rate would only increase for the system if connected pathways of large aperture fractures existed across the total network. However, there is only a small probability of these highly conductive paths developing in a fracture network.

Travel time is inversely proportional to flow rate. Since flow rate in large fractures will be small due to the greater influence on flow rate of the small apertures, travel time will be large in these fractures. Thus, mean travel time and ϕ_H will be large.

The purpose of the next study was to investigate the influence of the degree of heterogeneity on the directional characteristics of hydraulic effective porosity for discontinuous fracture systems. Two discontinuous systems were created using coefficients of variation for aperture of 0.3 and 1.0. In the case of coefficients of variation equal to 1.0, the apertures were correlated to the lengths such that the longer fractures were assigned the larger apertures. The remaining fracture geometric parameters (orientation, length, and fracture center location) were created in the same way for both discontinuous systems. The orientation statistics were identical to those of the previous distributed continuous systems. Fracture lengths for each set were lognormally distributed using a mean of 50 m and a standard deviation of 50 m. Fracture centers were randomly located in a square generation region. The number of fractures created in this generation region was determined from the length-density parameter developed by Long (1983). This parameter relates linear fracture density to mean fracture length and areal density, and was used to correlate the continuous systems discussed earlier with these discontinuous systems.

The polar plots of total porosity, hydraulic effective porosity, and rock effective porosity for the system with ν of 0.3 are shown in Figure 12 after five realizations. All three porosities were directionally stable, and this fracture system behaves like an equivalent porous medium for transport. The mean directional hydraulic effective porosity of 0.0000146 is larger than rock effective porosity, the same result that was found for the previous discontinuous system.

Results for rock effective porosity, hydraulic effective porosity, and total porosity for the discontinuous system with ν of 1.0 are each shown in Figure 13. Both total porosity and rock effective porosity were directionally stable, but hydraulic effective porosity was highly directionally dependent. Hydraulic effective porosity did not show the characteristics of an equivalent porous medium, as is evident from the very jagged polar plot of ϕ_H . The mean directional ϕ_H of 0.000037 is much larger than the mean directional ϕ of 0.000019. These porosity results were based on five realizations, and consequently, they may not be conclusive. However, we believe that hydraulic effective porosity will still exhibit directional tendencies when a large number of realizations are made because the same directional tendencies for ϕ_H were present after 5 and 25 realizations for the continuous system with ν of 1.0. Thus, the same type of non-porous medium behavior was observed for distributed discontinuous and continuous systems with ϕ_H being larger than ϕ .

CONCLUSIONS

This paper has examined the problem of the directional characteristics of hydraulic effective porosity for continuous and discontinuous fracture systems. Hydraulic effective porosity is constant in all directions if the system behaves like an equivalent porous medium. The distribution of apertures (heterogeneity) was found to have a major influence on the degree of porous medium equivalence for distributed continuous fracture systems. When heterogeneity was small (narrow aperture distribution), the system behaved like an equivalent porous medium with the hydraulic effective porosity being slightly less than the total porosity. However, when heterogeneity was large, the hydraulic effective porosity became directionally dependent and larger than the total porosity. Non-porous medium behavior differed for the distributed continuous systems and for the continuous systems with sets of parallel fractures. For the continuous system with two parallel sets, the hydraulic effective porosity abruptly decreased well below the total porosity in directions where the orientation of either set was orthogonal to the direction of the hydraulic gradient. The results for the continuous system with parallel sets also demonstrated that a system which behaved as a continuum for fluid flux may not behave like a continuum for mechanical transport.

The study of discontinuous fracture systems showed that when the hydraulic effective porosity was directionally stable, its value was intermediate between that of total porosity and rock effective porosity. Hydraulic effective porosity did not equal rock effective porosity because of the controlling influence small aperture fractures have on flow rate and subsequently travel time. The large flow capacities of large aperture fractures are often negated by the small aperture fractures in the system, which means that travel time through these large fractures is larger than expected. This tends to make hydraulic effective porosity larger than rock effective porosity. The distribution of apertures was found to have the same influence on the degree of porous medium equivalence for discontinuous and distributed continuous fracture systems.

ACKNOWLEDGEMENTS

This work was funded by the U. S. Department of Energy under Contract Number DE-AC-03-76SF00098.

REFERENCES

- Endo, H. K., Long J. C. S., Wilson, C. R., and Witherspoon, P. A., 1984, A model for investigating mechanical transport in fracture networks, accepted for publication in Water Resources Research.
- Long, J. C. S., 1983, "Investigation of Equivalent Porous Medium Permeability in Networks of Discontinuous Fractures," Ph.D. Thesis, University of California, Berkeley.
- Snow, D. T., 1969, Anisotropic permeability of fractured media, Water Resources Research, 5(6), . 1273-1289.

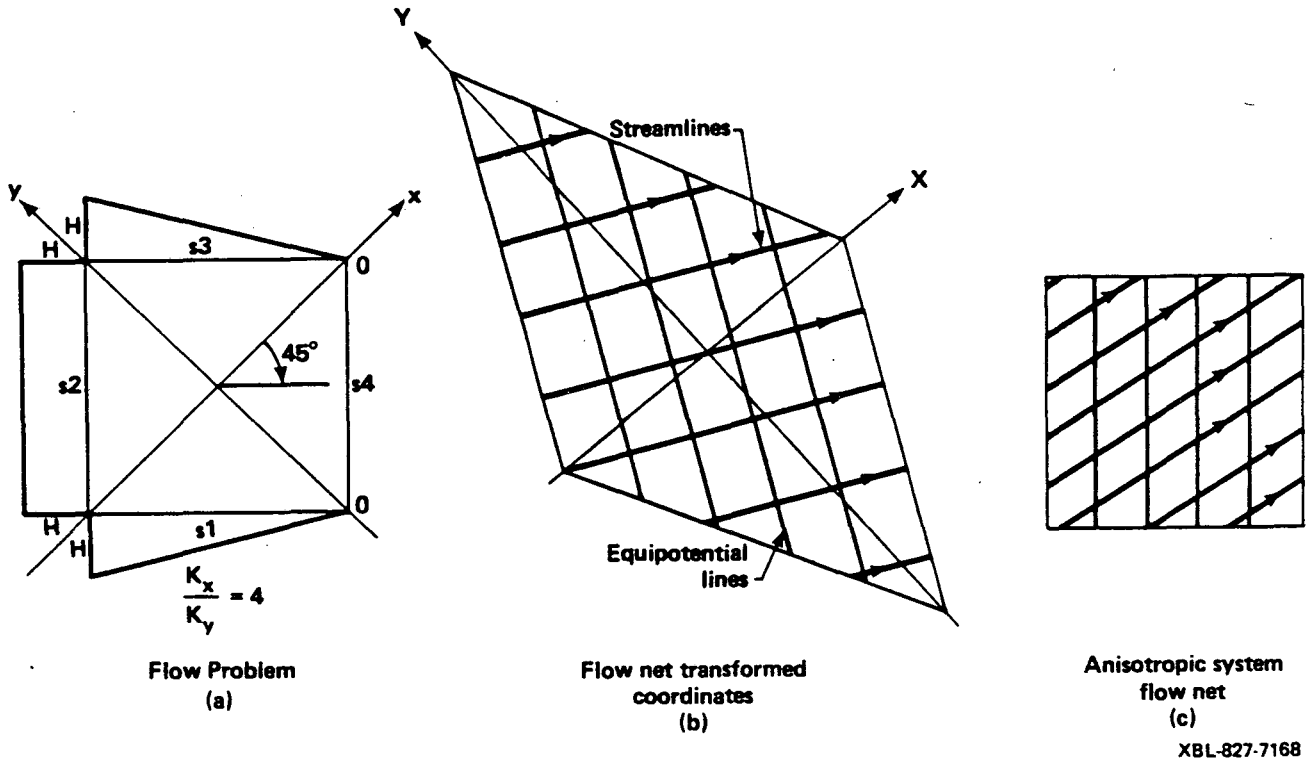
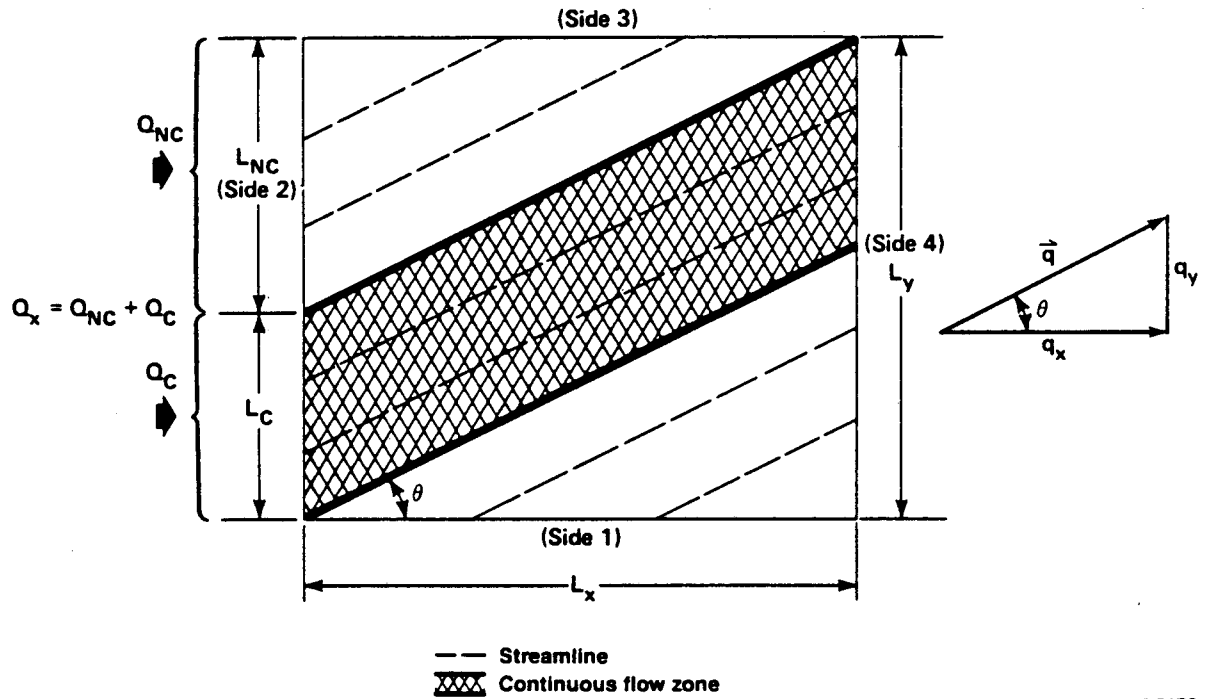
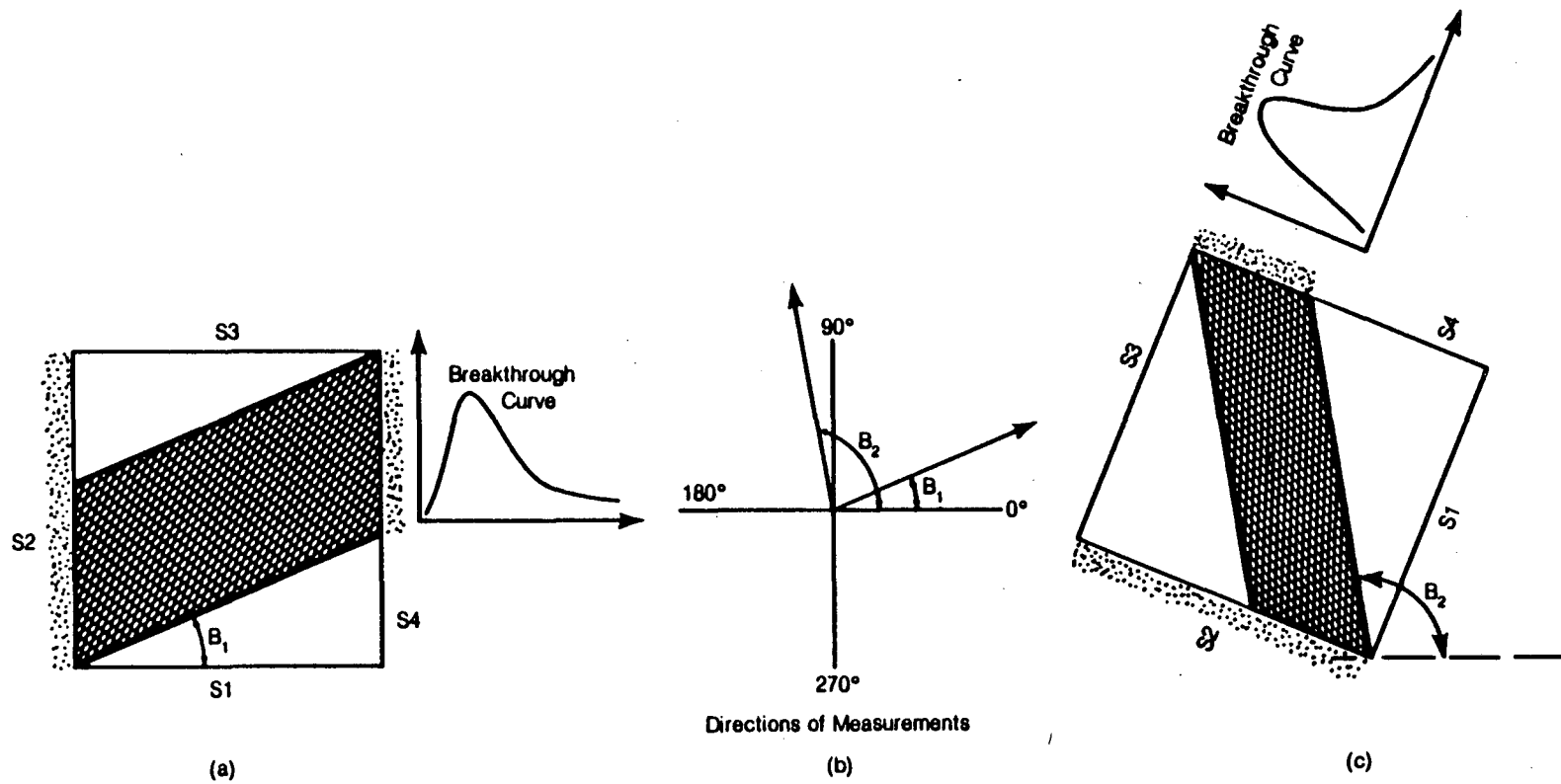

Figure 1. Flow field for an anisotropic porous medium with a constant hydraulic gradient.



XBL 827-7173

Figure 2. Example of groundwater flow in an anisotropic porous medium showing a cross-hatched zone where travel length is constant.



XBL 841-386

Figure 3. Procedure used in conducting a set of tracer experiments to measure directional mechanical transport for an anisotropic porous medium.

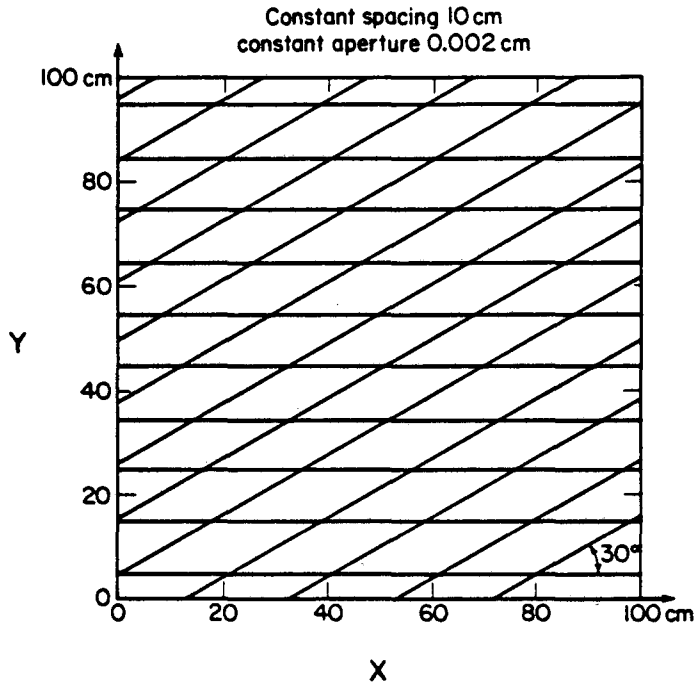

XBL-829-4642

Figure 4. Fracture network with two sets of parallel, continuous and constant-aperture fractures.

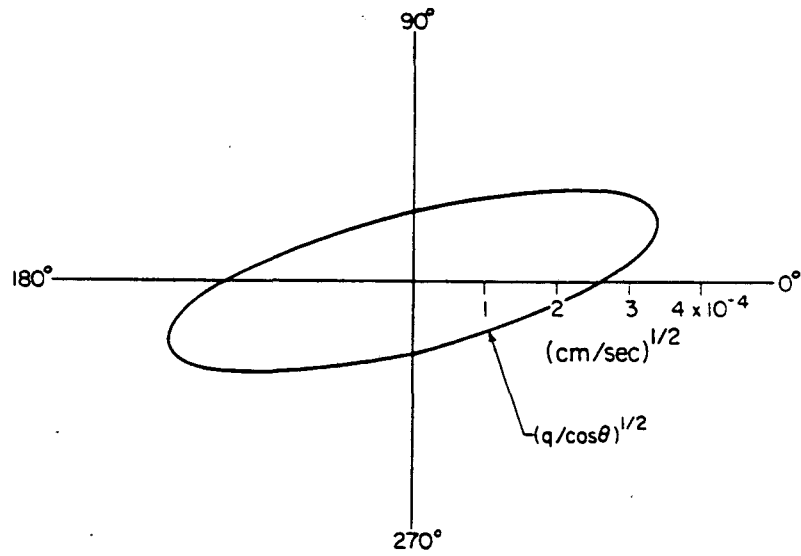

XBL 838-524A

Figure 5. Polar plot of specific discharge versus direction of flow for system with two parallel sets of parallel, continuous and constant-aperture fractures.

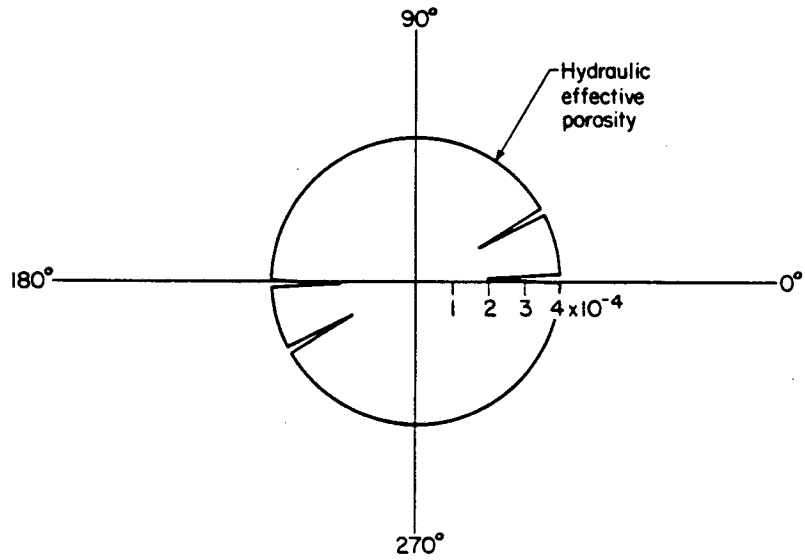

XBL 833-1421

Figure 6. Polar plot of hydraulic effective porosity versus direction of flow for system with two-parallel sets of parallel, continuous and constant aperture fractures.

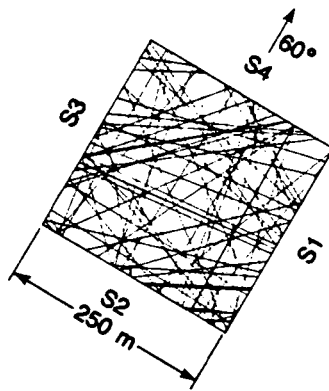
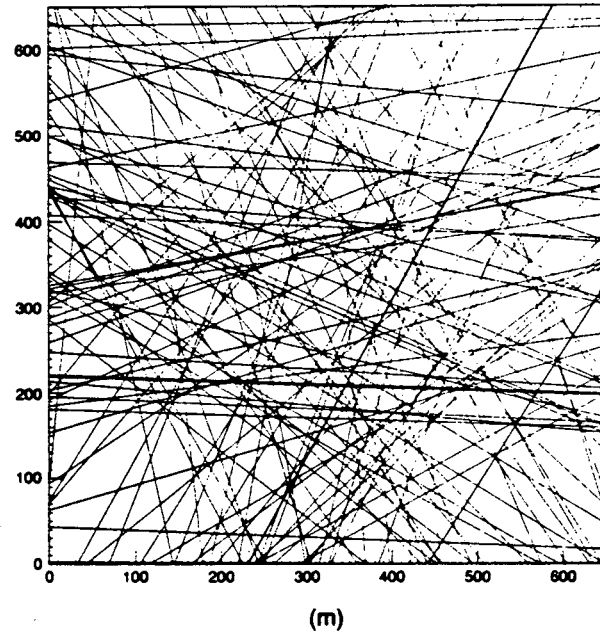

XBL 8211-3486A

Figure 7. Fracture network with two sets of continuous fractures where orientations have been probabilistically simulated using Gaussian distributions.

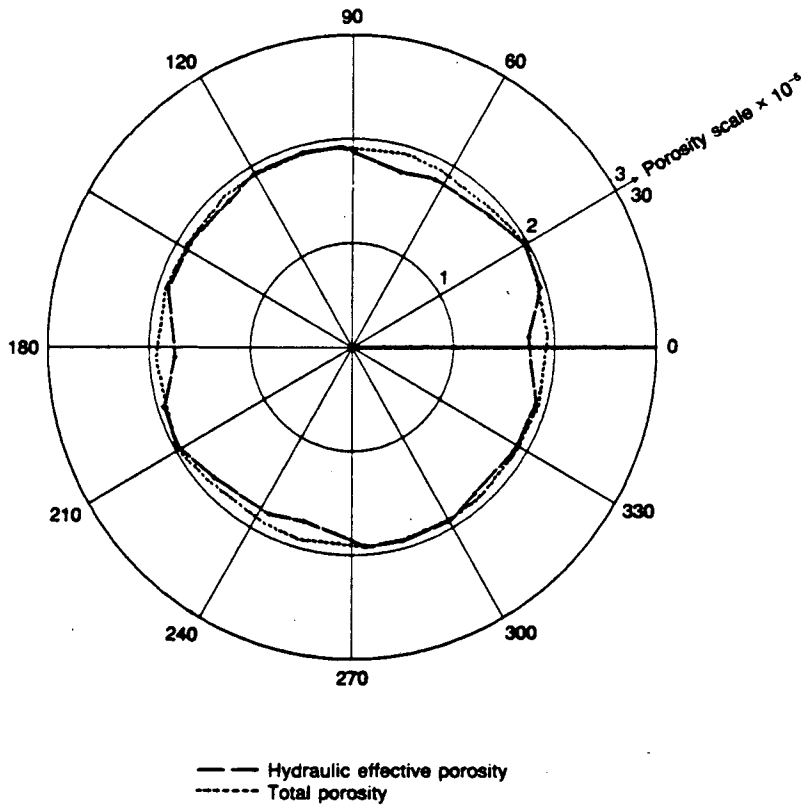

XBL 8312-7424

Figure 8. Polar plot of hydraulic effective and total porosity versus direction of flow after five realizations for distributed system of continuous fractures with lognormal distribution of apertures and $\nu = 0.3$.

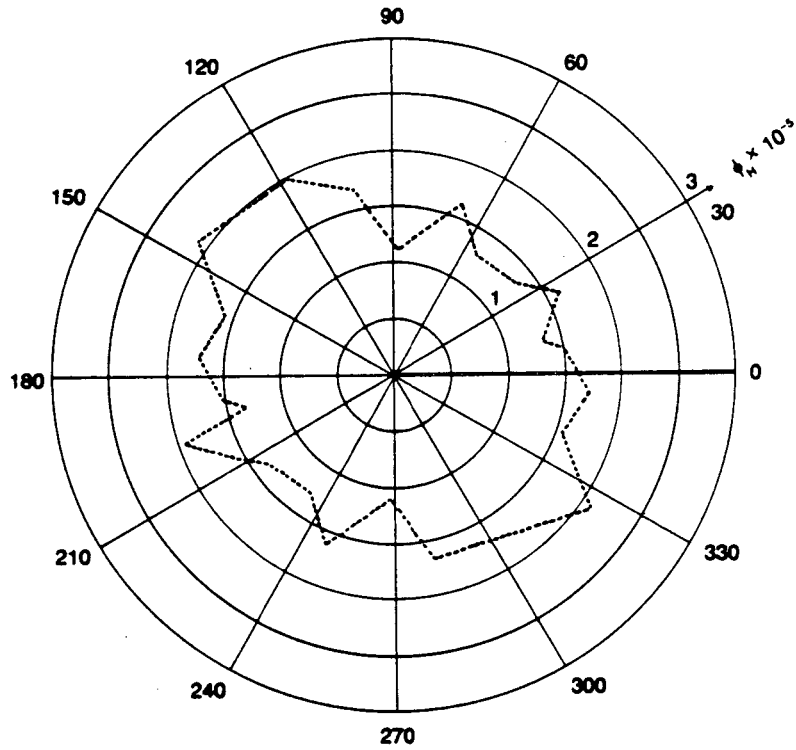

XBL 8312-7423-A

Figure 9. Polar plot of hydraulic effective porosity versus direction of flow after 25 realizations for distributed system of continuous fractures with lognormal distribution of apertures and $\nu = 1.0$.

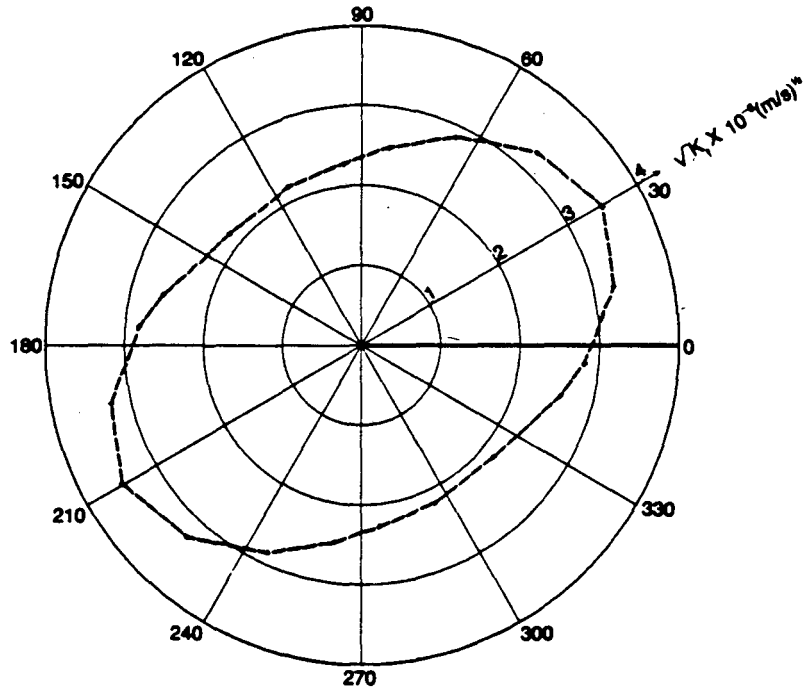

XBL 841-530

Figure 10. Polar plot of $\sqrt{K_f}$ versus direction of flow for a distributed network containing two discontinuous sets of fractures, one set with mean orientation of 0° and the other, 60° . Fractures lengths and apertures are lognormally distributed with $v = 0.1$.

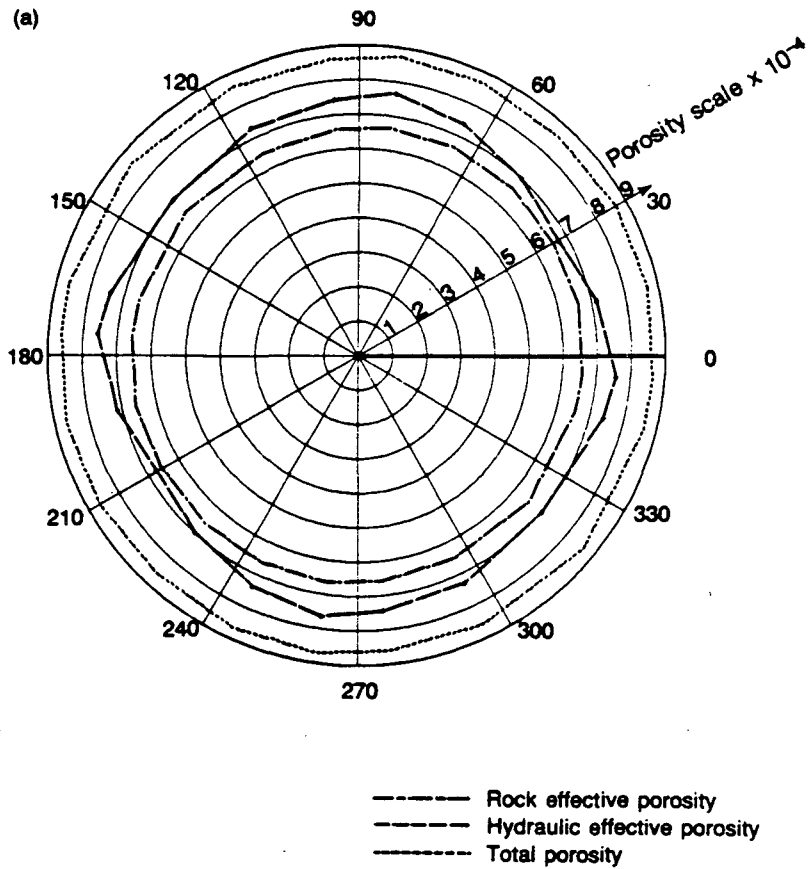

XBL 8311-7283

Figure 11. Polar plot of rock effective, hydraulic effective and total porosity versus direction of flow for a distributed network containing two discontinuous sets of fractures, one set with a mean orientation of 0° and the other, 60° . Fracture lengths and apertures are lognormally distributed with $\nu = 0.1$.

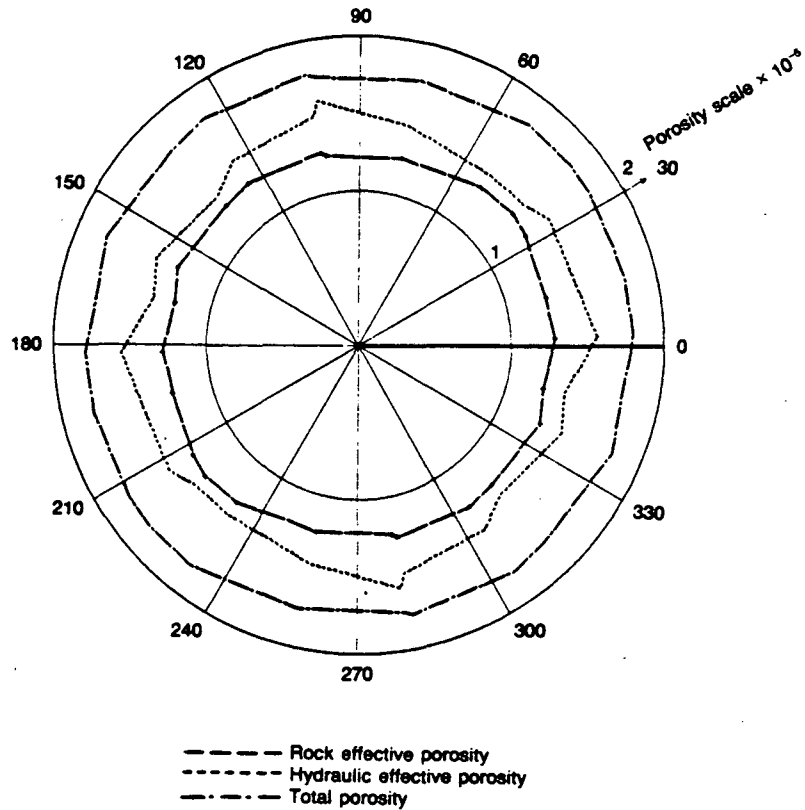

XBL 8312-7421

Figure 12. Polar plot of rock effective, hydraulic effective and total porosity versus direction of flow for a distributed network containing two discontinuous sets of fractures, one set with a mean orientation of 0° and the other, 60° . Fracture lengths are lognormally distributed with $\nu = 1.0$, and apertures are lognormally distributed with $\nu = 0.3$.

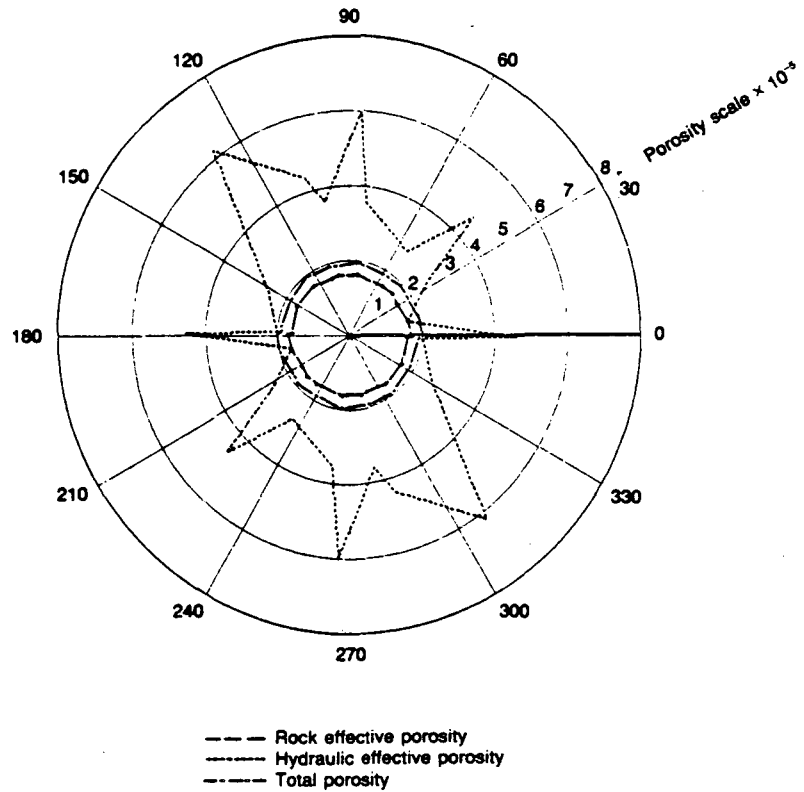

XBL 8312-7419

Figure 13. Polar plot of rock effective, hydraulic effective and total porosity versus direction of flow for a distributed network containing two discontinuous sets of fractures, one set with a mean orientation of 0° and the other, 60° . Fracture lengths and apertures are lognormally distributed with $\nu = 1.0$.

This report was done with support from the Department of Energy. Any conclusions or opinions expressed in this report represent solely those of the author(s) and not necessarily those of The Regents of the University of California, the Lawrence Berkeley Laboratory or the Department of Energy.

Reference to a company or product name does not imply approval or recommendation of the product by the University of California or the U.S. Department of Energy to the exclusion of others that may be suitable.

TECHNICAL INFORMATION DEPARTMENT
LAWRENCE BERKELEY LABORATORY
UNIVERSITY OF CALIFORNIA
BERKELEY, CALIFORNIA 94720