

# Merits of PM Noise Measurement Over Noise Figure: A Study at Microwave Frequencies\*

Archita Hati, David A. Howe, Fred L. Walls, *Fellow, IEEE*, and David K. Walker

**Abstract**—This paper primarily addresses the usefulness of phase-modulation (PM) noise measurements versus noise figure (NF) measurements in characterizing the merit of an amplifier. The residual broadband (white PM) noise is used as the basis for estimating the NF of an amplifier. We have observed experimentally that many amplifiers show an increase in the broadband noise of 1 to 5 dB as the signal level through the amplifier increases. This effect is linked to input power through the amplifier's nonlinear intermodulation distortion. Consequently, this effect is reduced as linearity is increased. We further conclude that, although NF is sometimes used as a selection criteria for an amplifier for low-level signal, NF yields no information about potentially important close-to-carrier  $1/f$  noise of an amplifier nor broadband noise in the presence of a high-level signal, but a PM noise measurements does. We also have verified experimentally that the single-sideband PM noise floor of an amplifier due to thermal noise is  $-177$  dBc/Hz, relative to a carrier input power of 0 dBm.

## I. INTRODUCTION

THIS paper addresses the appropriateness of noise figure (NF) measurements in amplifiers in the presence of a carrier signal. NF is a common amplifier specification that is used to calculate the noise at Fourier frequencies  $f$  that represent the offset from a carrier frequency  $\nu_0$ . In the presence of a carrier signal, the noise level near the carrier is no longer constant but often increases as  $f$  decreases. This increase usually changes at a rate of at least  $1/f$ , flicker behavior, which often significantly dominates over the white-noise level given by the NF, which in practice is measured in the absence of an actual signal through the amplifier. Furthermore, the flicker-noise level depends on the amplifier's linearity and input power. Because of this signal-induced rise in amplifier noise, many systems do not achieve the performance predicted by using the no-signal NF characterization.

The inherent near-direct current (DC) noise of an amplifier, which is usually flicker noise, is nonlinearly multiplied, hence up-converted as alias noise onto the signal being amplified and projected partially as phase-modulation (PM) noise and partially as amplitude-modulation (AM) noise [1], [2]. This behavior significantly limits the perfor-

mance of an amplifier used to amplify and/or distribute low-noise, spectrally pure oscillating signals designed as reference clocks for RF and digital systems. Most notably, timing jitter often is used to assess the limit of system performance, and an amplifier's merit under these circumstances is always better characterized by a PM noise measurements than by a NF measurement.

In this paper, we have used a well-established expression [1]–[3] to calculate the NF of an amplifier in terms of single-sideband PM noise, which is given by:

$$L(f) \equiv \frac{1}{2} S_{\phi}(f) = \frac{kT_0 \text{NF}}{2P_{\text{in}}}, \quad (1)$$

where  $k$  is the Boltzmann's constant,  $T_0$  is the temperature in kelvins, NF is the noise figure, and  $P_{\text{in}}$  is the input power to the amplifier. Though  $L(f)$  is represented as a function of  $f$ , it has no frequency dependence because the function is due to thermal noise.

We have extensively and carefully measured the phase-noise  $L(f)$  of different low-noise GaAs amplifiers at 10 GHz and of a SiGe amplifier at 2.5 GHz under different conditions of input signal. We have observed that the NF derived from a measurement of PM noise is often higher by 1 to 5 dB than that obtained with zero input signal. We also have observed that some amplifiers with low NF do not have lower  $1/f$  noise than those having a higher NF. We conclude that PM noise measurements are substantially more useful in characterizing an amplifier's noise than measurements of no-signal NF.

## II. MEASUREMENT SYSTEM

To ensure that the noise contribution of the measurement system is much lower than the PM noise of an amplifier under test, a two-channel, cross-correlation system for PM noise measurement is used [4]–[7]. A block diagram is shown in Fig. 1. The two-channel system comprises two separate phase-noise measurements that operate simultaneously. Each comprises a power splitter, a phase shifter, and a mixer. The phase shifters establish true phase quadrature between two signals at the mixer inputs. A variable attenuator is used after the device under test (DUT) to maintain a constant power level at port B for different input power to the DUT. For PM noise measurements, the mixer should be in saturation to reduce AM to PM conversion [8]. Therefore, while measuring the PM noise of an amplifier with high gain and low output power, an additional amplifier (shown by dotted lines in Fig. 1) is

Manuscript received December 6, 2005; accepted May 3, 2006.

A. Hati, D. A. Howe, and D. K. Walker are with the National Institute of Standards and Technology (NIST), Boulder, CO (e-mail: archita@boulder.nist.gov).

F. L. Walls is with Total Frequency, Boulder CO.

\*Work of an agency of the U.S. government, not subject to copyright.

Digital Object Identifier 10.1109/TUFFC.2006.121

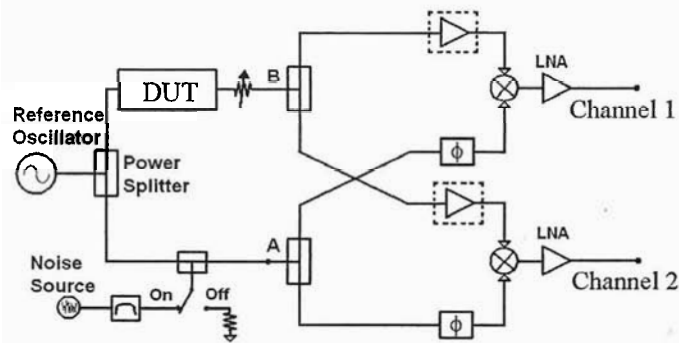
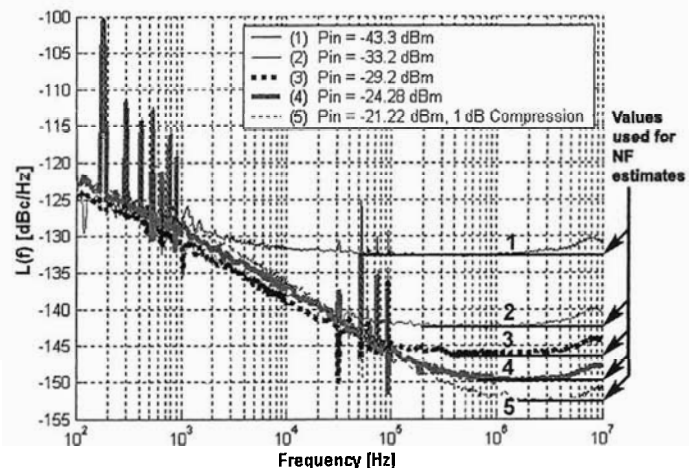

Fig. 1. Block diagram of PM noise-measurement system for amplifiers. LNA is low noise amplifier and DUT is device under test.

introduced in each channel of the measurement system to keep the mixer in saturation. The output of each mixer after amplification is fed to a two-channel, cross-correlation fast Fourier transform (FFT) spectrum analyzer. The advantage of two-channel, cross-correlation method is that only the coherent noise present in both channels averages to a finite value. The time average of the incoherent noise [6], [7] approaches zero as  $N^{-1/2}$ , where  $N$  is the number of averages. The measurement system has a PM noise floor of approximately  $L(10 \text{ Hz}) = -140 \text{ dBc/Hz}$  at a carrier frequency of 10 GHz. This noise level is much lower than the PM noise of the amplifiers under test that are the subject of this paper.

### III. EXPERIMENTAL RESULTS

We measured the PM noise of different amplifiers under different input conditions. Fig. 2(a) shows the PM noise of a GaAs high electron mobility field effect transistor (HEM-FET) amplifier as a function of Fourier frequency for different input power levels at 10 GHz. For this particular amplifier, the broadband noise is higher for low input power, and  $1/f$  noise is lower for low input power. It is apparent from Fig. 2(a) that white PM noise is not flat; there is a rise in the noise level close to  $f = 10 \text{ MHz}$ . This is due to noise contribution of the FFT analyzer as well as mismatch of delay between two signals at the mixer inputs. In order to estimate NF from the experimental graph, a horizontal line has been drawn [shown in Fig. 2(a)] for each input power level and is considered as the thermal noise level,  $L(f)$ . The NF of the amplifier is calculated from  $177 + P_{in} + L(f)$ , which is obtained from (1) by computing  $10 \cdot \log L(f)$ . The dependence of NF on  $P_{in}$  is shown in Fig. 2(b). When the carrier power is low, there is good agreement between NF measured with no carrier and NF measured with a carrier. But, as the carrier power is increased, there are discrepancies between two results. The calculated NF is higher by 2 dB when the amplifier is under 1 dB compression. This effect is due to nonlinear intermodulation processes inside the amplifier [1], [2]. Furthermore, Fig. 2(b) also shows the NF obtained using  $174 + P_{in} + L(f)$ , yielding a negative NF, which is physically impossible. These observations confirm



(a)

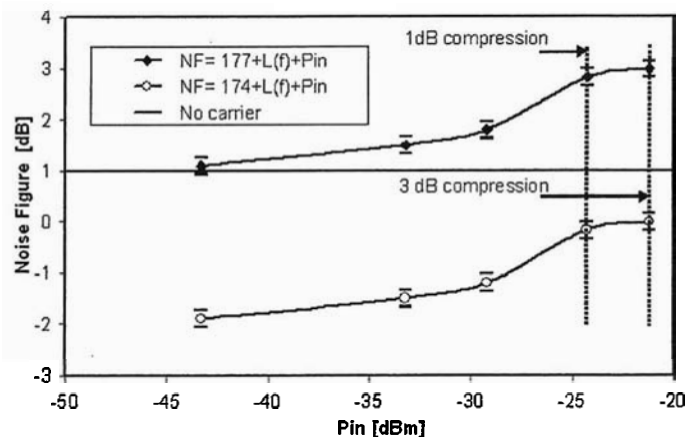

(b)

Fig. 2. (a) PM noise of GaAs HEMFET amplifier at different input power levels. Gain = 32.5 dB, NF = 1 dB, frequency = 10 GHz. The noise floor of the measurement system is 30 dB lower than plot 5 (see Fig. 7) (b). Variation of NF of GaAs HEMFET amplifier with input power. It also shows the uncertainty in NF that is calculated from (2) for  $k = 1.9$  and number of averages,  $N = 10,000$ .

that a PM noise floor of an amplifier due to thermal noise is  $-177 \text{ dBc/Hz}$ , rather than  $-174 \text{ dBc/Hz}$  (referenced to 0 dBm) as reported in previous literature [9], [10].

Fig. 2(b) also indicates the statistical uncertainty in NF calculated from PM noise measurement. The uncertainty is estimated from a formula [7], [11] given by:

$$L^{\alpha}(f) = L(f) \left[ 1 \pm \left( \frac{2kL^s(f)}{L(f)\sqrt{N}} \right) \right], \quad (2)$$

where,  $k$  is the confidence interval index,  $N$  is the number of averages,  $L^s(f)$  is the single channel PM noise,  $L(f)$  is the measured cross-correlated PM noise, and  $L^{\alpha}(f)$  is the actual PM noise.

Similar results are shown in Figs. 3(a) and (b) for a different GaAs FET amplifier having a NF of 1.5 dB. The results indicate that this amplifier shows an increase of the broadband PM noise of 1 to 3 dB as the signal level increases. In other words, the equivalent NF computed from  $L(f)$  is a function of input carrier power.

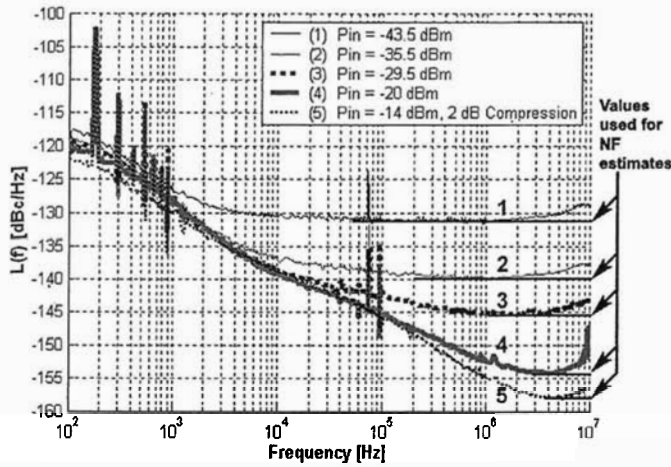

(a)

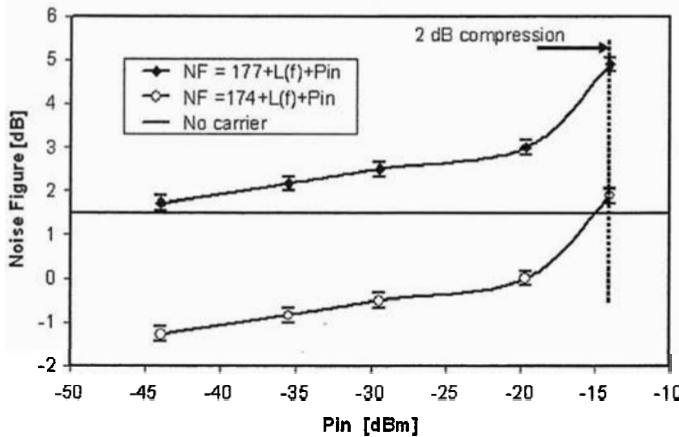

(b)

Fig. 3. (a) PM noise of GaAs FET amplifier at different input power levels. Gain = 35 dB, NF = 1.5 dB, frequency = 10 GHz. The noise floor of measurement system is 30 dB lower than the values shown in plot 5 (see Fig. 7). (b) Variation of NF of GaAs FET amplifier with input power. It also shows the uncertainty in NF that is calculated from (2) for  $k = 1.9$  and number of averages,  $N = 10,000$ .

A wideband amplifier with feedback that is fabricated in IBM's (Burlington, VT) 5 AM SiGe process has been used<sup>1</sup>. At this writing, PM noise is most conveniently measured with a SiGe amplifier at 2.5 GHz, having a noise figure of 3 dB and a gain of about 16 dB due to the as yet unavailability of a SiGe amplifier at 10 GHz for testing [12]. Fig. 4(a) shows the PM noise of the amplifier at different input power levels and Fig. 4(b) shows the dependence of NF on input power. Because the gain of this amplifier is low compared to the amplifiers discussed before, the PM noise and NF were measured for input powers higher than -6 dBm. Due to the requirement of a minimum power for a valid PM noise the measurement, we could not establish the fact that, when the carrier power is very low, there is good agreement between NF measured with no carrier

<sup>1</sup>Commercial products are identified for information only and do not constitute endorsement. Other products may have equal or better performance.

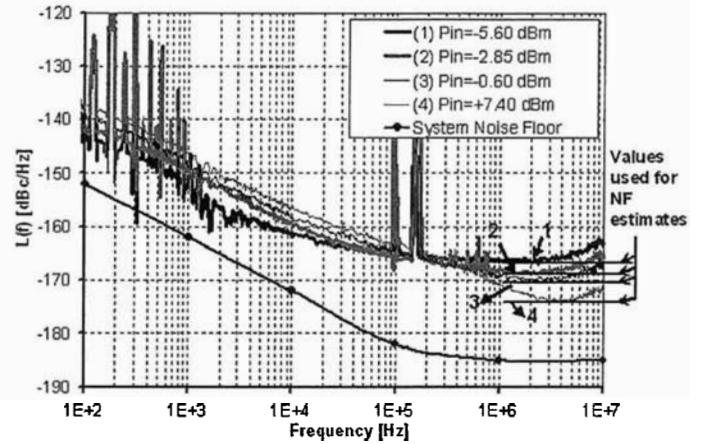

(a)

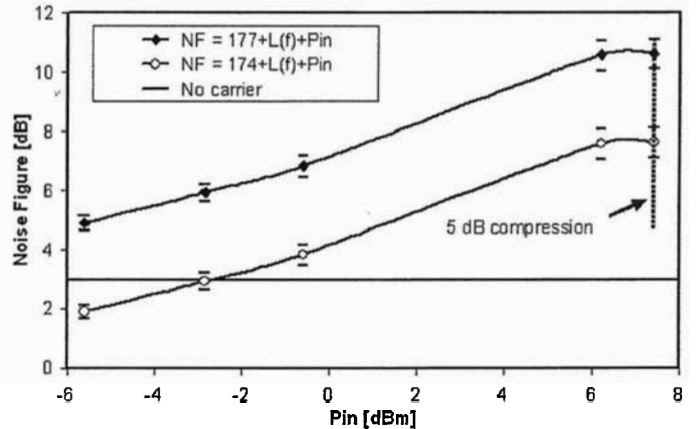

(b)

Fig. 4. (a) PM noise of SiGe FET amplifier at different input power levels. Gain = 16 dB, NF = 3 dB, frequency = 2.5 GHz. (b) Variation of NF of SiGe FET amplifier with input power. It also shows the uncertainty in NF that is calculated from (2) for  $k = 1.9$  and number of averages,  $N = 10,000$ .

and NF measured with a carrier. However, when the amplifier is under 5 dB compression (for an input power of 7.4 dBm), NF is about 7 dB higher than NF measured with no carrier. This seems to emphasize the fact that amplifier NF increases as it is pushed into compression, as we have already seen for GaAs amplifiers.

If this effect is due to nonlinear intermodulation processes, it should be reduced in the case of a highly linear, low-distortion amplifier. We test this hypothesis by measuring a feed-forward-type linear amplifier, the block diagram of which is shown in Fig. 5. The feed-forward configuration implements the technique of carrier suppression, which to a large extent reduces the effect of third order intermodulation [13]. We have measured the PM noise of a commercially available feed-forward amplifier at 10 MHz. The results are shown in Figs. 6(a) and (b). Note that the  $1/f$  noise of this amplifier is very low, due to the high linearity of the amplifier. Previous work [1], [2] showed that the nonlinear up-conversion of the baseband noise is absent in a perfect linear amplifier. The broadband noise of this feed-forward-type linear amplifier is also relatively low in

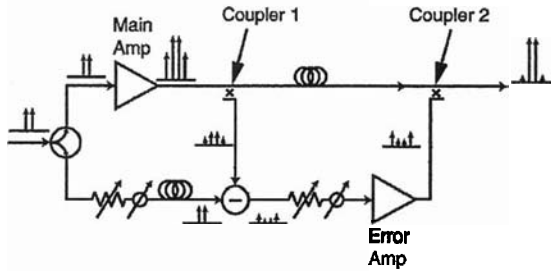
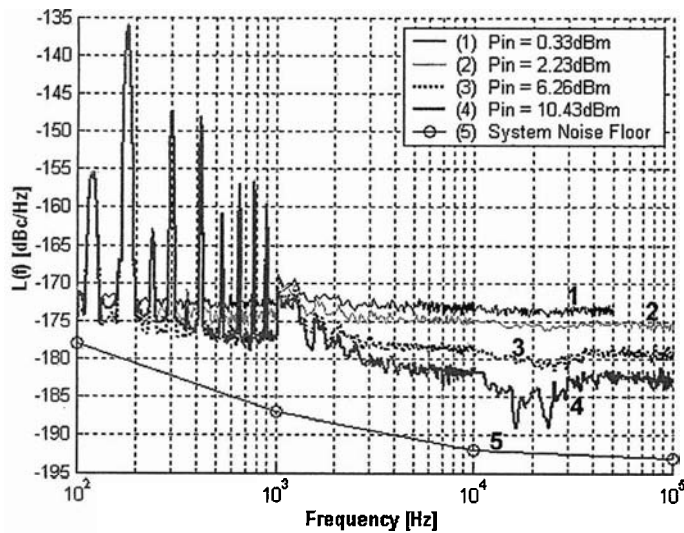
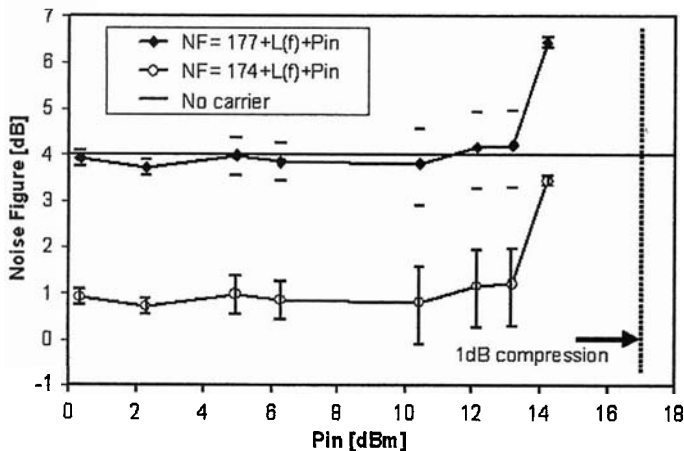

Fig. 5. Block diagram of a feed-forward linear amplifier. Two-tone intermodulation byproducts are shown in the power spectra at various points in the diagram.



(a)



(b)

Fig. 6. (a) PM noise of a high-linearity, feed-forward amplifier at different input power levels at 10 MHz. Gain = 12.5 dB, NF = 4 dB. (b) Variation of NF of high-linearity, feed-forward amplifier with input power. It also shows the uncertainty in NF that is calculated from (2) for  $k = 1.9$  and number of averages,  $N = 10,000$ .

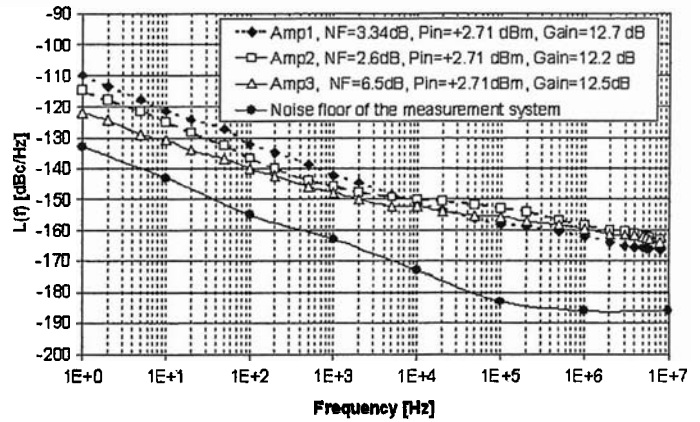

Fig. 7. Variation of flicker noise of different amplifiers with Fourier frequency at 10 GHz. Amp1, Amp2, and Amp3 are all GaAs PHEMT amplifiers.

comparison to other commercially available amplifiers [14]. Fig. 6(b) shows that there is very good agreement between NF with no carrier and NF with a carrier, as long as carrier suppression is in effect in the amplifier. Furthermore, the observations with this linear amplifier once again confirm that PM noise floor of an amplifier due to thermal noise is  $-177$  dBc/Hz.

The results above show that a PM noise measurement is more useful than a NF measurement in estimating the operating NF of an amplifier. Another advantage of a PM noise measurement is that it yields information about the flicker,  $1/f$  noise of an amplifier, but a NF measurement does not because NF is only meaningful at Fourier frequencies  $f$  where phase noise is white. In order to support this fact, we measured the PM noise of different amplifiers. Fig. 7 shows the flicker noise of three different amplifiers under the same input conditions but with different NF's. All three are GaAs pseudomorphic high electron mobility transistor (PHEMT) amplifiers. In these examples, note that the amplifier with the highest NF of 6.5 dB has the lowest  $1/f$  noise, almost 7 to 10 dB lower than the others. Contrary to popular belief, it is impossible to predict the  $1/f$  PM noise level of an amplifier based on its NF.

#### IV. CONCLUSIONS

We have extensively and carefully measured the phase noise  $L(f)$  of different low-noise amplifiers under different input signal conditions. It has been observed that the NF of an amplifier is a function of both carrier power and nonlinear intermodulation distortion. As the linearity of an amplifier increases, NF is less dependent on carrier power. We find that the NF obtained from a PM noise measurement is often higher by 1 to 5 dB than the NF obtained in a conventional manner. Another advantage of a PM noise measurement is that it yields information about the flicker,  $1/f$  noise of an amplifier, but a NF measurement does not because NF is only meaningful at Fourier frequencies  $f$  where phase noise is white. We conclude that PM noise

measurements are substantially more useful in characterizing an amplifier rather than attempting to guess PM noise from NF measurements. It also has been verified experimentally that, in the presence of a carrier, PM noise floor of an amplifier due to thermal noise is  $-177$  dBc/Hz (referenced to 0 dBm) not  $-174$  dBc/Hz as in some literature.

#### ACKNOWLEDGMENT

The authors thank Christopher Hay of Hittite Microwave Corporation, which purchased the assets of Q-Dot, Inc., as it was known at the time of this study, for providing low noise SiGe amplifiers at 2.5 GHz.

#### REFERENCES

- [1] E. S. Ferre-Pikal, F. L. Walls, and C. W. Nelson, "Guidelines for designing BJT amplifiers with low  $1/f$  AM and PM noise," *IEEE Trans. Ultrason., Ferroelect., Freq. Contr.*, vol. 44, pp. 335–343, Mar. 1997.
- [2] F. L. Walls, E. S. Ferre-Pikal, and S. R. Jefferts, "Origin of  $1/f$  PM noise and AM noise in bipolar junction transistor amplifiers," *IEEE Trans. Ultrason., Ferroelect., Freq. Contr.*, vol. 44, pp. 326–334, Mar. 1997.
- [3] W. P. Robins, *Phase Noise in Signal Sources*. London, UK: Peter Peregrinus (IEE), 1984.
- [4] R. Hanbury Brown, R. C. Jennison, and M. K. Das Gupta, "Apparent angular sizes of discrete radio sources," *Nature*, no. 4338, pp. 1061–1063, 1952.
- [5] R. F. C. Vessot, R. F. Mueller, and J. Vanier, "A cross-correlation technique for measuring the short-term properties of stable oscillators," in *Proc. IEEE-NASA Symp. Short Term Freq. Stability*, Nov. 1964, pp. 111–118.
- [6] F. L. Walls, A. J. Clements, C. M. Felton, M. A. Lombardi, and M. D. Vanek, "Extending the range and accuracy of phase noise measurement," in *Proc. 42nd Annu. Freq. Contr. Symp.*, 1988, pp. 432–441.
- [7] W. F. Walls, "Cross-correlation phase noise measurement system," in *Proc. IEEE Freq. Contr. Symp.*, 1992, pp. 257–261.
- [8] G. Cibiel, M. Régis, E. Tournier, and O. Llopis, "AM noise impact on low level phase noise measurements," *IEEE Trans. Ultrason., Ferroelect., Freq. Contr.*, vol. 49, pp. 784–788, June 2002.
- [9] G. K. Montress, T. E. Parker, and M. J. Loboda, "Residual phase noise measurements of VHF, UHF, and microwave components," in *Proc. 43rd Annu. Freq. Contr. Symp.*, 1989, pp. 349–359.
- [10] T. E. Parker, "Characteristics and sources of phase noise in stable oscillators," in *Proc. 41st Annu. Freq. Contr. Symp.*, 1987, pp. 99–110.
- [11] F. L. Walls, "Reducing errors, complexity, and measurement time of PM noise measurements," in *Proc. 47th Annu. Freq. Contr. Symp.*, 1993, pp. 289–297.
- [12] C. E. Hay, M. E. Harrell, and R. J. Kansy, "2.4 and 2.5 GHz miniature, low-noise oscillators using surface transverse wave resonators and a SiGe sustaining amplifier," in *Proc. IEEE Freq. Contr. Symp.*, 2004, pp. 174–179.
- [13] Penny Technologies, "Correction modules for feed-forward applications," *Microwave J.*, vol. 39, pp. 142–144, Aug. 1996.
- [14] M. C. D. Aramburo, E. S. Ferre-Pikal, F. L. Walls, and H. D. Ascarrunz, "Comparison of  $1/f$  PM noise in commercial amplifiers," in *Proc. IEEE Freq. Contr. Symp.*, 1997, pp. 470–477.



**Archita Hati** was born in West Bengal, India on April 26, 1970. She received her B.Sc., M.Sc., and Ph.D degrees in Physics from University of Burdwan, W.B., India, in 1990, 1992, and 2001, respectively. She also received her M.Phil. in Microwaves from the same university in 1993. Her Ph.D. work involved studies on high performance frequency synthesizers and related problems.

Since May 2001 she has been a guest researcher with the Time and Frequency Standards and Technology (NIST), Boulder, CO, and the Physics Laboratory's Time and Frequency Division, Boulder, CO. Her area of extensive experience includes high-precision spectrum and noise analysis of precision oscillators. She was involved with the design of low phase noise Cs frequency synthesizers for atomic clocks. Presently, she is involved in developing a W-band phase noise measurement system. She also performs calibration services for NIST.

She has published more than 27 scientific papers in national and international journals.



**David A. Howe** is leader of the Time and Frequency Metrology Group of the National Institute of Standards and Technology (NIST), Boulder, CO, and the Physics Laboratory's Time and Frequency Division, Boulder, CO. Mr. Howe has physics and math B.A. degrees from the University of Colorado, Boulder, CO, and is a member of Sigma Pi Sigma and Phi Beta Kappa academic societies. His expertise includes spectral estimation using digital processing techniques, spectral purity and noise analysis, digital servo design, automated accuracy evaluation of primary cesium standards, atomic beam analysis, reduction of oscillator acceleration sensitivity for special applications, statistical theory, and clock-ensemble algorithms.

From 1970 to 1973, he was with the Dissemination Research Section at NIST (then the National Bureau of Standards), Boulder, CO, where he coordinated the first TV time experiments, from which evolved closed captioning, as well as lunar-ranging and spacecraft time-synchronization experiments. He worked in NIST's Atomic Standards Section from 1973 to 1984 doing advanced research on cesium and hydrogen maser standards and ruggedized, compact rubidium and ammonia standards. He returned to the Dissemination Research Section in 1984 to lead and implement several global high-accuracy satellite-based time-synchronization experiments with other national laboratories. For this contribution, he was awarded the Commerce Department's highest commendation, the Gold Medal, in 1990 for advancements in time calibrations among standards laboratories who participate in the maintenance of Coordinated Universal Time (UTC). From 1994 to 1999, he worked as a statistical analyst for the Time Scale Section which maintains UTC(NIST) from an ensemble of laboratory atomic frequency standards. Mr. Howe is the developer of the Total and Theol variances used in high-accuracy estimation of long-term frequency stability. He has 98 publications and two patents in subjects related to precise frequency standards, timing, and synchronization.



**Fred L. Walls** (A'93-SM'94-F'02) was born in Portland, OR, on October 29, 1940. He received the B.S., M.S., and Ph.D. degrees in Physics from the University of Washington, Seattle, in 1962, 1964, and 1970, respectively. His Ph.D. thesis was on the development of long-term storage and nondestructive detection techniques for electrons stored in Penning traps and the first measurements of the anomalous magnetic (g-2) moment of low energy electrons.

From 1970 to 1973, he was a Postdoctoral Fellow at the Joint Institute for Laboratory Astrophysics in Boulder, CO. This work focused on developing techniques for long-term storage and nondestructive detection of fragile atomic ions stored in Penning traps for low energy collision studies. In 1973, he became a staff member of the Time and Frequency Division of the National Institute of Standards and Technology (formerly the National Bureau of Standards) in Boulder, CO. He was Leader of the Phase Noise Measurement Group and is engaged in research and development of ultra-stable clocks, crystal-controlled oscillators with improved short- and long-term stability, low-noise microwave oscillators, frequency synthesis from RF to infrared, low-noise frequency measurement systems, and accurate phase and amplitude noise metrology. He has retired from NIST and presently runs Total Frequency in Boulder, CO.

He has published more than 150 scientific papers and articles. He holds five patents for inventions in the fields of frequency standards and metrology. He received the 1995 European "Time and Frequency" Award from the Societe Francaise des Microtechniques et de Chromometric for "outstanding work in the ion storage physics, design and development of passive hydrogen masers, measurements of phase noise in passive resonators, very low noise electronics and phase noise metrology." He is the recipient of the 1995 IEEE Rabi Award for "major contributions to the characterization of noise and other instabilities of local oscillators and their effects on atomic frequency standards" and the 1999 Edward Bennet Rosa Award for "leadership in development and transfer to industry of state-of-the-art standards and methods for measuring spectral purity in electronic systems." He has also received three silver medals from the US Department of Commerce for fundamental advances in high resolution spectroscopy and frequency standards, the development of passive hydrogen masers and the development and application of state-of-

the-art standards and methods for spectral purity measurements in electronic systems. Dr. Walls is a Fellow of the American Physical Society, a Fellow of the IEEE, a member of the Technical Program Committee of the IEEE Frequency Control Symposium, and a member of the Scientific Committee of the European Time and Frequency Forum.



**David K. Walker** received his B.A. in physics and mathematics from Hastings College, Hastings, NE, in 1980, and B.S. and M.S. degrees in electrical engineering from Washington University, St. Louis, MO, in 1982 and 1983, respectively.

He spent eight years in industry working on microwave semiconductor device design and fabrication before joining the National Institute of Standards and Technology (NIST) in Boulder, CO, in 1991 as part of the monolithic microwave integrated circuit (MMIC) Project in the Microwave Metrology Group. His work at NIST has included semiconductor fabrication, network analyzer calibration, and on-wafer measurements. Current research interests include microwave thermal noise measurements, amplifier and transistor noise-parameter characterization, and calibration of radiometers for remote sensing.

Mr. Walker chairs the Automatic RF Techniques Group (ARFTG) Education Committee. He also holds five patents related to microwave technology.