

REVIEW

Metal complexes with Schiff-base ligands – pyridoxal and semicarbazide-based derivatives

VUKADIN M. LEOVAC^{1*#} VIOLETA S. JEVTIČIĆ,^{1#} LJILJANA S. JOVANOVIĆ^{1#} and GORAN A. BOGDANOVIĆ²

¹Department of Chemistry, Faculty of Science, University of Novi Sad, Trg Dositeja Obradovića 3, 21000 Novi Sad (e-mail: vule@ih.ns.ac.yu) and ²Vinča Institute of Nuclear Sciences, Laboratory of Theoretical Physics and Condensed Matter Physics, P. O. Box 522, 11001 Belgrade, Serbia and Montenegro

(Received 23 December 2004)

Abstract: The most important results of extensive studies (syntheses, spectral, magnetic, voltammetric and structural characteristics and biological activity) of metal complexes with pyridoxal semi-, thiosemi- and isothiosemicarbazones are reviewed.

Keywords: metal complexes, pyridoxal, semicarbazide-based derivatives, syntheses, structure, physico-chemical characteristics, biological activity.

CONTENTS

1. Introduction
2. Syntheses and general physical characteristics of the ligands
3. Coordination mode
4. Complexes: syntheses, physico-chemical characteristics and geometric configuration
5. Structural characteristics
6. Spectral characteristics
7. Electrochemistry
8. Biological activity
9. Other characteristics
10. Conclusion

1. INTRODUCTION

Semi-, thiosemi-, and isothiosemicarbazones, (SC, TSC, ITSC, respectively) (Fig. 1), as well as their metal complexes have been the subject of great interest of many researchers for a number of years. The statement is supported by the large number of papers, among them several reviews,^{1–9} while isothiosemicarbazides

* Author for correspondence.

Serbian Chemical Society active member.

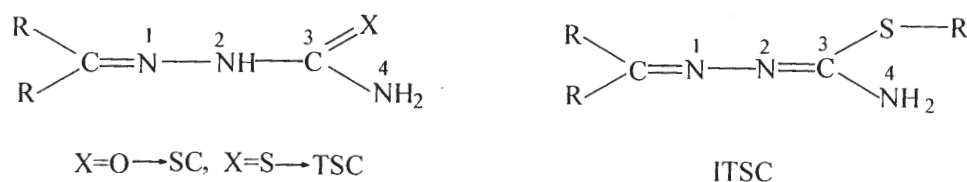

Fig. 1. General structural formulas of semi- thiosemi- and isothiosemicarbazones.

and isothiosemicarbazones were the subject of a monograph.¹⁰ The significance of these compounds, apart from their diverse chemical and structural characteristics, stems not only from their potential but also their proved application as biologically active molecules a wide spectrum of activity. This is especially related to thiosemicarbazones and their metal complexes, for which the relationship between structure and biological activity has been covered in papers by West *et al.*^{3,4} Furthermore, bearing in mind that many semi- and thiosemicarbazones form stable colored metal complexes, some of them have been proposed as analytical reagents.⁷ The coordination chemistry of semi-, thiosemi- and isothiosemicarbazones appeared to be very interesting from the point of view of both the number of metals forming complexes with them and the diversity of the ligand systems themselves (among them being also macrocyclic ones^{8,10-13}) *i.e.*, their denticity, set of donor atoms, stabilization of various (less common) oxidation states of metals,^{14,15} reactions of coordinated ligands,^{13,16,17} *etc.*

The investigation of metal complexes with Schiff bases derived from pyridoxal (PL), *e.g.*, 3-hydroxy-5-hydroxymethyl-2-methylpyridine-4-carboxaldehyde (one of the forms of vitamin B6), and amines, and/or amino acids, have also been the subject of great interest of many researchers.¹⁸⁻²¹ The primary reason for this lies in the fact that these compounds can serve as models for studying a wide range of biological reactions which are catalyzed by enzymes, in which pyridoxal phosphate (PLP), as the physiologically active form of pyridoxal, appears as an essential component.^{18,22} It has been shown that in the presence of metal ions, free pyridoxal can catalyze a variety of metabolic reactions, *e.g.*, of amino acids (transamination, decarboxylation, racemization and carbon-carbon bond cleavage), in which PLP acts as a co-enzyme.^{18,23} On the other hand, some recent pharmacological studies of Schiff bases of pyridoxal and aminoguanidine enabled Japanese authors²⁴ to set up the hypothesis that this Schiff base is more effective than aminoguanidine, which is known as a good inhibitor of the formation of advanced glycation end products, and is considered to be promising for the treatment of diabetic complications.

In view of the fact that Schiff bases of pyridoxal are effective ligands, they are of research interest to coordination chemists. Pyridoxal semi-, thiosemi- and isothiosemicarbazones (PLSC, PLTSC and PLITSC, respectively) (Fig. 2) form a special group of these ligands.

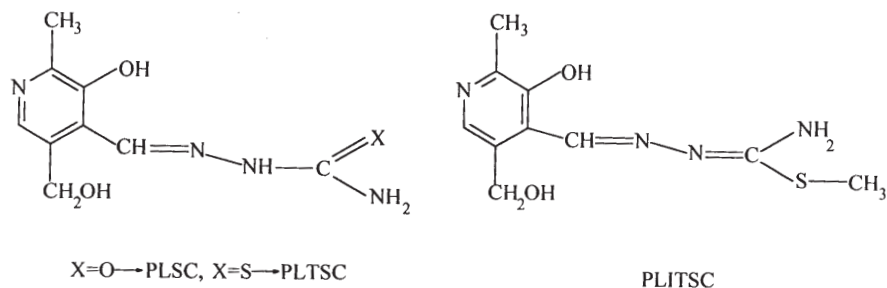

Fig. 2. Structural formulas of pyridoxal semi- (PLSC), thiosemi-(PLTSC) and isothiosemicarbazone (PLITSC).

This review presents the most important results which have been obtained in the studies of these ligands and their metal complexes.

2. SYNTHESSES AND GENERAL PHYSICAL CHARACTERISTICS OF THE LIGANDS

Like the majority of similar Schiff bases, pyridoxal semi-, thiosemi- and isothiosemicarbazones are mainly obtained in good yield by the condensation reaction of aqueous or alcoholic solutions of pyridoxal and the corresponding semicarbazide derivative.²⁵⁻²⁷ Depending on the form (neutral, protonated) of the ligand precursor, *i.e.*, of the presence of a proton acceptor (CO_3^{2-} , OAc^-), it is possible to obtain either neutral or protonated forms of the ligands²⁸ (Scheme 1). In the case of PLTSC the preparation of its trihydrated²⁵ and anhydrous²⁹ forms have been reported.

All three ligands (PLSC, PLTSC, and PLITSC) are yellowish substances, sparingly soluble in water and organic solvents, whereby the protonated forms exhibit somewhat higher solubility. On heating, especially in the presence of metal ions, due to complexation, their solubility shows a dramatic increase. The molar conductivity of aqueous solutions of the protonated forms of these ligands corresponds to 1:1 type of electrolytes. Both ligand forms (neutral and protonated) are characterized by enhanced thermal stability and they melt in the range from 212 °C (PLITSC·H₂O) to 245 °C (PLSC·HCl·H₂O).²⁸ In addition to the mentioned unsubstituted derivatives, in the case of PLTSC, some, mainly N4-substituted (alkyl and aryl), derivatives have been prepared.³⁰

3. COORDINATION MODE

The common coordination mode of these ligands is presented in Fig. 3. As can be seen, of seven potential ligand atoms of all three ligands, three are engaged in coordination, two of them being identical for all three ligands. Namely, the identical ligands are the phenolic oxygen and hydrazine N1 nitrogen. In the case of PLSC and PLTSC, the third ligand atom is the oxygen or sulfur atom of the amide, *i.e.*, thioamide group (Fig. 3 a,b,c). In the case of PLITSC, the third ligand atom is the N4 nitrogen of the

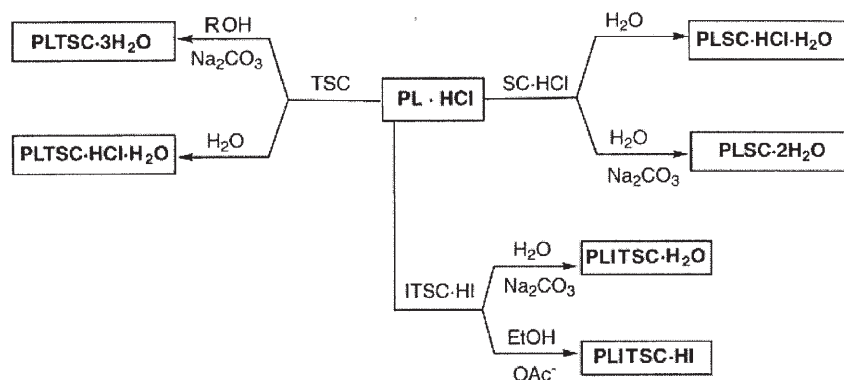

Scheme 1: Syntheses of the ligands.

isothioamide group (Fig. 3d, e, f). In all cases, two metallocycles are formed: one six-membered (pyridoxylidene) and one five-membered (semicarbazide derivative). Furthermore all three ligands can be coordinated either in neutral, monoanionic or dianionic forms. The monoanionic forms of PLSC and PLTSC are formed by deprotonation of the enol/thiol forms (Fig. 3b), and in the case of PLITSC, by deprotonation of the hydrazine nitrogen atom (Fig. 3e), *i.e.*, of the imido form of the isothiosemicarbazide residue*. The dianionic forms of all three ligands are formed by the additional deprotonation of the pyridine nitrogen (Fig. 3 c, f), *i.e.*, of the zwitter ion, the existence of which is explained by the migration of the hydrogen atom from the phenolic OH group to the heterocyclic nitrogen atom. It should be pointed out that this proton transfer is characteristic not only of coordinated but also of non-coordinated pyridoxal derivatives, which in the case of PLTSC·3H₂O was proved by solving its molecular structure by X-ray crystallography²⁵ (*vide infra*). That is, it was found that the angle in the non-protonated pyridine nitrogen increases from $\approx 120^\circ$ to $\approx 124^\circ$, which is characteristic for the pyridine C–NH–C angle. However, in contrast to this, the N-nonprotonated form was found in the structure of PLTSCMe₂·H₂O (PLTSCMe₂ = pyridoxal N4,N4-dimethylthiosemicarbazone).³⁰ IR spectroscopic proof of the existence of the NH⁺ group, *i.e.*, of the dipolar nature of the PL residue, is the appearance of one or more bands at about 2850 cm⁻¹, which, apart from the $\nu(\text{NH})^+$, can also belong to the $\nu(\text{OH})$ of hydroxymethyl groups.^{25,29}

In view of the mentioned deprotonation sequence, the form of the coordinated ligand will depend primarily on the pH and then on the nature of the metal ion. Namely, the presence of proton acceptors (NH₃, OAc⁻, Py, *etc.*) will facilitate the formation of complexes with the anionic forms of the ligand. Thus, for example, with Zn(NO₃)₂ and Ni(NO₃)₂, PLTSC give [Zn(PLTSC)(NO₃)₂] \cdot H₂O and [Ni(PLTSC–H)NO₃] \cdot 2H₂O, whereas with M(OAc)₂·H₂O, (M = Zn, Ni), it forms [Zn(PLTSC–H)OAc] \cdot H₂O and

* Free (non-coordinated) isothiosemicarbazones contain the isothiosemicarbazide fragment in the amido form (=N–N=C–(NH₂)–SR), and the coordinated ones in the imido form (=N–NH–C=(NH)–SR) ("prototropic tautomerism").¹⁰

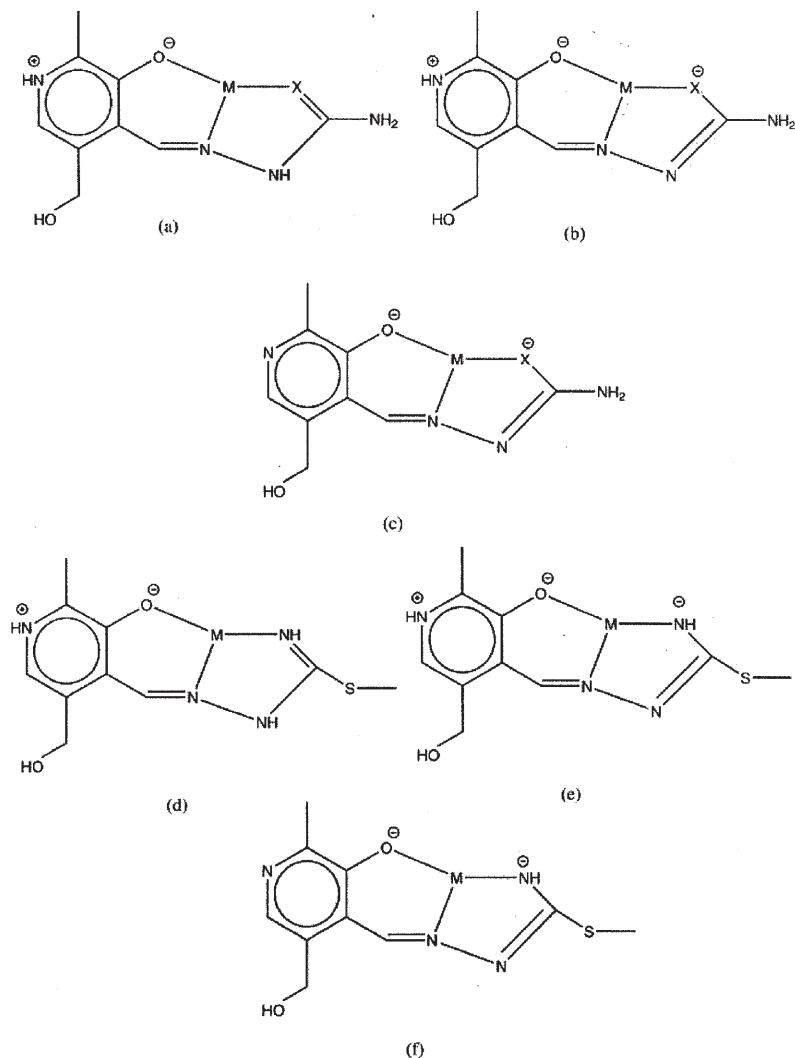

Fig. 3. Coordination modes and ligand forms of PLSC, PLTSC (a, b, c) and PLITSC (d, e, f).

$[\text{Ni}(\text{PLTSC}-2\text{H})]\cdot 2\text{H}_2\text{O}$.²⁵ By comparing the deprotonation of these three ligands, *i.e.*, the deprotonation of the residue of the semicarbazide derivative, it can be concluded that thiosemicarbazide is most readily deprotonated and that deprotonation of isothiosemicarbazide is the most difficult.²⁸

Finally, it should be noticed that in the case of PLTSC, with which, by far, the largest number of complexes have been prepared compared with the other two ligands, there are, in our opinion, two exceptions from the common tridentate ONS coordination. Thus, for example, in the mixed-ligand Au(III) complex of the formula $[\text{Au}(\text{HDAMP})\text{Cl}(\text{PLTSCMe})]\text{Cl}_2$,³¹ where HDAMP = 2-(*N,N*-dimethylamino-methyl)phenyl, and PLTSCMe = pyridoxal *N*4-methylthiosemicarbazone, the

pyridoxal derivative is coordinated as a bidentate N1S entity, which means that the phenolic oxygen is not included in the coordination.³¹ The absence of coordinations of the phenolic oxygen has also been found with the similar tridentate ONS salicylaldehyde thiosemicarbazone (SALTSC), which in complexes of the type $[M(PPh_3)_2(SALTSC-H)_2]$ ($M = Ru(II), Os(II)$), is also coordinated as a bidentate (NS) moiety, the TSC residue in this case is not coordinated *via* the N1 but *via* the hydrazine nitrogen, N₂, thus forming a four-membered ring.³² The same coordination mode (N₂S, instead of the usual N1S) of the coordinating thiosemicarbazone residue, apart from the mentioned complexes, has also been found in the case of complexes with some other thiosemicarbazones, such as Tl(III) and Ru(II) complexes with bidentate thiosemicarbazone, derivatives of benzaldehyde and acetylferrocene.^{33–35}

Another very interesting coordination mode, characteristic not only of PLTSC but also of the other tridentate thiosemicarbazones in general, has been found in the dimeric Tl(III) complex of the formula $[TlMe_2(PLTSC-H)(H_2O)]_2$ (Fig. 4).³⁶ It can be seen that PLTSC anion in its thiol form is bidentately coordinated *via* the enolized sulfur atom and, unexpectedly, *via* the oxygen atom of the undeprotonated phenolic hydroxyl, forming thus a nine-membered metallocycle. Monomeric $[TlMe_2(PLTSC-H)(H_2O)]$ units are more weakly bound in the dimer *via* the sulfur atom. Thus, the coordination behavior of this ligand is interesting also because the PL fragment appears in the form of a zwitter ion and neither of the hydrazine nitrogen atoms participates in the coordination. The absence of hydrazine nitrogen atoms from the coordination (*i.e.*, the occurrence of the monodentate S-coordination only) has also been observed in some other cases.^{1,6} An interesting coordination behavior of PLTSC, *i.e.*, PLTSCet (PLTSCet = pyridoxal N4-ethylthiosemicarbazone), has been observed in the dimeric square-pyramidal complex $[Cu(PLTSCet)Cl]_2Cl_2$, in which this ligand, apart from the usual ONS set of donor atoms, is also coordinated *via* the alcohol oxygen atom as a bridge.³⁷ Furthermore, in the coordination chemistry of thiosemicarbazones in general, there are also some other exceptions to the common coordination mode, one of them being the absence of the sulfur atom from coordination.^{1,13,38–40} Similar exceptions, *i.e.*, the absence from coordination of the oxygen atom of the amide group and of the N4 nitrogen of the isothioamide group, have also been found in the structures of complexes with semi- and isothiosemicarbazones, respectively.^{10,41–43}

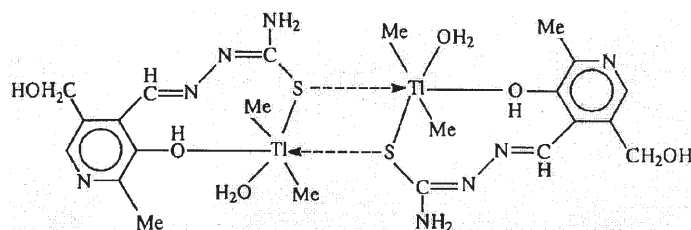

Fig. 4. Structure of $[TlMe_2(PLTSC-H)(H_2O)]_2$.

Finally, it should be stated that, to the best of our knowledge, in the coordination chemistry of Schiff bases – pyridoxal derivatives, the subject of this review, no report has appeared of a case of the pyridine nitrogen being coordinated. However, coordination of this nitrogen atom has been postulated⁴⁴ to occur in a solution of PL itself and Cu(II), and was proved in the crystal of the polymeric square-pyramidal (pyridoxylidene-DL-valinato)copper(II) complex, in which this commonly tridentate Schiff base, in addition to the oxygen atoms of the phenolic OH and carboxylic groups and imino nitrogen atom, is also coordinated *via* the pyridine nitrogen atom and the oxygen from the hydroxymethyl group of a neighboring molecule.⁴⁵ Coordination of the pyridine nitrogen atom has also been found⁴⁶ in the surface of the Cu(II) complex, but with pyridoxine (PN), *i.e.*, 2-methyl-3-hydroxy-4,5-dihydroxymethylpyridine (one of the forms of vitamin B₆) of the formula [Cu(PN)(PN-H)]NO₃. Namely, the neutral PN molecule in the form of a zwitter ion is coordinated to copper in the usual way, *i.e.*, *via* two oxygen atoms (from the OH⁻ and CH₂OH⁻ groups), while the deprotonated PN-H ligand, in addition to these two atoms, is also coordinated *via* the pyridine nitrogen, but to the neighboring copper atom. Monodentate *N*-coordination of PN has also recently been confirmed by X-ray structural analysis of the Pd(II) complex of the formula [Pd(OX)(PN)₂] (OX = oxalate).⁴⁷

4. COMPLEXES: SYNTHESSES, PHYSICO-CHEMICAL CHARACTERISTICS AND GEOMETRIC CONFIGURATION

The largest group of metal complexes with Schiff bases which have been synthesized and characterized up to now, represent complexes with PLTSC. The basic reason for this is the fact that the preparative coordination chemistry of the PLTSC ligand began the first (in 1986) with the paper of Italian authors,²⁵ who have shown a continuous interest in this ligand and its derivatives and complexes. In contrast to this ligand, the preparative coordination chemistry of the other two ligands (PLSC, PLITSC) is of a much more recent date, and for the present it is a research subject of Leovac *et al.*^{26,27}

With respect to the applied methods and synthesis conditions of metal complexes bearing these ligands, it can be said that practically all complexes were obtained by the simple non-template method, *i.e.*, by the reaction of ready-made ligands and metal salts, mainly in warm alcoholic (less often aqueous) solution under an air atmosphere. Some of the complexes were obtained by the template method, for example the pentacoordinated monomeric and dimeric Zn complexes with PLTSC of the formulas [Zn(PLTSC)Cl₂] \cdot 2H₂O and [{Zn(PLTSC-H)Cl}₂] \cdot 2H₂O (Cl-bridge), which were prepared by the reaction of an EtOH (or H₂O) solution of ZnCl₂, PL and TSC (in the mole ratio 1:1:1 and 2:1:1, respectively).⁴⁸

From the point of view of the metals with which complexes with all three ligands have been prepared and investigated, the most numerous are, undoubtedly, copper and iron complexes. In respect of their composition, a common feature of

all these complexes is that they belong to the type of mono(Schiff-base)-ligand complexes, the composition of which can be represented by the following general formulas: $\text{Cu(L)X}_2n\text{H}_2\text{O}$,^{26,49-52} $\text{Cu(PLTSC-H)XnH}_2\text{O}$ ^{25,53,54} and Cu(L-2H)A (PLSC: A = 1NH_3 , $1\text{H}_2\text{O}$ ⁴⁹; PLTSC: A = $2\text{H}_2\text{O}$ ²⁵, PLITSC: A = NH_3 , H_2O , 0.5MeOH ⁵³), which means that, for now, the Cu(II) complexes of PLSC and PLITSC involving the monoanionic form of the ligands have not been prepared. Complexes with the dianionic forms of PLSC and PLITSC were obtained in the presence of $\text{NH}_3(\text{aq})$,²⁸ and those with PLTSC in the presence of acetate.²⁵ With respect to their color, all complexes with PLSC and PLTSC, irrespective of the degree of deprotonation, are green, the same color being also characteristic of the complexes involving the neutral form of PLITSC, in contrast to the complex with the dianionic form of PLITSC, which is dark-brown. The effective magnetic moments of the complexes with PLSC and PLITSC (Cu(II) complexes with PLTSC have not been characterized yet by the magnetochemical method, the exceptions being $\text{Cu(PLTSC-H)X} \cdot 2\text{H}_2\text{O}$ (X = Cl, Br)^{28,54} and $[\text{Cu(PLTSCR-H)Cl}]\text{H}_2\text{O}$ (PLTSCR = pyridoxal N4-methyl/ethyl/phenylthiosemicarbazone), have values that are characteristic of the system $S = 1/2$ at room temperature.⁵⁵ The exceptions are desolvato complexes of the type Cu(L-2H) (L = PLSC, PLITSC) which have lower values of μ_{eff} (1.57 and 1.43 μ_{B} , respectively), which indicates the involvement of antiferromagnetic interactions of the neighboring metal centers, probably being a consequence of the dimeric structure of the molecule.²⁸

A study of the dependence of μ_{eff} of the above $[\text{Cu(PLTSCR-H)Cl}]\text{H}_2\text{O}$ complex, which was prepared from a more acidic (HCl) aqueous solution, on temperature showed the presence of very weak intramolecular antiferromagnetic interactions ($-2J = \text{ca. } 30 \text{ cm}^{-1}$) between the copper(II) centres. The EPR spectra of these complexes at 77 K in DMSO indicate the presence of a mixture of the monomer and dimer, consistent with the dissociation of the complexes.⁵⁵

Apart from those with C.N. 4 (square-planar coordination geometry), pentacoordinated Cu(II) complexes having deformed square-pyramidal configuration have also been prepared. In view of the mono-tridentate type of the complex, this means that, apart from the chelate ligands, the coordination also involves acidic residues, *i.e.*, water molecules. As examples of confirmed square-planar complexes $[\text{Cu(PLTSC-H)H}_2\text{O}] \cdot \text{X} \cdot \text{H}_2\text{O}$ (X = Cl, Br)^{53,54} and $[\text{Cu(PLITSC-2H)NH}_3] \cdot \text{H}_2\text{O} \cdot 0.5\text{MeOH}$ can be mentioned.⁵³ A deformed square-pyramidal structure have, for example, $[\text{Cu(PLSC)Br}_2]$,⁵² $[\text{Cu(PLSC/PLTSC)(H}_2\text{O)}_2]\text{SO}_4 \cdot 2\text{H}_2\text{O}$,^{28,51} $[\text{Cu(PLTSC)(H}_2\text{O)Cl}]\text{Cl}$,⁵⁰ and $[\text{Cu(PLITSC)(H}_2\text{O)NO}_3]\text{NO}_3$ ²⁶ complexes. To the best of our knowledge, there are no Cu(II) hexacoordinated complexes the structure of which has been proved by X-ray structural analysis. (Concerning the structural aspects of these and other complexes, *vide infra*).

Apart from those of copper, mono(ligand) complexes of Zn, Mn, Ni, Mo, Au, Pt, Tc, Tl and Sn of the formulas $[\text{Zn(PLTSC)(NO}_3)_2]$,²⁵ $[\text{Zn(PLTSC-H)X}] \cdot n\text{H}_2\text{O}$ (X=Cl, CH_3COO),^{25,48} $[\text{Mn(PLTSC)(H}_2\text{O)Cl}]\text{Cl}$,⁵⁴ $[\text{Ni(PLTSC-H)(NO}_3)] \cdot 2\text{H}_2\text{O}$,

[Ni(PLTSC-2H)·2H₂O],²⁵ [Ni(PLTSC-H)Py]NO₃, [Ni(PLSC)(H₂O)₃](NO₃)₂,⁵⁶ [MoO₂(PLTSC-2H)MeOH],⁵⁷ [Au(HDAMP)Cl(PLTSCMe)]Cl₂,³¹ [Pt(PLSC-H)Cl₃],²⁷ [TlMe₂(PLTSC-H)(H₂O)],³⁶ [SnR₂(PLTSC-2H)] (R = alkyl)⁵⁸ have also been obtained.

Complexes of Tl, *i.e.*, Sn, have been prepared by prolonged refluxing of ethanolic solutions of PLTSC with TlMe₂OH, *i.e.*, diorganotin(IV)oxide and PLTSC in benzene. On the basis of the given coordination formulas and usual mode of ligand coordination (the exceptions being Tl and Au complexes, SN-coordination), it can be concluded that among the isolated compounds there are not only tetra- and penta-, but also hexacoordinated complexes, *i.e.*, those having an octahedral structure (Mo and Pt complexes). In the case of [Ni(PLSC)(H₂O)₃](NO₃)₂, the structure was confirmed by X-ray structural analysis.⁵⁶ There is a report⁵⁹ describing the reaction of TeO₄⁻ and PLTSC, but it is not possible to unambiguously establish from it the composition of the obtained complex.

Several cobalt complexes with PLTSC and one with PLITSC have been isolated. In these complexes, depending on the reaction conditions, this metal can be stabilized either in its lower (+2) or higher (+3) oxidation state. Thus, the reaction of an EtOH solution of CoX₂·nH₂O (X = NO₃, OAc) and PLTSC (1:1 mole ratio) yields brown Co(II) complexes of the general formula Co(PLTSC-H)X·nH₂O.²⁵ It is interesting to note that the reaction not only with Co(OAc)₂, but also with Co(NO₃)₂, results in a complex with the monoanionic form of the ligand. However, if this reaction is performed in an aqueous solution, the result is an octahedral bis(ligand) cobalt(III) neutral complex, of the formula [Co(PLTSC-H)(PLTSC-2H)]·4.5H₂O, with non-equivalent PLTSC molecules: one molecule being singularly and the other doubly deprotonated.⁶⁰ The same (neutral) type of Co(III) complex, but with the composition [Co(PLTSC-1.5 H)₂]·3.5H₂O, was obtained by recrystallization of the viscous product from a CHCl₃-MeOH mixture, formed in a boiling CHCl₃-MeOH ligand solution and a methanolic solution of Co(OAc)₂.⁶⁰ In contrast to the previous complex, this complex contains equivalent PLTSC molecules. Namely, the pyridine nitrogen atoms in both ligand molecules are "semiprotonated", the conclusion being supported by the existence of a strong symmetric. N...H...N hydrogen bond (2.685 Å) between the pyridine nitrogens of neighboring molecules. Due to the ligand planarity, both complexes have a *mer*-octahedral configuration. Another bis(ligand) octahedral complex of PLTSC and Co(III) has been described, but a monocationic one, [Co(PLTSC-H)₂]Cl·EtOH, which was obtained in the reaction of CoCl₂ and PLTSC (mole ratio 1:1) in EtOH. On the basis of the analysis of CD spectra, it was concluded that spontaneous resolution takes place in solution, yielding a complex of the absolute configuration Λ.⁶¹ Recently, an octahedral bis(ligand) neutral complex of Co(III) and PLITSC, *viz.* [Co(PLITSC-H)(PLITSC-2H)]·MeOH, has been prepared.⁵⁶

Apart from copper, iron is the other element whose complexes with all three ligands (L) have been prepared. These are: monocationic mono- and bis(ligand) Fe(III) complexes $[\text{Fe}(\text{L})\text{Cl}_2(\text{H}_2\text{O})]\text{Cl}$, $[\text{Fe}(\text{L}-\text{H})_2]\text{X}\cdot n\text{H}_2\text{O}$, and in the case of PLITSC, the dicationic bis(PLITSC) complex $[\text{Fe}(\text{PLITSC})(\text{PLITSC}-\text{H})](\text{NO}_3)_2\cdot\text{H}_2\text{O}$, also.^{29,62,63} The complexes were obtained in reactions of warm EtOH solutions of Fe(III) and ligand in the appropriate mole ratio. Furthermore, with PLSC and PLTSC, a neutral bis(ligand) Fe(III) complex $[\text{Fe}(\text{L}-\text{H})(\text{L}-2\text{H})]\cdot 4\text{H}_2\text{O}$ was obtained,⁶³ which is analogous to the Co(III) complexes discussed above. This type of Fe(III) complex was obtained by the reaction of a MeOH solution of $[\text{Fe}(\text{L}-\text{H}_2)]\text{Cl}\cdot n\text{H}_2\text{O}$ with NH_3 (aq). In addition to those with PLTSC and PLSC, the complex $[\text{Fe}(\text{PLTSC}-\text{H})\text{Cl}_2]$ was prepared by the reaction of an EtOH solution of FeCl_2 and PLTSC (whereby Fe(II) was oxidized to Fe(III)⁶⁴) and $[\text{Fe}(\text{PLSC})(\text{SO}_4)(\text{H}_2\text{O})_2]$ (reaction of H_2O solution of FeSO_4 with the ligand).⁶⁵ The last complex is, at present, the only Fe(II) complex with this class of ligands. The dicationic bis(PLITSC) complex, which contains one neutral and one singly-deprotonated ligand, represents a very rare example of such a combination of ligands in bis(tridentate) complexes. With the exception of $[\text{Fe}(\text{PLTSC}-\text{H})\text{Cl}_2]$, which has a square-pyramidal configuration, all the other complexes have octahedral configuration. In the case of $[\text{Fe}(\text{PLSC})(\text{SO}_4)(\text{H}_2\text{O})_2]$, the *trans* (H_2O) isomer was isolated,⁶⁵ and in the case of $[\text{Fe}(\text{L})\text{Cl}_2(\text{H}_2\text{O})]\text{Cl}$ (L = PLSC, PLTSC), the *cis*(Cl) isomer.^{66,67}

The complexes are well soluble in DMF, less soluble in MeOH, EtOH and H_2O , those of the type $[\text{Fe}(\text{L})\text{Cl}_2(\text{H}_2\text{O})]\text{Cl}$ being, generally, the most soluble. Values of λ_{M} of this type of complex in H_2O solution correspond to 1:3 type of electrolytes, which is explained in terms of the total replacement of coordinated Cl ions with H_2O molecules.⁶² Moreover, the λ_{M} value of the PLTSC complexes corresponds to 1:4 type of electrolytes, which is, apparently, a consequence of the deprotonation of the TSC fragment and the formation of the mobile H_3O^+ ion.

With the exception of $[\text{Fe}(\text{PLTSC}-\text{H})_2]\text{Cl}$ and $[\text{Fe}(\text{PLITSC})\text{Cl}_2(\text{H}_2\text{O})]\text{Cl}$, which are spin-only, that is $[\text{Fe}(\text{PLTSC}-\text{H})_2]\text{Cl}\cdot 2\text{H}_2\text{O}$ and $[\text{Fe}(\text{PLTSC}-\text{H})(\text{PLTSC}-2\text{H})]\cdot 4\text{H}_2\text{O}$, which are low-spin, all the other complexes have somewhat lowered μ_{eff} values compared with purely high-spin Fe(III) complexes.^{29,62,63} This can be explained by the existence of "admixture" of the low-spin Fe(III). It is interesting to notice that the PLTSC complexes belong to groups differing in respect of their spin, which is in agreement with the literature data that the spin state of bis(tridentate) TSCs complexes of Fe(III) can depend on both the nature of the outer-sphere ion and the crystalhydrate composition of the complex.⁶⁸ Measurements of the temperature dependence of μ_{eff} values for $[\text{Fe}(\text{PLTSC}-\text{H})_2]\text{Cl}$ showed that this complex is high-spin ($\mu_{\text{eff}} = 5.75 \mu_{\text{B}}$ at 299 K, and that μ_{eff} decreases with decreasing temperature ($\mu_{\text{eff}} = 4.00$ (245 K), 2.26 (345 K), and 2.01 μ_{B} (78 K)).²⁹ On the basis of the magnetism, the transition temperature of this spin-crossover complex, asso-

ciated with the 6A_1 (high-spin) \leftrightarrow 2T_2 (low-spin) transition, is well defined as T_c (\downarrow) = 245 K. For the reverse transition occurring upon sample heating, T_c (\uparrow) = 256 K (the thermal hysteresis being 11 K). Variable temperature ${}^{57}\text{Fe}$ Mössbauer data also provide evidence for the presence of a spin transition in this complex. An analogous phenomenon, but appearing as a consequence of the nature of the substituted bonded to the N4 atom, was also found for $[\text{Fe}(\text{PLTSCPh-H})_2]\text{Cl}$ (PLTSCPh = pyridoxal N4-phenylthiosemicarbazone) ($\mu_{\text{eff}} = 5.90$, (320 K), 2.14 (78 K) in contrast to the same type of Fe(III) complex with N4-methyl/ethyl derivatives, which are low-spin (μ_{eff} ca. 2.12 μ_B),⁶⁹ in the same temperature interval.

5. STRUCTURAL CHARACTERISTICS

A survey of selected geometric and conformational parameters of all the ligands and their complexes which have been characterized by X-ray structural analysis are given in Tables I and II. The atom designations used in the text and Tables are given in Fig. 5.

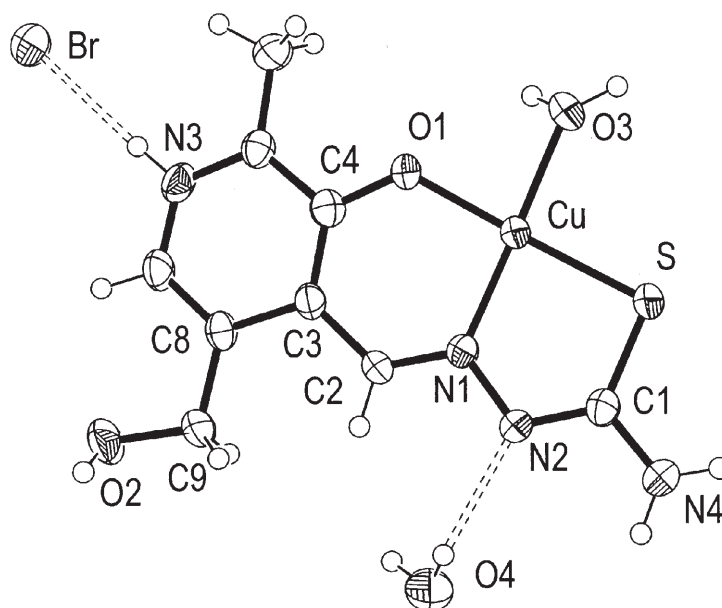

Fig. 5. ORTEP drawing of complex **16** as an example for the usual coordination mode of PLTSC as well as an example of the atom numbering scheme used in Table I and in the discussion. The thermal ellipsoids correspond to 50 % probability.

In the Tables, the crystal structures are divided into four groups. The first group contains the structures of the non-coordinated ligands (5 structures), the second consists of metal complexes of PLTSC (18 structures), while the third and fourth groups comprise metal complexes with PLITSC and PLSC as ligands (4 structures of each), which altogether makes 31 crystal structures. Since some of the

structures from Table I contain two molecules of the PL ligand derivative (bis(ligand) complexes **10**, **11**, **12**, **22**, **23**, **26** and **27**), and since the structure **25** includes two asymmetric molecules in one asymmetric unit, the number of PL derivatives for which unique X-ray experimental data exist increases to 39. The TSC fragment in the PLTSC ligand and its substituted derivatives is coordinated in the usual way, *i.e.*, *via* the N1 and S atoms, while the PL moiety is coordinated *via* the oxygen atom O1 of the deprotonated phenolic OH group (Fig. 5). The exceptions are Au and T1 complexes (**8** and **9**), whereby **8** involves coordination of N1 and S atoms (O1 is protonated and uncoordinated), while the coordination around T1 in **9**, apart from the O1 atom of the non-ionized phenolic group, is made of two S atoms from two different ligands. Namely, in **9** the S atom plays the role of a bridge between two adjacent T1 atoms, with T1–S distances of 2.83 and 3.19 Å (Fig. 4). In the solved structures of the complexes with PLITSC and PLSC, both ligands are always coordinated in the usual way, *i.e.*, *via* O1, N1, N4 (PLITSC) (Fig. 6), and O1, N1, O3 (PLSC) (Fig. 7) set of donor atoms.

TABLE I. Selected bond distances (Å) for all crystal structures of the PLTSC, PLITSC and PLSC compounds

Compound*	O1– C	N1– N2	N2– C1	C1– N4	C1– X	M– O1	M– N1	M– X	Ref.
PLTSC·3H ₂ O (1)	1.29	1.40	1.35	1.33	1.70	–	–	–	25
PLTSCMe·HCl (2)	1.34	1.36	1.38	1.34	1.67	–	–	–	31
PLTSCMeMe·H ₂ O (3)	1.29	1.37	1.39	1.32	1.68	–	–	–	30
PLTSCMe ₂ ·H ₂ O (4)	1.35	1.36	1.37	1.33	1.69	–	–	–	30
PLSC·HCl·H ₂ O (5)	1.34	1.36	1.38	1.32	1.23	–	–	–	28
[Mn(PLTSC)(H ₂ O)Cl]Cl (6)	1.27	1.36	1.33	1.30	1.71	2.00	2.27	2.48	54
[Zn(PLTSC–H)Cl ₂] ₂ ·2H ₂ O (7)	1.32	1.36	1.34	1.33	1.75	1.96	2.11	2.29	48
[Au(HDAMP)Cl(PLTSCMe)]Cl ₂ (8)	1.33	1.37	1.33	1.34	1.76	–	2.13	2.26	31
[TlMe ₂ (PLTSC–H)(H ₂ O)] ₂ (9)	1.35	1.34	1.34	1.33	1.74	3.12	–	2.83	36
[Co(PLTSC–H) (PLTSC–2H)·4.5H ₂ O (10)	1.31	1.37	1.33	1.34	1.72	1.95	1.89	2.21	60
[Co(PLTSC–1.5H) ₂] ₂ ·3.5H ₂ O (11)	1.29	1.40	1.30	1.37	1.74	1.96	1.89	2.23	
	1.30	1.38	1.32	1.35	1.71	1.96	1.90	2.21	60
	1.31	1.39	1.30	1.38	1.74	1.95	1.90	2.20	
[Co(PLTSC–H) ₂]Cl·EtOH (12)	1.26	1.40	1.33	1.38	1.69	1.94	1.88	2.20	61
	1.27	1.41	1.34	1.39	1.69	1.93	1.89	2.21	
[Cu(PLTSC)(H ₂ O) ₂]SO ₄ ·H ₂ O (13)	1.29	1.38	1.36	1.31	1.70	1.89	1.98	2.25	51
[Cu(PLTSC)Cl(H ₂ O)]Cl (14)	1.29	1.38	1.34	1.31	1.71	1.91	1.97	2.29	50

TABLE I. Continued

Compound*	O1– C	N1– N2	N2– C1	C1– N4	C1– X	M– O1	M– N1	M– X	Ref.
[Cu(PLTSC–H)(H ₂ O)] ₂ Cl ₂ ·2H ₂ O (15)	1.30	1.37	1.32	1.33	1.72	1.88	1.94	2.23	54
[Cu(PLTSC–H)(H ₂ O)] ₂ Br ₂ ·2H ₂ O (16)	1.31	1.37	1.32	1.34	1.73	1.94	1.87	2.24	53
[Cu(PLTSCMe ₂ –H)Cl] ₂ ·6H ₂ O (17)	1.29	1.38	1.34	1.35	1.72	1.91	1.97	2.22	37
[Cu(PLTSCMeMe)Cl] ₂ Cl ₂ ·4H ₂ O (18)	1.29	1.38	1.36	1.31	1.70	1.90	1.99	2.22	37
[Cu(PLTSCeEt)Cl] ₂ Cl ₂ ·2H ₂ O (19)	1.30	1.39	1.34	1.33	1.70	1.90	1.99	2.25	37
[Fe(PLTSC–H)Cl ₂] (20)	1.32	1.38	1.33	1.34	1.73	1.89	2.20	2.34	48
[Fe(PLTSC)(H ₂ O)Cl ₂]Cl (21)	1.30	1.37	1.34	1.31	1.70	1.92	2.22	2.43	67
[Fe(PLTSC–H) (PLTSC–2H)]·4H ₂ O (22)	1.30	1.39	1.32	1.34	1.72	1.94	1.92	2.25	28
[Fe(PLTSC–H) ₂]·0.5SO ₄ (23)	1.32	1.41	1.31	1.36	1.74	1.93	1.91	2.27	70
	1.30	1.39	1.32	1.34	1.75	1.91	1.92	2.23	28
	1.30	1.41	1.35	1.32	1.73	1.96	1.92	2.20	
[Cu(PLITSCH)(H ₂ O)NO ₃]NO ₃ (24)	1.29	1.37	1.36	1.28	1.75	1.88	1.97	1.93	26
[Cu(PLITSC–2H)NH ₃] ·H ₂ O·0.5MeOH (25)	1.31	1.41	1.33	1.33	1.76	1.89	1.95	1.93	28
	1.32	1.38	1.34	1.30	1.76	1.88	1.94	1.94	53
[Co(PLITSC–H)(PLITSC–2H)] ·MeOH (26)	1.32	1.39	1.33	1.31	1.75	1.94	1.88	1.89	56
	1.29	1.38	1.32	1.32	1.75	1.91	1.89	1.89	
[Fe(PLITSC)(PLITSC–H)](NO ₃) ₂ (27)	1.30	1.34	1.36	1.32	1.74	1.93	2.18	2.03	56
[Cu(PLSC)Br ₂] (28)	1.29	1.37	1.36	1.32	1.25	1.90	1.99	1.98	52
[Cu(PLSC)(H ₂ O)]SO ₄ ·2H ₂ O (29)	1.29	1.37	1.36	1.31	1.27	1.88	1.95	1.95	56
[Fe(PLSC)(H ₂ O) ₂ (SO ₄)] (30)	1.30	1.37	1.37	1.33	1.24	2.02	2.12	2.13	65
[Fe(PLSC)(H ₂ O)Cl ₂]Cl (31)	1.31	1.36	1.37	1.33	1.26	1.92	2.20	2.06	66

*PLTSCMe = PL N4-methylTSC, PLTSCMeMe = PL N2,N3-dimethylTSC, PLTSCMe₂ = PL N4,N4-dimethylTSC, PLTSCeEt = PL N4-ethylTSC

As can be seen from Table I, the C–O1 distance in both the free and coordinated ligands is between the value of a double (1.23 Å) and single (1.43 Å) C–O bond, which indicates significant delocalization of the π electrons of the pyridine ring towards the oxygen O1. It can be seen that this bond in complexes **8** and **9** is somewhat longer (1.33 and 1.35 Å, respectively) than in the other complexes (C–O1_(average) = 1.30 Å). The reason for this lies in the fact that, in contrast to the other complexes in which the ligands are coordinated *via* the deprotonated phenolic OH group, the ligand in **8** is coordinated without participation of the oxygen of the non-ionized O1H group, and in **9** the oxygen atom of the (also non-ionized) OH group enters a very weak interaction with

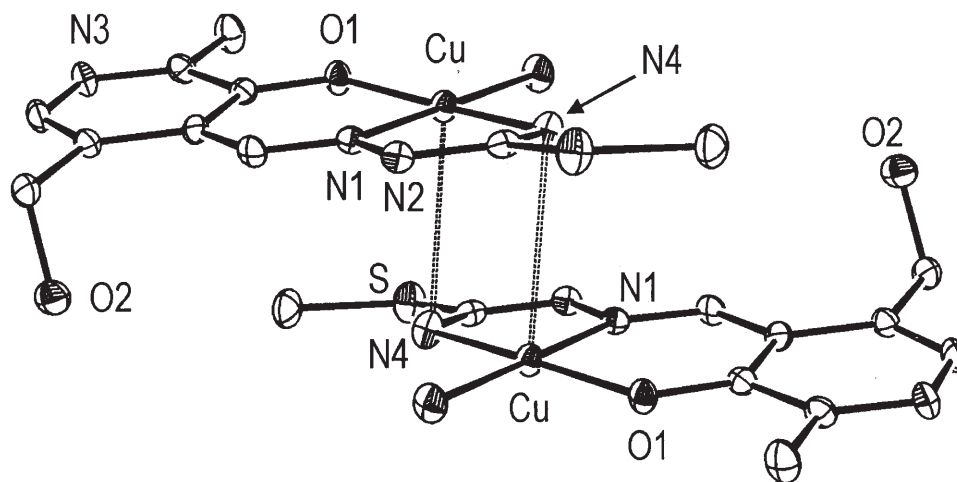

Fig. 6. View of the crystal-lattice of complex **25** illustrating by dashed lines the dimeric interactions of the Cu atom. Displacement ellipsoids are shown at the 20 % probability level while the H atoms are omitted for clarity.

T1 (T1–O = 3.12 Å). Hence, it is not surprising that the C–O1 distance in both complexes is close to the C–O1 bond in the free ligands **2**, **4** and **5**, which contain a non-ionized OH group. Thus, this bond in the free ligands **1** and **3** containing an ionized O1H group is practically identical to the bond in the complexes in which this group is also ionized. Moreover, non-coordinated PLSC and PLTSC ligands differ also in the conformation of their semi- and thiosemicarbazide residues. While ligands **1**, **3** and **5** show an *E* conformation around both the C2–N1 and C1–N2 bonds (the phenolic oxygen and the S or O3 atoms are *trans* to N1), the ligands **2** and **4** show a *Z* conformation around the C1–N2 bond. It is interesting to notice that the ligands **1** and **5** have a very similar configuration, although **1** appears as a neutral entity and **5** as a hydrochloride. The differences in the conformations of the non-coordinated ligands are the consequence of the different intra- and intermolecular hydrogen bonds, crystal packing, presence/absence of H atom at the O1 and N3, as well as of the effect of the presence/absence of methyl groups in the TSC fragment.

By analyzing the lengths of the N1–N2, N2–Cl and Cl–N4 bonds (Table I) it can be concluded that delocalization of electronic density exists in the N1–N2–Cl–N4 fragment. It is known that in the case of the PLTSC ligand, the sulfur atom also participates in this delocalization, but to a smaller extent when the S atom is coordinated (Table I). Delocalization of the π electrons in the N1–N2–Cl–N4 fragment occurs in all cases, irrespective of whether the N2 atom is protonated or whether the PL ligands are coordinated or not. Since the length of the C2–N1 bond is about 1.30 Å, it is quite clear that the C2 atom also participates in the π delocalization from the N1–N2–Cl–N4 fragment, making, thus, a bond between the π system in the pyridine ring and this fragment.

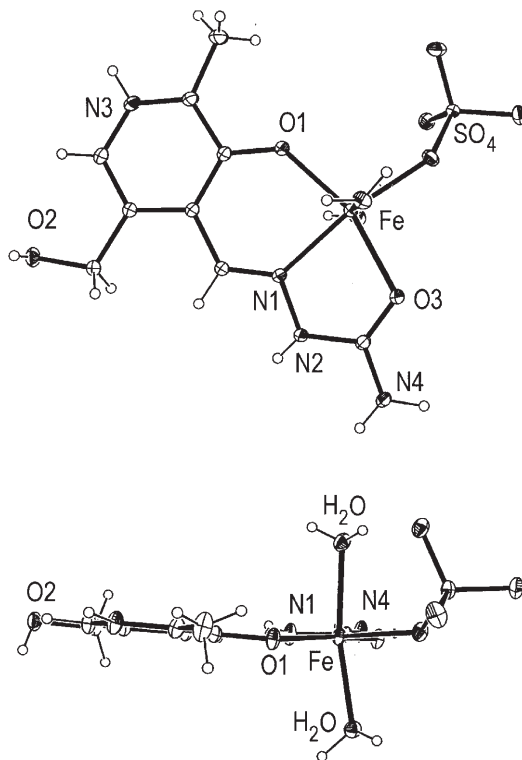

Fig. 7. Crystal structure of complex **30** in two orthogonal projections.

Bearing in mind the mentioned large delocalized π system, it is not surprising that all non-hydrogen atoms in these ligands are in many cases approximately co-planar. This only does not hold for the O2 atom from the $-\text{CH}_2\text{OH}$ group, which can change its position by rotating around the single C8–C9 bond. The position of the O2H hydroxyl group can be best described by the O2–C9–C8–C3 torsion angle (denoted as T1, Table II). The values of this torsion angle show that this group is approximately in the same plane with the pyridine ring in 10 examples. In a large number of examples (17), this torsion angle has a value in the relatively narrow interval of 60 to 70° (Table II). It can be supposed that, thanks to the free rotation around the C8–C9 bond, the O2H group assumes the position in which the most favorable hydrogen bond is realized.

On coordination, all three ligands form two fused chelate rings, one of which, MN1C2C3C4O1, is a six-membered and the other, MN1N2C1X (X = O, S, N), a five-membered ring. The five-membered chelate rings (FCR) are approximately planar or mildly deformed, whereas with the six-membered chelate rings (SCR), significant conformational differences can be observed. Namely, in some cases (**24**, **25**, **26** and **27**), the SCR has an approximately planar or close to planar conformation (**13**, **15**, **16**, **17**, **19**, **26**, **28**, **29**, **30**), whereas in some complexes (**7**, **10**, **11**,

12, 21, 22, 23, 31), it deviates significantly from a planar conformation. It is very difficult to establish a regularity in the occurrence of SCR planarity, but it should be noticed that the most planar SCR forms are observed in the complexes with PLITSC ligand. Also, it is possible to observe that deformation from the planar form occurs primarily because of rotation around the O1–M bond and partly because of rotation around the C3–C2 bond (exhibiting a very weak character of π bond), which is indicated by the values of the T3 and T5 torsion angles (Table II). On the other hand, the O1–C4–C3–C2 fragment is planar in all structures, which can be seen from the value of the torsion angle T2 (Table II); the latter rarely exceeds 6° , even with very deformed SCR. The SCR conformation has a very important effect on the overall molecule conformation because it brings the pyridine part of the ligand to a position which deviates significantly from the coordination plane formed by the chelate PL ligand, which is seen in Fig. 8 as the deviation of the PLTSC ligand from the broken line representing the ideal equatorial plane. The molecular structure of **30**, which represents an example of the complexes in which the SCR is almost planar, with small values of the T3 and T5 torsion angles is shown in Fig. 7. In the SCR, the N1–N2–Cl–X fragment is almost planar, which is evident from the value of the torsion angle T4. A significant consequence of the ONX coordination of PL ligand and the formation of two fused chelate rings is the deformation of the O1–M–N1, N1–M–S and N1–M–N4 coordination angles, which deviate significantly from 90° . The most pronounced deformation of the coordination angles is observed with the structures **6, 21, 27, 30** and **21**, in which the M–N1 bond is also significantly longer than the M–O1 bond, which is not the case with the majority of the other crystalline structures.

TABLE II. Selected bond angles ($^\circ$) and torsion angles ($^\circ$) for all crystal structures of the PLTSC, PLITSC and PLSC compounds (T1 = O2–C9–C8–C3, T2 = O1–C4–C3–C2, T3 = N1–C2–C3–C4, T4 = N1–N2–Cl–X, T5 = C4–O1–M–N1)

Comp.	O1–M–N1	N1–M–X	T1	T2	T3	T4	T5	Ref.
1	–	–	174.4	–1.2	–176.8	–178.0	–	25
2	–	–	–78.0	–2.4	4.8	–6.3	–	31
3	–	–	83.6	–1.2	153.5	–173.1	–	30
4	–	–	–105.8	–0.0	0.5	4.6	–	30
5	–	–	175.6	0.5	1.7	1.6	–	28
6	80.7	78.4	–49.3	5.9	–11.1	3.0	–25.3	54
7	86.8	83.3	173.6	0.0	16.0	–0.9	43.9	48
8	–	84.1	–167.9	5.0	–40.2	–1.3	–	31
9	–	–	71.5	–1.0	–3.3	–3.6	–	36

TABLE II. Continued.

Comp.	O1-M-N1	N1-M-X	T1	T2	T3	T4	T5	Ref.
10	94.3	85.3	67.0	1.4	14.8	-5.0	30.9	60
	93.2	85.9	64.6	1.4	16.3	-2.7	34.6	
11	93.8	85.1	-64.2	2.2	-16.3	2.1	-29.7	60
	93.0	85.2	-64.0	-2.4	-21.7	6.0	-38.6	
12	93.4	88.0	-63.6	3.6	8.4	2.8	20.0	61
	93.9	86.7	61.4	2.8	11.1	1.5	26.4	
13	90.8	87.4	-66.4	1.2	2.0	1.8	10.0	51
14	91.0	86.4	47.6	-2.8	7.2	-1.0	11.6	50
15	94.5	86.3	174.8	-0.9	-6.5	1.8	10.6	54
16	94.3	86.7	174.9	-0.2	-4.0	-0.5	-11.0	53
17	92.9	85.8	60.0	1.5	0.7	-1.5	1.9	37
18	92.5	85.8	-63.1	-1.9	-8.2	1.1	-18.4	37
19	91.4	86.7	62.1	2.3	3.8	1.8	11.3	37
20	-	-	-	-	-	-	-	48
21	82.8	79.8	61.4	-7.4	-5.5	1.2	-22.8	67
22	93.2	85.2	-67.1	-1.0	-15.8	5.7	-30.9	28
	93.3	84.3	-64.6	2.1	-15.5	2.9	-32.4	70
23	94.1	86.1	175.3	3.4	8.7	-0.8	22.1	28
	93.0	87.0	-162.3	-2.6	9.3	8.5	10.4	
24	91.5	81.4	-66.1	1.7	1.6	-179.3	3.8	26
25	92.5	81.0	-70.6	-8.5	3.7	4.9	2.6	28
	93.0	80.2	66.8	-5.1	2.8	7.3	7.5	53
26	95.2	81.2	62.7	0.4	-7.8	-0.8	-11.1	56
	95.1	82.1	177.4	5.1	-3.8	1.7	-1.6	
27	82.3	74.1	-178.3	-6.6	2.3	0.0	-1.7	56
28	89.8	80.2	-80.8	-0.7	-2.9	1.8	-11.5	52
29	92.2	82.2	76.1	-0.3	-3.8	3.0	-12.6	56
30	84.2	75.9	178.7	-2.5	-0.6	3.1	7.4	65
31	81.8	75.0	60.1	-6.8	-5.1	2.5	-21.5	66

For the complex **20** the necessary data were unavailable

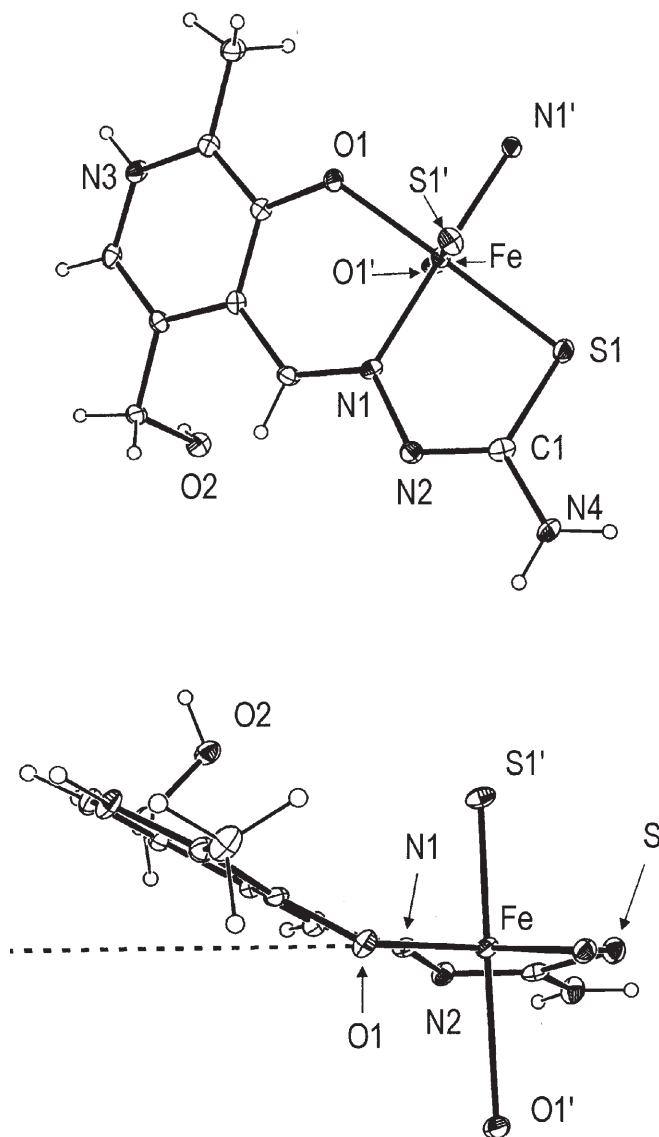

Fig. 8. Fragment of the molecular geometry of complex **22** in two orthogonal projections representing the displacement of the PLTSC ligand from the equatorial coordination plane (dashed line).

In respect to the formation of hydrogen bonds and the occurrence of intermolecular interactions, the complexes exhibit different behavior depending on the number of groups that can act as acceptors or donors of hydrogen atoms and their mutual ratio, *i.e.*, the number of potential donors and potential acceptors of H atoms. Some of the complexes, such as, for example, **13**, form 3D supramolecular structures. With this complex, the pyridine ring participates in the formation of

intermolecular C–H... π interactions, which can also be observed in the complexes **6**, **10**, **14**, **21**, **28**, **30**, and **31**. The N2, N4, N3 and O2 atoms, are of special importance in the formation of intermolecular hydrogen bonds. As already mentioned, the position of the –CH₂–O2H fragment with respect to the rest of the ligand is determined exactly by the hydrogen bonds formed with the O2 atom.

Some of the copper complexes exhibit interesting structural behavior. Namely, the molecules of these complexes form centrosymmetric dimers, but in different ways, *i.e.*, the bonds between the two molecules may be of different strength and involve different atoms. Thus, in the case of complex **18**, the coordinated Cl atom plays the role of a bridging ligand, forming an elongated Cu–Cl bond of 2.853 (1) Å with an adjacent molecule. In the case of complex **19**, a centrosymmetric dimer is formed thanks to the formation of a bond between the O2 and Cu from the neighboring molecule, the length of which is 2.350(5) Å. In this way, with both of these two complexes, a (4+1) coordination is formed around Cu and the bond between the molecules in the dimer is strong, which can be concluded on the basis of the mentioned Cu...Cl and Cu...O2 distances. The formation of dimers in the case of copper complexes **15**, **16** and **25** occurs in a different way, namely dimers are formed by participation of the coordinated atoms from the PL derivatives which enter into interaction with the Cu atom from a neighboring molecule. Thus, with **15** and **16**, the coordinated sulfur atom also interacts with a neighboring Cu atom, occupying approximately the apical position, with a Cu...S distance of 3.066(2) Å and 3.042(2) Å, respectively. With complex **25** (Fig. 6), as with **15** and **16**, the N4 atom from the PL derivative, which participates in coordination, is also involved in an interaction with the Cu atom from the other half of the dimer, occupying also the apical position, with Cu...N distances of 3.085(6) and 3.030(6) Å, respectively, in the crystallographically independent units. Although the distances Cu...S and Cu...N4 in **15**, **16** and **25** are significantly longer than the Cu...Cl and Cu...O2 distances in **18** and **19**, it is still possible to speak of a strong interaction in these dimers too. Also, such dimeric interactions, with Cu...X (X = F, C, N, O, S, Cl) distances which are longer than 2.8 Å, are also found in the case of Cu complexes with other ligands (more than 500 examples), for which it is possible to postulate a formal existence of the square-pyramidal (4+1) configuration.⁵³

6. SPECTRAL CHARACTERISTICS

6.1. IR Spectra

Practically all the ligands and complexes of PLTSC and its derivatives have been characterized in detail, whereas those of PLITSC and PLSC only in part, by recording their IR spectra. A common feature of all these spectra is that in the high-energy, range, *i.e.*, between 3500 and 3100 cm⁻¹ they possess several bands which are ascribed to the ν (OH) vibration of hydroxymethyl group and H₂O, along with ν (NH₂) vibrations. The ν (NH) band, which in the spectra of free PLSC and PLTSC is observed at about 3150

cm^{-1} ^{25,28,55} is missing from the spectra of singly-deprotonated ligands. This also holds for the $\nu(\text{NH}^+)$ band from the pyridine ring, which in the spectra of the free ligands and complexes involving monoanionic ligands is observed at about 2850 cm^{-1} , while it is also absent from the spectra of complexes with the dianionic form of the ligand. The very strong $\nu(\text{C}=\text{O})$ band in PLSC ligand at 1680 cm^{-1} ,²⁷ *i.e.*, around the value characteristic for the majority of semicarbazones,^{71,72} is in the complexes shifted to lower energies by $15\text{--}20 \text{ cm}^{-1}$ (neutral form), or is lost (anionic form). A number of bands in the range $1640\text{--}1400 \text{ cm}^{-1}$ in the spectra of both ligands and complexes are ascribed to pyridoxal ring vibrations, as well as to the $\nu(\text{C}=\text{N})$ and $\delta(\text{NH}_2)$ of the chain.^{25,28,55} M. Belicchi Ferrari *et al.*⁵⁰ observed that in the complexes involving neutral and singly-deprotonated form of the PLTSC ligand, such as $[\text{Cu}(\text{PLTSC})\text{Cl}(\text{H}_2\text{O})]\text{Cl}$ and $[\text{Cu}(\text{PLTSC-H})\text{H}_2\text{O}]\text{Cl}$, spectral changes occur in the $1500\text{--}1400 \text{ cm}^{-1}$ region upon deprotonation of the TSC fragment. Namely, the spectra of PLTSC complexes in this region are characterized by four medium-intensity bands which can be mainly ascribed to the pyridoxal ring, in contrast to the spectrum of the complex with PLTSC-H, which in this range has three bands. The authors think that this reduction in the number of bands in the given region is a consequence of the electronic delocalization occurring after deprotonation. A similar trend has also been observed in the case of Co(III) complex with this ligand.⁶⁰ The medium-intensity $\nu(\text{C}=\text{S})$ band in the ligand PLTSC and its substituted derivatives, observed in the range of *ca.* $990\text{--}840 \text{ cm}^{-1}$ is shifted due to complexation by *ca.* $20\text{--}100 \text{ cm}^{-1}$.^{25,37,69} Nevertheless, the $\nu(\text{SH})$ band (at *ca.* 2.500 cm^{-1}) is missing from the spectra of these ligands, so that it can be concluded that, as with the other TSCs, the thioketo form is also predominant in the crystal of this thiosemicarbazone.

6.2. Electronic spectra

The spectra of numerous transition metal complexes containing different types of thiosemi- or semicarbazone-based ligands have been described in the literature.¹ The obtained spectra display all kinds of electronic transitions characteristic of ligands and metal ions in coordination. This has been clearly illustrated in several papers on Fe(III) complexes with salicylaldehyde thiosemi-, isothiosemi- and semicarbazones. These spectra are sensitive to the type of ligand species involved in coordination (*i.e.*, L, L-H, L-2H)^{73,74} and also to the influence of ions present in the DMF solutions (Cl^- , H^+ , *etc.*). Therefore, the appearance of a spectrum has proved to be a useful support in the identification of particular complex species. In addition, a method for the spectrophotometric monitoring of the course of protonation of Fe(III) complexes alone^{75,76} and in binary mixtures⁷⁷ was successfully developed.

Contrary to this, the electronic spectral data for the title compounds has been reported in only a few papers.

Studies of the acid-base equilibria of different ligand species²⁵ in aqueous solutions of different pH and of several N-substituted PLTSC derivatives³⁰ have re-

cently been reported. The experimental absorbance values were compared to the calculated ones and the pH range in which a particular species is stable was determined. The protonation constants of the unsubstituted ligand show three distinct proton transfers to the alcoholic (PLTSC-H) ($\log K_1 = 11.11$) and phenolic groups (PLTSC) ($\log K_2 = 7.94$) and pyridine nitrogen atom (PLTSC-H⁺) ($\log K_3 = 4.29$).²⁵ In a subsequent study of substituted PLTSC, the same authors³⁰ established the possibility of protonation in total four centers, one more than previously – *i.e.*, the hydrazine nitrogen as the third in order. The values of the corresponding $\log K$ are similar to those cited above.

For the N4-substituted PLTSC copper(II) complexes of the formula [Cu(PLTSCR-H)Cl]·H₂O, the reflectance spectra of powdered samples and the adsorption spectra in MeOH and DMSO solutions were recorded.⁵⁵ Both techniques showed two main absorption bands of these complexes: the first (at about 630–640 nm) being ascribed to d-d transitions, while the other, which is dependent on the solution composition, appears at 385–415 nm. This band is the result of charge transfer S → Cu transition and its dependence on the solvent is taken as proof that the complex undergoes solvolysis, thus yielding species of the type [Cu(PLTSCR-H)(solv)Cl].

The electronic spectra of the three series of mono- and bis(ligand) Fe(III) complexes containing either, L, L-H or L-2H forms of PLSC, PLTSC and PLITSC were recorded in DMF solutions.^{62,63} Their features were compared with those of the corresponding ligands obtained in the same solvent. Apart from the absorption bands at $\lambda < 300$ nm, which are mainly a consequence of intraligand transitions and can be observed almost unchanged in the spectra of PLTSC or PLTSC-H-containing complexes, the other bands appearing in the region of 300–450 nm are rather different in the complexes from those of the pure ligands. In fact, the bands are composed of contributions of several close (intraligand and charge-transfer) processes which seem to be overlapped. The most complex spectra were recorded for non-electrolyte compounds (*i.e.*, [Fe(L-H)(L-2H)]) because of the absorption of the L-2H species. Common characteristics of all spectra (the only exception being the low-spin Fe(III) complex) is the absence of bands which could be ascribed to d-d transitions. In addition, in order to support findings of cyclic voltametric experiments, the authors also recorded spectra in DMF containing LiCl and/or H⁺. The results were useful for explaining the stability of particular complex species in solutions.

6.3. Other techniques

Apart from these spectral techniques (IR and UV-vis), some diamagnetic complexes of Sn(IV),⁵⁸ Tl(III),³⁶ Au(III),³¹ and Pt(IV),²⁷ as well as the corresponding ligands, have also been characterized by NMR spectroscopy. In addition, Sn complexes,⁵⁸ along with some Fe complexes have also been characterized by Mössbauer spectroscopy too.^{29,69} Finally, EPR characterizations of some Fe and Cu complexes have also been reported.^{55,69}

7. ELECTROCHEMISTRY

In order to characterize the redox processes which may occur on the ligands and complexes, as well as to examine the stability of complex species in solution, electrochemical investigations in suitable solvents are usually performed. Although the TSC-based ligands and their complexes were the subject of many polarographic and voltammetric studies,^{78,79} the title Schiff bases and their complexes have only been described in a few articles. Furthermore, although there are several reports on the electrochemical (in particular, polarographic) behavior of PL alone,^{80,81} no data were found on its condensation products with semi- or thio-semicarbazide. On the basis of the analogy of the structures of the studied new Schiff-base ligands and those described previously with salicylaldehyde condensation products,^{82,83} it could be supposed that the new ligands and, consequently, their complexes can be more easily reduced, which was confirmed in some cases.

Detailed voltammetric studies have been concerned with the electrochemical behavior of a number of Fe(III) complexes of different types (mono- and bis(ligand), using L, L-H or L-2H species) with all three ligands.^{62,63} These complexes were investigated in DMF, in the presence of several supporting electrolytes, at a glassy carbon working electrode.

The complexity of the behavior of these complexes is clearly seen from Fig. 9 giving the cyclic voltammograms of a non-electrolyte complex, which is more stable than the other types of complexes, recorded in an inert medium. This complex in DMF behaves as a coordination dimer of the type $[\text{Fe}(\text{L}-\text{H})_2][\text{Fe}(\text{L}-2\text{H})_2]$. The complex species undergo several reduction and oxidation processes. First two electronation processes (down to -1.0 V) are centered on Fe(III), while the other three are located on

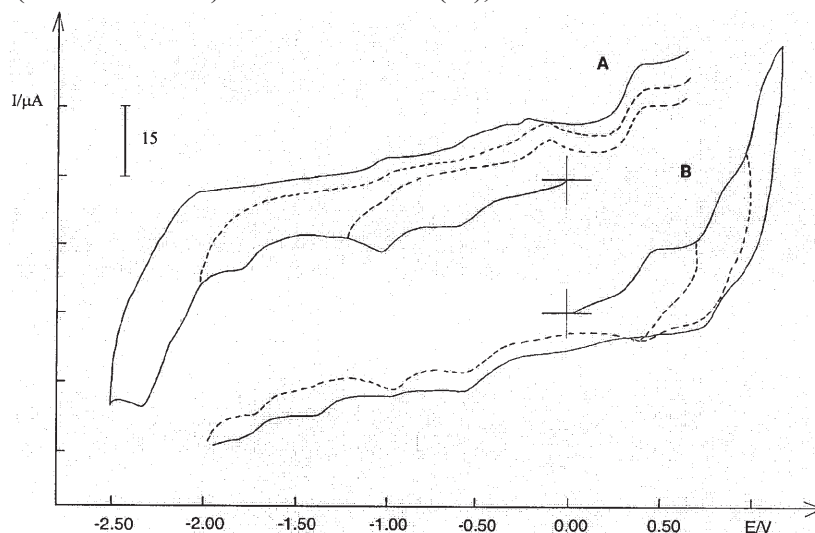

Fig. 9. Cyclic voltammograms for $[\text{Fe}(\text{PLSC}-\text{H})(\text{PLSC}-2\text{H})]$ in 0.1 mol dm^{-3} TBAP/DMF obtained at a GC electrode (0.20 V s^{-1}): reduction processes (A) and oxidation processes (B).

the ligand moieties (about -2 V). Most of the processes are followed by chemical reactions, usually irreversible; the reactions being faster if the medium contained "attractive" species such as Cl^- for the Fe(III)/Fe(II) pair, or H^+ and Li^+ for the ligands. The oxidations are similar to those described below:⁵⁵ in perchlorate medium, the processes taking place in the range of ligand oxidation ($> +0.5$ V) are followed by fast irreversible chemical reactions of complex decomposition. In all solutions, the established readiness to undergo corresponding reduction/oxidation process for the same type of complexes can be attributed to the coordinated donor set of atoms: ONS>ONO~ONN, which is in accordance with previous reports on similar complexes with thiosemi-, isothiosemi- and semicarbazone-based ligands condensed with salicylaldehyde (instead of PL).^{82,83}

The Cu(II) complex with pyridoxal N4-substituted thiosemicarbazone $[\text{Cu}(\text{PLTSCeT-H})\text{Cl}]\cdot\text{H}_2\text{O}$, was investigated in MeOH at a platinum electrode.⁵⁵ It exhibits three one-electron processes: one for reduction (-0.28 V) and two for oxidation ($+0.52$ V and $+0.98$ V). The reduction and first oxidation processes are reversible, the latter being followed by a slow chemical reaction of complex decomposition. The reduction/oxidation tendency proves that the presence of substituents on the ligand has no effect on the electric charge of the donor atoms (ONS). Consequently, this facility is mainly due to the presence of the sulfur atom, as is to be expected on the basis of many data reported previously for similar ligands.

8. BIOLOGICAL ACTIVITY

One of the main reasons why the literature concerning thiosemicarbazones is richer and more diverse than that of the semicarbazones is the higher biological activity of the former. Since the pioneering work of Domagk *et al.*⁸⁴ in 1946 on the antituberculosis activity of *p*-acetamidobenzaldehyde thiosemicarbazone (trivial names Thiacetazone or Tibon), the number of papers concerning the pharmacological use of these compounds has dramatically increased, due to the wide spectrum of their biological activity found in recent years.^{9,85} Nowadays, it is known that thiosemicarbazones show antitumorous, antiviral, antifungal, antibacterial and antimalarial activities. Of course, the primary task of researches is to investigate new compounds in respect of their activity against tumors and viruses. A correlation between the structure and biological activity has been established,³ the tridentate NNS 2-(*N*)-heterocyclic thiosemicarbazones being apparently most efficient as therapeutic agents. A new example of a potentially successful Fe(III) chelator in treating iron overload diseases is 3-aminopyridine-2-carboxaldehyde thiosemicarbazone (Triapine[®]), which has recently entered clinical trials.^{86,87} Of course, not only the ligands were found to be useful in pharmacological applications. It has been repeatedly shown that compared to the ligands, the thiosemicarbazone-based metal complexes (for example, Cu and Zn) are more efficient inhibitors of cancer cell growth.⁸⁸

As mentioned above, semicarbazones have a rather limited biological activity spectrum.^{9,85} They are mainly used as anticonvulsants, anti-protozoa agents, radioprotectors or radio-pharmaceuticals. There are also several reports on their anti-leukemia activity in mice,⁵ as well as on antimicrobial⁸⁹ and pesticide effects,⁹⁰ *etc.*

Until recently, it was assumed that isothiosemicarbazones are biologically inactive. However, Italian authors^{91–93} found a good antimicrobial potential for some of a range of 78 tested compounds, of which the 5-nitrofuryl derivative proved to be the most efficient.

Among an ample variety of thiosemicarbazone derivatives and their metal complexes, only a few examples of biological (including antiproliferative) tests with pyridoxal-based ligands can be found in the literature. One of the very promising applications of these compounds, such as pyridoxal aroylhydrazone, is their use as iron(III) chelating ligands in treating diseases of iron overload.^{94,95} For this purpose, Darnell and Richardson, after testing a number of compounds of this class, identified the most efficient molecule.⁹⁶ They found 2-hydroxy-1-naphthylaldehyde isonicotinoyl hydrazone is more effective in intracellular Fe chelation than desferrioxamine, the ligand of choice so far, being thus capable of antiproliferative action in some tumors. A study of this and similar aroylhydrazone compounds *in vivo* is now in progress.⁸⁶

However, as far as the biological activities of ligands based on PLTSC or PLSC and their complexes are concerned, there are only a few reports. The group of Belicchi Ferrari made a major contribution to these studies with their *in vitro* investigations of the activities of copper(II) compounds.

The ligand PLTSC and its copper(II) complexes – the monomeric $[\text{Cu}(\text{PLTSC})(\text{H}_2\text{O})\text{Cl}]\text{Cl}$ and dimeric $[\text{Cu}(\text{PLTSC}-\text{H})(\text{H}_2\text{O})]_2\text{Cl}_2 \cdot 2\text{H}_2\text{O}$, as well as the cobalt(III) complex, $[\text{Co}(\text{PLTSC}-\text{H})(\text{PLTSC}-2\text{H})] \cdot 4.5 \text{H}_2\text{O}$ were tested in respect of their biological activity. The obtained results showed that the Cu(II) complexes do not have antiviral action *in vitro* against RNA viruses, exhibit an inductive effect on Friend erythroleukemia cells (FLC), erythroid differentiation, and have a suppressive effect regarding FLC proliferation. In contrast to this, the cobalt(III) complex and free ligand showed no biological activity. The authors ascribe the observed differences in biological activities to the nature of the active species: $[\text{Cu}(\text{PLTSC})(\text{H}_2\text{O})]^{2+}$ in the monomeric and $[\text{Cu}(\text{PLTSC}-\text{H})(\text{H}_2\text{O})]^+$ in the dimeric complex, while the completely saturated coordination sphere in the octahedral Co(III) complex could be the reason for its lack of reactivity. Also, the free ligand PLTSC has no influence on FLC differentiation and other tests, probably due to its intramolecular hydrogen bonding, which is different from that in the complexes.⁵⁰

The ligands PLTSCet and PLTSCMe₂·H₂O (PLTSCet/Me₂ = pyridoxal N4-ethyl/dimethylthiosemicarbazone) have been tested *in vitro* against the U937 human

leukemic cell lines. Studies involving both inhibition of cell proliferation and apoptosis test showed that both ligands inhibited cell growth, but neither of them induced apoptosis.³⁰

The above unsubstituted ligand and its Cu(II) dimeric complex⁵⁰ were tested along with new copper dimeric complexes with N4-alkylated pyridoxal thiosemicarbazones of the formulas: $[\text{Cu}(\text{PLTSCMe}_2\text{-H})\text{Cl}]_2 \cdot 6\text{H}_2\text{O}$ and $[\text{Cu}(\text{PLTSCEt})\text{Cl}]_2 \cdot 2\text{Cl}_2 \cdot 2\text{H}_2\text{O}$ and N2,N4-methylated derivative $[\text{Cu}(\text{PLTSCMeMe})\text{Cl}]_2 \cdot 2\text{Cl}_2 \cdot 4\text{H}_2\text{O}$.³⁷ The previously synthesized compounds were applied on different murine and human leukemic cell lines both *in vitro* and *in vivo* and their activities were compared to the activity of the corresponding monomeric complex. Both complexes showed significant inhibition of TS/A murine adenocarcinoma cell proliferation *in vitro*, but they lacked *in vivo* activity of TLX5 lymphoma. Also, apoptosis on CEM and U937 human cell lines could be induced and their cycle altered with the dimeric complex. In comparison with this compound, the new complexes with N-alkylated ligands exerted only weak or practically no effect on the same cell lines (U937, CEM and K562), which is in accordance with previous reports on the effect of a substituent present on the amine nitrogen.⁹⁷

The biological activity of organotin(IV) complexes with PLTSC of the formula $[\text{SnR}_2(\text{PLTSC}-2\text{H})]$ (R = Me, Et, Bu, Ph) was also evaluated.⁵⁸ With the exception of the Me-complex, the other three suppress FLC proliferation, with the lowest thresholds for the latter two compounds. In contrast to the copper monomeric complexes with PLTSC,⁵⁰ the tin complexes did not enhance DMSO-induced FLC differentiation.

9. OTHER CHARACTERISTICS

Apart from their biological activity which can be used for pharmacological purposes, the title ligands and certain complexes appeared to be sensitive analytical tools for determining traces of metals in several complex materials. On the other hand, in some cases, the *in situ* formation of the ligand alone in the reaction of its constituent parts can also be exploited for analytical purpose.

Thus, in plasma analyses of vitamin B₆ vitamers (PL and PLP), which are very photosensitive, a new HPLC method based on precolumn semicarbazone formation and fluorescence detection has been proposed.⁹⁸ The obtained semicarbazones not only enhanced the fluorescence effects in comparison with the vitamers alone, but also increased their stability, thus enabling quantitative plasma PLP determinations even in B₆-deficient patients.

A kinetic spectrophotometric method was used in several cases to determine binary metal ion mixtures with PLTSC, provided the rates of metal ion reaction were sufficiently different. Thus, this method was successfully used to determine iron and cobalt ions in model solutions,⁹⁹ iron and copper in serum samples,¹⁰⁰ and copper and cobalt in steel samples.¹⁰¹ The last method was based on a flow-injection procedure described in a previous work¹⁰² for the determination of cobalt

with pyridoxal N4-phenylthiosemicarbazone. The same reagent was successfully used to determine iron(III) in some standard alloys and pharmaceutical samples.¹⁰³

Pyridoxal, N4-methylthiosemicarbazide, pyridoxal N4-methylthiosemicarbazone and Zn(II)-pyridoxal N4-methylthiosemicarbazone exhibited an interesting feature in a study of the inhibition of mild steel corrosion.¹⁰⁴ The Zn(II) complex appeared to be the most efficient, even when applied in a highly acidic medium.

10. CONCLUSION

Pyridoxal semi-, thiosemi- and isothiosemicarbazones represent a relatively new group of tridentate ONX (X = O, S, N) ligands of the Schiff-base type, exhibiting good complexing properties. Depending primarily on the synthesis conditions, pH, and nature of the metal ion, they can be coordinated either as neutral, mono- or dianionic ligands, whereby the proneness of the semicarbazide moiety to deprotonate increases in the series PLITSC < PLSC < PLTSC. Due to these properties, their tridentate nature and to the similarity of the nature of ligand molecules as a whole, it is not surprising that with the same metal (with a small number of exceptions) they give very similar types of complexes. Some Fe(III) chelates with PLTSC and its derivatives, are of special interest with respect to their magnetic characteristics. Namely, it has been found that the spin state of the central atom in these chelates may depend on both the nature of the substituent in the TSC fragment and the number of crystalline water molecules. Still it should be pointed out that this phenomenon is not a new one, as it was previously observed with Fe(III) complexes with salicylaldehyde thiosemicarbazone. Several Fe(III) and Cu(II) complexes with PLSC, PLTSC and PLITSC were electrochemically studied in non-aqueous media. A rather complicated voltammetric behavior, especially in the case of the Fe(III) compounds, was reported. Additionally some Cu(II) and Sn(IV) complexes with PLTSC and its derivatives showed certain biological activity, suppressing FLC proliferation *in vitro*, and some PLTSC derivatives have been proposed as sensitive analytical reagents of different transition metal ions.

Acknowledgement: This work was supported by the Ministry of Science and Environmental Protection of the Republic of Serbia (Grant No. 1318).

ИЗВОД

КОМПЛЕКСИ МЕТАЛА СА ШИФОВИМ БАЗАМА, ЛИГАНДИМА НА БАЗИ
ДЕРИВАТА СЕМИКАРБАЗИДА И ПИРИДОКСАЛАВУКАДИН М. ЛЕОВАЦ,¹ ВИОЛЕТА С. ЈЕВТОВИЋ,¹ ЉИЉАНА С. ЈОВАНОВИЋ¹ и
ГОРАН А. БОГДАНОВИЋ²¹Департаман за хемију, Природно-математички факултет, Универзитет у Новом Саду, Трг Доситеја
Обрадовића 3, 21000 Нови Сад и ²Институт за нуклеарне науке Винча, Лабораторија за теоријску физику
и физику кондензоване материје, п. бр. 522, 11001 БеоградПриказани су најважнији резултати опсежних испитивања (синтезе, спектралне,
магнетне, волтаметријске и структурне карактеристике и биолошка активност) комп-
лекса различитих метала са семи-, тиосеми- и изотиосемикарбазонима пиридоксала.

(Примљено 23. децембра 2004)

REFERENCES

1. M. J. M. Campbell, *Coord. Chem. Rev.* **15** (1975) 279
2. S. Padhye, G. B. Kauffman, *Coord. Chem. Rev.* **63** (1985) 127
3. D. X. West, S. B. Padhye, P. B. Sonawane, *Struct. Bond.* **76** (1991) 1
4. D. X. West, A. E. Liberta, S. B. Padhye, R. C. Chikate, P. B. Sonawane, A. S. Kumbhar, R. G. Yerande, *Coord. Chem. Rev.* **123** (1993) 49
5. S. N. Pandeya, J. R. Dimmock, *Pharmazie* **48** (1993) 659
6. J. S. Casas, M. S. Garcia-Tasende, J. Sordo, *Coord. Chem. Rev.* **209** (2000) 197
7. R. B. Singh, B. S. Garg, R. P. Singh, *Talanta* **25** (1978) 619
8. V. Arion, M. Revenko, J. Gradinaru, Yu. Simonov, V. Kravtsov, N. Gerbeleu, E. Saint-Aman, F. Adams, *Rev. Inorg. Chem.* **21** (2001) 1
9. H. Beraldo, *Quim. Nova* **27** (2004) 461
10. V. M. Leovac, V. I. Češljević, *Coordination Chemistry of Isothiosemicarbazide and Its Derivatives*, Faculty of Science, Novi Sad, 2002 (in Serbian)
11. S. Chandra, X. Sangeetika, *Spectrochim. Acta (A)* **60** (2004) 147
12. N. K. Singh, A. Srivastava, A. Sodhi, P. Ranjan, *Trans. Met. Chem.* **25** (2000) 133
13. N. V. Gerbeleu, V. B. Arion, J. Burgess, *Template Synthesis of Macrocyclic Compounds*, Wiley-VCH, Weinheim, 1999
14. V. M. Leovac, Lj. S. Jovanović, V. I. Češljević, L. J. Bjelica, N. J. Ević, *Polyhedron* **11** (1992) 1029
15. U. Knof, T. Weyhermuller, T. Wolter, K. Weighardt, *J. Chem. Soc. Chem. Commun.* (1993) 726
16. V. I. Češljević, V. M. Leovac, *J. Serb. Chem. Soc.* **59** (1994) 13
17. V. Arion, K. Weighardt, T. Weyhermuller, E. Bill, V. M. Leovac, A. Rufinska, *Inorg. Chem.* **36** (1997) 661
18. R. H. Holm, *Complexes of Vitamin B₆ in Inorganic Biochemistry*, G. B. Eichhorn, Ed., Elsevier, Amsterdam, 1975.
19. A. G. Sykes, R. D. Larsen, J. R. Fisher, E. H. Abott, *Inorg. Chem.* **30** (1991) 2911
20. P. Gili, M. G. Martin Rayes, M. G. Martin Zarza, M. F. C. Guedes da Silva, Y.-Y. Tong, A. J. L. Pombeiro, *Inorg. Chim. Acta* **255** (1997) 279
21. W. Henderson, L. L. Koh, J. D. Ranford, W. T. Robinson, J. O. Svensson, J. J. Vittal, Yu. M. Wang, Y. Xu, *J. Chem. Soc. Dalton Trans.* (1999) 3341
22. D. Dolphin, R. Poulson, O. Avramovic, Eds., *Vitamin B-6 Pyridoxal Phosphate: Chemical, Biochemical and Medical Aspects*, Part A, Wiley, New York, 1986
23. K. Aoki, H. Yamazaki, *J. Chem. Soc. Chem. Commun.* (1980) 363
24. T. Taguchi, M. Sugiura, Y. Hamada, I. Miwa, *Eur. J. Pharmacol.* **378** (1999) 283
25. M. Ferrari Belicchi, G. Fava Gasparri, E. Leporati, C. Pelizzi, P. Tarasconi, G. Tosi, *J. Chem. Soc. Dalton Trans.* (1986) 2455

26. V. M. Leovac, V. S. Jevtović, G. A. Bogdanović, *Acta Cryst.* **C58** (2002) 514
27. N. Ž. Knežević, V. M. Leovac, V. S. Jevtović, S. Grgurić-Šipka, T. J. Sabo, *Inorg. Chem. Commun.* **6** (2003) 561
28. V. S. Jevtović, *Ph. D. Thesis*, Faculty of Science, University of Novi Sad, 2002
29. M. Mohan, P. H. Madhuranath, A. Kumar, M. Kumar, N. K. Jha, *Inorg. Chem.* **28** (1989) 96
30. M. Belicchi Ferrari, F. Bisceglie, E. Leporati, G. Pelosi, P. Tarasconi, *Bull. Chem. Soc. Jpn.* **75** (2002) 781
31. U. Abram, K. Ortner, R. Gust, K. Sommer, *J. Chem. Soc. Dalton Trans.* (2000) 735
32. F. Basuli, M. Ruf, C. G. Pierpont, S. Bhattacharya, *Inorg. Chem.* **37** (1998) 6113
33. J. S. Casas, E. E. Castellano, A. Macias, M. C. Rodriguez-Argüelles, A. Sánchez, J. Sordo, *J. Chem. Soc. Dalton Trans.* (1993) 353
34. F. Basuli, S. M. Peng, S. Bhattacharya, *Inorg. Chem.* **39** (2000) 1120
35. J. S. Casas, M. V. Castano, M. C. Cifuentes, A. Sánchez, J. Sordo, *Polyhedron* **21** (2002) 1651
36. J. S. Casas, E. E. Castellano, M. C. Rodriguez-Argüelles, A. Sanchez, J. Sordo, J. Zukerman-Schpector, *Inorg. Chim. Acta* **260** (1997) 183
37. M. Belicchi Ferrari, F. Bisceglie, G. Pelosi, P. Tarasconi, R. Albertini, P. P. Dall' Aglio, S. Pinelli, A. Bergamo, G. Sava, *J. Inorg. Biochem.* **98** (2004) 301
38. Gy. Argay, A. Kalman, L. Parkanyi, V. M. Leovac, I. D. Brčeski, P. N. Radivojša, *J. Coord. Chem.* **51** (2000) 9
39. I. G. Santos, U. Abram, R. Alberto, E. V. López, A. Sánchez, *Inorg. Chem.* **43** (2004) 1834
40. N. C. Kasuga, K. Sekino, C. Koumo, N. Shimada, M. Ishikawa, K. Nomiya, *J. Inorg. Biochem.* **84** (2001) 55
41. A. Takeuchi, S. Komorita, *Chem. Express* **3** (1988) 535
42. V. M. Leovac, G. A. Bogdanović, V. I. Češljević, V. Divjaković, *Acta Cryst.* **C56** (2000) 936
43. V. N. Biyushkin, V. I. Gerasimov, I. V. Rozdestvenskaya, *Koord. khim.* **12** (1986) 1270
44. M. S. El-Ezaby, N. Gayed, *J. Inorg. Nucl. Chem.* **37** (1975) 1065
45. H. M. Dawes, J. M. Waters, T. N. Waters, *Inorg. Chim. Acta* **66** (1982) 29
46. V. H. Sabirov, A. S. Batsanov, Yu. T. Strutskov, M. A. Azizov, *Koord. khim.* **9** (1983) 1701
47. S. Dey, P. Banerjee, S. Gangopadhyay, P. Vojtišek, *Transition Met. Chem.* **28** (2003) 765
48. M. Belicchi Ferrari, G. Gaspari Fava, C. Pelizzi, P. Tarasconi, *J. Chem. Soc. Dalton Trans.* (1992) 2153
49. V. S. Jevtović, V. M. Leovac, S. Markov, J. Simeunović, *Yucomat 2003*. Herceg-Novi, p. 118
50. M. Belicchi Ferrari, G. Gasparri Fava, C. Pelizzi, P. Tarasconi, R. Albertini, S. Pinelli, R. Starchich, *J. Inorg. Biochem.* **53** (1994) 13
51. M. Belicchi Ferrari, G. Gaspari Fava, C. Pelizzi, G. Pelosi, P. Tarasconi, *Inorg. Chim. Acta* **269** (1998) 297
52. D. Poleti, Lj. Karanović, V. M. Leovac, V. S. Jevtović, *Acta Cryst.* **C59** (2003) 73
53. G. A. Bogdanović, V. M. Leovac, V. B. Medaković, V. S. Jevtović, S. D. Zarić, *6th International Conference on Fundamental and Applied Aspects of Physical Chemistry*, Belgrade 2002, Proceedings, p. 723
54. M. Belicchi Ferrari, G. Gaspari Fava, C. Pelizzi, P. Tarasconi, G. Tosi, *J. Chem. Soc. Dalton Trans.* (1987) 227
55. M. Mohan, N. S. Gupta, M. Kumar, W. E. Antholine, M. J. Ahmed, N. K. Jha, *Trans. Met. Chem.* **19** (1994) 265
56. V. M. Leovac, unpublished results
57. A. Symal, M. R. Maurya, *Trans. Met. Chem.* **11** (1986) 255
58. J. S. Cass, M. C. Rodriguez-Argüelles, U. Russo, A. Sánchez, J. Sordo, A. Vázquez-López, S. Pinelli, P. Lunghi, A. Bonati, R. Albertini, *J. Inorg. Biochem.* **69** (1998) 283
59. F. Grases, C. Genestar, *Radaiochim. Acta* **39** (1985) 43
60. M. Belicchi Ferrari, G. Gasparri Fava, M. Lanfranchi, C. Pelizzi, P. Tarasconi, *J. Chem. Soc. Dalton Trans.* (1991) 1951

61. M. Belicchi Ferrari, G. Gaspari Fava, G. Pelizzi, M. C. Rodriguez-Argüelles, P. Tarasconi, *J. Chem. Soc. Dalton Trans.* (1995) 3035
62. V. S. Jevtović, Lj. S. Jovanović, M. V. Leovac, L.J. Bjelica, *J. Serb. Chem. Soc.* **68** (2003) 929
63. Lj. S. Jovanović, V. S. Jevtović, V. M. Leovac, L. J. Bjelica, *J. Serb. Chem. Soc.* **70** (2005) 187
64. M. Belicchi Ferrari, G. Gaspari Fava, S. Pinelli, C. Pelizzi, P. Tarasconi, *6th Yugoslav-Italian Crystallographic Conference*, Pula, 1989, Abstracts, p. 23
65. V. S. Jevtović, Z. K. Jaćimović, Z. D. Tomić, G. Giester, V. M. Leovac, *41. Savetovanje Srpskog hemijskog društva*, Beograd, 2003, Izvodi radova, p. 80
66. Z. K. Jaćimović, Z. D. Tomić, G. Giester, V. S. Jevtović, V. M. Leovac, *ICOSECS 4*, Belgrade, 2004, Book of Abstracts, vol. I, p. 65
67. G. A. Bogdanović, V. S. Jevtović, V. M. Leovac, *7th International Conference on Fundamental and Applied Aspects of Physical Chemistry*, Belgrade, 2004, Proceedings, vol. II, p. 555
68. V. A. Kogan, V. V. Zelentsov, G. M. Larin, V. V. Lukov, *Kompleksy perekhodnykh metallov s gidrazonami*, Nauka, Moskva, 1990
69. N. S. Gupta, M. Mohan, N. K. Jha, W. E. Antholine, *Inorg. Chim. Acta* **184** (1991) 13
70. S. B. Novaković, G. A. Bogdanović, V. S. Jevtović, V. M. Leovac, *10th Conference of the Serbian Crystallographic Society*, Sokobanja, 2002, Book of Abstracts, p. 25
71. T. S. Wang, *Appl. Spectrosc.* **22** (1968) 167
72. V. M. Kolb, J. W. Stupar, T. E. Janot, a W. L. Duax, *J. Org. Chem.* **54** (1989) 2341
73. V. Leovac, L. Bjelica, Lj. Jovanović, *Polyhedron* **4** (1985) 233
74. V. M. Leovac, Lj. S. Jovanović, L. J. Bjelica, V. I. Češljević, *Polyhedron* **8** (1989) 135
75. L. J. Bjelica, Lj. S. Jovanović, F. D. Gaál, *Rev. Research, Chemistry Series, Faculty of Sciences*, University of Novi Sad, **13** (1983) 37
76. Lj. S. Jovanović, N. J. Ević, L.J. Bjelica, F. F. Gaál, *Microchem. J.* **38** (1988) 343
77. Lj. S. Jovanović, N. J. Ević, L.J. Bjelica, F. F. Gaál, *J. Serb. Chem. Soc.* **55** (1990) 219
78. G. K. Budnikov, *Elektrokhimicheskie reaktsii khelatov metallov v organicheskikh i smeshannykh rastvoritelyakh*, Izd. Kazanskogo universiteta, 1980, pp 100-130 (in Russian)
79. M. Cañadas, E. López-Torres, A. Martínez-Arias, M. A. Mendiola, M. T. Sevilla, *Polyllhedron* **19** (2000) 2059
80. O. Manoušek, P.Zuman, *J. Electroanal. Chem.* **1** (1959/60) 324
81. T. Pineda, J. M. Sevilla, M. Blazquez, F. Garcia-Blanco, M. Dominguez, *J. Electroanal. Chem.* **304** (1991) 53
82. L. Bjelica, Lj. Jovanović, *J. Electroanal. Chem.* **213** (1986) 85
83. L. J. Bjelica, Lj. S. Jovanović, V. M. Leovac, *Z. Phys. Chemie (Leipzig)* **269** (1988) 768
84. G. Domagk, R. Behnisch, F. Mietzsch, H. Schmidt, *Naturwissenschaften* **33** (1946) 315
85. H. Beraldo, D. Gambino, *Mini-Rev. Med. Chem.* **4** (2004) 159
86. D. R. Richardson, *Critical Reviews in Oncology/Hematology* **42** (2002) 267
87. F. J. Giles, P. M. Fracasso, H. M. Kantarjian, J. E. Cortes, R. A. Brown, S. Verstovsek, Y. Alvarado, D. A. Thomas, S. Faderl, G. Garcia-Manero, L. P. Wright, T. Samson, A. Cahill, P. Lambert, W. Plunkett, M. Sznol, J. F. DiPersio, V. Gandhi, *Leukemia Research* **27** (2003) 1077
88. A. Y. Louie, T. J. Meade, *Chem. Rev.* **99** (1999) 2711
89. A. Singh, R. Dhakarey, G. C. Saxena, *J. Indian Chem. Soc.* **73** (1996) 339
90. R. J. Anderson, I. S. Cloudsdale, R. J. Lamoreaux, K. Schaefer, J. Harr, 2000: US Patent, 6.110.869
91. M. T. Cocco, A. Plumitallo, M.L. Schivo, A. Delogu, *Farmaco* **45** (1990) 1101
92. M. C. Cardia, M. Begala, A. Delogu, E. Maccioni, A. Plumitallo, *Formaco* **55** (2000) 93
93. M. T. Cocco, C. Congiu, V. Onnis, M. L. Pellerano, A. Delogu, *Bioorg. Med. Chem.* **10** (2002) 501
94. J. T. Edward, *BioMetals.* **11** (1998) 203
95. P. V. Bernhardt, P. Chin, D. R. Richardson, *J. Biol. Inorg. Chem.* **6** (2001) 801
96. G. Darnell, D. R. Richardson, *Blood* **94** (1999) 781 and refs. therein

97. M. Baldini, M. Belicchi Ferrari, F. Bisceglie, G. Pelosi, S. Pinelli, P. Tarasconi, *Inorg. Chem.* **42** (2003) 2049
98. J. B. Ubbink, W. J. Serfontein, L. S. De Viliers, *J. Chromat. B* **342** (1985) 277
99. L. Ballesteros, D. Pérez-Bendito, *Analyst* **108** (1983) 443
100. M. Marquez, M. Silva, D. Pérez-Bendito, *Anal. Chim. Acta* **239** (1990) 221
101. E. Vereda, A. Rios, M. Valcarcel, *Analyst* **122** (1997) 85
102. E. Cristofol de Alcaraz, F. Sánchez Rojas, J. M. Cano Pavón, *Fresenius' J. Anal. Chem.* **340** (1991) 175
103. L. S. Sarma, G. N. Ramesh, C. J. Kumar, A. V. Reddy, *J. Indian Chem. Soc.* **77** (2000) 405
104. B. I. Ita, O. E. Offiong, *Mat. Chem. Phys.* **48** (1997) 164.