

A Review

Microbial Selection in Continuous Culture

W. HARDER, J. G. KUENEN

*Department of Microbiology, University of Groningen, Kercklaan 30, Haren,
The Netherlands*

AND

A. MATIN

*Department of Medical Microbiology, Stanford University, Stanford,
California 94305, U.S.A.*

Received 23 June 1976

Contents

	<i>Page</i>
1. Introduction	1
2. Theoretical considerations of continuous culture	2
A. General	2
B. Basic mathematics of continuous culture	4
C. Selection in continuous culture	6
3. Selection from nature	8
A. Selection at different substrate concentrations	8
B. Selection in response to more than one environmental factor	13
C. Selection of mixed populations	15
4. Selection of mutants	15
A. Mutants possessing hyper-levels of a substrate-capturing enzyme	16
B. Mutants exhibiting loss of biosynthetic function	19
C. Mutants containing mutator genes	20
5. Concluding remarks	22
6. References	22

1. Introduction

SELECTION and subsequent isolation of a specific micro-organism from a mixture of different organisms is a procedure of paramount importance in microbiology (van Niel 1949, 1955; Hungate 1962; Schlegel & Jannasch 1967; Veldkamp 1970). Among the methods available for selection, the classical batch type enrichment technique holds a special place. The major reasons for its popularity are its simplicity and the wide variety of selective growth conditions that can be applied. There is no doubt that this technique was a landmark in the history of microbiology in that it revealed the various metabolic types among micro-organisms and their significance in nature (Beijerinck 1921-1940). However, the complex processes occurring during growth of a mixed population in these closed systems are largely uncontrollable, and reproducible enrichments have been confined to organisms of pronounced metabolic specificities. Indeed, the reproducibility of batch enrichments generally increases when the initial conditions are made more extreme.

In the past, the strong interest in organisms selected in batch cultures overshadowed the fact that enrichment techniques for organisms lacking pronounced metabolic specificity were practically non-existent. With the introduction of the chemostat (Monod 1950; Novick & Szilard 1950*a,b*; Herbert *et al.* 1956), a new type of growth selection became available. In contrast to batch culture, continuous culture offers the possibility of selecting micro-organisms in a constant environment on the basis of their different growth rates at different substrate concentrations in the culture. Despite this novel feature, this technique has not received general recognition. This is the more surprising since the principles of enrichment and selection in continuous culture were already foreseen and practised by Novick & Szilard (1950*a,b*) in studies of mutation rates, and Powell (1958) and Moser (1958) provided mathematical analyses of the process of competition in the chemostat in the late fifties. We will not dwell here on the reasons for the apparent unpopularity of continuous flow methods in microbial selection. Instead, we intend to discuss the basic principles underlying microbial selection in continuous culture and illustrate some of its potentialities. For a broader discussion of the possibilities offered by continuous culture, the reader is referred to the reviews of Veldkamp & Jannasch (1972), Meers (1973) and Jannasch & Mateles (1974).

2. Theoretical Considerations of Continuous Culture

A. General

Micro-organisms, inoculated into a suitable growth medium, will grow at a rate which is the maximum possible under the given conditions. During their growth the environment will continuously change, but if the conditions remain favourable, growth will continue until one of the essential substrates in the medium is depleted. If all other nutrients are in excess this substrate is called the growth limiting substrate. The specific growth rate of a micro-organism is dependent on the concentration of the growth limiting substrate according to the empirical equation of Monod (1942, 1949):

$$\mu = \mu_{\max} \frac{s}{K_s + s} \quad (1)$$

where μ is the specific growth rate, μ_{\max} is the maximum specific growth rate, s is the concentration of the growth limiting substrate and K_s is a constant, numerically equal to the substrate concentration at which $\mu = \frac{1}{2} \mu_{\max}$. A diagrammatic representation of equation (1) is given in Fig. 1 and shows a Michaelis-Menten type of saturation curve.

To obtain sizeable population densities, the substrate concentrations employed in a batch culture are much higher than K_s , so that growth occurs at the maximum specific growth rate. Selection under these conditions will depend on the μ_{\max} values of different organisms. In contrast, in continuous culture, it is possible to maintain steady state concentrations of a growth limiting nutrient in the culture, which permit growth of micro-organisms at submaximal rates. In addition, in continuous culture parameters such as pH, oxygen tension, concentration of excretion products and population densities can easily be controlled.

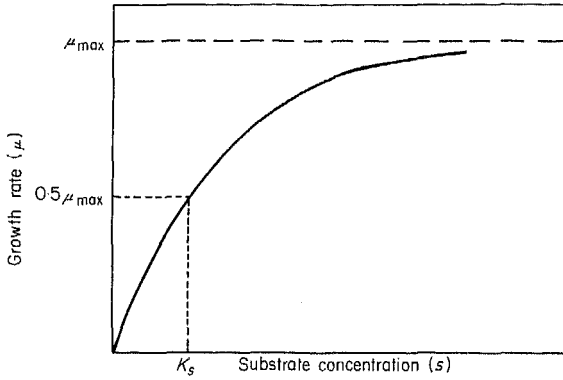

Fig. 1. Relation between the specific growth rate (μ) and the growth limiting substrate concentration (s). μ_{\max} is the maximum specific growth rate and K_s a constant.

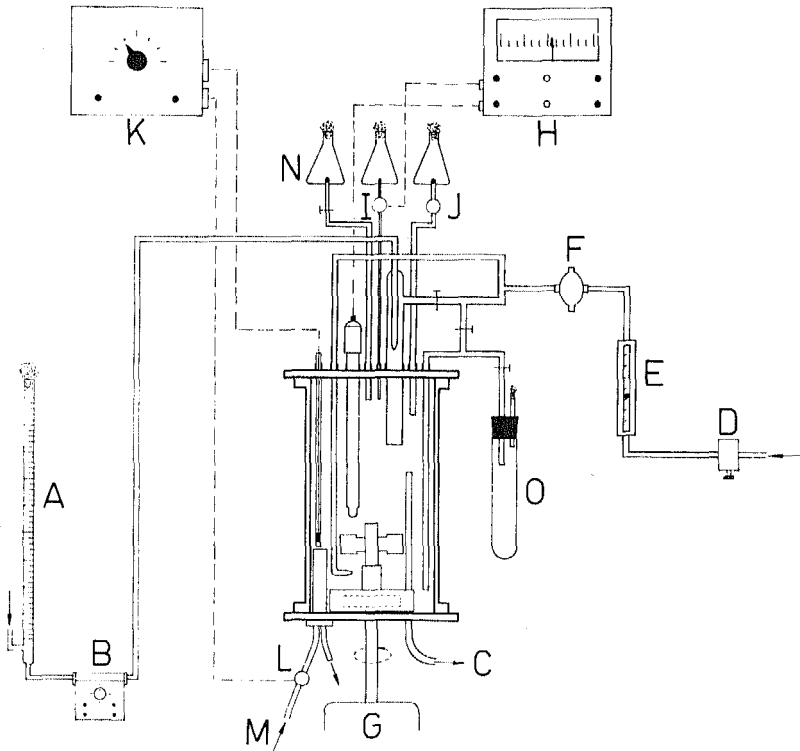

Fig. 2. Schematic diagram of a chemostat. A, burette (connected to medium reservoir) for measuring medium flow rate; B, medium pump; C, outlet for medium and air; D, gas flow controller; E, gas flow meter; F, filter; G, AC motor of magnetic drive; H, pH controller; I, peristaltic pump or magnetic valve connected to inlet tube for acid or alkali; J, peristaltic pump for antifoam addition; K, temperature controller; L, circulation pump; M, connection to temperature controlled waterbath; N, inoculation flask; O, sampling flask. From Veldkamp (1976).

B. Basic mathematics of continuous culture

A continuous culture consists of a culture vessel with growing micro-organisms, which is continuously supplied with fresh medium. The inflowing medium is instantly mixed with the culture liquid thus ensuring good homogeneity of the culture. At the same time the volume of the culture is kept constant by an overflow system. A schematic drawing of a continuous culture is shown in Fig. 2.

Upon initial inoculation, micro-organisms in this culture vessel grow as in batch culture, that is, at μ_{\max} , since all nutrients are present in excess. As the growth limiting substrate becomes depleted, the growth rate of the organisms will decrease according to equation (1) and will finally become zero, if no fresh medium is supplied to the culture. However, a continuous input of fresh medium will provide the culture with additional growth limiting substrate, allowing the growth rate of the organisms to be controlled by rate of addition of fresh medium. Although the organisms are simultaneously removed from the culture by the overflow device, they will maintain themselves in the vessel by multiplying, provided the rate at which the culture is diluted by the addition of fresh medium does not exceed a certain critical value.

The most commonly used continuous culture system is flow controlled, usually referred to as the chemostat (Herbert *et al.* 1956). In the chemostat the growth rate of micro-organisms is governed by the dilution rate (D) of the culture, where $D = f/V$; f = the flow rate (volume of fresh medium added to culture vessel/unit time) and V is the volume of the culture. (The dimension of D therefore is reciprocal time, usually h^{-1} .)

The change in the concentration of micro-organisms in the culture vessel is:

$$\text{change} = \text{growth} - \text{output} \quad (2)$$

and since growth is μx and output is Dx (where x = dry weight of organisms/l),

$$\frac{dx}{dt} = \mu x - Dx \text{ or } \frac{dx}{dt} = x(\mu - D). \quad (3)$$

So, if $\mu > D$ the concentration of organisms will increase, whereas the reverse is true for $\mu < D$. Only if $\mu = D$ will the level of organisms remain constant with time, that is, the culture will be in 'steady state'. Clearly, if $\mu > D$, consumption of substrate will be larger than the input and the substrate concentration in the growth vessel will gradually decrease, and, according to the Monod equation, μ will gradually decrease until the situation is reached where $\mu = D$. Not only from these considerations, but also from mathematical analysis, it can be shown that a chemostat is a self-adjusting system which will reach a steady state as long as D does not exceed the critical dilution rate (D_c):

$$D_c = \mu_{\max} \left(\frac{s_R}{K_s + s_R} \right) \quad (4)$$

where s_R is the substrate concentration of the inflowing medium. If $s_R \gg K_s$, then $D_c \approx \mu_{\max}$.

As the growth rate of an organism is determined by the concentration of the growth limiting substrate, we should also consider here the factors which govern substrate utilization and hence its residual concentration in the culture vessel.

The relation between growth (dx) and substrate utilization (ds) was found to be constant (Monod 1942):

$$\frac{dx}{ds} = \frac{\text{weight of organisms formed}}{\text{weight of substrate consumed}} = Y \quad (5)$$

where Y is the growth yield coefficient.

The change of substrate concentration (ds/dt) in the culture vessel is:

change = input - output - consumption

$$\frac{ds}{dt} = Ds_R - Ds - \frac{\text{growth}}{\text{yield}} = D(s_R - s) - \frac{ux}{Y} \quad (6)$$

Using equation (1)

$$\frac{ds}{dt} = D(s_R - s) - \frac{\mu_{\max} \cdot x}{Y} \left(\frac{s}{K_s + s} \right), \quad (7)$$

and substituting (1) in (3):

$$\frac{dx}{dt} = x \left[\mu_{\max} \left(\frac{s}{K_s + s} \right) - D \right], \quad (8)$$

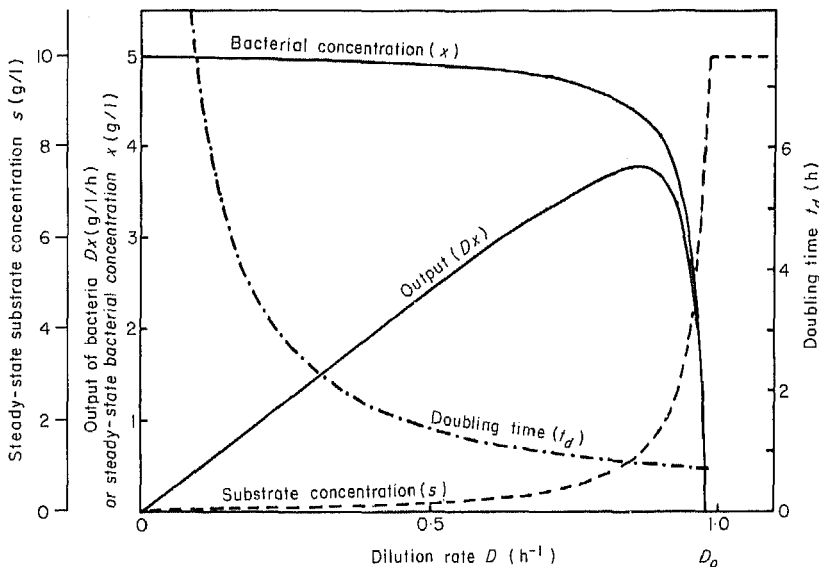

Fig. 3. Theoretical relations of the dilution rate (D) and the steady state values of bacterial concentration (x), substrate concentration (s), doubling time (t_d) and output (Dx). Data were calculated from equations (9) and (10) with the following growth constants: $\mu_m = 1.0 \text{ h}^{-1}$, $Y = 0.5$ and $K_s = 0.2 \text{ g/l}$, and a substrate concentration in the inflowing medium of $s_R = 10 \text{ g/l}$. Figure from Herbert *et al.* (1956).

It is obvious that in a steady state not only $dx/dt = 0$ but also $ds/dt = 0$. From equations (7) and (8) therefore follows the steady state concentration of the substrate (\bar{s}):

$$s = K_s \left(\frac{D}{\mu_{\max} - D} \right) \quad (9)$$

and similarly the steady state concentration of cells is (\bar{x}):

$$\bar{x} = Y(s_R - \bar{s}) = Y \left(s_R - K_s \frac{D}{\mu_{\max} - D} \right). \quad (10)$$

Equation (9) shows that \bar{s} is independent not only of \bar{x} but also of Y and s_R . Thus, it is possible to grow cells in continuous culture at high densities at growth limiting substrate concentrations. Fig. 3 shows a typical $D-\bar{x}$ and $D-\bar{s}$ curve for some experimental values of K_s , μ_{\max} and Y . It is apparent that a flow controlled chemostat can easily be operated at dilution rates clearly below the critical dilution rate, as small changes in D will only cause small changes in \bar{x} and \bar{s} . However, a flow controlled chemostat is not suitable for growing organisms in the range where \bar{s} and \bar{x} change dramatically with minor changes in D . For studies in this range (high growth rates) a turbidostat is usually employed, which keeps the cell density constant by continuous adjustment of the flow rate. It must be stressed, however, that in spite of differences in details of operation of the turbidostat, the theoretical basis is essentially the same for both systems (Herbert *et al.* 1966).

C. Selection in continuous culture

As has been stated before, it is clear from equation (9) that the substrate concentration in a steady state culture is dependent entirely on dilution rate and the particular growth characteristics of the organism. Consider two organisms A and B having growth characteristics as depicted in Fig. 4(a): in a steady-state-culture ($D = \mu$) of organism A at a given D , the concentration of the substrate will always be lower than that of a

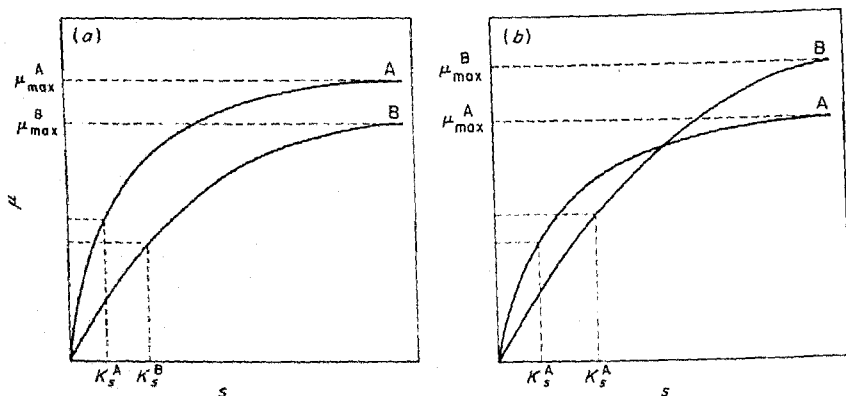

Fig. 4. $\mu - s$ relationship of two organisms A and B. (a) $K_s^A < K_s^B$ and $\mu_{\max}^A > \mu_{\max}^B$; (b) $K_s^A < K_s^B$ and $\mu_{\max}^A < \mu_{\max}^B$. From Veldkamp (1970).

culture of organism B at the same D . In other words, organism A will maintain a lower substrate concentration in the growth vessel than B. Therefore, in mixed culture of A and B, μ_B will become lower than μ_A and B will be washed out. In contrast, if the substrate saturation curves of A and B cross (Fig. 4(b)) the establishment of A or B as the steady state population would depend on the dilution rate. At high dilution rate (i.e., at high substrate concentration), B will outcompete A whereas the reverse will occur at low dilution rates (Pfennig & Jannasch 1962; Veldkamp & Jannasch 1972). Theoretically A and B will coexist if the dilution rate is set at the crossing point of the two curves (Fig. 4(b)). These considerations hold for any mixed culture in which there is no interaction between the component members (Powell 1958).

The considerations described for two competing organisms can be extended to more than two organisms and also to parent strains and their mutants. A more elaborate mathematical analysis of competition in the chemostat has been made by Powell (1958) and Moser (1958).

The Monod kinetics discussed above can usually account for the behaviour of chemostat cultures. The model is, however, oversimplified and must be modified in certain cases (Powell 1967; Tempest 1970). For instance, one of the assumptions on which the Monod model is based is that the yield coefficient (Y) is constant and independent of the growth rate (Monod 1942). However, yields can vary with growth rate due to, for instance, change of cell composition, change in efficiency of substrate utilization, the maintenance energy requirement, etc. Another variance from Monod kinetics may result from the effect of population densities due to, for example, excretion of growth stimulating or growth inhibitory substances (Tempest 1970). In such cases the growth parameters K_s and μ_{\max} may depend on the cell density above or below a certain threshold. Such an effect will clearly have a bearing on the outcome of a competition experiment. Similarly, it is possible that not all organisms in a culture are viable. This would mean that the viable organisms will grow at a rate greater than the actual dilution rate if a steady state is to be maintained. This can occur only if the actual substrate concentration in the culture is higher than that theoretically predicted from the Monod equation. Thus, as a result of a change in viability, the outcome of a competition experiment between two micro-organisms may not follow the theoretical predictions.

If the growth limiting substrate is toxic to the organisms the substrate saturation curve will actually not be a real saturation curve, but will decrease again above a certain optimal concentration of the substrate. In such a case the competition between two organisms will be governed by both their affinity to the substrate, and their ability to tolerate higher concentrations of the toxic substrate. Empirically it has been shown that the Haldane-equation gives a fairly good representation of such a $\mu - s$ relationship (Edwards 1970; Pawlowski & Howell 1973).

$$\mu = \mu_{\max} \frac{s}{(K_s + s)(1 + s/K_i)}$$

where K_i = the inhibition constant and μ_{\max} the theoretical maximum specific growth rate in the absence of inhibition. Such a case is illustrated in Fig. 5. Submaximal growth rates are possible at two distinct substrate concentrations. In order to grow an organism at substrate concentrations above optimal, the chemostat cannot be flow-controlled: on the one hand, a minor decrease in the dilution rate during the steady state will lead to a small decrease in substrate concentration and consequently in an increase in growth

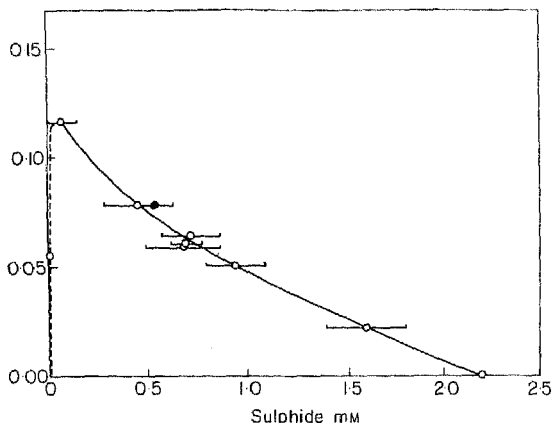

Fig. 5. Relation between specific growth rate and sulphide concentration in a *Chromatium* species. From van Gernerden & Jannasch (1971).

rate and the ultimate establishment of a new steady state at the corresponding substrate concentration below optimal. On the other hand, a similar increase in substrate will ultimately lead to a total inhibition of the growth of the organism (Veldkamp & Jannasch 1972). Growth at substrate concentrations above the optimum may be controlled by monitoring and controlling the substrate concentration itself.

3. Selection from Nature

A. Selection at different substrate concentrations

Jannasch (1967) pioneered the use of the chemostat in selection of micro-organisms from nature. He showed that if selection is carried out at a low concentration of the growth limiting carbon source, the bacteria which are selected from sea water are quite different from those selected at higher concentration of the same substrate. The former type of organisms have a low maximum specific growth rate (μ_{\max}) but also a high affinity (low K_s) for the substrate; the latter have a higher μ_{\max} but also a higher K_s . A synthetic medium with lactate as the growth-limiting nutrient was used in these experiments. Selection at low dilution rates (low lactate concentrations) led to the dominance of organisms belonging to the genera *Spirillum*, *Achromobacter*, *Vibrio* or *Micrococcus*; high dilution rates favoured the selection of organisms belonging to the genera *Pseudomonas* or *Aerobacter*. A *Spirillum* sp. and a *Pseudomonas* sp. which became the dominant populations at low and high dilution rates, respectively, were isolated in pure cultures. The two cultures were mixed and introduced into two separate chemostats which were run at dilution rates of 0.4 and 0.7 h⁻¹, respectively, using a lactate limited medium. The outcome was in agreement with the initial results: in the chemostat run at the lower dilution rate, the *Spirillum* sp. predominated 7:1 after five volume changes whereas at the dilution rate of 0.7 h⁻¹, the *Pseudomonas* sp. predominated 9:1 after 12 volume changes. The relationship between growth rate and lactate concentration for the two organisms, as determined in batch culture, is shown in

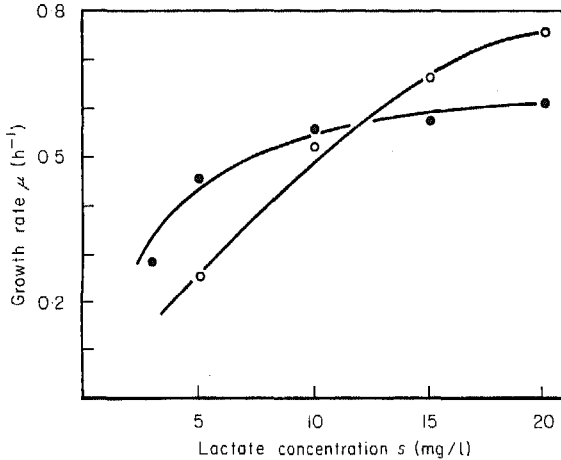

Fig. 6. Specific growth rate of a marine *Spirillum* sp. as a function of lactate concentration. K_s values: *Pseudomonas* sp., 9×10^{-5} M; *Spirillum* sp., 3×10^{-5} M. From Jannasch (1967).

Fig. 6. The substrate saturation curves of the two organisms cross and this explains the outcome of selection at different dilution rates (see Section 2.C).

Apart from the concentration of the limiting carbon source in the culture vessel, its concentration in the inflowing medium also affected the outcome of the selection. Thus, in one experiment, at a fixed dilution rate of 0.1 h^{-1} , lactate concentrations of 0.1, 1.0 and 10.0 mg/l in the inflowing medium led to the selection of an *Achromobacter* sp., a *Micrococcus* sp. and a *Spirillum* sp., respectively. Different responses of these organisms related to the densities of the population in the culture obtained at different lactate concentrations in the inflowing medium could account for these results (Jannasch & Mateles 1974).

Selections in the chemostat from fresh water have been carried out by Veldkamp and his coworkers. The method used in these experiments is illustrated in Fig. 7. One connects two chemostats to a reservoir containing an appropriate medium with a growth limiting nutrient. The medium pumps are adjusted to give different dilution rates in the two chemostats while all other parameters such as temperature, pH, dissolved oxygen, etc., are maintained at the same value. Both vessels are inoculated with a water sample which has previously been filtered in order to eliminate protozoa. The outcome of the competition is monitored by plating samples. As a rule, one finds different dominant bacterial populations in the two vessels after *ca.* five volume changes. This procedure is usually followed by purification of the dominant populations and the results are checked by carrying out competition experiments with the pure cultures (Veldkamp & Kuenen 1973).

Selections in the above manner have been made under carbon limiting conditions (lactate, glutamate and methanol, unpublished results) or under phosphate limitation (Veldkamp & Kuenen 1973). With any of the above substrates, small, thin, often spiral-shaped bacteria were selected at low dilution rates; at high dilution rates, selection of longer, thicker rods, often belonging to the genus *Pseudomonas* occurred. The relationship between growth rate and phosphate concentration of a *Spirillum* sp. and a

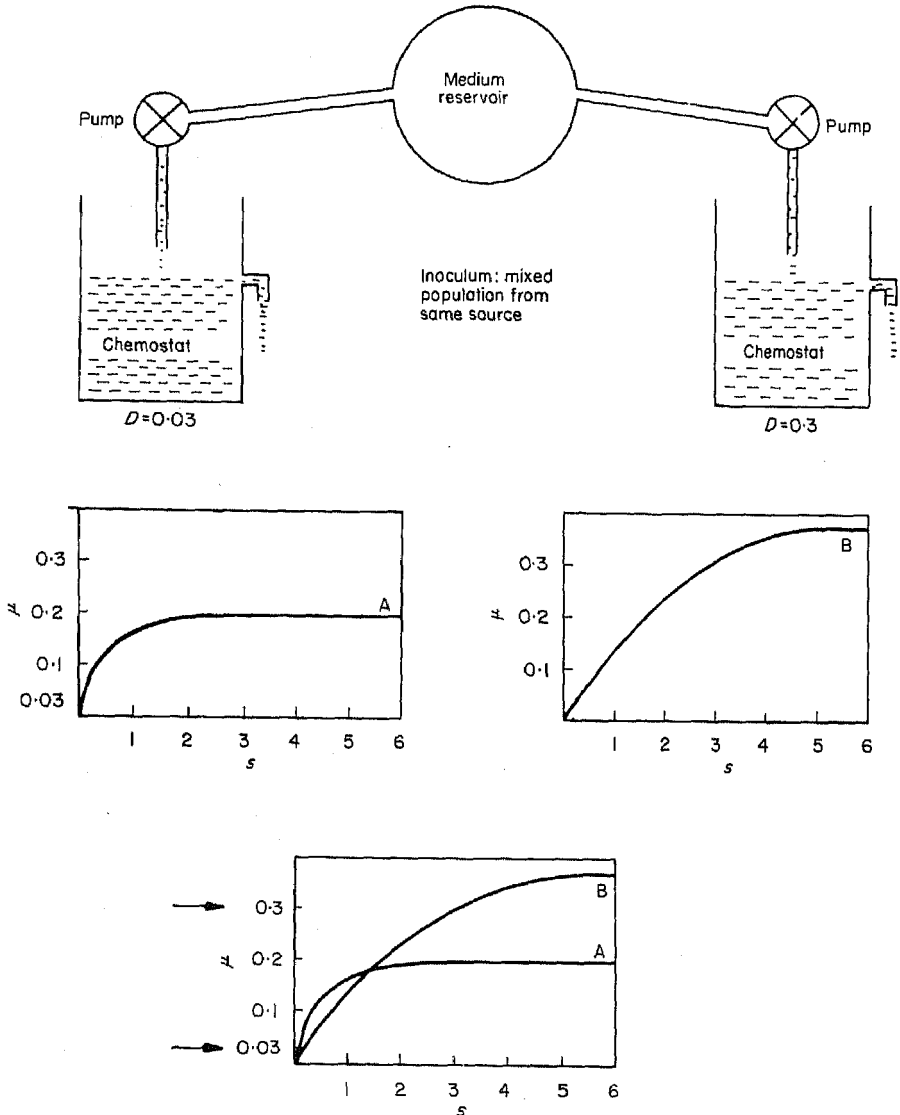

Fig. 7. Diagrammatic representation of the method used in selecting organisms on the basis of substrate affinity. Two chemostats are fed the same medium from the reservoir. The dilution rates in the left and right fermenters are $D = 0.03 \text{ h}^{-1}$ and $D = 0.3 \text{ h}^{-1}$ respectively. Both fermenters are inoculated with a mixed population from the same (natural) source. In the left fermenter A becomes dominant (low μ_{\max} , low K_s), in the right fermenter B (high μ_{\max} , high K_s). If the experiment is repeated with mixed, pure cultures of A and B (lower diagram) A becomes dominant at low and B becomes dominant at high dilution rates. From Kuenen & Veldkamp (1973).

rod-shaped bacterium is shown in Fig. 8. (These bacteria were isolated from fresh water at different dilution rates using phosphate limitation.) The curves describing this relationship for the two organisms cross and it is evident that if competition between them is carried out at a phosphate concentration to the left of the crossing point, the

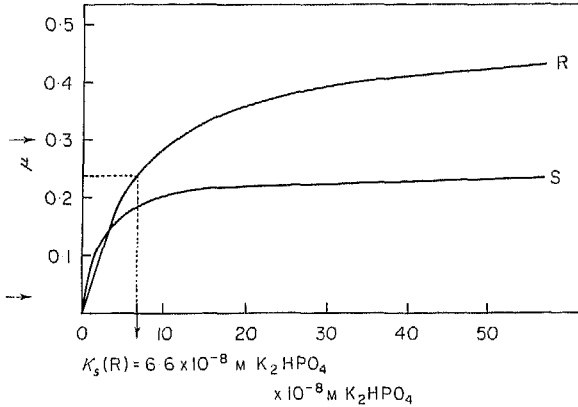

Fig. 8. Specific growth rate of a fresh water rod-shaped bacterium (R) and a *Spirillum* sp. (S) as a function of phosphate concentration. The curves are schematic and based on two measurements each at the growth rates indicated by the arrows. K_s values: rod shaped bacterium, $6.6 \times 10^{-8} \text{ M}$; *Spirillum* sp., $2.7 \times 10^{-8} \text{ M}$. From Veldkamp & Kuenen (1973) and Kuenen *et al.* (1977).

Spirillum would outgrow the *Pseudomonas*, while the reverse would be true at concentrations to the right of the crossing point. This was confirmed experimentally with a mixture of pure cultures of the two organisms (Veldkamp & Kuenen 1973). Competition between the two organisms was also studied employing limitation of a variety of other substrates. The different limitations used were lactate, succinate, alanine, asparagine, Mg^{++} , K^+ and NH_4^+ . The *Spirillum* sp. outcompeted the rod at a low concentration of any of these substrates. Experiments designed to test the metabolic versatility of the two organisms revealed no differences with respect to the utilization of 20 different carbon sources as growth substrates (Kuenen *et al.* 1977).

The low μ_{max} -low K_s type of organism was considered by Jannasch (1967) to represent the 'autochthonous' (Winogradsky 1949) part of the microbial population of natural waters. Since, as a rule, these environments are poor in nutrients (Duursma 1965), it is clear that such bacteria must play a predominant role in microbial transformations in these environments. Even relatively richer environments probably contain localized niches of nutrient depletion where such bacteria may play an important role. And yet, very little information on their physiology and ecology is available, because selections from these and other environments have been almost exclusively carried out using batch type enrichment techniques, which select *against* such organisms.

With this in mind Matin & Veldkamp (1974, and in preparation) have isolated the two types of bacteria from a fresh water pond employing L-lactate limitation. The low μ_{max} -low K_s bacterium is a *Spirillum* sp., and the high μ_{max} -high K_s organism is a *Pseudomonas* sp. The results of a competition experiment between the two bacteria under L-lactate limitation are shown in Fig. 9(a) and (b). The data give the ratio of viable counts of the *Pseudomonas* sp. and the *Spirillum* sp. at a dilution rate of 0.046 h^{-1} . It can be seen that the *Spirillum* sp. rapidly becomes dominant. Fig. 9(b) also gives the expected change in this ratio if the *Pseudomonas* sp. were unable to

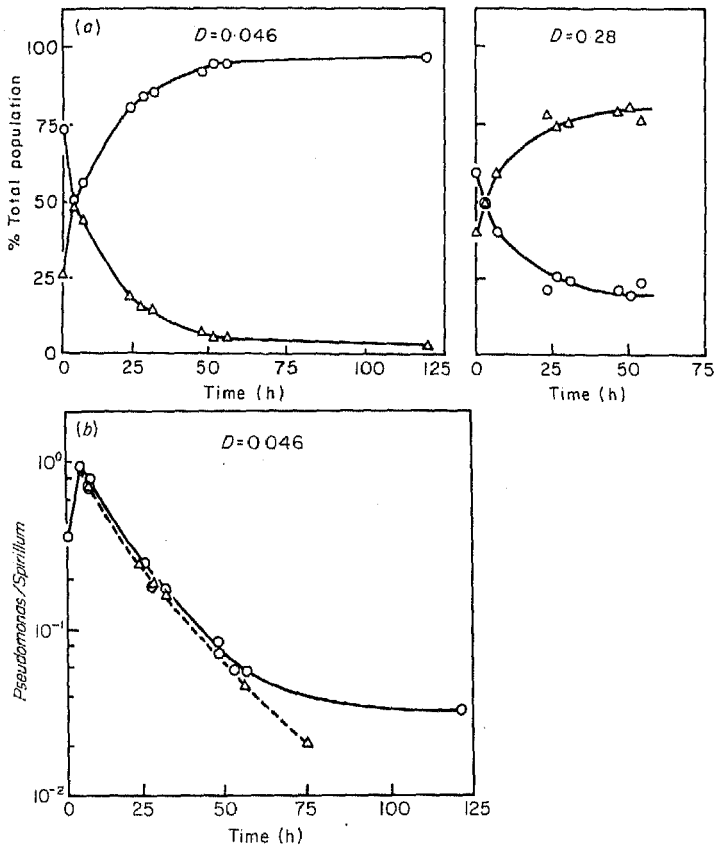

Fig. 9. (a) Competition between a fresh water *Pseudomonas* sp. (Δ) and *Spirillum* sp. (O) under L-lactate limitation at different dilution rates (Matin & Veldkamp, in preparation). (b) Change in the ratio of viable counts of *Pseudomonas* sp. and *Spirillum* sp. as a function of time at $D = 0.046 \text{ h}^{-1}$ during the competition experiment shown in (a) (O). The expected change in this ratio if the *Pseudomonas* sp. were not growing is also shown (Δ) (Matin & Veldkamp, in preparation).

multiply. The two rates are identical; thus at a low lactate concentration, the competitive advantage of the *Spirillum* sp. is such that the growth of the *Pseudomonas* sp. is negligible.

A comparative study of chemostat cultures of the two organisms revealed several features which could account for their different substrate saturation curves. The *Spirillum* sp. possesses a higher surface/volume ratio and a higher affinity transport system which should enable it to concentrate nutrients present at low concentrations more effectively than the *Pseudomonas* sp. In addition, the concentrations of cytochrome c, and NADH and NADPH oxidases are higher in the *Spirillum* sp., especially at low growth rates. It is interesting that during growth under carbon limitation, the *Spirillum* sp. accumulates poly- β -hydroxybutyric acid, which increases with decreasing growth rate: this propensity for polymer accumulation may have survival value in nutrient-poor environments in which the resident microflora must be frequently exposed to starvation conditions. This conjecture is supported by the finding that the *Spirillum* sp. is more resistant to death from starvation than the *Pseudomonas*

sp., especially after growth at low growth rates (Matin, Veldhuis & Stegeman, in preparation). Apart from these findings which point to adaptations of the *Spirillum* sp. to environments allowing only low growth rates, there is also evidence suggesting that the *Pseudomonas* sp. is unable to adapt to such environments. Thus, when the growth rate of the *Pseudomonas* sp. is lowered below $0.05\text{--}0.02\text{ h}^{-1}$, it shows signs of metabolic imbalance in that it excretes a large amount of NAD into the medium and its potential to respire lactate shows an abrupt decline (Matin & Veldkamp, in preparation).

B. Selection in response to more than one environmental factor

The potential of the chemostat to select on the basis of differences in the response to more than one environmental factor is illustrated by the work of Harder & Veldkamp (1971). Competition was studied between a facultatively psychrophilic *Pseudomonas* sp. (optimum temperature, 30°C), and an obligately psychrophilic *Spirillum* sp. (optimum temperature, 14°C), with respect to the effect of two environmental parameters, substrate (lactate) concentration and temperature. At temperature extremes of 16° and -2°C , one of the organisms grew faster at all lactate concentrations (dilution rates), the higher temperature leading to the dominance of the facultative psychrophile,

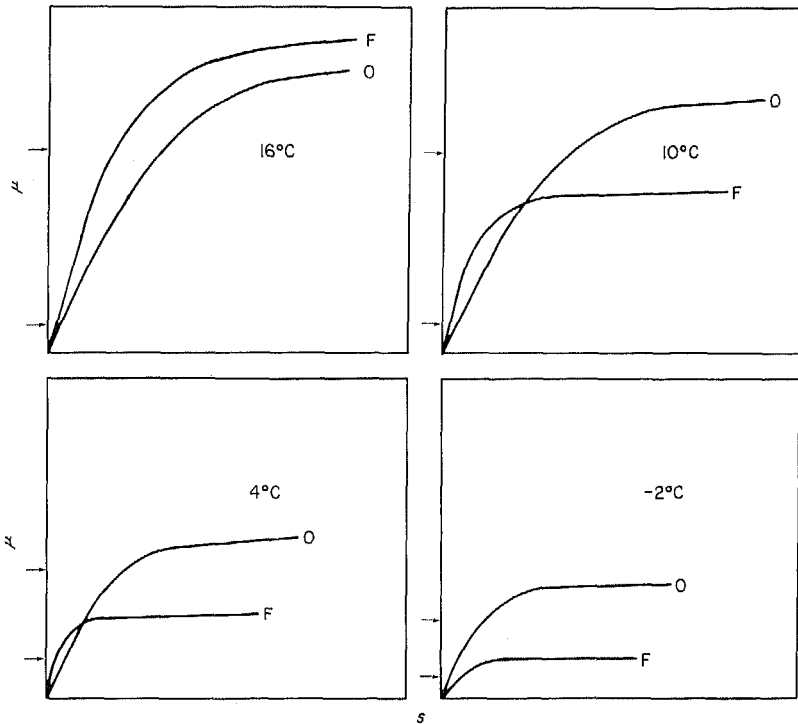

Fig. 10. Specific growth rate of an obligately psychrophilic *Pseudomonas* sp. (O) and a facultatively psychrophilic *Spirillum* sp. (F) as a function of lactate concentration at different temperatures. The curves are schematic and based on two measurements each at the growth rates indicated by the arrows. From Harder & Veldkamp (1971).

the lower temperature favouring selection of the obligate psychrophile (Fig. 10). However, at the intermediate temperatures of 10° and 4°C, the curves describing the relationship between growth rate and lactate concentration for the two organisms crossed, and lactate concentration became the decisive factor in competition indicating that K_s and μ_{\max} have independently changed with temperature. In a similar study Wirsen & Jannasch (1970) demonstrated that the K_s of a *Spirosoma* sp. for glucose changed from 3.2 to 0.3 mM when the temperature of steady state cultures was lowered from 30° to 15°C.

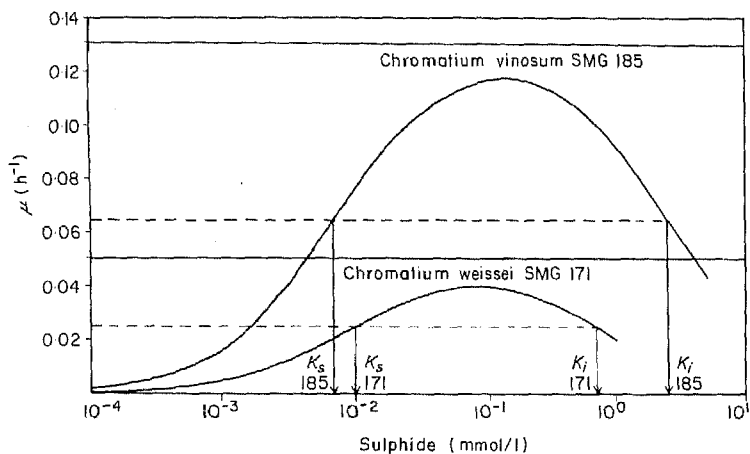

Fig. 11. Relation between the specific growth rate and sulphide concentration of *Chromatium vinosum* and *Chromatium weissei*. Full horizontal lines represent the theoretical μ_{\max} , broken lines represent $\frac{1}{2}\mu_{\max}$. From van Gernerden (1974).

Another example of selection on the basis of more than one parameter is the work of van Gernerden (1974). He studied the competition of two photosynthetic bacteria, *Chromatium vinosum* and *Chromatium weissei* under sulphide limitation and continuous light conditions in the chemostat. As can be seen from Fig. 11, *Chr. vinosum* became the dominant organism at all dilution rates. The outcome of this experiment could not provide an explanation for the occasional occurrence of *Chr. weissei* in high numbers in nature. However, in nature the sulphide concentration, in contrast to that in the steady state of a chemostat, may vary significantly due to the day and night rhythm. When a light and dark rhythm was introduced as an additional variable in similar competition experiments in the chemostat, *Chr. weissei* was able to maintain itself in the culture at high levels. It should be emphasized that in this case the continuous culture, by virtue of the dark and light regime, was essentially maintained in a non-steady state condition. The explanation of this phenomenon was found in the ability of *Chr. weissei* to oxidize the sulphide accumulated during the dark period, more rapidly than *Chr. vinosum*. This allowed *Chr. weissei* to utilize a significant portion of the available sulphide in the early stages after the dark period. During the early oxidation of sulphide, intracellular sulphur was formed and polysaccharide reserve materials accumulated in the cells. In the later stage, when sulphide concentrations had

become low, *Chr. weissei* could continue to grow at the expense of the intracellular sulphur and the stored reserve polymers at a rate higher than predicted from the μ -sulphide concentration curve. The outcome of these experiments may thus explain the coexistence of similar organisms in natural habitats.

C. Selection of mixed populations

Some instances have been recorded in the literature in which selection in continuous culture on a limiting carbon source led to the dominance of stable mixed microbial populations. These studies have been carried out mainly in connection with the production of single cell protein from methane and methanol and may be of considerable economic interest (Sheehan & Johnson 1971; Wilkinson *et al.* 1974; Snedecor & Cooney 1974). Wilkinson *et al.* (1974) have studied the nature of the interaction of a mixed microbial population utilizing methane. The population consisted of a methane-utilizing *Pseudomonas* sp., a methanol utilizing *Hyphomicrobium* sp., and, in addition, an *Acinetobacter* sp. and a *Flavobacter* sp. The authors concluded that the *Hyphomicrobium* sp. served to remove the small amounts of methanol which are produced during methane utilization by the *Pseudomonas* sp. and which inhibit its growth. The function of the *Acinetobacter* and *Flavobacter* spp. was believed to be the removal of complex products of growth or cell lysis.

4. Selection of Mutants

It was discussed earlier (Section 2) that the establishment of a particular micro-organism as a successful competitor in a chemostat culture will depend on the growth conditions and the properties of the organism. Since theoretically, a pure culture may turn into a mixed culture if a mutant arises that is favoured by the particular conditions

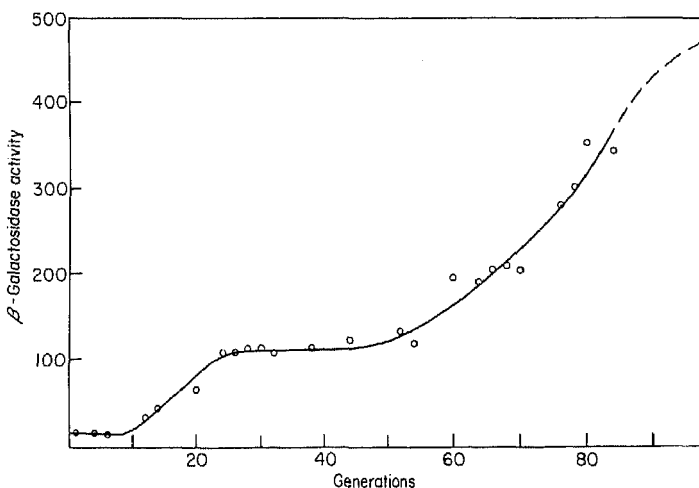

Fig. 12. Rise in β -galactosidase activity of *Escherichia coli* strain E102 grown in a lactose-limited chemostat. From Novick (1961).

of growth, the principles discussed above for mixed cultures apply also to the selection of mutants.

A. Mutants possessing hyper-levels of a substrate-capturing enzyme

Novick (1961) and Horiuchi *et al.* (1962) used continuous culture as an effective means for selecting specific types of mutants. They grew a strain of *Escherichia coli* that was inducible for β -galactosidase in a lactose-limited chemostat at relatively low dilution rates and observed a series of events which are shown in Fig. 12. During the first 10 generations, a low level of β -galactosidase activity was found. After about 20 generations the enzyme level rose to a value of over 100 units; such a level corresponds to that usually found in constitutive mutants. Samples of the culture taken from the chemostat and grown in batch cultures in the absence of lactose continued to form β -galactosidase at the same rate, indicating that the mutant that was selected was indeed constitutive for the synthesis of this enzyme. Continuation of the experiment led to the selection of mutants containing higher and higher levels of β -galactosidase until a strain was selected which seemed to have reached a maximum level of the enzyme. This maximum was about $\times 5-6$ that usually found in constitutive strains and the enzyme then made up approximately 20% of the total amount of bacterial protein. Bacteria containing these high levels of the enzyme could only be maintained in continuous culture under conditions where the lactose concentration is very low. When such hyper-producing strains were transferred to a batch culture with higher lactose concentrations, bacteria with the normal constitutive enzyme level were rapidly selected.

The results of this experiment can be rationalized making the assumption that the growth rate of the organism at low lactose concentrations depends on the concentration of β -galactosidase. This means that under lactose limitation, the rate of lactose hydrolysis is the growth-limiting reaction. This is not unlikely since β -galactosidase has a relatively high K_m for lactose ($3 \times 10^{-3} M$). At a given low intracellular lactose concentration the rate of its hydrolysis can be increased in one of two ways: first, by synthesizing more enzyme; and second, by synthesizing a modified enzyme having a lower K_m . Under the experimental conditions employed, the organisms synthesized

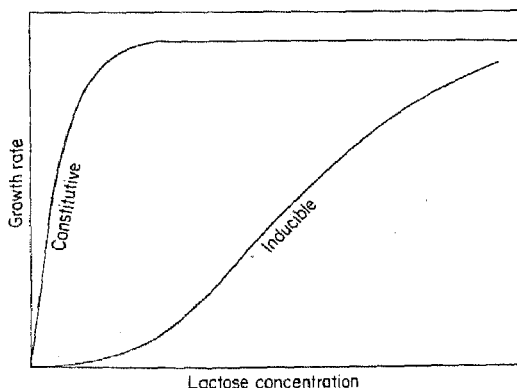

Fig. 13. Hypothetical relationship between growth rate and lactose concentration when the growth limiting enzyme is constitutive and when it is inducible. From Novick (1961).

more enzyme. The initial selection of a constitutive mutant would be favoured for the following reasons: in the inducible wild type the enzyme level will depend on the concentration of the inducer outside the cell; at very low inducer concentrations the enzyme level will be low and it will increase slowly with increasing concentrations of the inducer. In a constitutive strain, on the other hand, the enzyme level will be maximal irrespective of the substrate concentration and the mechanism of selection can then be understood from the $\mu - s$ relations (Fig. 13). In this diagram hypothetical $\mu - s$ relationships are given for a constitutive and an inducible strain. From the considerations given above it will be apparent that the constitutive strain is able to grow faster at low lactose concentrations and is, therefore, selected at low dilution rates. This technique of selecting constitutive mutants from inducible strains is applicable to all those cases in which the growth rate depends on the level of the enzyme of interest.

The subsequent selection of bacteria showing high levels of β -galactosidase (hyper strains) has been explained by Horiuchi and coworkers on the basis of crossing Monod saturation curves (cf. Fig. 4(b)). In this diagram organism B would be the normal constitutive mutant producing normal levels of enzyme, whereas organism A would be the hyperproducing mutant. At high concentrations of lactose, the normal strain is favoured, since under these conditions the growth-limiting step is not the rate of lactose hydrolysis. The excess enzyme in the hyper-strain is therefore superfluous and the energy wasted in synthesizing high levels of enzyme is reflected in a lower maximum specific growth rate. In contrast, at low lactose concentrations found under lactose limitation cells A possessing higher than normal levels of β -galactosidase can grow faster than strain B and will be selected. It is interesting to note that the selection of such hyperproducing strains has only been obtained in continuous culture. All attempts to obtain these mutants by successive transfer in batch culture have been unsuccessful.

The molecular basis for the hyperproduction of β -galactosidase in the organisms selected in this way is not completely understood. A possible explanation is that the cell contains more than one copy of the lac-operon (Horiuchi *et al.* 1962). Another possibility is that a promotor mutation results in a higher rate of transcription of the lac-operon (Clarke 1974). At present it is not possible to choose between these explanations although the gene duplication theory appears to be the more plausible.

In the experiments discussed above and those of Silver & Mateles (1969) and Dean (1972) and coworkers, spontaneous mutants containing higher levels of the enzyme were selected. It should be reiterated, however, that selection of this kind can only be successful when the growth-rate of the organism at lower substrate concentrations is limited by the level of the enzyme in question, and it seems likely that this is the case when the Michaelis-Menten constant of the 'substrate-capturing' intracellular enzyme is relatively high. Examples of such enzymes are: bacterial α - and β -galactosidase, uridine nucleosidase, a number of amino peptidases, asparaginase, urease, arylesterases, etc. (Barman 1969). The validity of this concept is further demonstrated by the recent elegant experiments of Hartley and his co-workers (Hartley *et al.* 1972; Hartley 1974; Rigby *et al.* 1974). These workers studied the behaviour of *Klebsiella aerogenes* in continuous culture. Wild-type *Klebsiella* is able to grow with ribitol as the sole carbon and energy source for growth and the initial catabolic step is the oxidation of ribitol to D-ribulose by the inducible enzyme ribitol dehydrogenase. Wild-type strains will not grow on xylitol, a stereoisomer of ribitol not widely found in nature, as the sole carbon and energy source, but it is possible to isolate mutants which will, and such mutants are found to be constitutive for the synthesis of ribitol dehydrogenase. Lerner *et al.* (1972)

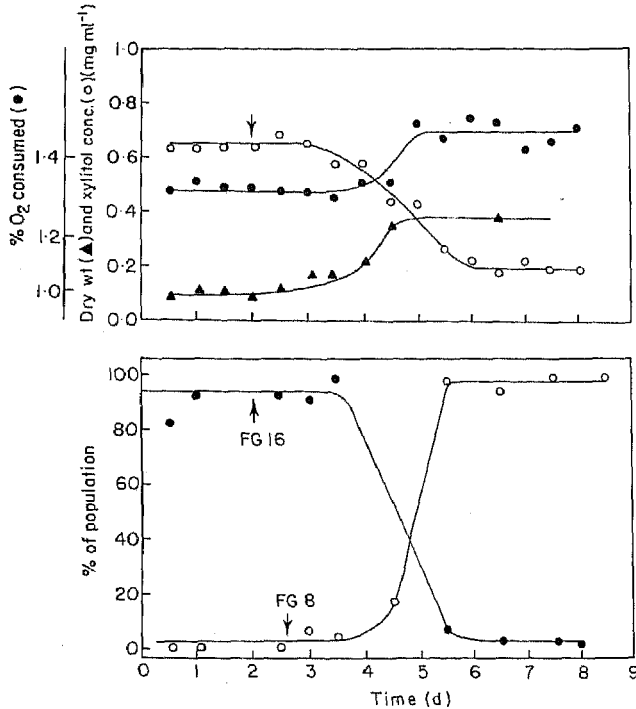

Fig. 14. Takeover in a continuous culture of strain FG 8 (●) by FG 16 (○). The arrow shows where 20 cells of strain FG 16 were introduced in a culture of FG 8. From Hartley *et al.* (1972).

presented convincing evidence that the growth on xylitol is due to the action of ribitol dehydrogenase on this substrate. However, ribitol dehydrogenase is not a very good enzyme for xylitol. The apparent K_m of the purified enzyme for ribitol is approximately 1 mM, whereas the affinity of the enzyme for xylitol is much lower (K_m approximately 1 M).

Since evidence was obtained that the rate of oxidation of xylitol was limited by the activity of ribitol dehydrogenase, the constitutive mutant was grown in continuous culture at low dilution rates with xylitol as the limiting carbon and energy source. In this way both spontaneous and u.v.-induced mutants were obtained with higher and higher ribitol dehydrogenase levels in a series of events similar to those described for β -galactosidase in *E. coli*. Eventually, hyperproducing mutants were selected in which the enzyme protein constituted up to 20% of the total protein. Thus, as in the case of β -galactosidase, the organisms eventually selected produced increased amounts of the substrate-capturing enzyme rather than synthesized an altered, improved enzyme. To test the potential of the chemostat to select a few cells of a mutant containing an improved enzyme from the population of the original organism, Hartley and his colleagues performed the following experiment (Fig. 14). A strain of *Klebsiella aerogenes* (FG 8) was grown in continuous culture with xylitol as the limiting carbon and energy source. The K_m of ribitol dehydrogenase for xylitol in this organism is 1 M. After steady-state was established (10^{12} cells), 20 cells of a mutant of *K. aerogenes* (FG 16) were

introduced into the culture. FG 16 differed from FG 8 in that its ribitol dehydrogenase had a lower K_m for xylitol (0.5 M). Within 3 d, the newly introduced mutant organism had completely taken over, indicating the strong selective pressure that continuous culture is able to exert on bacterial populations.

In the experiments described above, selection of mutants showing hyper-levels of a substrate-capturing enzyme was carried out in continuous culture, using 'natural' substrates. It should be possible, however, to use this technique in selection of mutants possessing improved ability to metabolize unnatural substrates. It has been emphasized before, this strategy of mutant selection is not likely to be successful for enzymes possessing a low K_m for the substrate used. Then, the rate of transport, and not of initial metabolism of the substrate may be limiting the growth rate at low substrate concentrations and the chemostat will almost certainly select for mutants showing a more efficient transport system.

B. Mutants exhibiting loss of biosynthetic function

Selection of mutants in continuous culture does not only operate in favour of strains that have developed high levels of 'substrate-capturing' enzymes. Loss of certain biosynthetic functions may also lead to the selective advantage of mutants over parental

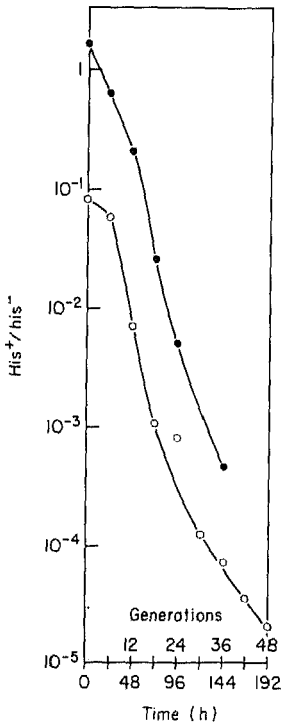

Fig. 15.

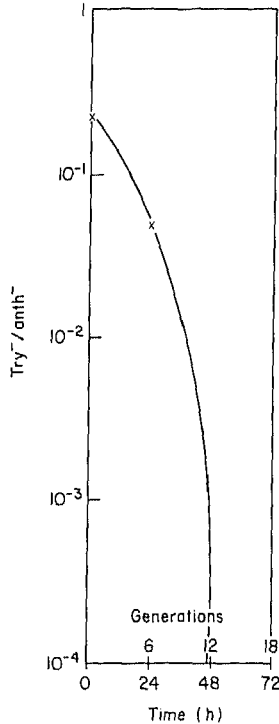

Fig. 16.

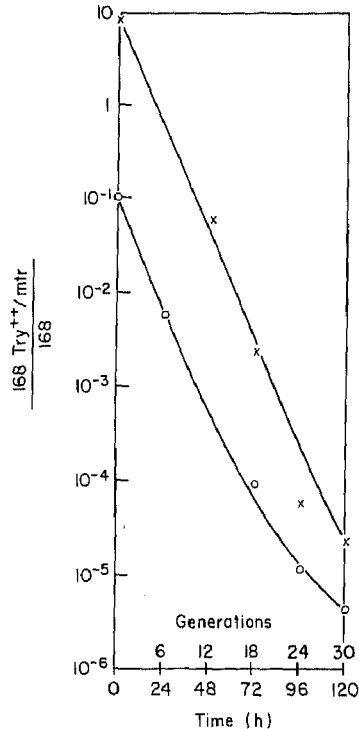

Fig. 17.

Figs 15-17. Change in the ratio of cell numbers of *B. subtilis* strains when grown together in continuous culture. The two curves in Fig. 15 and Fig. 17 refer to two different starting ratios. See text for strain designation. Mean viability was over 90%. From Zamenhof & Eichhorn (1967).

strains. Lwoff (1944) in his study of the establishment of parasitism anticipated that, on adequate media, auxotrophic mutants could have a selective advantage over prototrophic parents because of energetic economy. Such an advantage can be expected to be expressed in the chemostat where the auxotrophic mutant should outgrow its parent and thus become dominant. This concept was experimentally tested by Zamenhof & Eichorn (1967). When the histidine requiring (his^-) mutant 21 of *Bacillus subtilis* strain 168 was grown together with its histidine non-requiring spontaneous back-mutant (his^+), in the presence of 0.32 mM L-histidine, it had a strong selective advantage over his^+ (Fig. 15). The curves are essentially parallel regardless of the initial ratio of the two strains, indicating that the auxotroph his^- has an intrinsic selective advantage over its prototrophic parent his^+ and is not producing an inhibitor against his^+ . The non-involvement of inhibitors in the selection process is further suggested by the generality of the phenomenon: a similar behaviour was found for an indole requiring auxotroph (ind^-) and indole positive prototroph when grown together in the presence of 0.25 mM L-tryptophan. The energetic economy in auxotrophs is expected to be greater when the block in the biosynthetic pathway is relatively early (when a relatively large number of reactions have become redundant) as compared to a late block. Accordingly, an anthranilate-requiring ($anth^-$) strain was able to outgrow a tryptophan-requiring strain (trp^-), lacking tryptophan synthetase, in less than 48 h in a medium containing 0.25 mM L-tryptophan (Fig. 16).

In the presence of tryptophan in the medium the synthesis of tryptophan is repressed in wild type *Bacillus subtilis*, although some tryptophan synthetase is still made and some tryptophan synthesis may continue. However, a 'de-repressed' mutant, which continues to synthesize tryptophan at a high rate in the presence of the amino acid in the growth medium is expected to be at a selective disadvantage when grown together with the wild type in tryptophan containing media. That this is indeed the case was shown in an experiment in which a de-repressed spontaneous mutant, which excreted tryptophan (168 try^{++}/mtr) was grown together with its wild type parent (168) in unsupplemented basal medium (Fig. 17). Again the result was independent of the initial proportion of the two strains. These studies show that 'metabolite economy' may have led to the selection of micro-organisms exhibiting complex growth requirements: non-exacting organisms growing in environments rich in amino acids and other growth factors, would be overgrown by auxotrophic mutants. Initially such mutants may have resulted from point mutations only. In that case the structural gene, the messenger RNA and in many cases the inactive enzyme protein itself still have to be manufactured. However, if such mutations were deletions resulting in the elimination of a DNA segment and the shortening of the chromosome, additional advantages may have included faster replication of the chromosome and saving on sugars, bases, amino acids and ATP, otherwise required to synthesize this portion of DNA, m-RNA and protein. It follows that a mutant with a deletion would be at an advantage over a point mutant. Such mechanisms could account for the complete disappearance of certain genes during the process of evolution.

C. Mutants containing mutator genes

The spontaneous mutation rate in different organisms is under genetic control and mutants have been isolated which exhibit increased or decreased mutation frequencies. A mutant gene is called a mutator, if it increases the mutation rate, and antimutator, if it

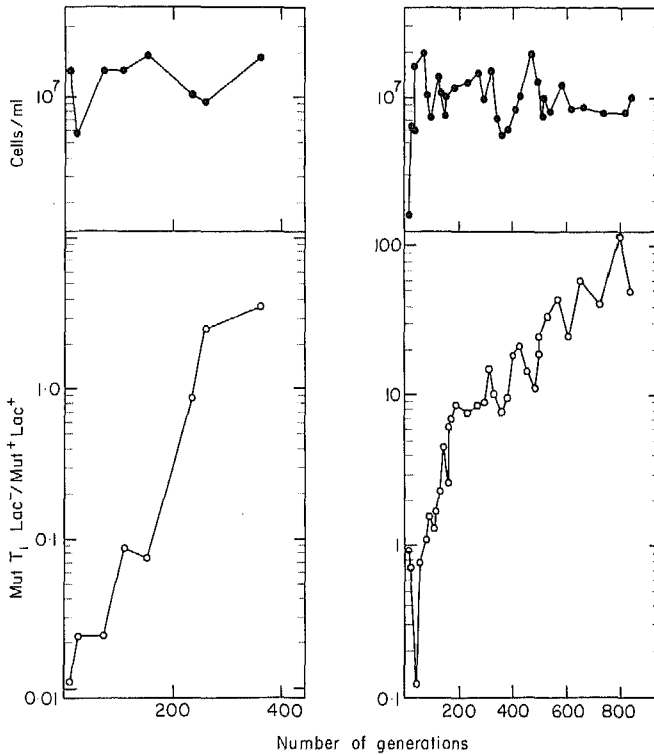

Fig. 18. Two competition experiments between strains of *Escherichia coli* under glucose limitation. The cell density (●) and $\text{mutT}_1/\text{mut}^+$ ratio (○) are plotted as a function of number of generations. From Cox & Gibson (1974).

decreases this rate. The basis of these mutations appears to be alteration of DNA polymerase, so that more or less errors occur during DNA replication (Muzyczka *et al.* 1972; Hershfield & Nossal 1973).

Increased capacity to give rise to mutants would increase adaptability of a population, but it would also increase the frequency of potentially harmful mutations. Would natural selection, therefore, select for or against increased mutation rates? Cox & Gibson (1974) and Nestmann & Hill (1973) have approached this question using the continuous culture technique. When wild type *E. coli* (Mut^+) and a mutator mutant (MutT_1) were grown in the chemostat under glucose limitation, the mutator mutant had a decisive advantage over the wild type (Fig. 18; Gibson *et al.* 1970; Cox & Gibson 1974). Ability to utilize lactose was used as the marker to distinguish the two strains. Two lines of evidence suggested that the selective advantage of MutT_1 resided in its increased mutation rate and not in some intrinsic property of the mutator gene. First, the MutT_1 population winning the competition possessed features absent from parent MutT_1 , as well as Mut^+ populations. For instance, the competed MutT_1 population showed increased stickiness to glass and/or increased resistance to glucose starvation compared to the parent MutT_1 or Mut^+ populations. Secondly, loss of the mutator gene from such competed MutT_1 populations did not lead to the loss of these features. It

appears therefore that increased mutation rates conferred a selective advantage on these populations.

5. Concluding Remarks

The work discussed in this review amply demonstrates the unique possibilities of the continuous culture technique in microbial selection. An important contribution of these studies is the knowledge concerning the existence, in natural environments, of bacteria possessing crossing substrate saturation curves. This finding strongly suggests that the micro-organisms, which are important in carrying out various transformations in many natural environments, are different from the type likely to be selected in batch enrichments. Further studies are needed to test the general validity of this concept: for instance, only scant knowledge is available on selection of chemolithotrophs towards the concentration of the lithotrophic energy source, or the selection of aerobes towards oxygen concentration. Continuous culture also affords the possibility of investigating, at a fixed substrate concentration, the influence of additional parameters, such as pH, temperature, O_2 tension, light intensity, etc. on the outcome of microbial competition. This feature so far has had limited application, but the few studies which have made use of this feature have been fruitful in yielding information on fundamental ecological principles.

The ability to obtain, and maintain over long periods of time, a desired set of environmental conditions in the culture vessel, and the 'open' nature of the continuous culture enable one to screen a large number of mutants rapidly with a view to selecting one better adapted to these conditions. This potential of the continuous culture is well illustrated by the ease with which 'hyper-mutants' possessing large concentrations of a substrate-capturing enzyme, have been isolated, and is of considerable interest in screening natural or induced mutants capable of attacking biologically recalcitrant molecules. A further area in which a continuous culture is indispensable, is in the study of the correlation between specific mutation and the ability to compete in a given set of environmental conditions. Such studies are of interest in investigating what traits will have survival value in specific environments.

6. References

- BARMAN, Th. E. 1969 *Enzyme Handbook* I and II. Berlin, Heidelberg & New York: Springer Verlag.
- BEIJERINCK, M. W. 1921-1940 *Verzamelde geschriften*. Den Haag: Nijhoff.
- CLARKE, P. H. 1974 The evolution of enzymes for the utilization of novel substrates. In *Evolution of the microbial world*, 24th Symposium of the Society for General Microbiology, pp. 183-217. London & New York: Cambridge University Press.
- COX, E. C. & GIBSON, T. C. 1974 Selection for high mutation rates in chemostats. *Genetics* 77, 169-184.
- DEAN, A. C. R. 1972 Influence of environment on the control of enzyme synthesis. *Journal of Applied Chemistry and Biotechnology* 22, 245-259.
- DUURSMA, E. K. 1965 The dissolved organic constituents of sea water. In *Chemical oceanography* vol. 1, ed. Riley, J. P. & Skirrow, G., pp. 433-475. London & New York: Academic Press.

- EDWARDS, V. H. 1970 The influence of high substrate concentrations on microbial kinetics. *Biotechnology and Bioengineering* **12**, 679–712.
- GIBSON, T. C., SCHEPPE, M. L. & COX, E. C. 1970 Fitness of an *Escherichia coli* mutator gene. *Science* **169**, 686–688.
- HARDER, W. & VELDKAMP, H. 1971 Competition of marine psychrophilic bacteria at low temperatures. *Antonie van Leeuwenhoek* **37**, 51–63.
- HARTLEY, B. S. 1974 Enzyme families. In *Evolution in the microbial world*. 24th Symposium of the Society for General Microbiology, pp. 151–182, London & New York: Cambridge University Press.
- HARTLEY, B. S., BURLEIGH, B. D., MIDWINTER, G. G., MOORE, C. H., MORRIS, H. R., RIGBY, P. W. J., SMITH, M. J. & TAYLOR, S. S. 1972 Where do enzymes come from? In *Enzymes: Structure and Function*. 8th FEBS Meeting, ed. Drenth, J., Oosterbaan, R. A. & Veeger, C. Ch. 29, pp. 151–176, Amsterdam: North Holland.
- HERBERT, D., ELSWORTH, R. & TELLING, R. C. 1956 The continuous culture of bacteria: a theoretical and experimental study. *Journal of General Microbiology* **14**, 601–622.
- HERSHFIELD, M. S. & NOSSAL, N. G. 1973 *In vitro* characterization of a mutator T₄ DNA polymerase. *Genetics* **73** (Suppl.), 131–136.
- HORIUCHI, T., TOMIZAWA, J. & NOVICK, A. 1962 Isolation and properties of bacteria capable of high rates of β -galactosidase synthesis. *Biochimica et Biophysica Acta* **55**, 152–163.
- HUNGATE, R. E. 1962 Ecology of bacteria. In *The Bacteria* vol. IV, pp. 95–119, New York: Academic Press.
- JANNASCH, H. W. 1967 Enrichment of aquatic bacteria in continuous culture. *Archiv für Mikrobiologie* **59**, 165–173.
- JANNASCH, H. W. & MATELES, R. I. 1974 Experimental bacterial ecology studied in continuous culture. *Advances in Microbial Physiology* **11**, 165–212.
- KUENEN, J. G. & VELDKAMP, H. 1973 De chemostaat als hulpmiddel bij de studie van de oecologie van bacteriën. *Vakblad voor Biologen* **6**, 100–104.
- KUENEN, J. G., BOONSTRA, J., SCHRÖDER, H. G. J. & VELDKAMP, H. 1977 Competition for inorganic substrates among chemoorganotrophic and chemolithotrophic bacteria. *Microbial Ecology*, **3**.
- LERNER, S. A., WU, T. T. & LIN, E. C. C. 1972 Evolution of a catabolic pathway in bacteria. *Science* **146**, 1313–1315.
- LWOFF, A. 1944 *L'évolution physiologique. Etude des pertes de fonctions chez les microorganismes* Paris: Hermann.
- MATIN, A. & VELDKAMP, H. 1974 Physiological basis of high substrate affinity. *ASM Abstracts*, p. 50.
- MEERS, J. L. 1973 Growth of bacteria in mixed cultures. *CRC Critical Reviews of Microbiology* **2**, 139–184.
- MONOD, J. 1942 *Recherches sur la croissance des cultures bactériennes* Paris: Hermann.
- MONOD, J. 1949 The growth of bacterial cultures. *Annual Review of Microbiology* **3**, 371–394.
- MONOD, J. 1950 La technique de culture continu; théorie et applications. *Annales de l'Institut Pasteur* **79**, 390–410.
- MOSER, H. 1958 *The dynamics of bacterial populations maintained in the chemostat*. Carnegie Institute of Washington, Publication 614, Washington D.C.
- MUZYCZKA, N., POLAND, R. L. & BESSMAN, M. J. 1972 Studies on the biochemical basis of spontaneous mutation. I. A comparison of the DNA polymerases of mutator, antimutator and wild type of bacteriophage T4. *Journal of Biological Chemistry* **247**, 7116–7122.
- NESTMANN, E. R. & HILL, R. F. 1973 Population changes in continuously growing mutator cultures of *Escherichia coli*. *Genetics* **73** (Suppl.), 41–44.
- NOVICK, A. 1961 Bacteria with high levels of specific enzymes. In *Growth in living systems* Purdue Growth Symposium, pp. 93–106, New York: Basic Books Inc.
- NOVICK, A. & SZILARD, L. 1950a Description of the chemostat. *Science* **112**, 715–716.
- NOVICK, A. & SZILARD, L. 1950b Experiments with the chemostat on spontaneous mutation of bacteria. *Proceedings of the National Academy of Sciences (Washington)* **36**, 708–719.
- PAWLOWSKY, H. & HOWELL, J. A. 1973 Mixed culture biooxidation of phenol. I. Determination of kinetic parameters. *Biotechnology and Bioengineering* **15**, 889–896.

- PFENNIG, N. & JANNASCH, H. W. 1962 Biologische Grundfragen bei der homokontinuierlichen Kultur von Mikroorganismen. *Ergebnisse der Biologie* **25**, 93–135.
- POWELL, E. O. 1958 Criteria for growth of contaminants and mutants in continuous culture. *Journal of General Microbiology* **18**, 259–268.
- POWELL, E. O. 1967 Growth rate of microorganisms as a function of substrate concentration. In *Microbial physiology and continuous culture* ed. Powell, E. O., Evans, C. G. T., Strange, R. E. & Tempest, D. W., pp. 34–56, Her Majesty's Stationery Office.
- RIGBY, R. W. J., BURLEIGH, B. D. & HARTLEY, B. S. 1974 Gene duplication in experimental enzyme evolution. *Nature, London* **251**, 200–204.
- SCHLEGEL, H. G. & JANNASCH, H. W. 1967 Enrichment cultures. *Annual Review of Microbiology* **21**, 49–70.
- SHEEHAN, B. T. & JOHNSON, M. J. 1971 Production of bacterial cells from methane. *Applied Microbiology* **21**, 511–515.
- SILVER, R. S. & MATELES, R. I. 1969 Control of mixed substrate utilization in continuous cultures of *Escherichia coli*. *Journal of Bacteriology* **97**, 535–543.
- SNEDECOR, B. & COONEY, C. L. 1974 Thermophilic mixed culture of bacteria utilizing methanol for growth. *Applied Microbiology* **27**, 112–117.
- TEMPEST, D. W. 1970 The continuous cultivation of micro-organisms. In *Methods in Microbiology* vol. 2, ed. Norris, J. R. & Ribbons, D. W., pp. 259–276. London & New York: Academic Press.
- VAN GEMERDEN, H. 1974 Coexistence of organisms competing for the same substrate: an example among the purple sulfur bacteria. *Microbial Ecology* **1**, 104–119.
- VAN GEMERDEN, H. & JANNASCH, H. W. 1971 Continuous culture of Thiorhodaceae. Sulfide and sulfur limited growth of *Chromatium vinosum*. *Archiv für Mikrobiologie* **79**, 345–353.
- VAN NIEL, C. B. 1949 "The Delft School" and the rise of general microbiology. *Bacteriological Reviews* **13**, 161–174.
- VAN NIEL, C. B. 1955 Natural selection in the microbial world. *Journal of General Microbiology* **13**, 201–217.
- VELDKAMP, H. 1970 Enrichment cultures of prokaryotic organisms. In *Methods in Microbiology* vol. 3A, ed. Norris, J. R. & Ribbons, D. W., pp. 305–361, London & New York: Academic Press.
- VELDKAMP, H. 1976 "Continuous culture in microbial physiology and ecology" Shildon, Co. Durham: Meadowfield Press.
- VELDKAMP, H. & JANNASCH, H. W. 1972 Mixed culture studies with the chemostat. *Journal of Applied Chemistry and Biotechnology* **22**, 105–123.
- VELDKAMP, H. & KUENEN, J. G. 1973 The chemostat as a model system for ecological studies. *Bulletins from the Ecological Research Committee (Stockholm)* **17**, 347–355.
- WILKINSON, T. G., TOPIWALA, H. H. & HAMER, G. 1974 Interactions in a mixed bacterial population growing on methane in continuous culture. *Biotechnology and Bioengineering* **16**, 41–59.
- WINOGRADSKY, S. 1949 *Microbiologie du sol. Oeuvres complètes* Paris: Masson.
- WIRSEN, C. O. & JANNASCH, H. W. 1970 Growth response of *Spirosoma* sp. to temperature shifts in continuous culture. *Bacteriological Proceedings* **G118**, 32.
- ZAMENHOF, S. & EICHHORN, H. H. 1967 Study of microbial evolution through loss of biosynthetic functions: establishment of "defective" mutants. *Nature, London* **216**, 456–458.