

Minimizing Air Consumption of Pneumatic Actuators in Mobile Robots

Grzegorz GRANOSIK^{1,2} and Johann BORENSTEIN¹

¹Dept. of Mechanical Engineering
The University of Michigan
Ann Arbor, MI, USA
granosik@umich.edu, johannb@umich.edu

²Institute of Automatic Control
Technical University of Łódź
Łódź, POLAND

Abstract—This paper introduces a new control method for pneumatic actuators, called “Proportional Position and Stiffness (PPS)” controller. The PPS method provides both position and stiffness control for a robot joint driven by a pneumatic cylinder with four ON-OFF valves. In addition, the proposed control system consumes much less compressed air than comparable strategies. These features make the PPS method highly suitable to applications on mobile robots.

Keywords: mobile robots, pneumatics, compliant, energy efficiency, nonlinear systems.

I. INTRODUCTION

Actuators and pneumatic controllers are of interest for robotic applications because of their large power output and relatively low cost. Additionally, pneumatic actuators are clean and lightweight. For these reasons pneumatic actuation has become a reasonable substitute for electric actuation special mobile robotics applications. For example, Pack et al. [1997] developed the ROBIN “climbing inspector” – probably the first robot that used McKibben-type pneumatic muscles for actuation. A different type of artificial muscles was incorporated by Berns et al. [2001] to actuate the legs of the *Airbug* six-legged insect-like robot and by Verrelst et al. [2002] in a biped robot. Aracil et al [1999] and Saltaren et al 1999 proposed the application of a Gough-Stewart platform as a climbing robot. In this application, both the gripper and the extension units are actuated by classic pneumatic cylinders. Pneumatic cylinders are also used in the eight-legged Robug IV designed by Cooke et al. [1999]. In a

review of novel actuation techniques in walking and climbing machines, Fukuda et al. [1999] presented several robots with pneumatic actuators. Schultz et al. [2001] proposed the concept of biological-inspired eight-legged robot with compliant joints and actuated by expanding fluidic actuators. A system with pneumatically driven gait orthosis was developed by Belforte et al. [2001], and a pneumatically driven biped robot was developed by Guihard and Gorce, [2001a]. Rachkow et al. [2002] presented a frame-type climbing robot driven by pneumatic cylinders and rotary pneumatic actuators.

Yet another type of actuation is required for one specific class of mobile robots, so-called “serpentine” robots. One such robot, called “OmniPede” (shown in Figure 1), was developed at the University of Michigan’s Mobile Robotics Lab [Long, Anderson, and Borenstein 2002] for the study of serpentine robot actuation.

Unlike conventional mobile robots, serpentine robots need mechanical power not only for propulsion, but also to actuate their joints. In the OmniPede, pneumatic cylinders are used to actuate the 2-DOF articulate joints that connect the segments. Active and controlled changes of angles between segments are needed for steering or for lifting lead segments to a desired height, for example to climb up a stair. Another important function of the joints is to give each segment maximal traction, by letting the robot body conform compliantly to the terrain.

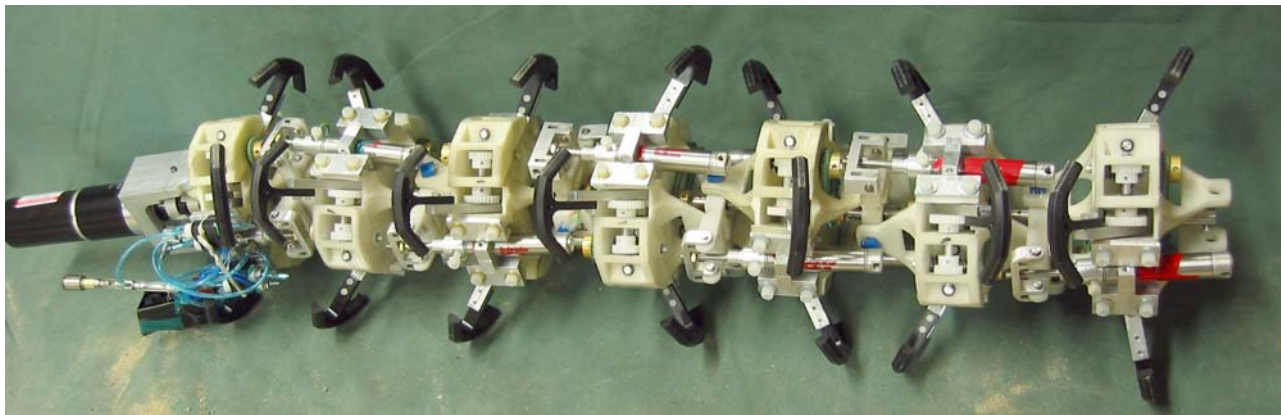

Figure 1. UM’s seven-segment OmniPede prototype. An electric motor (left side in the photograph) powers an articulate drive shaft “spine,” which provides mechanical power to all feet (black parts) through a five-bar mechanism. Segments are linked by 2-DOF articulate joints that are actuated by pneumatic cylinders.

¹ This work was conducted at the University of Michigan’s Mobile Robotics Lab and funded by the U.S. Department of Energy under Award No. DE-FG04-86NE3796

Pneumatic actuation has a fundamental advantage over electromechanical actuation because stiffness of the joints can be controlled easily by the pressure of the compressed air applied to the cylinders. However, pneumatic actuation is not as straightforward as electromechanical actuation. Pneumatic systems require a source of compressed air, multiple valves, and control methods for those valves. The supply of compressed air is of particular concern for mobile robots – unless, of course, they are tethered. Truly autonomous, untethered robots have to produce their own compressed air from very limited on-board resources, thus increasing weight, requiring space, and consuming energy.

Many advanced methods, which allow the proportional control of pneumatic actuators, were introduced in recent years [Richard and Scavarda, 1996; Van Varseveld and Bone, 1997; Bobrow and McDonell, 1998; Brockmann et al., 1999; Richer and Hurmuzlu, 2000; Outbib and Richard, 2000; Chillari et al., 2001; Guihard and Gorce, 2001b]. Common to these publications is that is that their authors mostly focused on the quality of the position control, paying less attention to the energy efficiency of the proposed controllers and their consumption of compressed air. This is not a problem in conventional (i.e., industrial) pneumatic systems where there is usually a local source of compressed air that can provide an almost unlimited supply of compressed air at little cost.

In this paper we examine the consumption of compressed air during the proportional control of on-off valves with conventional PWM methods. We then introduce a new control method that significantly reduces the amount of compressed air wasted for control purposes, and thereby increases overall energy efficiency. Furthermore, our new control method not only allows accurate proportional control of joints, but it also allows for the control of stiffness of the joints.

II. PNEUMATIC ACTUATORS

The dynamics of a pneumatic cylinder (see Figure 2) can be described using Newton's principle:

$$m\ddot{x} = P_c - F_T - F \quad (1)$$

where:

m – mass,

x – piston's position,

$P_c = p_1 A_1 - p_2 A_2$ – pneumatic force,

p_1, p_2 – pressures,

F_T – friction force,

F – load force,

A_1, A_2 – cross-section areas.

The dynamics of compressed air in the chambers of the cylinder is described by [Shearer 1956]:

$$\begin{aligned} \dot{p}_1 &= \frac{kRT\dot{m}_1}{V_1} - \frac{kp_1\dot{V}_1}{V_1} \\ V_1 &= A_1 x + V_{01} \\ \dot{p}_2 &= \frac{kRT\dot{m}_2}{V_2} - \frac{kp_2\dot{V}_2}{V_2} \\ V_2 &= A_2 (S - x) + V_{02} \end{aligned} \quad (2)$$

where:

k, R – ratio of specific heats (for air $k=1.4$) and gas constant respectively,

T – temperature,

V_1, V_2, V_{01}, V_{02} – volumes of the chambers and the fixed volumes on the end of the chambers respectively,

$p_1, p_2, \dot{p}_1, \dot{p}_2$ – pressures in chambers and first derivatives of pressures in chambers respectively,

S – stroke length,

\dot{m}_1, \dot{m}_2 – air mass flow rates.

The literature on pneumatic control using ON-OFF valves usually assumes one of the following two circuits, which we will refer to as the “conventional” methods, in order to set them apart from our proposed circuit. (1) Van Varseveld and Bone [1997] proposed a system containing two valves per cylinder and compared four different control strategies; (2) Chillari, Guccione and Muscato [2001] tested six different control strategies in a system containing four valves per cylinder. Both research teams achieved comparable positioning precision with their systems, but neither focused on air consumption during trajectory execution. It is thus difficult to quantitatively judge the overall energy efficiency of these systems. However, we can assume that in the 2-valve system the valves switch airflow

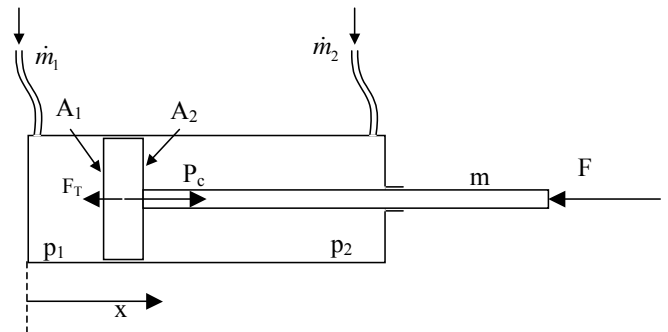

Figure 2. Pneumatic cylinder and nomenclature.

from “charging” to “exhausting” all the time so the average pressure in the chamber depends on the duty cycle of the controlling pulses. Air flows all the time even during steady state motion or after reaching the final position. The 4-valve system can produce an extended set of states, including states with closed chambers. When the cylinder reaches the reference position with the desired accuracy, then both chambers can be closed to stop airflow and thus air consumption.

III. PROPORTIONAL CONTROL SYSTEMS

As both papers mentioned in the previous section give comparable accuracy we decided to base our experiments on the same setup but to extend our analysis to include air consumption. The first case with two ON-OFF valves seems to be the least expensive solution for implementing proportional control of a pneumatic cylinder; it requires only two valves and position feedback. We choose this system as a reference. The second system contains a total of four valves and offers a potential reduction of compressed air consumption. The pneumatic circuit of such a system can be realized with 3-way valves, as shown in Figure 3. We combined this hardware with a new control law shown in Figure 4. Because of its unique dual proportional control, we call our system “*Proportional Position and Stiffness (PPS)*” controller.

The basic control method for proportional pneumatic control is based on the linear approximation of the drive’s model around the midstroke position and tuning the linear regulator [Liu and Bobrow 1988]. Usually three state variables are used for feedback: position, velocity, and acceleration or pressure difference. However, control laws based on the linear model fail when the model is a poor estimate, when the supply pressure varies, or when the cylinder works far from midstroke. To overcome these drawbacks, Kunt and Singh [1990] proposed a linear time-varying model, Richard and Scavada [1996] proposed a nonlinear model of pneumatic actuators, and McDonell and Bobrow [1998] proposed an adaptive control approach. Other solutions that do not require nonlinear modeling employ fuzzy logic [Shih and Ma, 1998] or genetic algorithms [Jeon et al., 1998]. Moreover, very good results are reported by Surgenor and Vaghan [1997] and Pandian et al [1997] from experiments with so-called “sliding mode” control. However, again none of publications include data on

air consumption. In order to analyse the minimization of compressed air consumption we decided to model the pneumatic drive as accurately as possible and then investigate ways of implementing savings.

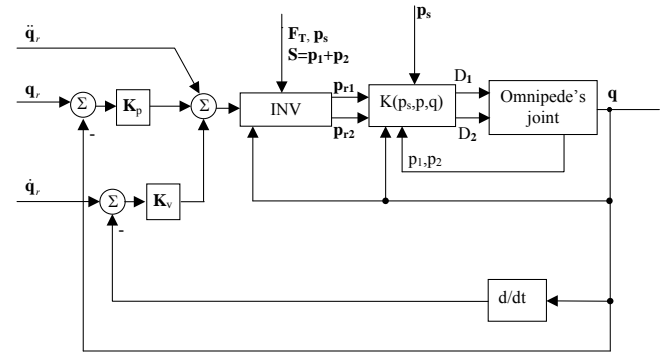

Figure 4. Control algorithm with inverse dynamics of pneumatic system

Our proposed control algorithm is based on the dynamic model of Eq. (1). This model is generally referred to as the “inverse model” [Craig 1989] and therefore shown as block “INV” in Figure 4. Block INV incorporates Eq. (1), which describes the forces in a pneumatic cylinder, and, in addition, the sum of pressures, $S = p_1 + p_2$, on both sides of the cylinder. S is directly related to the stiffness of the pneumatic actuator [Liu et al. 1996; Granosik and Jezierski, 1999]. Block INV generates reference values p_{r1} and p_{r2} for the lower level controller.

To be consistent we used the model of dynamics of compressed air in the chambers of the cylinder expressed by Eq. (2) to build the pressure regulator. We adapted the concept presented by Bobrow and McDonell [1998] to model the dynamics of airflow through ON-OFF valves. We measured the flow rate of the ON-OFF valves as a function

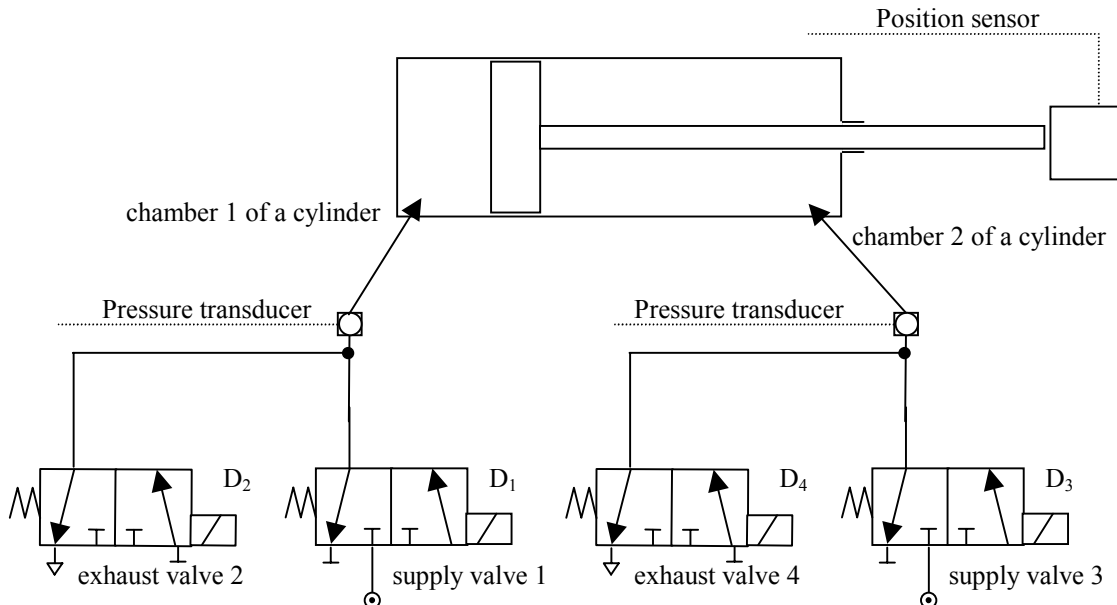

Figure 3. Pneumatic circuit for our *Proportional Position and Stiffness (PPS)* controller with zero air consumption at steady state.

of pressure in a chamber. In addition, we approximated experimental data by a square root functions

$$\begin{aligned} G_s &= RkT\dot{m}_s = A_s\sqrt{p_s - p} \\ G_e &= RkT\dot{m}_e = A_e\sqrt{p} \end{aligned} \quad (3)$$

where:

G_s, G_e – air flow into and out of the chamber during charging and exhausting, respectively

$A_s = 68$ – coefficients estimated using the least square method.
 $A_e = -72$

We used the dynamic models of compressed air Eq. (2) and (3) to obtain the pressure control law

$$\begin{aligned} G &= RkT\dot{m} = kp\dot{V} + K_pVe_p + K_DV\dot{e}_p \\ D &= G \frac{D_p}{A_s\sqrt{p_s - p}} \quad \text{if } G > 0 \\ D &= G \frac{-D_p}{A_e p} \quad \text{if } G < 0 \end{aligned} \quad (4)$$

where:

D – length of a pulse in the pulse width modulated controller. Four different signals $D_1 - D_4$ control the respective valves as shown in Figure 3. D is always a fraction of period $D_p = 30$ ms.

e_p, \dot{e}_p – pressure regulation error and its first derivative, respectively,

K_p, K_D – proportional and derivative coefficients, respectively.

Pressures p_1 and p_2 are controlled in our system by means of pulse width modulation (PWM). The PWM control law is realized in block $K(p_s, p, q)$ in Figure 4. The PWM controller functions by modifying the fraction of time D , during which certain valves of Figure 3 are open during every PWM interval D_p . In order to explain how the fraction of time D is computed in every sampling interval a variable G is defined. G is proportional to mass airflow and its sign describes the direction of airflow. A positive value for G indicates that air is being supplied to the bellows and that valve number 1 or 3 (see Figure 3) are opened. A negative value for G indicates that air is being exhausted and that valves 2 or 4 are opened.

IV. PNEUMATIC ACTUATOR TESTBED

In order to develop the desired air flow-minimizing control method we built the testbed shown in Figure 5. The purpose of the testbed was to compare three control methods with regard to air consumption. Each method comprised a pneumatic circuit and a control strategy. Two control methods represented a “conventional” approach; the other was the method proposed here. The pneumatic components used in both circuits consisted of a double acting cylinder with 9/16” bore size and 1.5” stroke length (Schrader

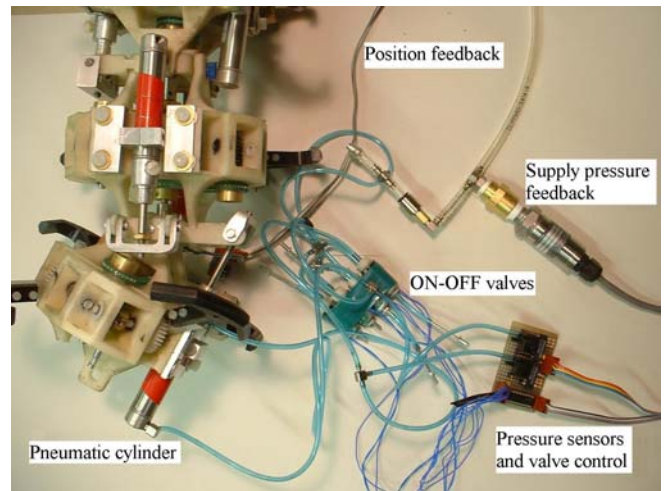

Figure 5. Proportional position and stiffness control test bed

Bellows), 3-way 2-state valves 407C3412100V (ASCO Scientific), pressure sensors SX100DD4 (SenSym ITC) and MSP-600-100-P-4-N-1 (MSI), and airflow transducer AWM5104VN (Honeywell). Each of the controllers was implemented on a Pentium-based PC running at 100 MHz. The actual pressure in both chambers of the cylinder as well as the supply pressure and the actual position of the actuator were measured as feedback signals. In addition, we measured the actual airflow to compare the air consumption with the three compared methods.

A. Experiments

In order to compare the three control methods, we conducted a series of experiments. In each experiment the joint was rotated from an angle of 13° to an angle of -20° within 3 seconds (the total range of the motion of this joint was $+25^\circ$ to -25°). The joint was then returned and stabilized in its original position during 2 seconds. The trajectory of the position was described as a 3rd order polynomial to avoid discontinuity of the joint velocity. These movements were repeated twice, so that the whole cycle lasted 20 seconds. The whole cycle is shown in upper parts of Figure 6-8. All methods performed comparably and with reasonably good accuracy in terms of position trajectory following. However, we were mostly interested in another factor – the total consumption of compressed air per cycle. To measure this parameter we employed a mass flow sensor with which total air consumption during a test was calculated as

$$flow = \int flowrate \cdot dt \quad (5)$$

Figure 6 shows the data gathered from a conventional proportional pneumatic control system containing 2 ON-OFF valves per cylinder. It results in continuous airflow, even during steady states, causing total air consumption on the level of 3.4SL (standard liter) per cycle (see bottom part of Figure 6).

We obtained better results with the implementation of the controller described by Chillari et al. [2001], shown in Figure 7. Here we used a set of two digital valves per chamber (four per cylinder) and a PID controller, which shut off airflow

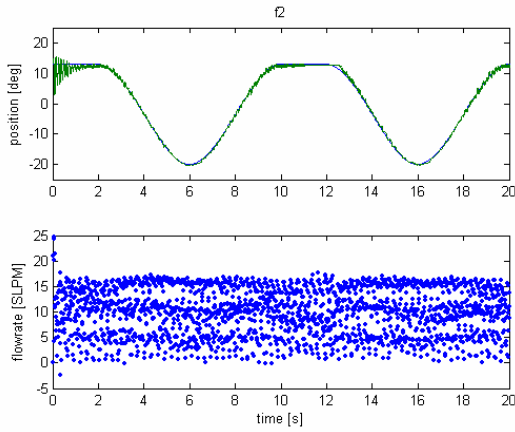

Figure 6. Position control - two 3/2 valves per cylinder
 $flow = 3.37$ SL

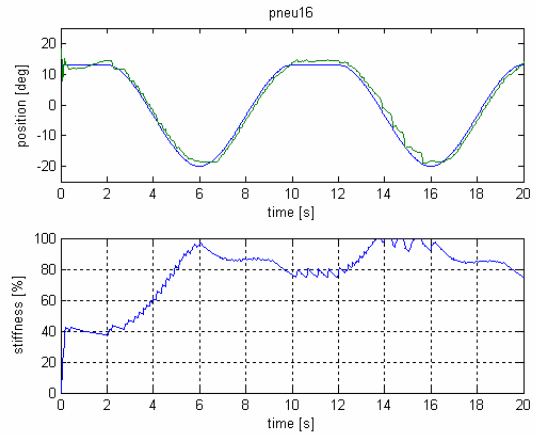

Figure 9. Position control - four 3/2 valves per cylinder (stiffness not controlled)

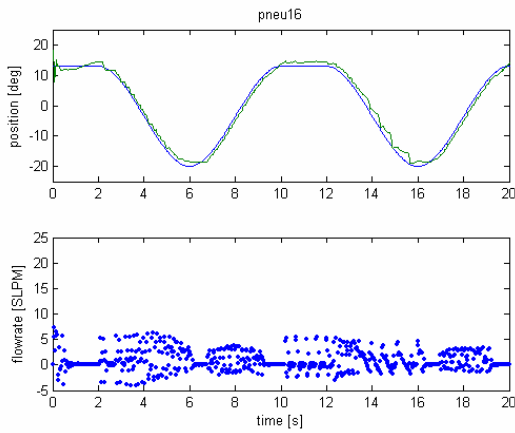

Figure 7. Position control - four 3/2 valves per cylinder
 $flow = 0.40$ SL

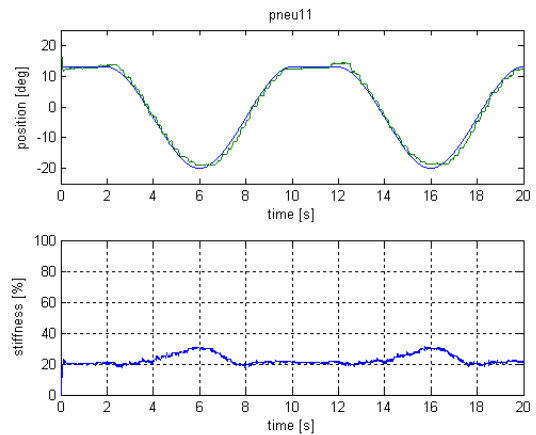

Figure 10. Position and stiffness model based control - four 3/2 valves per cylinder stiffness level – 20%

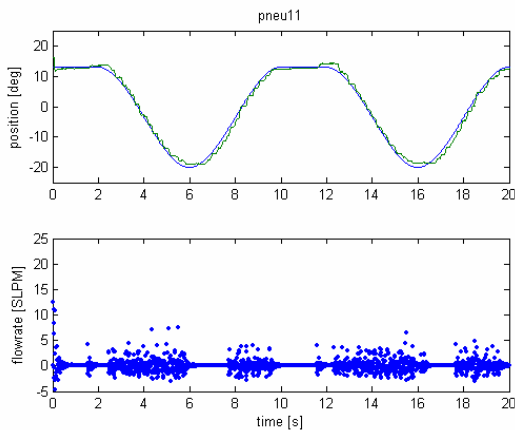

Figure 8. Position and stiffness model based control - four 3/2 valves per cylinder $flow = 0.11$ SL

when the position error reached a reasonable minimum. In this case the total air consumption was on the level of 0.4SL per cycle. However, the best results we obtained with our PPS control system (see Figure 8), where total air consumption was reduced to 0.11SL per cycle.

In addition to the reduction in air consumption, our PPS control algorithm provides simultaneous position and stiffness control. This feature provides full control over the

behavior of the pneumatic actuator and employs all advantages of a four-valves-per-cylinder system. Figure 9 and Figure 10 compare the stiffness of a cylinder for position control using the second method and our PPS control.

In the absence of stiffness control (see Figure 9), the stiffness of the cylinder varies arbitrarily as a function of position. Figure 10 shows that our PPS controller maintains a near-constant stiffness of 20% (as was commanded in this experiment). In our controller stiffness doesn't have to be constant, it can change in the full range of 0%-100% under computer control.

Based on these experiments we estimate that the total demand for compressed air for the typical movements of a serpentine robot like the OmniPede is on the order of 3SL/min. An off-the-shelf compressor that can supply the maximum flow rate, maximum working pressure, and has still sufficiently small dimensions is the NPK09 made by [KNF].

V. CONCLUSIONS

This paper focused on an aspect of pneumatic actuation that is usually neglected in the scientific literature: compressed air expenditure. We identified possible sources of savings of compressed air consumption:

- through nonlinear modeling of airflow;
- by considering the dynamics of the cylinder, and
- by calculating the exact times and sequences of ON-OFF valve control.

Our proposed control law based on the inverse model approach resulted in a substantial reduction in compressed air consumption comparing with linear PID controller. The new control strategy will allow us to use pneumatic drives even on autonomous, untethered robots. An additional advantage of our approach is that with four 3/2 digital valves per cylinder we can control not only the position, but also the stiffness of the robot's joints. This allows us to change the behavior of those joints during the robot's mission. For example, the joints of a serpentine robot could be stiff when traversing a gap, or limp and thus compliant, to conform to irregular terrain.

Acknowledgements

This work was funded by the U.S. Department of Energy under Award No. DE-FG04-86NE3796.

REFERENCES

- [1] ARACIL R., Saltarén R., Sabater J.M., "TREPA, parallel climbing robot for maintenance of palm trees and large structures," Proc. of 2nd Int. Conference on Climbing and Walking Robots, 453-461, Portsmouth 1999.
- [2] BELFORTE G., Gastaldi L., Pastorelli S., Sorli M., "Active gait orthosis with pneumatic proportional control," 4th Int. Conference on Climbing and Walking Robots CLAWAR, pp. 47-54, Germany 2001.
- [3] BERNS K., Albiez J., Kepplin V., Hillenbrand C. "Airbug - insect-like machine actuated by fluidic muscle," 4th Int. Conf. on Climbing and Walking Robots CLAWAR, pp. 237-244, Germany 2001.
- [4] BOBROW J.E., McDonell B.W., "Modeling, identification, and control of a pneumatically actuated, force controllable robot," IEEE Transactions on Robotics and Automation vol.14, no.5, pp. 732-741, 1998.
- [5] BROCKMANN W., Kohne J., "Towards high-speed, motion control of pneumatic actuators with low-cost valves," 4th Int. Conference on Climbing and Walking Robots CLAWAR, pp. 339-346, Germany 2001.
- [6] CHILLARI S., Guccione S., Muscato G., "An Experimental Comparison Between Several Pneumatic Position Control Methods," Proc. of the 40th IEEE Conf. on Decision and Control, pp. 1168-1173, USA 2001.
- [7] COOKE D.S., Hewer N.D., White T.S., Galt S., Luk B.L., "Implementation of modularity in Robug IV preliminary result," Proc. of 2nd Int. Conference on Climbing and Walking Robots, 393-403, Portsmouth 1999.
- [8] CRAIG J.J., "Introduction to robotics," Addison-Wesley Publishing Company, Inc. 1989.
- [9] FUKUDA T., Kurashige K., Arai F., "Recent topics on robotic actuation technologies," Proc. of 2nd Int. Conference on Climbing and Walking Robots, 3-15, Portsmouth 1999.
- [10] GRANOSIK G., Jezierski E., "Application of a maximum stiffness rule for pneumatically driven legs of walking robot," Proc. of 2nd Int. Conference on Climbing and Walking Robots, pp.213-218, Portsmouth 1999.
- [11] GUIHARD M., Gorce P., "Dynamic control of a biomechanical inspired biped - BIPMAN," 4th Int. Conference on Climbing and Walking Robots CLAWAR, pp. 39-45, Germany 2001a.
- [12] GUIHARD M., Gorce P., "Tracking of High Acceleration Movements with a Pneumatic Impedance Controller," Journal of Dynamic Systems, Measurement, and Control, vol. 123, pp. 549-551, 2001b.
- [13] JEON Y.S., Lee C.O. Hong Y.S., "Optimization of the control parameters of a pneumatic servo cylinder drive using genetic algorithms," Control Eng. Practice, vol.6, 847-853, 1998.
- [14] KNF Neuberger, Inc., Two Black Forest Road, Trenton, NJ 08691-1810 USA, www.knf.com.
- [15] KUNT C., Singh R., "A linear time varying model for on-off valve controlled pneumatic actuators," Transactions of the ASME. Journal of Dynamic Systems, Measurement and Control, vol.112, 740-747, 1990.
- [16] LIU S., Bobrow J.E., "An analysis of a pneumatic servo system and its application to a computer-controlled robot," Transactions of the ASME. Journal of Dynamic Systems, Measurement and Control, vol.110, pp.228-235, 1988.
- [17] LIU R., Zong G., Wang S., Bi S, "On the implementation of direct compliant control on parallel mechanism using rubberactuators," Proc. ASME Japan/USA Symposium on Flexible Automation, pp. 120-123, Boston, MA, 1996.
- [18] LONG G., Anderson J., and Borenstein J., "The OmniPede: A New Approach to Obstacle Traversal," Proc. 2002 IEEE International Conference on Robotics and Automation, pp. 714-719, USA 2002.
- [19] OUTBIB R. Richard E., "State feedback stabilization of an electropneumatic system," Transactions of the ASME. Journal of Dynamic Systems, Measurement and Control, vol.122, pp.410-415, Sep. 2000.
- [20] PACK R.T., Joe L.C. Jr, Kawamura K., "A rubberactuator-based structure- climbing inspection robot," Proc. of 1997 IEEE Int. Conf. on Robotics and Automation, pp. 1869-1874, USA 1997.
- [21] PANDIAN S.R., Hayakawa Y., Kanazawa Y., Kamoyama Y., Kawamura S., "Practical design of a sliding mode controller for pneumatic actuators," Transactions of the ASME. Journal of Dynamic Systems, Measurement and Control, vol.119, no.4, 666-674, 1997.
- [22] RACHKOW M., Marques L., De Almeida A.T., "Climbing robots for porous and rough surfaces," 5th Int. Conference on Climbing and Walking Robots CLAWAR, pp. 1013-1020, France 2002.
- [23] RICHARD E., Scavarda S., "Comparison between linear and nonlinear control of an electropneumatic servodrive," Transactions of the ASME. Journal of Dynamic Systems, Measurement and Control, vol.118, 245-252, 1996.
- [24] RICHER E., Hurmuzlu Y., "A high performance pneumatic force system Part I and II," Transactions of the ASME. Journal of Dynamic Systems, Measurement and Control, vol.122, pp.416-434, Sep. 2000.
- [25] SALTAREN R., Aracil R., Sabater J.M., Reinoso O., Jimenez L.M., "Modelling, simulation, and conception of parallel climbing robots for construction and service," Proc. of 2nd Int. Conference on Climbing and Walking Robots, 253-265, Portsmouth 1999.
- [26] SCHULTZ S., Pylatiuk C., Brethauer G.: "Walking machine with compliant joints," 4th Int. Conference on Climbing and Walking Robots CLAWAR, pp. 231-236, Germany 2001.
- [27] SHEARER J.L., "Study of pneumatic processes in the continuous control of motion with compressed air I, II," Trans. ASME, pp. 233-249, Feb.1956.
- [28] SHIH M.C., Ma M.A., "Position control of a pneumatic rodless cylinder using sliding mode M-D-PWM control the high speed solenoid valves," JSME International Journal, Series C, vol.41, no.2, 236-241, 1998.
- [29] SURGENOR B.W., Vaughan N.D., "Continuous sliding mode control of a pneumatic actuator," Transactions of the ASME. Journal of Dynamic Systems, Measurement and Control, vol.119, 578-581, Sept.1997.
- [30] VAN VARSEVELD R.B., Bone G.M, "Accurate position control of a pneumatic actuator using on/off solenoid valves," IEEE/ASME Transactions on Mechatronics, vol.2, no.3, 195-204, 1997.
- [31] VERRELST B., Van Ham R.R., Daerden F., Lefeber D., "Design of biped actuated by pleated pneumatic artificial muscles," 5th Int. Conference on Climbing and Walking Robots CLAWAR, pp. 211-218, France 2002.