

Mitochondria recycle nitrite back to the bioregulator nitric monoxide[★]

Hans Nohl¹✉, Katrin Staniek¹, Babak Sobhian², Soheyl Bahrami², Heinz Redl² and Andrey V. Kozlov^{1,2}

¹*Institute of Pharmacology and Toxicology, University of Veterinary Medicine, Vienna, Austria;*

²*Ludwig Boltzmann Institute for Experimental and Clinical Traumatology; Vienna, Austria*

Received: 25 September, 2000; accepted: 20 November, 2000

Key words: nitrite reductase, mitochondria, nitric oxide, electron paramagnetic resonance

Nitric monoxide (NO) exerts a great variety of physiological functions. L-Arginine supplies amino groups which are transformed to NO in various NO-synthase-active isoenzyme complexes. NO-synthesis is stimulated under various conditions increasing the tissue of stable NO-metabolites. The major oxidation product found is nitrite. Elevated nitrite levels were reported to exist in a variety of diseases including HIV, reperfusion injury and hypovolemic shock. Denitrifying bacteria such as *Paracoccus denitrificans* have a membrane bound set of cytochromes (cyt *cd*₁, cyt *bc*) which were shown to be involved in nitrite reduction activities. Mammalian mitochondria have similar cytochromes which form part of the respiratory chain. Like in bacteria quinols are used as reductants of these types of cytochromes. The observation of one-e⁻ divergence from this redox-couple to external dioxygen made us to study whether this site of the respiratory chain may also recycle nitrite back to its bioactive form NO. Thus, the aim of the present study was therefore to confirm the existence of a reductive pathway which reestablishes the existence of the bioregulator NO from its main metabolite NO₂⁻. Our results show that respiring mitochondria readily reduce added nitrite to NO which was made visible by nitrosylation of deoxyhemoglobin. The adduct gives characteristic triplet-ESR-signals. Using inhibitors of the respiratory chain for chemical sequestration of respiratory segments we were able to identify the site where nitrite is reduced. The results confirm the ubiquinone/cyt *bc*₁ couple as the reductant site where nitrite is recycled. The high affinity of NO to the heme-iron of cytochrome

[★]Presented at the 5th Symposium on "Free Radicals in Biology and Medicine" Łódź, Poland, 2000.

✉Corresponding author: Prof. Hans Nohl, Institute of Pharmacology and Toxicology University of Veterinary Medicine, Veterinärplatz 1, A-1210 Vienna, Austria; phone: (43 1) 25077 4400; fax: (43 1) 25077 4490; e-mail: Hans.Nohl@vu-wien.ac.at

Abbreviations: AA, antimycin A; EDRF, endothelium derived relaxing factor; EPR, electron paramagnetic resonance; Hb, hemoglobin; NO, nitric monoxide; NOS, nitric monoxide synthase; NO₂⁻, nitrite; NO₃⁻, nitrate; RLM, rat liver mitochondria; SMP, submitochondrial particles; TTFA, thenoyltrifluoroacetone.

oxidase will result in an impairment of mitochondrial energy-production. "Nitrite tolerance" of angina pectoris patients using NO-donors may be explained in that way.

The chemical identification of the endothelium derived relaxing factor as an inorganic nitroxide together with the recognition that the respective nitric monoxide molecule (NO) is generated in biological systems has led to an explosion of new research areas [1]. It is now clear that NO plays a pivotal role in physiology, pathophysiological events and in pharmacology. The physiological functions of NO which were realized so far are much broader than those known for endothelium derived relaxing factor (EDRF) (Fig. 1). Apart from the

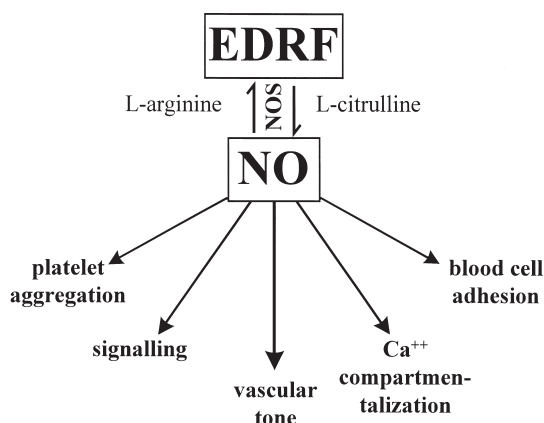

Figure 1. Main physiological functions of nitric oxide.

well established activities of the latter in the regulation of vascular blood flow and inhibition of platelet aggregation the low molecular mass bioregulator NO was recognized to control blood cell adhesion to the vascular wall to affect intracellular Ca^{2+} compartmentation, to stimulate the release of insulin from the β -cells, to control energy linked cell respiration as well as apoptosis and to interfere in cellular signalling activities.

NO by itself has a very short life time especially in biological systems [2].

The main metabolite of NO in hemoglobin-free systems is nitrite (NO_2^-) which is formed within the millisecond range.

Many pathways of NO degradation are known which yield NO_2^- (Fig. 2). However, ni-

trate (NO_3^-) is the major metabolite excreted into urine. The nitrate levels in blood are approximately 10-fold higher than those of nitrite [3–6]. One main route yielding NO_3^- from NO_2^- is a co-oxidation reaction with oxyhemoglobin that forms, in a complex sequence of reaction steps, nitrate and methemoglobin. Oxy-myoglobin can replace oxyhemoglobin in this reaction. While the stepwise oxidation of NO is well established, recycling of NO from NO_2^- was only assumed to occur in mammals [7, 8]. The aim of the present study was therefore to confirm the existence of a reductive pathway that reestablishes the existence of the bioregulator NO from its main metabolite NO_2^- . Furthermore, it was of interest to explore whether nitrite reduction to NO results from a pure chemical reaction as proposed by [7] or whether it is under the control of an enzyme.

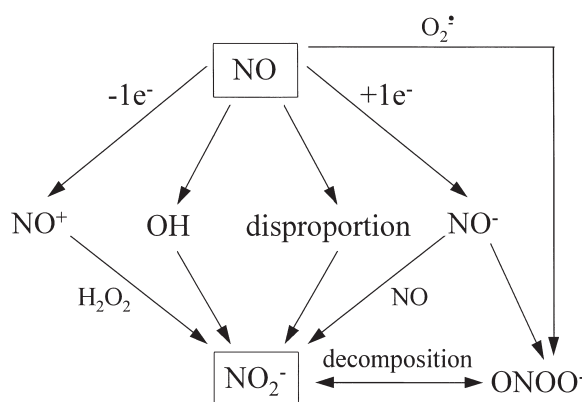

Figure 2. The pathways of NO degradation yielding nitrite.

Recently, xanthine oxidase was shown to catalyze the reduction of NO_2^- to NO under anaerobic conditions [9].

MATERIAL AND METHODS

Animals. Adult male Sprague-Dawley rats (Charles River Wiga GmbH, Sulzfeld, Ger-

many) weighing 430–460 g were used in this study. The animals were allowed to stabilize for at least 7 days to acclimatize before the experiments began.

Chemicals. Rotenone, myxothiazol, antimycin A, thenoyltrifluoroacetone (TTFA) were obtained from Sigma Chemical Co. Glutamic acid and malonic acid were received from Merck Co. Nitric monoxide gas was obtained from AGA Co. Other chemicals were of analytical grade purity. Hemoglobin (Hb) was prepared from bovine red blood cells as described before [10].

Preparations of mitochondria and submitochondrial particles. Rat liver mitochondria (RLM) were prepared according to Szarkowska & Klingenberg [11] and stored in buffer containing 0.25 M sucrose, 20 mM triethanolamine, 1 mM EDTA (pH = 7.25) at 0°C for 4–5 h. Submitochondrial particles (SMP) were prepared from beef hearts according to Graham & Rickwood [12], kept at –40°C in the same buffer and thawed at the day of experiment. The concentrations of RLM and SMP in the stock solutions were 50–60 mg protein/ml and 36 mg protein/ml, respectively. Before incubation both SMP and RLM were diluted to the concentration of 5 mg/ml with buffer containing additionally 10 mM of potassium phosphate (pH = 7.25). RLM (or SMP) alone or with different substrates were mixed with hemoglobin and inhibitors of the respiratory chain (total sample volume was 500 μ l) and kept under flow of argon for 10 min. Substitution of oxygen by argon was facilitated using a shaking table to provide gentle mixing of the mitochondrial suspension with argon. Then 5 μ l of oxygen-free sodium nitrite (NaNO_2) solution was injected through a channel made in the experimental cell under anaerobic conditions. Samples were aspirated by a syringe without exposure to oxygen and kept for 2 h at room temperature ($20 \pm 2^\circ\text{C}$) inside a home-made anaerobic chamber. After two hours the samples were frozen in liquid nitrogen, and subjected to EPR measurements. The experimental medium contained:

5 mg of protein/ml RLM or SMP; 0.5 mM Hb, 5 mM succinate or 5 mM of NADH or 2.5 mM glutamate plus 2.5 mM malate, 250 μ M Hb, 50 μ M NaNO_2 ; 0.25 M sucrose, 20 mM triethanolamine, 1 mM EDTA, and 10 mM K_2HPO_4 , pH = 7.25.

Intestinal I/R model. The rats were anesthetized by intramuscular injection of a mixture of ketamine/xylazine (112/15 mg/kg body mass) and maintained under anesthesia by 0.2% of isoflurane for the duration of the acute experiment. After performing a midline laparotomy, the superior mesenteric artery was occluded and then released after 60 min of ischemia, allowing reperfusion.

EPR measurements. The mitochondrial suspension or tissues collected from the rats were placed into 1 ml syringes, and immediately frozen in liquid nitrogen. Then the sample was pressed out of the syringe and moved to a finger-tip liquid nitrogen dewar. EPR spectra were recorded at liquid nitrogen temperature with a Bruker ER-200 SRP spectrometer under the following conditions: microwave frequency 9.431 GHz, modulation frequency 100 kHz, microwave power 20 mW, modulation amplitude 5 G; gain 10^5 . The double integral of the signal was calculated and compared with that obtained from nitrosoheme complex standards. In the same spectra we measured the magnitudes of peaks at $g = 2.002$ and calculated the ratio magnitude/double integral. This ratio was used for quantification of nitrosyl heme complexes when double integration failed due to either the low intensity of the signals or a strong interference with other signals. The preparation of nitroso-heme complex standards was performed as described earlier [13].

RESULTS AND DISCUSSION

We have recently shown that the occlusion of the arteria mesenterica is followed by a clear increase of NO in the tissue [14]. NO appearing in the tissue was detected by nitro-

sylation of deoxyhemoglobin giving rise to a triplet hyperfine electron paramagnetic resonance (EPR) sensitive splitting of the ferrous NO complex (Fig. 3). As to be expected from the fact that in the absence of oxygen NO cannot be derived from the cytochrome P450-containing enzyme set which produces NO from L-arginine in a complex sequence of catalytic steps, NO synthase (NOS) inhibitors were not able to suppress NO accumulation in the intestinal tissue during total ischemia [15]. In contrast, reoxygenation resulted in the stepwise decrease of tissue NO which however, was re-established after a reperfusion period of 24 h. NO decrease during reoxygenation is likely to

tion steps in which NO is an obligatory intermediate [16] (see reaction 1, 2, 3).

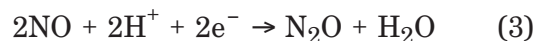
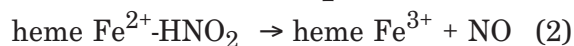
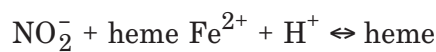

These prokaryotes use heme coordinated ferrous iron of a periplasmatic cytochrome *cd*₁ complex for reactions (1) and (2) and a cytochrome *bc* complex for the subsequent reduction of NO to N₂O [17, 18]. Protein and

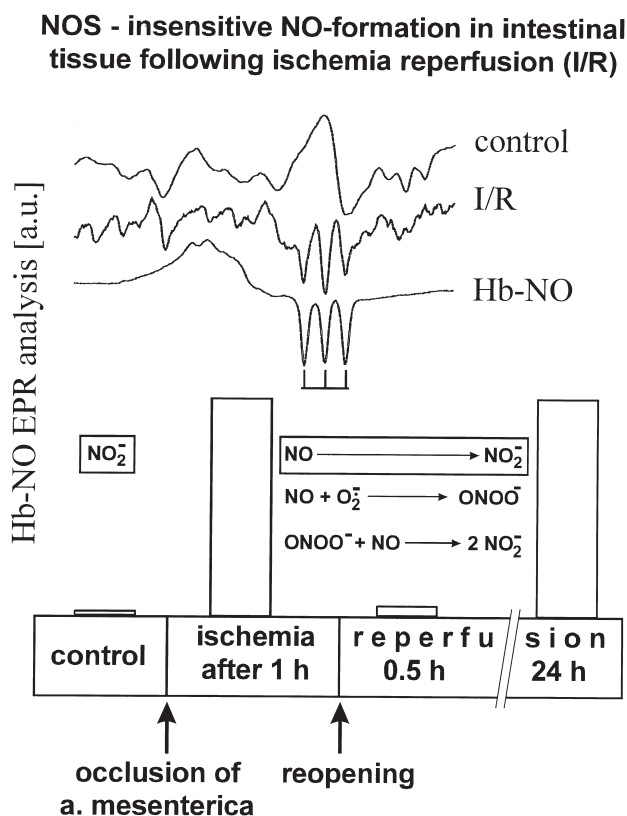

Figure 3. NO generation in ischemic intestine induced by superior mesenteric artery occlusion and following reoxygenation.

Control, sham operated animals; I/R, animals subjected to intestinal ischemia (1 h) and reperfusion (24 h); Hb-NO, heme-nitrosyl complexes.

be a result of peroxynitrite formation which proceeds rapidly in the presence of superoxide radicals. The latter are generally expected to be formed in the reperfusion period of an organ. As shown in Fig. 2 peroxynitrite can become a source for NO₂⁻ that in turn undergoes a second cycle to form NO after 24 h.

Denitrifying bacteria reduce nitrite to laughing gas (N₂O) in a complex sequence of reduc-

tion steps in which NO is an obligatory intermediate [16] (see reaction 1, 2, 3). heme coordinated iron operating as one e⁻ carriers are manifold present in the e⁻ transfer chain of mitochondria (Fig. 4). Redox-cycling e⁻ carriers of the respiratory chain therefore appeared to be promising candidates for one e⁻ reduction of nitrite to nitric oxide.

Nitrite reduction to NO was followed *via* nitrosylation of deoxyhemoglobin to give a

EPR detectable triplet. Fig. 5A demonstrates that nitrite reduction with substrates supplying e^- for cell respiration is neglectable. Reorganization of mitochondrial e^- carriers in the inner mitochondrial membrane following re-

the addition of substrates for respiration resulted in the reductive transformation of NO_2^- to NO (Fig. 5C). This was also the case when NO_2^- was in contact with intact mitochondria which, in contrast to SMP, contain endoge-

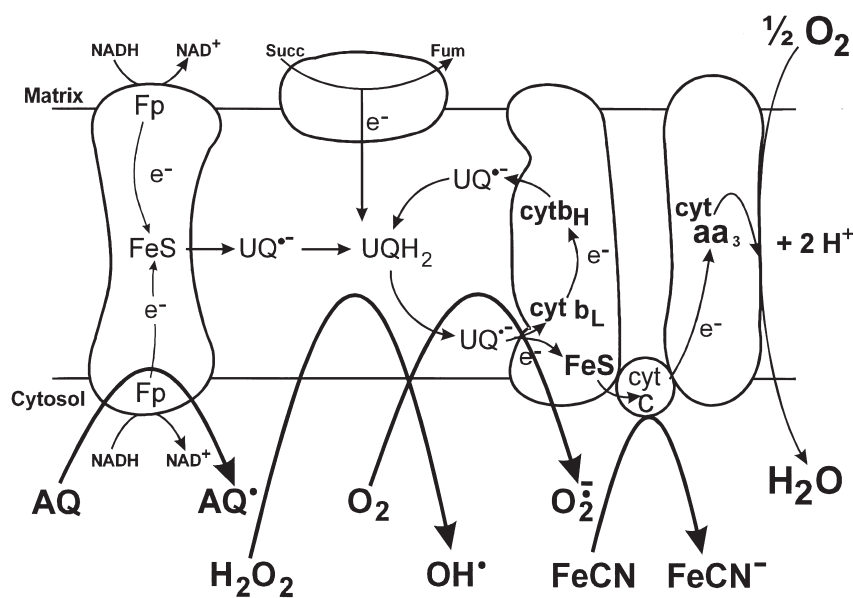

Figure 4. Various sites where electrons may leak from the respiratory chain to external oxidants.

moval of matrix constituents (= submitochondrial particles = SMP) do not reduce nitrite when in the resting state (Fig. 5B). Activation of the mitochondrial respiratory chain upon

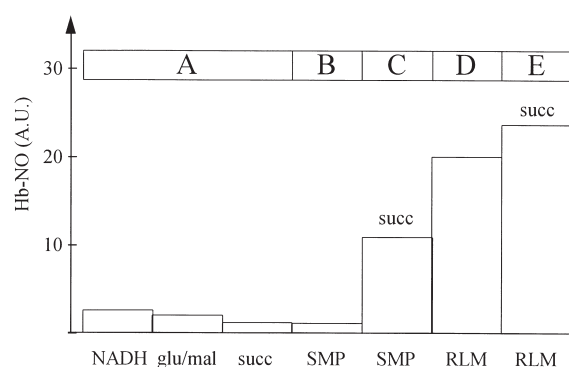

Figure 5. Nitrite reduction to NO with mitochondrial respiratory substrates alone (A) and after activation of the mitochondrial electron transfer. B, in the presence of SMP; C, in the presence of SMP plus succinate; D, in the presence of RLM; E, in the presence of RLM plus succinate.

nous substrates keeping the respiration chain running (Fig. 5D). Stimulation of respiration upon the external addition of substrates for respiration did not increase NO recycling from NO_2^- (Fig. 5E). This indicates the high efficiency of mitochondrial NO_2^- reduction.

When mitochondria were faced to quasi-physiological nitrite levels [19] NO release was almost linear (Fig. 6). A reduction rate of 15 nmoles NO_2^- per minute and mg mitochondrial protein to NO was calculated from the slope which is five times more than NO generated from mitochondrial NO under optimal experimental conditions [20, 21].

Identification of the mitochondrial reductant of nitrite was possible by means of adequate inhibitors that allow the separate reduction of segments of the respiratory chain (Fig. 7). The schematic presentation of the various components of the mitochondrial respiratory chain illustrates the sites of interac-

tion of inhibitors used. Rotenone prevents the transfer of reducing equivalents from the

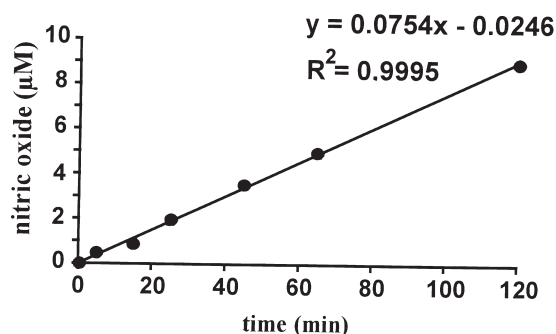

Figure 6. Mitochondrial NO formation rates from quasi physiological NO_2^- concentrations.

NADH-dehydrogenase complex (= complex I) while thenoyltrifluoroacetone (TTFA) keeps the succinate dehydrogenase complex (= complex II) in the reduced state in that the flow of reducing equivalents to the ubiquinone cycle is inhibited. With antimycin A (AA) recycling of e^- into the Q cycle is inhibited; as a conse-

quence downstream of the second electron to cytochrome oxidase is not possible; therefore AA keeps this second branch of the respiratory chain oxidized. Myxothiazole intercepts the interaction of the ubiquinol/ bc_1 redox cou-

ple. Ubisemiquinone involved in the transfer of reducing equivalents at this site is destabilized in the presence of myxothiazole.

Antimycin A which is required to diverge single e^- from the respiratory chain to dioxygen [22] is of no significance for the reductive transformation of NO_2^- to NO (Fig. 8). NO^- derived nitrosylation of deoxyhemoglobin was however, totally suppressed in the presence of myxothiazole. This observation stresses the involvement of ubisemiquinone in NO-recycling from NO_2^- . The insensitivity of NO-formation to the presence of AA excludes a reduction site downstream the cytochrome *c* branch of the respiration chain. Also complex I and complex II of the respiration chain can be excluded as reductants of NO_2^- since upregulation of the redox states of e^- carriers in these segments using rotenone and TTFA, respectively, resulted in a decrease of the NO recycling rate instead of being increased. It is evident from the above results that the nitrite reductase activity of mitochon-

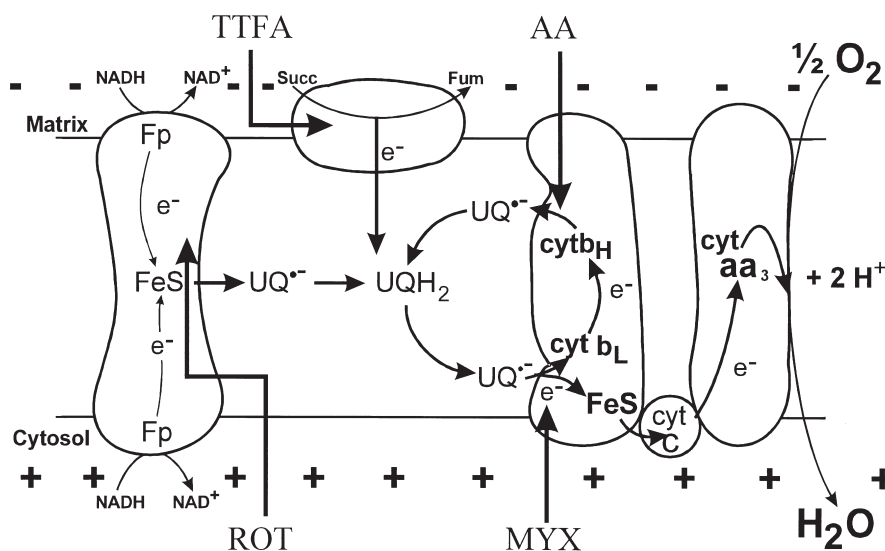

Figure 7. Segmental inhibition of mitochondrial electron flow.

MYX, myxothiazole; ROT, rotenone.

dria is identical with the reductant of the bc_1 -complex. Considering the positively charged surface of the cytosolic face of the inner mitochondrial membrane the negative charge of NO_2^- molecules facilitates the inter-

action of the ubiquinol/ bc_1 redox couple. Ubisemiquinone involved in the transfer of reducing equivalents at this site is destabilized in the presence of myxothiazole.

action with the respective reductant which is expected to operate close to the polar head group section of the membrane. NO derived

following the oxygen decay rate of a defined oxygen pulse (Fig. 9). The respiratory activity of mitochondria was only 70% of the controls

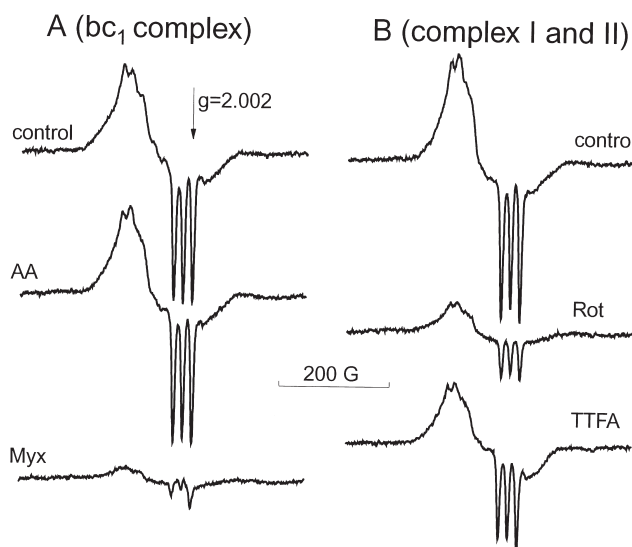

Figure 8. Effect of respiratory chain inhibitors on the nitrite mediated NO generation in mitochondrial suspension.

MYX, myxothiazole; ROT, rotenone.

from mitochondrial nitrite reductase activity can be expected to readily remove oxygen from cytochrome oxidase due to its high binding affinity which was reported to range mag-

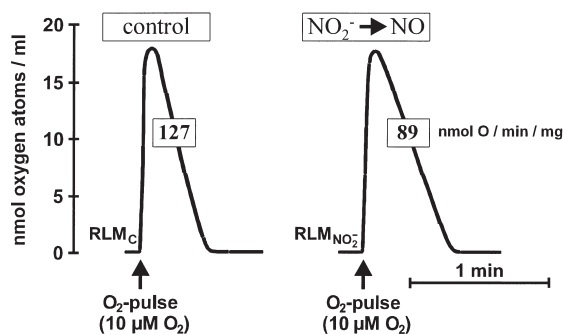

Figure 9. Inhibition of mitochondrial respiratory activity by nitrite derived NO.

nitudes of order above that for oxygen [23].

NO from nitrite was accumulated in mitochondria in the absence of oxygen up to values which were reported by Richter [20, 24] and Boveris [21, 25] to exert physiological activities when mitochondrial NOS was the source (about 2 nM/mg). The impact of nitrite derived NO on cytochrome oxidase was studied

when NO was recycled from quasi-physiological levels of nitrite. However, at physiological tissue oxygen concentrations (which are five times higher as applied in the above experiments) 40 μ M NO per mg mitochondrial protein was required for 30% inhibition. A Japanese research group has recently demonstrated that the inhibitor constant C_{50} of NO increases in proportion of the square of oxygen tension [26]. In other words NO-levels measured by Boveris *et al.* [21, 25] and Richter *et al.* [20, 24] are by far too low to control the flow of reducing equivalents through the respiratory chain. However, NO supplied by the mitochondrial nitrite reductase activity increases with the amount of nitrite accumulated in the tissue. The latter is a function of nutrition habits (vegetarians) and of other external sources which may increase the nitrite pool.

Intestinal bacteria may contribute in that they reduce nitrate to nitrite. Patients treated with NO-donors for better vascular blood supply or HIV patients which have high NO_2^- levels in their nervous systems may stimulate mitochondrial NO formation rates sufficiently to affect energy-linked respiration.

REFERENCES

1. Palmer, R.M., Ferrige, A.G. & Moncada, S. (1987) Nitric oxide release accounts for the biological activity of endothelium-derived relaxing factor. *Nature* **327**, 524–526.
2. Henry, Y., Lepoivre, M., Drapier, J.C., Ducrocq, C., Boucher, J.L. & Guissani, A. (1993) EPR characterization of molecular targets for NO in mammalian cells and organelles. *FASEB J.* **7**, 1124–1134.
3. Seligman, S.P., Buyon, J.P., Clancy, R.M., Young, B.K. & Abramson, S.B. (1994) The role of nitric oxide in the pathogenesis of pre-eclampsia. *Am. J. Obstet. Gynecol.* **171**, 944–948.
4. Tsikas, D., Boger, R.H., Bode Boger, S.M., Gutzki, F.M. & Frolich, J.C. (1994) Quantification of nitrite and nitrate in human urine and plasma as pentafluorobenzyl derivatives by gas chromatography-mass spectrometry using their ¹⁵N-labelled analogs. *J. Chromatogr. B. Biomed. Appl.* **661**, 185–191.
5. Preik Steinhoff, H. & Kelm, M. (1996) Determination of nitrite in human blood by combination of a specific sample preparation with high-performance anion-exchange chromatography and electrochemical detection. *J. Chromatogr. B. Biomed. Appl.* **685**, 348–352.
6. Komori, K., Matsumoto, T., Ishida, M., Kuma, S., Yonemitsu, Y., Eguchi, D. & Sugimachi, K. (1997) Enhancement of nitric oxide production after arterial reconstruction in patients with arteriosclerosis obliterans. *J. Vasc. Surg.* **26**, 657–662.
7. Zweier, J.L., Wang, P., Samouilov, A. & Kuppusamy, P. (1995) Enzyme-independent formation of nitric oxide in biological tissues. *Nature Med.* **1**, 804–809.
8. Vanin, A.F., Kiladze, S.V. & Kubrina, L.N. (1977) Factors influencing formation of dinitrosyl complexes of non-heme iron in the organs of animals *in vivo*. *Biofizika* **22**, 850–855.
9. Zhang, Z., Naughton, D., Winyard, P.G., Benjamin, N., Blake, D.R. & Symons, M.C.R. (1998) Generation of nitric oxide by a nitrite reductase activity of xanthine oxidase: A potential pathway for nitric oxide formation in the absence of nitric oxide synthase activity [published erratum appears in *Biochem Biophys. Res. Commun.* (1998) *Biochem. Biophys. Res. Commun.* **249**, 767–772].
10. Stolze, K., Dadak, A., Liu, Y. & Nohl, H. (1996) Hydroxylamine and phenol-induced formation of methemoglobin and free radical intermediates in erythrocytes. *Biochem. Pharmacol.* **52**, 1821–1829.
11. Szarkowska, L. & Klingenberg, M. (1963) On the role of ubiquinone in mitochondria, Spectrophotometric and chemical measurements of its redox reaction. *Biochem. Z.* **338**, 674–697.
12. Graham, J.M. & Rickwood, D. (1997) *Subcellular Fractionation*. Oxford University Press, Oxford, New York, Tokyo.
13. Kozlov, A.V., Bini, A., Iannone, A., Zini, I. & Tomasi, A. (1996) Electron paramagnetic resonance characterization of rat neuronal nitric oxide production *ex vivo*. *Methods Enzymol.* **268**, 229–236.
14. Kozlov, A.V., Sobhian, B., Duvigneau, C., Costantino, G., Gemeiner, M., Nohl, H., Redl, H. & Bahrami, S. (1999) NO synthase-dependent/independent formation of NO after intestinal ischemia and reperfusion. *Shock (Suppl.)* **12**, 44.
15. Kozlov, A.V., Sobhian, B., Duvigneau, C., Gemeiner, M., Nohl, H., Redl, H. & Bahrami, S. (2000) Organ specific formation of nitrosyl complexes under intestinal ischemia/reperfusion in rats involves NOS-independent mechanism(s). *Shock*, in press.
16. Henry, Y. & Bessieres, P. (1984) Denitrification and nitrite reduction: *Pseudomonas*

- aeruginosa* nitrite-reductase. *Biochimie* **66**, 259–289.
- 17.** Carr, G.J., Page, M.D. & Ferguson, S.J. (1989) The energy-conserving nitric-oxide-reductase system in *Paracoccus denitrificans*. Distinction from the nitrite reductase that catalyses synthesis of nitric oxide and evidence from trapping experiments for nitric oxide as a free intermediate during denitrification. *Eur. J. Biochem.* **179**, 683–692.
- 18.** Bessieres, P. & Henry, Y. (1984) Stoichiometry of nitrite reduction catalyzed by *Pseudomonas aeruginosa* nitrite-reductase. *Biochimie* **66**, 313–318.
- 19.** Zweier, J.L., Samouilov, A. & Kuppusamy, P. (1999) Non-enzymatic nitric oxide synthesis in biological systems. *Biochim. Biophys. Acta*, **1411**, 250–262.
- 20.** Ghafourifar, P. & Richter, C. (1997) Nitric oxide synthase activity in mitochondria. *FEBS Lett.* **418**, 291–296.
- 21.** Giulivi, C., Poderoso, J.J. & Boveris, A. (1998) Production of nitric oxide by mitochondria. *J. Biol. Chem.* **273**, 11038–11043.
- 22.** Nohl, H., Gille, L. & Kozlov, A.V. (1998) Prooxidant functions of coenzyme Q. *Subcell. Biochem.* **30**, 509–526.
- 23.** Brown, G.C. (1995) Nitric oxide regulates mitochondrial respiration and cell functions by inhibiting cytochrome oxidase. *FEBS Lett.* **369**, 136–139.
- 24.** Ghafourifar, P., Schenk, U., Klein, S.D. & Richter, C. (1999) Mitochondrial nitric-oxide synthase stimulation causes cytochrome *c* release from isolated mitochondria. Evidence for intramitochondrial peroxynitrite formation. *J. Biol. Chem.* **274**, 31185–31188.
- 25.** Boveris, A., Costa, L.E., Poderoso, J.J., Carreras, M.C. & Cadenas, E. (2000) Regulation of mitochondrial respiration by oxygen and nitric oxide. *Ann. N.Y. Acad. Sci. U.S.A.* **899**, 121–135.
- 26.** Takehara, Y., Nakahara, H., Inai, Y., Yabuki, M., Hamazaki, K., Yoshioka, T., Inoue, M., Horton, A.A. & Utsumi, K. (1996) Oxygen-dependent reversible inhibition of mitochondrial respiration by nitric oxide. *Cell Struct. Funct.* **21**, 251–258.