

55-20  
4988

**N95- 32423**

## **MODELING OF DC SPACECRAFT POWER SYSTEMS**

**Final Report  
NASA/ASEE Summer Faculty Fellowship Program--1994  
Johnson Space Center**

|                                     |   |
|-------------------------------------|---|
| <b>Prepared By:</b>                 | <b>F.C. Berry</b>   |
| <b>Academic Rank:</b>               | <b>Associate Professor</b>  |
| <b>University &amp; Department:</b> | <b>Department of Electrical Engineering<br/>Louisiana Tech University<br/>Ruston, Louisiana 71272</b> |
| <b>NASA/JSC</b>                     |   |
| <b>Directorate:</b>                 | <b>Engineering</b>  |
| <b>Division:</b>                    | <b>Propulsion And Power</b>   |
| <b>Branch:</b>                      | <b>Power</b>  |
| <b>JSC Colleagues:</b>              | <b>Tom Jeffcoat</b>   |
| <b>Data Submitted:</b>              | <b>August 5, 1994</b>   |
| <b>Contract Number:</b>             | <b>NGT-44-005-803</b>   |

displacement than we can measure from the pointing output. The motor command networks directing eye movements may receive more information from the vestibularly-derived spatial map than the motor command networks for pointing movements. Alternatively, vestibular input to both systems may be identical but the motor command networks for pointing may not produce as accurate an output as those for eye movements.

Our data provide a measure of an individual's ability to point to a remembered target location using only vestibular cues. These data can be contrasted with similar data derived from subjects whose eye-head coordination and internal spatial map have been perturbed, for example, by wearing minimizing lenses. In addition, these data can be compared to data collected from astronauts exposed to the microgravity environment of space.

#### REFERENCES

- 1.) Bloomberg J, Jones GM, Segal B (1991) Adaptive modification of vestibularly perceived rotation. *Exp. Brain Res.* 84: 47-56.
- 2.) Watt DGD, Money KE, Bondar RL, Thirsk RB, Garneau M, Scully-Power P (1985). Canadian medical experiments on shuttle flight 41-G. *Can Aeronaut. Space J.* 31:215-226.
- 3.) Young LR, Oman CM, Watt DGD, Money KE, Lichtenberg BK (1984). Spatial orientation in weightlessness and readaptation to earth's gravity. *Science.* 225: 205-208.

## ABSTRACT

Future spacecraft power systems must be capable of supplying power to various loads. This delivery of power may necessitate the use of high-voltage, high-power dc distribution systems to transmit power from the source to the loads. Using state-of-the-art power conditioning electronics such as dc-dc converters, complex series and parallel configurations may be required at the interface between the source and the distribution system and between the loads and the distribution system.

This research will use state-variables to model and simulate a dc spacecraft power system. Each component of the dc power system will be treated as a multiport network, and a state model will be written with the port voltages as the inputs. The state model of a component will be solved independently from the other components using its state transition matrix.

A state-space averaging method is developed first in general for any dc-dc switching converter, and then demonstrated in detail for the particular case of the boost power stage. General equations for both steady-state (dc) and dynamic effects (ac) are obtained, from which important transfer functions are derived and applied to a special case of the boost power stage.

## INTRODUCTION

The basic dc-dc level conversion function of switching converters is achieved by repetitive switching between two linear networks consisting of ideally lossless storage elements, inductances and capacitances. In practice, this function may be obtained by use of transistors and diodes that operate as synchronous switches. On the assumption that the circuit operates in the continuous conduction mode in which the instantaneous inductor current does not fall to zero at any point in the cycle, there are only two different states of the circuit. Each state can be represented by a linear circuit model or by a corresponding set of state-space equations.

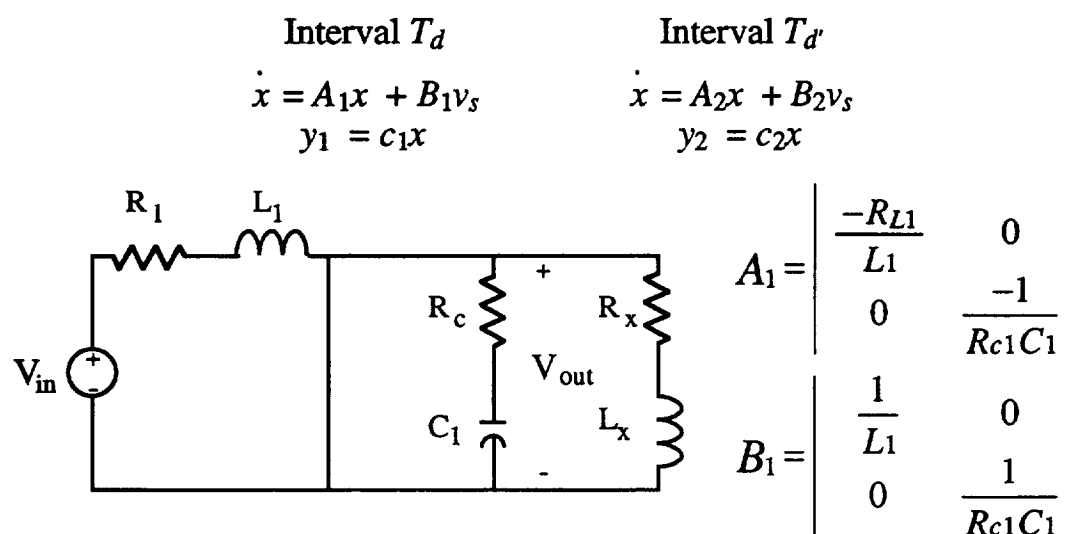

Fig. 1. Network for formulating  $A_1$  and  $B_1$ .

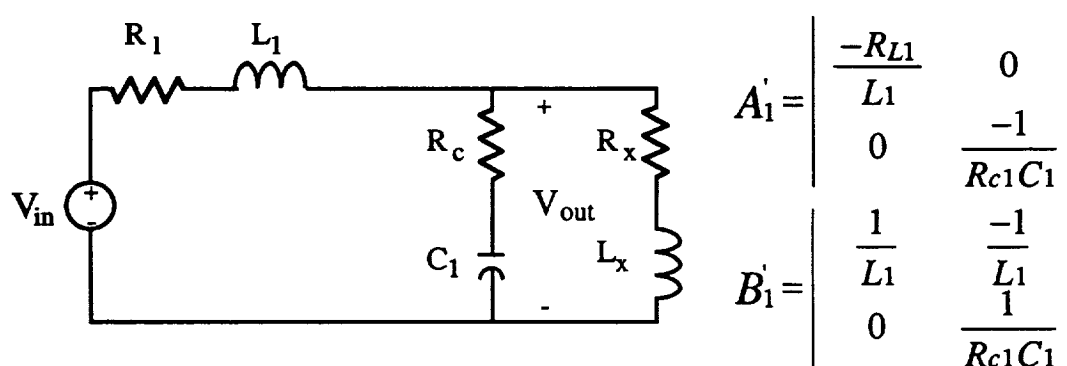

Fig. 2. Network for formulating  $A_1'$  and  $B_1'$ .

The interval  $T_d$  denotes the interval when the switch is in the on state and  $T_d'$  denotes the interval when the switch is in the off state. The state model is

formulated for a boost circuit assuming the circuit operates in the continuous conduction mode. The  $A$  and  $B$  matrices for each of the two linear networks are given along with the network model that was used to obtain the  $A$  and  $B$  matrices.

## SIMULATION

In the analysis of a system by the state-space approach, the system is characterized by a set of first-order differential or difference equations [1]. The dc-dc converter can be described by a set of state-space equations. These state-space equations have the following form:

$$\dot{x} = Ax + Bv$$

where  $x$  is a vector of state-variables,  $v$  is a vector of inputs, and  $A$  and  $B$  are matrices. The state-variables,  $x$ , are associated with the capacitor voltage and the inductor current. The solution for  $x$  is given by

$$x(t) = \Phi(t)x(0) + \int_0^t \Phi(t - \tau)Bv(\tau)d\tau$$

where  $\Phi(t)$  is the state transition matrix and  $x(0)$  is a vector containing initial values for the state variables. This solution for  $x(t)$  is valid if the matrices  $A$  and  $B$  are constant.

The dc-dc converter is a switching converter and is modeled by two different linear networks (Figures 1 and 2). Therefore, the matrices  $A$  and  $B$  are not constant over the interval  $[0, T]$ . The limits of integration must be changed to an interval over which  $A$  and  $B$  are constant. Also,  $v$  will contain entries that are unknown functions of time. All of these conditions will make the convolution integral very difficult to evaluate.

To evaluate the convolution integral it was assumed that the inputs,  $v$ , were constant or clamped over the interval of the integration. Therefore a recursive relationship for  $x$  can be developed if the appropriate interval,  $T$ , is selected for matrices  $A$  and  $B$  to be constant.

$$x(k+1) = \Phi(T)x(k) + \Theta(T)Bv(k)$$

In this equation,  $x(k+1)$  and  $x(k)$  are the values of the state vector at  $t=(k+1)T$  and  $t=kT$ , respectively;  $v(k)$  is the value of the voltage at  $t=kT$ . The variable  $T$  is referred to as the time step, and it must be selected such that  $A$  and  $B$  are constant and the inputs,  $v$ , does not change appreciably

over the interval  $[0, T]$ . The variable  $\Phi(T)$  is the state transition matrix, which is calculated using the following power series;

$$\Theta(T) = IT + \frac{AT^2}{2!} + \frac{A^2T^3}{3!} + \frac{A^3T^4}{4!} + \dots$$

The variables  $\Phi(T)$  and  $\Theta(T)$  are related by the following equation;

$$\Phi(T) = A\Theta(T) + I$$

### Simulation 1

The  $\Phi(T)$  and  $\Theta(T)$  are calculated for each time step. A set of these matrices is required for each linear network model of the boost circuit. The solution of  $x(k+1)$  is a function of  $x(k)$  and  $u(k)$ , and the  $\Phi(T)$  and  $\Theta(T)$  for that particular linear network. The calculation of  $x(k+1)$  requires one vector addition and two multiplications of a matrix and a vector. This simulation procedure requires two different sets of matrices to be maintained, one set for each linear network. The simulation procedure is summarized in the flowchart of Figure 3.

An example dc power system is simulated using the state variable approach. This system consists of a dc power source connected to a boost network with a resistive-inductive load. The results of this simulation are given in Figure 4.

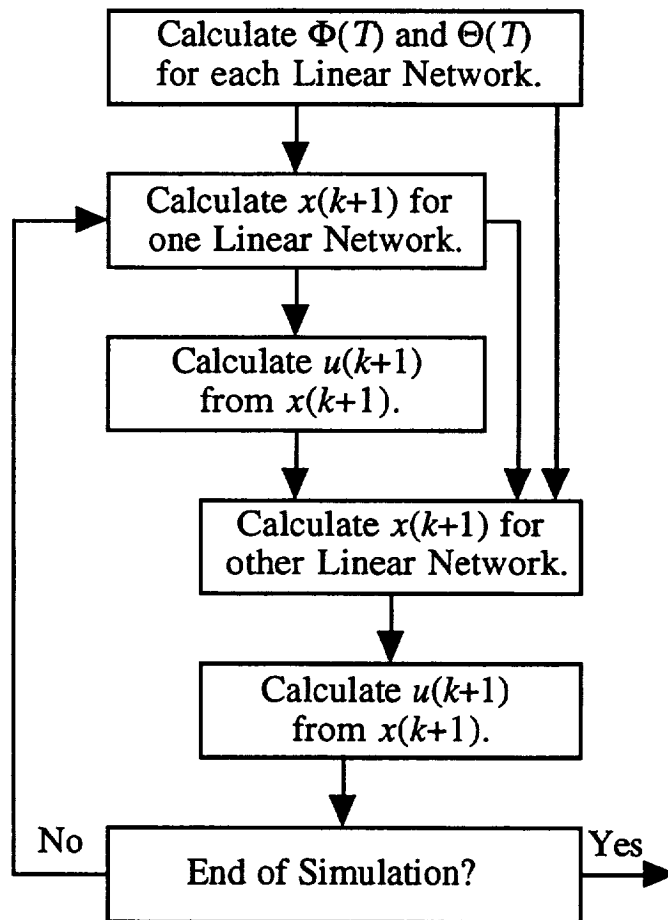

Fig. 3. Flowchart for Simulation 1.

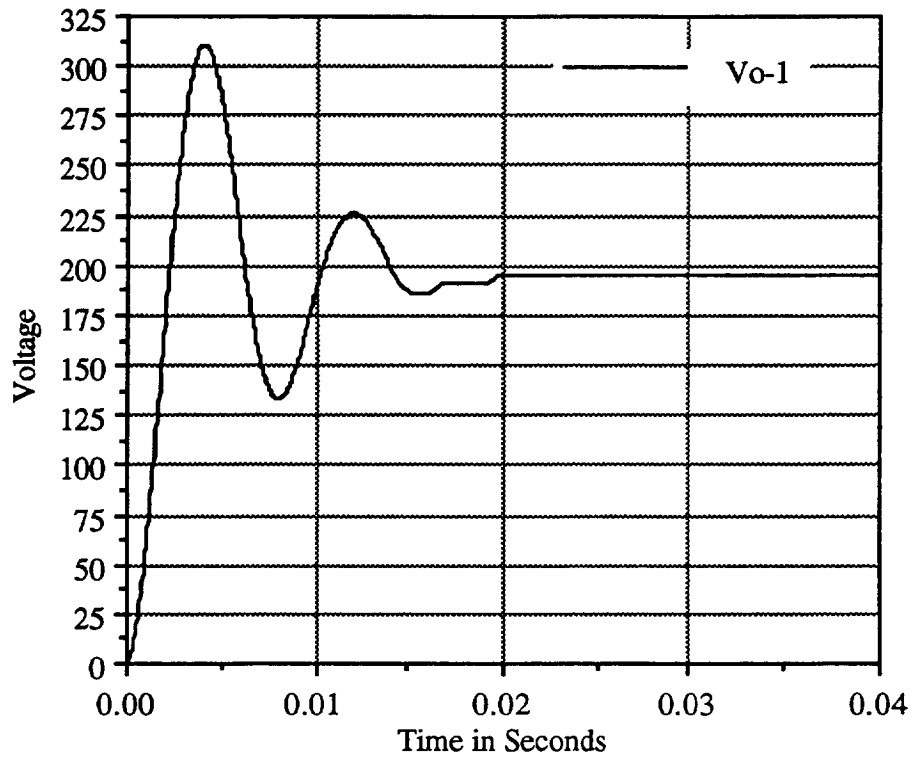

Fig. 4. Output voltage for Simulation 1.

### Simulation 2

The objective is to replace the state-space description of the two linear circuits by a single state-space description that represents the approximate behavior of the circuit across the period;

$$T_s = T_d + T_{d'}$$

To represent the approximate behavior of the circuit across the period,  $T_s$ , the following averaging method was used. The average was taken by summing the equations for the intervals of  $T_d$  and  $T_{d'}$  and multiplying each set of equations by  $d$  and  $d'$  respectively. The following linear continuous systems results;

$$\begin{aligned} \dot{x} &= (dA_1 + d'A_2) x + (db_1 + d'b_2) v_s \\ y &= (dc_1 + d'c_2) x \end{aligned}$$

This model is the basic average model that is the starting model for all other derivations.

The model represented is an averaged model over a single period  $T_s$ . If the duty ratio  $d$  is assumed to be constant from cycle to cycle, the  $d = D$  (the steady-state dc duty ratio). Then the averaged model becomes;

$$\begin{aligned}\dot{x} &= A x + B v_s \\ y &= C x\end{aligned}$$

where

$$A = (DA_1 + D'A_2) \quad B = (DB_1 + D'B_2) \quad c = (DC_1 + D'C_2)$$

The averaged model is a linear system. Therefore, superposition holds can be applied.

The  $\Phi(T)$  and  $\Theta(T)$  are calculated for each time step,  $T_s$ . One set of matrices is required for the averaged linear model of the boost circuit. The solution of  $x(k+1)$  is still a function of  $x(k)$  and  $u(k)$ , and  $\Phi(T)$  and  $\Theta(T)$ . The calculation of  $x(k+1)$  requires one vector addition and two multiplications of a matrix and a vector. The simulation procedure is summarized in the flowchart of Figure 5.

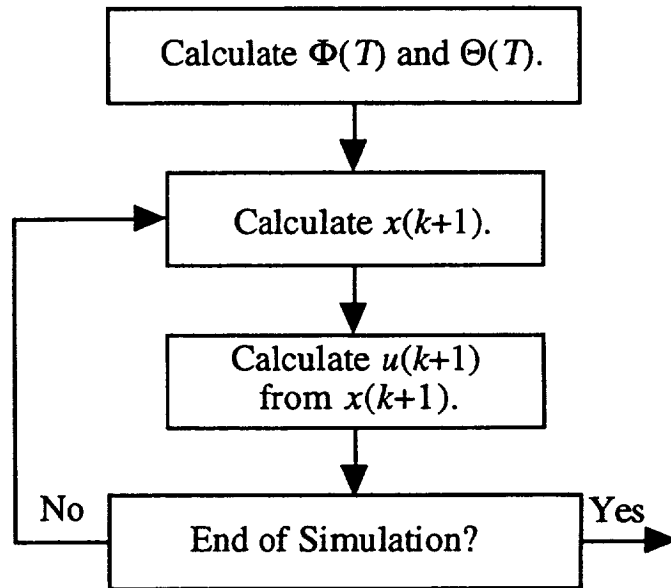

Fig. 5. Flowchart for Simulation 2.

An example dc power system is simulated using the state variable approach. This system consists of a dc power source connected to a boost network with a resistive-inductive load. The results of this simulation are given in Figure 6.



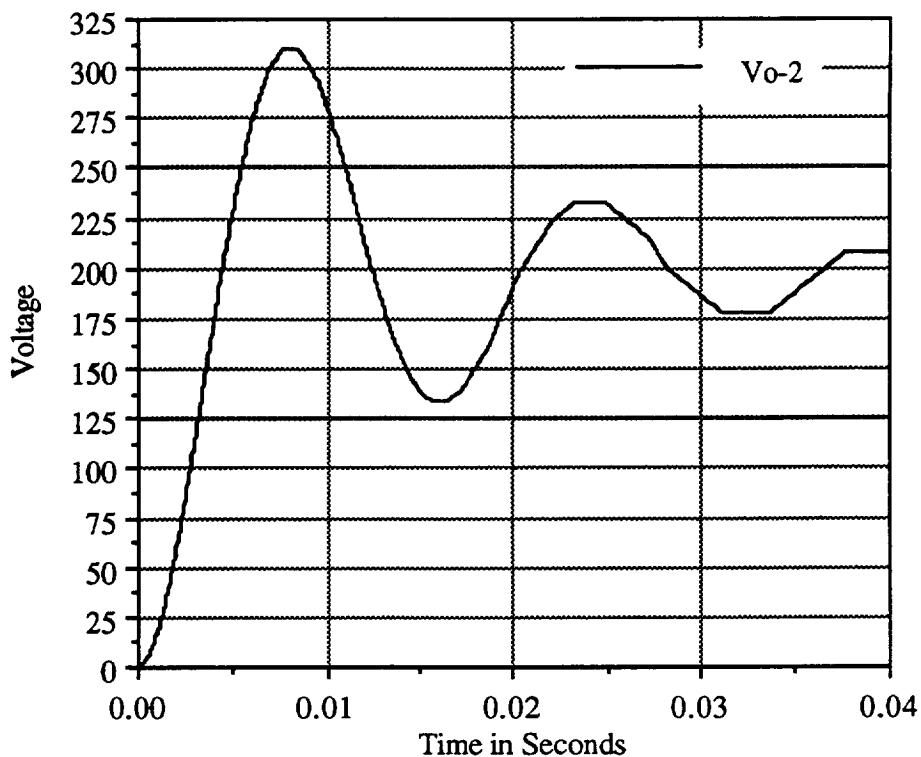

Fig. 6. Output voltage for Simulation 2.

### CONCLUSION

Two different simulation methods are presented. The method in Simulation 1 is a more traditional approach that relies on the modeling of each mode of operation of the dc-dc power converter. This is an effective method of modeling and has been used by several of authors [2,3,4]. However, for a large power system the number of models needed to describe the different modes of a variety of switching converters could become very large [1]. The modeling method presented in Simulation 2 tries to produce a single model of a switching converter. This method of modeling is done by producing a weighted average of the different linear models. Anytime an average is taken some distortion in time will occur because averaging is a form of high pass filtering. The comparison of the two different modeling methods in Figure 7 does show time distortion but the voltage magnitudes appear to be basically the same. More work in developing the theory and many more simulations must be done but the average method does appear to have some merit.

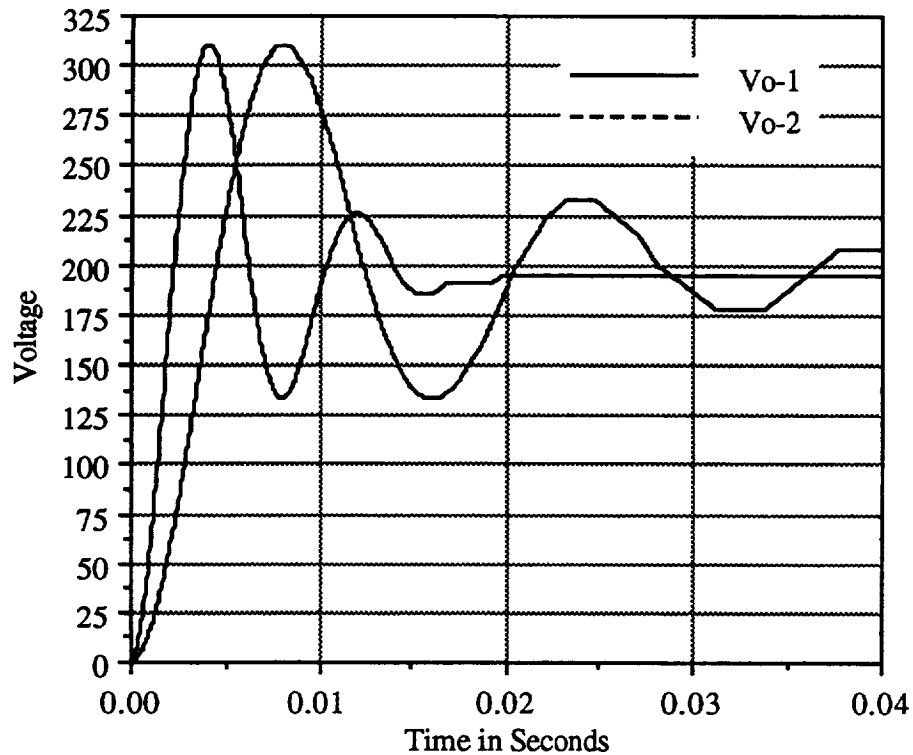

Fig. 7. Output voltage for Simulation 1 and 2.

## REFERENCES

- [1] R.M. Nelms and L.L. Grigsby, "Simulation of DC Spacecraft Power Systems," *IEEE Transactions on Aerospace and Electronic Systems*, Vol. 25, No. 1, January 1989.
- [2] B.H. Cho, J.R. Lee, and F.C. Lee, "Large-Signal Stability Analysis of Spacecraft Power Processing Systems," *IEEE Transactions on Power Electronics*, Vol. 5, No. 1, January 1990.
- [3] B.H. Cho and F.C. Lee, "Modeling and Analysis of Spacecraft Power Systems," *IEEE Transactions on Power Electronics*, Vol. 3, No. 1, January 1988.
- [4] J.R. Lee, B.H. Cho, S.J. Kim, and F.C. Lee, "Modeling and Simulation of Spacecraft Power Systems," *IEEE Transactions on Aerospace and Electronic Systems*, Vol. 24, No. 3, May 1988.