



MOIRÉ INTERFEROMETRY METHOD FOR NUMERICAL SIMULATION AND APPLICATIONS IN THREE-DIMENSIONAL METROLOGY-3D

MOHAMMEDI F., BENZAADA S.

Research laboratory in Subterranean and Surface Hydraulics, Larhyss,
University of Biskra PO Box 145 RP 07000, Algeria

farwane@yahoo.fr

ABSTRACT

The question that dominates and dictates the vision of this work is formed by the low spatial frequencies may appear in the combination of the light distribution of a periodical. The paper describes a method that allows the accurate prediction of the fringe localization in moiré. In the case of objects moving as a whole, Moiré can be applied thus as a metrological tool. The following applications are considered: study of mechanical vibrations and deformation, micro geometrical properties of surfaces. Several applications are emphasized: plane, cylindrical and spherical objects. Theoretical predictions are compared with experimental results.

Keywords: Digital image correlation, grid, phase, moiré, fringe projection

INTRODUCTION

Moiré techniques are straightforward methods for contactless non-destructive metrological measurements. Moiré topography in particular is a widely used means for shape contouring of three-dimensional objects (3D). The technique of the moiré is a process using the properties of the mechanical interferences between two gratings of lines of a very fine step. It makes it possible to visualize and measure displacements as well then the deformations in the field's rubber bands that plastic with the help of a mathematical data processing. The application of the method to the analysis of the constraints makes it

possible to determine in experiments and in any point the components of displacement like those of the deformations of a part subjected to an unspecified stress field. The principle of the method is based on the comparison between a deformed network and a grating not deformed playing the role of measuring rod. Each grating consists of a grid made up of a very great number of lines per millimeter. This method has very many advantages compared to the measurement techniques usually used. In particular, it allows the measurement of the deformations in any point, of a surface being able to be relatively significant.

PRINCIPLE OF THE MOIRE PROJECTION

Between them, these methods offer a wide range of high-sensitivity moiré interferometry provides abundant whole-field information in the form of contour maps fringe patterns. Through a fringe pattern which describes the height or deformation contours of the surface.

Figure 1 shows the light paths through the gratings. Collimated source light illuminates grating G1 and diffracts into two first-order beams, A and B. Grating G2, which has a grating frequency twice that of G1 (Figure1) redirects beams A and B so that they combine on the object surface. The reflected light from the surface passes back through the gratings and interferes on the CCD camera array.

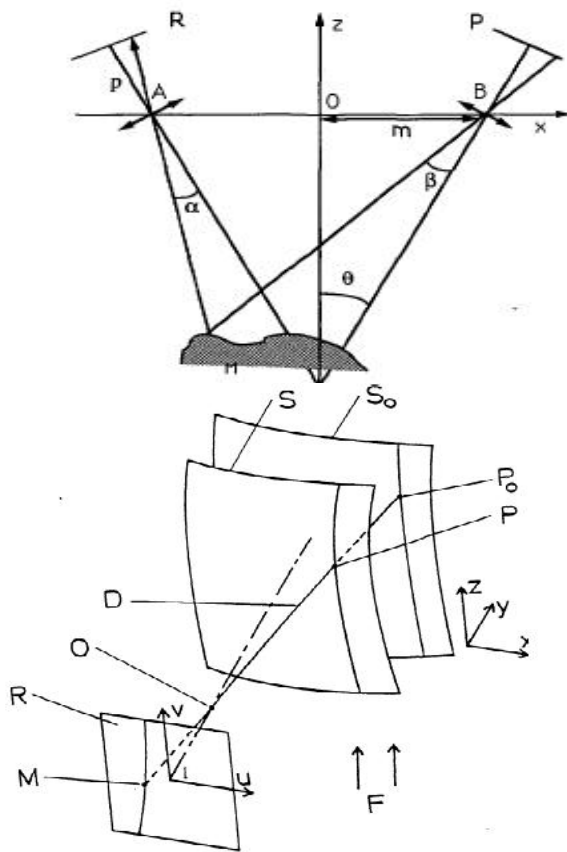

Figure 1: Experimental device of the geometry method

The reflected light from the surface passes back through the gratings and interferes on the CCD camera array. The sensitivity of the grating interferometer to surface deformation is caused by the difference in the incident angles α and β of beams A and B on the object surface (Figure 1).

The superposition of two identical gratings with a light angular shift reveals successive fringes dark and clear perpendicular to the more or less common direction of the 2 superimposed gratings. That is to say the angle formed by the two gratings: one can then conclude that the distance between two successive fringes is inversely proportional to the swing angle of the two gratings. The distance between a white fringe and a successive black fringe is then of figure 1 will be obtained by:

$$h \pm s = p \tag{1}$$

$$y = \cot g_n - p d / \sin_n$$

$$y = \cot g_{\alpha} - p d / \sin_{\alpha} \tag{2}$$

With d: distance between fringes, α : the angle formed between the fringe and the axis y and one can deduce the value from d and $\sin \alpha$ by:

$$d = \frac{v^2}{(2v^2 - 2v^2 \cos_{\alpha})^{1/2}} \tag{3}$$

The superposition image (Mohammadi, 2009; Sarychev et al., 1999) of figure 2 outlines periodically repeating dark parallel bands, called moiré lines. Spacing between the moiré lines is much larger than the periodicity of lines in the layers. The original fringe pattern can be described by:

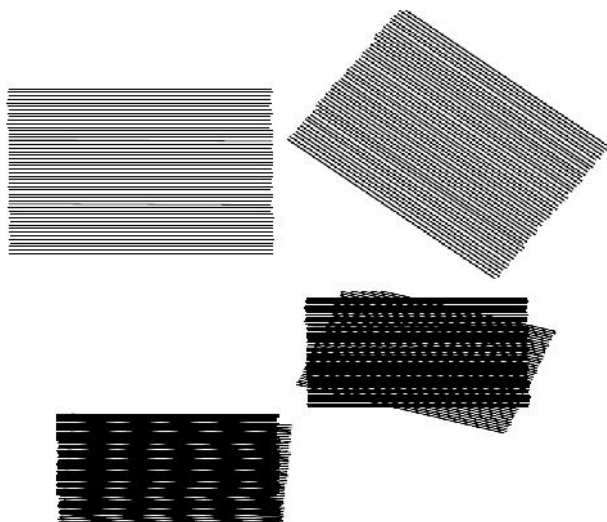

Figure 2: Superposition of two layers consisting of horizontal parallel lines

$$(x, y) \rightarrow \left\lfloor \left(\frac{-y}{h} \right) \right\rfloor \left\lfloor \left(\frac{x-y}{h} \right) \right\rfloor \tag{4}$$

Fundamental equation of moiré (Mohammadi, 1993; Patorski and Kujawska, 1993; Han, 1998; De Nicola and Ferraro, 2000), from this relation comes the subtractive and additive moiré effect. It is the effect of the product of transmittances of the two gratings. This function i.e. the equation (4), (Figure 2) is 0 and 1 for codes for the superposition of a horizontal grating with a grating of slope α . When $\alpha = 0$ (black) and $\alpha = 1$ (white) according to following mathematical modeling

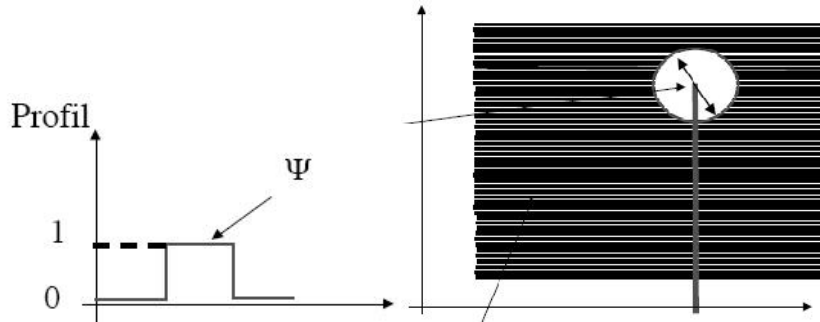

Figure 3: Modeling moiré fringes (Mohammedi, 2009)

STUDIES OF THE DEFORMATIONS

The study of stress of elastic three dimensional piece under promoting is a delicate problem, which cannot be, in general solved in thought using a numerical or analogical modeling according the Hook's law, the description of the stress state (Ye et al., 2003; Mohammedi and Zergui, 2009) of a configuration at the time t, subjected the surface or volume, static and dynamic stress is managed by the Relations existing between the unitary elongation ϵ_x and ϵ_y in function of normal stress σ_x and σ_y For small strains , shear strains γ_{xy} The displacement in fields U and V is expressed by:

$$U = \frac{N}{p}x, V = \frac{N}{p}y \quad (5)$$

Is related to displacements u_x and u_y by

$$v_x \approx \frac{1}{\Delta x(p)} \Delta N_x$$

$$v_y \approx \frac{1}{\Delta y(p)} \Delta N_y \quad (6)$$

With mechanical differentiation as:

$$\epsilon_{xy} = \frac{uU}{u_y} + \frac{uV}{u_x} \approx \frac{\Delta U}{\Delta y} + \frac{\Delta V}{\Delta x} \quad (7)$$

We use the fundamental equations it represents the energy available, within the body, for the propagation of the crack is defined as:

$$T_i \cdot \frac{uU}{u_x} = (\dagger_x v_x + \dagger_{xy} \frac{uV}{u_y}) \cos \theta + (\dagger_y \frac{uV}{u_x} + \dagger_{xy} v_x) \sin \theta \quad (8)$$

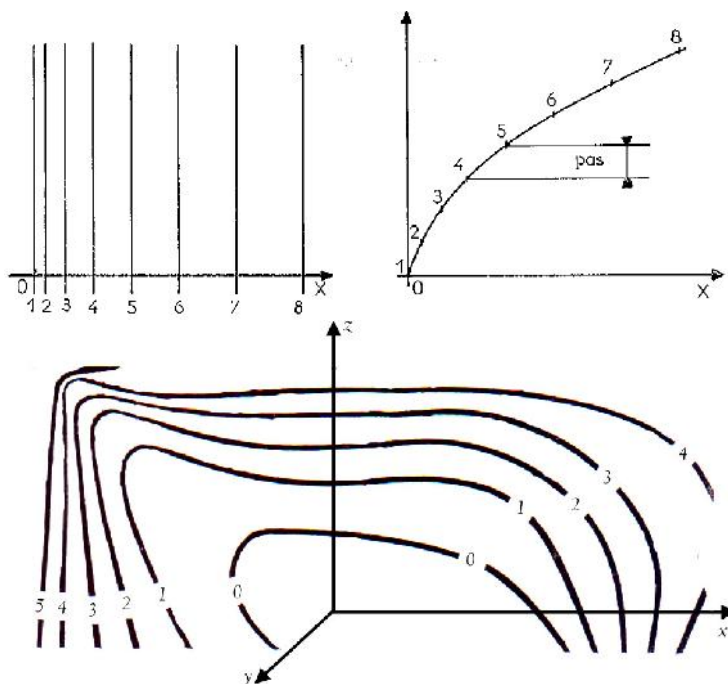

Figure 4: Displacements for measurement slope and curvature

The method of the moiré effect makes it possible to measure displacements then to reach the deformations by derivation of the curves thus obtained. It would be necessary in theory to pass by again with derived compared to the initial coordinates to obtain the traditional description of the field of the deformations. However, in the case of small deformations, two descriptions are almost identical and could be confused. On the other hand, it would be necessary, in the case of great deformations, to refer to these more complex calculations.

NUMERICAL SIMULATION

Simulations performed using Matlab logical arrays and logical and to perform “multiplication”. For the Matlab® user the library consists of a set of m-files that can be used from the Matlab® command line or included in functions or scripts.

PROCESSING IMAGES

XMoiréFringe® is a new library for fringe pattern processing which incorporates modern methods for automatic analysis including fringe pattern

demodulation, fringe pattern filtering and phase unwrapping methods. And additionally as a Matlab® toolbox. We apply the operators morphological of toolbox images processing:

- extract and remove background no uniformity
- applying thresholding to the image
- locate curvature and slope
- compare derived images with a references
- Derive the deformation map and stress map
- Application functions Matlab (Imrode, imdilate, periwit and skeletisation Imshow).



Figure 5: MATLAB interface with the scientific camera using Images Acquisition Toolbox

An image- processing system was used to collect data from consisted a CCD camera, frame-grabber, Pentium PC, and MATLAB proprietary software. The illumination was provided by a sodium light source of wavelength 589nm. The CCD camera is monochromatic with array of 768X512 pixels and can assign the gray shade to one of 256 levels (8bit). However, it is known that electronic noise can adversely affect the signal quality up to the first 3bits; all the images collected were reassigned with a resolution of 384X256 and Cropped to 256X256.

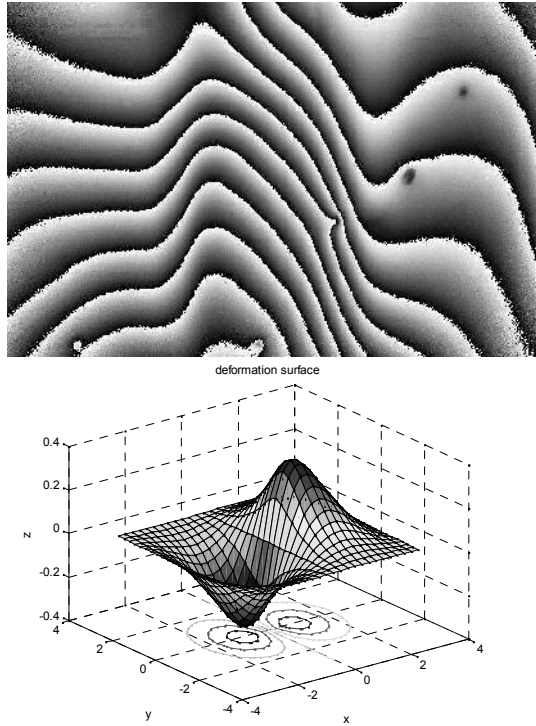

Figure 6: The digit recognition

Extract single images from a video stream and store them in standard formats, including BMP, JPEG, and TIFF.

RESULTS OF SIMULATION

A comparison between the real optical images of the forms of the fringes moiré and the digital simulations on different objects of forms were confirmed

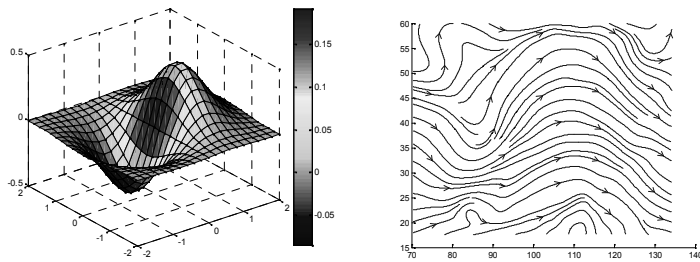

Figure 7: Numerical simulation patterns geometry moiré (process biological)

This simple means makes it possible to know the sign of the deformation. Indeed, it is then enough to make swivel slightly the pilot grating, the network deformed motionless remainder: If the material underwent traction, the grating witness is more «tight» that the deformed grating, their fringes swiveling in the same direction as the grating witness whom one makes turn. If the material underwent a compression, there is the phenomenon reverses and the fringes swivel in opposite direction of the direction of rotation which one applies to the pilot grating.

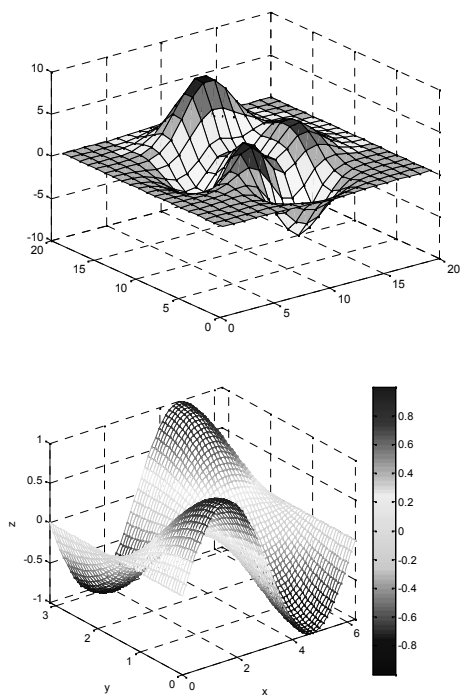

Figure 8 : Simulation patterns moiré 3Dmap

CONCLUSION

A robust technique for automated analysis of photo elastic components based on the phase-stepping moiré patterns and known as “load stepping” has been described demonstrated. the major conclusions that can may exist made regarding its development are as follows: The method could be applied to any problem of applying moiré fringes to any industrial or scientific problem consists of the following seven steps: Problem definition and goals, loading the object, reconstruction, viewing and storing, analysis of fringe, physical interpretation and use of deformation, this procedures are developed. However,

one can think that the research undertaken in this field will make it possible to lead to an examination at the same time faster and easier of the gratings of fringes of the moiré effect.

REFERENCES

- DE NICOLA S., FERRARO P. (2000). Fourier Transform Method of Fringe Analysis for Moiré Interferometry, *Journal of Optics A: Pure and Applied Optics*, 2(3), 228-233.
- HAN B. (1998). Recent Advancements of Moiré and Microscopic Moiré Interferometry for Thermal Deformation Analyses of Microelectronics Devices, *Exp. Mech.*, 38, 4, 278-285.
- MOHAMMEDI F. (1993). Thèse de Doctorat, Etudes topographiques des surfaces. Université Louis Pasteur de Strasbourg.
- MOHAMMEDI F. (2009). Modeling by a method for automating Moiré images for application in 2D-3D", *I.RE.PHY*, Vol. 3, n°2, 129-134.
- MOHAMMEDI F., ZERGUI B. (2009). Numerical simulation measurement of fracture and elasticity by moiré patterns experimental with observations, *International Review on Modeling and Simulations (I.RE.MOS)*, ISSN-1974-9821, Vol.2, n°5, 583-587.
- PATORSKI K., KUJAWINSKA, M. (1993). *Handbook of the Moiré Fringe Technique*, Elsevier Science Publishers, New York.
- SARYCHEV M.E., YU. V. ZHITNIKOV, L. BORUCKI, C.L. LIU, MAKHVILADZE T.M. (1999). General model for mechanical stress evolution during electromigration, *Journal of Applied Physics*, Vol. 86, n°6, 3068-3075.
- YE H., BASARAN C., HOPKINS D.C. (2003). Numerical simulation of stress evolution during electromigration in IC interconnect lines, *IEEE Transactions on Components and Packaging Technologies*, Vol.26, n°3, 673-681.