

6430
NACA TN 4017

NATIONAL ADVISORY COMMITTEE FOR AERONAUTICS

0067107



TECH LIBRARY KAFB, NM

TECHNICAL NOTE 4017

MOMENTUM TRANSFER FOR FLOW OVER A FLAT
PLATE WITH BLOWING

By H. S. Mickley and R. S. Davis
Massachusetts Institute of Technology



Washington
November 1957

AFL C

TECHNICAL LIBRARY
AFL 2811



TECHNICAL NOTE 4017

MOMENTUM TRANSFER FOR FLOW OVER A FLAT
PLATE WITH BLOWING

By H. S. Mickley and R. S. Davis

SUMMARY

The effect on the boundary layer of blowing air through a porous flat plate into a main airstream flowing parallel to the plate was studied experimentally. Measurements were made of velocity profiles and wall friction coefficients. Main-stream velocities ranging from 17 to 60 feet per second were used, the main-stream Euler number was zero, and a length Reynolds number R_x variation of 4×10^4 to 3×10^6 was investigated. The dimensionless ratio v_0/u_1 of blowing velocity to main-stream velocity was maintained constant, independent of length, in a given experiment. Values of v_0/u_1 of 0, 0.001, 0.002, 0.003, 0.005, and 0.010 were used. The experimental results were compared with the results of earlier work and significant differences were observed. In particular, at the same values of v_0/u_1 and R_x , the present experiments result in friction coefficients 15 to 30 percent smaller than those reported earlier.

The observed friction coefficients are predicted by mixture-length theory if the Reynolds number at the outer edge of the laminar sublayer is permitted to vary with v_0/u_1 .

INTRODUCTION

This report covers work carried out at the Massachusetts Institute of Technology under the sponsorship and with the financial assistance of the National Advisory Committee for Aeronautics. The results presented herein deal with the effect on the turbulent boundary layer of blowing gas through a porous flat plate into a main airstream flowing parallel to the plate.

An earlier report (ref. 1) has presented the results of experimental measurements of boundary-layer velocity and temperature profiles and wall friction and heat transfer coefficients for flow over a flat plate with blowing or suction and with blowing and main-stream acceleration. The experiments of reference 1 were made using air as both the main-stream and blowing or suction fluid. The present work was undertaken with the

intention of exploring the effect of blowing a gas other than air through the porous wall and into the main airstream. Experiments were carried out in which a helium-air mixture was blown through the porous wall and into the main airstream. Analysis of these experimental results showed that the equipment was not behaving properly. Material balances would not close and the measurements were not reproducible. When this situation became apparent, the primary experiments were stopped and an investigation of the cause of the anomalous behavior of the tunnel started. Prolonged work finally uncovered the source of the trouble. A glass heater cloth, supposedly securely fastened to the back side of the screen forming the porous wall, had become slack in certain regions. This permitted fluid from the main stream to flow behind the porous wall. The flow by-pass passage thus formed was only 0.01 to 0.03 inch deep, but its effect was readily discernible in the material balances. This tunnel defect was eliminated by removal of the heater cloth. This seriously restricted the capability of the tunnel with respect to heat transfer measurements. Following this alteration of the tunnel, checks of the tunnel operation gave satisfactory results.

The discovery of the tunnel defect raised questions concerning the reliability of some unpublished results as well as of the work reported in reference 1. Consequently, it was decided to delay the original program and to repeat some of the earlier work in which air was blown through the porous wall and into the main airstream. This report deals with new measurements of velocity profiles and wall friction coefficients in a turbulent boundary layer formed by the interaction of a uniform-velocity main stream flowing parallel to a porous wall through which air is blown normal to the main stream. These results are compared with earlier work and with the predictions of various theories.

SYMBOLS

The units reported are those directly measured in the experimental work.

c_f local friction coefficient, $2\tau_o/\rho_1 u_1^2$

E Euler number, $\frac{-x \frac{dp}{dx}}{\rho_1 u_1^2} = \frac{x}{u_1} \frac{du_1}{dx}$

H ratio of displacement to momentum thickness, δ_1/δ

K mixture-length constant

m	dimensionless distance into boundary, $y/\bar{\delta}$
p	static pressure
R_x	length Reynolds number, $u_1 x \rho / \mu$
$R_{\bar{\delta}}$	boundary-layer-thickness Reynolds number, $u_1 \bar{\delta} \rho / \mu$
R_{δ}	momentum-thickness Reynolds number, $u_1 \delta \rho / \mu$
s	slope of relation between $\bar{\delta}$ and δ (see eq. (25))
u	local velocity in x direction, fps
u_1	main-stream velocity, fps
u_τ	friction velocity, $u_1 \sqrt{c_f/2}$, fps
u'	dimensionless velocity ratio, u/u_τ
$u'_a y'_a$	Reynolds number at outer edge of laminar sublayer, $u_a \rho y_a / \mu$
v	local velocity in y direction, fps
x	distance downstream from leading edge of plate measured parallel to plate, in.
y	normal distance from plate, in.
y'	dimensionless distance, $\frac{\rho_1 u_1 \sqrt{c_f/2} y}{\mu}$
β	dimensionless profile factor, u/u_1
δ	boundary-layer thickness, somewhat indefinite distance to outer edge of boundary layer, in.
δ_1	displacement thickness of boundary layer (see eq. (2)), in.
$\bar{\delta}$	99-percent thickness of boundary layer; defined as value of y at which $u/u_1 = 0.990$, in.
δ	momentum thickness of boundary layer (see eq. (1)), in.
τ	local shear stress

Subscripts:

- a conditions at outer edge of laminar sublayer
- o conditions at wall where $y = 0$

EQUIPMENT USED IN EXPERIMENTAL STUDIES

The experimental apparatus used in these studies is shown in figure 1. The apparatus was designed to simulate two-dimensional flow over a porous flat plate with both suction and injection of material into the boundary layer. Provision was also made to study accelerated flow by means of a flexible bottom wall used to change the cross-sectional area of the tunnel.

The details of the equipment are described in reference 1. Only the main features of the apparatus and the revisions made as a result of the present work will be reported here.

The main-stream air is supplied by a centrifugal blower (see fig. 1) to a calming section 2 fitted with a honeycomb of mailing tubes designed to reduce vortex motion and turbulence. The calming chamber discharges into a nozzle 3. The air from the calming chamber then enters the tunnel 4 which has a rectangular cross section. The top wall of the tunnel 5 is used as the test wall. This is made from 80-mesh Jelliff Lectromesh screen 0.004 inch thick. The top wall is roughly 12 feet long and 1 foot wide. The space behind the test wall is divided into 15 separate compartments. Each compartment has its own independent gas supply line. Provision is made for boundary-layer removal immediately upstream of the leading edge of the test wall 6 in order to simulate a sharp leading edge on a flat plate. The bottom wall of the tunnel is flexible and mounted on a ladderlike support which can be adjusted by screw jacks 7. This arrangement was used to obtain constant main-stream velocity by adjusting the tunnel area. Openings were provided in the bottom wall at various intervals for insertion of the traversing gear used in measuring profiles in the boundary layer.

The air issuing from the flow divider at the tunnel exit is allowed to discharge into the atmosphere. The long metal duct 8 (see fig. 1) is used for air intake. This technique gives better control of boundary-layer removal and also reduces fluctuations in main-stream velocity by stabilizing the flow at the fan inlet.

The slots provided in the side wall to allow for boundary-layer removal were completely closed off. This was done to insure further two-dimensional flow. Clauser (ref. 2) has reported having extreme

difficulty obtaining two-dimensional flow because of boundary layers migrating out of the tunnel through small slots in the test wall. Admittedly, adverse pressure gradients were used in his work, but it was decided not to risk this added difficulty.

The flow divider was used to control the static pressure level in the tunnel and also the pressure distribution. It was found that without the flow divider the boundary layer was noticeably thinner near the outlet of the tunnel than would be expected. It was concluded that end effects were propagating back up the tunnel because of the nonuniform egress of the air from the tunnel. When the flow divider was installed this effect was eliminated.

When fluids other than air were blown into the boundary layer, gas of the desired composition was prepared by continuously mixing metered streams of the second fluid (helium) and air in an external mixing section. This mixed gas was then supplied and separately metered to each compartment along the top wall. Periodically, a gas sample was taken from each compartment supply line and analyzed. The results of the analysis were in excellent agreement with the composition calculated from the measured flow rates of the helium and airstreams.

The first measurements made with helium and air mixtures blown into the main airstream showed that the tunnel was not behaving properly. Material balances failed to close to within the estimated experimental errors, and measurements made on different days under supposedly the same operating conditions differed by a small but nevertheless significant amount. Every aspect of the tunnel was carefully examined. Finally, it was found that velocity profile measurements made with very small and carefully calibrated probes indicated a finite velocity at the wall. Disassembly of the top wall revealed that the woven Fiberglas Nichrome wire heating cloth (shown as item 9, section AA of fig. 1) had become slack. As a result, a passage was formed which permitted fluid to flow behind the porous screen parallel to the direction of main-stream flow. In order to eliminate these channels, the Fiberglas cloth was removed. Fine glass beads 0.011 inch in diameter were poured into each compartment until a uniform layer $3/4$ inch thick rested directly on top of the Lectromesh screen. Subsequent checks of the tunnel indicated that this alteration had solved the problem. Material balances now closed. The measurements were reproducible at will. Velocity profiles extrapolated to zero at the wall. No three-dimensional effects could be discerned.

The removal of the glass heater cloth had one serious disadvantage. The top wall could not be heated without blowing hot gas through the compartment. It appeared that major construction changes would be required to retain this feature. Consequently, it was decided to postpone heat transfer measurements until time permitted a new top wall to be built.

EXPERIMENTAL PROCEDURE

The basic experimental procedure was as follows:

- (1) Main-stream velocity was set by means of fan speed.
- (2) Boundary-layer removal was adjusted by means of a throttle located in the air-intake line.
- (3) The bottom wall was adjusted to make dp/dx or du_1/dx equal zero.
- (4) The blowing gas (if any) was turned on. The mass transfer distribution was adjusted by means of the valves in each line supplying air to each compartment.
- (5) Profiles were measured at nine different x positions along the top wall with the tunnel operating at steady state.

RANGE OF MEASUREMENTS

The experimental measurements reported here deal solely with the momentum-transfer process in a turbulent boundary layer formed by blowing air through a porous flat plate into a main airstream flowing at constant main-stream velocity parallel to the plate.

The work completed to date using a gas other than air as the injected fluid has been exploratory in nature. The data obtained are too fragmentary to warrant publication at this date.

Experimental measurements are reported for the following range of flow conditions:

Main-stream velocity, u_1 , fps	17 to 60
Length Reynolds number, R_x	0.4 to 30×10^5
Blowing velocity, v_0 , fps	0.03 to 0.25
Dimensionless blowing ratio, v_0/u_1	0 to 0.010

Runs were made at $v_0/u_1 = 0, 0.001, 0.002, 0.003, 0.005, \text{ and } 0.010$. Air was the only material injected into the boundary layer. At each blowing ratio v_0/u_1 , at least two different values of u_1 were used in order to see if v_0/u_1 was truly a correlating parameter for the skin-friction data rather than some other function of v_0 . Previous work had not been conclusive on this point.

CODE USED TO DESIGNATE EXPERIMENTAL DATA

The following system was used to designate a run. The first letter C indicates the fact that the main-stream velocity was constant, as it was in all runs reported. The second group gives the value of the dimensionless blowing ratio v_0/u_1 multiplied by 10^3 . The third group is the approximate average value of the main-stream velocity at which the run was made. The product of the second and third groups gives the value of v_0 used in that particular run.

Thus, C-1-50 is a run made at constant main-stream velocity with $v_0/u_1 = 1 \times 10^{-3}$ at a main-stream velocity u_1 of 50 feet per second with $v_0 = 0.05$ foot per second; C-0-50 is a run with a constant main-stream velocity u_1 of 50 feet per second with $v_0/u_1 = 0$.

MEASUREMENT AND CALCULATION TECHNIQUE

Velocity Profiles

Boundary-layer velocity profiles were measured at nine different x stations along the top wall. Depending on the boundary-layer thickness, 15 to 30 profile points were taken at each station. Two separate measurements of the static pressure were made at each station. One was made using the wall static taps and the other by use of a static probe inserted into the main stream. No significant pressure gradient was observed in the y-direction by this technique.

A specially constructed flat probe was used to obtain impact pressures in the boundary layer. The measured impact pressures were used to calculate velocities in the boundary layer. The probe was made as follows. A short piece of nickel tubing with an outside diameter of 0.025 inch and 0.0025-inch wall thickness was flattened into a broad narrow tip. The probe tip was 0.008 inch high with an opening of 0.003 inch and 0.0025-inch walls. This made a small probe capable of measuring within 0.004 inch of the wall or to y' values of the order of 2 to 6. The tip was then silver soldered to progressively larger sizes of stainless tubing until an inside diameter of 0.25 inch was reached. The length of very small tubing was kept to a minimum and with this system the response time proved to be excellent.

The impact pressures used in calculating the velocity profiles were measured by means of Prandtl type micromanometers using n-heptane as the measuring fluid. These could be read to within ± 0.0005 inch of n-heptane.

One manometer was used to measure the profile impact pressures and another used to measure the tunnel main-stream velocity. This latter manometer was used to facilitate setting and adjusting the main-stream velocity and to hold it constant during a run.

The reference pressure for the profile manometer was atmospheric. The main-stream velocity manometer was referenced to the tunnel static pressure so that it gave a direct measure of tunnel velocity u_1 . The probe was brought into contact with the top wall by means of an electronic contact indicator. With this device the $y = 0$ point could be reproduced within ± 0.0005 inch.

Boundary-Layer Thickness

The measured velocity profiles were used to calculate the boundary-layer momentum thickness

$$\theta = \int_0^{\infty} \frac{u}{u_1} \left(1 - \frac{u}{u_1}\right) dy \quad (1)$$

and the boundary-layer displacement thickness

$$\delta_1 = \int_0^{\infty} \left(1 - \frac{u}{u_1}\right) dy \quad (2)$$

at each station. The integrations were performed on an International Business Machines Corp. digital computer. All of the raw data points were used to evaluate the integral quantities.

Friction Coefficients

Local friction coefficients were evaluated by means of the Von Kármán momentum equation with the terms involving products of the fluctuating velocity components neglected:

$$\frac{d\theta}{dx} - \frac{v_0}{u_1} + \left(2 + \frac{\delta_1}{\theta}\right) \frac{\theta}{u_1} \frac{du_1}{dx} = \frac{\tau_0}{\rho_1 u_1^2} = \frac{c_f}{2} \quad (3)$$

It is believed that except in the vicinity of the separation point or at very high blowing rates the fluctuating terms may be safely neglected. In the present experiments du_1/dx was approximately zero.

EXPERIMENTAL RESULTS

Velocity Profiles

Experimental data.- Velocity profiles were measured under the experimental conditions shown in table I. The test fluid used for both main and blowing streams was air. Traverses were made at selected stations varying from 11.17 to 96.55 inches from the leading edge. In any given run both the main-stream velocity and the local blowing velocity were maintained essentially constant and independent of distance from the leading edge. In order to test the validity of v_0/u_1 as a correlating parameter, measurements were made for a fixed value of v_0/u_1 in at least two separate runs employing significantly different main-stream velocities. The complete velocity profile measurements are tabulated in table II.

Accuracy of measurement.- The reproducibility (precision) of a velocity measurement reported here is

$$\frac{\Delta u}{u} = \frac{1.8}{u^2} \quad (4)$$

where u is measured in feet per second. This precision is better than that obtained in earlier work reported in reference 1 and results from improved techniques. Near the wall, the accuracy of the velocity measurements is poorer than that indicated by equation (4).

Near the wall, the interpretation of impact-tube measurements is not well understood. Even when the impact-tube Reynolds number is greater than 30 (as was always the case in the present work), the presence of a wall seems to affect the impact-tube calibration. Preston (ref. 3) has observed that near a wall the fluid velocity is proportional to the impact pressure to the $7/8$ power. Trilling and Hakkinen have shown in an unpublished paper that when the probe is completely immersed in the laminar sublayer, the velocity is proportional to the $3/5$ power of the impact pressure. The conventional pitot-tube expression, based upon Bernoulli's equation, assumes the velocity to be proportional to the square root of the impact pressure. These findings cast considerable doubt on any conventional interpretation of an impact-tube reading made in or partly in the laminar sublayer. In view of the fact that additional uncertainties are introduced by blowing, no attempt was made to alter Bernoulli's equation when applied to impact measurements made in the sublayer.

The position of the probe with respect to the wall was also subject to some uncertainty. The value of y reported in table II is the distance from the center of the probe opening to the wall. This value is uncertain by ± 0.001 inch. Near the wall, the effective probe center is displaced relative to the geometric center as a result of the transverse velocity gradients. This factor also reduces the reliability of measurements made in or partly in the laminar sublayer.

It is believed that the errors due to turbulent fluctuations and probe yaw were not important.

Momentum and Displacement Thickness

The measured velocity profiles were used in conjunction with equations (1) and (2) to calculate the values of the momentum thickness θ and displacement thickness δ_1 by means of numerical integration with the aid of a digital computer. The resulting values of θ and δ_1 are tabulated in table I.

The reproducibility of δ_1 and θ is estimated to be

$$\frac{\Delta\delta_1}{\delta_1} \approx \frac{1.8}{u_1^2} \quad (5)$$

$$\frac{\Delta\theta}{\theta} \approx \frac{3.6}{u_1^2} \quad (6)$$

where u_1 is in feet per second. The errors in δ_1 and θ are somewhat greater than equations (5) and (6) indicate. This is due to the fact that, although reproducible, the absolute values of the velocity near the wall are uncertain.

Local Friction Coefficients

Values of the local friction coefficients were calculated from the experimental data by means of Von Kármán momentum equation (3). The values are tabulated in table I.

The uncertainty in the calculated friction coefficients depends upon the relative magnitudes of the terms on the right-hand side of the momentum equation. In blowing runs, the local friction coefficient is

obtained as the small difference between two quantities of the same magnitude. In addition, one of these quantities ($d\theta/dx$) is obtained by differentiation of experimental results, a process which inherently involves loss in precision. In the course of calculating the friction coefficients from the experimental data, the precision of the final result was estimated. These precision estimates are tabulated below.

Run	Blowing velocity ratio, v_0/u_1	Estimated precision of friction coefficient, percent
C-0-50; C-0-60	0.000	± 10
C-1-30; C-1-50	.001	± 12
C-2-25; C-2-50	.002	± 15
C-3-17; C-3-33; C-3-50	.003	± 30
C-5-20; C-5-40	.005	Friction data highly uncertain
C-5-30; C-5-50		
C-10-20; C-10-26	.01	Friction data have no significance

For v_0/u_1 values above 0.003, the friction-coefficient data are so uncertain that no reliable conclusions can be drawn from them. At these high blowing rates, the data often indicated negative values of the coefficients. However, the measured velocity profiles gave no evidence of flow separation.

ANALYSIS AND DISCUSSION

Constant Main-Stream Velocity, No Blowing

Velocity profiles.— The velocity profile data of run C-0-60 are plotted in the form of u' as a function of $\log y'$ in figure 2. The solid line shown represents the relation

$$u' = 5.6 \log y' + 4.9 \quad (7)$$

which Clauser (ref. 2) has shown to be in excellent agreement with the smooth-plate data of Ludweig and Tillmann (ref. 4), Klebanoff and Diehl (ref. 5), Freeman (ref. 6), and Schultz-Grunow (ref. 7) over the range $20 = y' = 400$. There is good reason to believe that turbulent-boundary-layer data obtained from smooth-plate flow should follow equation (7) over the range indicated. The present data fulfill this condition, indicating that the tunnel behaved like a smooth plate and that the present measurement techniques were adequate.

A second comparison of the velocity profile data obtained in this investigation with the results of others is shown in figure 3. Here,

the velocity defect $\frac{1 - \{u/u_1\}}{\sqrt{c_f/2}}$ is plotted as a function of y/δ for

run C-0-60; δ is the boundary-layer thickness, and, following Clauser (ref. 2), is taken to be

$$\delta = \frac{3.6\delta_1}{\sqrt{c_f/2}} \quad (8)$$

where δ_1 is the displacement thickness. The area enclosed by the lines in figure 3 encompasses the data given in references 2 and 5 to 8 for constant-pressure turbulent-boundary-layer profiles for both smooth and rough walls. The available evidence suggests that this plot is a universal correlation of constant-pressure boundary-layer profiles. The data obtained in the present work follow this relation.

Friction coefficients.- The measured local friction coefficients for all no-blowing runs are shown plotted as a function of length Reynolds number R_x in figure 4. The solid line represents the relation

$$c_f/2 = \frac{0.0289}{R_x^{0.2}} \quad (9)$$

Although empirical, over the Reynolds number range of this work equation (9) is a good representation of available flat-plate, constant-pressure flow data. The agreement between the observed friction coefficients and the data of other workers is good.

The comparison of the no-blowing boundary-layer data obtained in this study with the work of others strongly suggests that the tunnel test wall behaved like a smooth flat plate and that the measurement techniques were adequate. It appears that the tunnel modifications successfully eliminated the anomalous behavior noted early in the work. It is believed, however, that the results reported in reference 1 were influenced by tunnel aberrations. In the previous work, the experimentally determined friction coefficients for no blowing were about 15 percent higher than those observed here.

Constant Main-Stream Velocity, Blowing

Velocity profiles.- Typical velocity profiles are shown in figures 5(a), 5(b), 6, and 7. In these plots, the ordinate is $\beta = u/u_1$ and the abscissa is $m = y/\bar{\delta}$ where $\bar{\delta}$ is the value of y at which $u/u_1 = 0.990$.

Figure 5(a) presents the data of run C-3-50, corresponding to $v_0/u_1 = 0.003$, and figure 5(b) presents the data of run C-5-20, corresponding to $v_0/u_1 = 0.005$. Examination of these profiles shows that for a given blowing ratio the dimensionless profiles are not strictly similar but form a clustered family.

Figure 6 compares the profiles obtained for run C-3-50 at station H ($R_x = 7.50 \times 10^5$), run C-3-33 at station J ($R_x = 7.44 \times 10^5$), and run C-3-17 at station M ($R_x = 7.40 \times 10^5$). Although the main-stream velocities for these runs differ by a factor of 3, the comparison is made at the same Reynolds number. (Note that when v_0/u_1 and R_x are the same for different runs, the momentum-thickness Reynolds numbers R_θ and the boundary-layer-thickness Reynolds numbers R_δ are also equal.) When compared on this basis, the dimensionless velocity profiles are roughly similar.

Figure 7 illustrates the effect of blowing on the velocity profiles. Each curve represents a different value of v_0/u_1 . However, the boundary-layer-thickness Reynolds number R_δ is roughly the same for all the curves. The effect of blowing is clear. At a given value of $m = y/\bar{\delta}$, increasing the blowing ratio v_0/u_1 results in a significant reduction of $\beta = u/u_1$.

In view of the correlating success of a plot of $\frac{1 - (u/u_1)}{\sqrt{c_f/2}}$ as a function of y/δ for the no-blowing case, this procedure was applied to the blowing data. It was not successful. At a given value of v_0/u_1 greater than zero, this method of plotting spread the profile data.

Friction coefficients.- The measured friction coefficients are shown plotted as a function of Reynolds number in figures 8(a), 8(b), 9(a), and 9(b). In each case the ordinate is the local coefficient $c_f/2$ and each curve corresponds to a fixed value of v_0/u_1 . In figures 8(a) and 8(b) the abscissa is length Reynolds number R_x ; in figures 9(a)

and 9(b) the abscissa is the momentum-thickness Reynolds number R_δ . Although the local friction coefficients for $v_0/u_1 = 0.005$ are shown, these data are highly uncertain and represent order-of-magnitude values only. Either of the two correlating techniques is equally satisfactory. These results strongly indicate that for constant-main-stream-velocity flow at constant values of v_0/u_1 , the local friction coefficient is solely a function of the blowing ratio v_0/u_1 and a characteristic Reynolds number.

Blowing has a marked effect on the local friction coefficient. At $R_x = 10^6$, for $v_0/u_1 = 0$, $c_f/2 = 0.0018$, while for $v_0/u_1 = 0.003$, $c_f/2 = 0.00038$, a reduction, due to blowing, of a factor of 4.7 in the local coefficient.

Figure 10 compares the present friction-coefficient data with that obtained before alteration of the tunnel. The solid lines correspond to the present results, the dashed lines represent the constant-main-stream-velocity data of reference 1. At given values of v_0/u_1 and R_x , the friction coefficients reported in the earlier work are significantly greater than those observed after modification of the tunnel. The present data are believed to be more reliable.

COMPARISON WITH THEORY

Mixture-Length Analysis

Rubesin (ref. 9) has presented a one-dimensional mixture-length treatment of the effect of blowing upon a compressible, turbulent boundary layer. When both the main and injected streams are considered incompressible and of the same composition, his results reduce to the following equations:

The formula for predicting the velocity profile for the laminar sublayer ($0 \leq y' \leq y'_a$) is

$$y' = \frac{2u_\tau}{v_0} \log_e \left(1 + \frac{v_0 u'}{u_\tau} \right)^{1/2} \quad (10)$$

and that for predicting the profile for the turbulent core ($y'_a \leq y'$) is

$$\log_e \frac{y'}{y'_a} = \frac{2Ku_T}{v_o} \left[\left(1 + \frac{v_o u'}{u_T} \right)^{1/2} - \left(1 + \frac{v_o u'_a}{u_T} \right)^{1/2} \right] \quad (11)$$

The formula for predicting the friction coefficient is

$$\log_e \frac{KR_\delta}{y'_a \left(1 + \frac{v_o}{u_T \sqrt{c_f/2}} \right)^{1/2}} = \frac{2Ku_T}{v_o} \left[\left(1 + \frac{v_o}{u_T \sqrt{c_f/2}} \right)^{1/2} - \left(1 + \frac{v_o u'_a}{u_T} \right)^{1/2} \right] \quad (12)$$

Combination of equation (12) and Von Kármán momentum equation (3) gives, for the special case of constant main-stream velocity,

$$\frac{\log_e R_x K (c_f/2) \left(1 + \frac{v_o}{u_T \sqrt{c_f/2}} \right)^{1/2}}{y'_a} = \frac{2Ku_T}{v_o} \left[\left(1 + \frac{v_o}{u_T \sqrt{c_f/2}} \right)^{1/2} - \left(1 + \frac{v_o u'_a}{u_T} \right)^{1/2} \right] \quad (13)$$

In the above relations, the subscript a refers to conditions at the outer edge of the laminar sublayer. It is assumed in the derivation that the junction between the sublayer and the turbulent core is sharp; that is, the thickness of the buffer layer is assumed to be zero. The symbol K is the mixture-length constant.

For the no-blowing case, Rubesin tabulates the values of K, u'_a, and y'_a which best fit the extensive turbulent-boundary-layer data. These values are tabulated below

Mixture-length constants	Method of evaluation		
	From velocity profile data (inner portion of turbulent layer)	From c _f -versus-R _δ data	From c _f -versus-R _x data
K	0.400	0.352	0.392
u'_a	11.5	12.6	13.1
y'_a	11.5	12.6	13.1

It will be immediately evident that the numerical values of the mixture-length constants depend upon the evaluation technique employed. These differences are due to the inadequacies of the mixture-length theory and to the mathematical approximations involved in the derivation. In the case of blowing, experimental data must be used to determine the best values of the mixture-length constants.

Examination of equation (11) shows that if the theory is correct, a plot of the measured velocity profiles in the form of $\log_e y'$ versus

$\left(1 + \frac{v_0 u'_a}{u_\tau}\right)^{1/2}$ should result in a straight line provided that only the

turbulent portion of the boundary layer is considered. The slope of

this line is $2Ku_\tau/v_0$ and the intercept at $y' = 1$ is $\left(1 + \frac{v_0 u'_a}{u_\tau}\right)^{1/2}$

$\frac{v_0}{2Ku_\tau} \log_e y'_a$. The measured velocity profiles are plotted in this manner

in figures 11(a) to 11(d). A straight line of slope $2Ku_\tau/v_0$ with $K = 0.400$ has been fitted to the data in the vicinity of $y' = 20$ and is shown as a solid line in the figures. Over the inner portion of the turbulent boundary layer ($10 \leq y' \leq 200$) the theoretical line is a reasonable representation of the velocity profile data. As expected, the data depart from the mixture-length line in the outer portion of the turbulent layer and in the sublayer region.

If a method of predicting the value of the Reynolds number $u_a' y_a'$ at the outer edge of the laminar sublayer were available, the intercept of the velocity profile could be determined from mixture-length theory. In an attempt to establish a prediction technique, numerical values of y_a' , u_a' , and $u_a' y_a'$ were calculated for each measured velocity profile by the following procedure. The value of the mixture-length constant K was taken to be 0.400 and equation (11) was fitted to each profile. This resulted in one relation between u_a' and y_a' . Introduction of equation (10) then permitted u_a' and y_a' to be calculated for each profile. The accuracy of such calculations was poor. The straight-line plotting technique based upon equation (11) introduces the experimental errors of both the velocity profile measurements and the local friction coefficient. In addition, the precision of the calculation was low. Alternate fitting techniques gave results for a given profile differing by as much as 10 percent. The following table gives the mean of the computed values for a fixed value of v_0/u_1 :

v_0	y_a'		u_a'		$u_a'y_a'$	
	Mean value	Variation, percent	Mean value	Variation, percent	Mean value	Variation, percent
0	11.5	--	11.5	---	132	---
.001	11.5	± 3	13.7	± 5	157	± 8
.002	11.5	± 3	18.9	± 7	217	± 10
.003	10.3	± 6	26.1	± 9	268	± 15
.005	5.9	± 9	35.0	± 12	206	± 22

The columns labeled "variation" give the variation found among the calculated quantities from profiles obtained at a fixed value of v_0/u_1 . For example, at $v_0/u_1 = 0.005$, the profiles examined gave values of $u_a'y_a'$ ranging from 161 to 251, that is, ± 22 percent from the mean of 206. Inasmuch as errors may be responsible for a large part of the variation, quantitative conclusions are not warranted. Qualitatively, u_a' and $u_a'y_a'$ increase with increasing values of v_0/u_1 . Despite their poor accuracy, the results rather definitely indicate that u_a' and $u_a'y_a'$ must be permitted to vary with v_0/u_1 if mixture-length theory is used.

At a fixed value of v_0/u_1 , u_a' tends to increase with increasing length Reynolds number. The trend of y_a' is less definite but it appears to decrease with increasing Reynolds number. Values of u_a' and of y_a' obtained from one profile of a sequence often departed significantly from the general trend. As a result, the values of $u_a'y_a'$ fluctuated widely and no definite trend of $u_a'y_a'$ with R_x at constant v_0/u_1 could be discerned. The profile results suggest that $u_a'y_a'$ may be a function of v_0/u_1 alone, but the data cannot be considered to support this conjecture adequately.

There is no assurance that the value of K should be independent of the blowing rate. The velocity profiles suggest that K increases as v_0/u_1 is increased. However, below values of v_0/u_1 of 0.005, any effect is small. The strongest indication is found from the profiles for $v_0/u_1 = 0.01$. Although no friction data are available for this case, the situation may be treated in the following way. For large values of v_0/u_1 , the data indicate that $c_f/2$ is very small and in the turbulent region of the boundary layer $\frac{v_0 u_1'}{u_\tau} \gg 1$. Under such circumstances, equation (11) reduces to

$$\log_e \frac{y}{y_a} = \frac{2K}{\sqrt{v_0/u_1}} \left[\left(\frac{u}{u_1} \right)^{1/2} - \left(\frac{u_a}{u_1} \right)^{1/2} \right] \quad (14)$$

Consequently, a plot of $\log_e y$ versus $(u/u_1)^{1/2}$ should be a straight line of slope $2K/\sqrt{v_0/u_1}$. Profiles for run C-10-26 are shown plotted in this manner in figure 12. The solid lines represent a value of $K = 0.400$. The dashed lines represent $K = 0.550$. The higher value of K appears to be a better fit of the data.

The local-friction-coefficient data were also employed to examine the predictions of mixture-length theory. Equation (12) was compared with the $c_f/2$ and R_x data and equation (13) was compared with the $c_f/2$ and R_x data. In either case, the procedure used involved determining the constants of the mixture-length equations from one experimental value of $c_f/2$ at a fixed value of v_0/u_1 and Reynolds number. The constants so determined were then used in the mixture-length expression and the predicted values of $c_f/2$ were calculated over the experimental range of Reynolds number. The curves of $c_f/2$ versus Reynolds number at fixed values of v_0/u_1 calculated from the mixture-length equations were then compared with the corresponding experimental curves. In every case it was assumed that sublayer relation (10) was valid; this determined y'_a in terms of u'_a .

The relation between $c_f/2$ and R_x predicted by equation (13) was tested first. The mixture-length constant K was taken to be 0.392, the value which best fits the extensive no-blowing data. Numerical values of u'_a and y'_a were then found by fitting equations (10) and (13) to one data point at $R_x \approx 10^6$ for each value of v_0/u_1 . It was assumed then that at a given value of v_0/u_1 , u'_a was constant. Using this value of u'_a , the curve of $c_f/2$ versus R_x was calculated by means of equations (10) and (13) over the range of experimental data. This technique did not result in satisfactory agreement between experiment and theory.

In view of the indication given by the velocity profile data that the sublayer Reynolds number $u'_a y'_a$ might be a function of v_0/u_1 only, this assumption was tried. Again with $K = 0.392$, $u'_a y'_a$ was determined for each value of v_0/u_1 by fitting equations (10) and (13) to one experimental point at $R_x \approx 10^6$. The resulting values of $u'_a y'_a$ are shown plotted versus v_0/u_1 in figure 13. With the value of $u'_a y'_a$ determined at each value of v_0/u_1 from one experimental point, the rest

of the curve of $c_f/2$ versus R_x was calculated by assuming $u'_a y'_a$ to be invariant with R_x at constant values of v_0/u_1 . A comparison of the calculated and experimental curves is shown in figures 8(a) and 8(b). The correspondence is good; the agreement between theory and experiment on this basis is well within the experimental error. Further, the plot of $u'_a y'_a$ versus v_0/u_1 shown in figure 13 discloses a happy circumstance - over the range $0.001 \leq v_0/u_1 \leq 0.005$, $u'_a y'_a$ is linear in v_0/u_1 and the relation

$$u'_a y'_a = 195 + 2.5(10^4) (v_0/u_1) \quad (15)$$

holds. For no blowing, equation (15) gives $u'_a y'_a = 195$ or $u'_a = y'_a = 13.96$ which is 6.5 percent greater than the customary value of 13.1. This discrepancy may well be due to the fact that no starting length correction was applied to the present experimental $c_f/2$ and R_x data.

The comparison of the experimental $c_f/2$ and R_s data with the predictions of equations (10) and (12) was made in the same fashion. The value of K was taken to be 0.352, independent of v_0/u_1 and R_s . One experimental point for each value of v_0/u_1 was then used to calculate u'_a and y'_a and the product $u'_a y'_a$. The laminar-sublayer Reynolds number $u'_a y'_a$ found in this manner was then plotted as a function of v_0/u_1 . It was found (see fig. 13) that the straight-line relation

$$u'_a y'_a = 158.6 + 2.5(10^4) (v_0/u_1) \quad (16)$$

fitted the calculated values with a maximum deviation of 5 percent. Consequently, equation (16) was used in conjunction with equations (10) and (12) to calculate values of $c_f/2$ over the range of v_0/u_1 and R_s covered by the experimental results. A comparison of the values of $c_f/2$ calculated in this fashion and the experimental values is shown in figures 9(a) and 9(b). The measured and calculated values agree to within the experimental error.

It is clear that over the Reynolds number range $5 \times 10^5 \leq R_x \leq 3 \times 10^6$ or $1,000 \leq R_s \leq 7,000$ and blowing-velocity-ratio range $0 \leq v_0/u_1 \leq 0.005$, the mixture-length equations (10) to (13) may be used to predict the measured local friction factors provided that the laminar-sublayer Reynolds number is permitted to vary with v_0/u_1 . In order to predict $c_f/2$ as a function of R_x , use equations (10), (13),

(15), and $K = 0.392$. In order to predict $c_f/2$ as a function of R_s , use equations (10), (12), (16), and $K = 0.352$. It is to be emphasized that the experimental friction-coefficient data are less accurate than the precision with which the mixture-length equations fit them. At values of v_o/u_1 of 0.003, the reported experimental coefficients are subject to errors of ± 30 percent and even larger errors are possible at values of v_o/u_1 of 0.005.

Mixture-length-theory relations are a reasonable fit of the measured velocity profiles over the inner portion of the turbulent layer up to values of v_o/u_1 of 0.005 if the mixture-length constant K is taken to be 0.400. However, such a fit demands that $u_a'y_a'$ vary with v_o/u_1 and possibly with other quantities. The data reported here are not sufficiently accurate to permit the formulation of a reliable method for predicting $u_a'y_a'$ for the purpose of calculating velocity profiles.

The chief value of an essentially heuristic approach like that of mixture-length theory is in correlation and extrapolation of experimental data. Over the ranges listed above, it is a satisfactory local-friction-coefficient correlation method. It is known that in the no-blowing case the mixture-length predictions hold up to $R_x \approx 10^8$ and that velocity profiles and friction coefficients as a function of momentum-thickness Reynolds number R_s are reasonably predicted when nonseparating pressure distributions are imposed. It is likely, therefore, that in the case of blowing the mixture-length predictions will prove to be satisfactory at higher Reynolds numbers and a fair approximation when nonseparating pressure gradients are imposed. Experimental confirmation of this conjecture is needed.

Extrapolation to values of v_o/u_1 greater than 0.005 must be made with caution. The velocity-profile data suggest that at $v_o/u_1 = 0.01$ a larger value of K is needed. An analysis based upon use of the measured values of the boundary-layer thickness points in the same direction.

The measured velocity profiles determine the momentum thickness θ and the boundary-layer thickness δ . Since δ is difficult to obtain quantitatively from profile data, it is convenient to replace it by δ , the value of y at which $u/u_1 = 0.990$. Now, consider mixture-length relations (11) and (12). Gloss over the experimental evidence that the best fit of the velocity profiles entails somewhat different values of K and $u_a'y_a'$ than the best fit of the $c_f/2$ and R_s data. Take K and $u_a'y_a'$ to be independent of the type of data to be fitted. Then, combination of equations (11) and (12) gives

$$\frac{\log_e y' \left(1 + \frac{v_o}{u_1 c_f / 2}\right)^{1/2}}{KR_s} = \frac{2Ku_T}{v_o} \left[\left(1 + \frac{v_o u'}{u_T}\right)^{1/2} - \left(1 + \frac{v_o}{u_T c_f / 2}\right)^{1/2} \right] \quad (17)$$

Now, introduce the definitions

$$y' = \frac{\rho u_1 \sqrt{c_f / 2} y}{\mu} \quad (18)$$

$$u' = \frac{u}{u_T} = \frac{u}{u_1 \sqrt{c_f / 2}} \quad (19)$$

$$\bar{\delta} = y \quad \left(\frac{u}{u_1} = 0.990 \right) \quad (20)$$

into equation (17). There results

$$\log_e \frac{(\bar{\delta} / y) \left(\frac{c_f}{2} + \frac{v_o}{u_1} \right)^{1/2}}{K} = 2Ku_T \left(1 + \frac{v_o}{u_1 c_f / 2} \right)^{1/2} - \left[\frac{\left(1 + 0.99 \frac{v_o}{u_1 c_f / 2} \right)^{1/2}}{\left(1 + \frac{v_o}{u_1 c_f / 2} \right)} - 1 \right] \quad (21)$$

But

$$\left(\frac{1 + 0.99 \frac{v_o}{u_1 c_f / 2}}{1 + \frac{v_o}{u_1 c_f / 2}} \right)^{1/2} = \left(1 - \frac{0.01 \frac{v_o}{u_1} \frac{c_f}{2}}{1 + \frac{v_o}{u_1} \frac{c_f}{2}} \right)^{1/2} \approx 1 - \frac{0.01 \frac{v_o}{u_1} \frac{c_f}{2}}{2 \left(1 + \frac{v_o}{u_1} \frac{c_f}{2} \right)} \quad (22)$$

Combination of equations (21) and (22) gives

$$\bar{\delta}/\delta = \frac{\frac{K}{\left[(c_f/2) + (v_o/u_1) \right]^{1/2}}}{\exp \frac{0.01K}{\left[(c_f/2) + (v_o/u_1) \right]^{1/2}}} \quad (23)$$

When the experimental values of $\bar{\delta}$ are plotted as a function of δ , a straight line of the form

$$\bar{\delta} = s\delta \quad (24)$$

represents the data for a fixed value of v_o/u_1 to within the probable precision of the measurements. This is illustrated in figure 14. The slope of the line is a distinct function of v_o/u_1 as shown as follows:

v_o/u_1	$\bar{\delta}/\delta$ or slope s	$\frac{K}{\left[(c_f/2) + (v_o/u_1) \right]^{1/2}}$	Mean value of K
0.001	8.0	8.7	0.41
.002	7.5	8.1	.43
.003	7.0	7.5	.44
.005	6.5	5.5	.40
.010	5.6	6.0	.58

The values of $K / \left[(c_f/2) + (v_o/u_1) \right]^{1/2}$ shown above were calculated from equation (23) using the experimental values of $\bar{\delta}/\delta$. The column labeled "Mean value of K " was calculated using the mean value of $c_f/2$ of the experimental data at a given value of v_o/u_1 . The data for $v_o/u_1 = 0.005$ show a trend with main-stream velocity. For run C-5-50, $\bar{\delta}/\delta = 6.8$; for run C-5-20, $\bar{\delta}/\delta = 6.0$. Runs C-5-30 and C-5-40 lie within the above limits. The value of $\bar{\delta}/\delta$ of 6.5 given above is a mean of all runs at $v_o/u_1 = 0.005$.

The table just presented indicates that a satisfactory correlation of the experimental data over the range $0 \leq v_0/u_1 \leq 0.005$ should result if K is taken to be constant and independent of v_0/u_1 . This is confirmed by the other comparisons presented earlier. On the other hand, the data at $v_0/u_1 = 0.01$ indicate that a larger mixture-length constant is needed. The present velocity profile data at $v_0/u_1 = 0.01$ leave much to be desired, however, and it is felt that both a check of these measurements and additional measurements at high positive values and negative values of v_0/u_1 are needed before a definite statement is warranted.

CONCLUSIONS

An investigation of the effect on the boundary layer of blowing air through a porous flat plate into a main airstream flowing parallel to the plate results in the following conclusions:

1. With zero Euler number flow and constant blowing velocity, specification of the blowing velocity ratio v_0/u_1 and the local Reynolds number R_x fixes the local dimensionless velocity profile and local friction coefficient.

2. The present results indicate that blowing has a larger effect on the boundary layer than that found in earlier experiments. At the same values of v_0/u_1 and R_x , the present experiments result in friction coefficients 15 to 30 percent smaller than those reported earlier. The new measurements are believed to be more reliable.

3. Within the blowing-velocity-ratio range $0 \leq v_0/u_1 \leq 0.005$ and over the turbulent-flow Reynolds number range experimentally investigated ($5 \times 10^5 \leq R_x \leq 3 \times 10^6$ or $1,000 \leq R_\delta \leq 7,000$ where R_δ is momentum-thickness Reynolds number); the mixture-length equations of Rubesin (NACA TN 3341) adequately predict the measured local friction factors provided that the laminar-sublayer Reynolds number is permitted to vary with v_0/u_1 . Equations are presented which predict the local friction coefficient as a function of R_x for flow with zero Euler number and $K = 0.392$ and as a function of R_δ with $K = 0.352$ where K is the mixture-length constant. The experimental friction coefficients are less accurate than the precision with which the mixture-length equations fit them. Extrapolation of the equations to values of v_0/u_1 greater than 0.005 must be made with caution. The velocity profile data suggest that at values of v_0/u_1 above 0.005 the value of K increases

with increasing values of v_0/u_1 . It is likely that the mixture-length predictions will prove to be satisfactory at higher Reynolds numbers and to be a fair approximation when nonseparating pressure gradients are imposed. Experimental confirmation of this conjecture is needed.

Mixture-length relations are a reasonable fit of the measured velocity profiles over the inner portion of the turbulent layer up to values of v_0/u_1 of 0.005 if K is taken to be 0.400. At larger values of v_0/u_1 , larger values of K are indicated. In order to fit mixture-length theory with the experimental profiles, $u_a'y_a'$ must vary with v_0/u_1 and possibly with other flow variables. The present data are not sufficiently accurate to permit the formulation of a reliable method of predicting $u_a'y_a'$ for the purpose of the calculation of velocity profiles.

Massachusetts Institute of Technology,
Cambridge, Mass., January 9, 1956.

REFERENCES

1. Mickley, H. S., Ross, R. C., Squyers, A. L., and Stewart, W. E.: Heat, Mass, and Momentum Transfer for Flow Over a Flat Plate With Blowing or Suction. NACA TN 3208, 1954.
2. Clauser, Francis H.: Turbulent Boundary Layers in Adverse Pressure Gradients. Jour. Aero. Sci., vol. 21, no. 2, Feb. 1954, pp. 91-108.
3. Preston, J. H.: The Determination of Turbulent Skin Friction by Means of Pitot Tubes. Jour. R.A.S., vol. 58, no. 518, Feb. 1954, pp. 109-121.
4. Ludweig, H., and Tillmann, W.: Investigations of the Wall-Shearing Stress in Turbulent Boundary Layers. NACA TM 1285, 1950.
5. Klebanoff, P. S., and Diehl, Z. W.: Some Features of Artificially Thickened Fully Developed Turbulent Boundary Layers With Zero Pressure Gradient. NACA Rep. 1110, 1952. (Supersedes NACA TN 2475.)
6. Freeman, Hugh B.: Measurements of Flow in the Boundary Layer of a 1/40-Scale Model of the U. S. Airship "Akron." NACA Rep. 430, 1932.
7. Schultz-Grunow, F.: New Frictional Resistance Law for Smooth Plates. NACA TM 986, 1941.
8. Moore, Walter L.: An Experimental Investigation of the Boundary-Layer Development Along A Rough Surface, Ph.D. Thesis and Contract N8-onr-500, Dept. of Mech. and Hydraulics, Univ. of Iowa and Office Naval Res., Aug. 1951.
9. Rubesin, Morris W.: An Analytical Estimation of the Effect of Transpiration Cooling on the Heat-Transfer and Skin-Friction Characteristics of a Compressible, Turbulent Boundary Layer. NACA TN 3341, 1954.

TABLE I.- SUMMARY OF EXPERIMENTAL VELOCITY PROFILE MEASUREMENTS AND FRICTION FACTORS

Station	x, in.	u_1 , fps	R_x	δ_1 , in.	δ , in.	H	R_δ	v_0/u_1	δ/x	$c_f/2$
Run C-0-50										
E	11.17	50.2	0.274×10^6	0.04385	0.03291	1.332	810	0	2.957×10^{-3}	2.58×10^{-5}
G	21.73	50.8	.545	.06703	.05165	1.298	1298	0	2.381	1.998
H	29.73	50.8	.734	.08697	.06599	1.318	1639	0	2.226	1.868
I	38.42	51.0	.955	.1080	.08207	1.315	2044	0	2.140	1.796
J	46.48	51.2	1.155	.1308	.09779	1.337	2432	0	2.106	1.767
K	58.55	51.1	1.452	.1624	.1223	1.328	3055	0	2.090	1.754
L	70.44	51.2	1.762	.1818	.1367	1.329	3420	0	1.941	1.629
M	83.55	51.3	2.092	.1981	.1507	1.315	3776	0	1.805	1.515
N	96.55	51.4	2.422	.2338	.1770	1.321	4442	0	1.834	1.539
Run C-0-50 (a)										
E	11.17	50.3	0.279	0.04608	0.03585	1.285	900	0	3.221	2.68
G	21.73	50.8	.549	.06857	.05304	1.293	1342	0	2.445	2.044
H	29.73	50.8	.752	.09309	.06950	1.339	1761	0	2.341	1.957
I	38.42	51.0	.976	.1119	.08389	1.353	2155	0	2.187	1.829
J	46.48	50.9	1.180	.13028	.09695	1.344	2461	0	2.087	1.745
K	58.55	51.1	1.492	.1401	.10312	1.359	2630	0	1.762	1.643
L	70.44	51.0	1.793	.1881	.1399	1.345	3560	0	1.986	1.660
M	83.55	51.6	2.150	.2041	.1531	1.331	3940	0	1.833	1.533
N	96.55	51.8	2.495	.2308	.1737	1.329	4490	0	1.800	1.505
Run C-0-60										
E	11.17	58.0	0.323	0.04053	0.03157	1.284	917	0	2.856	2.25
G	21.73	58.2	.632	.06609	.0509	1.298	1485	0	2.347	1.941
H	29.73	58.2	.846	.09256	.07013	1.319	2040	0	2.362	1.856
I	38.42	58.2	1.100	.1107	.08367	1.323	2400	0	2.182	1.805
J	46.48	58.6	1.362	.1257	.09493	1.324	2782	0	2.044	1.691
K	58.55	58.6	1.690	.1510	.11405	1.324	3291	0	1.949	1.612
L	70.44	58.5	2.030	.1834	.1378	1.331	3970	0	1.957	1.619
M	83.55	58.6	2.412	.2023	.1529	1.323	4420	0	1.831	1.515
N	96.55	58.5	2.780	.2337	.1772	1.319	5100	0	1.856	1.519
Run C-1-50										
E	11.17	50.5	0.277	0.04889	0.0337	1.452	856	1.00	3.020	1.605
G	21.73	50.4	.543	.08176	.06093	1.341	1523	.988	2.804	1.432
H	29.73	50.3	.741	.1119	.08193	1.368	2042	1.00	2.691	1.320
I	38.42	50.4	.959	.1346	.09839	1.366	2456	1.00	2.561	1.210
J	46.48	50.8	1.167	.1591	.1164	1.366	2922	1.00	2.504	1.160
K	58.55	50.6	1.467	.1914	.1396	1.370	3497	1.00	2.384	1.055
L	70.44	51.0	1.762	.2283	.1660	1.370	4100	.990	2.356	.980
M	83.55	50.9	2.085	.2597	.1899	1.366	4737	1.00	2.278	.960
N	96.55	50.7	2.40	.3016	.2198	1.370	5462	1.02	2.276	.936
Run C-1-50										
E	11.17	29.2	0.162	0.04783	0.0358	1.341	518	0.983	3.20	1.780
G	21.73	29.4	.318	.08572	.06209	1.373	910	1.00	2.863	1.470
H	29.73	29.3	.434	.1185	.08480	1.394	1236	1.025	2.990	1.432
I	38.42	29.5	.565	.1436	.1028	1.395	1513	1.00	2.680	1.310
J	46.48	29.85	.692	.1667	.1226	1.360	1826	1.00	2.64	1.277
K	58.55	29.70	.867	.2135	.1521	1.400	2152	1.00	2.60	1.240
L	70.44	29.80	1.045	.2741	.1790	1.400	2655	1.00	2.54	1.190
M	83.55	30.3	1.242	.3007	.2072	1.430	3080	1.00	2.48	1.140
N	96.55	30.3	1.447	.3403	.2345	1.440	3515	1.00	2.43	1.095
Run C-2-50										
E	11.17	49.5	0.265	0.06336	0.04383	1.450	1042	2.021	3.938	1.359
G	21.73	50.1	.522	.1042	.07363	1.415	1775	2.001	3.395	.914
H	29.73	50.0	.714	.1362	.1062	1.420	2331	2.00	3.267	.807
I	38.42	50.3	.928	.1707	.1185	1.442	2861	1.90	3.089	.750
J	46.48	50.9	1.136	.2119	.1400	1.460	3422	1.91	3.012	.680
K	58.55	50.7	1.427	.3046	.1720	1.450	4193	1.97	2.958	.650
L	70.44	51.1	1.731	.3159	.2188	1.440	5380	2.06	3.107	.620
M	83.55	50.9	2.042	.3439	.2494	1.420	6100	1.980	2.986	.590
N	96.55	51.4	2.385	.3910	.2832	1.410	7000	1.976	2.934	.549

*Flow divider omitted.

TABLE I.- SUMMARY OF EXPERIMENTAL VELOCITY PROFILE MEASUREMENTS AND FRICTION FACTORS - Continued

Station	x, in.	u_1 , fps	R_x	δ_1 , in.	δ , in.	H	R_δ	v_0/u_1	δ/x	$c_x/2$
Run C-2-25										
E	11.17	23.62	0.1307 × 10 ⁶	0.06239	0.04416	1.411	519	2.00 × 10 ⁻³	3.968 × 10 ⁻³	1.410 × 10 ⁻³
G	21.73	24.00	.2585	.1106	.07909	1.400	943	2.00	3.646	1.151
H	29.73	23.85	.352	.1546	.1073	1.440	1273	2.11	3.620	1.00
I	38.42	24.02	.458	.1788	.1249	1.430	1510	2.00	3.400	.920
J	46.48	24.25	.560	.2320	.1631	1.420	1972	2.15	3.512	.870
K	58.55	24.40	.709	.2809	.1902	1.430	2305	2.00	3.250	.800
L	70.44	24.61	.862	.3260	.2252	1.440	2760	2.000	3.200	.750
M	83.55	24.82	1.050	.3680	.2505	1.460	3150	1.900	3.000	.680
N	96.55	24.90	1.195	.4250	.2895	1.470	3584	2.000	3.000	.580
Run C-3-50										
E	11.17	49.2	0.276	0.06553	0.0456	1.437	1155	3.04	4.097	0.680
G	21.73	50.2	.548	.1160	.08186	1.417	2069	2.95	3.774	.485
H	29.73	50.2	.750	.1639	.1122	1.461	2830	3.00	3.779	.436
I	38.42	51.2	.989	.1982	.1367	1.450	3525	2.90	3.564	.340
J	46.48	51.3	1.198	.2518	.1689	1.491	4360	2.96	3.636	.330
K	58.55	51.5	1.516	.2998	.2039	1.470	5290	2.90	3.485	.270
L	70.44	51.6	1.825	.3620	.2538	1.485	6320	2.86	3.462	.290
M	83.55	52.2	2.187	.4026	.2783	1.447	7290	2.80	3.332	.250
N	96.55	52.2	2.530	.4766	.3271	1.460	8570	2.83	3.389	.250
Run C-3-33										
E	11.17	32.15	0.176	0.0729	0.04956	1.470	785	3.20	4.453	0.850
G	21.73	32.50	.347	.1229	.08502	1.445	1359	3.00	3.919	.562
H	29.73	32.40	.473	.1690	.1141	1.481	1817	2.98	3.843	.515
I	38.42	33.0	.622	.2207	.1490	1.480	2410	3.00	3.878	.480
J	46.48	33.3	.744	.2644	.1779	1.486	2850	3.07	3.830	.410
K	58.55	33.3	.958	.3213	.2192	1.468	3591	3.01	3.750	.400
L	70.44	33.4	1.156	.3731	.2605	1.440	4280	3.00	3.700	.365
M	83.55	33.8	1.388	.4409	.3070	1.436	5110	3.00	3.677	.340
N	96.55	33.92	1.670	.4936	.3435	1.437	5950	2.950	3.563	.290
Run C-3-17										
E	11.17	16.97	0.0375	0.06879	0.04809	1.430	161.5	3.00	4.305	0.911
G	21.73	17.00	.1866	.1273	.09402	1.407	777	2.99	4.161	.751
H	29.73	16.85	.253	.1705	.1200	1.420	1021	2.99	4.036	.680
I	38.42	17.00	.330	.2129	.1468	1.450	1260	2.90	3.820	.570
J	46.48	17.23	.404	.2700	.1830	1.460	1606	3.00	3.980	.620
K	58.55	17.15	.507	.3292	.2223	1.481	1922	2.90	3.796	.550
L	70.44	17.25	.614	.3979	.2678	1.486	2335	2.97	3.801	.486
M	83.55	17.82	.740	.4676	.3185	1.470	2820	3.01	3.812	.455
N	96.55	17.62	.860	.5253	.3591	1.463	3200	2.97	3.719	.410
Run C-5-50										
E	11.17	49.5	0.274	0.0864	0.0600	1.518	1400	5.25	5.370	0.190
G	21.73	50.8	.548	.1644	.1089	1.510	2750	5.12	5.020	-----
H	29.73	51.2	.755	.2389	.1499	1.594	3815	5.08	5.048	-----
I	38.42	51.4	.980	.2903	.1847	1.572	4720	5.06	4.816	-----
J	46.48	51.8	1.197	.3513	.2100	1.591	5690	5.02	4.515	-----
K	58.55	52.5	1.526	.4163	.2671	1.559	6960	4.95	4.565	-----
L	70.44	52.7	1.830	.5146	.3268	1.575	8480	4.93	4.641	-----
M	83.55	53.2	2.180	.5739	.3723	1.541	9730	4.88	4.458	-----
N	96.55	53.8	2.565	.6659	.4343	1.533	11920	4.83	4.500	-----
Run C-5-40										
E	11.17	39.0	0.214	0.0922	0.0598	1.542	1147	5.13	5.373	0.220
G	21.73	39.5	.421	.1656	.1091	1.517	2120	5.06	5.029	-----
H	29.73	39.7	.580	.2449	.1555	1.574	3035	5.03	5.237	.100
I	38.42	40.4	.762	.2959	.1914	1.545	3805	4.95	4.990	.070
J	46.48	41.6	.951	.3696	.2422	1.526	4955	4.81	5.215	.080
K	58.55	41.2	1.187	.4679	.3013	1.552	6110	4.85	5.150	.060
L	70.44	41.4	1.433	.5856	.3631	1.607	7380	4.83	5.156	.050
M	83.55	41.9	1.725	.6093	.4200	1.536	8190	4.77	5.030	.040
N	96.55	42.3	2.010	.7196	.4800	1.537	9740	4.73	4.970	-----

TABLE I.- SUMMARY OF EXPERIMENTAL VELOCITY PROFILE MEASUREMENTS AND FRICTION FACTORS - Concluded

Station	x, in.	u_1 , fps	R_x	δ_1 , in.	δ , in.	H	R_δ	v_0/u_1	θ/x	$c_f/2$
^a Run C-5-30										
E	11.17	29.2	0.167 × 10 ⁶	0.0949	0.0625	1.518	939	5.13 × 10 ⁻³	5.615 × 10 ⁻³	-----
G	21.73	29.5	.329	.1695	.1134	1.495	1720	5.07	5.228	-----
H	29.73	29.7	.453	.2340	.1514	1.546	2310	5.03	5.099	-----
I	38.42	30.4	.596	.3063	.1967	1.577	3060	4.93	5.129	-----
J	46.48	30.5	.725	.3803	.2402	1.583	3750	4.93	5.172	-----
K	58.55	30.8	.924	.4506	.2923	1.542	4615	4.85	4.996	-----
L	70.44	30.8	1.108	.5486	.3419	1.605	5390	4.78	4.855	-----
M	83.55	31.6	1.343	.6019	.3853	1.562	6200	4.74	4.614	-----
N	96.55	31.8	1.562	.7053	.4483	1.573	7260	4.68	4.645	-----
Run C-5-20										
E	11.17	18.9	0.104	0.0950	0.0646	1.469	603	5.28	5.807	0.33 × 10 ⁻³
G	21.73	19.0	.203	.1845	.1198	1.540	1120	5.17	5.523	.26
H	29.73	19.3	.282	.2638	.1723	1.529	1635	5.40	5.810	.21
I	38.42	19.4	.366	.3242	.2069	1.567	2005	5.06	5.395	.15
J	46.48	19.8	.453	.4029	.2609	1.544	2545	5.32	5.618	.11
K	58.55	19.9	.572	.4679	.3007	1.536	2960	5.04	5.140	-----
L	70.44	20.1	.700	.6029	.3796	1.588	3770	5.10	5.391	.10
M	83.55	20.2	.834	.6366	.4119	1.546	4165	4.96	4.930	-----
N	96.55	20.5	.982	.6903	.4533	1.523	4612	4.87	4.697	-----
^a Run C-10-26										
E	11.17	25.7	0.143	0.1599	0.0988	1.618	1265	10.1	8.88	-----
G	21.72	26.4	.284	.3314	.2013	1.646	2635	9.86	9.28	-----
H	29.72	26.6	.392	.4696	.2743	1.712	3620	9.77	9.23	-----
I	38.42	26.9	.510	.5989	.3403	1.562	4530	9.65	8.87	-----
J	46.48	28.0	.642	.6764	.3983	1.698	5510	9.28	8.57	-----
K	58.55	28.0	.810	.8319	.4816	1.727	6700	9.28	8.23	-----
L	70.44	28.6	.994	.9749	.5403	1.804	7620	9.10	7.67	-----
M	83.55	29.1	1.215	1.096	.6126	1.789	10180	8.93	7.34	-----
N	96.55	30.1	1.432	1.073	.6913	1.552	10230	8.65	7.16	-----
^a Run C-10-20										
E	11.17	19.7	0.108	0.1799	0.1109	1.577	1075	10.2	9.96	-----
G	21.73	19.4	.207	.3916	.2298	1.704	2197	10.3	10.59	-----
H	29.73	19.6	.286	.5056	.2894	1.747	2790	10.2	9.75	-----
I	38.42	20.5	.387	.5856	.3393	1.726	3425	9.76	8.85	-----
J	46.48	20.8	.476	.6829	.4083	1.673	4180	9.61	8.79	-----
K	58.55	20.9	.604	.8585	.4926	1.745	5080	9.54	8.92	-----
L	70.44	21.3	.728	.9239	.5500	1.814	5260	9.40	7.23	-----
M	83.55	21.5	.872	1.035	.6300	1.704	6340	9.31	6.27	-----
N	96.55	21.9	1.030	1.082	.7050	1.689	6830	9.11	6.64	-----

^aSkin-friction coefficients computed for these runs showed erratic behavior and were at times negative; consequently, skin-friction coefficients for these runs are not reported.

TABLE II.- EXPERIMENTAL VELOCITY PROFILE DATA

(a) Run C-0-50; $v_o/u_1 = 0$; $u_1 = 50$ fps; $v_o = 0$ fps

y, in.	u/u_1 for station ^a -								
	E	G	H	I	J	K	L	M	N
0.010	0.435	0.486	0.413	0.352	0.347	0.365	0.368	0.354	0.339
.015	.471	.535	.500	.466	.371	.417	.404	.433	.409
.020	.564	.593	.563	.534	.463	.490	.465	.493	.467
.025	.618	.621	.594	.568	.523	.534	.519	.529	.506
.030	.651	.642	.616	.594	.559	.555	.542	.552	.527
.035	.672	.660	.630	.613	.579	.575	.558	.570	.547
.040	.682	.667	.642	.626	.596	.584	.578	.579	.560
.050	.708	.686	.661	.639	.619	.608	.595	.593	.580
.060	.731	.705	.675	.658	.641	.623	.607	.614	.590
.070	.753	.714	.682	.671	.654	.631	.624	.629	.611
.080	.774	.730	.698	.680	.670	.650	.637	.636	.611
.090	.791	.743	.709	.691	.675	.662	.643	.643	.631
.100	.808	.751	.720	.700	.681	.671	.655	.655	.633
.150	.877	.801	.765	.750	.724	.705	.691	.690	.673
.200	.934	.849	.805	.784	.759	.738	.720	.718	.702
.250	.973	.887	.842	.812	.786	.760	.748	.738	.722
.300	.988	.920	.879	.837	.811	.784	.767	.758	.739
.350	.991	.952	.904	.869	.834	.809	.785	.778	.752
.400	.995	.973	.930	.888	.844	.830	.801	.802	.775
.500	-----	.993	.972	.933	.902	.845	.841	.827	.805
.600	-----	1.000	.994	.966	.931	.880	.872	.858	.834
.700	-----	-----	-----	.986	.963	.919	.900	.888	.861
.800	-----	-----	-----	.995	.987	.948	.930	.911	.886
.900	-----	-----	-----	-----	.998	.970	.952	.932	.897
1.000	-----	-----	-----	-----	1.000	.991	.970	.948	.924
1.200	-----	-----	-----	-----	-----	-----	.992	.980	.953
1.400	-----	-----	-----	-----	-----	-----	.999	.993	.976
1.600	-----	-----	-----	-----	-----	-----	-----	.997	.994
1.800	-----	-----	-----	-----	-----	-----	-----	1.000	.997

^a x distances corresponding to lettered stations are listed in table I.

TABLE II.- EXPERIMENTAL VELOCITY PROFILE DATA - Continued

(b) Run C-0-50; $v_0/u_1 = 0$; $u_1 = 50$ fps; $v_0 = 0$

y, in.	u/u ₁ for station ^a -								
	E	G	H	I	J	K	L	M	N
0.010	0.434	0.492	0.383	0.324	0.313	0.354	0.325	0.337	0.303
.015	.545	.553	.464	.436	.421	.454	.419	.337	.406
.020	.603	.597	.530	.507	.496	.507	.480	.485	.475
.025	.639	.626	.568	.551	.533	.539	.515	.520	.505
.030	.659	.641	.586	.573	.561	.551	.529	.537	.519
.035	.675	.658	.607	.597	.579	.571	.550	.547	.544
.040	.692	.667	.619	.609	.587	.582	.562	.560	.547
.050	.716	.686	.644	.632	.611	.604	.586	.582	.573
.060	.737	.701	.660	.646	.626	.611	.601	.603	.589
.070	.758	.716	.673	.656	.625	.623	.613	.615	.603
.080	.775	.729	.688	.673	.651	.643	.624	.623	.612
.090	.791	.741	.698	.686	.661	.650	.633	.635	.620
.100	.806	.755	.706	.696	.674	.658	.641	.652	.629
.150	.874	.797	.756	.736	.718	.699	.676	.675	.667
.200	.931	.845	.795	.774	.752	.729	.704	.706	.692
.250	.961	.883	.835	.805	.778	.759	.734	.735	.725
.300	.977	.916	.865	.837	.812	.780	.762	.756	.742
.350	.984	.946	.899	.862	.837	.806	.777	.767	.758
.400	.988	.970	.922	.886	.861	.827	.798	.794	.772
.500	.994	.992	.965	.930	.904	.987	.832	.823	.808
.600	.998	.998	.991	.965	.939	.903	.870	.855	.839
.700	-----	.999	.998	.986	.970	.932	.898	.883	.860
.800	-----	1.000	.999	.999	.986	.956	.924	.906	.881
.900	-----	-----	-----	-----	.996	.979	.951	.928	.903
1.000	-----	-----	-----	-----	1.000	.992	.967	.951	.926
1.200	-----	-----	-----	-----	-----	-----	.993	.980	.960
1.400	-----	-----	-----	-----	-----	-----	1.000	.995	.981
1.600	-----	-----	-----	-----	-----	-----	-----	.998	.995
1.800	-----	-----	-----	-----	-----	-----	-----	1.000	.999

^a x distances corresponding to lettered stations are listed in table I.

TABLE II.- EXPERIMENTAL VELOCITY PROFILE DATA - Continued

(c) Run C-0-60; $v_0/u_1 = 0$; $u_1 = 60$ fps; $v_0 = 0$

y, in.	u/u ₁ for station ^a -								
	E	G	H	I	J	K	L	M	N
0.004	0.372	0.350	0.328	0.279	0.306	0.297	0.291	0.283	0.277
.006	.417	.401	.331	.309	.330	.314	.298	.286	.289
.008	.464	.453	.381	.361	.374	.358	.332	.336	.298
.010	.599	.493	.437	.408	.427	.406	.376	.373	.390
.015	.586	.559	.519	.488	.491	.487	.460	.462	.461
.020	.626	.603	.556	.539	.540	.527	.503	.493	.495
.025	.648	.621	.583	.564	.561	.556	.534	.530	.528
.030	.672	.637	.604	.588	.579	.566	.551	.543	.543
.035	.683	.657	.615	.597	.588	.583	.565	.564	.556
.040	.696	.668	.627	.615	.600	.600	.575	.576	.564
.050	.724	.688	.646	.636	.622	.609	.591	.593	.585
.060	.744	.705	.666	.647	.636	.626	.604	.609	.602
.070	.762	.716	.676	.660	.648	.636	.622	.616	.608
.080	.778	.729	.686	.676	.657	.652	.633	.627	.615
.090	.799	.742	.699	.686	.676	.665	.640	.637	.625
.100	.813	.749	.703	.696	.685	.669	.653	.646	.637
.150	.889	.805	.756	.741	.728	.704	.682	.684	.668
.200	.941	.845	.797	.774	.757	.737	.712	.708	.694
.250	.975	.888	.835	.804	.789	.759	.740	.735	.720
.300	.990	.923	.867	.837	.813	.784	.759	.749	.736
.350	.992	.955	.896	.860	.840	.813	.782	.771	.756
.400	.995	.975	.925	.890	.862	.832	.803	.784	.775
.500	.999	.995	.967	.931	.903	.869	.839	.828	.805
.600	1.000	1.000	.988	.964	.939	.907	.868	.853	.832
.700	-----	-----	.995	.986	.969	.938	.904	.880	.856
.800	-----	-----	.996	.996	.989	.960	.924	.905	.879
.900	-----	-----	-----	1.000	1.000	.981	.952	.927	.905
1.000	-----	-----	-----	-----	-----	.993	.968	.950	.914
1.200	-----	-----	-----	-----	-----	1.000	.993	.978	.954
1.400	-----	-----	-----	-----	-----	-----	1.000	1.000	.978
1.600	-----	-----	-----	-----	-----	-----	-----	-----	.996
1.800	-----	-----	-----	-----	-----	-----	-----	-----	1.000

^a x distances corresponding to lettered stations are listed in table I.

TABLE II.- EXPERIMENTAL VELOCITY PROFILE DATA - Continued

(d) Run C-1-50; $v_0/u_1 = 1 \times 10^{-3}$; $u_1 = 50$ fps; $v_0 = 0.05$ fps

y, in.	u/u ₁ for station ^a -								
	E	G	H	I	J	K	L	M	N
0.004	0.374	0.341	0.302	0.263	0.286	0.276	0.250	0.253	0.255
.006	.390	.355	.322	.317	.315	.299	.264	.259	.263
.008	.429	.410	.365	.358	.357	.334	.303	.273	.271
.010	.480	.444	.404	.399	.383	.378	.334	.315	.316
.015	.556	.519	.470	.462	.441	.436	.399	.390	.387
.020	.589	.552	.509	.495	.486	.483	.446	.436	.431
.025	.618	.579	.545	.526	.508	.505	.471	.474	.466
.030	.639	.596	.559	.541	.527	.524	.484	.494	.470
.035	.653	.620	.581	.554	.543	.546	.498	.514	.492
.040	.662	.625	.588	.568	.557	.552	.512	.529	.499
.050	.689	.647	.609	.589	.576	.571	.531	.543	.535
.060	.702	.663	.620	.604	.589	.579	.548	.550	.539
.070	.722	.678	.635	.618	.607	.593	.566	.565	.547
.080	.744	.687	.647	.634	.623	.609	.572	.583	.563
.090	.760	.700	.660	.645	.627	.620	.583	.591	.575
.100	.776	.712	.670	.656	.635	.620	.587	.598	.591
.150	.845	.760	.719	.697	.683	.666	.631	.633	.615
.200	.916	.812	.760	.729	.714	.696	.664	.662	.643
.250	.962	.850	.793	.767	.753	.711	.690	.692	.672
.300	.984	.891	.835	.797	.772	.745	.718	.710	.698
.350	.993	.924	.858	.827	.797	.766	.734	.737	.708
.400	.996	.950	.891	.857	.825	.790	.754	.750	.728
.500	1.000	.992	.943	.901	.863	.824	.790	.770	.754
.600	-----	.999	.979	.938	.907	.861	.825	.810	.787
.700	-----	1.000	.998	.974	.932	.893	.854	.844	.816
.800	-----	-----	1.000	.993	.970	.926	.882	.870	.835
.900	-----	-----	-----	1.000	.989	.952	.912	.890	.859
1.000	-----	-----	-----	-----	1.000	.971	.934	.905	.873
1.200	-----	-----	-----	-----	-----	1.000	.968	.950	.922
1.400	-----	-----	-----	-----	-----	-----	1.000	.982	.950
1.600	-----	-----	-----	-----	-----	-----	-----	.993	.976
1.800	-----	-----	-----	-----	-----	-----	-----	1.000	.991
2.000	-----	-----	-----	-----	-----	-----	-----	-----	1.000

^a x distances corresponding to lettered stations are listed in table I.

TABLE II.- EXPERIMENTAL VELOCITY PROFILE DATA - Continued

(e) Run C-1-30; $v_o/u_1 = 1 \times 10^{-3}$; $u_1 = 30$ fps; $v_o = 0.03$ fps

y, in.	u/u_1 for station ^a -								
	E	G	H	I	J	K	L	M	N
0.004	0.313	0.297	0.288	0.238	0.260	0.270	0.243	0.193	0.334
.006	.329	.302	.306	.279	.282	.277	.251	.234	.340
.008	.367	.346	.317	.297	.297	.301	.270	.274	.358
.010	.423	.381	.355	.303	.340	.334	.300	.298	.415
.020	.549	.516	.476	.445	.432	.446	.429	.414	.452
.030	.634	.597	.556	.535	.503	.512	.490	.470	.505
.040	.686	.627	.594	.562	.549	.545	.517	.521	.527
.050	.704	.668	.619	.606	.577	.568	.530	.540	.535
.060	.727	.670	.632	.618	.597	.582	.546	.553	.567
.070	.742	.695	.651	.623	.598	.609	.564	.568	.576
.080	.772	.704	.665	.646	.624	.616	.579	.588	.570
.090	.780	.714	.676	.665	.646	.617	.604	.588	.585
.100	.805	.714	.671	.667	.650	.628	.592	.591	.605
.200	.933	.812	.760	.738	.717	.689	.653	.660	.651
.300	.984	.896	.816	.797	.769	.755	.705	.718	.693
.400	1.000	.949	.896	.840	.822	.796	.741	.731	.733
.500	-----	.980	.939	.890	.864	.815	.733	.775	.755
.600	-----	1.000	.965	.940	.903	.855	.813	.792	.769
.700	-----	-----	1.000	.960	.930	.881	.844	.818	.797
.800	-----	-----	-----	.987	.950	.909	.878	.843	.820
.900	-----	-----	-----	1.000	.979	.937	.901	.875	.850
1.000	-----	-----	-----	-----	1.000	.950	.911	.886	.868
1.200	-----	-----	-----	-----	-----	1.000	.957	.926	.894
1.400	-----	-----	-----	-----	-----	-----	.976	.963	.934
1.600	-----	-----	-----	-----	-----	-----	1.000	.989	.958
1.800	-----	-----	-----	-----	-----	-----	-----	1.000	.975
2.000	-----	-----	-----	-----	-----	-----	-----	-----	1.000

^a x distances corresponding to lettered stations are listed in table I.

TABLE II.- EXPERIMENTAL VELOCITY PROFILE DATA - Continued

(f) Run C-2-50; $v_0/u_1 = 2 \times 10^{-3}$; $u_1 = 50$ fps; $v_0 = 0.10$ fps

y, in.	u/u ₁ for station ^a -								
	E	G	H	I	J	K	L	M	N
0.004	0.299	0.304	0.281	0.231	0.262	0.236	0.235	0.234	0.257
.006	.317	.324	.303	.277	.271	.253	.257	.246	.260
.008	.368	.362	.329	.316	.294	.292	.268	.281	.267
.010	.402	.411	.372	.345	.338	.325	.292	.301	.333
.020	.525	.508	.471	.447	.411	.425	.386	.431	.395
.030	.574	.556	.516	.485	.456	.473	.429	.486	.461
.040	.611	.580	.554	.517	.488	.491	.467	.507	.496
.050	.633	.606	.567	.549	.520	.508	.484	.510	.514
.060	.656	.613	.583	.557	.534	.522	.491	.547	.521
.070	.677	.634	.600	.577	.554	.551	.507	.557	.522
.080	.696	.652	.616	.582	.559	.548	.532	.547	.548
.090	.716	.664	.619	.599	.573	.570	.527	.576	.545
.100	.736	.669	.632	.602	.583	.570	.534	.595	.567
.200	.891	.769	.717	.690	.662	.643	.613	.643	.636
.300	.975	.852	.788	.756	.728	.701	.667	.670	.661
.400	.995	.926	.853	.819	.776	.654	.702	.711	.701
.500	.995	.974	.915	.859	.819	.691	.750	.738	.739
.600	1.000	.996	.957	.904	.864	.729	.781	.768	.754
.700	-----	1.000	.992	.946	.899	.769	.815	.784	.765
.800	-----	-----	1.000	.975	.931	.810	.840	.826	.796
.900	-----	-----	-----	1.000	.963	.913	.859	.842	.817
1.000	-----	-----	-----	-----	.976	.937	.896	.861	.836
1.200	-----	-----	-----	-----	1.000	.973	.946	.912	.868
1.400	-----	-----	-----	-----	-----	.996	.979	.936	.907
1.600	-----	-----	-----	-----	-----	1.000	.991	.971	.934
1.800	-----	-----	-----	-----	-----	-----	1.000	.990	.967
2.000	-----	-----	-----	-----	-----	-----	-----	1.000	.990
2.200	-----	-----	-----	-----	-----	-----	-----	-----	1.000

^a x distances corresponding to lettered stations are listed in table I.

TABLE II.- EXPERIMENTAL VELOCITY PROFILE DATA - Continued

(g) Run C-2-25; $v_0/u_1 = 2 \times 10^{-3}$; $u_1 = 25$ fps; $v_0 = 0.05$ fps

y, in.	u/u ₁ for station ^a -								
	E	G	H	I	J	K	L	M	N
0.004	0.296	0.292	0.307	0.225	0.261	0.228	0.199	0.173	0.165
.006	.296	.274	.324	.248	.273	.249	.199	.173	.195
.008	.314	.338	.328	.225	.289	.228	.223	.175	.182
.010	.385	.370	.336	.250	.324	.288	.211	.234	.165
.020	.500	.444	.381	.361	.396	.394	.245	.245	.239
.030	.594	.537	.448	.453	.464	.464	.302	.316	.327
.040	.635	.589	.532	.519	.518	.509	.340	.340	.376
.050	.668	.608	.550	.535	.506	.531	.355	.442	.383
.060	.697	.625	.574	.573	.527	.534	.356	.455	.389
.070	.712	.658	.602	.584	.532	.553	.390	.505	.428
.080	.750	.666	.620	.600	.557	.571	.382	.470	.426
.090	.743	.680	.630	.618	.570	.578	.423	.505	.448
.100	.758	.693	.628	.622	.594	.613	.444	.510	.414
.200	.888	.767	.720	.706	.661	.646	.508	.579	.526
.300	.960	.856	.767	.771	.714	.706	.583	.604	.600
.400	.991	.904	.838	.818	.748	.742	.637	.636	.625
.500	1.000	.956	.879	.856	.819	.772	.681	.654	.628
.600	-----	.976	.930	.881	.853	.814	.743	.686	.638
.700	-----	1.000	.956	.916	.877	.846	.764	.721	.703
.800	-----	-----	.990	.945	.895	.864	.777	.748	.706
.900	-----	-----	1.000	.973	.929	.876	.828	.752	.747
1.000	-----	-----	-----	1.000	.963	.900	.852	.812	.760
1.200	-----	-----	-----	-----	.992	.960	.909	.822	.786
1.400	-----	-----	-----	-----	1.000	.982	.937	.834	.867
1.600	-----	-----	-----	-----	-----	1.000	.964	.911	.877
1.800	-----	-----	-----	-----	-----	-----	1.000	.960	.904
2.000	-----	-----	-----	-----	-----	-----	-----	1.000	.957
2.200	-----	-----	-----	-----	-----	-----	-----	-----	.968
2.400	-----	-----	-----	-----	-----	-----	-----	-----	1.000

^a x distances corresponding to lettered stations are listed in table I.

TABLE II.- EXPERIMENTAL VELOCITY PROFILE DATA - Continued

(h) Run C-3-50; $v_0/u_1 = 3 \times 10^{-3}$; $u_1 = 50$ fps; $v_0 = 0.15$ fps

y, in.	u/u ₁ for station ^a -								
	E	G	H	I	J	K	L	M	N
0.004	0.303	0.317	0.276	0.269	0.248	0.232	0.221	0.211	0.227
.006	.337	.341	.304	.276	.248	.248	.235	.221	.229
.008	.377	.367	.329	.317	.251	.275	.244	.227	.229
.010	.408	.388	.351	.341	.282	.305	.267	.256	.244
.015	.468	.456	.404	.385	.333	.363	.317	.301	.284
.020	.506	.490	.439	.424	.376	.396	.358	.332	.339
.025	.534	.516	.459	.453	.396	.408	.370	.373	.361
.030	.555	.532	.474	.464	.421	.433	.387	.399	.391
.035	.564	.541	.500	.481	.441	.453	.401	.417	.400
.040	.581	.554	.510	.490	.443	.459	.417	.435	.411
.050	.606	.574	.526	.505	.463	.473	.430	.444	.433
.060	.630	.583	.541	.524	.483	.496	.464	.464	.438
.070	.652	.605	.555	.538	.500	.510	.474	.471	.451
.080	.669	.619	.570	.547	.509	.511	.474	.483	.458
.090	.686	.631	.576	.566	.522	.521	.488	.493	.478
.100	.702	.638	.594	.574	.535	.533	.492	.503	.493
.150	.789	.692	.633	.626	.576	.570	.540	.551	.515
.200	.866	.738	.672	.657	.615	.594	.579	.575	.570
.250	.927	.784	.706	.686	.634	.628	.591	.684	.586
.300	.968	.822	.755	.719	.674	.645	.626	.625	.599
.350	.992	.859	.783	.742	.703	.677	.652	.641	.620
.400	1.000	.896	.818	.773	.722	.687	.659	.659	.650
.500	-----	.954	.870	.823	.771	.733	.710	.691	.672
.600	-----	.989	.919	.870	.818	.770	.745	.726	.704
.700	-----	.999	.969	.912	.860	.806	.764	.736	.729
.800	-----	1.000	.989	.952	.890	.842	.803	.770	.742
.900	-----	-----	1.000	.972	.925	.868	.831	.803	.773
1.000	-----	-----	-----	.988	.957	.903	.856	.824	.789
1.200	-----	-----	-----	1.000	.991	.953	.906	.869	.828
1.400	-----	-----	-----	-----	1.000	.981	.937	.905	.866
1.600	-----	-----	-----	-----	-----	1.000	.977	.941	.901
1.800	-----	-----	-----	-----	-----	-----	.992	.967	.926
2.000	-----	-----	-----	-----	-----	-----	1.000	.988	.955
2.200	-----	-----	-----	-----	-----	-----	-----	1.000	.976
2.400	-----	-----	-----	-----	-----	-----	-----	-----	.993
2.600	-----	-----	-----	-----	-----	-----	-----	-----	1.000

^a x distances corresponding to lettered stations are listed in table I.

TABLE II.- EXPERIMENTAL VELOCITY PROFILE DATA - Continued

(i) Run C-3-33; $v_0/u_1 = 3 \times 10^{-3}$; $u_1 = 33$ fps; $v_0 = 0.10$ fps

y, in.	u/u ₁ for station ^a -								
	E	G	H	I	J	K	L	M	N
0.004	0.279	0.286	0.269	0.241	0.205	0.204	0.182	0.227	0.200
.006	.309	.298	.279	.259	.236	.230	.204	.238	.213
.008	.341	.317	.285	.264	.239	.224	.217	.255	.237
.010	.362	.352	.300	.274	.265	.242	.235	.275	.237
.020	.495	.457	.401	.371	.358	.350	.299	.371	.306
.030	.552	.521	.468	.441	.414	.416	.361	.422	.401
.040	.591	.552	.494	.482	.437	.438	.392	.444	.411
.050	.614	.578	.536	.500	.458	.462	.409	.499	.447
.060	.634	.593	.555	.523	.499	.489	.429	.509	.442
.070	.662	.608	.560	.534	.500	.498	.434	.525	.463
.080	.686	.614	.583	.555	.532	.506	.456	.538	.497
.090	.690	.629	.593	.568	.526	.520	.462	.538	.507
.100	.709	.650	.603	.578	.552	.541	.482	.555	.505
.200	.855	.740	.677	.657	.619	.599	.560	.597	.577
.300	.957	.818	.749	.714	.675	.655	.591	.619	.621
.400	.992	.887	.817	.758	.725	.702	.649	.651	.659
.500	.999	.941	.876	.807	.769	.737	.688	.686	.689
.600	1.000	.987	.917	.851	.814	.772	.722	.715	.721
.700	-----	1.000	.959	.892	.860	.799	.748	.733	.743
.800	-----	-----	.991	.921	.886	.831	.784	.753	.752
.900	-----	-----	1.000	.953	.915	.869	.802	.787	.777
1.000	-----	-----	-----	.976	.953	.882	.819	.814	.794
1.200	-----	-----	-----	1.000	.990	.937	.879	.856	.828
1.400	-----	-----	-----	-----	1.000	.967	.928	.896	.859
1.600	-----	-----	-----	-----	-----	1.000	.969	.930	.892
1.800	-----	-----	-----	-----	-----	-----	.983	.962	.925
2.000	-----	-----	-----	-----	-----	-----	1.000	.979	.946
2.200	-----	-----	-----	-----	-----	-----	-----	1.000	.978
2.400	-----	-----	-----	-----	-----	-----	-----	-----	1.000

^a x distances corresponding to lettered stations are listed in table I.

TABLE II.- EXPERIMENTAL VELOCITY PROFILE DATA - Continued

(j) Run C-3-17; $v_o/u_1 = 3 \times 10^{-3}$; $u_1 = 17$ fps; $v_o = 0.05$ fps

y, in.	u/u ₁ for station ^a -								
	E	G	H	I	J	K	L	M	N
0.004	0.326	0.292	0.279	0.221	0.249	0.191	0.263	0.216	0.172
.006	.367	.302	.318	.218	.271	.191	.272	.214	.233
.008	.334	.335	.301	.282	.305	.216	.227	.275	.275
.010	.357	.310	.306	.262	.259	.239	.249	.234	.253
.015	.406	.335	.332	.230	.287	.260	.305	.216	.222
.020	.449	.380	.384	.320	.272	.292	.323	.234	.237
.025	.510	.451	.398	.398	.337	.324	.323	.309	.272
.030	.525	.485	.444	.392	.352	.331	.338	.324	.293
.035	.561	.517	.469	.442	.400	.382	.351	.346	.329
.040	.596	.547	.478	.457	.400	.402	.369	.399	.378
.050	.631	.585	.527	.504	.418	.427	.425	.418	.403
.060	.647	.625	.552	.519	.468	.456	.466	.452	.433
.070	.652	.633	.571	.541	.497	.469	.478	.485	.444
.080	.673	.646	.609	.559	.497	.500	.471	.476	.481
.090	.681	.686	.608	.568	.542	.515	.489	.509	.501
.100	.701	.626	.585	.591	.547	.525	.488	.496	.501
.150	.788	.694	.650	.638	.605	.559	.528	.519	.549
.200	.868	.731	.691	.671	.619	.620	.551	.547	.574
.250	.924	.792	.736	.705	.660	.645	.592	.620	.591
.300	.954	.799	.743	.694	.681	.657	.618	.611	.628
.350	.980	.835	.782	.732	.718	.669	.632	.628	.617
.400	.983	.887	.806	.770	.725	.669	.667	.647	.624
.500	.999	.916	.858	.810	.748	.732	.698	.655	.662
.600	.996	.973	.898	.842	.783	.743	.739	.682	.662
.700	.999	.984	.917	.888	.815	.780	.747	.744	.691
.800	1.000	.997	.959	.918	.857	.822	.777	.758	.715
.900	-----	1.000	.959	.946	.866	.844	.822	.783	.743
1.000	-----	-----	.986	.965	.897	.879	.840	.796	.760
1.200	-----	-----	1.000	1.000	.950	.910	.856	.829	.815
1.400	-----	-----	-----	-----	.982	.965	.914	.862	.836
1.600	-----	-----	-----	-----	1.000	1.000	.955	.891	.868
1.800	-----	-----	-----	-----	-----	-----	.980	.931	.902
2.000	-----	-----	-----	-----	-----	-----	1.000	.966	.928
2.200	-----	-----	-----	-----	-----	-----	-----	1.000	.957
2.400	-----	-----	-----	-----	-----	-----	-----	-----	.985
2.600	-----	-----	-----	-----	-----	-----	-----	-----	1.000

^a x distances corresponding to lettered stations are listed in table I.

TABLE II.- EXPERIMENTAL VELOCITY PROFILE DATA - Continued

(k) Run C-5-50; $v_0/u_1 = 5 \times 10^{-3}$; $u_1 = 30$ fps; $v_0 = 0.25$ fps

y, in.	u/u ₁ for station ^a -								
	E	G	H	I	J	K	L	M	N
0.004	0.284	0.299	0.286	0.211	0.222	0.233	0.206	0.172	0.204
.006	.289	.305	.283	.233	.238	.240	.203	.183	.214
.008	.308	.317	.291	.247	.235	.262	.208	.179	.222
.010	.339	.338	.299	.268	.254	.274	.219	.196	.233
.015	.389	.386	.342	.298	.281	.313	.259	.239	.255
.020	.432	.413	.379	.331	.301	.342	.282	.281	.269
.025	.460	.438	.392	.355	.321	.350	.300	.304	.288
.030	.482	.453	.418	.366	.344	.373	.317	.311	.298
.035	.501	.467	.423	.389	.352	.384	.325	.339	.331
.040	.518	.477	.435	.407	.357	.394	.339	.357	.342
.050	.538	.506	.455	.414	.386	.417	.356	.370	.364
.060	.564	.523	.468	.438	.406	.427	.367	.381	.372
.070	.588	.530	.483	.449	.418	.438	.381	.390	.388
.080	.610	.542	.493	.465	.430	.447	.394	.399	.397
.090	.622	.551	.499	.472	.443	.456	.400	.421	.415
.100	.643	.566	.516	.482	.461	.467	.403	.427	.422
.150	.726	.612	.553	.524	.492	.500	.458	.474	.463
.200	.803	.658	.596	.558	.539	.534	.488	.500	.488
.250	.868	.704	.524	.597	.570	.561	.515	.524	.516
.300	.921	.738	.657	.630	.588	.570	.547	.557	.541
.350	.962	.775	.695	.653	.620	.604	.575	.562	.562
.400	.987	.815	.729	.675	.646	.620	.605	.588	.572
.500	1.000	.884	.783	.733	.687	.649	.633	.618	.588
.600	-----	.942	.843	.775	.729	.685	.657	.649	.632
.700	-----	.982	.897	.829	.767	.724	.685	.674	.648
.800	-----	1.000	.939	.868	.808	.754	.713	.696	.673
.900	-----	-----	.974	.910	.846	.788	.745	.716	.690
1.000	-----	-----	.991	.939	.880	.817	.764	.751	.713
1.200	-----	-----	1.000	.987	.943	.870	.815	.778	.753
1.400	-----	-----	-----	1.000	.986	.916	.867	.830	.784
1.600	-----	-----	-----	-----	1.000	.958	.908	.866	.823
1.800	-----	-----	-----	-----	-----	.987	.944	.910	.859
2.000	-----	-----	-----	-----	-----	1.000	.972	.929	.877
2.200	-----	-----	-----	-----	-----	-----	.989	.965	.921
2.400	-----	-----	-----	-----	-----	-----	1.000	.982	.941
2.600	-----	-----	-----	-----	-----	-----	-----	1.000	.961
2.800	-----	-----	-----	-----	-----	-----	-----	-----	.982
3.000	-----	-----	-----	-----	-----	-----	-----	-----	1.000

^a x distances corresponding to lettered stations are listed in table I.

TABLE II.- EXPERIMENTAL VELOCITY PROFILE DATA - Continued

(1) Run C-5-40; $v_0/u_1 = 5 \times 10^{-3}$; $u_1 = 40$ fps; $v_0 = 0.20$ fps

y, in.	u/u ₁ for station ^a -								
	E	G	H	I	J	K	L	M	N
0.004	0.261	0.292	0.245	0.213	0.279	0.211	0.144	0.188	0.000
.006	.282	.320	.224	.215	.280	.207	.175	.201	.078
.008	.316	.344	.264	.242	.290	.213	.178	.202	.203
.010	.341	.361	.268	.250	.299	.234	.180	.214	.212
.020	.436	.425	.343	.308	.329	.311	.257	.269	.288
.030	.493	.462	.394	.374	.373	.360	.279	.331	.316
.040	.524	.490	.425	.419	.395	.380	.300	.348	.338
.050	.546	.513	.450	.429	.409	.404	.333	.363	.362
.060	.569	.528	.468	.443	.435	.412	.340	.378	.381
.070	.586	.539	.481	.460	.443	.428	.347	.412	.389
.080	.607	.545	.495	.474	.458	.437	.368	.416	.405
.090	.630	.559	.511	.492	.465	.443	.390	.430	.416
.100	.643	.577	.510	.499	.485	.462	.399	.440	.416
.200	.802	.666	.588	.578	.554	.525	.453	.514	.484
.300	.912	.732	.651	.635	.605	.560	.530	.552	.540
.400	.982	.820	.716	.691	.660	.610	.569	.587	.564
.500	1.000	.879	.787	.737	.699	.650	.609	.625	.600
.600	-----	.943	.846	.791	.739	.679	.647	.640	.631
.700	-----	.983	.897	.834	.769	.712	.678	.667	.645
.800	-----	1.000	.935	.878	.803	.742	.700	.684	.675
.900	-----	-----	.965	.902	.836	.782	.730	.722	.688
1.000	-----	-----	.987	.936	.872	.805	.759	.741	.705
1.200	-----	-----	1.000	.991	.934	.864	.803	.777	.738
1.400	-----	-----	-----	1.000	.971	.915	.849	.826	.778
1.600	-----	-----	-----	-----	.992	.954	.888	.861	.814
1.800	-----	-----	-----	-----	1.000	.982	.934	.899	.840
2.000	-----	-----	-----	-----	-----	.977	.961	.934	.872
2.200	-----	-----	-----	-----	-----	1.000	.980	.960	.909
2.400	-----	-----	-----	-----	-----	-----	1.000	.982	.935
2.600	-----	-----	-----	-----	-----	-----	-----	.995	.969
2.800	-----	-----	-----	-----	-----	-----	-----	1.000	.977
3.000	-----	-----	-----	-----	-----	-----	-----	-----	.986
3.200	-----	-----	-----	-----	-----	-----	-----	-----	1.000

^a x distances corresponding to lettered stations are listed in table I.

TABLE II.- EXPERIMENTAL VELOCITY PROFILE DATA - Continued

(m) Run C-5-30; $v_0/u_1 = 5 \times 10^{-3}$; $u_1 = 30$ fps; $v_0 = 0.25$ fps

y, in.	u/u ₁ for station ^a -								
	E	G	H	I	J	K	L	M	N
0.004	0.249	0.246	0.276	0.194	0.186	0.219	0.139	0.184	0.194
.006	.245	.270	.242	.207	.190	.236	.157	.184	.233
.008	.245	.270	.253	.229	.194	.225	.202	.208	.234
.010	.245	.302	.305	.243	.218	.246	.208	.207	.198
.015	.316	.351	.314	.301	.236	.272	.216	.255	.234
.020	.389	.414	.345	.328	.242	.294	.260	.248	.249
.025	.433	.435	.379	.333	.286	.337	.263	.293	.286
.030	.463	.441	.392	.381	.311	.360	.309	.311	.298
.035	.491	.479	.405	.370	.324	.392	.292	.323	.321
.040	.498	.488	.434	.396	.329	.379	.318	.351	.321
.050	.538	.495	.451	.423	.371	.392	.333	.361	.337
.060	.578	.519	.465	.453	.376	.423	.361	.394	.363
.070	.593	.536	.486	.460	.387	.431	.365	.390	.365
.080	.617	.552	.493	.464	.435	.435	.380	.394	.373
.090	.619	.558	.507	.485	.444	.445	.391	.407	.413
.100	.635	.574	.521	.476	.442	.487	.399	.408	.397
.150	.718	.632	.553	.518	.495	.480	.422	.448	.426
.200	.779	.662	.599	.549	.522	.546	.467	.500	.473
.250	.846	.684	.627	.589	.551	.554	.511	.515	.491
.300	.898	.734	.664	.622	.583	.584	.539	.527	.504
.350	.940	.786	.712	.655	.612	.603	.562	.537	.521
.400	.970	.810	.732	.683	.650	.610	.587	.572	.548
.500	.993	.863	.792	.728	.687	.640	.604	.607	.586
.600	1.000	.932	.841	.774	.728	.674	.650	.633	.596
.700	-----	.966	.890	.808	.752	.707	.672	.653	.627
.800	-----	.996	.929	.850	.793	.731	.700	.684	.646
.900	-----	1.000	.956	.877	.819	.790	.739	.714	.673
1.000	-----	-----	.985	.921	.856	.805	.749	.723	.685
1.200	-----	-----	1.000	.972	.918	.851	.792	.774	.737
1.400	-----	-----	-----	1.000	.958	.895	.840	.820	.776
1.600	-----	-----	-----	-----	.985	.944	.886	.860	.815
1.800	-----	-----	-----	-----	1.000	.977	.938	.888	.840
2.000	-----	-----	-----	-----	-----	.990	.967	.927	.875
2.200	-----	-----	-----	-----	-----	1.000	.994	.944	.905
2.400	-----	-----	-----	-----	-----	-----	1.000	.978	.939
2.600	-----	-----	-----	-----	-----	-----	-----	.987	.958
2.800	-----	-----	-----	-----	-----	-----	-----	1.000	.977
3.000	-----	-----	-----	-----	-----	-----	-----	-----	1.000

^a x distances corresponding to lettered stations are listed in table I.

TABLE II.- EXPERIMENTAL VELOCITY PROFILE DATA - Continued

(n) Run C-5-20; $v_0/u_1 = 2 \times 10^{-3}$; $u_1 = 20$ fps; $v_0 = 0.05$ fps

y, in.	u/u ₁ for station ^a -								
	E	G	H	I	J	K	L	M	N
0.004	0.300	0.226	0.258	0.170	0.217	0.226	0.152	0.174	0.191
.006	.321	.261	.258	.172	.251	.226	.166	.151	.209
.008	.334	.261	.303	.192	.251	.229	.186	.120	.209
.010	.359	.313	.274	.192	.266	.226	.205	.229	.226
.020	.425	.348	.329	.252	.281	.287	.205	.274	.256
.030	.490	.434	.376	.336	.320	.313	.255	.314	.302
.040	.564	.480	.418	.363	.320	.361	.298	.368	.342
.050	.579	.506	.438	.401	.344	.391	.350	.412	.342
.060	.607	.532	.492	.411	.397	.420	.345	.417	.402
.070	.621	.539	.516	.449	.387	.434	.396	.434	.427
.080	.656	.547	.508	.485	.426	.456	.396	.443	.410
.090	.669	.547	.540	.476	.435	.464	.407	.426	.418
.100	.693	.562	.524	.505	.452	.456	.396	.460	.428
.200	.794	.654	.612	.556	.561	.557	.483	.536	.498
.300	.879	.710	.646	.638	.589	.585	.525	.546	.540
.400	.954	.785	.707	.677	.646	.591	.567	.564	.592
.500	1.000	.832	.753	.723	.687	.623	.628	.590	.623
.600	1.000	.906	.816	.772	.710	.672	.655	.609	.631
.700	-----	.965	.856	.789	.748	.711	.672	.640	.651
.800	-----	1.000	.899	.841	.789	.749	.686	.668	.686
.900	-----	-----	.917	.887	.823	.769	.719	.701	.689
1.000	-----	-----	.975	.914	.865	.795	.740	.743	.725
1.200	-----	-----	1.000	.958	.905	.868	.785	.759	.727
1.400	-----	-----	-----	1.000	.936	.922	.821	.812	.806
1.600	-----	-----	-----	-----	.976	.943	.871	.844	.792
1.800	-----	-----	-----	-----	1.000	.990	.908	.868	.854
2.000	-----	-----	-----	-----	-----	1.000	.963	.894	.884
2.200	-----	-----	-----	-----	-----	-----	.985	.975	.918
2.400	-----	-----	-----	-----	-----	-----	1.000	.961	.944
2.600	-----	-----	-----	-----	-----	-----	-----	1.000	.956
2.800	-----	-----	-----	-----	-----	-----	-----	-----	.982
3.000	-----	-----	-----	-----	-----	-----	-----	-----	1.000

^a x distances corresponding to lettered stations are listed in table I.

TABLE II.- EXPERIMENTAL VELOCITY PROFILE DATA - Continued

(o) Run C-10-26; $v_o/u_1 = 10 \times 10^{-3}$; $u_1 = 26$ fps; $v_o = 0.25$ fps

y, in.	u/u ₁ for station ^a -								
	E	G	H	I	J	K	L	M	N
0.004	0.297	0.290	0.280	0.166	0.294	0.174	0.157	0.151	0.188
.006	.259	.298	.323	.201	.281	.188	.174	.145	.218
.008	.282	.309	.320	.169	.270	.161	.157	.147	.218
.010	.340	.322	.306	.190	.282	.198	.151	.145	.210
.020	.385	.330	.306	.221	.287	.183	.180	.179	.218
.030	.409	.330	.339	.223	.313	.222	.204	.194	.244
.040	.420	.349	.339	.273	.307	.247	.234	.199	.247
.050	.444	.391	.320	.284	.326	.284	.234	.240	.342
.060	.465	.397	.358	.288	.321	.299	.271	.232	.351
.070	.487	.385	.339	.312	.333	.299	.250	.254	.350
.080	.491	.413	.381	.332	.355	.335	.257	.258	.361
.090	.501	.418	.392	.354	.360	.330	.257	.272	.353
.100	.530	.459	.409	.342	.355	.335	.250	.301	.366
.200	.647	.511	.442	.402	.422	.425	.334	.337	.385
.300	.780	.584	.487	.468	.474	.450	.384	.395	.418
.400	.854	.647	.548	.507	.503	.483	.417	.422	.423
.500	.921	.689	.603	.555	.543	.511	.459	.444	.487
.600	.972	.746	.652	.602	.566	.539	.490	.461	.481
.700	1.000	.804	.684	.640	.618	.562	.527	.522	.509
.800	1.000	.855	.745	.672	.634	.574	.552	.532	.527
.900	-----	.900	.792	.703	.661	.611	.585	.562	.551
1.000	-----	.943	.828	.736	.702	.635	.613	.581	.572
1.200	-----	.989	.901	.811	.753	.682	.655	.612	.583
1.400	-----	1.000	.962	.878	.816	.719	.687	.652	.628
1.600	-----	-----	.999	.923	.863	.789	.749	.699	.653
1.800	-----	-----	-----	.971	.915	.833	.795	.723	.698
2.000	-----	-----	-----	1.000	.950	.874	.812	.764	.740
2.200	-----	-----	-----	-----	.980	.924	.856	.827	.755
2.400	-----	-----	-----	-----	1.000	.952	.909	.842	.801
2.600	-----	-----	-----	-----	-----	.972	.925	.875	.816
2.800	-----	-----	-----	-----	-----	1.000	.952	.894	.849
3.000	-----	-----	-----	-----	-----	-----	.973	.930	.870
3.200	-----	-----	-----	-----	-----	-----	.987	.952	.901
3.400	-----	-----	-----	-----	-----	-----	1.000	.988	.928
3.600	-----	-----	-----	-----	-----	-----	-----	1.000	.949
3.800	-----	-----	-----	-----	-----	-----	-----	-----	.986
4.000	-----	-----	-----	-----	-----	-----	-----	-----	.991
4.200	-----	-----	-----	-----	-----	-----	-----	-----	1.000

^a x distances corresponding to lettered stations are listed in table I.

TABLE II.- EXPERIMENTAL VELOCITY PROFILE DATA - Concluded

(p) Run C-10-20; $v_0/u_1 = 10 \times 10^{-3}$; $u_1 = 20$ fps; $v_0 = 0.20$ fps

y, in.	u/u_1 for station ^a -								
	E	G	H	I	J	K	L	M	N
0.004	0.265	0.286	0.298	0.192	0.267	0.222	0.143	0	0.200
.006	.251	.300	.269	.192	.215	.206	.143	.093	.141
.008	.322	.307	.254	.211	.256	.237	.165	.197	.115
.010	.288	.314	.254	.228	.280	.197	.143	.180	.216
.020	.348	.326	.277	.274	.294	.265	.148	.180	.231
.030	.397	.339	.304	.274	.322	.265	.165	.304	.200
.040	.434	.351	.324	.294	.338	.278	.201	.304	.252
.050	.464	.373	.381	.331	.338	.308	.185	.346	.216
.060	.464	.389	.381	.336	.348	.292	.237	.304	.245
.070	.519	.405	.370	.348	.327	.285	.311	.336	.200
.080	.519	.429	.359	.369	.316	.336	.274	.355	.283
.090	.511	.425	.386	.379	.368	.396	.298	.383	.294
.100	.542	.443	.370	.358	.378	.341	.298	.365	.316
.200	.656	.471	.440	.400	.439	.375	.341	.391	.393
.300	.732	.504	.458	.444	.489	.444	.363	.440	.361
.400	.819	.576	.508	.541	.514	.478	.415	.490	.432
.500	.801	.628	.592	.575	.567	.510	.453	.542	.513
.600	.941	.698	.625	.604	.579	.524	.475	.542	.548
.700	.963	.749	.708	.638	.630	.544	.483	.517	.523
.800	.993	.800	.724	.682	.655	.563	.581	.536	.566
.900	1.000	.854	.746	.720	.676	.594	.602	.555	.584
1.000	-----	.896	.783	.736	.687	.635	.602	.567	.635
1.200	-----	.971	.882	.838	.710	.672	.652	.601	.656
1.400	-----	1.000	.955	.873	.779	.722	.705	.660	.688
1.600	-----	-----	1.000	.933	.854	.783	.742	.716	.683
1.800	-----	-----	-----	.965	.910	.818	.785	.739	.726
2.000	-----	-----	-----	1.000	.952	.856	.802	.772	.746
2.200	-----	-----	-----	-----	.982	.904	.844	.825	.779
2.400	-----	-----	-----	-----	1.000	.943	.905	.829	.808
2.600	-----	-----	-----	-----	-----	.972	.926	.874	.845
2.800	-----	-----	-----	-----	-----	1.000	.962	.903	.868
3.000	-----	-----	-----	-----	-----	-----	.981	.943	.913
3.200	-----	-----	-----	-----	-----	-----	1.000	.968	.927
3.400	-----	-----	-----	-----	-----	-----	-----	1.000	.966
3.600	-----	-----	-----	-----	-----	-----	-----	-----	.987
3.800	-----	-----	-----	-----	-----	-----	-----	-----	1.000

^a x distances corresponding to lettered stations are listed in table I.

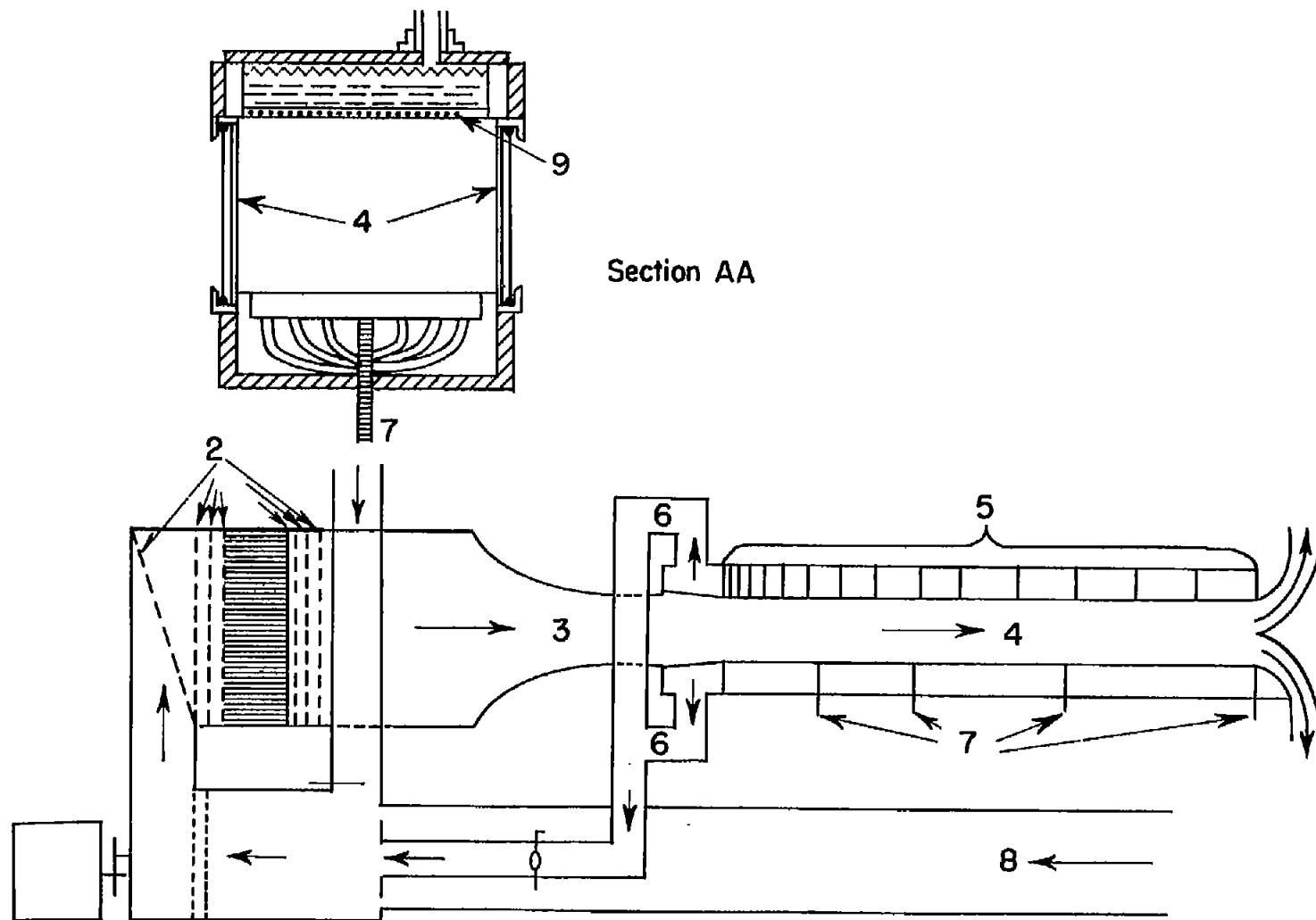

Figure 1.- Apparatus used in experimental work.

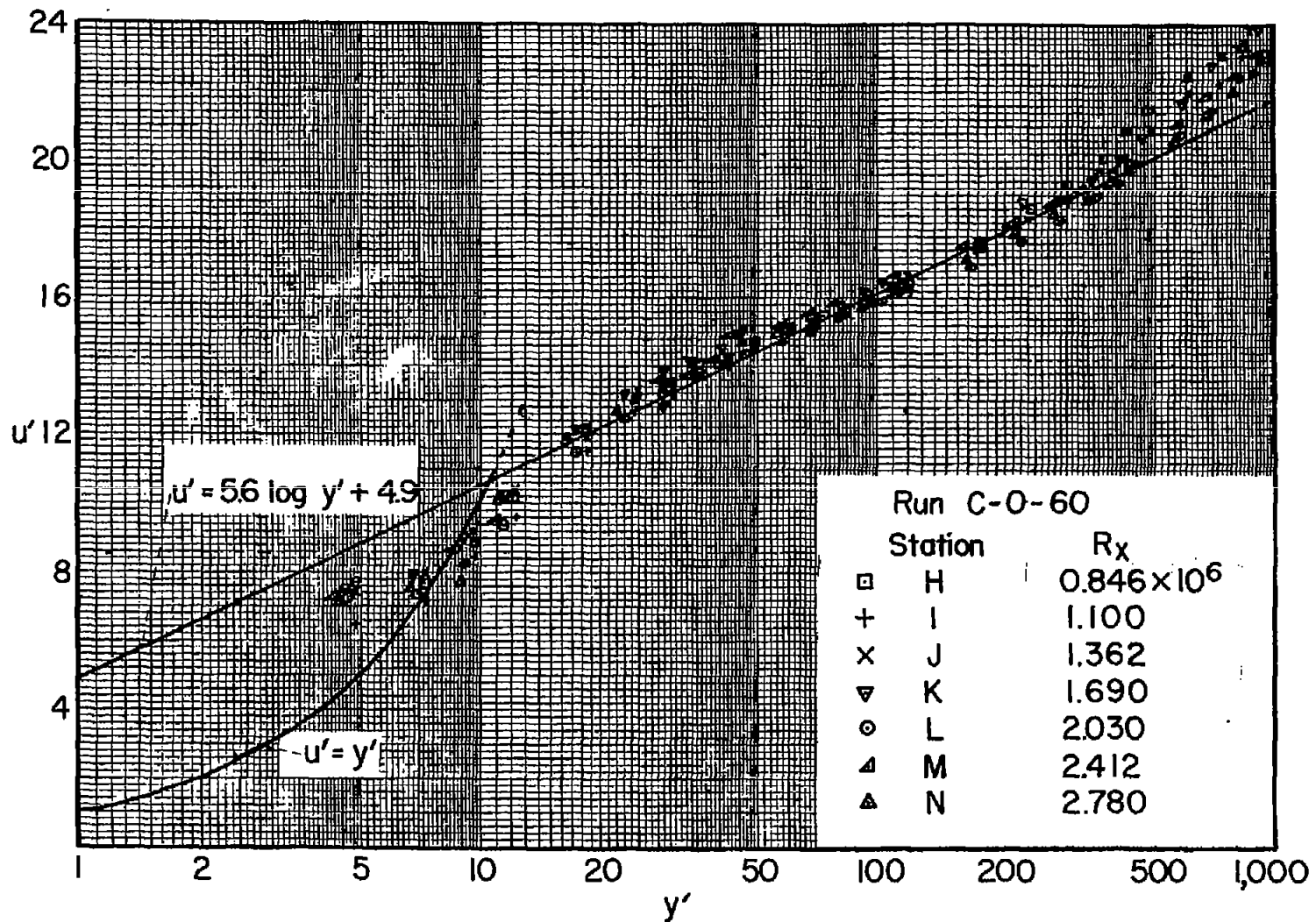

Figure 2.- Universal velocity distribution for turbulent velocity profiles near smooth walls compared with present data.

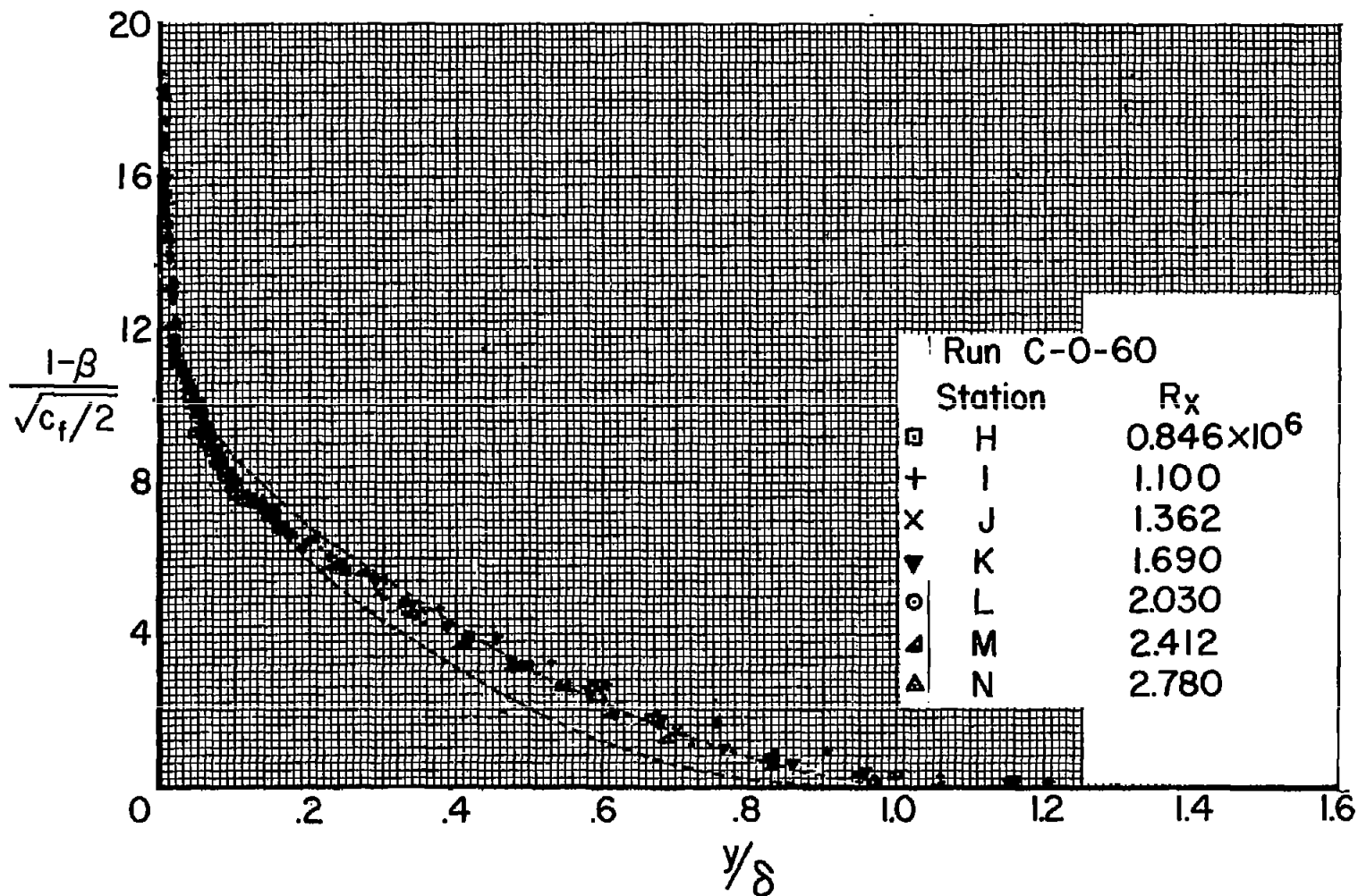

Figure 3.- Universal plot of turbulent-boundary-layer profiles compared with experimental no-blowing velocity data. Area enclosed by dashed lines encompasses data given in references 2 and 5 to 9 for constant-pressure turbulent-boundary-layer profiles for both smooth and rough walls.

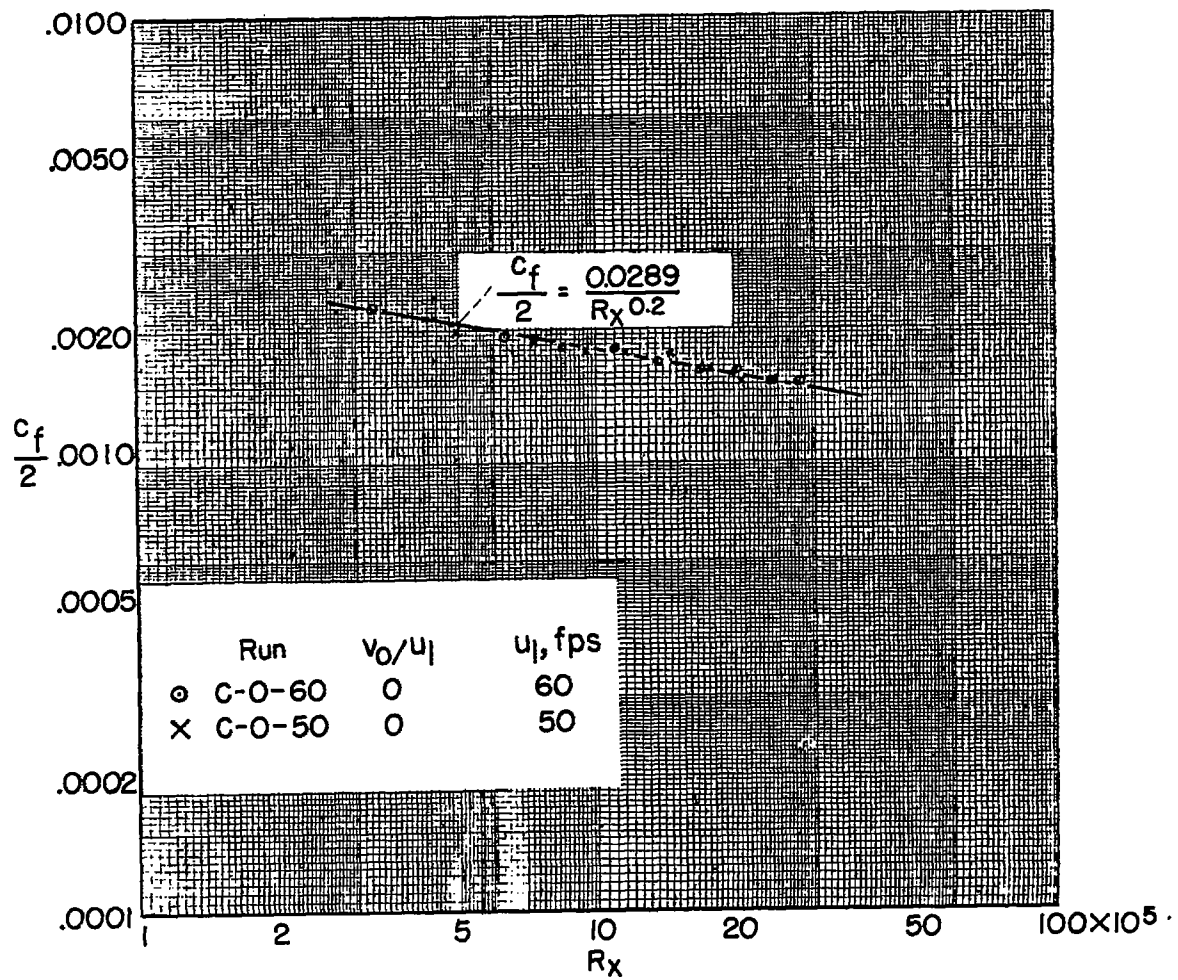
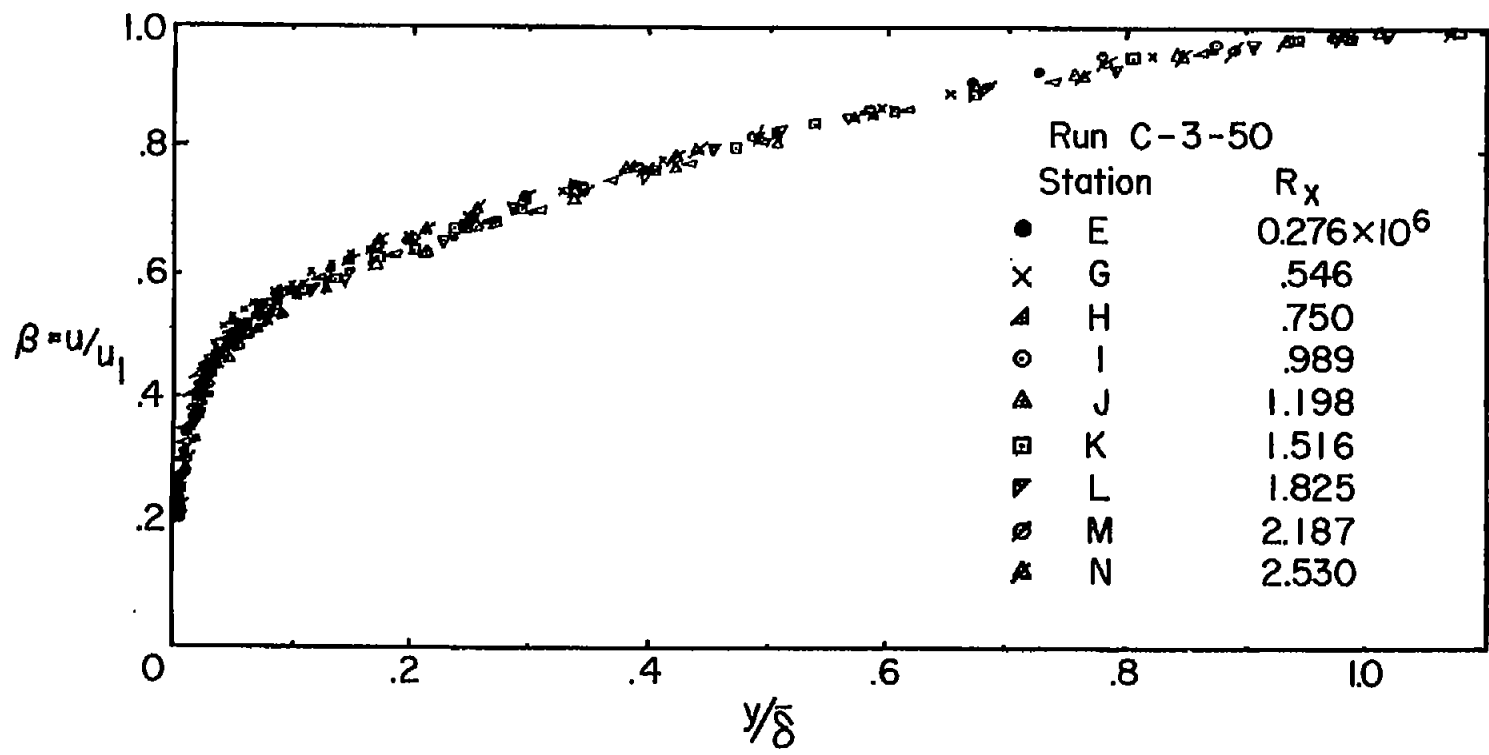
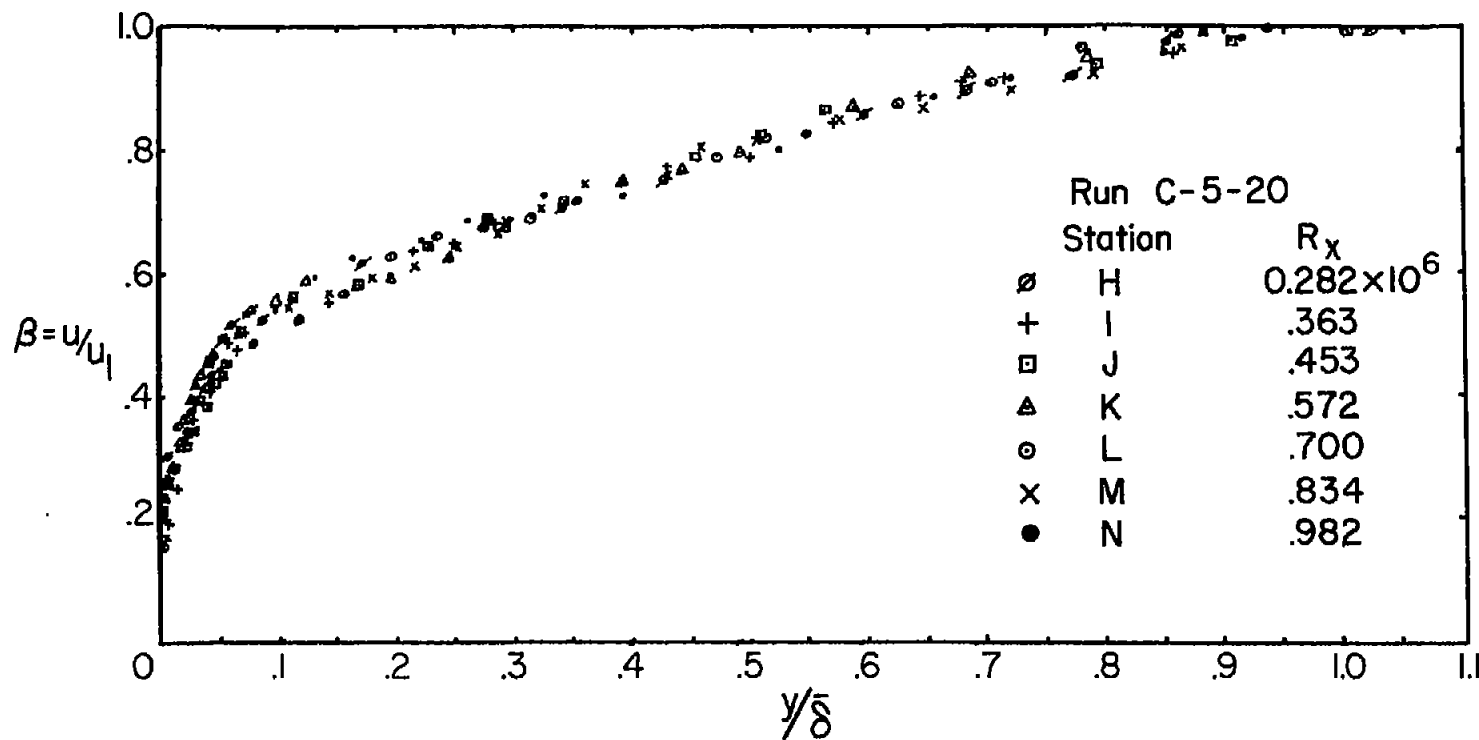

Figure 4.- Comparison of experimental no-blowing local friction coefficients with correlated results of other workers.



(a) Run C-3-50; $\frac{v_0}{u_1} \approx 0.003$; $u_1 \approx 50$ fps.

Figure 5.- Dimensionless velocity profiles.



(b) Run C-5-20; $\frac{v_0}{u_1} \approx 0.005$; $u_1 \approx 20$ fps.

Figure 5.- Concluded.

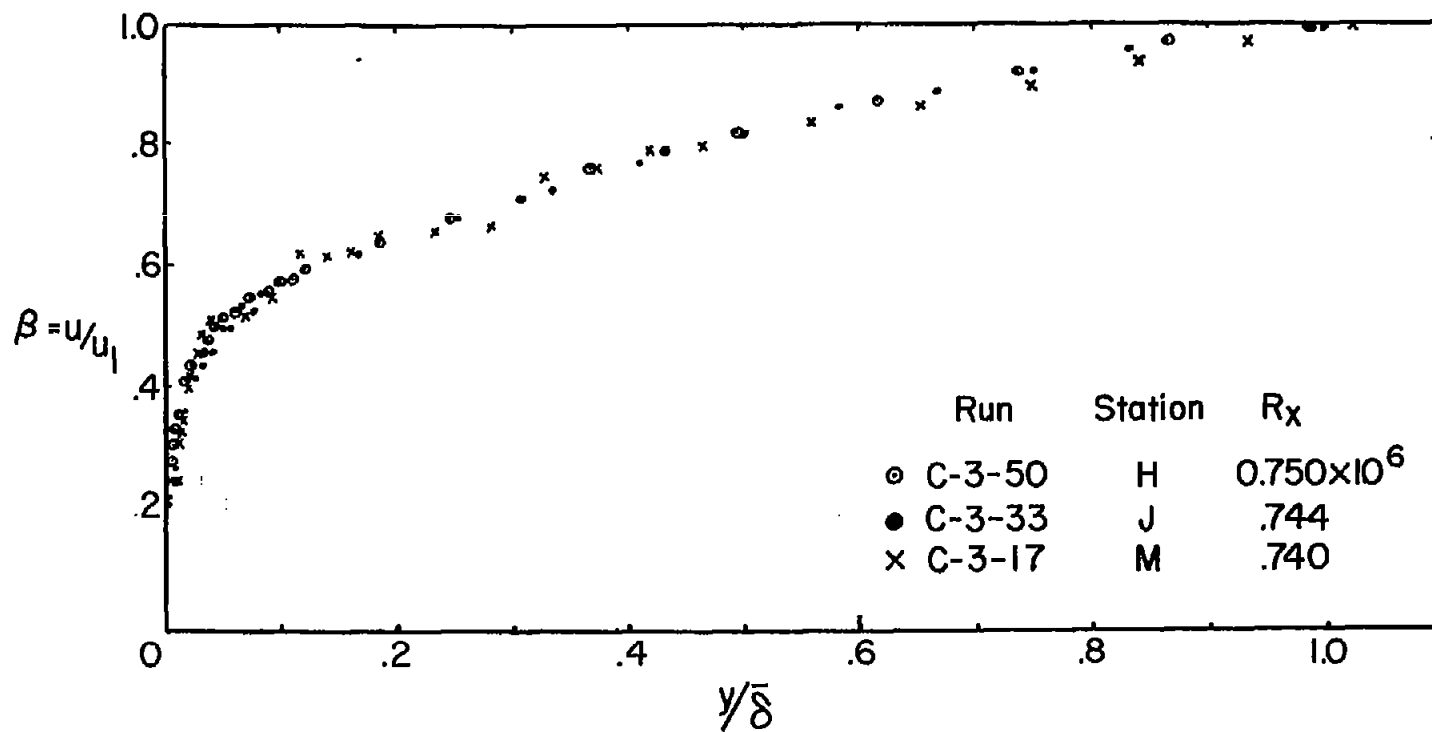

Figure 6.- Comparison of dimensionless velocity profiles at $v_0/u_1 \approx 0.003$.

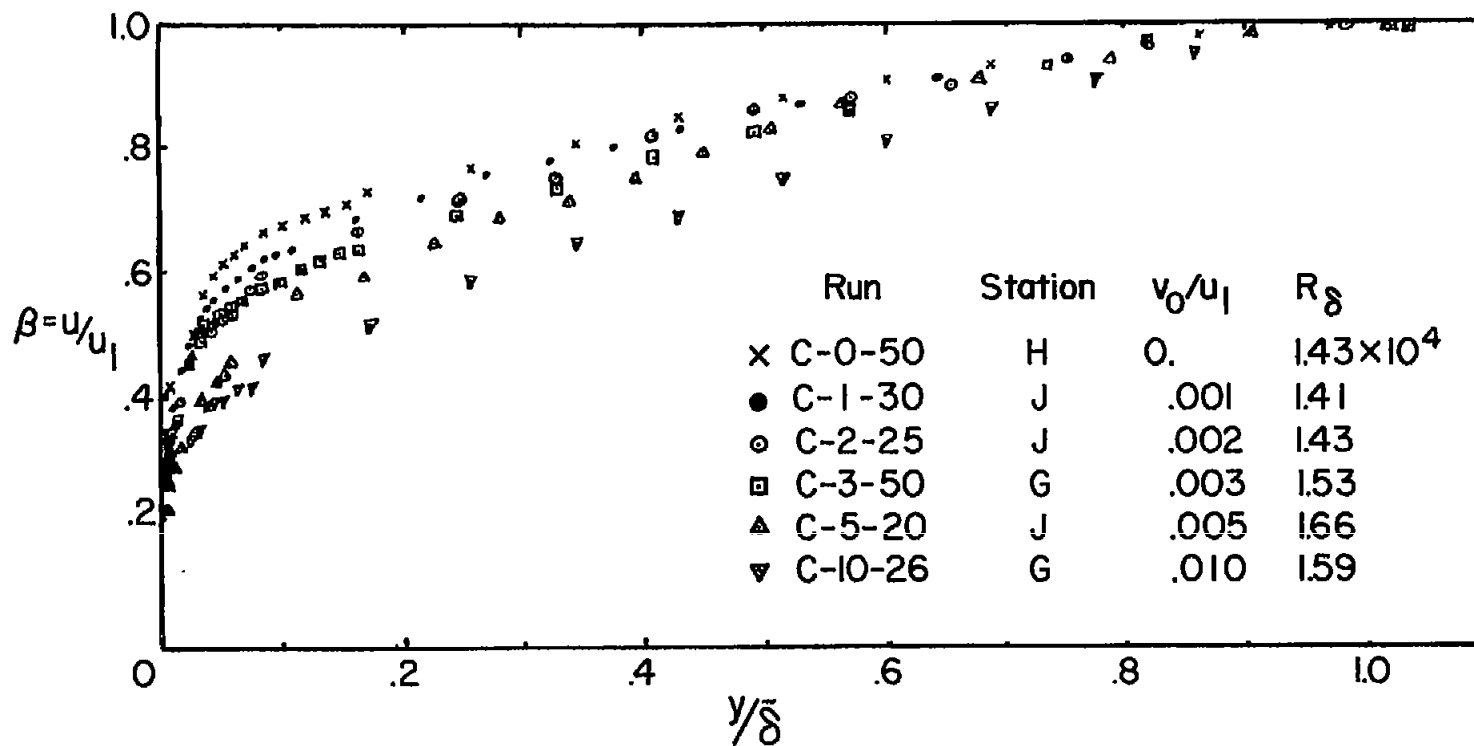
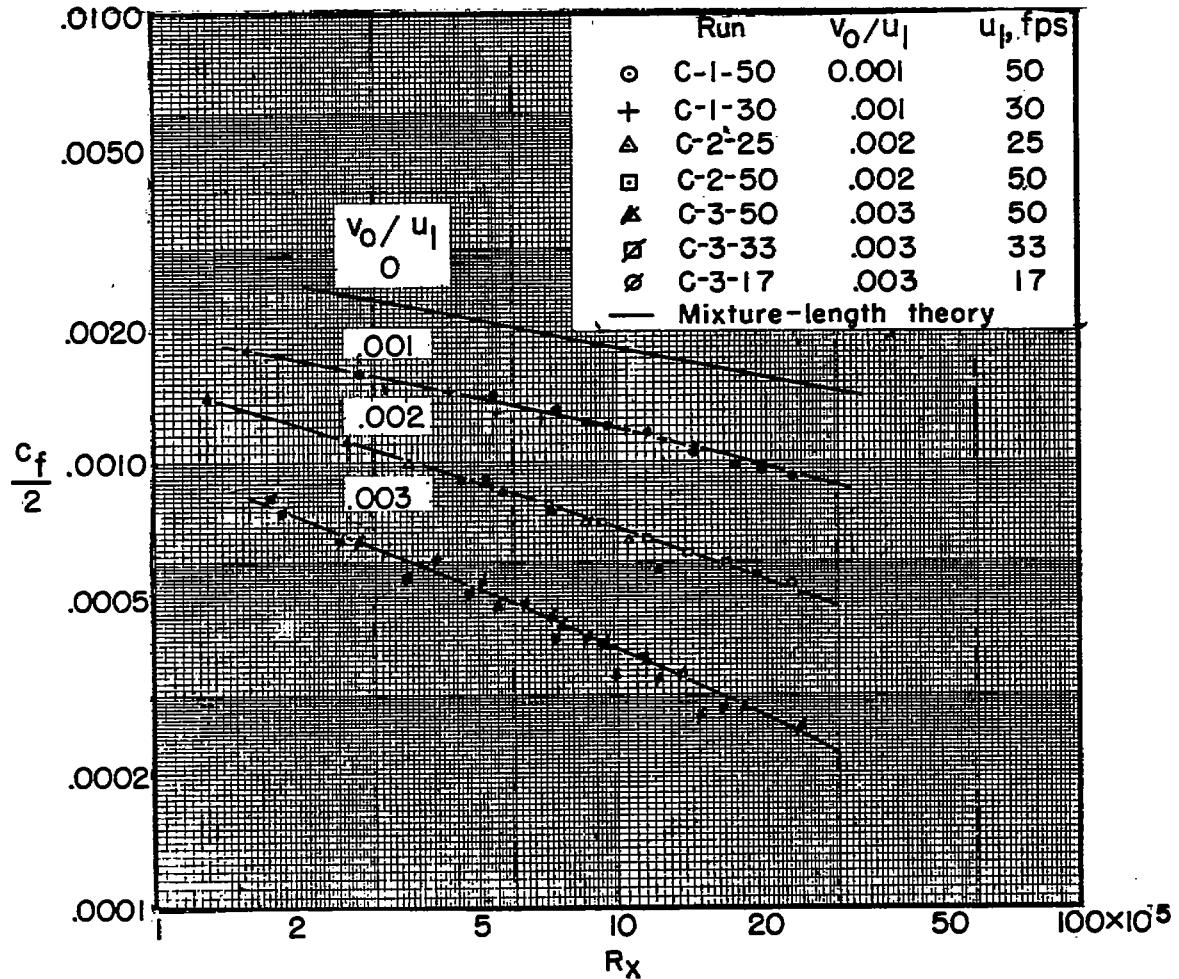
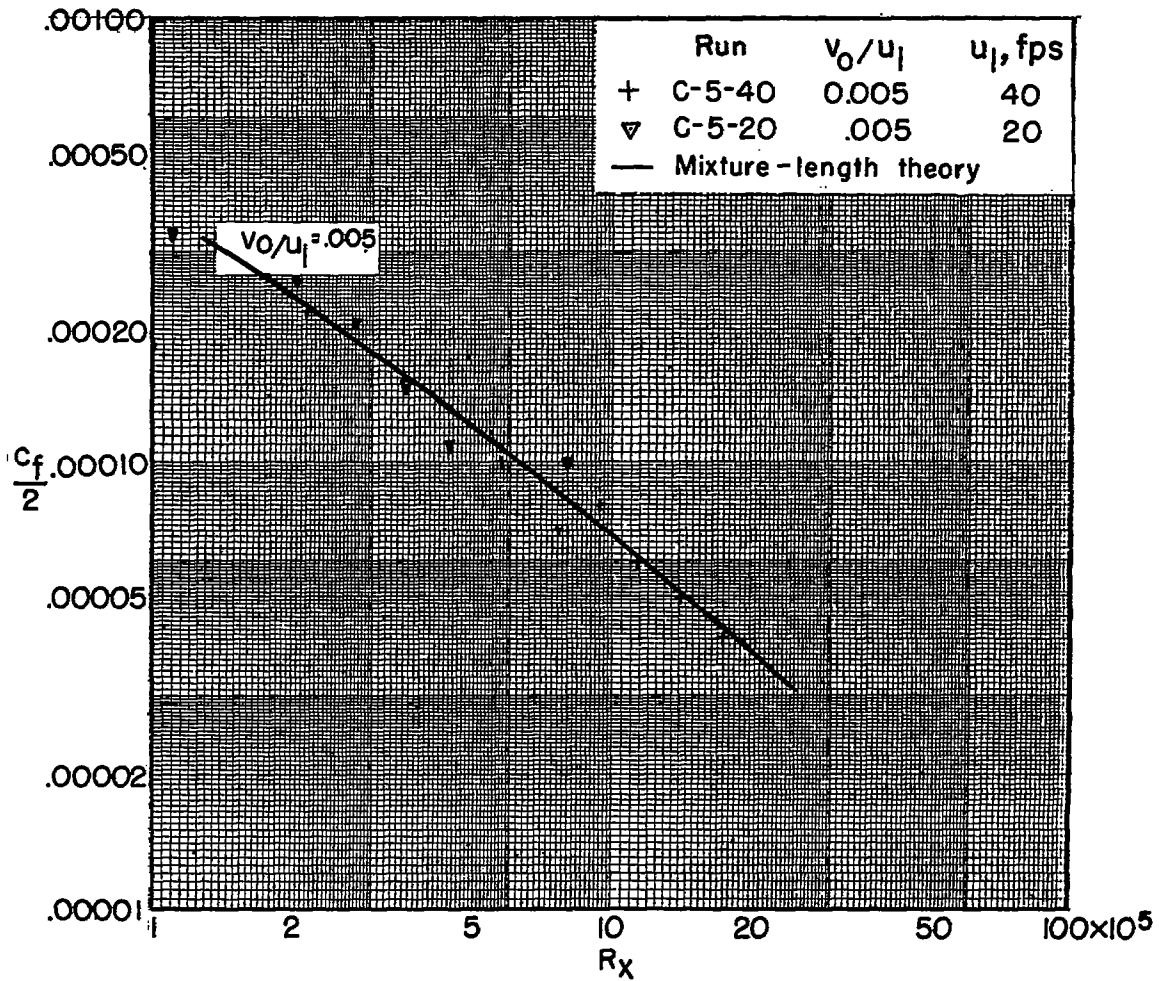

Figure 7.- Comparison of dimensionless velocity profiles at different values of v_0/u_1 .



(a) $v_0/u_1 = 0, 0.001, 0.002, \text{ and } 0.003$.

Figure 8.- Variation of experimental local friction coefficients with v_0/u_1 and length Reynolds number and comparison with mixture-length theory.



(b) $v_0/u_1 = 0.005$.

Figure 8.- Concluded.

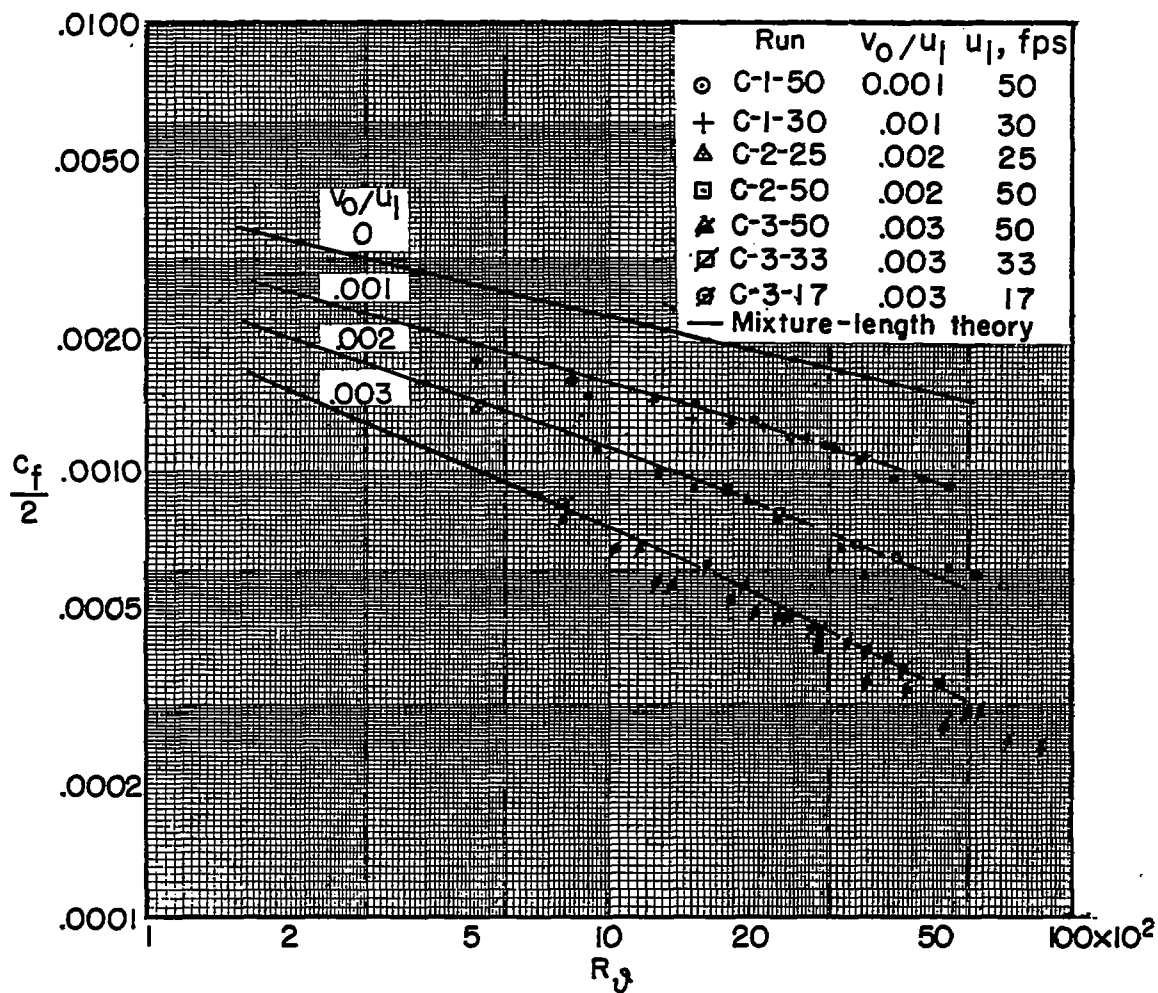

(a) $v_0/u_1 = 0, 0.001, 0.002, \text{ and } 0.003.$

Figure 9.- Variation of experimental local friction coefficients with v_0/u_1 and momentum-thickness Reynolds number and comparison with mixture-length theory.

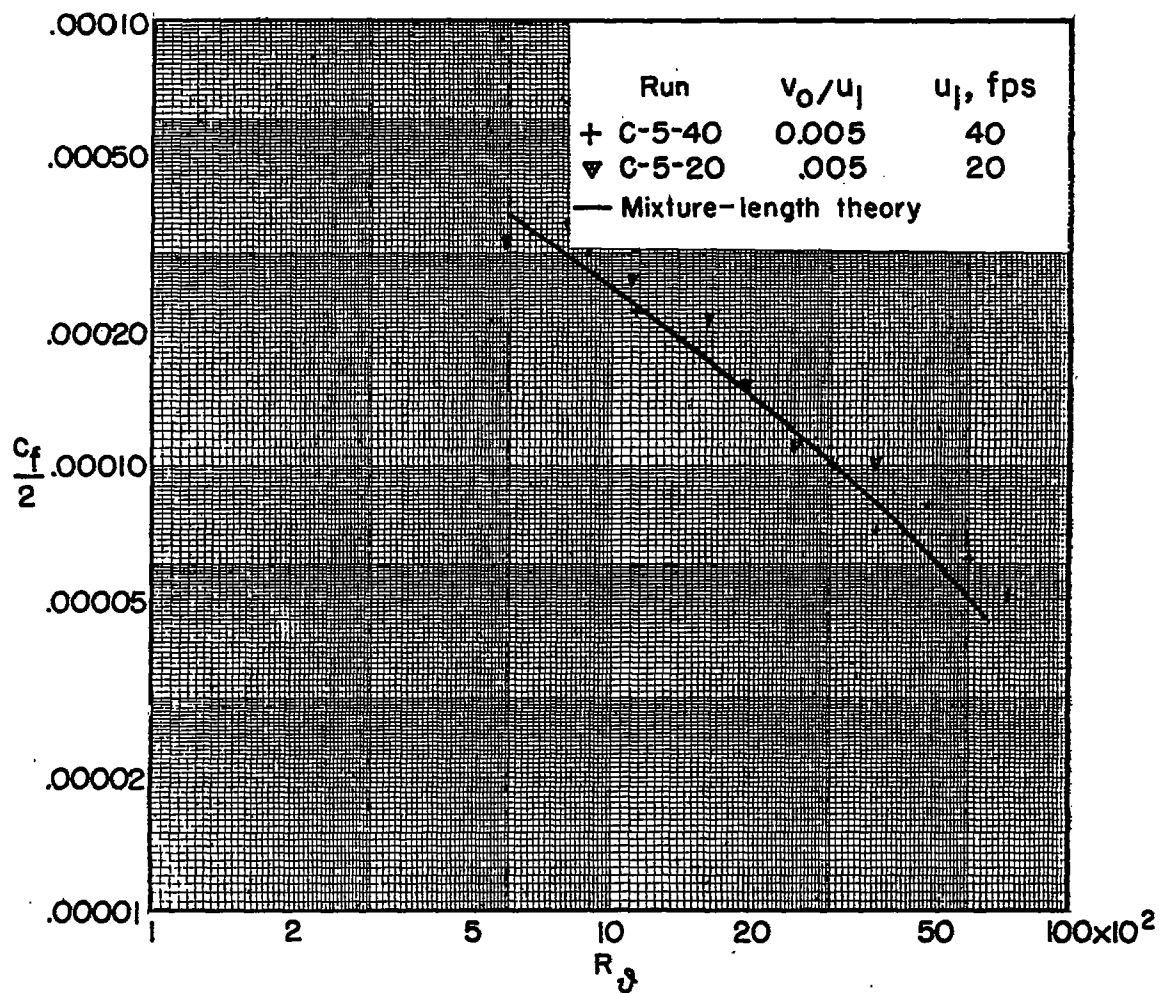

(b) $v_0/u_1 = 0.005$.

Figure 9.- Concluded.

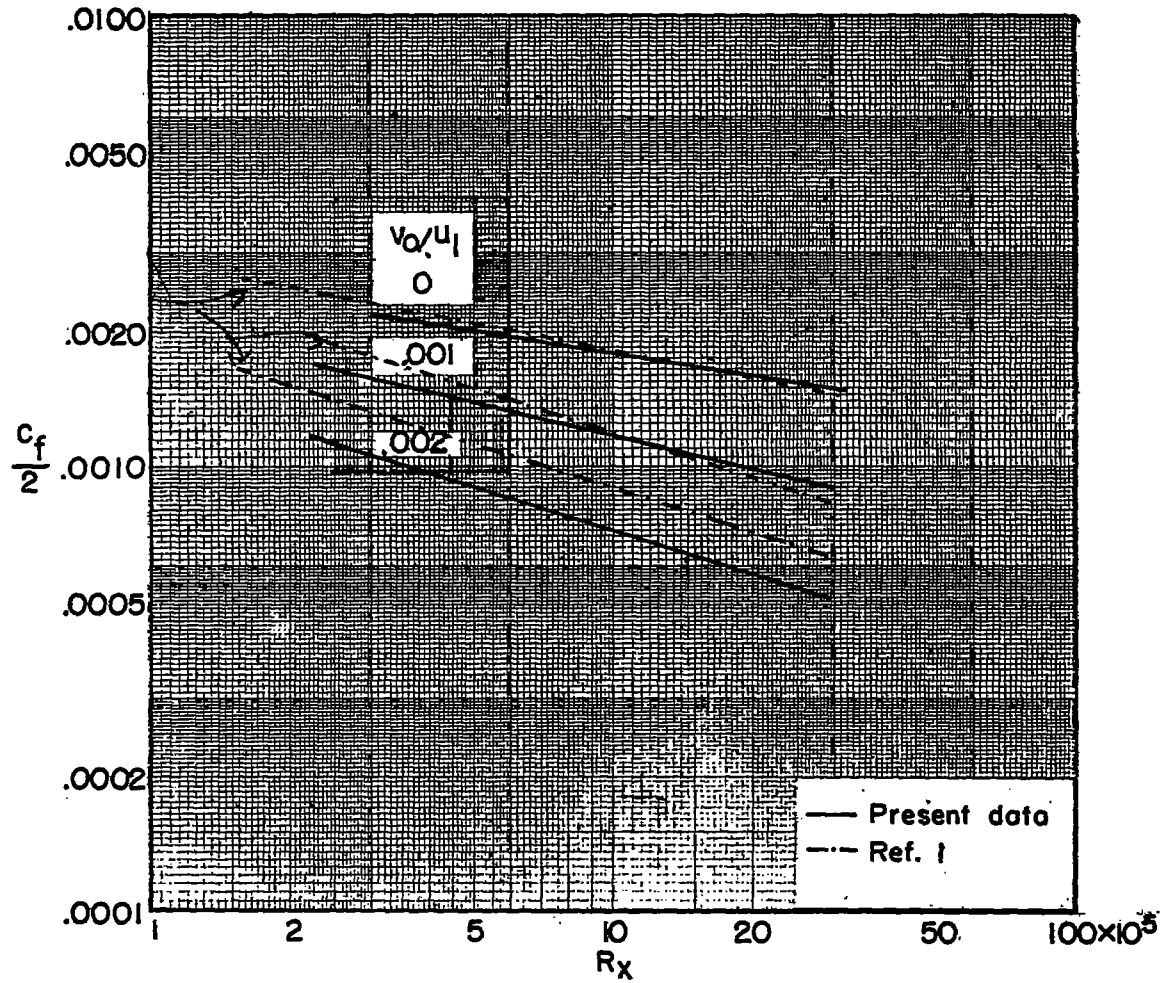
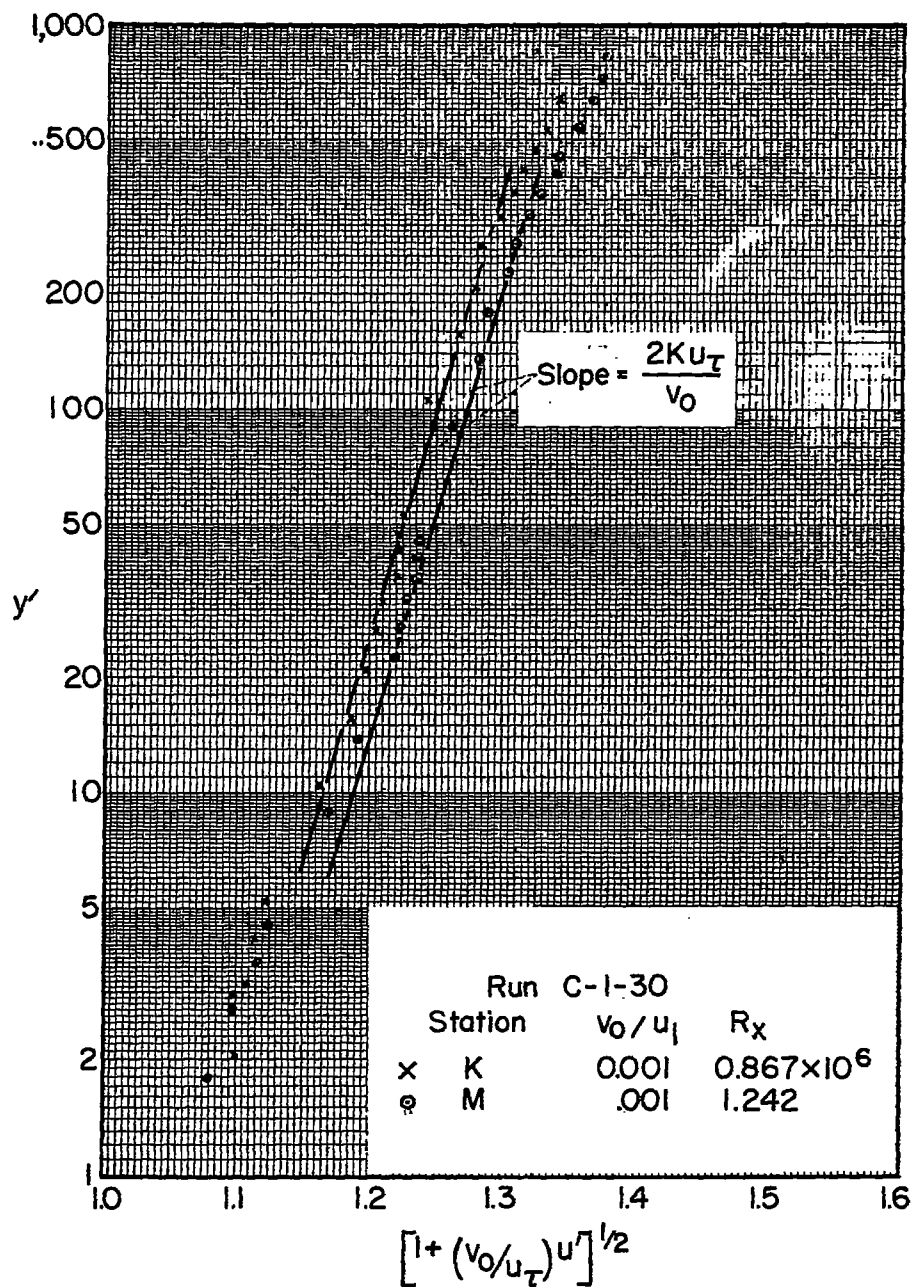

Figure 10.- Comparison of present experimental local friction-coefficient data and earlier results of reference 1.



(a) Run C-1-30.

Figure 11.- Velocity profiles compared with mixture-length theory.

Slope, $\frac{2Ku_{\tau}}{v_0}$; $K = 0.400$.

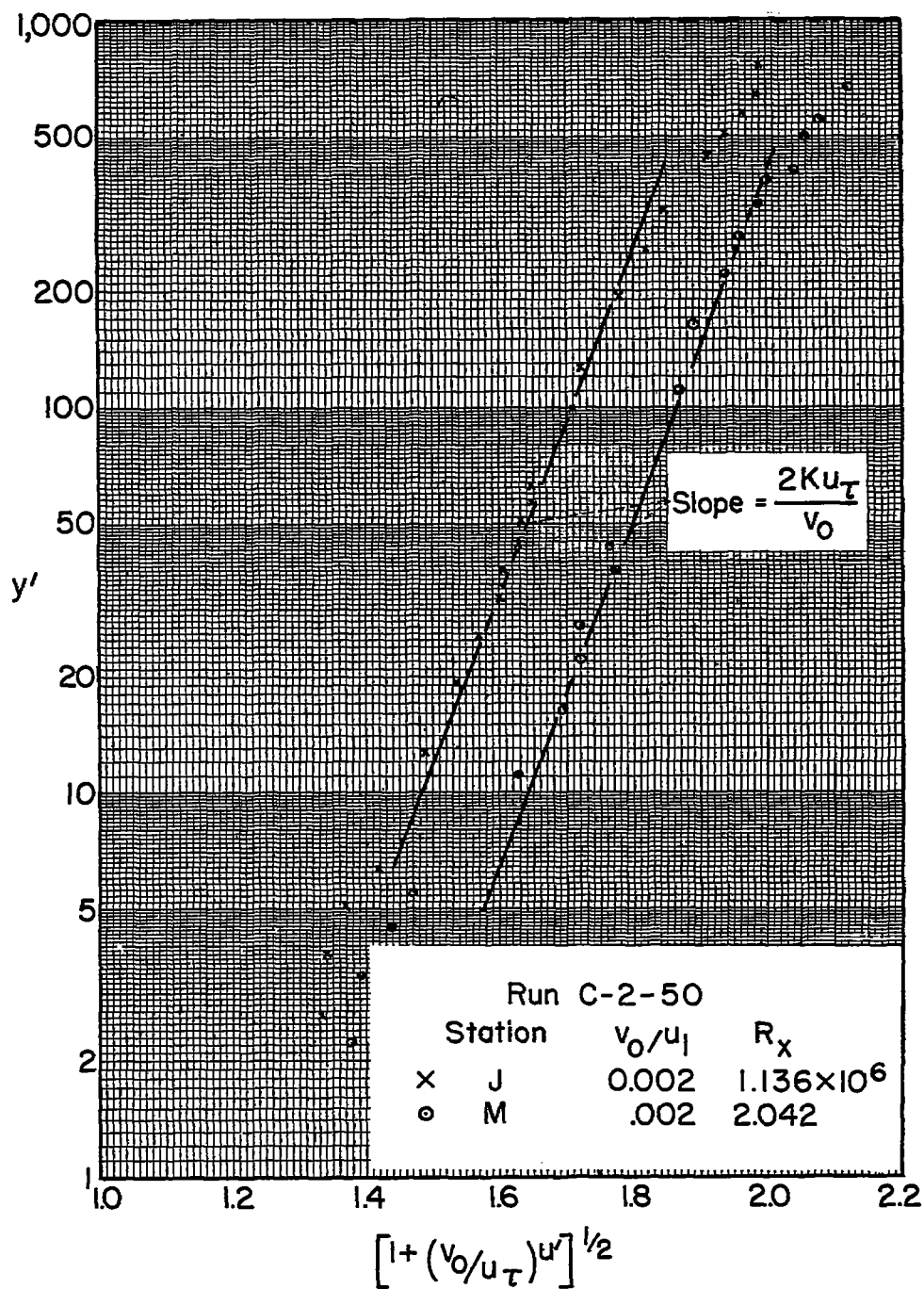

(b) Run C-2-50.

Figure 11.- Continued.

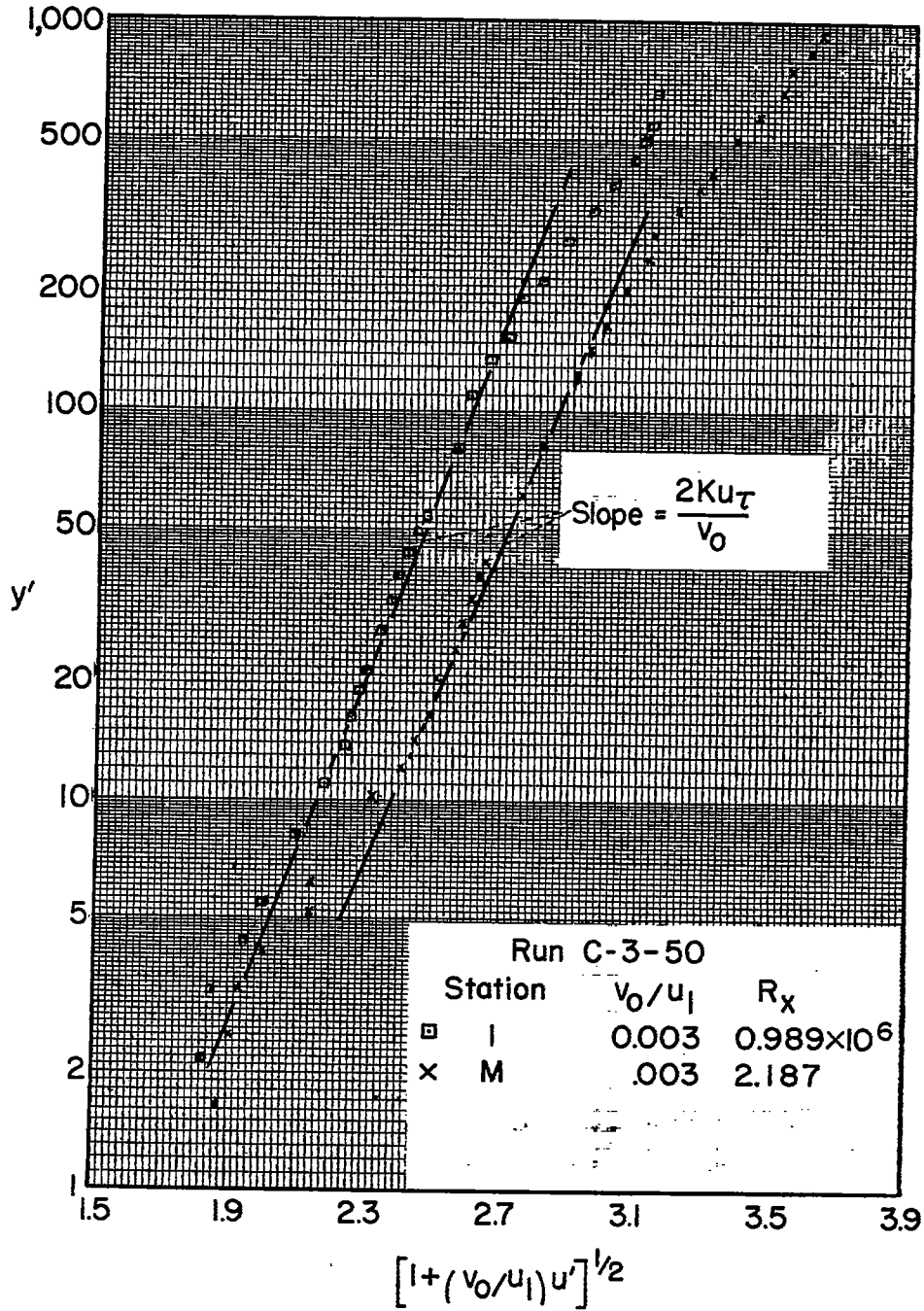

(c) Run C-3-50.

Figure 11.- Continued.

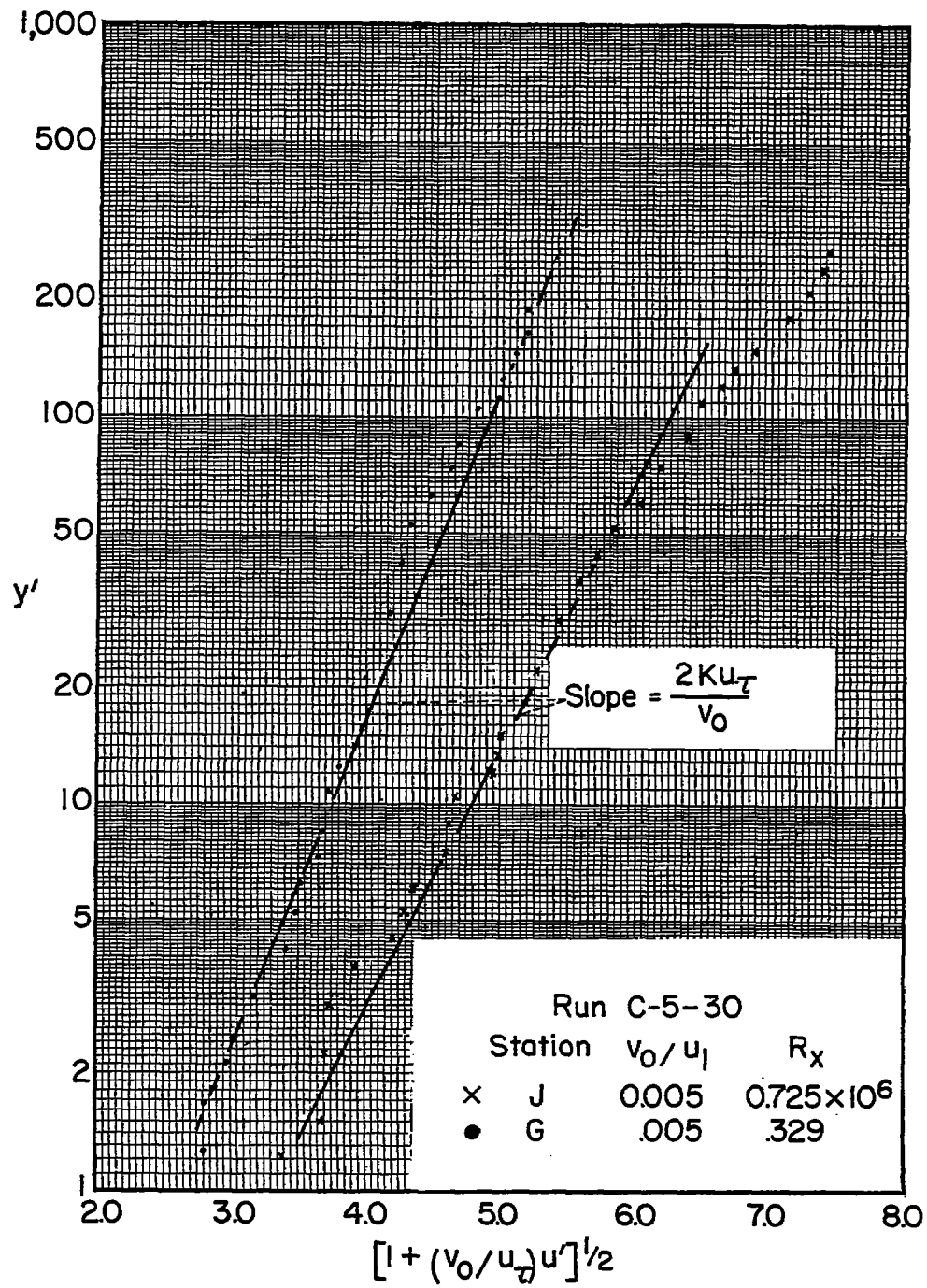

(d) Run C-5-30.

Figure 11.- Concluded.

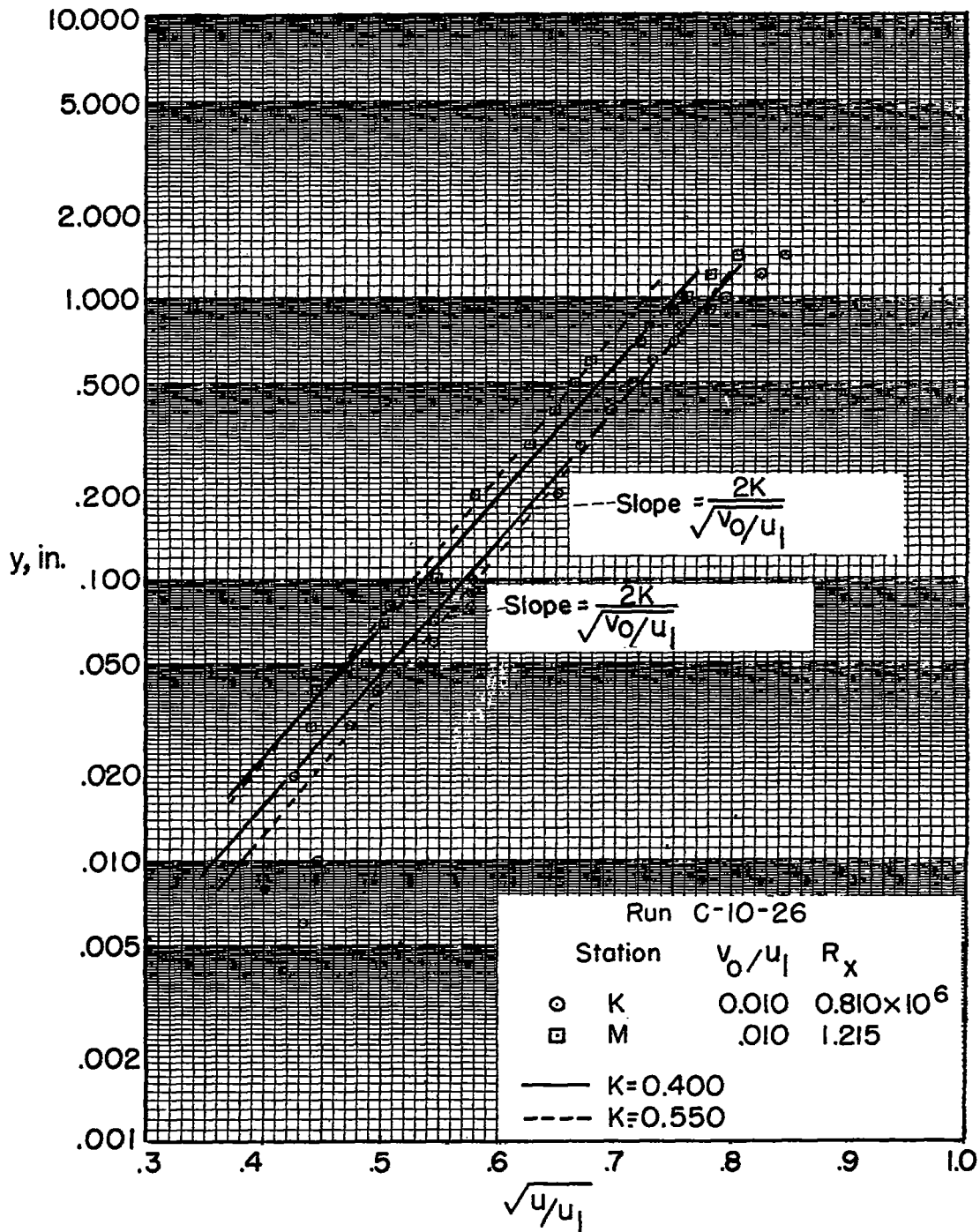

Figure 12.- Velocity profiles of run C-10-26 compared with mixture-length theory.

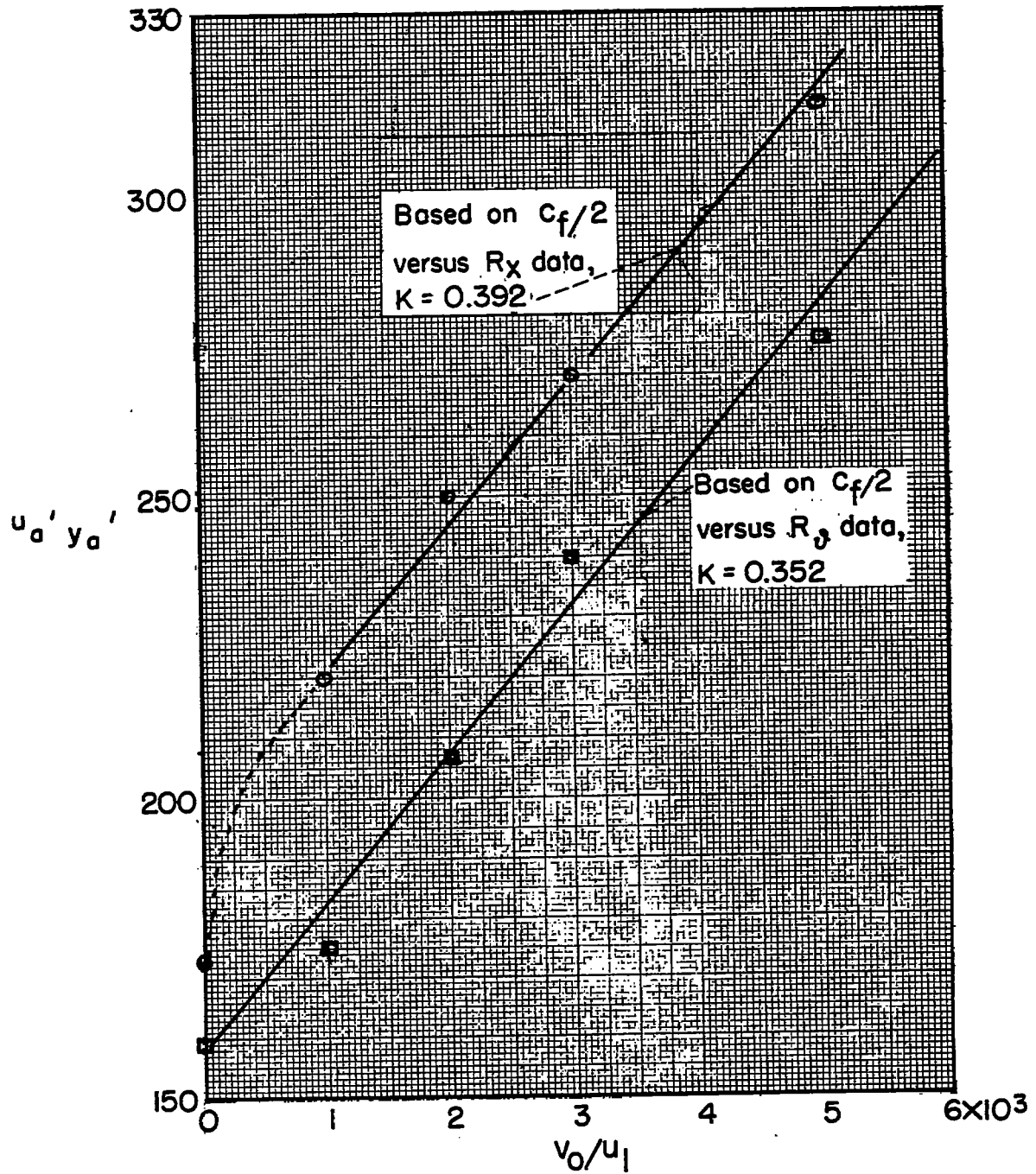

Figure 13.- Value of Reynolds number at outer edge of laminar sublayer $u'_a y'_a$ as a function of v_0/u_1 .

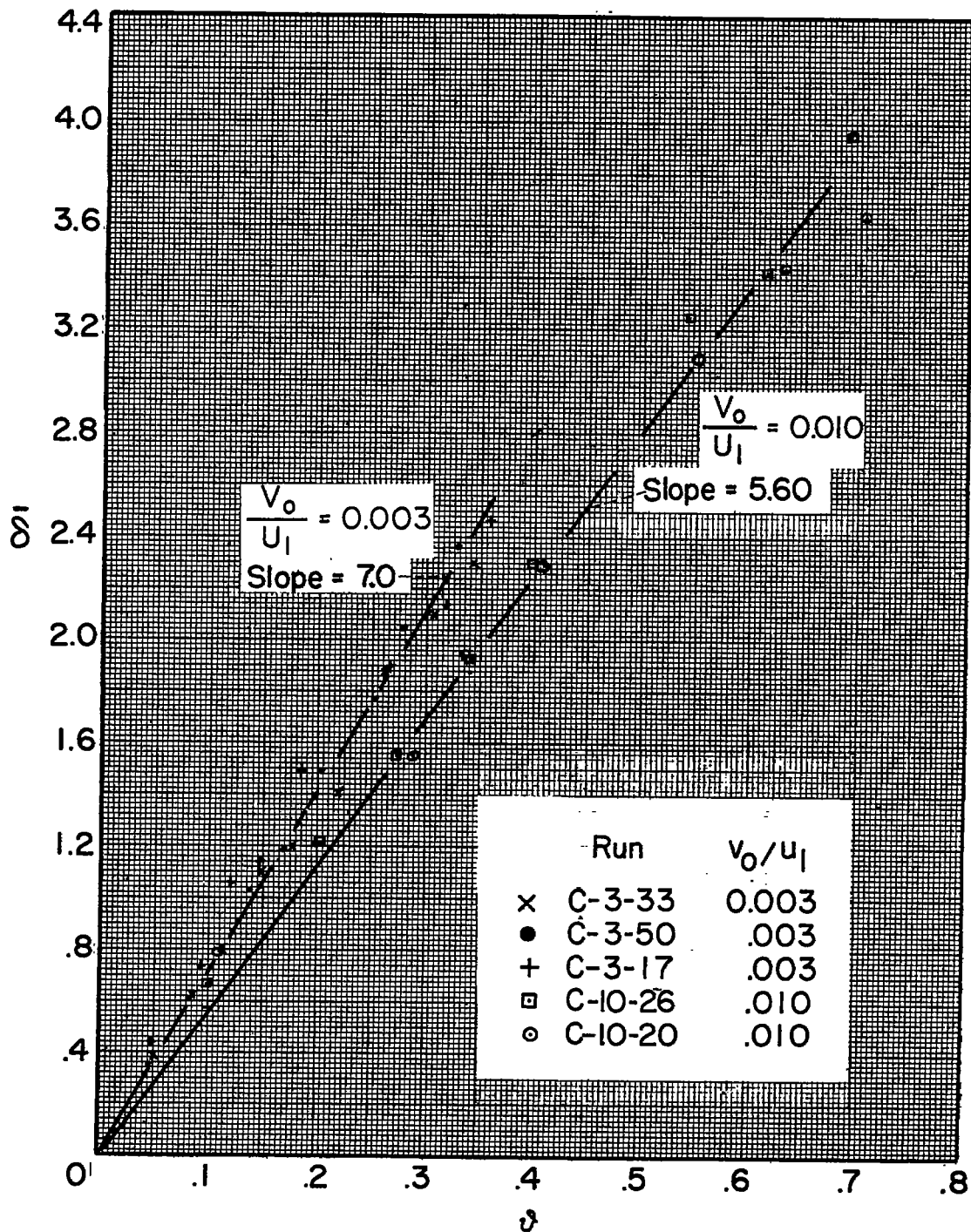

Figure 14.- Boundary-layer thickness δ as a function of momentum thickness δ^* .