

Discussion Paper #661R

MONOPOLY PROVISION OF QUALITY AND WARRANTIES:
AN EXPLORATION IN THE THEORY OF MULTIDIMENSIONAL SCREENING*

by

Steven Matthews and John Moore

August 1985

Revised May 1986

* This is an extensively revised and strengthened version of the first half of "Monopoly Provision of Product Quality and Warranties."

MONOPOLY PROVISION OF QUALITY AND WARRANTIES:
AN EXPLORATION IN THE THEORY OF MULTIDIMENSIONAL SCREENING¹

by

Steven Matthews
Department of Economics
Northwestern University
Evanston, IL 60201

and

John Moore
London School of Economics
Houghton Street
London WC2A 2AE

Headnote:

We address the monopoly problem of designing and pricing a product line of goods distinguished by different quality and warranty levels. Consumers vary in their evaluations of these attributes, so that the problem is one of screening. It is sufficiently complex that the local approach commonly used does not work. Instead, we use new techniques for dealing with incentive constraints between nonadjacent consumer types. These techniques allow us to characterize optimal allocations that may not be monotonic. In particular, although the more eager types of buyer do pay higher prices and yield the monopoly higher profit, they may receive lower quality or lower warranty coverage. We find preference restrictions that restore monotonicity: concave risk tolerance implies that warranty coverage increases in type, and constant absolute risk aversion implies that quality increases in type.

Keywords:

mechanism design, monopoly screening, price discrimination and bundling, quality and warranties.

1. INTRODUCTION

Much attention has been given recently to the problem of how an imperfectly competitive firm deals with a diverse consumer population. Such a firm offers its customers a set of contracts from which they can choose, where a contract specifies a total payment, the quantities of various goods and services, their physical attributes, and remedies for nonperformance. Ideally, the firm would like to design for each customer a contract which extracts maximum surplus from his type. But typically the customer would not choose this contract, preferring instead a contract meant for another type of customer. This is the self-selection problem central to the literature on, for example, the design of nonuniform pricing schedules,² tax schedules,³ bundling schemes,⁴ product lines,⁵ auctions,⁶ implicit contracts,⁷ and regulatory policies.⁸

We consider in this paper a monopoly design problem in which each contract specifies a different quality product and the terms on which it will be sold. The intuition behind its solution starts with the observation that profit is potentially greatest on contracts designed for "high" type consumers, those with a high evaluation of quality. Because high type consumers cannot be prevented from choosing contracts meant for low types, this profit can only be realized by distorting the contracts meant for low types in a direction that makes them relatively unattractive to high types. All but the highest type of consumer should therefore receive products of inefficiently low quality.

Although this intuition was expressed by Dupuit (as noted by Ekelund (1970)) nearly a century ago, it was made rigorous only recently by Mussa and Rosen (1978). Their analysis depended on several restrictive assumptions:

each contract specified only a price and a quality level, each consumer's utility function was linear in the contract, and consumer types were represented by a one dimensional parameter. We relax the first two assumptions. Only the quality variable enters utility linearly: we interpret it concretely as the probability of the product working. Consumers are risk averse. The resulting demand for insurance is supplied by warranties that pay back compensation for product failure. Our task is to characterize the profit-maximizing set of contracts which specify the three variables, quality, warranty, and price.

Our first set of results confirms and sharpens the intuition of Dupuit and Mussa and Rosen. We show that contracts meant for low types are distorted precisely in order to make them less attractive to high type consumers. The way in which these contracts are distorted is to have them specify inefficiently low quality levels and warranty coverages. Very low type consumers receive warranties that pay back less than the price of the product.

Our second set of results differs from that of Mussa and Rosen, as well as from that of all the screening literature we have seen. In Mussa and Rosen, both components of an optimal contract, price and quality, must increase with the type of consumer for whom it is intended. In contrast, although we show that contracts intended for higher types do yield higher profit and specify higher prices, they need not have higher qualities and warranties. We present a counterexample to the proposition that higher types must receive greater quality. Additional assumptions about consumer risk aversion are required to show that qualities and warranties will be monotonic in type: constant absolute risk aversion leads to monotonic quality levels, and concave risk tolerance leads to monotonic warranty coverages.

We are able to solve a screening problem in which the optimal contracts

need not be monotonic in type only by using a new methodology. The usual technique relies on showing that "local incentive compatibility implies global incentive compatibility." Showing this requires strong assumptions which, almost incidentally, always imply that the optimal contracts will be monotonic. Earlier results to the effect that higher types receive, for example, a higher quality in product line models or a greater quantity in nonuniform pricing models, are due, we believe, to assumptions made more for technical than for economic reasons.

To substantiate this claim, in Section 2 we describe the standard local approach to screening problems. Although some of the results in Section 2 may be familiar, we present them in a general context and in a geometrical way that highlights the differences in our approach. In Section 3 we discuss our model of qualities and warranties. The key technical results are derived in Section 4, and the economic implications are derived and discussed in Section 5. Section 6 contains final remarks on monotonicity and the local approach.

2. TECHNICAL BACKGROUND: THE LOCAL APPROACH

A representative screening problem is of the following form:

$$(M) \quad \text{Maximize}_{\mathbf{x}_1, \dots, \mathbf{x}_n} \sum_{i=1}^n \pi(\mathbf{x}_i) f_i$$

subject to

$$(IC) \quad U(\mathbf{x}_i, \theta_i) \geq U(\mathbf{x}_j, \theta_i) \text{ for all } j \neq i, \text{ and}$$

$$(VP) \quad U(\mathbf{x}_i, \theta_i) \geq \bar{U} \text{ for all } i.$$

Here, \mathbf{x}_i is the k -dimensional contract intended for type θ_i consumers, f_i is the fraction of the consumers who are of type θ_i , and $\pi(\mathbf{x}_i)$ is the benefit (e.g. profit or social welfare) obtained when a consumer chooses \mathbf{x}_i .⁹ A consumer of type θ_i choosing contract \mathbf{x}_j receives utility $U(\mathbf{x}_j, \theta_i)$, where U is continuously differentiable in \mathbf{x} .

The first $k-1$ components of a contract $\mathbf{x} = (\mathbf{a}, b)$ indicate the levels of attributes -- such as quantity or quality. In general, U need not be monotone in any attribute. But we do assume $U_k < 0$, with the interpretation that the k^{th} contract component, b , is an outlay made by the consumer.

The essence of a screening problem is the set of incentive constraints IC. They are required because each consumer must be allowed to choose his most preferred contract out of all those being offered; the firm cannot offer different types of consumer different contracts either because it cannot observe the type of any consumer, or because it is legally prevented from discriminating on the basis of type. The voluntary participation constraint VP is required in addition because each consumer has the option of obtaining utility \bar{u} by refusing to choose any of the contracts.

Not knowing which incentive constraints bind makes it difficult to use the Kuhn-Tucker conditions for (M) to characterize its solutions. Instead, the basic approach used since Mirrlees (1971,1976), and extended and refined most recently by Mirrlees (1985) and Maskin and Riley (1984b), has been to solve a simpler problem obtained by ignoring all but the adjacent incentive constraints:

$$(AIC) \quad U(\mathbf{x}_i, \theta_i) > U(\mathbf{x}_j, \theta_i) \text{ for all } i \text{ and } j = i-1, i+1.$$

The relaxed problem obtained by replacing IC with AIC is generally more

tractable. For example, θ is often assumed to be a continuously distributed scalar. Then AIC corresponds to the first and second order conditions for a consumer optimum, both of which are local constraints on derivatives that can be handled by control-theoretic techniques.

For this local approach to be valid, solutions to the relaxed problem must be shown to satisfy the global incentive constraints that were neglected. Showing this always requires a variety of assumptions; in particular, meaning must be given to the ordering used to identify "adjacent" types. This is done by assuming that $[\theta_1, \theta_n]$ is a one-dimensional interval of real numbers, and then making assumptions about the derivatives U_θ and $U_{\mathbf{x}\theta}$.

At this point it is useful to introduce a figure we shall use extensively. For any contract \mathbf{x} , refer to the graph of $U(\mathbf{x}, \cdot)$ as a utility curve. A set $\{\mathbf{x}_1, \dots, \mathbf{x}_n\}$ of contracts satisfies all the incentive constraints provided that for each i , the curve $U(\mathbf{x}_i, \cdot)$ is the highest of the utility curves at θ_i , as shown in Figure 1. If the contracts satisfy only the adjacent incentive constraints, then we know only that for each i , $U(\mathbf{x}_i, \cdot)$ is above $U(\mathbf{x}_{i+1}, \cdot)$ at θ_i and below at θ_{i+1} .

A key property of a set of contracts can be defined in terms of their utility curves: $\{\mathbf{x}_1, \dots, \mathbf{x}_n\}$ satisfies the single-crossing property if

(SCP) no distinct pair of the utility curves $U(\mathbf{x}_1, \cdot), \dots, U(\mathbf{x}_n, \cdot)$ intersect at more than one point, and they actually cross at any point of intersection in the interval (θ_1, θ_n) .

This single-crossing property should not be confused with the less fundamental, but very well-known, single-crossing property of indifference curve maps. We shall refer to the latter shortly.

Although it has not been put quite this way before, the local approach has always been justified by showing that solutions to the relaxed problem satisfy SCP. This is because AIC and SCP imply IC. For, suppose to the contrary that $\{\mathbf{x}_1, \dots, \mathbf{x}_n\}$ satisfies AIC and SCP, but not IC. Then there exists an i and, we can assume, some $j > i + 1$ such that type θ_j prefers contract \mathbf{x}_i the most, i.e. the curve $U(\mathbf{x}_i, \cdot)$ is strictly above all the other curves at θ_j (see Figure 2).¹⁰ We can also assume $\mathbf{x}_i \neq \mathbf{x}_{i+1}$, since we can always let i be the largest integer such that type θ_j prefers \mathbf{x}_i the most. So $U(\mathbf{x}_i, \cdot)$ is strictly above $U(\mathbf{x}_{i+1}, \cdot)$ at θ_j , while AIC implies that $U(\mathbf{x}_i, \cdot)$ is above $U(\mathbf{x}_{i+1}, \cdot)$ at θ_i and below at θ_{i+1} . This violates SCP.

In order to show that SCP holds, it is standard practice to assume that the marginal rates of substitution are ordered by type (MRS-ordering):

$$(MRSO) \quad -U_h(\cdot, \theta)/U_k(\cdot, \theta) \text{ increases in } \theta \text{ for all } h < k.$$

Thus, higher types are assumed to be willing to pay more for a given increase in any of the $k-1$ attributes. Although restrictive, MRS-ordering does describe a natural way in which consumers may vary.

If $k=2$, i.e. if there is only one attribute, then MRSO implies that any indifference curve of one type crosses that of another type at most once. This is the usual "single-crossing property" of indifference curve maps (see, e.g. (Cooper (1984))). It is equivalent to SCP holding for all sets of contracts; the key step in the proof is the simple observation that two utility curves $U(\mathbf{x}, \cdot)$ and $U(\hat{\mathbf{x}}, \cdot)$ intersect at two points θ and θ^0 if and only if both of these types are indifferent between \mathbf{x} and $\hat{\mathbf{x}}$. Thus, $k=2$ and MRSO together guarantee that all sets of contracts will satisfy SCP.

If $k > 2$, the single-crossing property of indifference curve maps cannot

hold: two $(k-1)$ -dimensional indifference "curves" (manifolds) generically form either an empty or a $(k-2)$ -dimensional intersection containing, if $k > 2$, a continuum of points. It is then impossible for all sets of contracts to satisfy SCP. An additional property is used in this case. Say that a set $\{\mathbf{x}_1, \dots, \mathbf{x}_n\}$ is attribute-ordered if

(AO) for any $i < j$, $\mathbf{x}_i = (\mathbf{a}_i, b_i)$ and $\mathbf{x}_j = (\mathbf{a}_j, b_j)$, the attribute levels satisfy $a_{h,i} \leq a_{h,j}$ for all $h < k$.

Properties MRSO and AO together give SCP, as the following lemma implies.

LEMMA 0: If MRSO holds, and if $\{\mathbf{x}_1, \dots, \mathbf{x}_n\}$ has the property that for any pair $\mathbf{x}_i = (\mathbf{a}_i, b_i)$ and $\mathbf{x}_j = (\mathbf{a}_j, b_j)$, either $a_{h,i} \leq a_{h,j}$ for all $h < k$ or $a_{h,i} \geq a_{h,j}$ for all $h < k$, then $\{\mathbf{x}_1, \dots, \mathbf{x}_n\}$ satisfies SCP.¹¹

PROOF: Assume that for some i and j , the utility curves $U(\mathbf{x}_i, \cdot)$ and $U(\mathbf{x}_j, \cdot)$ are distinct and intersect at θ^0 , where $\mathbf{x}_i = (\mathbf{a}_i, b_i)$ and $\mathbf{x}_j = (\mathbf{a}_j, b_j)$. Let $b(\mathbf{a})$ be the function whose graph for all \mathbf{a} between \mathbf{a}_i and \mathbf{a}_j coincides with the indifference surface of type θ^0 that contains \mathbf{x}_i and \mathbf{x}_j : $b(\mathbf{a})$ is given by

$$(2.1) \quad U(\mathbf{a}, b(\mathbf{a}), \theta^0) = U(\mathbf{x}_i, \theta^0).^{12}$$

Then $b(\cdot)$ is continuous, with $b(\mathbf{a}_i) = b_i$, $b(\mathbf{a}_j) = b_j$, and derivatives

$$(2.2) \quad b_h(\mathbf{a}) = \frac{-U_h(\mathbf{a}, b(\mathbf{a}), \theta^0)}{U_k(\mathbf{a}, b(\mathbf{a}), \theta^0)} \quad \text{for all } h < k.$$

Letting $\mathbf{a}(t) = t\mathbf{a}_j + (1-t)\mathbf{a}_i$ and $\mathbf{x}(t) = (\mathbf{a}(t), b(\mathbf{a}(t)))$, from (2.2) we have

$$\begin{aligned}
(2.3) \quad U(\mathbf{x}_j, \theta) - U(\mathbf{x}_i, \theta) &= \int_0^1 \left\{ \sum_{h=1}^{k-1} [U_h(\mathbf{x}(t), \theta) + U_k(\mathbf{x}(t), \theta) b_h(\mathbf{a}(t))] [a_{h,j} - a_{h,i}] \right\} dt \\
&= \int_0^1 U_k(\mathbf{x}(t), \theta) \sum_{h=1}^{k-1} \left[\frac{U_h(\mathbf{x}(t), \theta)}{U_k(\mathbf{x}(t), \theta)} - \frac{U_h(\mathbf{x}(t), \theta^0)}{U_k(\mathbf{x}(t), \theta^0)} \right] [a_{h,j} - a_{h,i}] dt
\end{aligned}$$

for all θ . Relabeling if necessary, we may assume by hypothesis that $a_{h,j} - a_{h,i} \geq 0$ for each $h < k$. Further, $a_{h,j} - a_{h,i} > 0$ for some $h < k$, for otherwise $\mathbf{a}_i = \mathbf{a}_j$ and $U(\mathbf{x}_j, \theta^0) = U(\mathbf{x}_i, \theta^0)$ would imply $b_i = b_j$, and the two utility curves would not be distinct. Consequently, as $U_k < 0$, the second integral in (2.3) is positive if $\theta > \theta^0$ and negative if $\theta < \theta^0$. This shows that $\{\mathbf{x}_1, \dots, \mathbf{x}_n\}$ satisfies SCP. Q.E.D.

The solid arrows in Figure 3 summarize our discussion of the local approach so far. Any solution to the relaxed problem satisfies AIC. Properties MRSO and either $k=2$ or AO are used in addition to get that such solutions satisfy IC and hence solve the unrelaxed problem.

We do not know of any way to use the local approach without assuming, or obtaining as an intermediate step, the attribute-ordering property. When $k=2$, AO is a direct consequence of MRSO and AIC (see the speckled arrows in Figure 3); the standard revealed preference argument for this, which uses $U_k < 0$, is illustrated in Figure 4. Although AO is not implied by MRSO and AIC when $k > 2$, it is then sometimes simply assumed to hold (see, e.g. Mirman and Sibley (1980) or Proposition 8 in Maskin and Riley (1984b)).^{13,14} In two other papers a "regularity condition" is assumed which, together with the first order conditions for the relaxed problem, imply that its solutions will satisfy AO. The first is Maskin and Riley (1984a), where the regularity condition involves the utility function, the type distribution function, and

the choice variables $\mathbf{x}_1, \dots, \mathbf{x}_n$. In the second paper, Matthews and Moore (1986), a companion to this one, the regularity condition is simply that the hazard rate $f(\theta)/[1-F(\theta)]$ be nondecreasing.¹⁵

In this paper we are interested in whether an optimal set of (three-dimensional) contracts is necessarily attribute-ordered. We must therefore use a non-local approach. To our knowledge, only two monopoly screening papers have discussed non-local approaches. The first is Spence (1980), where attention is focused more on obtaining general algorithms than on characterizing optimal contracts. The second is Moore (1984), which introduces the approach we develop and use in this paper. It is based on a relaxed problem derived from (M) by replacing IC with the set of downward incentive constraints:

$$(DIC) \quad U(\mathbf{x}_i, \theta_i) \geq U(\mathbf{x}_j, \theta_i) \quad \text{for all } j < i.$$

This formalizes the intuition that the monopolist's principal concern is to prevent high types from being attracted to the contracts meant for low types. Because only one direction of incentive constraint is imposed in the new relaxed problem, the resulting distortions in the contracts that solve it are relatively easy to determine.

But solutions to this relaxed problem are of interest only if they solve the unrelaxed problem, which they do if they satisfy the neglected upward incentive constraints. The key to showing this, as we shall explain in Section 4, is to make sufficient assumptions on the utility function to guarantee that two utility curves cannot cross more than twice, and that they can cross twice only if their contracts are related in a particular fashion. Loosely put, then, the method is based on a double-crossing property of the

utility curves.

3. THE MODEL

We now turn to the details of our model. Quality will be represented as a probability of functioning, which is a common way of representing quality in static models.¹⁶ It is also restrictive, since the dichotomy between working and total breakdown does not represent a continuum of possible lifetimes or partial effectivenesses. Considering warranties as monetary compensations is also common.¹⁷ Warranties that specify compensation are best thought of as providing insurance against an interruption of the product's flow of services; such insurance will be desirable whenever replacement cannot be made instantaneously.

Consumers are assumed to observe the quality of any product they purchase. Warranties therefore will not signal unobservable quality.¹⁸ Also, warranties will not affect the level of care taken by consumers,¹⁹ and seller-buyer disputes will not occur over whether the product failed.²⁰ These moral hazard issues are assumed away in order to focus clearly on the screening issue. We do assume one moral hazard problem, namely, that third parties cannot determine whether a failed product had received proper care. This assumption prevents third party insurance, thereby allowing the monopoly to bundle warranties with qualities.

We regard a monopoly primarily as a polar case of an imperfectly competitive market in which screening can take place. The literature on monopoly provision of quality and warranties is slim. Grossman (1981), who models quality and warranty as we do, considers a monopolized market; however, he assumes that quality is exogenously determined and unobservable, and that consumers are identical. Braverman, Guasch and Salop (1983) demonstrate that

a monopoly can bundle a warranty with a quality level to achieve in effect a two-part tariff; however, their warranties specify replacement and their consumers are all also alike.

Our model is most like that of Mussa and Rosen (1978). It would be the same if consumers were risk neutral. Consumers then would not care independently about the price and warranty coverage associated with a product, but would care only about the expected payment. Consumers' utility functions would be linear in the two components of a contract, quality and expected payment, and therefore satisfy the single-crossing property of indifference curve maps. The resulting screening problem can, as Mussa and Rosen show, be solved by using the local approach.

In our model, choosing a product corresponds to choosing a contract $\mathbf{x} = (p, q, w)$ where p is the price, q is the quality, and w is the warranty. The quality q is the probability that the product will work; the warranty w is the amount of money to be returned to the consumer if it fails. Because not purchasing a product will be equivalent to purchasing at a zero price a product with a zero probability of working, we represent not purchasing as choosing the no-purchase contract $0 = (0, 0, 0)$. The set $\mathbf{X} = \mathbf{R} \times [0, 1] \times \mathbf{R}$ of contracts $\mathbf{x} = (p, q, w)$ therefore contains all possible options for a consumer.

Consumers vary according to their willingness to pay. A consumer of type θ has an evaluation of θ dollars for a functioning product, regardless of his initial income. Consequently, a consumer of type θ who chooses a contract (p, q, w) receives, in dollar terms, $\theta - p$ if the product works and $w - p$ if it fails. There are n consumer types, denoted by $\theta_1 < \theta_2 < \dots < \theta_n$. The fraction of consumers who are of type θ_i is $f_i > 0$.

All consumers have the same risk preferences, embodied in a strictly concave, increasing utility function $u: (L, \infty) \rightarrow \mathbf{R}$, where $-\infty \leq L < 0$ and

$u(y) \rightarrow -\infty$ as $y \rightarrow L$. The expected utility a consumer of type θ obtains from contract \mathbf{x} is

$$U(\mathbf{x}, \theta) = qu(\theta - p) + (1 - q)u(w - p).$$

Referring back to the discussion in Section 2, it is readily verified that this U satisfies MRSO if we let the attribute vector be $\mathbf{a} = (p, q)$ and the "outlay" be $\mathbf{b} = -w$. (The connection with the literature on optimal auctions for risk averse buyers, Maskin and Riley (1984a), Matthews (1983), and Moore (1984), should also be noted: simply interpret q as the probability of winning, θ as a representative bidder's evaluation of the object at auction, p as the amount he pays if he wins, and $p - w$ as the amount he pays if he loses.)

As in Mussa and Rosen (1978), the firm can produce any number of products of quality q at a unit cost $C(q)$. This assumes away reasons for product variety based upon scale or scope economies, allowing us to focus on demand effects. We assume C has derivatives $C' \geq 0$ and $C'' \geq 0$, with $C(0) = 0$. We also assume $C'(0) < \theta_n$, so that it will be optimal to sell products with positive quality to at least the highest types of consumer. We further assume $C(1) > \theta_n$, which will imply that no consumer will receive a product with perfect quality $q = 1$. The expected profit obtained from each consumer who chooses contract \mathbf{x} is

$$\pi(\mathbf{x}) = p - C(q) - (1 - q)w,$$

and the producer maximizes total expected profits.

Fully efficient allocations are easy to describe. First, the price $p(\theta)$ is a transfer irrelevant to the question of efficiency. Next, consumers

should be fully insured, so that a consumer's warranty should equal his evaluation: $w^*(\theta) = \theta$. The quality should then be set to maximize the expected surplus $\theta q - C(q)$, which results in

$$q^*(\theta) = \begin{cases} 0 & \text{if } \theta < C'(0) \\ \{q \mid C'(q) = \theta\} & \text{otherwise.} \end{cases}$$

To ease the exposition, we assume in the remainder of this section that $q^*(\cdot)$ is single-valued, which is the case when C is strictly convex.

Notice that the optimal allocation $(q^*(\theta), w^*(\theta))_{\theta \in \mathbf{I}}$ is independent of the distribution of types. Furthermore, higher type consumers demand both higher qualities and higher warranties, so that qualities and warranties are increase in type. Finally, consumers who purchase a product do not care if it works or not, receiving $\theta - p(\theta)$ in either case.

If there are several firms competing in a Bertrand fashion by putting contracts on the market, the resulting equilibrium will be fully efficient, with each contract yielding zero expected profit. It has $\mathbf{x}^c(\theta) = 0$ if $\theta < C'(0)$, and otherwise $w^c(\theta) = \theta$, $q^c(\theta) = q^*(\theta)$, and $p^c(\theta) = C(q^*(\theta)) + (1 - q^*(\theta))\theta$. All three components of a competitive contract increase in θ . Because $\mathbf{x}^c(\theta)$ maximizes $U(\mathbf{x}, \theta)$ subject to $\pi(\mathbf{x}) \geq 0$, the competitive allocation is incentive compatible, i.e., consumers of type θ prefer $\mathbf{x}^c(\theta)$ to any other market contract. Bertrand competition therefore yields the same allocation regardless of whether firms can observe each consumer's type.

The same is not true of the perfectly discriminatory allocation, $\mathbf{x}^d(\theta)$, which is the efficient one that maximizes $\pi(\mathbf{x})$ subject to the constraint $U(\mathbf{x}, \theta) \geq U(\mathbf{0}, \theta) = u(0)$. Interestingly, this allocation has full money-back warranties, since all the surplus is extracted from type θ by setting $p^d(\theta) = \theta = w^d(\theta)$. Again, w^d , q^d , and p^d each increase in θ . This allocation

is not incentive compatible because most consumer types would prefer a contract meant for some lower type. This follows from $U(\mathbf{x}^d(\theta), \theta) = u(0)$, whereas $U(\mathbf{x}^d(\hat{\theta}), \theta) > U(\mathbf{x}^d(\hat{\theta}), \hat{\theta}) = u(0)$ for any $\hat{\theta} < \theta$ satisfying $q(\hat{\theta}) > 0$. The discriminatory allocation is therefore infeasible if all consumers choose from the same set of contracts.

4. THE CHARACTERIZATION THEOREMS

We now consider, in the context of our model, the monopoly problem (M) given in Section 2. The only change in notation is that \bar{u} is replaced by $u(0)$ in the VP constraint, since $u(0)$ is the utility level achieved by not purchasing a product. Let (M') denote the relaxed problem obtained by replacing the full set of incentive constraints, IC, by just the downward ones, DIC. Our central technical result, Theorem 2 below, is that solutions to (M') satisfy the missing upward incentive constraints; that is, (M) and (M') have the same set of solutions.

We need to make an additional preference assumption, namely, that consumers have nonincreasing absolute risk aversion (NIARA):

$$(NIARA) \quad R(y) \equiv \frac{-u''(y)}{u'(y)} \quad \text{is nonincreasing.}$$

This assumption will be maintained henceforth, as will the technical assumption that $u(\cdot)$ is four times differentiable, with $u' > 0$ and $u'' < 0$.

An immediate implication of NIARA is that u' is convex in u , and that u' is linear in u if $u(\cdot)$ exhibits constant absolute risk aversion (CARA).²¹ Therefore, for any constant y and random variable \tilde{y} ,

$$(4.1) \quad Eu(\tilde{y}) = u(y) \quad \Rightarrow \quad Eu'(\tilde{y}) \geq u'(y),$$

with an equality in the case of CARA. Since by concavity u' decreases in u , (4.1) has the following two implications:

$$(4.2) \quad Eu(\tilde{y}) \leq u(y) \quad \Rightarrow \quad Eu'(\tilde{y}) \geq u'(y)$$

$$(4.3) \quad Eu'(\tilde{y}) \leq u'(y) \quad \Rightarrow \quad Eu(\tilde{y}) \geq u(y),$$

where in both cases an equality on the left implies an equality on the right if $u(\cdot)$ exhibits CARA.

So far we have implicitly assumed that at an optimum, the payments p_i and w_i will be deterministic. This should be justified, particularly since in some models randomizing payments reduces the loss imposed by incentive constraints (see, for example, the exposition by Arnott and Stiglitz (1985)). In the present model, NIARA implies that stochastic contracts are never optimal in (M') . The intuition for this is that if one type's contract had a random payment, then replacing that payment by its certainty equivalent (for him) would increase profits. Downward incentive compatibility would not be upset because the higher types, who are less risk averse, would not prefer the new deterministic contract to the original random contract.

To show this formally, let $\tilde{\mathbf{x}} = (\tilde{p}, q, \tilde{w})$ denote a contract in which the price \tilde{p} and the warranty \tilde{w} are perhaps stochastic. Then the full monopoly problem (i.e. admitting the possibility of random payments) should be written

$$(\tilde{M}) \quad \text{Maximize} \quad \sum_{i=1}^n E\pi(\tilde{\mathbf{x}}_i) f_i \quad \text{subject to} \\ \tilde{\mathbf{x}}_1, \dots, \tilde{\mathbf{x}}_n$$

$$(IC) \quad EU(\tilde{\mathbf{x}}_i, \theta_i) \geq EU(\tilde{\mathbf{x}}_j, \theta_i) \quad \text{for all } j \neq i, \text{ and}$$

$$(VP) \quad EU(\tilde{\mathbf{x}}_i, \theta_i) \geq u(0) \quad \text{for all } i,$$

where $EU(\tilde{\mathbf{x}}, \theta)$ and $E\pi(\tilde{\mathbf{x}})$ are given by

$$EU(\tilde{\mathbf{x}}, \theta) \equiv qEu(\theta - \tilde{p}) + (1-q)Eu(\tilde{w} - \tilde{p})$$

$$E\pi(\tilde{\mathbf{x}}) \equiv E\tilde{p} - C(q) - (1-q)E\tilde{w}.$$

The corresponding relaxed problem, (\tilde{M}') , has IC replaced by the downward incentive constraints

$$(DIC) \quad EU(\tilde{\mathbf{x}}_i, \theta_i) \geq EU(\tilde{\mathbf{x}}_j, \theta_i) \quad \text{for all } j < i.$$

There is a trivial indeterminacy in the solutions of (\tilde{M}) and (\tilde{M}') : of the two net payments \tilde{p}_i and $\tilde{w}_i - \tilde{p}_i$, only the first is relevant if $q_i = 1$, and only the second is relevant if $q_i = 0$. We shall say $\{\tilde{\mathbf{x}}_1, \dots, \tilde{\mathbf{x}}_n\}$ is a solution to (\tilde{M}) or (\tilde{M}') only if each \tilde{p}_i (resp. \tilde{w}_i) is deterministic if $q_i = 0$ (resp. $q_i = 1$). Given this convention, we have

THEOREM 1: Every contract $\tilde{\mathbf{x}}_i$ in a solution to (\tilde{M}') has a deterministic price \tilde{p}_i and warranty \tilde{w}_i . That is, (\tilde{M}') and (M') have the same solutions.

PROOF: Consider a contract $\tilde{\mathbf{x}}_i$ in which the price \tilde{p}_i is not deterministic, so that $q_i > 0$ by our convention. Define a deterministic p_i^* by $u(\theta_i - p_i^*) = EU(\theta_i - \tilde{p}_i)$. The strict concavity of u implies that $p_i^* > E\tilde{p}_i$.

Let $\tilde{w}_i^* = p_i^* + (\tilde{w}_i - \tilde{p}_i)$. Then, replacing $\tilde{\mathbf{x}}_i$ by $\tilde{\mathbf{x}}_i^* \equiv (p_i^*, q_i, \tilde{w}_i^*)$ will not affect the expected utility of type i , but will increase the monopoly's expected profit. Moreover, $\tilde{D}\tilde{I}C$ will continue to be satisfied. To see this, let

$$\begin{aligned}\phi(\theta) &\equiv EU(\tilde{\mathbf{x}}_i^*, \theta) - EU(\tilde{\mathbf{x}}_i, \theta) \\ &= q_i u(\theta - p_i^*) - q_i Eu(\theta - \tilde{p}_i).\end{aligned}$$

Note that (4.2) implies that $\phi(\theta)$ and $\phi'(\theta)$ cannot both be positive at any θ . Thus, since $\phi(\theta_i) = 0$, $\phi(\theta) \leq 0$ for all $\theta > \theta_i$. So all types higher than θ_i prefer $\tilde{\mathbf{x}}_i$ to $\tilde{\mathbf{x}}_i^*$, which implies that $\tilde{D}\tilde{I}C$ continues to be satisfied.

Finally, it is clear that a non-deterministic $(\tilde{w}_i - \tilde{p}_i)$ should be replaced by its certainty equivalent. This will not affect any consumer's expected utility of this contract, and so not affect $\tilde{D}\tilde{I}C$, but will increase the monopoly's expected profit. Q.E.D.

Theorem 1, when taken in conjunction with Theorem 2 below, will imply that any solution to the full monopoly problem (\tilde{M}) is deterministic and solves the comparatively simpler problem (M') . Without loss of generality, we now omit reference to stochastic payments and drop the tildes.

The next proposition states some useful, but not surprising, properties of solutions to (M') .

PROPOSITION 1: Every contract \mathbf{x}_i in a solution to (M') satisfies

(i) $\pi(\mathbf{x}_i) \geq 0$; (ii) $q_i < 1$; and (iii) if $q_i = 0$ then $w_i - p_i = 0$ and $q_j = 0$ for all $j < i$.

PROOF: To prove (i), assume it is false. Then let $i \geq 1$ be the smallest i such that $\pi(\mathbf{x}_i) < 0$. Then, since $f_i > 0$, replacing \mathbf{x}_i by the contract that type θ_i prefers the most in $\{0\} \cup \{\mathbf{x}_1, \dots, \mathbf{x}_{i-1}\}$ increases profit without violating DIC or VP. This contradiction proves (i). To prove (ii), note that $C(1) > \theta_n$ implies that if $q_i = 1$, then $\pi(\mathbf{x}_i) = p_i - C(1)$ is nonnegative only if $p_i > \theta_n$. But then $U(\mathbf{x}_i, \theta_i) = u(\theta_i - p_i) < u(0)$, contrary to VP. To prove (iii), assume $q_i = 0$. Then VP implies $w_i - p_i \geq 0$, and (i) implies $w_i - p_i = -\pi(\mathbf{x}_i) \leq 0$. So $w_i - p_i = 0$, and $U(\mathbf{x}_i, \theta_i) = u(0)$. If $q_j > 0$ for some $j < i$, then $U(\mathbf{x}_j, \theta_i) > U(\mathbf{x}_j, \theta_j)$. But then DIC and VP imply $U(\mathbf{x}_i, \theta_i) > U(\mathbf{x}_j, \theta_j) \geq u(0)$, contrary to $U(\mathbf{x}_i, \theta_i) = u(0)$. Q.E.D.

Because of part (iii) of Proposition 1, we can adopt the convention that $\mathbf{x}_i = 0$ if and only if $q_i = 0$. That is, we shall set $p_i = w_i = 0$ if $q_i = 0$.

We now need the first order conditions for (M'). Let $\mu_1 f_1$ be the nonnegative multiplier associated with the first VP constraint, $U(\mathbf{x}_1, \theta_1) \geq u(0)$. The VP constraints for $i > 1$ need not be included: they will be automatically satisfied because DIC implies that $U(\mathbf{x}_i, \theta_i)$ is nondecreasing in i . Let $\lambda_{ji} f_j$, where $j < i$, be the nonnegative multiplier associated with a typical (downward) incentive constraint $U(\mathbf{x}_i, \theta_i) \geq U(\mathbf{x}_j, \theta_i)$. It is convenient to regard the choice variables of (M') as $w_i - p_i$, p_i , and q_i . Letting $\mu_i \equiv \sum_{j < i} \lambda_{ji} f_j f_i^{-1}$ for $i > 1$, the first order conditions with respect to these three variables are, respectively,

$$(4.4) \quad -1 + (\mu_i - \sum_{j > i} \lambda_{ij}) u'(w_i - p_i) = 0,$$

$$(4.5) \quad 1 - \mu_i u'(\theta_i - p_i) + \sum_{j > i} \lambda_{ij} u'(\theta_j - p_i) = 0 \quad \text{if } q_i > 0,$$

$$(4.6) \quad w_i - C'(q_i) + \mu_i [u(\theta_i - p_i) - u(w_i - p_i)] - \sum_{j>i} \lambda_{ij} [u(\theta_j - p_i) - u(w_i - p_i)] \\ \leq 0, \quad \text{with equality if } q_i > 0.$$

(Account has been taken in (4.4) and (4.6) of the fact that $q_i < 1$ for all i .)

Let $\lambda_{ij} \equiv \lambda_{ij} u'(w_i - p_i)$, which is nonnegative. If $q_i > 0$, then μ_i can be eliminated from (4.4) - (4.6) to yield the following two equations:

$$(4.7) \quad u'(w_i - p_i) + \sum_{j>i} \lambda_{ij} u'(\theta_j - p_i) = (1 + \sum_{j>i} \lambda_{ij}) u'(\theta_i - p_i)$$

$$(4.8) \quad [w_i - C'(q_i)] u'(w_i - p_i) = \\ u(w_i - p_i) + \sum_{j>i} \lambda_{ij} u(\theta_j - p_i) - (1 + \sum_{j>i} \lambda_{ij}) u(\theta_i - p_i),$$

Two more properties of solutions to (M') immediately follow from these conditions. First, from (4.7) and the concavity of $u(\cdot)$,

$$(4.9) \quad q_i > 0 \Rightarrow w_i \leq \theta_i.$$

Second, since u is convex in u' , (4.7) implies that the RHS of (4.8) is nonnegative (zero if $u(\cdot)$ exhibits CARA). Therefore,

$$(4.10) \quad q_i > 0 \Rightarrow w_i \geq C'(q_i) \quad (\text{with equality if } u(\cdot) \text{ exhibits CARA}).$$

We discuss, and strengthen, (4.9) and (4.10) in the next section.

Perhaps the most important use of NIARA is in the following lemma, which can be loosely summarized by saying that two utility curves cannot cross more

than twice, and if they do cross twice then the more "curved" one corresponds to the contract with the larger price and the smaller quality. (See Figure 5.) These properties will be the key to proving that the upward incentive constraints can be discarded.

LEMMA 1: Let $(\mathbf{x}, \hat{\mathbf{x}}) = ((p, q, w), (\hat{p}, \hat{q}, \hat{w}))$ be a pair of distinct contracts, and suppose that $\theta^- < \theta^0 < \theta^+$ are three types such that types θ^- and θ^+ (weakly) prefer \mathbf{x} to $\hat{\mathbf{x}}$, whereas type θ^0 (weakly) prefers $\hat{\mathbf{x}}$ to \mathbf{x} . Then if at least one of the preferences is strict, $p < \hat{p}$ and $q > \hat{q} > 0$. Furthermore,

(i) if $U(\mathbf{x}, \theta^+) > u(\hat{\mathbf{x}}, \theta^-)$, then $U(\mathbf{x}, \theta) > U(\hat{\mathbf{x}}, \theta)$ for all $\theta > \theta^+$, and

(ii) if $U(\mathbf{x}, \theta^-) > U(\hat{\mathbf{x}}, \theta^-)$, then $U(\mathbf{x}, \theta) > U(\hat{\mathbf{x}}, \theta)$ for all $\theta < \theta^-$.

PROOF: Let $\Delta(\theta) \equiv U(\hat{\mathbf{x}}, \theta) - U(\mathbf{x}, \theta)$. Recalling our convention that $\mathbf{x} = (0, 0, 0)$ if $q = 0$, it follows from $\mathbf{x} \neq \hat{\mathbf{x}}$ that $q \neq 0$ or $\hat{q} \neq 0$. As at least one of the preferences is strict, there must be some point θ^* such that $\Delta'(\theta^*) = 0$. This implies that $q \neq 0$, $\hat{q} \neq 0$, and $q/\hat{q} = u'(\theta^* - p)/u'(\theta^* - \hat{p})$.²² Also, another point θ^{**} exists such that $0 > (\theta^{**} - \theta^*)\Delta'(\theta^{**})$. Dividing this inequality by $\hat{q}u'(\theta^{**} - \hat{p})$ and substituting $u'(\theta^* - \hat{p})/u'(\theta^* - p)$ for q/\hat{q} yields

$$\begin{aligned} 0 > (\theta^{**} - \theta^*) & \left[\frac{u'(\theta^{**} - \hat{p})}{u'(\theta^{**} - p)} - \frac{u'(\theta^* - \hat{p})}{u'(\theta^* - p)} \right] \\ & = (\theta^{**} - \theta^*) \int_{\theta^*}^{\theta^{**}} \left[\frac{u'(\theta - \hat{p})}{u'(\theta - p)} \right] [R(\theta - p) - R(\theta - \hat{p})] d\theta, \end{aligned}$$

where $R(y) \equiv -u''(y)/u'(y)$. NIARA now implies that $p < \hat{p}$. It follows from

$q/\hat{q} = u'(\theta^* - p)/u'(\hat{\theta}^* - p)$ that $q > \hat{q}$.

To prove (i), assume $U(\mathbf{x}, \theta^+) > U(\hat{\mathbf{x}}, \theta^+)$, but that $U(\mathbf{x}, \theta^{++}) < U(\hat{\mathbf{x}}, \theta^{++})$ for some $\theta^{++} > \theta^+$. Then applying the first part of the lemma to $(\hat{\mathbf{x}}, \mathbf{x})$ and $(\theta^0, \theta^+, \theta^{++})$ yields $\hat{p} < p$, a contradiction. This proves (i), and (ii) is proved similarly. Q.E.D.

THEOREM 2: The monopoly problem (M) and the relaxed problem (M') have the same set of solutions. Furthermore, any solution satisfies

- (i) the voluntary participation constraint is binding for the lowest type: $U(\mathbf{x}_1, \theta_1) = u(0)$;
- (ii) the adjacent downward incentive constraints are binding for all higher types: $U(\mathbf{x}_i, \theta_i) = U(\mathbf{x}_{i-1}, \theta_i)$ for all $i > 1$; and
- (iii) if an upward incentive constraint is binding, then all types in the interval receive identical contracts: if $U(\mathbf{x}_s, \theta_s) = U(\mathbf{x}_t, \theta_s)$ for some $s < t$, then $\mathbf{x}_i = \mathbf{x}_s$ for all $i \in \{s, \dots, t\}$.

PROOF: We note first that (i) is satisfied. For if $U(\mathbf{x}_1, \theta_1) > u(0)$, then p_1 could be raised to increase profit without upsetting VP or DIC.

To show that (M) and (M') have the same solution sets, it suffices to show that all solutions to (M') satisfy the upward incentive constraints removed from (M) to obtain (M'). Let $A = \{\mathbf{x}_1, \dots, \mathbf{x}_n\}$ be any solution to (M'). Then group the upward incentive constraints as follows:

$$(UIC_k) \quad U(\mathbf{x}_i, \theta_i) > U(\mathbf{x}_j, \theta_i) \quad \text{for all } i, j \text{ such that } i < j \leq k.$$

We must show that A satisfies UIC_n . We prove this by induction on k .

Trivially, A satisfies UIC_1 . Now assume A satisfies UIC_k for some $k < n$. We

show that A satisfies UIC_{k+1} in Steps 1-3 below; these steps will also establish part (ii) of the theorem. Part (iii) is proved separately in Step 4.

Step 1: The adjacent downward constraints are binding in $\{\theta_1, \dots, \theta_{k+1}\}$, i.e.

$$U(\mathbf{x}_i, \theta_i) = U(\mathbf{x}_{i-1}, \theta_i) \text{ for all } 1 < i \leq k+1.$$

Suppose to the contrary that $U(\mathbf{x}_i, \theta_i) > U(\mathbf{x}_{i-1}, \theta_i)$ for some such i . Then $q_i > 0$. Because raising p_i would increase profit without making \mathbf{x}_i more attractive to any type, there must be some $j < i-1$ such that $U(\mathbf{x}_i, \theta_i) = U(\mathbf{x}_j, \theta_i)$. Hence $U(\mathbf{x}_j, \theta_i) > U(\mathbf{x}_{i-1}, \theta_i) > U(\mathbf{x}_{i-1}, \theta_i)$. Since IC is satisfied for j and $i-1$, $U(\mathbf{x}_j, \theta_{i-1}) \leq U(\mathbf{x}_{i-1}, \theta_{i-1})$ and $U(\mathbf{x}_j, \theta_j) \geq U(\mathbf{x}_{i-1}, \theta_j)$. (See Figure 6.) The hypothesis of Lemma 1(i) is therefore satisfied at $(\mathbf{x}, \hat{\mathbf{x}}) = (\mathbf{x}_j, \mathbf{x}_{i-1})$ and $(\theta^-, \theta^0, \theta^+) = (\theta_j, \theta_{i-1}, \theta_i)$. So $q_j > q_{i-1} > 0$ and $U(\mathbf{x}_j, \theta) > U(\mathbf{x}_{i-1}, \theta)$ for every $\theta \geq \theta_i$. The latter implies, by DIC, that for all $k \geq i$, $U(\mathbf{x}_k, \theta_k) > U(\mathbf{x}_{i-1}, \theta_k)$. By complementary slackness, therefore, $\lambda_{i-1, k} = 0$ for all $k \geq i$. So by replacing i with $i-1$ in (4.7) and (4.8), we deduce that $\theta_{i-1} = C'(q_{i-1})$. But replacing i by j in (4.9) and (4.10) gives $\theta_j \geq C'(q_j)$. Therefore, using $q_{i-1} < q_j$ and the convexity of C , it follows that $\theta_{i-1} \leq \theta_j$. This contradiction of $j < i-1$ proves that $U(\mathbf{x}_i, \theta_i)$ must equal $U(\mathbf{x}_{i-1}, \theta_i)$ for any $1 < i \leq k+1$.

Step 2a: Profit $\pi(\mathbf{x}_i)$ is nondecreasing in the range $\{\mathbf{x}_1, \dots, \mathbf{x}_{k+1}\}$.

Suppose $\pi(\mathbf{x}_i) < \pi(\mathbf{x}_{i-1})$ for some $1 < i \leq k+1$. Then, since

$U(\mathbf{x}_i, \theta_i) = U(\mathbf{x}_{i-1}, \theta_i)$, we could replace \mathbf{x}_i by \mathbf{x}_{i-1} to increase expected profit without violating DIC.

Step 2b: Profit is increasing on this range between any two distinct, nonzero contracts, i.e., if $1 \leq j < i \leq k+1$ and $0 \neq x_j \neq x_i$, then $\pi(\mathbf{x}_j) < \pi(\mathbf{x}_i)$.

In the light of Step 2a, we need only prove that for any $1 < i \leq k+1$, a contradiction follows from assuming $0 \neq x_{i-1} \neq x_i$ and $\pi(\mathbf{x}_{i-1}) = \pi(\mathbf{x}_i)$. First note that A solves (\tilde{M}') by Theorem 1. Another solution is $\tilde{A} = \{x_1, \dots, x_{i-1}, \tilde{x}, x_{i+1}, \dots, x_n\}$, where \tilde{x} is defined by

$$\tilde{x} = \begin{cases} x_{i-1} & \text{with probability } 1/2 \\ x_i & \text{with probability } 1/2. \end{cases}^{23}$$

\tilde{A} is feasible for problem (\tilde{M}') since $U(x_i, \theta_i) = U(x_{i-1}, \theta_i)$ implies $\tilde{D}\tilde{I}C$ is not violated, and \tilde{A} solves (\tilde{M}') because it generates the same expected profit as does A. Therefore, again by Theorem 1, \tilde{x} must have a deterministic price and warranty if $0 < (q_{i-1} + q_i)/2 < 1$. But this holds because, given $0 \neq x_{i-1}$, Proposition 1(ii) and (iii) imply that $0 < q_{i-1}, q_i < 1$. Let (\hat{p}, \hat{w}) be the common value of (p_{i-1}, w_{i-1}) and (p_i, w_i) . Now $q_{i-1} \neq q_i$, since $x_{i-1} \neq x_i$. This, together with $U(x_i, \theta_i) = U(x_{i-1}, \theta_i)$ from Step 1 implies $\theta_i - \hat{p} = \hat{w} - \hat{p}$, i.e. $\hat{w} = \theta_i$. But (4.9), with i replaced by $i-1$, implies that $\hat{w} \leq \theta_{i-1}$, which gives us the contradiction $\theta_i \leq \theta_{i-1}$.

Step 3: UIC_{k+1} holds; in fact, if $i < k+1$ and $x_i \neq x_{k+1}$, then $U(x_i, \theta_i) > U(x_{k+1}, \theta_i)$.

Suppose to the contrary that the set

$$T = \{i \mid i \leq k, x_i \neq x_{k+1}, \text{ and } U(x_i, \theta_i) \leq U(x_{k+1}, \theta_i)\}$$

is nonempty. Then by Proposition 1(iii), $q_{k+1} \neq 0$. Let j be the largest

element of T . We claim that $\mathbf{x}_j \neq 0$, and hence that $\pi(\mathbf{x}_j) < \pi(\mathbf{x}_{k+1})$ by Step 2b. For if $q_j = 0$,

$$U(\mathbf{x}_{j+1}, \theta_{j+1}) = U(\mathbf{x}_j, \theta_{j+1}) = u(0) = U(\mathbf{x}_j, \theta_j) < U(\mathbf{x}_{k+1}, \theta_j),$$

which, since $q_{k+1} > 0$, is strictly less than $U(\mathbf{x}_{k+1}, \theta_{j+1})$. So $j \neq k$. But then $j+1 \in T$, contrary to the maximality of j in T . Thus $\pi(\mathbf{x}_j) < \pi(\mathbf{x}_{k+1})$, as claimed. Replacing \mathbf{x}_j by \mathbf{x}_{k+1} in A increases expected profit and, because j was chosen maximal in T , does not cause DIC to be violated. This contradicts the fact that A solves (M') .

Step 4: If $U(\mathbf{x}_s, \theta_s) = U(\mathbf{x}_t, \theta_s)$ for $s < t$, then $\mathbf{x}_i = \mathbf{x}_s$ for $i \in \{s, \dots, t\}$.

To prove this, we use Steps 2a, 2b and 3 with $k+1$ replaced by t . Given $U(\mathbf{x}_s, \theta_s) = U(\mathbf{x}_t, \theta_s)$, it follows from Step 3 that $\mathbf{x}_s = \mathbf{x}_t$. Therefore by Step 2a, $\pi(\mathbf{x}_i) = \pi(\mathbf{x}_s)$ for all $i \in \{s, \dots, t\}$. If $\mathbf{x}_s = \mathbf{x}_t = 0$, then $\mathbf{x}_i = 0$ for all $i < t$ by Proposition 1. If $\mathbf{x}_s \neq 0$, then $\mathbf{x}_i = \mathbf{x}_s$ for each $i \in \{s, \dots, t\}$, for otherwise Step 2b and $\mathbf{x}_i \neq \mathbf{x}_s$ would imply $\pi(\mathbf{x}_i) > \pi(\mathbf{x}_s)$. Q.E.D.

5. PROPERTIES OF THE MONOPOLY SOLUTION

We now derive normative results about how each contract is distorted from full information optimality, as well as positive results about the monotonicity properties of the contracts. The following propositions refer to a monopoly set of contracts, which is a set of contracts solving the full monopoly problem (\tilde{M}) . However, we conclude from Section 4 that any solution to (\tilde{M}) also solves the much simpler problem (M') . To see why, observe first that (\tilde{M}) must yield profits between those of (M) and (\tilde{M}') . Then, since Theorems 1 and 2 together imply that (M) and (\tilde{M}') yield the same profits,

(\tilde{M}) and (\tilde{M}') must yield the same profits. Any solution to (\tilde{M}) therefore also solves (\tilde{M}') , so that Theorem 1 implies it is deterministic and solves (M') . Therefore, any solution $\{x_1, \dots, x_n\}$ of (\tilde{M}) satisfies the necessary conditions (4.4) - (4.10) for (M') , which we shall use repeatedly.

The first proposition concerns the welfare properties of the contracts. We establish that both qualities and warranties will be underprovided. Only the highest type consumer has an efficient contract; this familiar result follows because there is no need to distort the contract so as to deter some other (higher) type from selecting it.

PROPOSITION 2: Every contract $x_i \neq 0$, for $i < n$, has a quality and warranty that are below their full information levels: $q_i < q^*(\theta_i)$ and $w_i < \theta_i$.²⁴ The highest type of consumer receives a full information efficient contract: $q_n \in q^*(\theta_n)$ and $w_n = \theta_n$.

PROOF: For $i = n$, it follows from (4.7) that $w_n = \theta_n$, and from (4.8) that $w_n = C'(q_n)$. Thus $\theta_n = C'(q_n)$, so that $q_n \in q^*(\theta_n)$.

For $i < n$, we shall show that there is some multiplier λ_{ij} in (4.7) which is positive. This and the concavity of u will imply $w_i < \theta_i$, which with (4.10) gives $C'(q_i) < \theta_i$, so that $q_i < q^*(\theta_i)$.

Assume to the contrary that $\lambda_{ij} = 0$ for all $j > i$. It follows from (4.7) and (4.8) that $\theta_i = w_i = C'(q_i)$. Then for $k < i$, (4.9) and (4.10) imply

$$C'(q_k) \leq w_k \leq \theta_k < \theta_i = w_i = C'(q_i).$$

Thus $w_k < w_i$ and, since C is convex, $q_k < q_i$. Hence $p_k < p_i$; otherwise x_k would have a lower warranty than x_i without having either a lower price or a

higher quality, so that type θ_k would prefer \mathbf{x}_i to \mathbf{x}_k , contrary to IC.

We now show that $U(\mathbf{x}_{i+1}, \theta_{i+1}) = U(\mathbf{x}_k, \theta_{i+1})$ for some $k < i$. Equation (4.4), with i replaced by $i + 1$, gives $\mu_{i+1} > 0$. Recall the definition

$$\mu_{i+1} = \sum_{j < i+1} \lambda_{j,i+1} f_j f_{i+1}^{-1}.$$

Since, by assumption, $0 = \lambda_{i,i+1} \equiv \lambda_{i,i+1} u'(w_i - p_i)$, $k < i$ exists such that $\lambda_{k,i+1} > 0$. Complementary slackness now implies that

$$U(\mathbf{x}_{i+1}, \theta_{i+1}) = U(\mathbf{x}_k, \theta_{i+1}).$$

From Theorem 2(ii), $U(\mathbf{x}_{i+1}, \theta_{i+1}) = U(\mathbf{x}_i, \theta_{i+1})$. Therefore $\Delta(\theta_{i+1}) = 0$, where $\Delta(\theta) \equiv u(\mathbf{x}_i, \theta) - u(\mathbf{x}_k, \theta)$. Also, DIC implies $\Delta(\theta_i) > 0$. So $\Delta(\cdot)$ cannot be an increasing function. However, for any θ ,

$$\Delta'(\theta) = q_i u'(\theta - p_i) - q_k u'(\theta - p_k) > 0,$$

since $0 < q_i$, $q_k \leq q_i$, and $p_k < p_i$. Contradiction. Q.E.D.

Proposition 2 is illustrated in Figure 7. Holding the price p_i fixed, the figure shows the indifference curves of a type θ_i consumer and of the monopoly over pairs (q, w) . The full information optimal pair is $Y^* = (q^*(\theta_i), \theta_i)$, whereas the monopoly pair is $Y = (q_i, w_i) \ll Y^*$. Shifting Y into the crosshatched region would make the consumer better off and, if other (higher) types could be prevented from switching to \mathbf{x}_i , would also make the monopoly better off. In particular, if the incentive constraints could be ignored, the monopoly could increase profits by giving the consumer a higher quality and a higher warranty, without charging a higher price. The reason for this is that increasing q_i not only increases the expected utility of type

θ_i , but also increases the expected profit $\pi(\mathbf{x}_i)$. This follows from the fact that, since $C'(q_i) \leq w_i$, instead of $C'(q_i) = w_i$, q_i is less than the quality level that minimizes expected cost holding the warranty level fixed at w_i .

Although we cannot draw rigorous conclusions regarding moral hazard with this model, we remark that Proposition 2 does imply that one kind of moral hazard is alleviated. This is because $w-p \leq \theta-p$ implies that the consumer wants the product to work rather than to fail.

Proposition 2 is not refutable if the consumer types are unobservable. Refutable propositions then refer only to the set of contracts, without referring to the consumer type receiving each contract. The results that follow, when taken together, are of this kind.

The next proposition is not refutable as it stands if types are unobservable. However, it does imply that some contract should have warranty coverage less than price, whereas some other contract should have warranty coverage greater than price. This contrasts with the results of Section 3, where it was shown that in every competitive or perfectly discriminating contract, the warranty is no less than the price.²⁵

PROPOSITION 3: Let θ_m be the lowest type to purchase a product. If $m < n$, then $w_m < p_m$ and $w_n > p_n$.

PROOF: Since $x_{m-1} = 0$, from Theorem 2 we have

$$U(\mathbf{x}_m, \theta_m) = q_m u(\theta_m - p_m) + (1 - q_m) u(w_m - p_m) = U(\mathbf{x}_{m-1}, \theta_m) = u(0).$$

This implies $w_m < p_m$, since $0 < q_m < 1$ and $w_m < \theta_m$ by Proposition 2.

Also by Proposition 2, $w_n = \theta_n$. Hence, since $q_m > 0$, DIC implies that

$$u(w_n - p_n) = U(\mathbf{x}_n, \theta_n) \geq U(\mathbf{x}_m, \theta_n) > U(\mathbf{x}_m, \theta_m) = u(0).$$

Therefore $w_n > p_n$. Q.E.D.

The remaining propositions establish monotonicity relationships in the contract set.

PROPOSITION 4: More profit is made on higher types than on lower types:

$\pi(\mathbf{x}_i) \leq \pi(\mathbf{x}_{i+1})$ for all $i < n$, and $\pi(\mathbf{x}_i) < \pi(\mathbf{x}_{i+1})$ if $\mathbf{x}_i \neq \mathbf{x}_{i+1}$.

PROOF: For the most part, this was proved in the course of proving Theorem 2. The only case not dealt with there is where $0 = \mathbf{x}_i \neq \mathbf{x}_{i+1}$, i.e. where $m=i+1$, using the notation of Proposition 3. We must show $\pi(\mathbf{x}_m) > 0$.

Suppose $\pi(\mathbf{x}_m) = 0$. Then $m < n$, for positive profit can be made on at least type θ_n because, by assumption, $\theta_n > C'(0)$. Now, since C is convex and $C(0) = 0$, $C(q_m) \leq q_m C'(q_m)$, which from (4.10) is not more than $q_m w_m$. Therefore $\pi(\mathbf{x}_m) = p_m - C(q_m) - (1-q_m)w_m \geq p_m - w_m$, which by Proposition 3 is positive. Q.E.D.

If profits are observable, Proposition 4 can be used in conjunction with other results to yield refutable conclusions. For example, Proposition 3 and 4 together imply that the most profitable contracts have warranty coverage greater than price, but the least profitable contracts have warranty coverage less than price. Proposition 4 can also be used in conjunction with Theorem 3 below to predict under what conditions price, warranty, and quality vary positively with profitability.

Theorem 3 is stated in terms of the risk tolerance function, which is defined by $\rho(y) \equiv [R(y)]^{-1} = -u'(y)/u''(y)$. Assuming NIARA is equivalent to assuming ρ is nondecreasing.

THEOREM 3: If $i < n$ and $x_i \neq 0$, then

- (i) $p_i \leq p_{i+1}$,
- (ii) $p_i \leq p_{i+1}$ and $w_i \leq w_{i+1}$ if ρ is concave,
- (iii) $p_i \leq p_{i+1}$, $w_i \leq w_{i+1}$, and $q_i \leq w_{i+1}$ if ρ is constant.

PROOF: We prove (iii) first, using (i) and (ii). Assume $q_i > q_{i+1}$ for some i . Since $q_i > 0$, Proposition 1(iii) implies $q_{i+1} > 0$. Therefore, as $\rho' = 0$, (4.10) implies $w_i = C'(q_i)$ and $w_{i+1} = C'(q_{i+1})$. Then, by the convexity of C and $q_i > q_{i+1}$, $w_i \geq w_{i+1}$. Since by (i), $p_i \leq p_{i+1}$, IC is now violated: type θ_{i+1} prefers x_i to x_{i+1} because it offers a higher quality at no higher price and with no lower warranty. (A higher quality is beneficial, since $\theta_{i+1}^{-p_{i+1}} > \theta_i^{-p_{i+1}} \geq w_i^{-p_{i+1}} \geq w_{i+1}^{-p_{i+1}}$.) The rest of (iii) follows from (i) and (ii).

To prove (i) and (ii), it is most convenient to put the first order conditions (4.7) and (4.8) in terms of a function $h: \mathbb{R}^2 \rightarrow \mathbb{R}$ that is a discrete approximation to the risk tolerance function. Define h by

$$h(s,t) = \frac{u(t) - u(s)}{u'(s) - u'(t)}$$

if $s \neq t$, and by $h(s,s) = \rho(s) = [1/R(s)]$ otherwise. In Lemma A1 of the Appendix we show that h is continuous, and that its two partial derivatives, h_1 and h_2 , are nonnegative because of NIARA.

Now, (4.7) and (4.8) hold because, by assumption, $q_i > 0$. Equation (4.8)

can be written

$$\begin{aligned}
 (5.1) \quad & [w_i - C'(q_i)]u'(w_i - p_i) + u(\theta_i - p_i) - u(w_i - p_i) \\
 &= \sum_{j>i} \lambda_{ij} [u'(\theta_i - p_i) - u'(\theta_j - p_i)] h(\theta_i - p_i, \theta_j - p_i) \\
 &> h(\theta_i - p_i, \theta_{i+1} - p_i) \sum_{j>i} \lambda_{ij} [u'(\theta_i - p_i) - u'(\theta_j - p_i)],
 \end{aligned}$$

where the last inequality follows from replacing θ_j in $h(\theta_i - p_i, \theta_j - p_i)$ by θ_{i+1} and using $h_2 \geq 0$. Equation (4.7) can be written as

$$(5.2) \quad \sum_{j>i} \lambda_{ij} [u'(\theta_i - p_i) - u'(\theta_j - p_i)] = u'(w_i - p_i) - u'(\theta_i - p_i).$$

Substituting from (5.2) into (5.1), we obtain

$$\begin{aligned}
 & [w_i - C'(q_i)]u'(w_i - p_i) \\
 &> [u'(w_i - p_i) - u'(\theta_i - p_i)] [h(\theta_i - p_i, \theta_{i+1} - p_i) - h(\theta_i - p_i, w_i - p_i)].
 \end{aligned}$$

Rearranging this inequality now yields

$$(5.3) \quad C'(q_i) \leq H(\theta_{i+1}, \theta_i, p_i, w_i - p_i),$$

where H is defined by

$$(5.4) \quad H(\theta^+, \theta, p, z) \equiv p + z - \left[\frac{u'(z) - u'(\theta - p)}{u'(z)} \right] [h(\theta - p, \theta^+ - p) - h(\theta - p, z)].$$

We conclude these manipulations by considering the particular case where $q_{i+1} > q_i$; this case will arise in the course of proving both parts (i) and (ii) of the theorem. Our immediate goal is to demonstrate that inequality (5.6) below holds when $q_{i+1} > q_i$. There are two steps.

First, if $q_{i+1} > q_i > 0$, (4.7) and (4.8) both hold with i replaced by $i+1$. Then by the same argument which derived (5.3), we have

$$(5.5) \quad C'(q_{i+1}) \leq H(\theta_{i+2}, \theta_{i+1}, p_{i+1}, w_{i+1}^{-p_{i+1}}).$$

Second, if $q_{i+1} > q_i$, there will be an equality in (5.3). To prove this, notice that from (5.1) it is enough to show that $\lambda_{ij} = \lambda_{ij} u'(w_i^{-p_i}) = 0$ for all $j > i+1$. Suppose to the contrary that $\lambda_{ij} > 0$ for some $j > i+1$. Then by complementary slackness and DIC, $U(\mathbf{x}_i, \theta_j) = U(\mathbf{x}_j, \theta_j) > U(\mathbf{x}_{i+1}, \theta_j)$. But by Theorem 2(ii) and (iii) respectively, $U(\mathbf{x}_i, \theta_{i+1}) = U(\mathbf{x}_{i+1}, \theta_{i+1})$ and, since $\mathbf{x}_i \neq \mathbf{x}_{i+1}$, $U(\mathbf{x}_i, \theta_i) > U(\mathbf{x}_{i+1}, \theta_i)$. Therefore, by applying Lemma 1 to $(\mathbf{x}, \mathbf{x}) = (\mathbf{x}_i, \mathbf{x}_{i+1})$ and $(\theta^-, \theta^0, \theta^+) = (\theta_i, \theta_{i+1}, \theta_j)$, it follows that $q_i > q_{i+1}$, contrary to assumption that $q_{i+1} > q_i$.

Combining (5.3) as an equality with inequality (5.5), and using the convexity of $C(\cdot)$, we obtain that for $q_i < q_{i+1}$,

$$(5.6) \quad 0 \leq H(\theta_{i+2}, \theta_{i+1}, p_{i+1}, w_{i+1}^{-p_{i+1}}) - H(\theta_{i+1}, \theta_i, p_i, w_i^{-p_i}).$$

Inequality (5.6) is the basis for proving parts (i) and (ii) of the theorem.

First we prove part (i). Assume the contrary, that $p_i > p_{i+1}$ for some i , where $q_i > 0$. From Theorem 2, $U(\mathbf{x}_i, \theta_i) > U(\mathbf{x}_{i+1}, \theta_i)$ and $U(\mathbf{x}_{i+1}, \theta_{i+1}) = U(\mathbf{x}_i, \theta_{i+1})$. Adding these yields

$$q_i [u(\theta_{i+1}^{-p_i}) - u(\theta_i^{-p_i})] < q_{i+1} [u(\theta_{i+1}^{-p_{i+1}}) - u(\theta_i^{-p_{i+1}})].$$

This implies, since $u'' < 0$ and $p_i > p_{i+1}$, that $q_i < q_{i+1}$. Therefore, since \mathbf{x}_{i+1} has a lower price and a higher quality than \mathbf{x}_i , the fact that, by IC, type θ_i does not prefer \mathbf{x}_{i+1} to \mathbf{x}_i implies that $w_i^{-p_i} > w_{i+1}^{-p_{i+1}}$. Letting $z_i = w_i^{-p_i}$ and $z_{i+1} = w_{i+1}^{-p_{i+1}}$, (5.6) can be written as

$$(5.7) \quad 0 < \int_{\theta_{i+1}}^{\theta_{i+2}} H_1(\theta^+, \theta_i, p_i, z_i) d\theta^+ + \int_{\theta_i}^{\theta_{i+1}} H_2(\theta_{i+2}, \theta, p_i, z_i) d\theta \\ - \int_{p_{i+1}}^{p_i} H_3(\theta_{i+2}, \theta_{i+1}, p, z_i) dp - \int_{z_{i+1}}^{z_i} H_4(\theta_{i+2}, \theta_{i+1}, p_{i+1}, z) dz.$$

Lemma A2(i) and A2(ii) in the Appendix directly imply, since $z_i \leq \theta_i^{-p_i}$, that the first two integrals are nonpositive. If $p \in [p_{i+1}, p_i]$, then $z_i \leq \theta_i^{-p_i}$ implies that $z_i \leq \theta_{i+1}^{-p}$. Therefore, by Lemma A2(iii), the third integral is positive. Lastly, $z \in [z_{i+1}, z_i]$ implies $z \leq \theta_{i+1}^{-p_{i+1}}$, so the fourth integral is positive by Lemma A2(iv). Hence the RHS of (5.7) is negative. This contradiction proves that $p_i \leq p_{i+1}$.

Finally we prove part (ii) of the theorem. In particular, we show that $\rho'' \leq 0$ implies $w_i \leq w_{i+1}$. Assume to the contrary that $w_i > w_{i+1}$. Then, since $p_i \leq p_{i+1}$, it must be that $q_i < q_{i+1}$; for otherwise contract \mathbf{x}_{i+1} would have a lower warranty than \mathbf{x}_i without having the compensation of either a lower price or a higher quality, and so type θ_{i+1} would prefer \mathbf{x}_i to \mathbf{x}_{i+1} , contrary DIC. Now (5.6) can be written

$$(5.8) \quad 0 < \int_{\theta_i}^{\theta_{i+1}} H_2(\theta_{i+1}, \theta, p_i, w_i - p_i) d\theta - \int_{w_{i+1}}^{w_i} H_4(\theta_{i+1}, \theta_{i+1}, p_i, w - p_i) dw \\ + \int_{p_i}^{p_{i+1}} (H_3 - H_4)(\theta_{i+1}, \theta_{i+1}, p, w_{i+1} - p) dp - \int_{\theta_{i+1}}^{\theta_{i+2}} H_1(\theta^+, \theta_{i+1}, p_{i+1}, w_{i+1} - p_{i+1}) d\theta^+.$$

Since $w_i - p_i < \theta_i - p_i$ and $w_{i+1} - p_{i+1} < \theta_{i+1} - p_{i+1}$, the first and last integrals are nonpositive by Lemma A2(i) and A2(ii) in the Appendix. The third integral is nonpositive by Lemma A3. Lastly, since $w - p_i < \theta_{i+1} - p_i$ follows from $w < w_i \leq \theta_i$, Lemma A2(iv) implies the second integral is positive. Hence the RHS of (5.8) is negative. This contradiction proves that $w_i < w_{i+1}$. Q.E.D.

Theorem 3 establishes preference assumptions under which p , w and q are nondecreasing in θ . Part (i) states that without any further preference assumptions, p is nondecreasing in θ , i.e., higher type consumers purchase more expensive quality-warranty bundles. A monopoly would obviously like to charge those consumers more who are willing to pay more; (i) shows that this intuition is not overturned by having to include incentive constraints.

Part (ii) of the theorem states that if the risk tolerance function of consumers is concave, then higher types receive greater warranties. The intuition for this is relatively obscure. Roughly, it seems that if risk tolerance is increasing at a diminishing rate, then higher types are not so tolerant of risk that they can be compensated for paying a higher price merely by giving them increased quality; their reward for telling the truth must take the form of greater warranty coverage, even if it also takes the form of higher quality (see next paragraph). Most commonly used utility functions have concave risk tolerance.²⁶ Also, concave risk tolerance implies

nondecreasing relative risk aversion, a property commonly thought to hold.^{27,28} So concave risk tolerance does not seem to be a bad assumption.

Part (iii) of the theorem states that if consumers' preferences exhibit constant risk tolerance (equivalent to CARA), then higher types will receive higher quality as well as higher warranties and prices. It is surprising that an assumption as strong as CARA is required to show that consumers who value quality more will receive higher quality -- an intuitively natural result. The following example indicates that quality may not increase in type even if preferences are completely standard.

EXAMPLE 1: The utility function is $u(y) = \log(.25 + y)$. The types are $\theta_1 = .6$, $\theta_2 = .8$, and $\theta_3 = 1.0$. The distribution is given by $f_1 = .26$, $f_2 = .14$, and $f_3 = .60$. The cost function is $C(q) \equiv 0$. The monopoly allocation, calculated numerically, is $(p_1, q_1, w_1) = (.4435, .7070, .2709)$, $(p_2, q_2, w_2) = (.4838, .6706, .3455)$, and $(p_3, q_3, w_3) = (.8437, 1.0000, --)$. Note that $q_1 > q_2$ and $q_2 < q_3$.²⁹

6. FINAL REMARKS: MONOTONICITY AND THE LOCAL APPROACH

Example 1 is of separate methodological interest. Only the adjacent downward incentive constraints are binding: $U(\mathbf{x}_3, \theta_3) = -.9006$ exceeds $U(\mathbf{x}_1, \theta_3) = -.9019$. Thus, it is not true that some nonadjacent constraints must bind if the optimal quality allocation is not monotonic in type. However, the converse is true: nonadjacent constraints do not bind when the optimal quality allocation is monotonic.

PROPOSITION 5: Suppose quality in a monopoly allocation is nondecreasing in type. If $j < k < i$ and $\mathbf{x}_j \neq \mathbf{x}_k$, then type θ_i strictly prefers \mathbf{x}_i to \mathbf{x}_j and

type θ_j strictly prefers \mathbf{x}_j to \mathbf{x}_i .

PROOF: Type θ_j cannot be indifferent between \mathbf{x}_j and \mathbf{x}_i , for otherwise Theorem 2(iii) would imply $\mathbf{x}_k = \mathbf{x}_j$. Now suppose type θ_i is indifferent between \mathbf{x}_i and \mathbf{x}_j . Then by DIC, $U(\mathbf{x}_j, \theta_i) = U(\mathbf{x}_i, \theta_i) \geq U(\mathbf{x}_k, \theta_i)$. Also by DIC, $U(\mathbf{x}_j, \theta_k) \leq U(\mathbf{x}_k, \theta_k)$. By Theorem 2(iii), since $\mathbf{x}_j \neq \mathbf{x}_k$, $U(\mathbf{x}_j, \theta_j) > U(\mathbf{x}_k, \theta_j)$. Therefore, by applying Lemma 1 to $(\mathbf{x}, \hat{\mathbf{x}}) = (\mathbf{x}_j, \mathbf{x}_k)$ and $(\theta^-, \theta^0, \theta^+) = (\theta_j, \theta_k, \theta_i)$, it follows that $q_j > q_k$. This contradicts the assumption that quality is nondecreasing in type. Q.E.D.

Proposition 5 suggests that it is the possibility of quality decreasing in type that forces us to consider nonadjacent incentive constraints. This accords with the discussion in Section 2. Recall properties MRSO and AO, and that U satisfies MRSO if we let the "attributes" vector \mathbf{a} be (p, q) , and the "outlay" \mathbf{b} be $-w$. If we were to have known that both p_i and q_i would be nondecreasing in i , then AO would also have held and the nonadjacent constraints could have safely been neglected. But in our model, q_i need not be nondecreasing in i .

Under what circumstances might q_i be decreasing in i ? As the example indicates, this happens when there are few intermediate types relative to both the number of high types and the number of low types. The intuition is as follows. Because there are many low types, the tendency to extract profit from them by selling them high quality is strong compared with the opposing need to make their contract unattractive to higher types. Next, consider the intermediate and high types as a subset. For incentive reasons, it is best to sell the (few) intermediate types low quality, incurring only a small sacrifice of profit from them, so as to extract high profit from the (many)

high types. It seems, then, that quality decreases in type only if the probability function decreases rapidly in an intermediate region.

This is corroborated in a companion paper to this, Matthews and Moore (1986). There, we assume a continuous type distribution and require that its hazard rate function be nondecreasing. This regularity condition does not allow the probability function to decrease rapidly in intermediate regions. The local approach is then used to show that this condition insures that quality will not decrease in type.

Without such a regularity condition, the local approach cannot be used in this model. Example 1 demonstrated that some optimal allocations are not monotonic in type; consequently, the usual proof (Section 2) that the local approach works is invalid. This begs the question: does the local approach work nevertheless? The answer is no. We conclude the paper with a counterexample. Alter the distribution in Example 1 to $f_1 = .32$, $f_2 = .16$, and $f_3 = .52$. Then, solving the relaxed monopoly problem in which only the adjacent incentive constraints (both upward and downward) are imposed yields $(p_1, q_1, w_1) = (.5070, .8554, .2955)$, $(p_2, q_2, w_2) = (.5314, .8187, .3624)$, and $(p_3, q_3, w_3) = (.7663, 1.0000, ----)$. This allocation does not solve the unrelaxed monopoly problem, since it is not incentive compatible: $U(\mathbf{x}_1, \theta_3) = -.7250$ exceeds $U(\mathbf{x}_3, \theta_3) = -.7262$. The local approach therefore does not work.

APPENDIX A

LEMMA A1: The function defined by

$$h(s,t) = \frac{u(t) - u(s)}{u'(s) - u'(t)}$$

if $s \neq t$, and by $h(s,s) = \rho(s) [= 1/R(s)]$, is continuous. Moreover,

$h_1(s,t) = h_2(t,s) \geq 0$ for $s \neq t$, and if $h=\rho$ if ρ is constant.

PROOF: By L'Hopital's rule,

$$\lim_{t \rightarrow s} h(s,t) = \lim_{t \rightarrow s} \frac{u'(t)}{-u''(t)} = \rho(s).$$

Hence h is continuous. The symmetry of h implies $h_1(s,t) = h_2(t,s)$. For $s \neq t$, differentiation of

$$h(s,t) = \frac{\int_s^t u'(y)dy}{\int_s^t R(y)u'(y)dy}$$

with respect to t yields

$$h_2(s,t)[u'(s)-u'(t)]^2 = u'(t) \int_s^t [R(y) - R(t)]u'(y)dy,$$

which is nonnegative because $u' > 0$ and R is nonincreasing. This equation also shows that h is constant if $R' = 0$. Q.E.D.

LEMMA A2: At a point (θ^+, θ, p, z) satisfying $\theta < \theta^+$ and $z < \theta - p$, the derivatives of the function H defined in (5.4) have the following signs:

- (i) $H_1(\theta^+, \theta, p, z) \leq 0$;
- (ii) $H_2(\theta^+, \theta, p, z) \leq 0$;
- (iii) $H_3(\theta^+, \theta, p, z) > 0$; and
- (iv) $H_4(\theta^+, \theta, p, z) > 0$.

PROOF: (i) Differentiating H yields

$$H_1(\theta^+, \theta, p, z) = - \left[\frac{u'(z) - u'(\theta-p)}{u'(z)} \right] h_2(\theta-p, \theta^+-p).$$

Therefore, since $z \leq \theta-p$ and $h_2 \geq 0$, $H_1(\theta^+, \theta, p, z) \leq 0$.

(ii) Differentiating H yields

$$\begin{aligned} H_2(\theta^+, \theta, p, z) &= \left[\frac{u''(\theta-p)}{u'(z)} \right] [h(\theta-p, \theta^+-p) - h(\theta-p, z)] \\ &+ \left[\frac{u'(z) - u'(\theta-p)}{u'(z)} \right] h_1(\theta-p, z) + \left[\frac{u'(\theta-p) - u'(z)}{u'(z)} \right] h_1(\theta-p, \theta^+-p). \end{aligned}$$

The third term is nonpositive because $h_1 \geq 0$ and $z \leq \theta-p$. By straightforward differentiation of $h(\theta-p, z)$ with respect to $\theta-p$, the sum of the first two terms can be shown to equal

$$\left[\frac{u''(\theta-p)}{u'(z)} \right] [h(\theta-p, \theta^+-p) - h(\theta-p, z)] - \left[\frac{u''(\theta-p)}{u'(z)} \right] [h(\theta-p, \theta-p) - h(\theta-p, z)].$$

This expression is nonpositive because $h_2 \geq 0$ and $\theta \leq \theta^+$. Hence (ii) holds.

(iii) Differentiating H yields

$$H_3(\theta^+, \theta, p, z) = 1 - H_1(\theta^+, \theta, p, z) - H_2(\theta^+, \theta, p, z).$$

Hence (iii) follows from (i) and (ii).

(iv) Differentiating H yields

$$\begin{aligned} H_4(\theta^+, \theta, p, z) &= \left[\frac{u'(z) - u'(\theta-p)}{u'(z)} \right] h_2(\theta-p, z) \\ &+ \left[\frac{-u''(z)u'(\theta-p)}{u'(z)^2} \right] [h(\theta-p, \theta^+-p) - h(\theta-p, z)] + 1. \end{aligned}$$

Because $h_2 \geq 0$ and $z \leq \theta-p \leq \theta^+-p$, the first two terms are nonnegative. Hence (iv) holds. Q.E.D.

LEMMA A3: If the risk tolerance function $\rho = 1/R$ is concave, then

$$H_3(\theta, \theta, p, w-p) \leq H_4(\theta, \theta, p, w-p).$$

PROOF: Let $z = w-p$. Note that $\rho(y) = h(y, y)$ and $\rho'(y) = 2h_1(y, y)$. Hence, by differentiating H , and also differentiating h to derive an expression for h_1 , we obtain after some manipulation,

$$\begin{aligned} (H_3 - H_4)(\theta, \theta, p, z) &= \left[\frac{u'(z) - u'(\theta-p)}{u'(z)} \right] \rho'(\theta-p) - \left[\frac{h(\theta-p, z) - \rho(\theta-p)}{\rho(z)} \right] \\ &\quad + \frac{\rho(z) - \rho(\theta-p)}{\rho(z)} \\ &= \frac{1}{u'(z)\rho(z)} \left\{ [u'(z) - u'(\theta-p)]\rho(z)\rho'(\theta-p) \right. \\ &\quad \left. - [u(\theta-p) - u(z)] - u'(\theta-p)\rho(\theta-p) + u'(z)\rho(z) \right\} \end{aligned}$$

The term in curly brackets is equal to

$$\int_z^{\theta-p} [-u''(y)\rho(z)\rho'(\theta-p) - u'(y) - u''(y)\rho(y) - u'(y)\rho'(y)] dy,$$

which in turn is equal to

$$\int_z^{\theta-p} [\rho(z)\rho'(\theta-p) - \rho(y)\rho'(y)] [-u''(y)] dy.$$

Because $\rho' \geq 0$ and $\rho'' \leq 0$, the integrand in this expression is nonpositive.

Q.E.D.

Footnotes

- 1 This paper has benefited from the comments of Roger Guesnerie, Tom Holmes, Bill Rogerson, John Weymark and two anonymous referees, as well as from seminar participants at the 1984 Summer Econometric Society Meetings, the FTC, Caltech, Berkeley, Stanford, and Paris. We owe a special debt to James Mirrlees for many insightful comments. We thank Brian Pinto and Arthur Kennickell for computer assistance. We are also grateful for the hospitality and congeniality of the Department of Economics and CARESS at the University of Pennsylvania, and support from NSF Grant SES 8410157 and the Suntory-Toyota International Centre for Economics and Related Disciplines at the LSE.
- 2 Such as Goldman, Leland and Sibley (1984), Harris and Raviv (1981), Maskin and Riley (1984b), Mirman and Sibley (1980), Roberts (1979), Spence (1980), and Stiglitz (1977).
- 3 Such as Guesnerie and Seade (1982), Mirrlees (1985), and Weymark (1986).
- 4 Such as Adams and Yellin (1976), Chiang and Spatt (1982), and Palfrey (1983).
- 5 Such as Maskin and Riley (1984b) and Mussa and Rosen (1978).
- 6 Such as Maskin and Riley (1984a), Matthews (1983), Moore (1984), and Myerson (1981).
- 7 Such as Hart (1983).
- 8 Such as Baron and Myerson (1982).
- 9 Our analysis would be the same if the benefit obtained from a contract depends upon the type of consumer who chooses it, so that $\pi(\mathbf{x}_i, \theta_i)$ replaces $\pi(\mathbf{x}_i)$. For example, a contract might provide insurance against an accident whose probability depends upon the risk class θ of the consumer who chooses it, as in Stiglitz (1977).
- 10 The alternative case is that $j < i-1$, which is handled by basically the same argument.
- 11 The property described in Lemma 0 is weaker than A0, and it is vacuously satisfied if $k=2$. Lemma 0 therefore formally proves what was stated above: MRSO alone implies that SCP holds for all contract sets if $k=2$.

- 12 We assume a solution $b(\mathbf{a})$ exists to (2.1) for each \mathbf{a} between \mathbf{a}_i and \mathbf{a}_j . A variety of assumptions that are innocuous in specific contexts will imply this.
- 13 Roberts (1979), treating the multiproduct nonuniform pricing problem using income level as the type parameter, does not assume A0. He instead claims that A0 must hold if all goods are normal. As this is incorrect, his characterizations of optimal contracts using the local approach are necessarily valid only if A0 is assumed.
- 14 Rather than A0, the weaker property stated in Lemma 0 could be assumed in such models. But this would be to no benefit, since that property, in conjunction with MRSO and AIC, can be shown to imply A0 anyway.
- 15 Similar regularity conditions have been used when $k=2$ (see Baron and Myerson (1982), Maskin and Riley (1984b), Mussa and Rosen (1978), Myerson (1981) or Spence (1980)). They are used when only the downward adjacent incentive constraints DAIC (or, in a continuous types model, only the consumers' first order conditions) are imposed. Such a doubly-relaxed problem, (M') say, is typically straightforward to solve. The regularity condition is needed to insure that solutions to (M') satisfy the neglected upward adjacent incentive constraints UAIC (or, in a continuous model, the consumers' second order conditions). But, as stated above, there is no need for any regularity condition when $k=2$ if all of AIC is imposed.
Alternatively, recalling that A0 is a necessary condition when $k=2$, it is valid to impose A0 as an explicit constraint together with DAIC, in which case AIC will be satisfied if, as is usual, the DAIC bind (recall Lemma 0). This technique also does not need a regularity condition. See, for example, the discussion of the discrete $k=2$ case in Spence (1980), or the continuous $k=2$ case in Maskin and Riley (1984b) and Mussa and Rosen (1978).
- 16 Quality is a probability of functioning in Braverman, Guasch and Salop (1983), Corville and Hausman (1979), Grossman (1981), Palfrey and Romer (1983), Schwartz and Wilde (1982), and Spence (1977).
- 17 Warranties are monetary compensations in Corville and Hausman (1979), Grossman (1981), Heal (1977), and Spence (1977).
- 18 Warranties act as signals in Corville and Hausman (1979), Grossman (1981), and Spence (1977).
- 19 This moral hazard problem is discussed in Priest (1981).

- 20 Seller-buyer disputes are studied in Palfrey and Romer (1983).
- 21 To prove this, define $v(\cdot)$ by $v(u) \equiv u'[u^{-1}(u)]$. Then $v'(u) = -R[u^{-1}(u)]$. So from NIARA (CARA), $v''(u) \geq (=) 0$.
- 22 The remainder of the proof is simple if NIARA is strengthened to decreasing absolute risk aversion (DARA). Since θ^* is a local maximizer of $\Delta(\cdot)$, the second order condition implies

$$\begin{aligned} 0 &\geq \Delta''(\theta^*) = qR(\theta^*-p)u'(\theta^*-p) - \hat{q}R(\theta^*-p)u'(\theta^*-p) \\ &= qu'(\theta^*-p)[R(\theta^*-p) - R(\theta^*-p)], \end{aligned}$$

where $R(\cdot) \equiv -u''(\cdot)/u'(\cdot)$, and the second equality follows from the first order condition $q/\hat{q} = u'(\theta^*-p)/u'(\theta^*-p)$. Hence, from DARA (but not NIARA), $p \leq \hat{p}$. But if $p = \hat{p}$, then it would follow from the first order condition that $q = \hat{q}$, and all types would rank \mathbf{x} and $\hat{\mathbf{x}}$ in the same way, contrary to the hypothesis. So $p < \hat{p}$, and the first order condition implies $q > \hat{q}$. The proof of (i) and (ii) is in the text.

- 23 Alternatively, $\tilde{\mathbf{x}} = (\tilde{p}, \tilde{q}, \tilde{w})$ is given by $\tilde{q} = (q_{i-1} + q_i)/2$; $\tilde{p} = p_{i-1}$ with probability $q_{i-1}/(q_{i-1} + q_i)$ and $\tilde{p} = p_i$ with probability $q_i/(q_{i-1} + q_i)$; and $\tilde{w} = w_{i-1}$ with probability $q_{i-1}/(q_{i-1} + q_i)$ and $\tilde{w} = w_i$ with probability $q_i/(q_{i-1} + q_i)$.
- 24 As $q^*(\cdot)$ may be multi-valued, $q_i < q^*(\theta_i)$ means that q_i is less than each element of $q^*(\theta_i)$.
- 25 If (a) the warranty is greater than the price, (b) the firm cannot restrict the quantity a consumer purchases, and (c) a consumer can (circumspectly) break a product without invalidating the warranty, then a consumer would buy and break an unlimited number of units. This moral hazard problem would force $w < p$ even in the competitive case. In the monopoly case this problem could be handled by imposing $w \leq p$ as a constraint, which would probably not change many results.
- 26 Most commonly used utility functions are in the HARA class, which is characterized by linear risk tolerance.

- 27 See Arrow (1970) for why relative risk aversion is generally thought to be nondecreasing.
- 28 Relative risk aversion is $r(y) = y/\rho(y)$. Hence $r' \geq 0$ if and only if $y\rho' \leq \rho$. But ρ concave implies that $y\rho'(y) \leq \rho(y) - \rho(0)$, which is less than $\rho(y)$ because $\rho(0) \geq 0$. Therefore $r' \geq 0$ if ρ is concave.
- 29 The cost function in this example violates our assumption that $C(1) > 1$. This is why q_3 is at its maximum possible value, $q_3 = 1$. We chose $C \equiv 0$ deliberately so that the example would also illustrate an optimal auction for one risk averse bidder in which the probability of winning actually decreases in the bidder's evaluation of the object being sold. See Maskin and Riley (1984a), Matthews (1983) and Moore (1984).

References

- Adams, W. and J. Yellin (1976), "Commodity Bundling and the Burden of Monopoly," Quarterly Journal of Economics, 90, 475-488.
- Arnott, R. and J. Stiglitz (1985), "Randomization with Asymmetric Information: A Simplified Exposition," Queens University DP No. 594.
- Arrow, K. (1970), Chapter 3 in Essays in the Theory of Risk Bearing, Chicago: Markham.
- Baron, D. and R. Myerson (1982), "Regulating a Monopolist With Unknown Costs," Econometrica, 50, 911-930.
- Braverman, A., J.L. Guasch, and S. Salop (1983), "Defects in Disneyland: Quality Control as a Two-Part Tariff," Review of Economic Studies, 50, 121-132.
- Chiang, R. and C.S. Spatt (1982), "Imperfect Price Discrimination and Welfare," Review of Economic Studies, 49, 155-182.
- Cooper, R. (1984), "On Allocative Distortions in Problems of Self-Selection," The Rand Journal of Economics, 15, 568-577.
- Corville, L. and W. Hausman (1979), "Warranty Scope and Reliability under Imperfect Information and Alternative Market Structures," Journal of Business, 92, 361-378.
- Ekelund, R.B. (1970), "Price Discrimination and Product Differentiation in Economic Theory: An Early Analysis," Quarterly Journal of Economics, 84, 268-278.
- Goldman, M., H. Leland, and D. Sibley (1984) "Optimal Nonuniform Prices," Review of Economic Studies, 51, 305-319.
- Grossman, S. (1981), "The Informational Role of Warranties and Private Disclosure about Product Quality," Journal of Law and Economics, 24, 461-484.

- Guesnerie, R. and J. Seade (1982), "Nonlinear Pricing in a Finite Economy," Journal of Public Economics, 17, 157-179.
- Harris, M. and A. Raviv (1981), "A Theory of Monopoly Pricing Schemes with Demand Uncertainty," American Economic Review, 71, 347-365.
- Hart, O. (1983), "Optimal Labour Contracts Under Asymmetric Information," Review of Economic Studies, 50, 3-36.
- Heal, G.K. (1977), "Guarantees and Risk Sharing," Review of Economic Studies, 44, 549-560.
- Maskin, E. and J. Riley (1984), "Optimal Auctions with Risk Averse Buyers," Econometrica, 52, 1473-1518.
- Maskin, E. and J. Riley (1984), "Monopoly Selling Strategies with Incomplete Information," The Rand Journal of Economics, 15, 171-196.
- Matthews, S.A. (1983), "Selling to Risk Averse Buyers with Unobservable Tastes," Journal of Economic Theory, 30, 370-400.
- Matthews, S.A. and J. Moore (1986), "The Local Approach to Multidimensional Screening Problems," in progress.
- Mirman, L. and D. Sibley (1980), "Optimal Nonlinear Prices for Multiproduct Monopolies," Bell Journal of Economics, 11, 659-670.
- Mirrlees, J.A. (1971), "An Exploration in the Theory of Optimum Income Taxes," Review of Economic Studies, 38, 175-208.
- Mirrlees, J.A. (1976), "Optimal Tax Theory: A Synthesis," Journal of Public Economics, 6, 327-358.
- Mirrlees, J.A. (1985), "Optimal Taxation," in the Handbook of Mathematical Economics, vol. 3, ed. by K. Arrow and M. Intriligator, Amsterdam: North-Holland.

- Moore, J. (1984), "Global Incentive Constraints in Auction Design," Econometrica, 52, 1523-1537.
- Mussa, M. and S. Rosen (1978), "Monopoly and Product Quality," Journal of Economic Theory, 18, 301-317.
- Myerson, R. (1981), "Optimal Auction Design," Mathematics of Operations Research, 6, 58-73.
- Palfrey, T.R. (1983), "Bundling Decisions by a Multiproduct Monopoly with Incomplete Information," Econometrica, 51, 463-484.
- Palfrey, T. and T. Romer (1983), "Warranties, Performance, and the Resolution of Buyer-Seller Disputes," Bell Journal of Economics, 14, 97-117.
- Priest, G.L. (1981), "A Theory of the Consumer Product Warranty," The Yale Law Journal, 90, 1297-1352.
- Roberts, K.W.S. (1979), "Welfare Considerations of Nonlinear Pricing," The Economic Journal, 89, 66-83.
- Schwartz, A. and L. Wilde (1982), "Consumer Markets for Warranties," Caltech Social Science WP 445.
- Spence, A.M. (1977), "Consumer Misperceptions, Product Failure, and Product Liability," Review of Economic Studies, 44, 561-572.
- Spence, A.M. (1980) "Multi-Product Quantity-Dependent Prices and Profitability Constraints" (1980), Review of Economic Studies, 47, 821-841.
- Stiglitz, J. (1977), "Monopoly, Nonlinear Pricing, and Imperfect Information: The Insurance Market," Review of Economic Studies, 44, 407-430.
- Weymark, J.A. (1986), "Comparative Statics Properties of Optimal Nonlinear Income Taxes," mimeo, British Columbia and Northwestern.

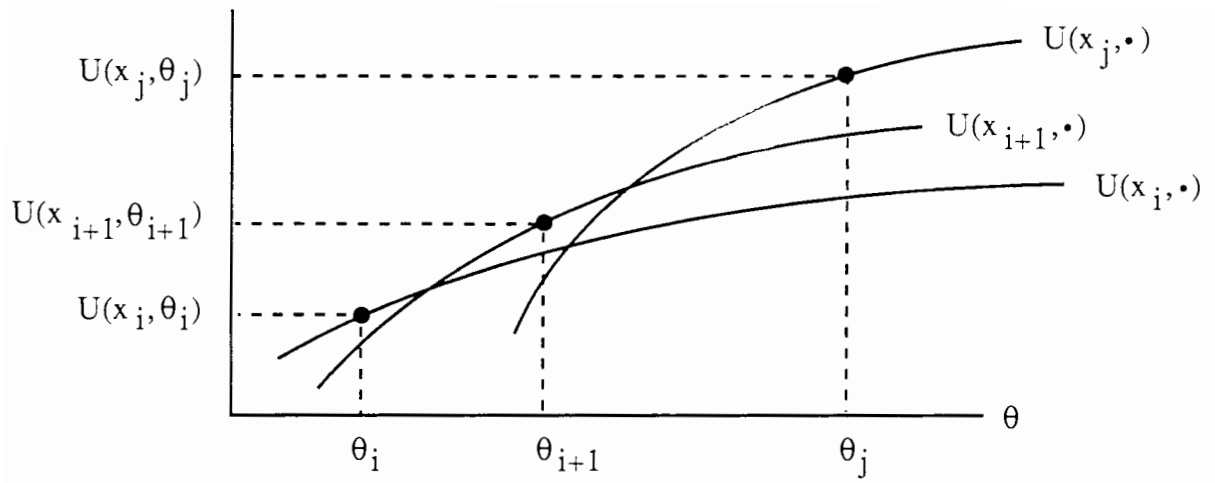

Figure 1

The Utility Curve Illustration of IC

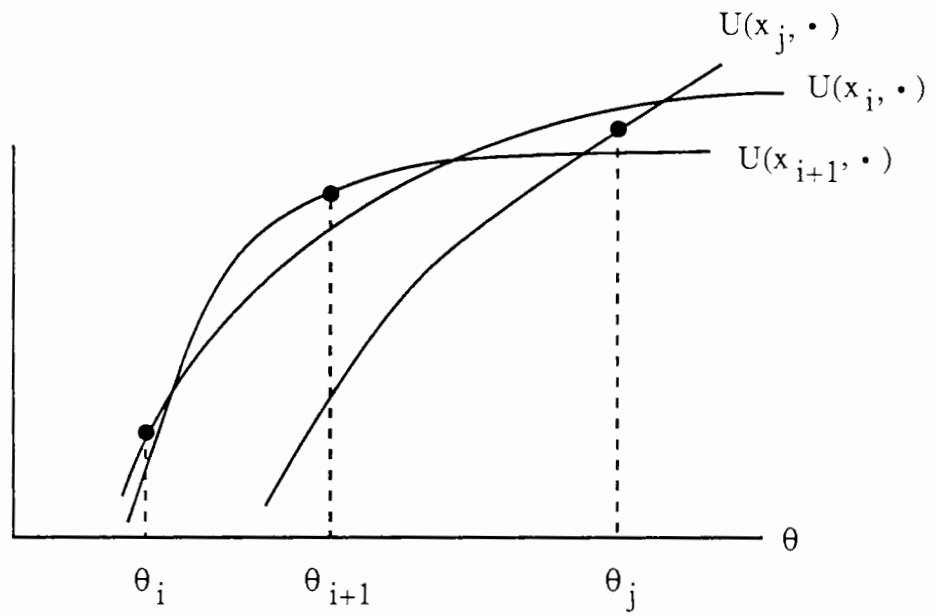

Figure 2

SCP Is Violated If AIC But Not IC Holds

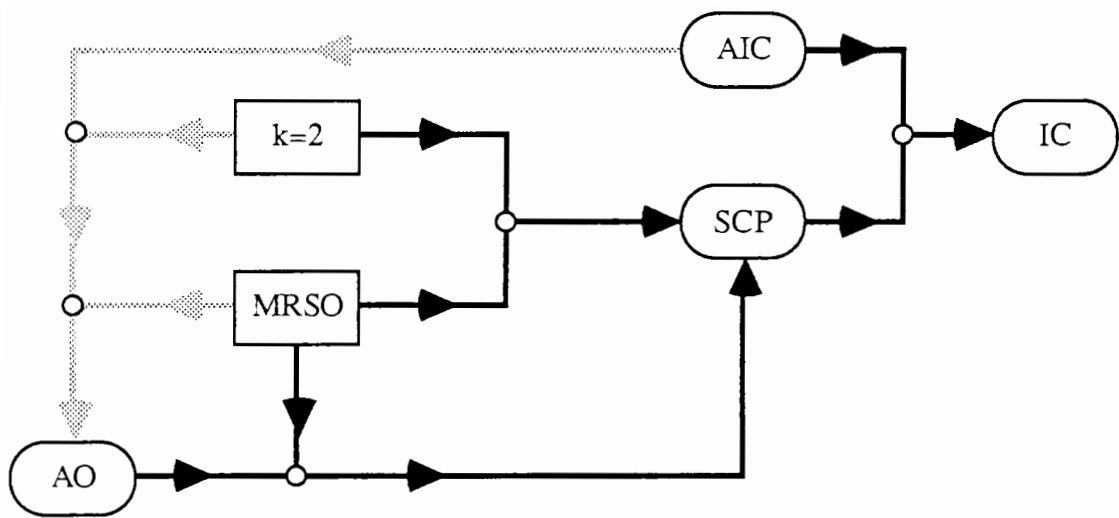

Figure 3

The Local Approach

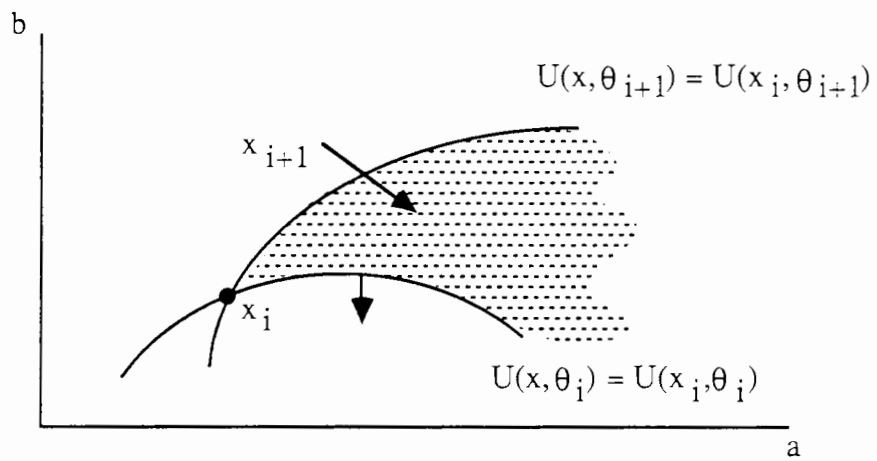

Figure 4

The Standard Revealed Preference Argument for AO

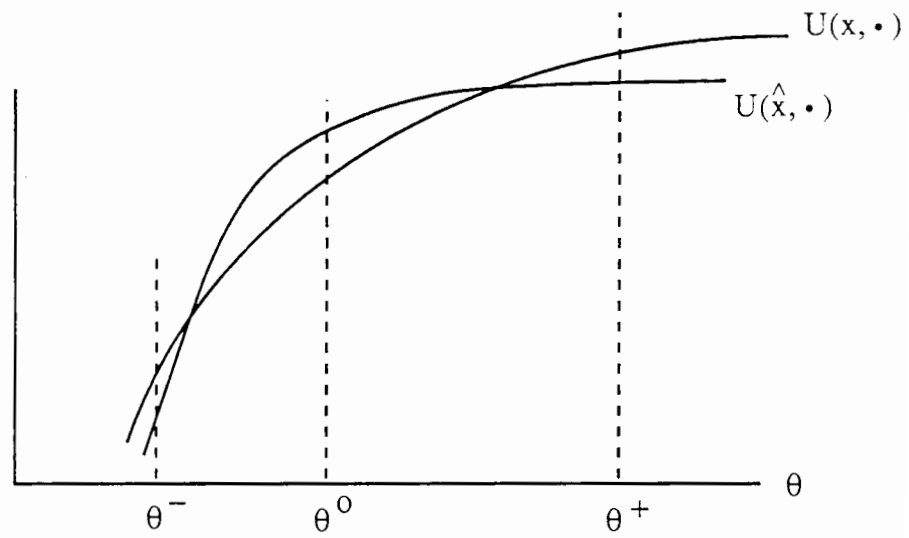

Figure 5

This Configuration Implies that $p < \hat{p}$ and $q > \hat{q} > 0$, and
that the Two Curves Cannot Cross Again

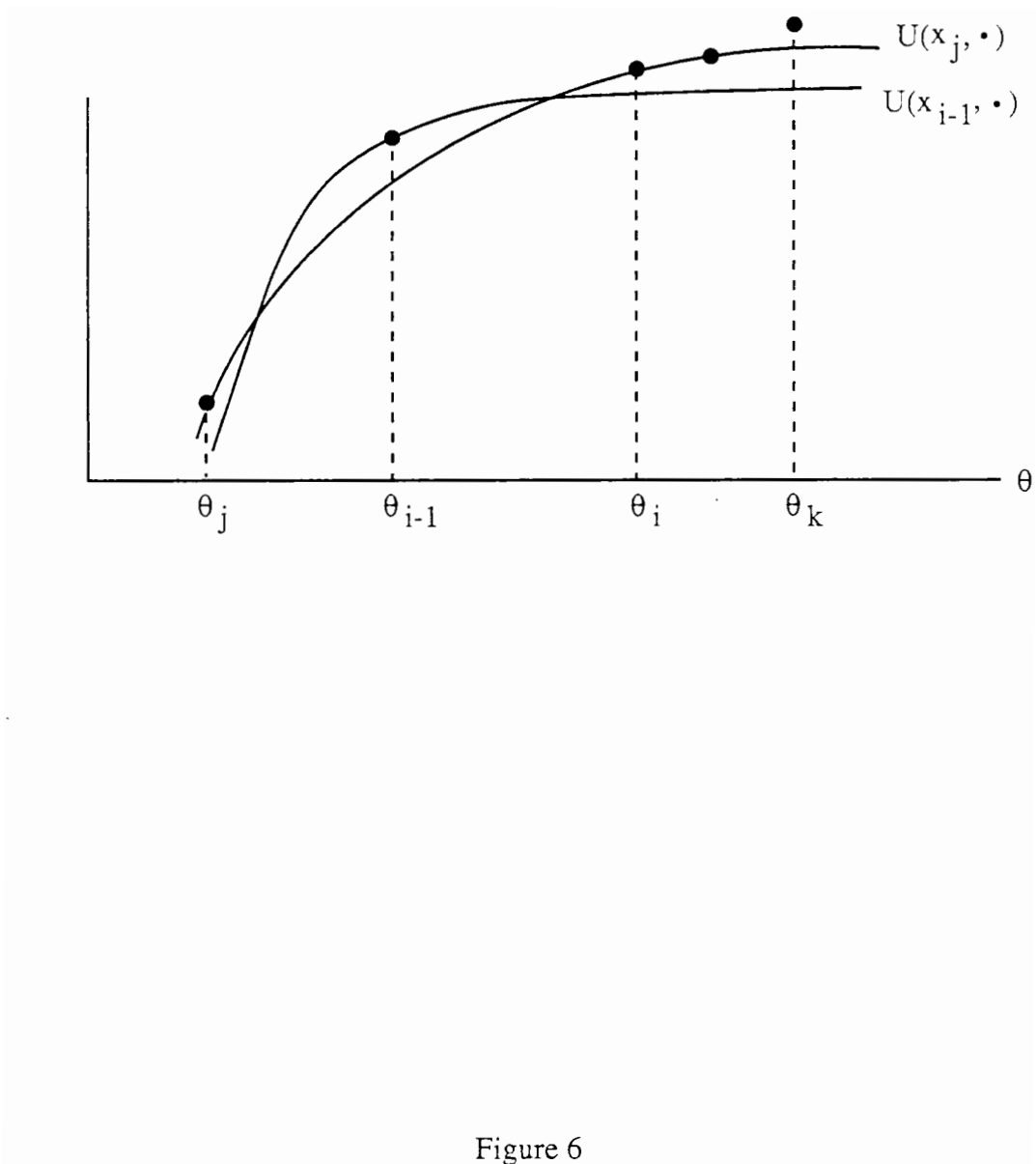

Figure 6

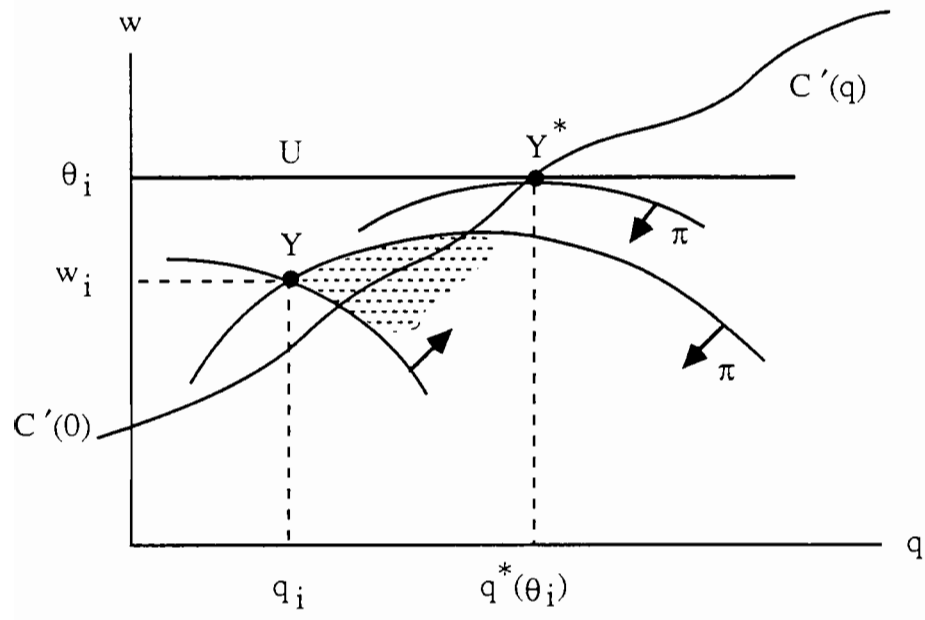

Figure 7