

ACCEPTED VERSION

I. Gunawan

Multistage interconnection networks reliability evaluation based on stratified sampling Monte Carlo method

International Journal of Modelling and Simulation, 2008; 28(2):209-214

*"This is an Accepted Manuscript of an article published by Taylor & Francis in **International Journal of Modelling and Simulation**, in 2008 available online:*

<http://dx.doi.org/10.1080/02286203.2008.11442470>

PERMISSIONS

<http://authorservices.taylorandfrancis.com/sharing-your-work/>

Accepted Manuscript (AM)

As a Taylor & Francis author, you can post your Accepted Manuscript (AM) on your departmental or personal website at any point after publication of your article (this includes posting to Facebook, Google groups, and LinkedIn, and linking from Twitter).

To encourage citation of your work we recommend that you insert a link from your posted AM to the published article on [Taylor & Francis Online](#) with the following text:

"This is an Accepted Manuscript of an article published by Taylor & Francis in [JOURNAL TITLE] on [date of publication], available online: [http://www.tandfonline.com/\[Article DOI\]](http://www.tandfonline.com/[Article DOI])."

N.B. Using a real DOI will form a link to the Version of Record on [Taylor & Francis Online](#).

The AM is defined by the [National Information Standards Organization](#) as:

"The version of a journal article that has been accepted for publication in a journal."

This means the version that has been through peer review and been accepted by a journal editor. When you receive the acceptance email from the Editorial Office we recommend that you retain this article for future posting.

Embargoes apply if you are posting the AM to an institutional or subject repository, or to academic social networks such as Mendeley, ResearchGate, or Academia.edu.

<http://authorservices.taylorandfrancis.com/journal-list/>

International Journal of Modelling and Simulation 12mth Embargo

13 March, 2016

**MULTISTAGE INTERCONNECTION NETWORKS RELIABILITY EVALUATION
BASED ON STRATIFIED SAMPLING MONTE CARLO METHOD**

Indra Gunawan

Department of Mechanical and Manufacturing Engineering

Auckland University of Technology

Auckland, New Zealand

Email: indra.gunawan@aut.ac.nz

Abstract

Multistage Interconnection Networks (MINs) have been widely adopted in communication networks especially in telecommunication and multiprocessors environments. This paper aims to evaluate the reliability performance of Shuffle Exchange Network with an Additional Stage (SEN+), based on Monte Carlo method using computerized simulation. The evaluation is further improvised by deploying stratified sampling into the Monte Carlo method. SEN+ described in this paper is confined to multiprocessor environment based on identical switching elements used in interconnecting multiple processors. It is shown that Monte Carlo method is capable of providing reliability evaluation for SEN+ system.

Keywords: Monte Carlo Method, Multistage Interconnection Networks, Network Reliability, Shuffle Exchange Network, Simulation.

1. Introduction

In general, Multistage Interconnection Networks (MINs) consist of layers of switching elements (SEs) connected in a predefined topology to provide interconnection between multiple processors and

memory modules. It falls within the category of indirect network as it relies on intermediate elements to provide the interconnection between the input and output elements. Currently there exist quite a number of MIN topologies such as extra cube network, gamma network [1], multi-layer MIN [2], tandem-banyan network [3, 4]. The interconnection pattern, types of switching element and the number of stages in the network design differentiate each MIN topology. The most typical type of MIN is the generalized multistage cube network as shown in Fig. 1. The rectangles represent 2x2 SEs with eight inputs and outputs on the left and right sides of interconnection network system respectively.

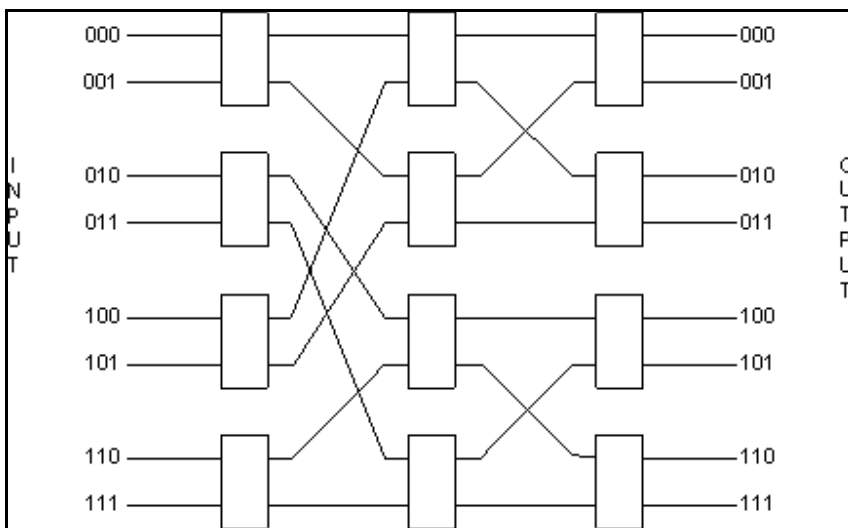

Figure 1. 8x8 Generalized Multistage Cube Network

MIN has been widely used in both circuit and packet switching networks. Examples of systems that implement MIN are Ultracomputer [5], NEC Cenju-3 [6] and Cenju-4 [7], IBM RP3, ATM switch [3, 8] and optical network [9]. The extensive usage of MIN prompts for an efficient yet accurate method to evaluate the reliability of MIN. This paper presents a method to evaluate the reliability of MIN based on Monte Carlo method with stratified sampling. The type of MIN evaluated in this paper is known as the Shuffle Exchange Network with an Additional Stage (SEN+). SEN+ is a hybrid of generic Shuffle

Exchange Network (SEN) with higher failure tolerance compared to SEN due to an additional stage of SE [10]. Fig. 2 shows the layout of an 8x8 SEN+ topology. A switching element (SE) is said to be working when it could perform all the four connection patterns shown in Fig. 3.

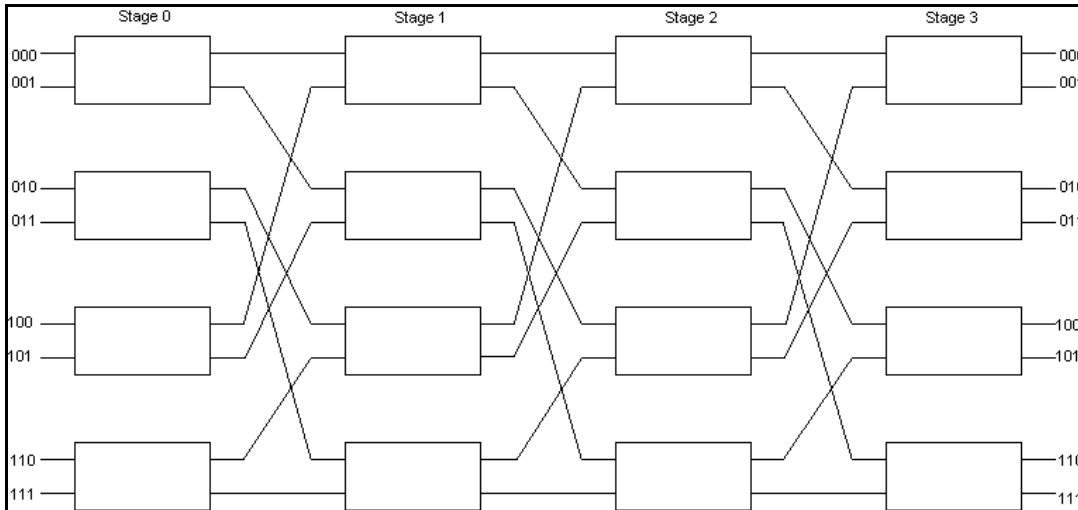

Figure 2. 8x8 SEN+ Topology Layout

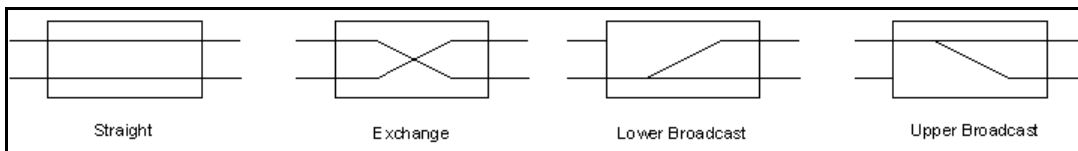

Figure 3. Four Possible States of a 2x2 Switching Element (SE)

Section 2 describes reliability evaluation of SEN+ system that includes three reliability parameters: terminal, broadcast, and network reliability. Monte Carlo method is introduced in section 3 as an alternative to compute the reliability of MINs in general. Numerical results are provided in section 4 to prove that Monte Carlo method is capable of providing reliability evaluation of SEN+ system. Conclusion based on the reliability measurement and confidence interval is presented in section 5.

2. Reliability Evaluation

Reliability of MIN is defined as the probability that the MIN could provide the required interconnection between a set of processors and a set of memory modules for a specified period of time under a given set of operating conditions. It is crucial to ascertain the reliability of a MIN as disruption of its connectivity can be devastating, especially in safety critical systems which may impact the safety of human beings.

The reliability evaluation of SEN+ can be divided into three types of reliability; terminal, broadcast and network. Terminal reliability represents the probability of existence of at least one fault free path between a designated pair of processor and memory. It is usually used to gauge the robustness of MIN. Broadcast reliability is defined as the probability that a single processor is able to broadcast data or connected to all the memory modules. Lastly, network reliability is defined as the probability that all processors are connected to all memory modules. It is commonly addressed as the all-terminal reliability.

Let $r(t)$ represents the reliability of SE as a function of time, t which represents the time until the SE fails. The exact terminal reliability for SEN+ can be calculated by simplifying the two path connections between the source and destination terminals into two parallel series of SE connections [11, 12] as shown in Fig. 4. Then the equation to calculate terminal reliability can be derived as $R_{Tr}(t) = [r(t)]^2 [1 - (1 - r(t))^{\log_2 N - 1}]^2$ where N represents the number of inputs.

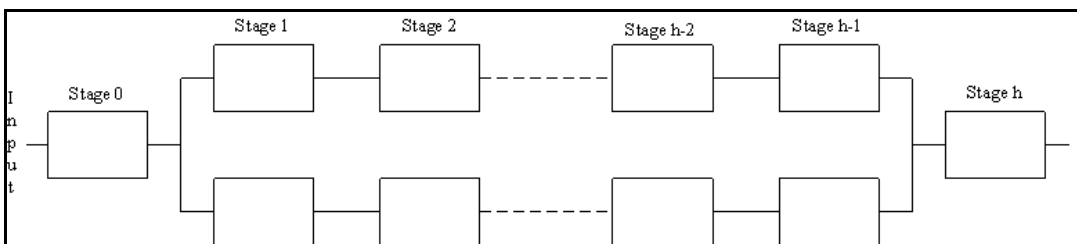

Figure 4. Simplified SEN+ Diagram to Calculate Terminal Reliability

A more general approach of computing terminal reliability for general type of network was derived by Chua and Kuo [13]. Their method can be applied to all types of MIN. Conventional method of calculating terminal reliability is by enumerating all the paths connecting the pair of source and destination terminals. Then a Boolean product of components for each path is derived and sum of all the products is calculated. Substituting the components' reliability value will results the terminal reliability of the network. The sum of products is also known as sum of disjoint product, F (disjoint). Instead of finding sum of disjoint product, Chua and Kuo's method utilized complement sum of disjoint product, $\sim F(\text{disjoint})$ to calculate terminal unreliability and then the network reliability is computed by $(1 - \text{terminal unreliability})$.

A recursive expression was derived by Cheng and Ibe to calculate the exact broadcast reliability of SEN+ [14]. The recursive expression consists of two parts, a terminating and a recursive expression that is called recursively to calculate broadcast reliability. Calculating exact broadcast reliability by enumerating all possible states of switching elements (SEs) can be expensive as the number of SEs increases as the network size gets larger. Gunawan introduced a simple mathematical expression to estimate the lower bound of broadcast reliability of an extra-stage cube network [12]. The derivation of the expression is based on reliability block diagram.

Exact network reliability can be calculated by evaluating all possible permutation of SE states [15] in the network. By summing the products of all possible permutation of SE states, the exact network reliability can be determined by substituting the working and failed SEs with the SE reliability. Reliability bound method (lower and upper bounds) is a better alternative to estimate MIN reliability with larger number of inputs. Reliability block diagram can be used to aid the derivation of bound equations of MIN reliability [12]. Gunawan showed that lower bound reliability of the network provides a close estimate of the exact network reliability for extra-stage cube network. Blake and Trivedi derived lower and upper bounds network reliability with slightly tighter bounds compared to

Gunawan's method [10]. For SE with higher reliability (>0.99000), a tighter bound expression than Blake and Trivedi's method was shown by Cheng and Ibe [14]. Srivaree-ratana and Smith applied artificial neural network to estimate all-terminal reliability based on the network link reliability [16] for general network system. The artificial neural network estimation can be applied to links with identical or differing reliabilities. Before artificial neural network can be applied to estimate network reliability, it needs to be trained and validated. They proved that the estimation is more precise compared to Konak and Smith's method [17, 18] with links of different reliabilities. However, the estimation may subject to bias and/or variance which depends on the training samples as noted by them.

Konak and Smith derived an improved upperbound method to estimate network reliability for varying link reliabilities [17, 18]. A polynomial time calculation was used to compute the bound value which makes it computationally feasible for large networks. They extended the work of Jan [19] to include unequal arc reliability and at the same time achieved tighter upper bound even if the reliability of the arcs is the same.

In the next sections, the Monte Carlo method is applied for reliability evaluation of large scale SEN+ systems.

3. Monte Carlo Method

Exact reliability of SEN+ can be determined by evaluating all possible SE states as being done by Fard and Gunawan [15]. However this method is complicated due to the huge possibilities of SE states as the number of inputs, N gets higher as shown in Table 1.

On the other hand, Monte Carlo method is capable of providing a point estimate of SEN+ reliability without requiring the evaluation every possible SE state by just performing random sampling on SE states as described in Algorithm 1. This paper presents a method based on the adaptation of Fishman's method [20]. Monte Carlo (MC) method enables estimation of SEN+ reliability via random sampling

of SE states; working (1) or fail (0). The following assumptions are defined to facilitate the evaluation of SEN+ reliability:

- i. A SE can only have two states; working (1) or fail (0).
- ii. All SE failures are statistically independent and random. A SE is assumed failed when it could not be in any of the four connection patterns; lower broadcast, upper broadcast, straight or exchange pattern (Figure 2).
- iii. A SE is assumed to be less reliable than the link and cannot be repaired.
- iv. All SEs have identical reliability.
- v. All SEs in the first and last stages are assumed to be working.

Table 1. Number of Possible SE States to be Evaluated for Each Type of Reliability.

N	Number of Possible SE States		
	Terminal Reliability	Broadcast Reliability	Network Reliability
8	16	64	256
16	64	16384	16777216
32	256	1.07E+09	1.84E+19
64	1024	4.61E+18	1.46E+48
128	4096	8.51E+37	3.9E+115

Algorithm 1: Monte Carlo Method (MC) for SEN+ Reliability Evaluation

Parameters:

1. Number of SEs in the intermediate stages, m
2. SE reliability, r(t)
3. Number of inputs, N
4. Number of replications, n
5. Number of SE in the first and last stages, f
6. Reliability of SEN+, R

Procedure:

1. SET accumulated reliability, $R_{ac} = 0$

SET number of working switches, $w = 1$

SET number of SE in intermediate stages, m

SET total number of samplings, $s = 0$

SET total connected network, $c = 0$

2. REPEAT

Note: Calculate the stratum sampling size for each stratum. Number of stratum depends on the number of working SEs in the intermediate stages.

SET number of sampling for stratum i ($i = w$),

Stratum sampling size, $\delta = n \cdot \binom{m}{w} \cdot r(t)^m \cdot [1 - r(t)]^{m-w}$

SET $s = s + \delta$

Note: Evaluate only when the number of working SEs in the intermediate stages is at least half of the total number of the SEs in the intermediate stages. The SEN+ fails when the number of working SEs in the intermediate stages is less than half of its total.

IF $w \geq m \times 0.5$ THEN

Note: The interconnection still functions even there is a single SE failure. Evaluation is skipped as the interconnection is functioning when there is only a single SE failure.

IF $w < m - 1$ THEN

Note: Generated SE states are dependent on the type of interconnection; terminal, broadcast or network.

Randomly generate SE states in intermediate stages in array state[m]

Note: Evaluation of SEN+ network is dependent on the type of interconnection; terminal, broadcast or network.

This is done by evaluating the array state[m].

IF the SEN+ network is connected THEN

$c = c + 1$

END IF

ELSE

$c = c + \delta$

END IF

$w = w + 1$

UNTIL ($w \leq m$)

3. *Note:* The estimated reliability for intermediate stages is multiplied with all the SE reliability for first and last stages to calculate the overall estimated reliability.

$$\text{RETURN } R = (c / s) \cdot r(t)^f$$

Algorithm 1 depicts the procedure to perform Monte Carlo method with stratified sampling. Stratified sampling is applied to further enhance the accuracy of estimation. It partitions the sample into several strata (smaller and non-overlapping sets), where each stratum contains homogenous elements. This enables sampling to be performed on important strata and ignores irrelevant ones, thus improving the accuracy and efficiency of the estimation. Number of replications indicates the number of random sampling to be performed in the Monte Carlo method. Stratum sampling size is based on proportional allocation derived from binomial probability distribution shown in equation (1), based on the number of working SE in each stratum.

3.1 Confidence Interval for Monte Carlo Point Estimate

Confidence interval of the Monte Carlo method point estimate reliability value is then derived by making use of statistical non-parametric bootstrapping method. In bootstrapping, elements are sampled many times with replacement from the original random sample generated from the MC method. Non-parametric bootstrapping does not require any assumptions being made on the distribution pattern thus removing any errors that may result biased outcome. The bootstrapping method used to estimate the confidence interval in this paper is based on Efron's percentile confidence limit [21]. It is the simplest and most direct method in the bootstrapping family.

4. Numerical Results

Results from other methods are compared with the results from Monte Carlo method to ascertain the level of accuracy. For terminal reliability, it is compared against terminal reliability of SEN+ calculated using the mathematical approach [11, 12].

Broadcast and network reliabilities are used for comparison up to number of inputs, $N = 16$. This network reliability is computed by enumerating of all possible SE states using Fard and Gunawan's method [15]. For higher number of inputs, results are compared against Cheng and Ibe's exact broadcast reliability and network reliability bounds [14]. Results in Cheng and Ibe's paper are used in this comparison. In addition, results are also compared with Blake and Trivedi's network reliability bounds [10].

Throughout the analysis, 6000 replications (sampling size) with 95% level of confidence based on 5000 bootstrap samples for the estimated point reliability value is used as the settings for the Monte Carlo method. This setting has been tested out previously and proven to provide a moderate approximation in regard to the time required to generate the results.

All the methods mentioned above except Cheng and Ibe's broadcast and network reliability methods are implemented on a single software platform. The platform is built on Microsoft .Net framework using C# language plumbed with smaller ancillary functions developed in Matlab. It is capable of computing the all the three types of reliability for SEN+ using Monte Carlo method with varying SE reliability up to 2048 input, in addition to other methods mentioned previously.

A measurement parameter is introduced to measure the accurateness of Monte Carlo method, known as percentage of difference, α . This method measures the difference between Monte Carlo point estimate and the reliability value calculated using other methods.

$$\text{Percentage of Difference, } \alpha = \left| \frac{\text{Estimated value} - \text{Exact value}}{\text{Exact value}} \right| \times 100\% \quad (1)$$

4.1 Terminal Reliability

Monte Carlo point estimation shows low percentage of difference with less than 0.024% and 0.134% for $N = 16$ and 2048 respectively, as shown in Fig. 5. Plotting the confidence interval of Monte Carlo point estimate together with the reliability value for $N = 2048$ (Fig. 6) shows that it encapsulates all the exact values with lessening interval size as the SE reliability increases.

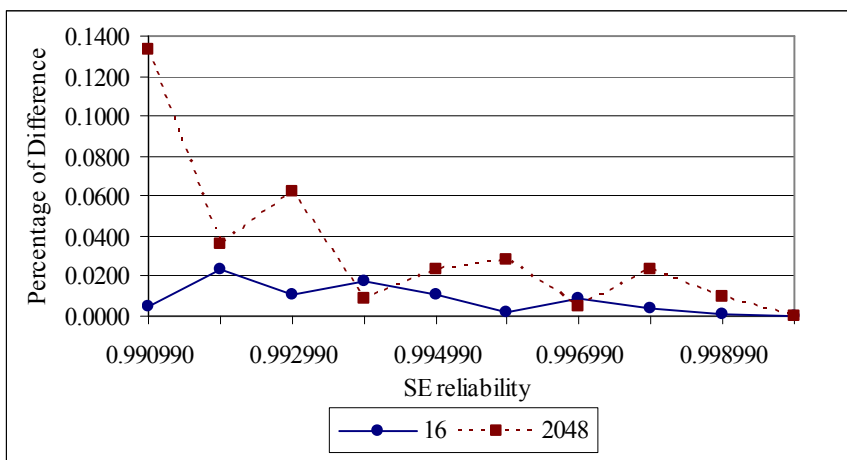

Figure 5. Percentage of Difference of Terminal Reliability for $N = 16$ and 2048 between Monte Carlo Point Estimate and Gunawan & Thanawastien Methods

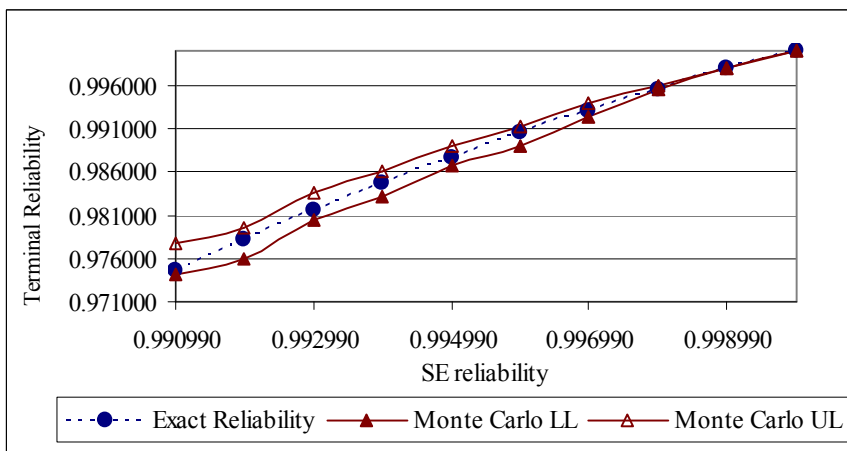

Figure 6. Exact Reliability and Monte Carlo Confidence Interval for Terminal Reliability with $N = 2048$

4.2 Broadcast Reliability

Broadcast reliability evaluation using Monte Carlo yields close approximation to the exact reliability.

Fig. 7 shows that Monte Carlo point estimation differs from reliability in Cheng and Ibe's method with percentage of difference less than 0.098% for $N = 1024$.

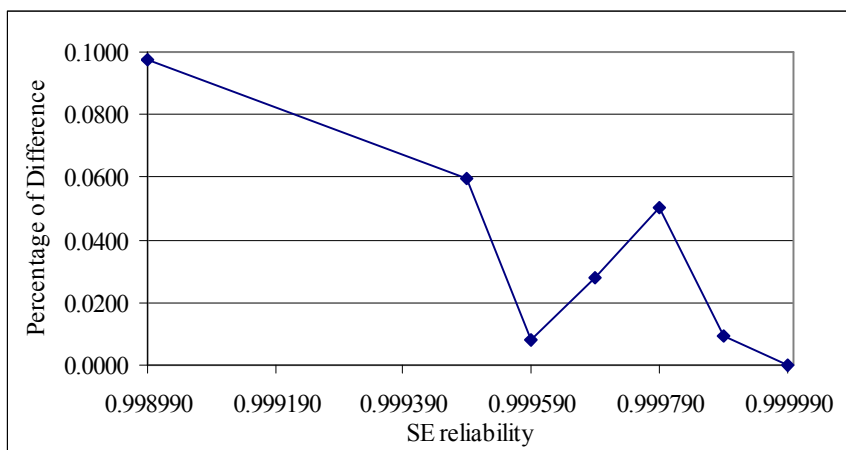

Figure 7. Percentage of Difference for Broadcast Reliability between Monte Carlo Evaluation and Cheng & Ibe's method with $N = 1024$

4.3 Network Reliability

In term of network reliability, Monte Carlo point estimation generates percentage lower than 0.084% for $N = 16$ with varying SE reliability as shown in Fig. 8. Due to the extreme number of possible SE states as the number of inputs increases, comparison can only be made up to maximum of 16 input for network reliability.

For higher number of inputs, comparison is made against the bounds calculated using Cheng and Ibe's, and Blakes and Trivedi's methods. Fig. 9 and 10 show that Monte Carlo confidence intervals fall within the bounds of Blake and Trivedi's method. However, it falls slightly lower than Cheng and

Ibe's bounds. Nevertheless, it is safe to use the Monte Carlo point estimation as the risk of overestimating the reliability value is lower than Cheng Ibe's bounds.

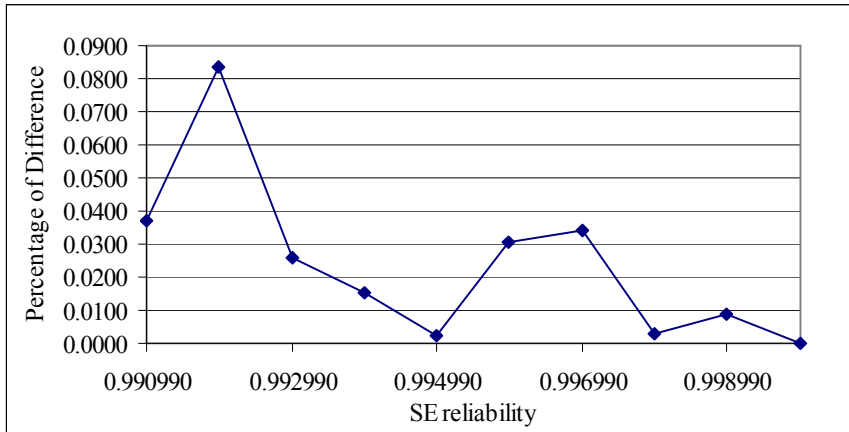

Figure 8. Percentage of Difference for Monte Carlo method point estimate for N = 16

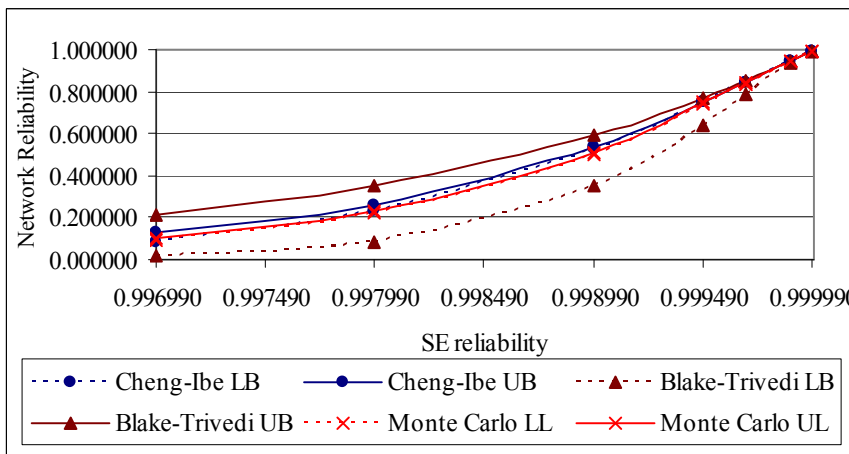

Figure 9. Network Reliability Bounds Calculated Using Cheng-Ibe's and Blakes-Trivedi's Method Plotted Together with Monte Carlo Confidence Interval for N = 512

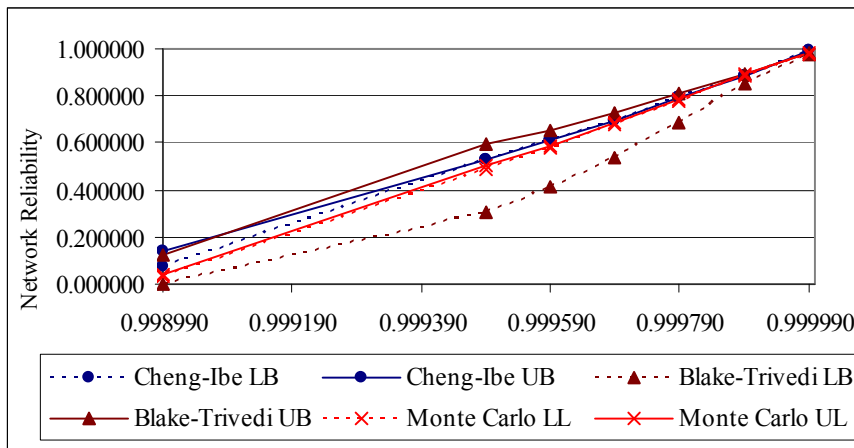

Figure 10. Network Reliability Bounds Calculated Using Cheng-Ibe's and Blakes-Trivedi's Method Plotted Together with Monte Carlo Confidence Interval for N = 1024

5. Conclusion

Based on the reliability results, it shows that Monte Carlo method is capable of providing reliability evaluation for SEN+ systems, thus proving that Monte Carlo method can be used as an alternative to compute the reliability of MINs in general. Instability of the line pattern in the percentage of difference plots is because of the single value estimation. The line pattern can be smoothed out by repeating the Monte Carlo method and then find the average value of the estimate before calculating the percentage of difference. Monte Carlo method is based on randomization which generates differing results at each time. Therefore, finding the average for repeated Monte Carlo method provides a better approximation. The presented numerical results are based on 6000 replications. The accuracy of the Monte Carlo method can be further increased by increasing the number of replication in trade of the resource and time to compute the result. Further works may include application of Monte Carlo method for other MIN systems to quantify their reliability.

References

1. A. Vamma and C.S. Raghavendra, Performance analysis of redundant path interconnection networks, *Proceedings of International Conference of Parallel Processing*, 1985, 474-479.
2. D. Tutsch and H. Gunter, Multilayer multistage interconnection networks, *Proceedings of 2003 Design, Analysis, and Simulation of Distributed Systems (DASD'03)*, Orlando, USA, 155-162.
3. S. Sibal and J. Zhang, On a class of banyan networks and tandem banyan switching fabrics, *IEEE Transactions on Communications*, 43 (7), 1995, 2231-2240.
4. F.A. Tobagi, T. Kwok and F.M. Chiussi, Architecture, performance, and implementation of the tandem-banyan fast packet switch, *IEEE Journal on Selected Areas of Communication*, 9 (8), 1991 1173-1193.
5. A. Gottfried, An overview of the NYU ultracomputer project, Technical report (TR-086-U100), Department of Computer Science, New York University, 1987.
6. J. Dongarra, The NEC Cenju-3, <http://www.top500.org/ORSC/1996/node39.html>, 1996.
7. NEC Corporation, NEC releases highly parallel computer based on new memory architecture, <http://www.nec.co.jp/press/en/9707/2801.html>, 1997.

8. R.Y. Awdeh and H.T. Mouftah, Survey of ATM switch architectures, *Computer Networks and ISDN Systems*, 8, 1995, 1567–1613.
9. Y. Yang, Permutation capability of optical multistage interconnection networks, *Journal of Parallel and Distributed Computing*, 60, 2000, 72-91.
10. J. Blake and K.S. Trivedi, Multistage interconnection network reliability, *IEEE Transactions on Computer*, 38 (11), 1989, 1600-1604.
11. S. Thanawastien, The shuffle/exchange-plus networks, *Proceedings of the 20th Annual Southeast Regional Conference*, 1982, 89-96.
12. I. Gunawan, Reliability bounds for large multistage interconnection networks, *Conference on Applied Parallel Computing (PARA'02)*, Espoo, Finland, 2002.
13. P.J. Chua and C.L. Kuo, A simple approach to the evaluation of multistage interconnection network reliability, *Proceedings 37th Midwest Symposium Circuits and Systems*, 1994, 313-316.
14. X. Cheng and O.C. Ibe, Reliability of class of multistage interconnection networks, *IEEE Transactions on Parallel and Distributed Systems*, 3 (2), 1992, 241-246.
15. N.S Fard, and I. Gunawan, Performance improvement in communication network systems, *Proceedings of IV SIMPOI/POMS*, 2001.

16. C. Srivaree-ratana and A.E. Smith, Estimation of all-terminal reliability using an artificial neural network, *Computers & Operations Research*, 29 (7), 2002, 849-868.
17. A. Konak and A.E. Smith, A general upper bound for all-terminal network reliability and its uses, *Proceedings of the Industrial Engineering Research Conference*, Banff, Canada, 1998.
18. A. Konak and A.E. Smith, An improved general upperbound for all-terminal network reliability, <http://www.pitt.edu/~aesmith/postscript/bound.pdf>, 1998
19. R.H. Jan, Design of reliable networks, *Computers and Operation Research*, 20 (1), 1993, 25-34.
20. S.G. Fishman, *Monte Carlo: concepts, algorithms and applications* (New York: Springer, 1996).
21. B. Efron and R.J. Tibshirani, *An introduction to the bootstrap* (New York: Chapman and Hall, 1993).