

Natural Fibers Concrete Model Using Points Launching Algorithm in Thermal Conductivity Prediction

S Ariyanti¹, M Zulkarnain^{2*}, M Lubis³

1. Department of Industrial Engineering, Engineering Faculty,
University of Mercubuana, Jakarta, Indonesia

2. Faculty of Mechanical & Manufacturing Engineering
Technology, Universiti Teknikal Malaysia Melaka, Malaysia

3. Department of Mechanical Engineering, Engineering
Faculty, University of Tarumanagara, Jakarta, Indonesia

ABSTRACT

Insulating building walls provides a reliable approach to reduce heat losses in buildings. However, thermal insulation requires an appropriate selection of materials and understanding of their thermal properties e.g. thermal conductivity and density. This study presents a 3D model of fiber-concrete composite for thermal conductivity prediction. Composite materials properties were characterized by morphology structure that are often complicated to model, especially on fiber system. In order to understand thermal interaction of the wall for an insulating system, the model provides four level range of fibers number (100, 150, 200 and 250 fibers number) to analyze fiber network existing. The fibers are constructed by points neighbor derived from randomly launching order to perform spline. MATLAB software was reliable to generate a fibers structure algorithm before export to computer-aided design software. The natural fibers of oil palm, coconut and sugar cane were simulated using finite element method to study characteristic and thermal behavior of insulating material. Representative volume element and grid independence study was done to validate the model. The simulation demonstrated that improvement in insulating material about 0.65% can be achieved by using 250 coconut fibers number, which is much lower compared to plain concrete. A Morphology study was successful to understand fibers distribution and thermal absorption through the concrete. This model provides a promising solution in an understanding of thermal dispersion for concrete composite material application.

1. INTRODUCTION

The building sector accounts for a third or more of worldwide daily energy consumption [1]. The rising population growth and urbanization is a major reason that results in the development of more buildings and residences. Buildings utilize metabolized matter and energy, about 25-40% of society's energy consumption [2], to produce waste and emissions. These account for about 30% of greenhouse gas emissions [3].

*Corresponding Author: m.zulkarnain@utem.edu.my

Previous studies have revealed that the heat losses in building occur through the external wall and its envelope has a major share in waste of energy. Thus, in order to save energy, it is considered paramount to use optimum insulation thickness in buildings [4].

There are several approaches proposed to save energy losses through the wall. Some approaches emphasize insulating the wall to protect heat transfer through the inside of the building [1, 4]. Yu et al. [5] suggested a technique that involve the construction of layers in the wall by stacking plasters within the concrete, thus improving thermal insulation [5]. Improving buildings' thermal insulation strictly involve appropriate material selection. One of the most modern insulating material available is an insulating board with the core made of rigid phenolic foam [6]. By using low thermal conductivity coefficient of this material, heat transfer through the wall can be reduced. Babota et. al [7] suggested another technique by designing an exterior wall of buildings from 10 cm thick with extruded polystyrene insulation. By analyzing the results, they showed that thermal performances of the wall improves comparatively to other studies applying insulating heat transfer.

Some building materials are known to produce a large amount of harmful emissions, where eighteen percent (18%) of the emissions are caused indirectly by material exploitation and transportation [8]. These materials have been found unsuitable to serve as insulating materials. More improved sustainable building technology materials are natural fiber such as sheep wool, hemp, sugar cane, coconut fiber and oil palm fiber, which have been traditionally used as renewable resource [1, 9, 10] and some for concrete reinforcement [11]. Florea and friend applied sheep wool and hemp as insulating material and found a high-energy efficiency of the building. The materials that were used were easy to supply because they are commonly found local products and because of their lightweight [1]. Other researchers have also been reported to use locally found organic insulating materials such as oil palm and coconut oil [9]. These materials have proven to be strong enough to reduce heat transfer due to their low thermal conductivity that are typically about 0.05 W/m.K.

Several studies focus on fibers distribution model in predicting mechanical behavior of the fibers [12, 13]. There is still a significant need of studies investigating thermal behavior of fibers for building insulation applications. This paper thus introduces a new model on the use of natural fibers of oil palm, coconut and sugar cane as insulating materials of concrete to reduce heat losses of buildings. The model presents the natural fibers embedded in concrete as a composite with new technique morphology structured. The model development is accomplished in MATLAB environment. In order to understand thermal interaction, the model provides four level range of fibers number to analyze fiber network existing. The effect of the amount in thermal conductivity was analyzed by finite element method.

2. METHODOLOGY

2.1. Material

The material for thermal conductivity study is chosen based on availability of local products for building. Vermiculite/cement of 3:1 ratio grade is selected as plain concrete for input into ANSYS Workbench software, while oil palm, coconut and sugar cane fibers are employed as filled concrete composite [9]. The material properties such as thermal conductivity and density are derived from previous studies; see Table 1 [14].

Table 1. Experiment data of fibers [9, 10].

Materials	Diameter, mm	Thermal Conductivity, W/m.K	Density, kg/m³
Oil Palm	0.137	0.057	774.3
Coconut	0.104	0.05	785.1
Sugar Cane	0.157	0.05314	678.8
Concrete	-	0.836	1320

3. MODEL DEVELOPMENT

3.1. Fibers Distribution Technique

Fibers distribution is an essential step in understanding/developing the microstructure characteristic that affect thermal conductivity. Generally, the microstructure was passed through three stages to fulfil nature fiber behavior: a) Generate domain size, b) Launch point c) Generate Fiber. All the stages procedures are explained as follows.

a) Generate Domain Size

As presented, the fibers formulation begins from domain size selection. The domain size selected is a cubical shape defined with respect to the x, y and z-axis (i.e. given same size for all axes). The cubical domain contains several points from the discretization process, these allowed to create several small cubes cloud with similar sizes on their axes. Every small cube cloud contains one coordinate point at the center. In this situation, the cube contains several numbers of points access that can be used as referring points in randomly selected manner. The domain size selected should allow minimum size in model design. This is validated through Representative Volume Element (RVE) study.

b) Launch Points

Multi points number registered in the cubical domain is selected randomly. Point selection is done once to avoid the overlapping condition. Furthermore, the program allows constructing several points in order to perform fiber design of a spline shape. The multi orientation of spline makes it possible to perform several points' neighbor position. These neighbor distance are limited by an allowed distance, (L_{allowed}), among the first point (P_i). The first points (P_i) selected are considered as the initial point in coordinate fiber position and fixed, while the second-order points selected (P_{i+1}) acts as a neighbor which allows to move from the origin point. Second-order points (P_{i+1}) are attached as a neighbor by following Pythagoras concept where the angle θ_i is used to measure the distance L_i from P_i . Points (P_{i+1}) are attached to P_i by using the same θ_i as a neighbor in $L_{\text{allowanced}}$ as distance. In addition, re-selecting point P_{i+1} will re-process if $L_i \leq L_{\text{allowanced}}$. The step is repeatedly until the number point is satisfied for one fiber design and fulfil the model by several fibers number. In the final stage, every single point of single fiber come out with x, y and z coordinate information that can be exported into excel file.

c) Generate Fiber

In this stage, prior to input in computer-aided design (CAD) software, excel file was used to generate splines based on points order given from MATLAB. All possible coordinates were developed by using subroutine to construct the spline. Consequently, the file is easy to export to any type of CAD software that allows ANSYS to import geometry. Four level range of fibers number were embedded in 50mm×50mm×50mm of a cubical sample, these are 100, 150, 200 and 250 fibers number.

3.2. Validation

In order to study the effect of nature fibers in thermal performance, it is necessary to validate the method through thermal conductivity setup by using ANSYS Finite Element Analysis. ANSYS code for composite study were derived from previous studies [15,16]. The material chosen was plain concrete and modelled by ANSYS Workbench software. The plain concrete was modelled in 50 mm side size with simple Hexahedron in the meshing. The study focused on thermal conductivity result define by equation (1).

$$k = \frac{Q \cdot l}{A \cdot \Delta T} \quad (1)$$

where Q denote thermal energy in Watt, l is the length of the sample in meter, A is area and ΔT is the differentiated temperature in Kelvin. The boundary conditions were 200°C and 22°C without any resistance on the surface. Table 2 presents thermal conductivity results for both experimental and finite element method. The figure shows that 0% difference was achieved between experimental and finite element method. According to transient thermal analyses of ANSYS Workbench, thermal transfer requires a certain time to pass through the concrete to allow Q to be calculated as shown in the Equation (1).

Table 2. Thermal conductivity comparison

Method	k , W/m.K
Experimental	0.836
Finite Element Analysis	0.836

3.3. Representative Volume Element (RVE)

Thermal conductivity was studied in material investigating scale with various sizes of 20 mm, 30 mm, 40 mm and 50 mm of side sizes. The geometry model chosen in the RVE study was 250 fibers number with sugar cane as filler as shown in Figure 1. The scale sample prepared was located at the center of the fibers distribution by applying different temperatures to generate heat transfer.

The investigated concrete/sugar cane composite thermal conductivity against multi-scale is shown in Figure 2. The figure presents insignificant difference in results among varied scale, which means that the multi-scale size of concrete results in almost constant value.

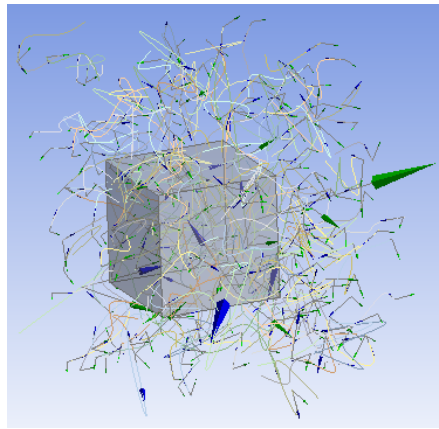

(a)

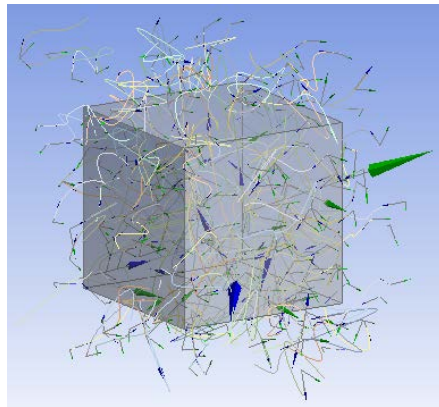

(b)

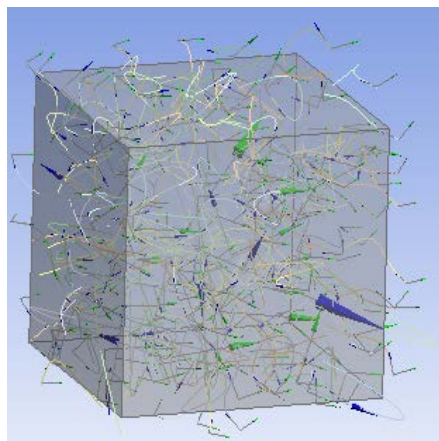

(c)

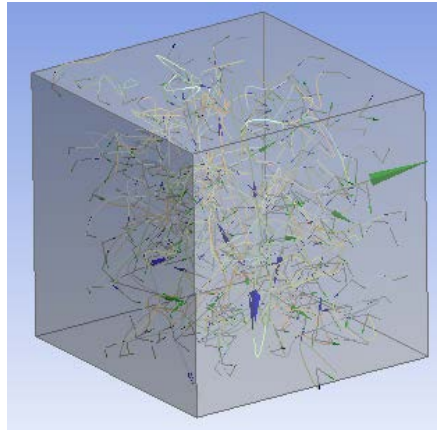

(d)

Figure 1. Material investigating scale with various sizes of (a) 20 mm, (b) 30 mm, (c) 40 mm and (d) 50 mm.

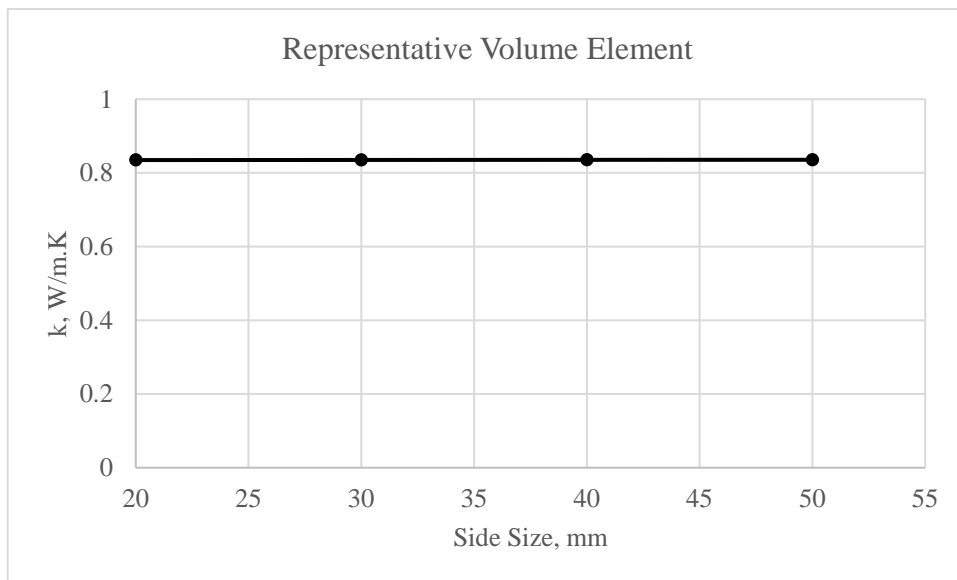

Figure 2. Multi-scale RVE model

3.4. Meshing

Grid Independence study was conducted on plain concrete to determine suitable element number for thermal analysis; this is similar to previous study in [15]. The meshing employed was simple Hexahedron for thermal analyzing. Figure 3 shows grid independence study on plain concrete against thermal conductivity, where the graph produces constant values of conductivity to element numbers. The mesh number above 1000 was considered in this study to obtain accurate results on thermal conductivity purpose.

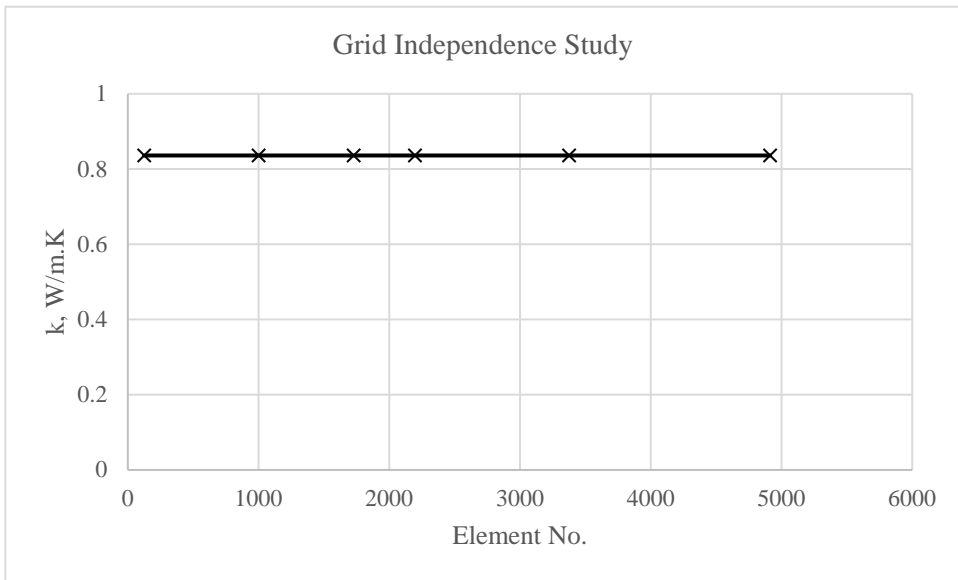

Figure 3. Grid independence study against thermal conductivity of plain concrete.

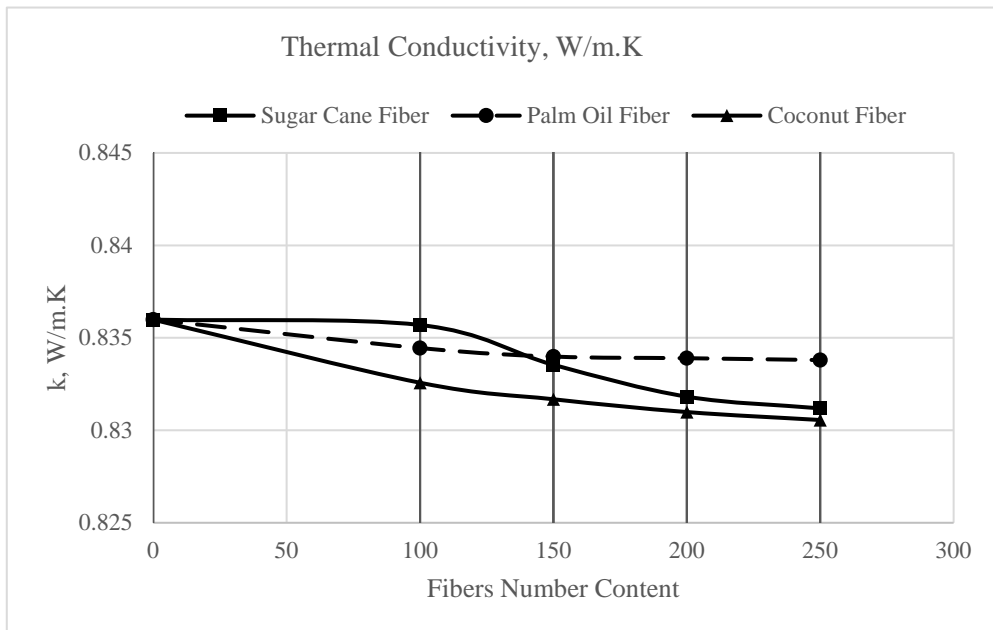

Figure 4. Thermal conductivity against fibers number

4. RESULTS AND DISCUSSIONS

Concrete composite simulation has shown different performance based on fiber material selection and particularly on thermal conductivity. The characteristic fiber performance in thermal conductivity is described in Figure 4. This figure illustrates that thermal conductivity against various fibers number content leads to a decreasing trend. It is observed that coconut fiber performs slightly lower than other fiber due to its peculiar fiber characteristics. By comparing thermal conductivity performance to the plain concrete, 250 fibers number showed good performance as insulator by decreasing temperature loss approximately by 0.65%, 0.58% and 0.26% for coconut, sugar cane and palm oil, respectively. The result demonstrates the potential usefulness of natural fibers from local product as insulating materials to help reduce energy loss from the buildings. The graph trend would probably decrease by adding more fibers embedded inside the concrete. This phenomenon has been supported in previous studies that demonstrated an increase in thermal resistance of composite because of adding more insulating fillers [16].

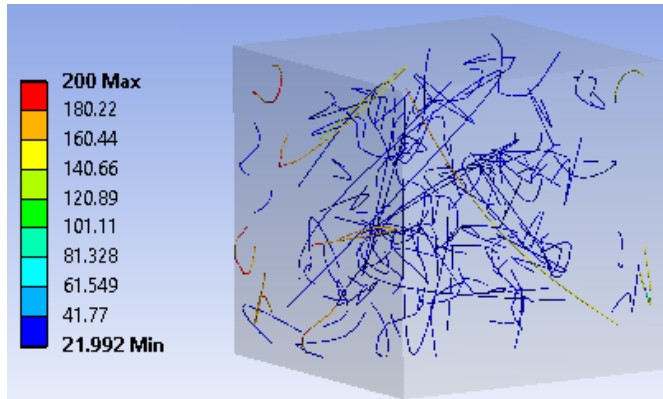
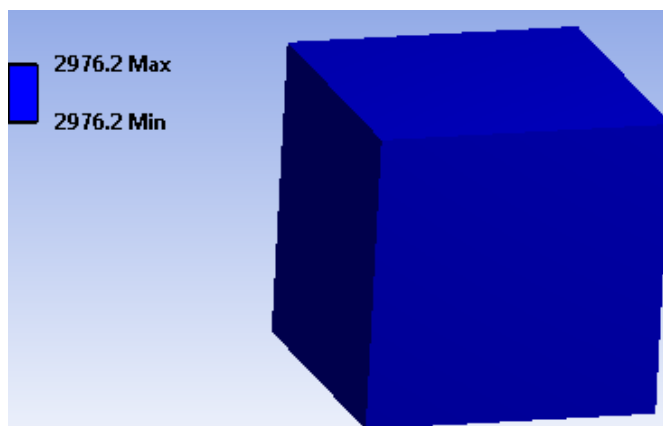
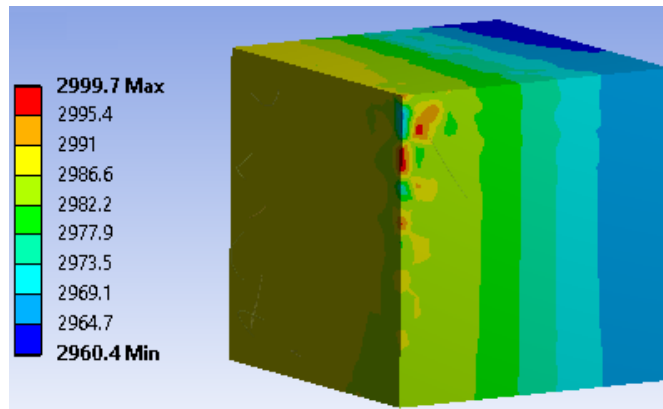

Figure 5. Temperature distribution on 100 number fibers of sugar cane



(a)



(b)

Figure 6. Heat flux through sample of (a) plain concrete and (b) 100 fibers number of sugar cane.

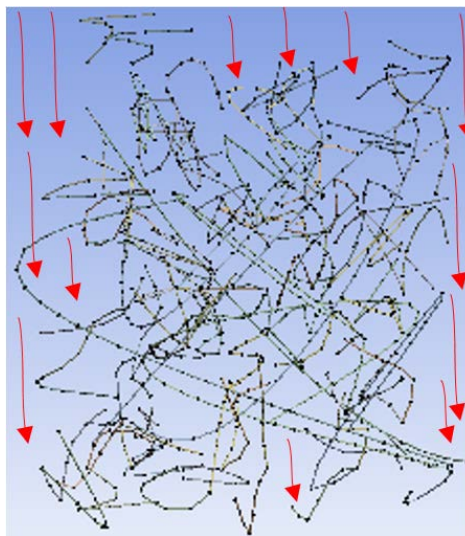

Figure 7. Schematic illustration of fibers particles distribution in concrete about the formation of thermally conductive pathways.

Morphology is an important part of influencing thermal conductivity results. This point has been explained in previous work that observed a decrease in thermal conductivity due to rise of alveolar structure in fibers distribution [17]. According to morphology observation, we found that fibers distribution under certain conditions might be increasing thermal insulation as shown in Figure 5. The figure shows that temperature distributes around fiber and this cause a small amount of the temperature to be absorbed through the concrete. It is clearly seen that the homogeneity of fiber distribution produced a good temperature absorption. It causes reduction in the total heat flux passing through the concrete as shown in Figure 6.

Comparison of heat flux between plain concrete and 100 fibers number can be easily distinguished. This shows that fibers successfully decrease heat flux flow through the concrete, homogeneously. It is observed that fiber formation successfully blocked the thermal conductive pathway. This phenomenon occurred on all amount of fiber content from various fiber types. However, the pathway of thermal through concrete obviously led to a thermal transfer. Figure 7 illustrates the schematics of fibers network to counter thermal to transfer through the wall. This network connected lines contributes to the thermal resistance. The total resistance among fibers in the concrete is the sum of thermal resistance. Thus, a long fibers network chain might increase the resistivity of the concrete. The thermal conductivity value can be decreased by long line of fibers network. It can be determined that the decreasing amount of thermal energy passes through a specific area per unit of time. It might be possible to add more fibers to produce higher thermal resistance for increase energy efficiency.

5. CONCLUSIONS

A fiber concrete composite model has been successfully developed in this study. to study thermal conductivity and the characteristics of composite of fiber concrete. According to the results, fibers quantity and quality primarily affect thermal changes of composite. The models showed that the quality of thermal conductivity decreases by increasing the quantity of fibers, for all types of natural fibers (e.g. oil palm, coconut and sugar cane). Meanwhile, we conducted a morphology study that shows how the energy efficiency can be enhanced by insulating the total heat flux. By achieving a decrease in thermal conductivity, this method of fiber-concrete composite is an innovative step of using local products as insulating materials.

ACKNOWLEDGMENT

On behalf of all authors, the corresponding author states that much appreciate to Universiti Teknikal Malaysia Melaka (UTeM) to support financial and equipment during research completion.

REFERENCES

- [1] Florea I and Manea DL., Analysis of Thermal Insulation Building Materials Based on Natural Fibers, *Procedia Manuf*, 32, 230 (2019).
- [2] Perez-Lombard L, Ortiz J, Pout C., A review on buildings energy consumption information, *Energy Build.*, 40(3), 394–398 (2008).
- [3] Reza B, Sadiq R, Hewage K., Energy-based life cycle assessment (Em-LCA) of multi-unit and single-family residential buildings in Canada, *Int. J. Sustainable Built Environ.*, 3, 207 (2014).
- [4] Mishra S, Usmani J A, Varshney S., Energy Saving Analysis in Building Walls Through Thermal Insulation System, *Int. J. Eng. Res. App.*, (2)5, 128(2012).
- [5] Yu G, Zheng S, Zhaou P, Du C., Thermal Performance of Building-integrated Solar Wall during Stagnation, *Procedia Eng.*, 205, 183 (2017).
- [6] Hola A, Czarnota M., Analysis of the possibilities of improving timber-framed wall thermal insulating with regards to historical buildings, *Procedia Eng.*, 111, 311 (2015).
- [7] Babota F, Iernutan RA., Calculation and analysis of corrected thermal resistance in a common dwelling building in Romania, in various thermal insulation options – The exterior wall, *Procedia Manuf.*, 32, 442(2019).

- [7] Keysar E and Pierce AR., Decision support tool for green building: Facilitating selection among new adopters on public sector projects, *J. Green Build*, 2, 153 (2007).
- [8] Monahar K, Experimental Investigation of Building Thermal Insulation from Agricultural By-products, *Br. J. App. Sci. Technol.*, 2(3), 227 (2012).
- [9] Shang XM., Fractal Heat Transfer in Wool Fiber Hierarchy, *Heat Transfer Res.*, 44, 399 (2013).
- [10] Shakir AA., Wan Ibrahim MH, Othman NH, Shahidan S., The Effect of Palm Oil Clinker and Oil Palm Shell on the Compressive Strength of Concrete, *Iran J. Sci. Technol. Trans. Civ. Eng.*, 43, 1 (2018).
- [11] Rasouli M & Broujerdian V., 3D Finite Element Modeling of FRP-Confined Rectangular Short Columns Considering Variation of Poisson's Ratio, *Iranian Journal of Science and Technology, Trans. Civ. Eng.*, 44, 449 (2020).
- [12] Kaveh A, Bakhshpoori T, Ziabari SMH., New Model Derivation for the Bond Behavior of NSM FRP Systems in Concrete, *Iran J. Sci. Technol. Trans. Civ. Eng.*, 41, 249 (2017).
- [13] Koksai F, Diaz JJDC, Gencel O, Rabanal FPAR., Experimental and numerical analysis of new bricks made up of polymer modified-cement using expanded vermiculite, *Comput. Concr.*, (12)3, 319 (2013).
- [14] Shen H, Finite element analysis on parameterized model of fiber composite battledore, *Int. Jnl. of Multiphysics*, (13)2, 179 (2019).
- [15] Varatharajoo R, Salit M.S., Hong G.K., Material optimization of carbon/epoxy compositerotator for spacecraft energy storage, *Int. Jnl. of Multiphysics*, (4)2, 95 (2010).
- [16] Nagy B, Nehme SG, Szagri D., Thermal properties and modeling of fiber reinforced concretes, *Energy Procedia*, 78, 2742 (2015).
- [17] Hakkoum S, Kriker A, Mekhermeche A., Thermal characteristics of Model houses Manufactured by date palm fiber reinforced earth bricks in desert regions of Ouargla Algeria, *Energy Procedia*, 119, 662 (2017).
- [18] Oushabi SA, Kammouni A, Tanane O, El Bouari A., Mechanical and thermal conductivity properties of hemp fiber reinforced polyurethane composites, *Case Stud. Constr. Mater.*, 8, 203 (2018).

