

NEMATODE SURVIVAL IN RELATION
TO SOIL MOISTURE

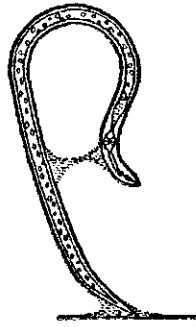

W. R. SIMONS

NEMATODE SURVIVAL IN RELATION TO SOIL MOISTURE

Dit proefschrift met stellingen van:

WILFRIED RUDOLF SIMONS

landbouwkundig ingenieur, geboren te Bussum op 11 augustus 1939, is goedgekeurd door de promotor, Dr. Ir. M. Oostenbrink, lector in de Nematologie.

De Rector Magnificus van de Landbouwhogeschool,

H. A. LENIGER

Wageningen, 9 mei 1973

W. R. SIMONS

NEMATODE SURVIVAL IN RELATION
TO SOIL MOISTURE

PROEFSCHRIFT

TER VERKRIJGING VAN DE GRAAD
VAN DOCTOR IN DE LANDBOUWWETENSCHAPPEN,
OP GEZAG VAN DE RECTOR MAGNIFICUS,
PROF. DR. IR. H. A. LENIGER,
HOGLERAAR IN DE TECHNOLOGIE,
IN HET OPENBAAR TE VERDEDIGEN OP DONDERDAG
21 JUNI 1973 DES NAMIDDAGS TE VIER UUR IN DE AULA
VAN DE LANDBOUWHOGESCHOOL TE WAGENINGEN

1973
1973
1973
1973
1973

**This thesis is also published as Mededelingen Landbouwhogeschool Wageningen 73-3 (1973)
(Communications Agricultural University Wageningen, The Netherlands)**

STELLINGEN

I

Droogte is voor veel grondnematoden niet zonder meer schadelijk.

II

Het gebruik van de benaming aaltje als synoniem van nematode dient vanwege de associatie met aal te worden vermeden.

III

Het is onjuist om de toename van nematodenpopulaties in bevochtigde grond, vlak na een periode van droogte, voornamelijk toe te schrijven aan het uitkomen van eieren.

KHAN, A. M. et al. (1971). *Indian J. Nematology* 1.

NORTON, D. C. (1959). *Pl. Dis. Repr* 43.

IV

De grote verspreiding in Nederland van *Tylenchorhynchus dubius* kan worden toegeschreven aan de droogtetolerantie en de polyfagie van deze soort.

V

Nematodenbestrijding met droge braak zal alleen in combinatie met grondbewerking doelmatig zijn.

VI

De arbeidsproductiviteit bij de rechterlijke macht kan worden verhoogd door rechters (adequate) kantoren in de gerechtsgebouwen te verschaffen.

VII

De nematicide werking van ammoniak mag niet worden toegeschreven aan endosmose.

VASSALLO, M. A. (1967). *Nematologica* 13.

VIII

Bij het onderzoek over biologische bestrijding van insecten verdient de toepassing van nematoden meer aandacht.

IX

Dat marktonderzoekers hebben vastgesteld dat er op verscheidene voor publiek toegankelijke plaatsen in Nederland nog een stilte bestaat die met achtergrondmuziek kan worden doorbroken, is op zichzelf al jammerlijk.

X

'Selection at random' is een, de wiskunde onwaardige, 'contradictio in terminis'.

BAILEY, N. T. J. (1959). Statistical methods in biology

XI

Ondanks een toenemende behoefte aan hulp van buitenlandse deskundigen in ontwikkelingslanden zal de vraag hiernaar gaan afnemen.

XII

De discriminatie van 'linksen' door de overwegend rechts georiënteerde maatschappij kan enigszins worden verminderd door schaatswedstrijden op 8-vormige banen te houden.

*Aan Marijke
Martijn
Arjan
Bastiaan*

CONTENTS

1. INTRODUCTION AND LITERATURE SURVEY	1
1.1. General	1
1.2. Nematodes in aqueous solutions	6
1.3. Soil moisture effects on nematodes	9
1.3.1. Saturated soil	9
1.3.2. Unsaturated soil	13
1.3.3. Dry soil	18
1.4. Scope of the investigations	23
2. MATERIALS AND METHODS	24
2.1. Nematodes	24
2.1.1. Specimens for experiments	24
2.1.2. Extraction from soil	24
2.1.3. Enumeration of extracted populations	25
2.1.4. Statistical analyses of nematode numbers	26
2.2. Soils	26
2.2.1. Natural soils selected for experiments	26
2.2.2. Soil treatment prior to experimentation	28
2.3. Desiccation of nematodes in vitro	28
3. SURVIVAL IN MOIST FALLOW SOIL	32
3.1. General investigations	32
3.1.1. Fluctuating moisture levels	32
3.1.2. Constant moisture levels	33
3.1.3. Various controlled moisture regimes	34
3.2. Investigations on <i>Tylenchorhynchus dubius</i> and <i>Rotylenchus robustus</i>	36
3.2.1. Under a constant moisture level	36
3.2.2. Various constant moisture levels	37
3.2.3. Constant moisture levels with addition of fertilizer	38
3.2.4. Constant moisture levels with addition of organic manure	38
3.2.5. Fluctuating moisture levels	40
3.3. Discussion	41
4. SURVIVAL IN DRY FALLOW SOIL	43
4.1. Extraction of nematodes from dry soil	43
4.2. General investigations	47
4.2.1. Desiccation survival in Tarthorst soil	47
4.2.2. Desiccation survival in three different soils	48
4.3. Investigations on <i>Tylenchorhynchus dubius</i> and <i>Rotylenchus robustus</i>	49
4.3.1. Active nematode stages	49
4.3.2. Nematode eggs	50
4.3.3. Comparison of <i>Tylenchorhynchus dubius</i> and <i>Rotylenchus robustus</i>	53
4.4. Discussion	56
5. DESICCATION SURVIVAL IN VITRO	58
5.1. General aspects of desiccation	58
5.2. Rate of desiccation	59
5.3. Degree of desiccation	60
5.4. Duration of desiccation	61
5.5. Fluctuating degrees of desiccation	62

5.6. Active nematode stages	63
5.7. Nematode eggs	64
5.8. Influence of inorganic salts	66
5.9. Influence of carbon dioxide	68
5.10. Discussion	69
6. SUMMARY	73
7. SAMENVATTING	76
ACKNOWLEDGMENTS	79
REFERENCES	80

1. INTRODUCTION AND LITERATURE SURVEY

1.1. GENERAL

Established populations of plant parasitic nematodes are very persistent in the soil. Their density may vary with the host plants and with climatic, soil and other factors. Under favourable conditions, nematodes move, feed and reproduce; under unfavourable conditions they become inactive and may be damaged or die, but there are always enough survivors to restore the population promptly when circumstances improve.

Most nematode parasites of aerial plant tissues, such as *Ditylenchus*, *Anguina*, and *Aphelenchoides* species, have certain stages which may become quiescent and extraordinary resistant under adverse conditions. The cyst-forming and root-knot nematodes have special protecting mechanisms against environmental stresses. Their eggs and unhatched larvae are covered by a cyst wall or a jelly matrix and the greater part of the life cycle occurs inside the host plant. Many species of ectoparasitic root infecting nematodes, however, do not have apparent mechanisms for protection; their entire life cycle occurs in the soil and all developmental stages are exposed to a perpetually changing environment. Populations of ectoparasites are nevertheless persistent. Such nematodes have been chosen for further investigation.

Soil inhabiting nematodes need an aerobic, aquatic milieu for their activities, and the moisture content of the soil, which may fluctuate widely, is therefore of great importance. In studying the influence of soil moisture on nematodes one must consider the following: the solid, mineral and organic soil phase (solid soil), the liquid soil phase (soil moisture), the gaseous soil phase (soil air), and the nematodes. These constituents have been studied extensively in their corresponding disciplines and data on the relationship between solid soil, soil moisture and soil air are amply available. The influence of nematodes on the structure and composition of the soil is probably very small, despite their general abundance at densities of 20–50 per ml of soil. The length of a nematode is usually less than 1 mm and its weight less than $2 \cdot 10^{-7}$ g. Even large nematodes are unable to move anything but the film of water around their bodies and an occasional minute soil particle and they do not change the structure of the soil. This can be seen in vitro by watching nematodes moving in thin layers of soil under a microscope, and can also be noticed from a recent time-lapse photographic study on nematode activity in glass-panelled observation chambers (East Malling Research Station, 1965/66; cf. PITCHER 1968).

Nematodes do require space and must have some influence on the quality of soil water and soil air. The biomass, calculated from the data above, however, is only some 20 kg per ha, with perhaps 100 kg per ha or 0.003 % by weight of the tilth as a maximum, and must therefore be negligible as a factor in soil

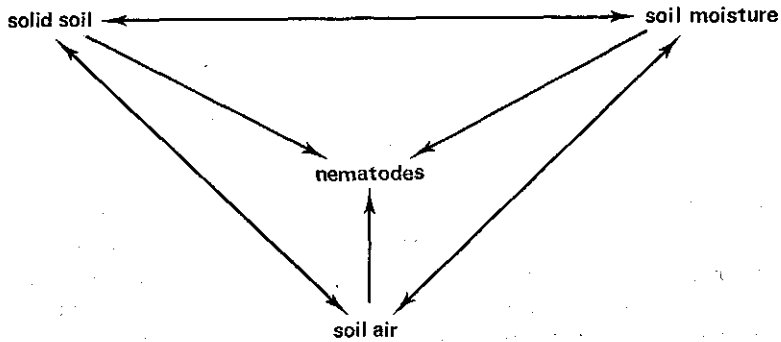

FIG. 1. Scheme of gross relations between the three major, interrelated soil phases and nematodes.

formation or as a constituent of the soil. This calculation has, of course, no bearing on the significance of nematodes in biological processes, i.e. the causation of plant diseases and interactions with the micro-flora and fauna in the soil.

Several studies, reviewed in detail under 1.2 and 1.3, demonstrate that solid soil, soil water and soil air affect the behavior of nematodes. The information, however, is too scanty and erratic to draw a clear picture about the relationship between soil moisture and nematodes, also because the soil phases are complex and interrelated. It has, for example, been established beyond doubt that certain nematode species thrive only in certain types of soil, but it is not known in how far this is determined by the soil structure, the solid materials, the moisture, the dissolved materials, the biotic elements or other components.

The scheme of figure 1 summarizes the gross relations between the interrelated soil phases and nematodes. In the scheme of figure 2, solid soil, soil water and soil air are analysed into the constituents which determine the moisture potentials affecting nematodes. Although soil moisture quantity (moisture content) and quality are always interrelated and interacting, it is desirable and often unavoidable to indicate them separately in soil moisture-nematode studies. The terms matric potential and osmotic potential in figure 2 refer to the energy state of the soil moisture at a given locality. Adhesion and adsorption forces cause moistening of the soil particles and the surface tension of the water causes capillary filling of the pores, unless adverse forces like gravity are greater. Matric potential refers to the energy state of soil moisture due to adsorption, adhesion and capillary forces. Chemicals dissolved in the water cause an osmotic potential. The sum of these potentials or the total potential (expressed in erg/g) is defined as negative. In practice the concept soil moisture tension (expressed in cm water-column or bar), derived from the matric potential, is often used. In a water-saturated soil the moisture tension is about zero. When water disappears from the system by gravity, evapotranspiration or otherwise, the moisture tension of the remaining water will increase and may reach values of 100 bar and more in very dry soil. As the practically important range of soil

	phases	constituents	moisture potentials
S O I L	solid soil	silicates, clay minerals chemical components	→ matric potential
	soil moisture	dissolved salts wetting agents water	→ osmotic potential → surface tension
	soil air	water vapour	→ vapour pressure (relative humidity)

FIG. 2. Analysis of soil phases (cf. fig. 1) into constituents, which determine the moisture potentials affecting nematodes.

moisture tensions is rather long, the pF value is often used, i.e. the 10-logarithm of the soil moisture tension expressed in centimeters water-column. pF values of 0 to 7 therefore correspond with soil moisture tensions of 1 to 10^7 cm (= about 0.001 to 10,000 bar). The moisture content of a soil corresponding to a particular pF value depends on soil structure and texture. For each combination of structure and texture there is a specific relation between amount of moisture and pF value. Plotting these two variables against each other gives the so-called moisture characteristic or pF curve. There is, however, no fixed relation between moisture content and pF value. A drying soil generally shows a different curve than a soil that is being wetted. The moisture characteristic is nevertheless a useful tool to indicate particular conditions in the soil. Figure 3 shows examples of such curves for different soils.

Besides the amount of soil moisture in the liquid state, the relative humidity of the air in the soil pores also is related to pF according to the equation:

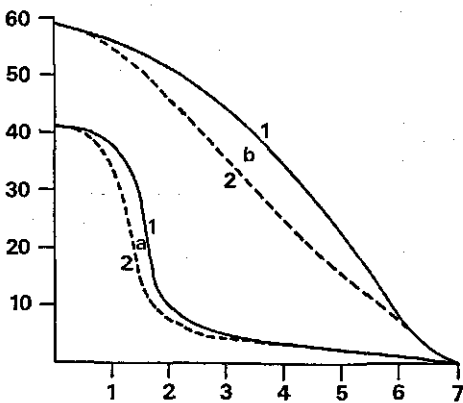

FIG. 3. Moisture characteristics of a sandy soil (a) and a clay soil (b) when they are gradually dried (1) or wetted (2).
Abscissa: pF value.
Ordinate: moisture content (% water by volume).

$$pF' = C + \log (2 - \log r.h.)$$

When the pF includes the osmotic potential, it will be indicated as pF'. The value of C varies with the temperature; C = 6.502 at 20°C. The graphical presentation of the equation shows that the relative humidity is close to 100% up to pF' values of about 4 (fig. 4A) Precise readings of high relative humidities can be obtained from figure 4B, in which the scale of the ordinate is double logarithmically.

WALLACE (1958) studied movement of nematodes in connection with soil moisture. Figure 5A shows that moisture content of the soil is of great influence on nematode mobility and that there is no mobility when the soil particles are too fine and therefore soil pores are too small. Figure 5B, calculated from results by KHAN et al. (1971), demonstrates that the amount of soil moisture also affects reproduction of nematodes. Thus favourable soil moisture conditions for both mobility and reproduction appear to be limited to a narrow range of moisture contents. The relation between a soil moisture quantity gradient and nematode activities may be characterised by an optimum curve, if the gradient and the time of exposure are well-chosen. This holds for the density of a thriving population (resulting from various activities such as movement,

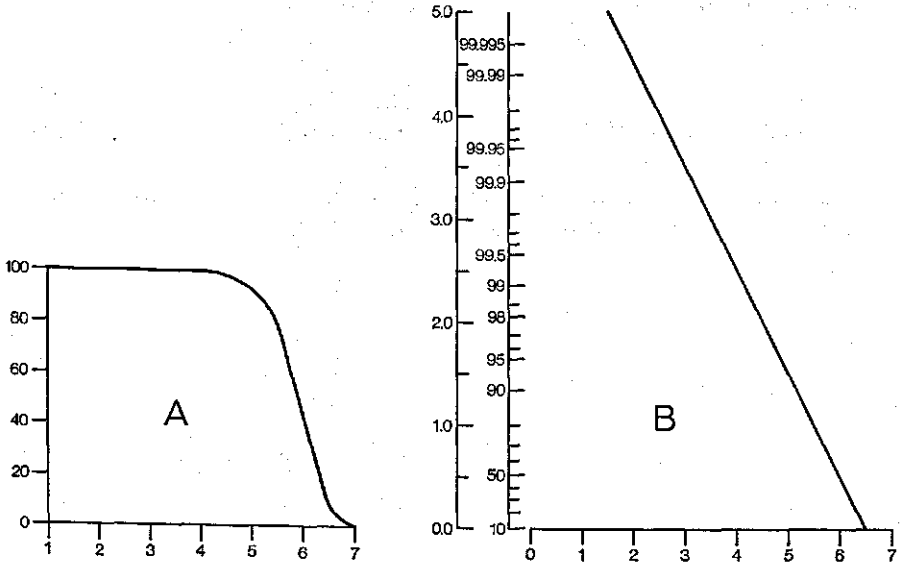

FIG. 4. Relation between pF' and relative humidity (r.h.) at 20°C (fig. A: Croney, Coleman and Bridge, 1952; fig. B: Stakman, 1968).

Abscissae: pF' value.

Ordinates: fig. A. r.h. in %, fig. B. left scale: $-\log(-\log \frac{r.h.}{100})$

right scale: r.h. in %

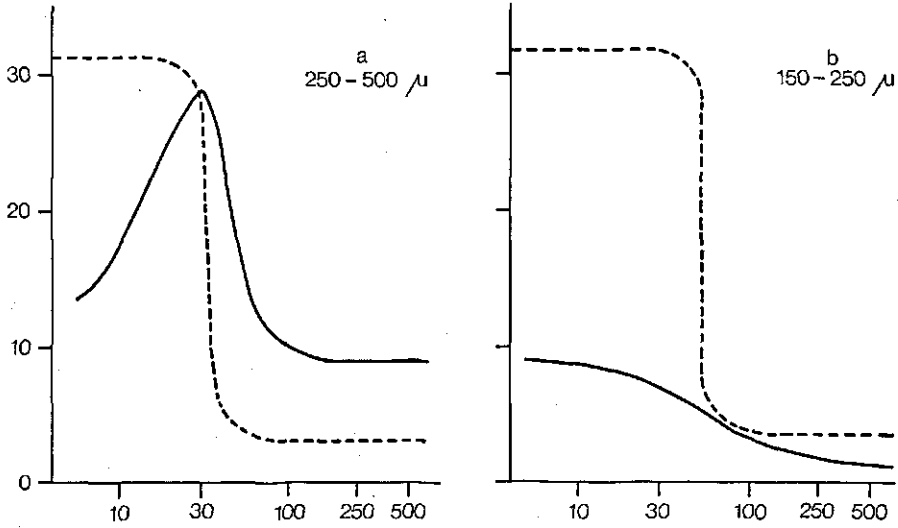

FIG. 5A. Horizontal migration of *Ditylenchus dipsaci* larvae through fractions of a sandy loam soil which are favourable (a) or too fine (b), at different suctions (after Wallace, 1958). —: mobility, ----: moisture content at different suctions. Abscissae: suction (cm water column, log. scale). Ordinates: moisture content (% by volume) as well as migration (% nematodes moving more than 3 cm in 5 hours).

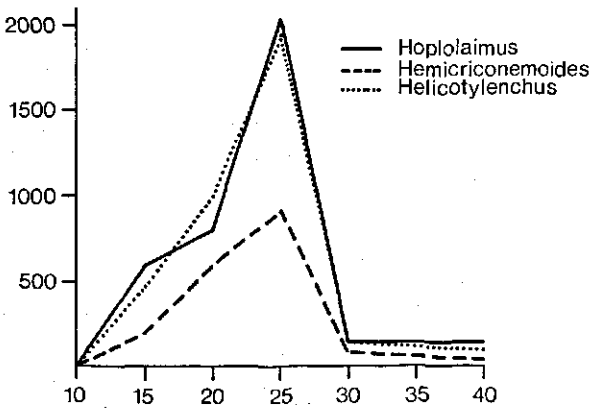

FIG. 5B. Population development of three nematode genera on mango seedlings, proceeding from 300 specimens of each genus inoculated in soil, which is kept at 6 different moisture levels during 60 days. (Calculated and constructed after Khan, Adhami and Saxena, 1971). Abscissa: soil moisture content (% by weight). Ordinate: number of nematodes 60 days after inoculation.

feeding and reproduction, and dying), or for a particular activity such as movement.

Literature on nematode-moisture relations including results on unfavourable moisture conditions is scrutinized and evaluated below.

1.2. NEMATODES IN AQUEOUS SOLUTIONS

Nematodes are aquatic animals with an integument permeable to water, ions and molecules. This permeability may be selective. Changes of concentration or composition of the soil solution will lead to exchange of water and ions or molecules between the nematode's body fluid and the soil solution to restore an (osmotic) equilibrium. Osmoregulation has been studied more often for non-plant parasitic nematodes than for plant parasitic species and the literature mainly relates to in vitro studies.

CROLL and VIGLIERCHIO (1969) conclude from the literature that animal parasitic nematodes living in hypertonic environments osmoregulate better in hypertonic media than in hypotonic media. Nematodes inhabiting hypotonic habitats regulate better in hypotonic media. From their experiments with the marine nematode *Deontostoma californicum*, the body fluid of which is isotonic to 0.6M NaCl and that is able to osmoregulate only in hypertonic solutions, they presume that ionic and osmotic regulation of nematodes is related to the properties of the integument and to the chemical and physical properties of the ions. Experiments by STEPHENSON (1944) with *Rhabditis terrestris* placed in solutions of different inorganic chlorides showed that an exchange of water and ions between the nematodes and the solutions occurred. The rate of exchange for this nematode depended on three factors: osmotic pressure inside the nematode, concentration of the chloride solutions, and kind of ions in the solution. Stephenson suggests that penetration rates are controlled by the living protoplasm of the nematode's epidermis and not by the non-living cuticle. *Rhabditis terrestris* kept in a solution osmotically equivalent to 1 M NaCl for 17 minutes recovered after transfer to the original culture medium equivalent to 0.02 M NaCl. MYERS (1967) found indications for selective uptake and retention of different ions in *Panagrellus redivivus* and *Aphelenchus avenae*. Similar observations were made for *Ascaris* species by HOBSON et al. (1952a, b). VIGLIERCHIO, CROLL & GORTZ (1969) tested the response of 6 soil and plant nematode species to 24 hours dip in solutions of urea and NaCl. They found that tolerance (restored activity upon transfer to distilled water) varied with species. The order of increasing tolerance was *Rhabditis* spp., *Pratylenchus vulnus*, *Hemicycliophora arenaria*, *Tylenchulus semipenetrans*, *Meloidogyne hapla* (L2), *Ditylenchus dipsaci* (L4). Treatment of *Ditylenchus dipsaci* and *Rhabditis* spp. with several electrolytes gave the following order of increasing mortality: NaCl, Na₂SO₄, RbCl, KI for *Ditylenchus* and Na₂SO₄, RbCl, NaCl, KI for *Rhabditis*. It was also observed that *Ditylenchus dipsaci* shrinks in a hypertonic

solution and does not recover its original size as does *Rhabditis* spp. These phenomena, referred to as tolerance for *Ditylenchus* and adaptation for *Rhabditis*, could be related to difference in biology and natural environment of these species.

BLAKE (1961) observed that *Ditylenchus dipsaci* larvae (L4) were killed after 36 hours in a 1M urea solution. *Tylenchorhynchus icarus* recovered in water after a 4 day treatment in 1 M urea (WALLACE & GREET, 1964). *Hoplolaimus columbus* ceased movement after 16 hours in 0.2 M KI, 0.4 M NaCl, 0.6 M Na₂SO₄ and 1 M urea. Recovery from these solutions after 3 days in water was 10% from KI, 30% from NaCl, 55% from Na₂SO₄ and 90% from urea (FASSULIOTIS, 1972).

The effect of sugar solutions has been investigated for various nematode species. *Pratylenchus brachyurus*, *Dolichodorus heterocephalus*, *Radopholus similis* and *Panagrellus* sp. survived 1 hour immersion in a solution of 7% (w/v) sucrose (about 4.7 bar). One hour in a 30% (w/v) solution (about 20 bar) killed nearly 100% of these nematodes. Also addition of 5% (w/v) sucrose to various soils killed almost all nematodes within 24 hours (FEDER, 1960). When cysts of *Heterodera schachtii* were treated with 0.1 to 60% sucrose solutions for 96 hours and subsequently placed in sugar-beet diffusate, emergence of larvae was reduced only 40% by the highest concentration tested (STEELE, 1962). Soaking cysts of *Heterodera glycines* in a 5% sucrose solution up to 96 hours did not reduce the viability of eggs and larvae inside the cysts. In soil mixed with 20% (w/w) sugar, larvae in cysts were not killed after 96 hours. Also, free larvae of *H. glycines* and specimens of *Pratylenchus* sp., *Xiphinema* sp. and saprozoic nematodes survived in this sugar-amended soil, although much less than in soil with 1% sugar (EPPS, 1963). *Pratylenchus penetrans*, *Rotylenchus robustus*, and *Tylenchorhynchus dubius* survived a 2 days' treatment with a 22 bar glucose solution, which killed *Trichodorus* and *Longidorus* spp. (WYSS, 1970).

Hatching of *Pratylenchus penetrans* eggs decreased with increasing concentrations of sodium and potassium chlorides and nitrates up to 0.6 M. A high proportion of eggs survived high osmotic pressures (up to 25 bar) for 12 days (THISTLETHWAYTE, 1969). Emergence of larvae from eggs and cysts of *Meloidogyne* and *Heterodera* spp. was reduced in solutions of various substances with high osmotic pressure. Damage to the unhatched larvae, however, hardly occurred (WALLACE, 1956; DROPKIN et al., 1958).

In most experiments, nematodes were placed directly in the test solutions and usually tolerated the high concentrations and osmotic pressures. In soil, most processes take place gradually, thus giving nematodes an adjustment period, so tolerance and survival in soil may be better under conditions comparable to those of solutions in experiments. Besides, high concentrations of chemicals in general are rare in moist soils.

Precise data on the osmotic pressure of nematodes are not available, but experiments with osmotic solutions have given some indications. BLAKE (1961) observed that the horizontal migration of L4 *Ditylenchus dipsaci* in sand was not influenced by replacing water with urea solutions up to 0.3 M (6.8 bar). However, mobility of *Tylenchorhynchus icarus* in sand and in vitro was reduced

if the liquid phase was a 0.1 M urea solution of 2.4 bar (WALLACE & GREET, 1964). Movement of *Rhabditis terrestris* in several inorganic chloride solutions ceased at osmotic pressures above 4.5 bar (STEPHENSON, 1944). No detectable inhibition of movement was observed for the following species after 24 hours treatment in NaCl solutions at the following osmotic pressures: *Trichodorus christiei* adults (4.48 bar), *Tylenchulus semipenetrans* and *Meloidogyne javanica* L2 larvae (8.96 bar), *Helicotylenchus erythrinae* adults (13.61 bar), *Tylenchorhynchus claytoni* adults (22.5 bar) (VAN GUNDY, 1965). Emergence of larvae from *Heterodera schachtii* cysts was almost completely inhibited in solutions containing a number of organic and inorganic substances when the concentrations were increased to 0.1 M (up to 4.5 bar) (WALLACE, 1956). Emergence of larvae from egg sacs of *Meloidogyne javanica* was greatly reduced in 12.5 bar solutions of sucrose, glycerol, glycine and urea. The hatch from free eggs was inhibited in glycerol at about 11 bar, whereas embryonic development stopped between 15 and 20 bar. The activity of L1 and L2 larvae inside the egg and of L2 larvae outside the egg was reduced in 0.3 M glycerol. The fact that L1 larvae maintained their activity longer than the unhatched L2 larvae, was attributed to lower permeability of the L1 egg shell (WALLACE, 1966). BAXTER and BLAKE (1969) assume from experiments with eggs of *Meloidogyne javanica* that the osmotic pressure of the extracellular fluid of the eggs is about 4 bar; the same value would hold for the pseudocoelomic fluid of the L2 larvae.

Recently the specific rates of penetration and release of radiolabeled chemicals and water have been measured by MARKS, THOMASON and CASTRO (1968). The experiments were carried out with ethylene dibromide (EDB), 1,2-dibromo-3-chloropropane (DBCP), water, glucose, sodium acetate, and glycine on *Aphelenchus avenae*, *Tylenchulus semipenetrans* (L2), *Anguina tritici* (L2), and a *Pellodera* species. It was found that water and nematicides were readily taken up and released. This was not the case with the other chemicals, thus giving strong evidence for selective intake or exchange mechanisms. Water penetration and release occurred at the same rate, but the rates as such were different for three nematode species tested. Rate of penetration of the nematicides was higher than the rate of release, causing a concentration increase in the nematode until equilibrium was reached. In subsequent experiments, this finding was confirmed for numerous chemicals, with internal concentrations varying from 16 to 0.7 times the external concentrations (CASTRO, THOMASON and BELD, 1970). In glucose solutions, which permeate slowly, the rate of water permeation in *Aphelenchus avenae* was not appreciably altered by osmotic pressure in the range from 0 to 26 bar. (THOMASON, CASTRO, BELSER and BELD, 1972).

The main phenomena observed for nematodes in solutions are:

1. The continuous transfer of water.
2. The selective intake of substances.
3. The rate of intake of water is equal to the rate of release.
4. The rate of intake of substances differs from the rate of release.

5. The rates of intake and release of substances vary, depending on the chemical composition.
6. The rates of intake and release of substances differ with nematode species and stage.
7. The tolerance to certain substances varies with nematode species and stage.
8. Different substances affect nematodes differently.

1.3. SOIL MOISTURE EFFECTS ON NEMATODES

There are several records correlating nematode populations and rainfall, irrigation, or soil moisture content in the literature, but few of these give experimental results. Most of them cannot easily be interpreted, because quantity and quality of soil moisture and other factors are usually not considered separately. The results for saturated soil, unsaturated soil and dry soil are reviewed separately, because these conditions affect nematode biology differently. Only the boundary between saturated and unsaturated soil can be indicated unequivocally if saturated soil is defined as soil in which all pores are filled with water. With relation to nematodes the boundary between unsaturated soil and dry soil is hard to describe accurately. If, for instance, loss of moisture by the nematode is taken as a criterion for drought, this may occur in wet soil at a high osmotic potential due to dissolved salts. In this thesis dry soil is defined as soil in which evaporative loss of moisture by the nematode predominates.

1.3.1. Saturated soil

Survival in saturated soil has been investigated for various species and the results suggest essential differences between species.

IMAMURA (1931) extracted nematodes from a paddy field before and after irrigation. The total number of nematodes decreased by about 50% after irrigation and *Tylenchus apapillatus* and *gracilis* decreased, whereas *T. filiformis* and *intermedius* increased in numbers. PERRY (1953) stated that *Dolichodoros heterocephalus* can live and thrive in water-saturated soil. *Paratylenchus amblycephalus* appears to be rather susceptible to a high soil moisture content, according to REUVER (1959).

JOHNSTON (1958) added *Tylenchorhynchus martini* and other nematodes to rice field soil in jars. Several moisture levels were established and survival was measured after 12, 22 and 32 days. Survival of all nematodes was lowest in very wet and dry soil. Susceptibility of the genus *Meloidogyne* to an excess of soil moisture has been reported by several authors. BROWN (1933) found that flooding for 12 to 22 months was required to achieve eradication; 4 months were sufficient to kill larvae but not eggs. THAMES & STONER (1953) observed that growing one irrigated rice crop resulted in good control of *M. incognita* on peat soil. RHOADES (1964) reported a decline of *M. incognita* and *M. javanica* after flooding. DAULTON and NUSBAUM (1962) found a more rapid reduction of

egg viability in saturated soil than in non-saturated soil upon inoculation of *Meloidogyne* eggs. Susceptibility of eggs in egg-masses to saturation of the soil was mentioned by PEACOCK (1957). After 7 months inundation with seawater of an area in the South-West of the Netherlands, *Heterodera schachtii* was not completely eradicated. Also cysts of *H. rostochiensis* still contained viable eggs and larvae after 15 months storage in tap-water (OOSTENBRINK, 1950).

OVERMAN (1965) experimented with sandy soil infested with several species of ectoparasitic nematodes. She concluded that flooding fallow soil reduced most ectoparasites to the same degree as *Meloidogyne* species; only *Hoplolaimus galeatus* and *Criconemoides curvatum* persisted in notable numbers. Flooding for 4 weeks appeared to give the most practical results. A double cycle of 2 weeks flooding plus 2 weeks drying was most effective at high temperatures, although *Trichodorus christiei* (now *Paratrichodorus minor*) and *Criconemoides curvatum* could replenish their populations on the succeeding crop. Survival in flooded soil was inversely correlated with temperature for all nematodes studied. FISHLER and WINCHESTER (1965) concluded from pot experiments with peat soil that a treatment of two weeks flooding + two weeks dry + two weeks flooding was as effective against *Meloidogyne incognita acrita* as 9 months continuous flooding. Constant flooding for 1 to 5 months gave the same results as unflooded fallow, but flooding for 1 year destroyed all nematodes.

Since nematodes are aquatic animals, excess of moisture as such cannot be expected to affect them directly. Damaging influences of submerged soil must be due to qualitative properties of the moisture. Saturated soil allows little oxygen to reach the soil organisms. The available oxygen is consumed by aerobic microorganisms which then become inactive or die. Decomposition of organic matter is taken over by facultative anaerobic and anaerobic microorganisms. For their respiration, oxidized substances and dissimilation products of organic matter are used as electron acceptors which causes chemical reduction of nitrates, manganese oxydes, iron oxydes, carbon dioxide, sulfates, organic acids, etc. Ammonium is one of the important dissimilation products, but organic acids may also accumulate, and methane will be formed by further metabolism. Carbon dioxide is liberated in several processes. Hydrogen is generated by anaerobic dissimilation of carbohydrates. Hydrogen sulfide may be formed if sulfates are present. Denitrifying bacteria may cause increased amounts of nitrogen (N_2) as well as nitrogen oxydes.

The course of these and other processes depends on many factors such as the type and amount of organic matter, microorganisms present, temperature, soil pH, redox potential, soil texture, inorganic substances, etc. (cf. BELL, 1969; VAN BREEMEN et al., 1967).

Lack of oxygen in saturated soil has been studied in relation to nematode survival. FELDMESSER and FEDER (1954) observed progressive reduction and eventual cessation of motility of *Aphelenchoides olesistus* (now *A. fragariae*), *Rhabditis* sp., *Heterodera rostochiensis* larvae and larvae of *Meloidogyne* sp. at decreasing O_2 concentrations in vitro. They found different rates of reaction for

different species. BOLANDER and FAULKNER (1969) studied survival of *Ditylenchus dipsaci* at various O₂ concentrations in vitro. Less than 10% survived 0.85 ppm O₂ at 15°C for 24 days, whereas 95% survived at 7.5 ppm O₂. An increase in temperature reduced survival markedly. *Criconemoides xenoplax*, *Hemicycliophora similis*, *Helicotylenchus* sp, and *Tylenchus* sp. persisted in flooded cranberry bogs for 2 years. Their numbers in experimental plots with hardly any plant growth were equal to those under normal culture. The measured oxygen concentrations varied from 1.75 to 6.75 ppm. Populations of *Criconemoides xenoplax*, *Hemicycliophora similis* and *Helicotylenchus* sp. in potted soil flooded for 145 days remained constant. The oxygen concentration was 6.8 ppm (BIRD & JENKINS, 1965). These oxygen concentrations are surprisingly high, because water in equilibrium with air contains 8.4 ppm oxygen at 25°C, but in rice fields the oxygen concentration 2 days after flooding is only about 0.1 ppm (VAN BREEMEN et al., 1967).

VAN GUNDY and STOLZY (1968) have reported related findings on the availability of oxygen. It has been demonstrated for a number of nematodes that oxygen is required for normal development. The rates of utilization depend on the physiological stage of the nematode and on the soil environment surrounding the nematode. Nematode growth and reproduction, behaviour, survival, and distribution were correlated with oxygen diffusion rates in artificial and natural soil environments by the above authors. One function of oxygen in nematode metabolism is the oxidation of lipids. Lipid storage and reduced metabolism enabled nematodes to survive in environments with a temporary lack of, or continuous low concentration of oxygen. Van Gundy and Stolzy also remarked in regards to population dynamics of a particular species that soil oxygen appears to determine the population limits rather than the individual life-span unless oxygen deficiency occurs for too long a period. The nematodes respond to critically low oxygen levels by becoming quiescent and return to activity when the oxygen level rises again. These conclusions are based on various experiments with several species (VAN GUNDY et al., 1962, 1963, 1964, 1967, 1968; STOLZY et al., 1960). Quantitative data on oxygen requirements were related to oxygen diffusion rates measured with platinum microelectrodes. COLLIS-GEORGE and WALLACE (1968) remarked that the oxygen diffusion rates measured in this way may overestimate the requirements for oxygen supply. They found a linear relationship between cumulative exposure to oxygen concentration and cumulative hatch of *Meloidogyne javanica* from egg sacs in vitro.

BRODIE and TOLER (1966) replaced the air in sterile soil with nitrogen and nitrogen plus hydrogen. Survival of larvae and eggs of *Meloidogyne incognita* after 28 days was the same as in aerated soil. If the air was replaced by carbon dioxide, the number of larvae was reduced to 50% after 7 days; this percentage was still the same after 28 days. Eggs survived in carbon dioxide treated soil and in untreated soil equally well. WALLACE (1968) noticed that *Meloidogyne javanica* larvae maintained their infectivity after 4 days without oxygen but prolonged treatment irreversibly inhibited subsequent activity. After 2 days without

O₂ subsequent hatching from eggs was markedly reduced. The rate of hatch also decreased if the O₂-CO₂ ratio decreased from atmospheric conditions to conditions with 5% O₂ and 15% CO₂, but there was no reduction in total hatch.

COOPER, VAN GUNDY and STOLZY (1970) reported that exposure to nitrogen for 12 hours every 3 days over a 30 day period decreased the population of *Hemicycliophora arenaria* in a tomato field to 20% of the untreated. N₂ exposure for 24 hours every 3 days inhibited the population by 94%. Similar exposures every 5 days decreased the population by 67% and 80%. These experiments indicate reduced nematode reproduction, which may be due to oxygen deficiency, rather than to intoxication by nitrogen.

Data showing that aeration increases nematode activity have been compiled by WALLACE (1963).

There is little doubt that the activity of many nematodes drops when the oxygen concentration decreases or when the concentration of carbon dioxide increases. Loss of activity may indirectly influence survival, but it is not clear how long nematodes can survive in complete absence of oxygen. This may vary with the species, stage of development, condition of the nematode, etc. Carbon dioxide does not seem toxic at normal levels. It may even be stimulatory at low concentrations (KLINGLER, 1959, 1961, 1963, 1965, 1972).

The inorganic substances in water-saturated soils consist of two groups of chemicals. The chemicals present at the onset of submergence will be diluted and their possible toxicity (see 1.3.2.) will decrease. The second group consists of substances liberated or formed under anaerobic conditions and their composition depends on the amount and type of organic matter and the microbiological processes. Osmotic effects are not experienced under these circumstances.

VASSALO (1967) found ammonia (NH₃) to be an effective nematicide at concentrations from 0.25% upward with a maximum efficiency at 1%. He attributed the nematicidal effect to the osmotic pressure generated by the ammonia (about 3 and 13 bar respectively). This, however, is doubtful since nematodes are generally not affected by osmotic pressures up to 10 bar and are usually not killed at higher pressures. WALKER and MAVRODINEANU (1967) obtained nematicidal effects with ammonia solutions that were about 10 times weaker. A 300 ppm (0.03%) solution killed 45% of *Pratylenchus penetrans* and a 800 ppm solution (0.08%) killed 95%.

RODRIGUEZ-KABANA, JORDAN and HOLLIS (1965) found that a decline of total nematode populations in flooded rice fields was correlated with an increase in concentration of hydrogen sulfide (H₂S) in the soil water. Laboratory tests showed that H₂S at concentrations found in flooded fields killed 100 percent of the nematodes in 5 to 10 days. Fluctuations of populations of total plant parasites and of *Tylenchorhynchus martini* and *Radopholus oryzae* (now *Hirschmanniella oryzae*) were the same as those for total nematodes. In vitro tests with hydrogen and natural gas containing methane showed that these gasses were harmless in the soil. Carbon dioxide caused a mortality of 20-30% in vitro, but in submerged rice fields, the highest concentrations of CO₂ occurred

some days after flooding when the nematode populations were high. Also lack of oxygen could not be responsible for a population decrease in rice fields, for a 2 week incubation period in oxygen-free water under nitrogen did not harm the nematodes. Laboratory assays by HOLLIS and JOHNSTON (1957) on *Tylenchorhynchus martini* revealed greater reductions of nematodes in saturated soil than in unsaturated moist soil, and also greater reductions in nonsterilized saturated soil than in sterilized saturated soil. The latter phenomenon was attributed to microorganisms. JOHNSTON (1957), working with the same nematodes, found the greatest reduction of nematode numbers in nonsterile saturated soil where oxygen was replaced by nitrogen. In soils adjusted to a moisture level of 50% of field capacity no reduction occurred. He also found that a *Clostridium* species produced a toxic principle that killed the nematodes. The bacterium, *Clostridium butyricum* PRAZMOWSKI (1880), produces large amounts of n-butyric, propionic, acetic, and formic acids under anaerobic conditions in pure culture when supplied with rapidly decomposable organic matter (JOHNSTON, 1958; cf. HOLLIS and RODRIGUEZ-KABANA, 1966). The effect of this bacterium on *Tylenchorhynchus martini* has been demonstrated in vitro. Adding cornmeal to soil increased the lethal effects of flooding against these nematodes. HOLLIS and RODRIGUEZ-KABANA (1966) reported a decline of *T. martini* due to the production of butyric and propionic acids in flooded cornmeal-amended soil in pots. They remark that these acids are also present under normal field conditions, but not in nematicidal quantities, and that the main acid in the field is acetic acid, which as such is not very toxic to nematodes. BANAGE and VISSER (1965) tested a *Dorylaimus* sp. in solutions of various organic acids. Formic, acetic, propionic, butyric and valeric acids at concentrations from 0.001 M to 1 M were toxic to the nematode proportionately to the dosage. A 0.0001 M solution did not affect the nematode. Formic acid was less toxic than the other acids at the same pH. Evidence was also obtained that the undissociated acid molecule was the chief toxic factor. These results may not be the same for tylenchid nematodes since dorylaimids appear to be more sensitive (cf. HOLLIS, 1961).

1.3.2. Unsaturated soil

In unsaturated soil, most large pores which contain nematodes are partly filled with water: there is a water-film on the soil particles and also where particles touch and in the small pores. This situation is favourable for nematode mobility (Wallace, 1963).

When water is removed from the soil system, the water film becomes very thin and the smaller pores will also be empty. The protracted shape of the nematode and its hydrophilic integument allow it to keep moist.

Movement and other activities of nematodes are directly related to moisture quantity. Active nematodes that do not find food consume their energy reserves and probably suffer from starvation sooner than inactive nematodes. Also the quality of the soil moisture, depending on various factors, may influence nematode activity and survival. Literature on the influence of soil moisture on

nematode survival in unsaturated soil often includes data which are difficult to evaluate or to compare, because the soil moisture conditions are described in general terms. Seasonal influences in sampling and extraction procedures may also introduce variables. BARKER (1968) not only found seasonal fluctuations in the density of various species, but also seasonal fluctuations in the efficiency of different extraction techniques. This efficiency may also vary with nematode species (BARKER, NUSBAUM and NELSON, 1969).

A literature survey about soil moisture effects in unsaturated soil is given below.

Tylenchorhynchus dubius and *Rotylenchus robustus* populations were only slightly affected by water loss down to the permanent wilting point for plants in a humic sandy soil (WYSS, 1970). The experiment lasted less than three weeks, which is short for studying the effect of soil moisture on nematodes. An inoculated population of *T. dubius* in moist sterile sandy soil lost about 6% of its logarithmic density each month when no host plants were present (SHARMA, 1971). In another experiment with *T. dubius* inoculated in sand, about 40% of the nematodes were still alive and active after 2 years. The fourth stage larvae and adult females survived better than the other stages (SHARMA, 1971). A field population of *T. dubius* in sandy soil on which pea had been grown, maintained its density at a high level throughout the autumn and winter and the populations from a field which was kept fallow for several years was reduced to about half its size in the first year and to a very low level in the second year, but was not completely eradicated in the following year (OOSTENBRINK, 1966).

NORTON (1959) found an increase in populations of *T. brevidens* and *Paratylenchus projectus* on wheat during periods of rainfall. Since nearly all individuals were juveniles it was assumed that they hatched from eggs present in the soil. Also MINTON, CAIRNS and SMITH (1960) found that the density of *Hoplolaimus tylenchiformis* in cotton fields rose after periods of rainfall, but this was not so for various other nematode species. PRASAD and JHA (1969) observed that submergence of the soil for two days increased the number of nematodes extracted, while after some days of drying the number of nematodes was reduced. KHAN, ADHAMI and SAXENA (1971) reported similar observations with populations of *Helicotylenchus erythrinae*, *Hoplolaimus indicus* and *Hemicriconemoides mangiferae* from mango orchards. Population densities were correlated with soil moisture content in the field, which was confirmed by pot experiments. High nematode populations in high soil moisture levels following periods of drought were explained by the hatch of eggs but definitely not by reactivation of nematodes paralysed by drought. This explanation is disputable (cf. 4.3.). In pots of fallow soil, *Tylenchorhynchus brevidens* disappeared after three months if the moisture content was kept near field capacity (24% moisture). Survival was better if the moisture content was continuously kept at 60% of field capacity, or alternated between low and 60% of field capacity. The best survival (50% after 9 months) occurred in continuously dry soil, i.e. 2.4% moisture (MEAGHER, 1970). JOHNSTON (1958) stored rice field soil at adjusted soil moisture conditions in closed jars for 32 days. Survival of *Tylenchorhynchus martini* was best in soil

between 40% and 60% of field capacity. The lowest survival was found in very wet and in fairly dry soil.

A field population of *Rotylenchus robustus* maintained its density at about the same level for over 1 year whether a pea crop was grown or not. A *R. robustus* population in a fallow sandy peat soil was reduced to 50% in the third year and to a very low level in the fourth year, but was not eradicated in the following 2 years. Also populations of *Tylenchorhynchus dubius* and *Pratylenchus crenatus*, which decreased at different rates during the first 4 years, had not completely disappeared after 6 years. Other data showed that the densities of *R. robustus* and *T. dubius* hardly had changed after 7 years of fallow in which *P. crenatus* was reduced to 5% (OOSTENBRINK, 1966). After storage in moist soil in closed jars for 4½ years, pre-adults of *Paratylenchus projectus* and females of *P. dianthus* were still living (RHOADES and LINFORD, 1961). Population buildup of *Xiphinema americanum* was limited by soil moisture (WARD, 1960; GRIFFIN and BARKER, 1966). *Xiphinema index* died out after 9 to 10 months in moist sterile soil without food. They persisted for at least 5 years when old roots were present (RASKI et al., 1965). *Trichodorus* species seem to be rather sensitive to soil moisture conditions (WYSS, 1970; RÖSSNER, 1971). Populations of *Pratylenchus brachyurus* in cotton fields were not correlated with rainfall data (MINTON, CAIRNS and SMITH, 1960). *Pratylenchus minyus* kept in fallow soil in pots disappeared after 1 month if the soil was kept at field capacity. If the soil was kept at 60% of field capacity or alternately dried and wetted, 20% of the population was still present after 15 months (MEAGHER, 1970). In a 40 days' trial, *Pratylenchus* inoculated in soil showed better survival as moisture tensions increased from pF 0 to pF 4.2 (KABLE and MAI, 1968). *Radopholus similis* survived in fallow soil for at least 6 months, although their number was greatly reduced (HANNON, 1963). With *Meloidogyne javanica*, GODFREY, OLIVEIRA and GITTEL (1933) stated that egg-masses were killed after 40 weeks in soil at field capacity, and according to MARTIN (1967) *M. javanica* persisted in fallow soil for longer than 4 years under natural climatic conditions. After two years the infestation of the soil was still high.

The data on survival, even for the same species, vary considerably. They leave little doubt however, that nematodes generally can survive in moist soil for rather long periods. In some cases only particular stages survive well. It is still unknown whether differences in survival can directly be attributed to differences in the quantity of soil moisture as such. Various qualitative aspects of the soil solution must be important, as appears from the following data on the influence of oxygen and carbon dioxide, organic matter and inorganic compounds in the soil water.

The availability of oxygen in the soil depends on its use by plants and soil organisms and gas exchange with the atmosphere which is affected by the moisture content of the soil. The significance of oxygen to nematodes as described for saturated soil also applies to unsaturated soil, but complete absence of oxygen rarely occurs. Reduced availability of oxygen, however, may have an

influence. The significance of soil moisture, aeration and also temperature on aging of nematodes has been indicated by VAN GUNDY, BIRD and WALLACE (1967). Stored food reserves in the body of *Meloidogyne javanica* are used up rapidly at high temperatures, in relatively dry soils, and in oxygenated solutions. Conversely, body contents are conserved at low temperatures, in wet soils, and in solutions with low oxygen concentrations. Relatively dry soil here is sand at pF 1.7! Differences exist between species. *Meloidogyne javanica* larvae have a higher respiration rate than *Tylenchulus semipenetrans* larvae, and the latter species is mobile and infective for a longer time than *M. javanica*.

Carbon dioxide concentrations in soil may vary from 0.5% to 11%, and the amount dissolved in the soil solution will be proportional. High concentrations reduce nematode activity, but there is no proof that CO₂ is toxic at any concentration found in soil (GILLARD et al., 1958; KÄMPFE, 1959; SPECHT and WALKER, 1969).

Organic matter also influences nematode populations in aerated soil. By mineralization, nitrogen in organic compounds becomes converted into inorganic nitrogen. Soil microorganisms first produce ammonia that becomes oxidized to nitrites and nitrates. The oxidation process depends on the oxygen supply of the soil. Nitrite oxidation goes quicker than ammonium oxidation, so in general the level of nitrite nitrogen is low in comparison with ammonium and nitrate nitrogen. Nevertheless nitrites can accumulate if the concentration of free ammonia becomes high by the addition of heavy dressings of ammonium fertilizers on soils with a high pH. Soil moisture has a considerable influence on nitrification. During the dry season, nitrate accumulates in the surface layers of tropical and subtropical soils, although there is still doubt about the causes (RUSSELL, 1961). On the other hand denitrification, by which nitrogen (N₂), nitrous oxide (N₂O), and nitrogen dioxide (NO₂) are formed, may also occur (NELSON and BREMNER, 1970). There is good evidence that soil organic matter, especially readily decomposable material, reduces the population of plant nematodes. Most of the literature has been compiled by SAYRE (1971) and his findings and some others can be summarized as follows: most investigations utilized excessively large quantities of organic materials and this has not been generally adopted in practice with the particular aim to control plant parasitic nematodes. Explanations given for the possible mechanisms involved in the partial control of nematodes are:

- a. the products from decomposing organic amendments are directly toxic to plant parasitic nematodes;
- b. microbivorous nematodes rapidly reproduce and their increase stimulates a wide array of natural enemies which then also attack plant parasitic nematodes;
- c. nematode enemies are directly favoured by the organic substances on which they may feed facultatively.
- d. changes in the physical and chemical condition of the soil may alter the host-nematode relationship;

e. increased resistance of the host plant, induced by the organic materials or decomposition products.

Organic soil amendments may also reduce damage to crops by nematodes owing to more rapid root growth by improved soil conditions.

Many investigators perceived the suppression of plant parasitic nematodes and postulated the causes without proving the significance of each, but VAN DER LAAN (1956) found that *Heterodera rostochiensis* larvae in roots of potato plants treated with organic matter developed significantly slowly compared to those in roots of plants treated with fertilizer or untreated plants. This could point to physiological changes in the plant, resulting in a slight resistance. SAYRE et al. (1964, 1965) obtained extracts from plant residues decomposing in soil which were nematocidal between pH 4.0 and 5.3 to two tested plant parasites, but not to saprozoic nematodes. They proved that one of the nematocidal compounds of the extracts was butyric acid.

WALKER (1969) carried out comparative experiments with *Pratylenchus penetrans* in order to demonstrate the necessity of microbial activity for the effectiveness of organic soil amendments. Addition of 1% (w/w) nonsterile soybean meal to sterilized sandy loam gave a significant decrease in the number of nematodes. Sterilized soybean meal plus selected microorganisms added to sterile soil gave similar results. Sterile soil with sterile soybean meal had no effect. Other nitrogenous compounds like KNO_2 , $\text{Ca}(\text{NO}_3)_2$, NH_4NO_3 , $(\text{NH}_4)_2\text{CO}_3$, urea and peptone decreased populations with variable effectiveness. KNO_2 being the most nematocidal. In other experiments WALKER (1971) compared the effectiveness of nitrates, nitrites, organic nitrogen or ammonium compounds against *Pratylenchus penetrans*. Nitrate was less effective than other nitrogen compounds. Nitrite was most effective. Carbon dioxide and nitrogen concentrations were proven not to be responsible for the population reductions. Also ethylene and methane were excluded, but ammoniacal nitrogen concentrations were directly correlated with nematode populations. A normal field application of anhydrous ammonia gave good control of nematodes, especially in the area close to the place of injection (ENO, BLUE and GOOD, 1955).

Inorganic compounds available in the soil or added as fertilizer may reach high concentrations in dry soil, but they can hardly be expected to have a determining influence on nematode populations in moist soils. Few experimental results are available on this subject. Moreover, most studies deal with the effect of added inorganic material on nematode populations on a growing host crop, by which the direct influence of the added compound remains unknown. UPADHYA (1969) observed large reductions of a great number of plant parasitic and saprozoic nematodes in unplanted soil after addition of inorganic fertilizers. This author rejected the possibility of osmotic effects, but the applied amount of 14 g potassium sulphate (48% K_2SO_4) per kg of sandy soil will cause an osmotic pressure of about 18 bar at a moisture content of 15% by weight.

A high potassium compound fertilizer (NPK 9-4-15) reduced the number of

Heterodera schachtii cysts on beet and the same effect was induced by potassium chloride (CURTIS, 1964). On the contrary development of *Meloidogyne incognita* on cucumber increased at high levels of potassium. In the same study by MARKS and SAYRE (1964) *Meloidogyne javanica* and *M. hapla* were not influenced by potassium. ELLENBY and GILBERT (1958) observed depressed hatching of *Heterodera rostochiensis* if chlorides of monovalent ions were added to a hatching factor solution, whereas chlorides of divalent ions caused increased hatching. CLARKE and SHEPHERD (1966) investigated the influence of a great number of inorganic ions on the hatching of nine species of *Heterodera*. In general there was a selective response by the various species to particular ions. For instance Cd^{2+} was very active in hatching *H. schachtii* and *H. tabacum*, slightly active for *H. goettingiana*, *H. carotae* and *H. rostochiensis*, but inactive or inhibitory for the other species. Zn^{2+} stimulated hatching of 7 species. The more abundant ions in the soil, such as K^+ , Na^+ , Mg^{2+} and Fe^{3+} , were not more active than other ions. KRADEL (1959) could not demonstrate an influence of manganese, borium, copper, molybdenum and zinc on the development of *Heterodera rostochiensis* on potatoes. Cu^{2+} ions in aqueous suspensions of *Trichodorus pachydermus* were toxic to this species, but no negative effects were observed in soil (HAFKENSCHIED, 1972). Calcium gifts to the soil generally do not seem to affect the cysts of *Heterodera* species (DECKER, 1969), but addition of calcium hydroxyde to sandy alkaline soils with a high pH (> 7) was found to reduce populations of *Pratylenchus*, *Trichodorus*, *Hemicycliophora* and others (KUIPER and DE LEEUW, 1963). Here also eggs and larvae in cysts were not affected. In acids soils, the compound had no effect. Also calcium cyanide has been used against nematodes with varying success (cf. DECKER, 1969). DE GROOTE (1960) attributed the nematicidal effect of this compound to the technical impurities and the formation of ammonium carbonate.

Nematicidal soil disinfectants usually effect nematodes via the soil solution, but since such toxic materials are not normal components of the soil solution, they are not considered here.

1.3.3. Dry soil

In saturated or nearly saturated soil, survival of nematodes is probably only indirectly affected by the quantity of soil moisture, whereas in periodically dry soil the amount of moisture may directly influence survival. In saturated soil there is continuously a transfer of water into and out of the nematodes (cf. 1.2.) The amount of water inside the nematode will not decrease as long as the osmotic pressure of the soil solution remains lower than that of the nematode's pseudocoelomic fluid. Nematodes exposed to air not saturated with water vapour loose moisture and become inactive. In soil the so-called free energy of the water determines whether desiccation occurs. If the soil suction increases, an increasingly greater part of the nematode will be exposed to the soil air, although probably not directly, because a water film may be present around the nematode. The presence of a thin film of water will depend on the physico-chemical properties or the chemical potential of the boundary layer of the nematode body.

BIRD (1971) compiled the literature on this subject and cited several indications for the existence of a lipid layer with a thickness of some tens of millimicrons, which could be present on all nematodes. BIRD (1957) has demonstrated the presence of such a layer on *Ascaris lumbricoides*. A lipid layer is hydrophobic, which conflicts with observations that nematodes are very easily wetted. The latter fact may be due to hydrophilic (ionic) substances in the lipid layer which bond water molecules, resulting in a moistening layer around the nematode. Transfer of water may occur via this water film. Loss of moisture due to predominant release will depend on the difference between moisture potentials inside and outside the nematode. If the moisture potential inside the nematode is mainly determined by substances dissolved in the pseudocoelomic fluid, a value corresponding to 4 bar is probable (cf. 1.2.). Analyses on *Ascaris* species have demonstrated the presence of inorganic ions, predominantly sodium, potassium, calcium, magnesium and chloride, besides proteins, carbohydrates, etc. (FAIRBAIRN, 1960). The moisture potential outside the nematode is determined by different soil factors. In relation to the release of water by nematodes, soil solution and soil air are considered separately.

The factors influencing the total moisture potential of the soil solution in contact with nematodes are summarized below.

a. Capillary forces. The concave surface of the fluid between the nematode body and the soil particles produces a potential, which depends on the radii of the curvature, according to the equation:

$$p = \sigma \left(\frac{1}{r_1} + \frac{1}{r_2} \right)$$

in which p = potential (dynes. cm^{-2}), σ = surface tension (dynes. cm^{-1}), r_1 and r_2 = radii of the curvature (cm) respectively perpendicular and parallel to the longitudinal axis of the nematode. The influence of r_2 can be neglected, because its value is very great in comparison with r_1 or even indefinite for a straight nematode. For $r_1 = 1 \mu$, $r_2 = \infty$ and $\sigma = 72$ dynes. cm^{-1} , the moisture potential corresponds to about 0.72 bar. The maximum value will not exceed about 1 bar.

b. Osmotic potential due to dissolved salts. Unless chemicals are added to the soil, the salt concentration is about 0.02 N at field capacity (pF 2 in a sandy soil). Assuming the average activity coefficient of the salts to be 0.7, the corresponding osmotic pressure is about 0.85 bar. If at pF 4, the amount of soil moisture would have been reduced to one third, the osmotic pressure will be about 2.5 bar.

c. The osmotic potential in the double layer of the soil particles due to the presence of exchangeable ions. This potential may become very high.

At total soil moisture potentials corresponding to pF' values greater than 3.6 (4 bar) the nematode will loose water and its osmotic potential will increase. At the same time there is the possibility of ion uptake from the soil solution at the points of contact.

In a drying soil, an increasingly greater part of the nematode will be exposed

to the soil atmosphere, of which the relative humidity is related to the pF' value of the soil. (cf. 1.1.). At relative humidities below 100%, the nematode could lose water to the atmosphere, but the presence of substances dissolved in the pseudocoelomic fluid of the nematode will reduce the release of water. If the osmotic pressure of 4 bar again is taken as a measure of the moisture potential inside the nematode, loss of water to the soil air will occur at relative humidities below 99.7% (pF' 3.6) at 20°C.

Regarding the transfer of water between nematodes and soil air it should be noted that temperature also influences the relative humidity. Relative humidity (r.h.) is the ratio of the pressure of water vapour present (P) to the pressure of saturated water vapour (P_s) at the same temperature. In formula:

$$\text{r.h.} = \frac{P}{P_s} \cdot 100$$

The relationship between temperature (t) and pressure of saturated water vapour (P_s) between 15° and 25°C is:

$$\log P_s = 0.026t + 0.72$$

(P_s in mm Hg, t in °C; STAKMAN, 1968).

If at a lower temperature the saturated water vapour (P_s) becomes equal to the existing water vapour, condensation occurs. The necessary lowering of the temperature (Δt) that causes condensation can be calculated with the equation:

$$\Delta t = 10^{pF' - 4.9} \text{ (at } 20^\circ\text{C)}$$

(after STAKMAN, 1968). At pF' 4 a lowering of the temperature by 0.126°C causes condensation and this will stop water loss by the nematode or even allow water intake. A desiccated nematode with increased moisture potential may even take up water when the temperature falls only slightly and the relative humidity rises. Similarly a rise of temperature will result in a lower relative humidity and an increased desiccation of the nematode. The dynamics of these processes depend on the speed of the nematode. The dynamics of these temperature fluctuations may cause alternately desiccation and remoistening of the nematode.

The phenomena mentioned above have been related to single nematodes and not to populations, because moisture potentials in soil may differ even at short distances, especially if the moisture situation is not constant. Also the effect of temperature fluctuations may vary due to differences in thermal conduction in the soil. Accurate calculations would also require more information on the nematode's pseudocoelomic fluid and the function and properties of the cuticle and epidermis.

Continued drying of the soil will bring about an increased desiccation of the nematodes, which may cause death or anhydrobiosis eventually followed by

death or resuscitation upon rewetting. Some nematode species are known to survive dry conditions for a long time. There are remarkable records on some plant parasites. *Tylenchus polyhypnus* revived after 39 years (STEINER and ALBIN, 1946), *Anguina tritici* after 28 years, *Ditylenchus dipsaci* after 23 years and *Tylenchus balsamophilus* after 24 years (FIELDING, 1951). Also *Aphelenchoides ritzemabosi*, *Ditylenchus myceliophagus*, *Anguina agrostis* and *Heterodera rostochiensis* are known to withstand drought very well. In general only one of the developmental stages can resist desiccation. Most of these species survive inside plant material, but there are also several records on desiccation survival of plant parasites in soil. A number of these data have been compiled in table 1.

TABLE 1. Survival of various nematodes in dry soil

Species	Duration of drought	Survival	Remarks	Reference
<i>Tylenchorhynchus dubius</i>	3 weeks	85%		Wyss (1970)
<i>T. dubius</i>	6 weeks	0%	soil in plastic bags	Sharma (1971)
<i>T. brevidens</i>	9 months	50%		Meagher (1970)
<i>T. brevidens</i>	15 months	some		Meagher (1970)
<i>T. claytoni</i>	6 weeks	some		McGlohan et al. (1962)
<i>Rotylenchus robustus</i>	3 weeks	< 10%		Wyss (1970)
<i>R. robustus</i>	13 weeks	some		Rössner (1971)
<i>Helicotylenchus nannus</i>	7 months	some		McGlohan et al. (1962)
<i>H. nannus</i>	1 year	some		Radewald & Takeshita (1964)
<i>Hoplolaimus tylenchiformis</i>	2 days	0%		McGlohan et al. (1962)
<i>H. columbus</i>	1 year	some	adults & pre-adults	Fassuliotis (1972)
<i>Paratylenchus projectus</i>	2 weeks	many	pre-adults & larvae	Rhoades & Linford (1961)
<i>P. projectus</i>	8 weeks	some	pre-adults	Rhoades & Linford (1961)
<i>P. projectus</i>	2 days	0%		McGlohan et al. (1962)
<i>P. amblycephalus</i>	?	0%		Reuver (1959)
<i>P. minutus</i>	4 months	0%		Radewald & Takeshita (1964)
<i>Pratylenchus penetrans</i>	3 weeks	40%		Wyss (1970)
<i>P. penetrans</i>	13 weeks	some		Rössner (1971)
<i>P. penetrans</i>	12 days	14-22%	pF 5.0	Kable & Mai (1968)
<i>P. penetrans</i>	6 weeks	30-65%	pF 4.2	Kable & Mai (1968)

TABLE 1. Continued

Species	Duration of drought	Survival	Remarks	Reference
<i>P. brachyurus</i>	6 days	100%	1.2 hrs/day t > 39°C	Feldmesser & Rebois (1965)
<i>P. brachyurus</i>	6 days	5%	2.8 hrs/day t > 39°C	Feldmesser & Rebois (1965)
<i>P. brachyurus</i>	5 weeks	25-50%	0.6-1.2 hrs/day t > 43°C	Feldmesser & Rebois (1965)
<i>P. brachyurus</i>	4 months	0%		Radewald & Takeshita (1964)
<i>P. minyus</i>	13 months	40%		Meagher (1970)
<i>Radopholus similis</i>	27 hours	some	12 hrs/38°C	Feldmesser & Feder (1957)
<i>Rotylenchulus reniformis</i>	7 months	some	air-dry soil	Birchfield & Martin (1967)
<i>Heterodera avenae</i>	13 months	good	eggs & larvae in cysts	Meagher (1970)
<i>H. avenae</i>	6 months	0%	eggs & larvae in cysts	Duggan (1960)
<i>Meloidogyne javanica</i>	20 weeks	some	larvae & eggs	Godfrey et al. (1933)
<i>M. javanica</i>	16-20 weeks	some	larvae & eggs (stirred soil)	Godfrey et al. (1933)
<i>M. incognita acrita</i>	4 months	0%		Radewald & Takeshita (1964)
<i>M. species</i>	5 days	0%	rapidly dried soil	Peacock (1957)

The data in table 1 cannot be compared, but it appears that apart from the parasites of aerial plant tissues and cystforming *Heterodera*'s, that have an apparent protective mechanism, some nematodes can survive desiccation for considerable periods of time. More evidence is given by ORR and NEWTON (1971), who recovered 28 nematode genera from dust that had been collected in traps two meters above the ground. Among them were the plant parasitic genera: *Aphelenchus*, *Aphelenchoides*, *Criconemoides*, *Ditylenchus*, *Helicotylenchus*, *Longidorella*, *Meloidogyne*, *Neotylenchus*, *Pratylenchus*, *Psilenchus*, *Tetylenchus*, *Tylenchorhynchus* and *Tylenchus*. Also KRŃJAIĆ and KRŃJAIĆ (1970) found various species with a similar method.

Thus there are reasons for suspicion regarding the general assumption that few species of nematodes are able to survive desiccation. Hardly any species can survive when subjected to desiccation on a glass slide in the laboratory, but this treatment is unrealistic. In soil, the process of drying takes place gradually and nematodes obviously adapt themselves to a decreasing amount of moisture.

1.4. SCOPE OF THE INVESTIGATIONS

This study deals with the effect of soil moisture on the survival of ectoparasitic root-infesting nematodes in fallow soil as determined under laboratory conditions. Three essentially differing situations can be distinguished.

- a. Water-saturated soil. This condition is known to reduce nematode populations by predominantly microbiological processes. Few experiments are made on this aspect.
- b. Unsaturated moist soil. Little is known about the direct influence of moisture quantities on survival under these conditions or on the effect of additions to the soil.
- c. Dry soil. Severe drought is unfavourable to the group of nematodes concerned, but precise data on the significance of the degree of desiccation, the duration, differences between species or stages of development, the influence of fertilizer, etc. are poorly known.

The greater part of the experiments is carried out with two species of ectoparasitic nematodes, i.e. *Tylenchorhynchus dubius* and *Rotylenchus robustus*, whereas various other species are tested in general investigations.

Increased knowledge about the influence of soil moisture regimes on nematode survival may result in methods of nematode control in combination with agricultural practices which are already widely used, such as dry fallow, irrigation and manuring of the soil.

2. MATERIALS AND METHODS

General materials and methods are described here while special techniques are cited under the corresponding experiments.

2.1. NEMATODES

2.1.1. *Specimens for experiments*

All experiments with soil were carried out with indigenous nematode populations. Soil without plants was stored at room temperature from 1.5 to 2 months prior to experimentation unless otherwise mentioned. This avoided complications for the interpretation of experimental results, since populations generally decline strongest shortly after the removal of host plants, and such decline may overshadow possible population changes resulting from the effect of soil factors studied.

The main ectoparasitic nematodes present in the experimental soils and considered in the experiments, are cited in table 2.

TABLE 2. The main indigenous species of ectoparasitic nematodes present in the experimental soils

Soil	Nematode species
Tarthorst	<i>Tylenchorhynchus dubius</i> , <i>T. maximus</i> , <i>T. ornatus</i> , <i>T. tessellatus</i> , <i>Helicotylenchus pseudorobustus</i> , <i>Paratylenchus f.</i> , <i>Criconemoides spp.</i>
Westberg	<i>Helicotylenchus pseudorobustus</i> , <i>Paratylenchus f.</i> , <i>P. microdorus</i> .
Dijkgraaf	<i>Tylenchorhynchus nothus</i> , <i>Rotylenchus robustus</i> .
Rijnsteeg	<i>Tylenchorhynchus quadrifer</i> , <i>Helicotylenchus pseudorobustus</i> , <i>H. varicaudatus</i> , <i>Paratylenchus f.</i> , <i>P. microdorus</i> .
Ellecom	<i>Tylenchorhynchus dubius</i> .
PD (a)	<i>Tylenchorhynchus dubius</i> , <i>Rotylenchus robustus</i> .
PD (b)	<i>Rotylenchus robustus</i> .

2.1.2. *Extraction from soil*

Dry soil was wetted without disturbing the structure and then stored for 1 to 3 days prior to extraction. This is an essential modification of the normal extraction methods which proved to be necessary and which was introduced after extensive experimentation (cf. 4.1.). Moist soil that served as a reference received the same treatment.

Two extraction methods were used.

1. Elutriation according to the method of OOSTENBRINK (1960). This method was used in the general investigations only. The technique is based on the difference between settling speed of soil particles and nematodes. Soil with nema-

todes is washed into the upper part of an elutriator, in which water rises at an adjustable speed. Heavy soil particles settle to the bottom of the apparatus and the risen water with nematodes and fine soil particles pours out onto 4 piled sieves with 44 μ mesh. Nematodes and other residues are washed from the sieves and the suspension is cleaned by pouring it over a double cottonwool filter, supported by a course sieve, placed in a shallow tray with water. The nematodes creep through the filters and are collected from the tray in 24 hours or later.

2. A slight modification of the cottonwool filter method (OOSTENBRINK, 1960), referred to as decantation. Wet soil (50 g or less) is placed into a 2 l can; 600 ml of water is added; the suspension is stirred for 10 seconds and decanted into a container 5 seconds later. The procedure of adding water, stirring and decanting is repeated two more times. The collected suspension is poured on 4 sieves of 44 μ mesh. Further extraction proceeds as with the elutriation method.

In all but the general investigations, the final step of the extraction procedure, when the nematodes had to pass through the cottonwool filters, lasted five days instead of one so that nematodes that were not very active had ample opportunity to pass through the filters.

2.1.3. Enumeration of extracted populations

Initial populations in experiments with soil were determined after all pre-treatments were carried out.

As a rule all extracted nematodes were counted instead of samples from a suspension. This reduced variation since in many cases various stages of development were analysed which would increase variation. This often necessitated working with small amounts of soil containing less than 600 specimens of the investigated species. Since no plants are grown, 25 or 50 g of soil was adequate. It required thoroughly mixing the soil prior to experimentation, and this resulted in low coefficients of variation for the initial populations (< 5%).

Analysis of duplicate aliquots from nematode suspensions to determine the size of the population was performed in the general investigations. The size of the aliquots depended on nematode density in a 25 ml water suspension as given below.

Number of nematodes per ml	aliquots taken
> 100	2.5 ml from a 25 ml suspension
60-100	5 ml from a 25 ml suspension
30- 60	2 ml from a 10 ml suspension
< 30	5 ml from a 5 ml suspension

At densities below 60 nematodes per ml from a 25 ml suspension, the water was reduced to 10 or 5 ml. Aliquots were pipetted from the centre of a hand-shaken suspension into the lid of a plastic Cooper tissue culture dish with an appropriate rectangular grid to facilitate counting. This was done under a dissecting microscope at 50 times magnification.

2.1.4. Statistical analyses of nematode numbers

Numbers of nematodes were usually analysed after transformation to 10-logarithms. Percentages were analysed after angular transformation (angle = $\arcsin \sqrt{\frac{\text{percentage}}{100}}$). The common statistical methods, such as the analysis of variance, Tukey's multiple range test, Kendall's rank correlation test, regression and correlation tests, were used.

Significance of differences was indicated at the 0.05 level of probability.

2.2. SOILS

2.2.1. Natural soils selected for experiments

Data on the soils used have been summarized in table 3. The moisture characteristics are given in figure 6. The curves have been determined on the soils, which were sieved and slightly compressed like in the experiments and having been started from water-saturated soil (desorption curves). Soil moisture is expressed in percentages by weight for practical reasons; moisture content is determined gravimetrically. In the experiments, moisture contents were at any rate determined at the evaluation time of the nematode populations.

Grams of soil refer to grams of oven-dry (105°C) soil, unless mentioned otherwise.

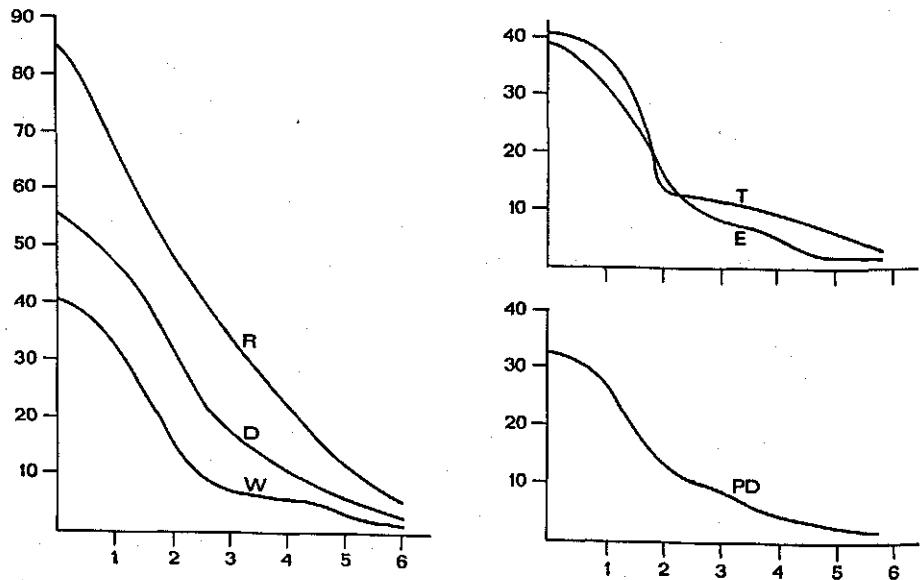

FIG. 6. Moisture characteristics of six soils used for experimentation. T = Tarthorst soil, E = Ellecom soil, PD = PD soil, R = Rijnsteeg soil, D = Dijkgraaf soil, W = Westberg soil. Abscissae: pF value.

Ordinates: soil moisture content (% by weight).

TABLE 3. Data on the soils used for experiments

Soil	Origin	Bulk density (g. cm ⁻³)	Organic matter (%)	pH KCl	CaCO ₂ (%)	Granular composition (%)					
						> 400 μ	200-400	100-200	50-100	2-50	< 2 μ
Tarthorst	former sports field	1.04	2.9	6.4	0.1	18	34	21	10	13	4
Westberg	natural lawn under trees	1.14	1.7	3.8	0	15	40	20	7	13	5
Dijkgraaf	kitchen garden	0.91	5.1	5.4	0	12	30	24	10	18	6
Rijnsteeg	meadow	0.72	6.5	4.6	0	10	22	12	7	29	20
Ellecom	experimental field (grass)	1.05	1.2	6.5	0	7	16	22	26	23	6
PD	a) experimental crop rotation field (grass)	1.16	2.2	5.7	0.1	15	35	29	7	9	5
PD	b) experimental field (weeds)										

2.2.2. *Soil treatment prior to experimentation*

In all experiments, soil from the original location was sieved through a 3 mm sieve to remove stones and roots and thoroughly mixed. Consequently, bulk density values are lower than those for the soils in the field, even after they have been recompressed.

In experiments where the amount of soil moisture was kept at a fixed predetermined level, the moisture content usually had to be adjusted. If the soil had to be wetted, demineralized water was used. To obtain saturated and near saturated soil, the required amount of soil was put into the containers used in the experiment and compressed to the required bulk density. Then the calculated amount of water was added extremely slowly so that any air could escape. If unsaturated soil had to be wetted, a small amount of water was added carefully to the thinly spreaded soil with a mistifier and mixed. This procedure was repeated until the required amount of water had been added. The soil was then covered and stored for some hours. When it was necessary to remove a small amount of water, the soil was spread out and remixed at varying times.

Extensive tests showed these techniques to be satisfactory in obtaining the required moisture content. However, these techniques do not allow for very accurate pF values and those values mentioned indicate a certain limited range, which is no objection because subtle differences are not studied.

2.3. DESICCATION OF NEMATODES IN VITRO

For the desiccation experiments in vitro (chapter 5) two principles are applied. The first is the relationship between pF' and relative humidity (see 1.1.), the second is the relationship between relative humidity and the concentration of aqueous glycerine solutions in a closed container. This relationship is presented in figure 8. To effect these principles for experiments with nematodes, a humidity chamber was designed that allows quick handling. The humidity chamber (fig. 7) consists of a heavy glass jar (1), which is almost completely filled with water or a water-glycerine solution, and a perspex ring (2) with a bridge for glass-slides (3). The two bridge openings in the ring (4) are closed with rubber stoppers (5). A groove (6) in the bottom of the ring, filled with synthetic modelling-clay, ensures gas-tight fitting of ring and jar and makes separation simple in case of solution renewal. The thick plan-parallel perspex lid (7) is sealed onto the ring also with synthetic clay.

Although the use of water-glycerine mixture ensures relative humidities which are almost independent of the temperature between 10°C and 30°C, a quick change of the temperature will nevertheless cause a temporary change of the existing humidity. To avoid this, the humidity chambers were placed in an incubator with a constant temperature of 20°C ± 0.5. The slight fluctuations of the temperature occurred very gradually.

Various desiccation techniques were applied, all accomplishing gradual desiccation of nematodes.

1. *Glass slide desiccation technique*

A number of humidity chambers were filled with aqueous glycerine solutions in a range based on equably increasing pF' values (see table 4). The nematodes to be tested were collected in a drop of de-ionized water on a glass cavity slide. The water was removed with a micropipette and the slide placed immediately into chamber no 1 containing water. The relative humidity in this chamber was 100% or a little lower and this first step conditioned the nematodes to the process of desiccation. After a certain period of time the nematodes were transferred to chamber 2 at 97.7% r.h. (pF' 4.5) and so on to the required final humidity.

2. *Membrane filter desiccation technique*

Instead of putting the nematodes on a glass slide, a membrane filter (cellulose nitrate, pore size 3μ) can be used. With a micropipette the nematodes in a small amount of water were brought onto the filter. The water was directly removed

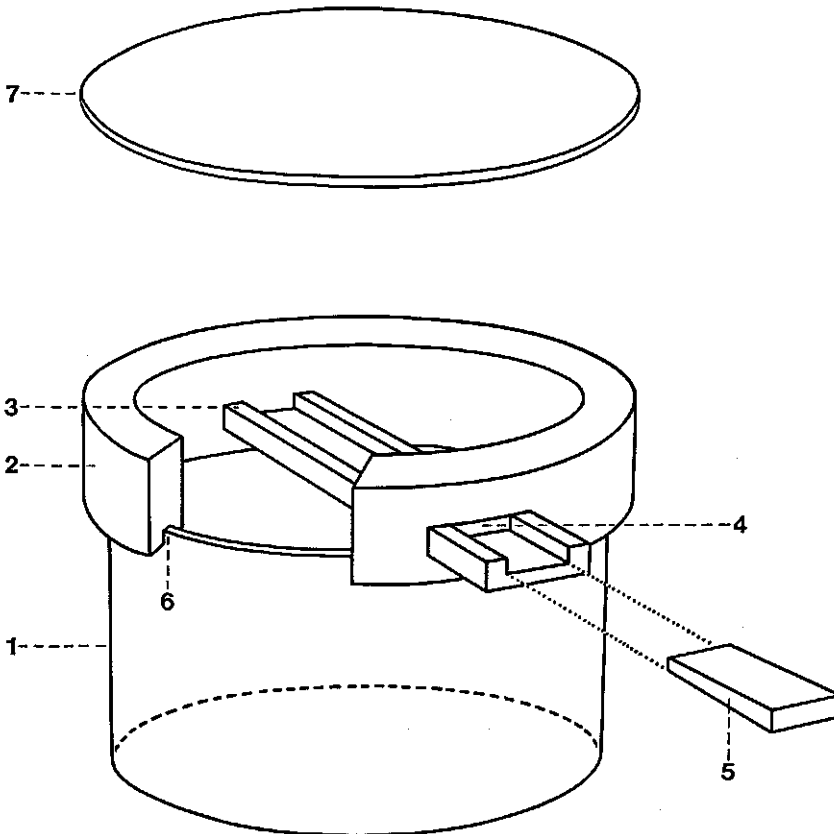

FIG. 7. Constant humidity chamber for desiccation of nematodes (for explanation of the figures is referred to the text of par. 2.3.).

TABLE 4. Range of aqueous glycerine solutions with corresponding relative humidities (r.h.) and pF' values at 20°C used in desiccation experiments

No.	density water-glycerine mixture	r.h. (%)	pF'
1	0.998 (water)	100-99	
2	1.030	97.7	4.50
3	1.046	96.0	4.75
4	1.066	93.0	5.00
5	1.099	87.9	5.25
6	1.132	79.5	5.50
7	1.186	66.5	5.75

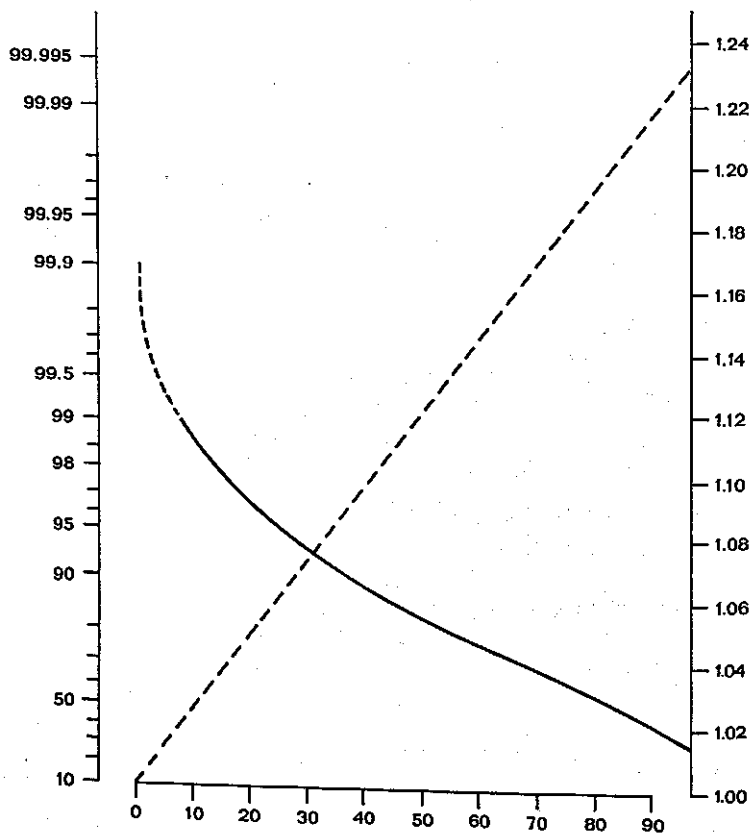

FIG. 8. Relations between the concentration of aqueous glycerine solutions and relative humidity (r.h.) at 10° to 30°C (—) and specific gravity at 20°/4°C (---) (Stakman, 1968).
 Abscissa: concentration aqueous glycerine solution (% by weight).
 Ordinates: left: r.h. (%), double log. scale (cf. fig. 4B).
 right: specific gravity aqueous glycerine solution.

by vacuum suction, through which only a small area of the filter became wet. The filter with nematodes was placed into chamber 2 (97.7% r.h.) and the water from the filter evaporated slowly, by which the first step of desiccation also proceeded gradually.

3. *Gradual desiccation technique*

The desiccation process can proceed still more gradually by the following technique, by which the transfer of nematodes from one chamber to the other becomes unnecessary and which enables simultaneous execution of several experiments. Nematodes on a glass slide, like in technique 1, were placed in a humidity chamber with water. At stated intervals a certain amount of glycerine was pumped into the chamber by means of a peristaltic pump and mixed with the water by a stirrer that also functioned as a fan. The stirrer was driven by an electromotor mounted on the lid of the chamber. Both pump and stirrer were switched on and off simultaneously by a time switch-relay. The glycerine reservoir and pump were placed inside the incubator to ensure equal temperatures of the liquids. Both rate and final step of desiccation could be controlled by administration of the glycerine.

At the end of the test the nematodes were taken out of the final chamber, rewetted in tap water and examined for survival after a 24 hours recovery period. Since the difference between living and dead nematodes was sometimes indistinct, nematodes were considered alive if they showed activity, either spontaneously or upon touching.

3. SURVIVAL IN MOIST FALLOW SOIL

Moist soil is the common, permanent habitat of ectoparasitic root-infesting nematodes. When suitable plants are growing, the nematodes may reproduce and thrive. During periods of fallow the nematodes enter quiescence since they are obligatory plant parasites. It is under these circumstances that the influence of moisture on nematode survival is investigated.

This chapter includes general, introductory investigations (3.1.) and more specific studies on soils with *Tylenchorhynchus dubius* and *Rotylenchus robustus* (3.2.). The influence of extreme drought is covered in chapters 4 and 5.

3.1. GENERAL INVESTIGATIONS

The general investigations examine the influence of fluctuating and constant moisture levels and various controlled moisture regimes in moist soils on the natural nematode communities.

3.1.1. *Fluctuating moisture levels*

Natural nematode communities in three different soils were exposed to a fluctuating moisture regime under partially controlled conditions. Earthen pots were filled with 100 g Westberg soil (sand), Dijkgraaf soil (loamy sand) or Rijnsteeg soil (sandy clay loam). The soils had been taken from the fields of grasses and weeds towards the end of the growing season, i.e. late September. After sieving to remove stones and coarse roots, the soils, which had a loose 'sandy' structure due to the pretreatment (cf. chapter 2), were used without delay. Five pots of each soil were kept to determine the initial populations. The remaining 30 pots of each soil were placed in a greenhouse with average daily temperatures of 15–18°C during 22 weeks. Incidentally the temperature rose to a maximum of 26°C for 1 to 2 hours each day. The relative humidity of the air was between 30% and 60% with occasional extremes of 20% and 90% for short periods. The pots were sprinkled with water regularly so that neither saturation nor dryness occurred. After 2 weeks and then every 4 weeks during a total period of 22 weeks, the nematode populations in each soil were determined with 5 replicate pots taken at random. Adults and larvae were analysed separately for each of the prevailing genera of ectoparasitic nematodes.

The course of the populations is summarized in table 5. It appeared that all genera survived in all soils for a long time despite the absence of food plants. Some populations showed an increase in density during the first weeks, which may have been due to hatching of eggs (which as such are lost in the extraction procedure) and to larval development. The populations in these recently collected soils may also have fed and reproduced on bits of fresh roots in the soil. Ultimately the densities of all nematodes in all soils were significantly reduced.

TABLE 5. Percentage population density (initial density is 100) of the main plant nematode genera in three fallow soils exposed to a partially controlled, moderately fluctuating moisture regime after 2, 6, 10, 14, 18, and 22 weeks. A = adults, L = larvae. Each percentage is the weighted mean of 5 replicates

Nematodes and soils		Exposure time in weeks					
		2	6	10	14	18	22
<i>Paratylenchus</i> (sand)	A	72	52	19	26	19	10
	L	23	15	5	1	0.3	0
<i>Helicotylenchus</i> (sand)	A	119	105	28	97	48	84
	L	52	49	27	15	19	24
<i>Rotylenchus</i> (loamy sand)	A	176	161	143	145	45	14
	L	145	109	48	51	34	22
<i>Tylenchorhynchus</i> (loamy sand)	A	102	96	78	50	77	26
	L	116	80	32	39	18	16
<i>Tylenchorhynchus</i> (sandy clay loam)	A	103	117	83	81	88	84
	L	72	36	53	46	23	39
<i>Helicotylenchus</i> (sandy clay loam)	A	69	75	77	53	56	40
	L	67	37	47	37	16	16
<i>Paratylenchus</i> (sandy clay loam)	A	97	65	61	63	24	35
	L	72	0	8	4	0	0

The reduction of larvae was stronger than adults. *Paratylenchus* larvae disappeared quickly and are obviously more susceptible than the adults and the other genera.

3.1.2. Constant moisture levels

Previously stored Tarthorst soil at pF 1.8 with its natural nematode community (cf. chapter 2) was adjusted to moisture levels corresponding to pF values 1, 2, 3 and 4. Each batch of soil was spread over 8 plastic pots with 50 g of soil each. The initial populations were determined by extracting the soil of three replicate pots. The remaining 5 pots of each series were covered with a thin, perforated plastic sheet to allow for gas exchange and to prevent loss of moisture. This was further achieved by placing the pots in a climatic cabinet at $16 \pm 0.2^\circ\text{C}$ and 98–100% relative humidity. After 13 weeks the soil moisture content and the nematode populations were determined on two and three pots of each pF series respectively. The moisture content had not perceptibly changed. The nematode figures are reported separately for the four prevailing genera of plant parasites.

The results are summarized in table 6. At pF 2 the mean percentages of the final numbers of nematodes were less than 100 for all genera, but only *Paratylenchus* had decreased significantly. *Paratylenchus* is also the only genus which declined at all pF values, although the difference was significant only at pF 2. It is obvious that the populations as a whole are not strongly influenced by any of the moisture conditions even after 13 weeks.

TABLE 6. Percentage population density (initial density is 100) of the major plant parasitic nematode genera of a natural community in a sandy soil kept at 4 different moisture levels for 13 weeks. Each percentage is the mean of 3 replicates. Percentages differing significantly from 100 are marked by *

Nematode genera	pF			
	1	2	3	4
<i>Tylenchorhynchus</i>	111	82	106	94
<i>Helicotylenchus</i>	71	80	272*	91
<i>Paratylenchus</i>	56	36*	65	86
<i>Criconemoides</i>	129	53	100	135

3.1.3. Various controlled moisture regimes

Tarthorst soil was exposed to six different moisture regimes under controlled conditions (1-6), whereas the effects of soil tilling (T) and the addition of organic manure (O) were also investigated.

Oblong plastic bags hanging in plastic cylinders of 4.6 cm diameter were filled with 280 g of soil. The cylinders were divided into 6 groups and during 20 weeks the soil of each group was subjected to one of the following moisture regimes:

1. Held continuously at about pF 2. This served as a reference.
2. From pF 0 slowly rising to pF 4 in 12 weeks, saturation, and gradually drying to pF 4 in 8 weeks.
3. Held at pF 0 during 4 weeks, then increasing to pF 3 in 8 weeks, saturation for 4 weeks, and then a rapid increase to pF 3.5 in 4 weeks.
4. Held at pF 0 during 4 weeks, then gradually increasing to pF 3.5 in 12 weeks, saturation, and a rapid increase to pF 3.5 in 4 weeks.
5. From pF 0 gradually increasing to pF 4.5 in 20 weeks.
6. Held at saturation for 20 weeks.

In all cases, drainage was prevented to check leaching of nematodes and salts. The entire experiment was carried out at both 15°C and 20°C, and the cylinders with soil were placed in climate rooms at 70-90% relative humidity. Evaporation was regulated by separate ventilators. The soil moisture condition was estimated every three to four days by means of gypsum resistance blocks (Bouyoucos) placed in additional cylinders with soil. The gypsum blocks had been calibrated in the same soil prior to the experiment. Moreover soil moisture

FIG. 9. Survival of natural populations of three nematode genera after 20 weeks in fallow Tarthorst soil subjected to moisture regimes 1 to 6 (cf. text), as well as to soil tilling (T) and to organic manure (O), at both 15° and 20°C.

P₁ = initial population. Broken lines (----) indicate levels under which populations differ significantly from P₁ or from treatment 1; * marks the treatments causing a significant difference from treatment 1.

Abscissae: symbols for different treatments as indicated above.

Ordinates: number of nematodes per 100 g soil (log. scale).

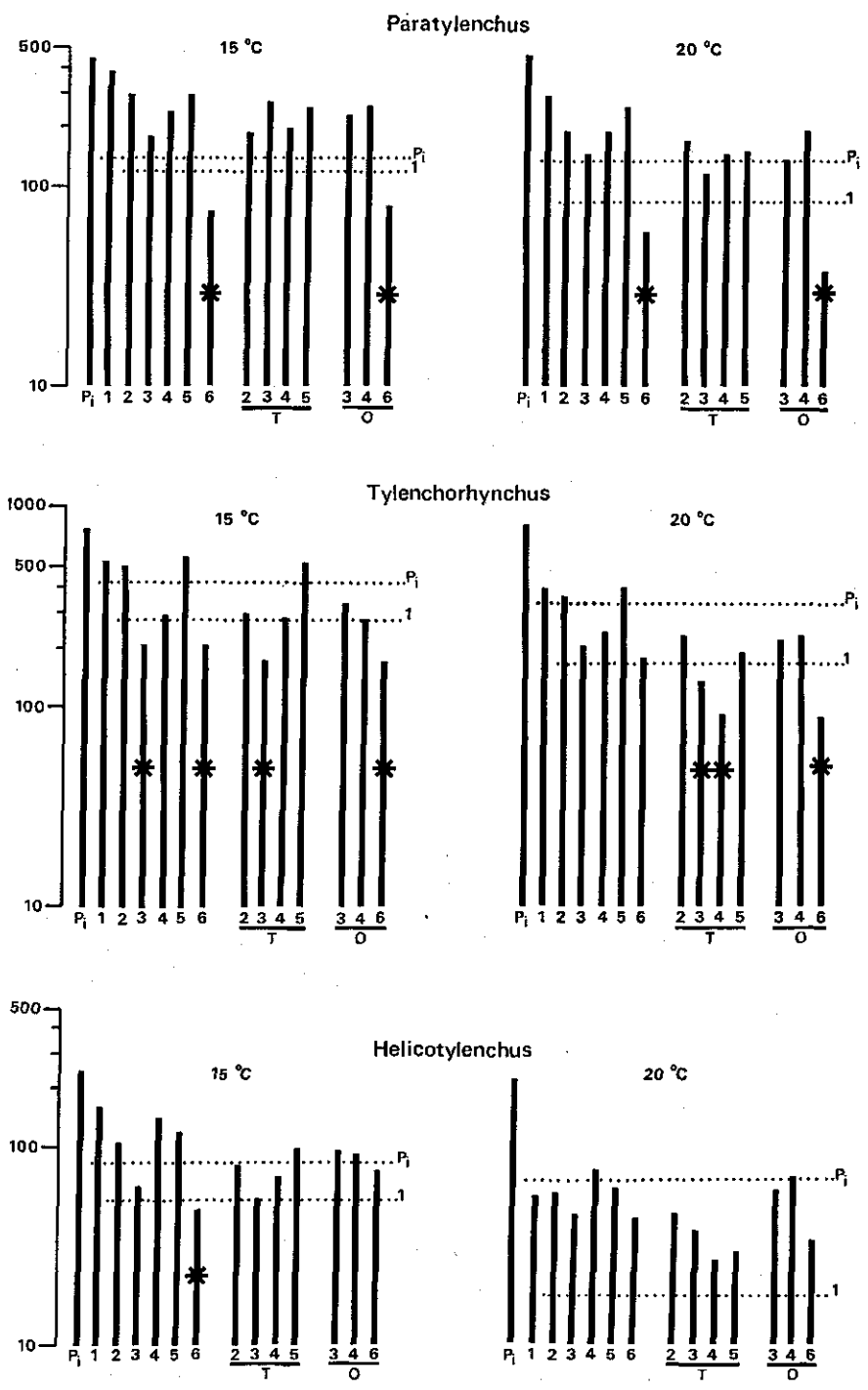

FIG. 9.

was determined gravimetrically every 4 weeks on other separate cylinders with soil. In the course of the experiment the bulk density of the soil increased from 0.96 to 1.05 g.cm⁻³.

The effect of soil tilling (T) was investigated on parallel series of cylinders with soil exposed to the moisture regimes 2, 3, 4 and 5. The tilling took place when the soil was fairly dry. The first time after 9 weeks, then after 15 weeks for regimes 2 and 5, and finally after 18 weeks for regimes 3 and 4. Tilling is simulated by pouring over the soil into similar cylinders.

The influence of manuring (0) was investigated on parallel series of soil exposed to the moisture regimes 3, 4 and 6, which all had a saturation period of at least 4 weeks. An amount of dried cow-house manure equivalent to 10 tons per hectare was mixed with the soil at the beginning of the experiment; this amount equals 50 tons non-dried manure per hectare.

After 20 weeks the final nematode populations were determined on 3 replicates of each treatment and compared with the initial populations. The nematode figures recorded are for three of the prevalent genera of ectoparasites, namely *Paratylenchus*, *Tylenchorhynchus* and *Helicotylenchus*.

The results are summarized in figure 9 and can be described as follows:

- a. None of the populations was eradicated or nearly eradicated by any of the treatments.
- b. All populations decreased in comparison to the initial population P_i; this was more obvious for *Helicotylenchus* than for the other two genera, particularly at 20°C.
- c. None of the treatments 1, 2 and 5 caused significant differences from P_i, except for *Helicotylenchus* at 20°C.
- d. Nearly all populations were significantly reduced by treatment 6, viz. continuously flooding, compared to P_i as well as to treatment 1.
- e. Most of the treatments 3 and several of the treatments 4, both comprising strong and rapid soil moisture fluctuations, reduced the numbers of *Tylenchorhynchus* and *Helicotylenchus*, but not of *Paratylenchus*, compared to P_i.
- f. No general effect could be attributed to tilling or addition of organic manure in these trials.

3.2. INVESTIGATIONS ON *TYLENCHORHYNCHUS DUBIUS* AND *ROTYLENCHUS ROBUSTUS*

The effect of constant and fluctuating soil moisture levels and of some qualitative factors due to the addition of fertilizer and organic manure was studied in moist soils containing *T. dubius* and *R. robustus*, the two most numerous ectoparasitic species in sandy soils in the Netherlands. Two test soils contained either *T. dubius* or *R. robustus*, and another one harboured both species.

3.2.1. Under a constant moisture level

Ellecom soil with *T. dubius* as the only *Tylenchorhynchus* species and PD soil

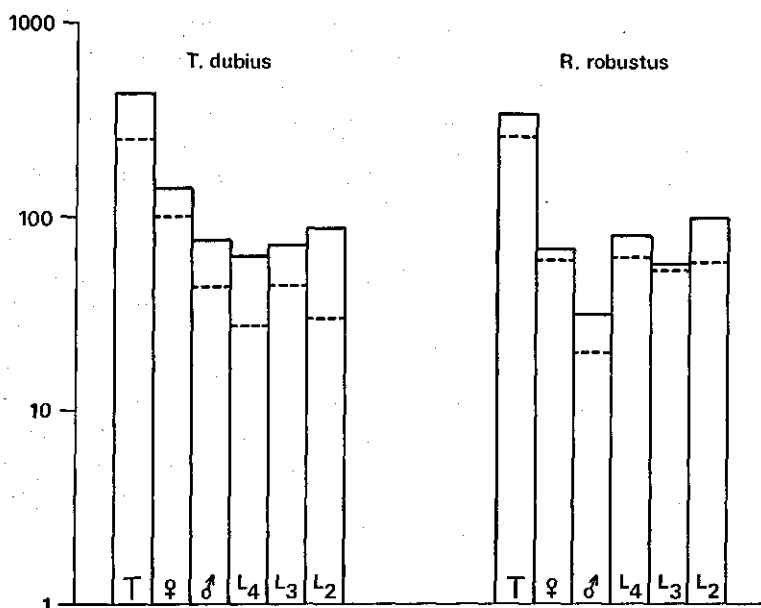

FIG. 10. Initial numbers (—) and numbers after 19 weeks (---) of populations of *T. dubius* and *R. robustus* in fallow soils at pF 1.7–1.9, separately for total nematode numbers (T), females (♀), males (♂), L4, L3 and L2 larvae. Each number is the mean of 5 replicates.

Abcissa: symbols for nematode stages as indicated above.

Ordinate: nematode numbers per 25 g soil; log. scale.

(b) with *R. robustus* as the sole *Rotylenchus* species were kept at pF 1.7–1.9 in 90 ml glass jars with bakelite screw caps. The jars were filled with 25 g of the soils and placed in a laboratory cabinet at $22 \pm 3^\circ\text{C}$ and $75 \pm 10\%$ relative humidity. The screw caps allowed for some gas exchange. This also resulted in some loss of moisture, causing the pF to increase gradually from 1.7 at the beginning to 1.9 at the end of the experiment. The size and composition of the populations were determined on 5 replicate pots of each soil at the beginning of the experiment, after 3 weeks, and then every 4 weeks during a total period of 19 weeks.

The results of the initial and final populations are illustrated in figure 10 and show that after 19 weeks, the total populations and the number of each developmental stage of both species have only slightly been reduced. When all the results are considered, the decrease of total populations or stages is not significant due to density fluctuations during the course of the experiment (Kendall's rank correlation test).

3.2.2. Various constant moisture levels

Population development of *T. dubius* and *R. robustus* was compared at three constant moisture levels in PD soil (a) in which both species were numerous. A required number of 90 ml glass jars contained 25 g of soil of which the mois-

ture content had been adjusted at levels corresponding to pF 0.5–1.0 (series I), pF 1.7–2.0 (series II) and pF 3.9–4.2 (series III) respectively. Except for 5 replicate jars of each series to determine the initial populations, all jars were stored in an aquarium with removable top and water in the bottom. The aquarium was placed in a climatic room at 18°C and 80% relative humidity. These conditions ensured about 100% r.h. and prevented loss of water from the soil. The air in the aquarium was refreshed regularly by forcing air through a porous block in the water. The populations were analysed after 0, 4, 8, 16 and 24 weeks; females, males and larvae were noted separately. The soil was always moistened three days prior to decantation to avoid deficient nematode extraction from the relatively dryer soils (cf. par. 4.1).

The results do not reveal significant changes of either populations at any of the three moisture levels when the results from all evaluation data are considered (Kendall's rank correlation test). This applies to the total populations as well as to the females, males and larvae separately. The initial and final populations are illustrated in figure 11A, showing the slight density changes after almost half a year of fallow at the three moisture levels.

3.2.3. Constant moisture levels with addition of fertilizer

The quality of the natural soil solution will often be influenced by the addition of fertilizers. To investigate the effect of fertilizer application on survival at different constant moisture levels, a very high dose was added to PD soil with *T. dubius* and *R. robustus*. The dressing was equivalent to 3300 kg N.P.K. 12–10–18 per hectare. The fertilizer was reduced to a powder and mixed with the soil immediately before the moisture adjustment. The electrical conductivity of the soil solution (saturation extract) increased from 1.2 to 9.1 millimho's per cm. Soil moisture levels, environment, population determination data and all other experimental conditions were similar to the previous experiment (par. 3.2.2.).

The size and composition of the initial populations and the populations after 24 weeks are presented in figure 11B. When the results from all evaluation data are considered, neither total populations nor the recorded stages changed significantly at any of the moisture levels according to Kendall's rank correlation test. The addition of fertilizer, therefore does not change the persistence of the nematodes at the various moisture levels.

3.2.4. Constant moisture levels with addition of organic manure

The influence of an organic manure dressing on survival of *T. dubius* and *R. robustus* in soil at different constant moisture levels was investigated by adding a high dose of cow-house manure to PD soil (a). The amount added was equivalent to 10 tons of dried cow-house manure per hectare, equivalent to 50 tons of moist material. Soil moisture levels, environment, population determination data and all other experimental conditions were similar to the previous experiments (3.2.2 and 3.2.3).

The size and composition of the initial populations and the populations after

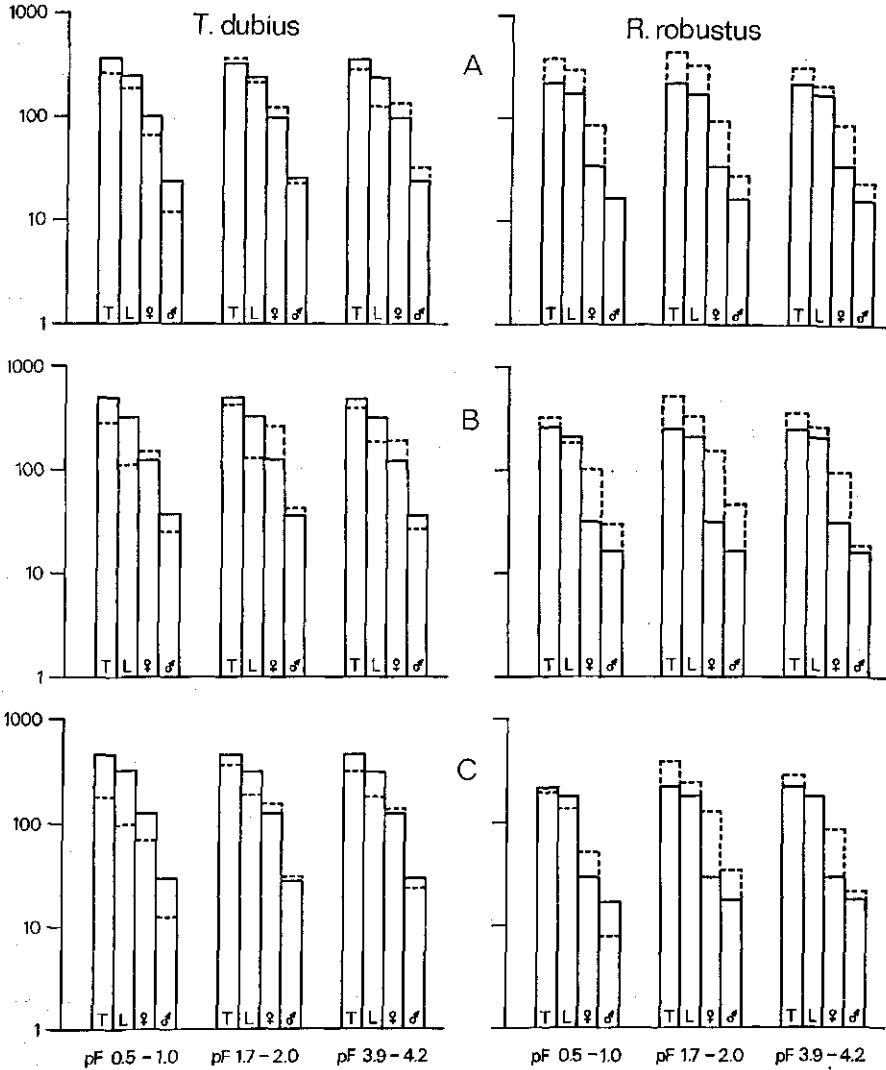

FIG. 11A, B, C. Initial numbers (—) and numbers after 24 weeks (---) of populations of *T. dubius* and *R. robustus* in a fallow sandy soil at three constant moisture levels as indicated, separately for total nematodes (T), larvae (L), females (♀) and males (♂), in three parallel experiments:

A. Various constant soil moisture levels without soil dressings (cf. 3.2.2.).

B. As A., with soil dressing of fertilizer (cf. 3.2.3.).

C. As A., with soil dressing of organic manure (cf. 3.2.4.).

Each number is the mean of 5 replicates.

Abscissae: indication of pF values and of nematode stages.

Ordinates: nematode numbers per 25 g of soil; log. scale.

24 weeks are illustrated in figure 11C. As in the previous experiments, total populations and recorded stages of development did not change significantly when all results are considered, and the addition of organic manure did not influence the persistence of the nematodes at the moisture conditions studied.

3.2.5. Fluctuating moisture levels

The constant soil moisture levels studied in par. 3.2.2 to 3.2.4 did not reduce the populations of *T. dubius* and *R. robustus* significantly during a period of 24 weeks. Usually, however, the moisture condition in the soil is variable, depending on weather conditions. In the following experiment PD soil (a) was treated in such a way that the moisture level fluctuated between pF 0 and 4.2. As in the experiments with constant moisture levels, 90 ml glass jars with 25 g of soil were placed in a climate room at 18°C, but now at 75% relative humidity. The moist soil was allowed to dry to an average pF value per jar of 4.2, determined by weighing every 3 or 4 days. Demineralized water was added to saturation and again allowed to evaporate. This process continued during the full experimental period of 24 weeks. To reduce the rate of drying of the small amount of soil, all jars were covered with a plate of perforated hard-board. Then water had to be added every 2½ or 3 weeks; the total observation period of 24 weeks covered 9 cycles.

Also the effect of dressings with fertilizer and organic manure was investigated, thus giving three soil series: A – no additions; B – fertilizing with 3300 kg N.P.K. per hectare; C – manuring with 10 tons dried cow-house manure per hectare.

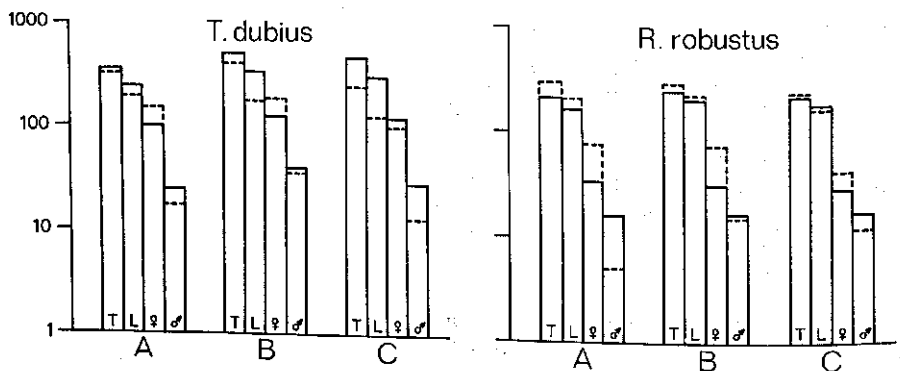

FIG. 12 A, B, C. Initial numbers (—) and numbers after 24 weeks (---) of populations of *T. dubius* and *R. robustus* in fallow sandy soil fluctuating between pF 0 and 4.2, indicated separately for total nematode numbers (T), larvae (L), females (♀) and males (♂), in three parallel experiments:

- A. Unamended soil.
- B. Fertilized soil.
- C. Soil with organic manure.

Each number is the mean of 5 replicates.

Abscissae: indication of experiments and of nematode stages.

Ordinates: nematode numbers per 25 g of soil; log scale.

Of each series, size and composition of the populations were determined on 5 replicate jars after 4, 8, 16 and 24 weeks. Initial populations of the series A, B and C were the same as those in the experiments under 3.2.2, 3.2.3 and 3.2.4. Experimental conditions other than soil moisture were also similar, so the data can be compared.

The initial and final populations are illustrated in figure 12. After 24 weeks the total populations and developmental stages of both species changed only slightly and there was no general effect due to the addition of fertilizer or organic manure. When the results from all evaluation data were considered, total populations and stages of development did not change significantly (Kendall's rank correlation test). There were also no general differences with the populations in soils at various constant moisture levels. (cf. fig. 12 A,B,C. with fig. 11A,B,C.). It is clear that fluctuating soil moisture levels have no greater effect on survival than constant moisture levels within the range of pF 0 to 4.2.

3.3. DISCUSSION

The orientational experiments indicated that a natural population of ectoparasites that has been deprived of food for some time in fallow soil is not strongly affected by non-extreme moisture conditions. At various constant moisture levels up to pF 4, populations of four nematode genera had changed little after three months (3.1.2.). Also in soil exposed to gradual moisture fluctuations for 5 months, the populations of three ectoparasitic genera had been reduced only slightly. Strong and rapid moisture fluctuations caused somewhat greater reductions. No population, however, was eradicated or nearly eradicated by any moisture treatment, nor by continuous flooding. The latter treatment caused an average reduction of the populations by about 80%, whereas an intermediate observation after 12 weeks indicated reduction by about 70%. Neither the addition of organic manure nor tilling of the soil caused higher mortality at any moisture regime (3.1.3.). The absence of a perceptible effect by the addition of organic manure to saturated soil may perhaps be explained by the relatively high organic matter content of the unamended soil (cf. 2.2.1.).

Further investigations on non-feeding populations of *T. dubius* and *R. robustus* reveal the following points with respect to their survival at non-extreme soil moisture conditions during about half a year.

- Survival at various soil moisture levels between pF 0.5 and pF 4.2 does not differ, neither at constant nor at fluctuating moisture levels.
- The size of the total populations does not change significantly at any soil moisture level or moisture regime between pF 0.5 and 4.2.
- Normal administration of fertilizer or organic manure to the soil does not affect survival at constant or fluctuating moisture levels between pF 0.5 and 4.2.
- The composition of the populations, as far as females, males and total larvae

are concerned, hardly changes at any of the investigated qualitative and quantitative moisture conditions.

Other studies have shown that field populations of ectoparasites and other nematodes fluctuate mainly in dependence of the host plants present (OOSTENBRINK, 1966). A population may rise to a high level if a host crop is grown, fall back to about half its density within two months after harvest, and then decline only slowly until the next host crop is grown. On the basis of field experiments OOSTENBRINK (1966) considered 'that most phytophagous nematodes can survive long starvation periods without host plants in the soil. Well-settled populations are evidently proof against temporary fluctuations in the physical-chemical milieu such as temperature, moisture, chemical composition of the soil moisture, aeration, disturbance of the soil'. The previous experiments affirm these findings and suppositions with respect to soil moisture in moist fallow soil, for neither quantities nor different qualitative properties of soil moisture affected the tested populations. The condition of the nematode populations, as influenced by the time of removal of host plants, appears to be important indeed (see also 2.1.1.), for when a fresh population was used, numbers of nematodes showed a significant decline (3.1.1.).

KABLE and MAI (1968) assumed that high activity and therefore high expenditure of energy caused high mortality of nematodes at soil moisture conditions favourable for nematode activity. This does not seem to hold for survival of populations in fallow soil. At relatively high pF values, like 3.9–4.2, activity is almost or completely reduced (cf. 1.1 and Wallace, 1963). At pF values of 0.5–1.0 and 1.7–2.0 the conditions for activity are optimal. Since no differences in survival have been observed between populations at different constant soil moisture levels, nor between these and the populations in soil at fluctuating moisture conditions, it seems likely that a population in fallow soil is scarcely active.

Numbers of nematodes extracted from soil of one moisture level at different times during the course of the experiments sometimes differed significantly, causing a fluctuating course of the populations. This may be due to the fact that the extraction techniques are based on the activity of nematodes. Since temperature influences nematode activity, the fluctuating nematode numbers may have been caused by different ambient temperatures. This has been reported before by KERR and VITHILINGHAM (1967), who found that temperatures of 27°C and higher significantly reduced the number of extracted nematodes in comparison with numbers extracted at 22° to 25°C with a modified Baermann funnel technique. It may be advisable to extract nematodes in constant temperature rooms.

4. SURVIVAL IN DRY FALLOW SOIL.

Several investigations were made on the desiccation survival of ectoparasitic nematodes in dry soil (4.2. and 4.3.). First, however, special problems had to be solved on the method for extraction of nematodes from dry soil (4.1.).

4.1. EXTRACTION OF NEMATODES FROM DRY SOIL

Desiccation of soil in the field proceeds gradually, as does the loss of moisture by nematodes, which become inactive when their body moisture is removed. If dry soil is wetted, the nematodes take up water and become active again if still alive. Reactivation may require a considerable length of time, depending on the degree of desiccation. This suggests that the common methods of nematode extraction cannot be used for nematodes from dry soil, unless they are first conditioned. The following experiments illustrate this problem and develop an adequate extraction technique.

Well-mixed, moist PD soil (a) with both *T. dubius* and *R. robustus* was allowed to dry out thoroughly and was extracted for nematodes in three different ways. Three groups of 5 glass jars (90 ml) each with 50 g of soil were placed in a laboratory cabinet at $20 \pm 3^\circ\text{C}$. During the first 3 weeks, the pF increased slowly from 2.5 to 4.5 and the relative humidity of the air remained about 90%. In the following 5 weeks, the relative humidity decreased to $75 \pm 10\%$ and the pF increased to 5.5 or higher. Size and composition of the populations of the two species were determined on 5 replicate jars by each of the three extraction methods:

- D (= dry): elutriation of dry soil and cleaning the residue on cottonwool filters.
- SW (= shortly wetted): wetting of dry soil in situ, viz. in the jars, for 3 hours, followed by extraction as in D.
- W (= wet): wetting of the dry soil in situ for 2 days, followed by extraction as in D.

To obtain additional information the usual extraction procedure was complemented in two ways. Firstly, the extracted, residual wet soil was collected, kept for 2 more days and re-extracted by decantation. Secondly, nematodes that had passed through the cottonwool filters were collected periodically and counted during a longer period than normal, viz. during a 27 day period after first contacting water.

The results have been illustrated in figures 13 to 15 and table 7, and can be described as follows:

1. The efficacy of the extraction methods D, SW and W differs enormously when nematodes are collected and analysed one day after extraction as in the usual procedure. D yields only 14% and 4% of W for *T. dubius* and *R. robustus*

respectively. SW gives higher numbers for *T. dubius*, but not for *R. robustus* in comparison with D (fig. 13).

2. Comparison of numbers obtained when all nematodes have been in contact with water for a total period of 3 days, i.e. 1 day after extraction for W and 3 days after extraction for SW and D, shows that SW is substantially higher than D, but W still gives by far the highest numbers (fig. 14A).

3. If the uncleaned nematode extract is left on the filters up to 27 days, thus offering the nematodes ample opportunity to become active and pass through the filters, the differences between W, SW and D remain. If the total yield of nematodes of W after 27 days is indicated as 100%, SW and D reach 74% and 39% respectively for *T. dubius* and 69% and 21% for *R. robustus* (fig. 14A).

4. In addition to the efficacy (total numbers) the rate the nematodes pass through the filters varies with the methods and the species (table 7). The nematodes extracted by method W pass the quickest and by method D the slowest. *T. dubius* appears to be more active than *R. robustus*. Over 95% of the

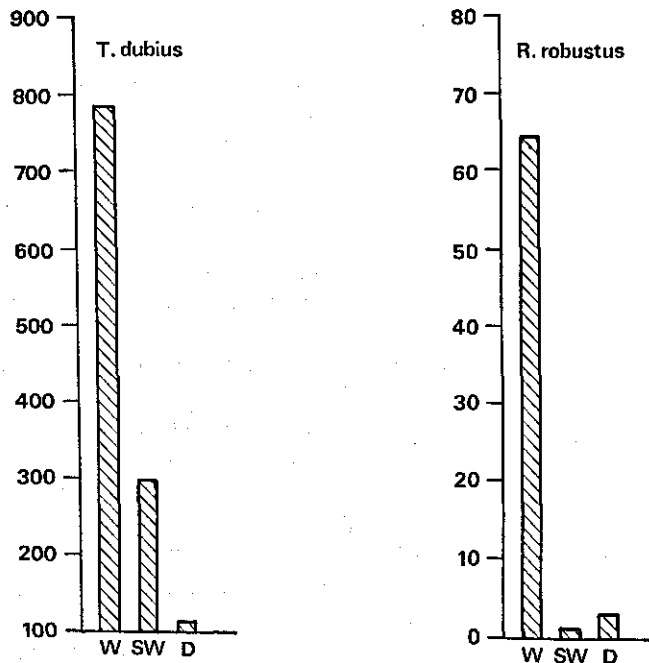

FIG. 13. Numbers of *T. dubius* and *R. robustus* extracted from desiccated soil by elutriation after three different pretreatments of the soil, i.e.

W = dry soil wetted in situ for 2 days.

SW = dry soil wetted in situ for 3 hours.

D = dry soil not wetted.

Nematode numbers are means of 5 replicates.

Abscissae: indication of pretreatments mentioned above.

Ordinates: number of nematodes in 50 g soil.

total *Tylenchorhynchus* have passed through the filters after 9 days, whereas *Rotylenchus* needs 20 days.

5. Re-extraction of the extracted soil again produces varying numbers of nematodes dependent on the original extraction method. Addition of the numbers or re-extracted nematodes to originally extracted numbers reduces the differences between methods, but does not eliminate them, nor does it change the order (fig. 14B). The percentages of re-extracted nematodes calculated against the total sum of nematodes (extraction + re-extraction) for each tech-

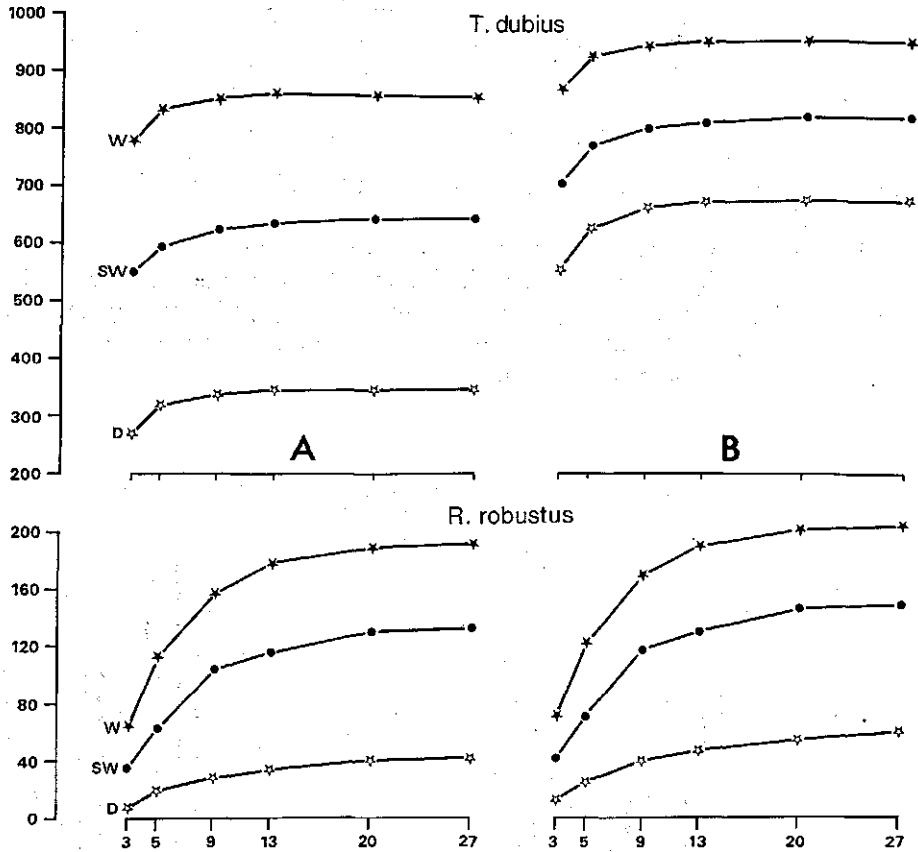

FIG. 14 A. Cumulative numbers of *T. dubius* and *R. robustus* extracted from desiccated soil by elutriation when the nematodes were given the opportunity to pass through the cottonwool filters up to 27 days after wetting the soil.

FIG. 14 B. Cumulative numbers of nematodes as presented in fig. A plus numbers of nematodes collected by re-extraction of the residual soil after the first extraction.

W = dry soil wetted in situ for 2 days prior to extraction.

SW = dry soil wetted in situ for 3 hours prior to extraction.

D = dry soil not wetted prior to extraction.

Abscissae: days after wetting the soil.

Ordinates: number of nematodes in 50 g soil.

TABLE 7. Percentages of nematodes extracted from dry soil by 3 different methods and collected up to 27 days after wetting the soil (the total number after 27 days is used as 100% for each method). Each percentage is the mean of 5 replicates

Species	Method	Days after wetting					
		3	5	9	13	20	27
<i>T. dubius</i>	W	90.4	96.5	98.8	99.8	100	100
	SW	85.7	92.7	97.2	98.9	100	100
	D	78.4	92.5	97.7	99.4	100	100
<i>R. robustus</i>	W	33.5	58.6	81.7	92.7	98.4	100
	SW	26.5	46.2	78.0	87.1	98.5	100
	D	17.0	43.9	65.8	80.5	95.1	100

nique are the following: for *T. dubius*: W 10%, SW 32%, D 49%; for *R. robustus*: W 7.5%, SW 12.5%, D 32%.

6. The frequency of developmental stages in the populations is not systematically affected by the extraction method. Figure 15 shows the frequency of the stages at 20 days after wetting, based on the originally extracted populations. This frequency is substantially similar at the other times of evaluation or when re-extracted nematodes are included.

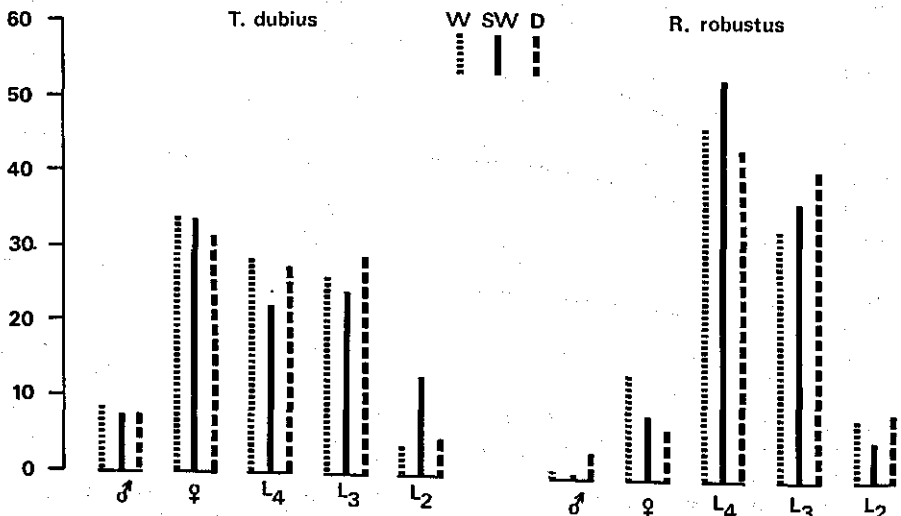

FIG. 15. Distribution of stages of development of populations of *T. dubius* and *R. robustus* extracted from dry soil by three different methods, indicated at W, SW and D (cf. fig. 14).

Abscissae: stages of development: ♂ = males, ♀ = females, L4, L3 and L2 = fourth, third and second stage larvae.

Ordinate: percentage of nematodes.

Similar results were obtained in another experiment using PD soil (b) with *R. robustus* and Ellecom soil with *T. dubius*, using the decantation extraction method.

Extraction of nematodes from dry soil may result in an underestimation of the actual number of living nematodes if:

- a. the soil is not moistened long enough to allow the nematodes to take up water and regain their activity,
- b. the soil structure is disturbed before the nematodes have taken up water,
- c. the nematodes are not given enough time to pass cottonwool or other cleansing filters.

The observed losses are probably explained by the combined effect of the following phenomena:

1. Handling of dry soil may damage the desiccated nematodes. This is substantiated by tests *in vitro*, showing that after disturbing the shape of dehydrated nematodes reactivation upon rewetting is greatly reduced. Internal injury must be the cause, for the cuticle of dehydrated nematodes appears to be toughish and is not easily injured by for instance sharp edges of soil particles. Upon rewetting, damaged dehydrated nematodes absorb water normally. This explains the persisting differences between D and W.
2. In dry soil some of the nematodes may be stuck to the bigger soil particles that have a great settling speed in water. Therefore these nematodes will be lost during extraction, which is based on elutriation or decantation.

4.2. GENERAL INVESTIGATIONS

4.2.1. Desiccation survival in Tarthorst soil

In this experiment Tarthorst soil that had been sieved and mixed, was used after storage for 3 weeks. Earthen pots containing 100 g of the above soil were placed in the laboratory where the temperature and relative humidity fluctuated between 15° and 30°C and 35% and 80%, respectively. The soil in half the pots was allowed to dry out, which increased the pF from 2.0 to 5.5 within one week. The other pots were watered daily so that the pF fluctuated between 0.5 and 2.0. The populations of the main ectoparasitic genera were analysed on three replicate pots of both the wet and the dry series at the beginning of the trial, then when the soil had become dry (i.e. after 1 week) and further every 3 weeks for a total of 13 weeks. Before extraction the soil was wetted for 2 days, and the nematodes collected three days after extraction.

The results are summarized in figure 16. Numbers of all three genera declined markedly in dry soil in the first week, viz. to 53%, 50% and 11% of corresponding numbers in moist soil for *Tylenchorhynchus*, *Paratylenchus* and *Helicotylenchus*, respectively. This can be explained by the very quick drying of the soil during the first week. In moist soil slighter reductions occurred. After the first week, populations in both wet and dry soil continued to decline. At the end of the experiment, numbers of all genera in dry soil were significantly lower than those in wet soil. The final numbers in dry soil were reduced to

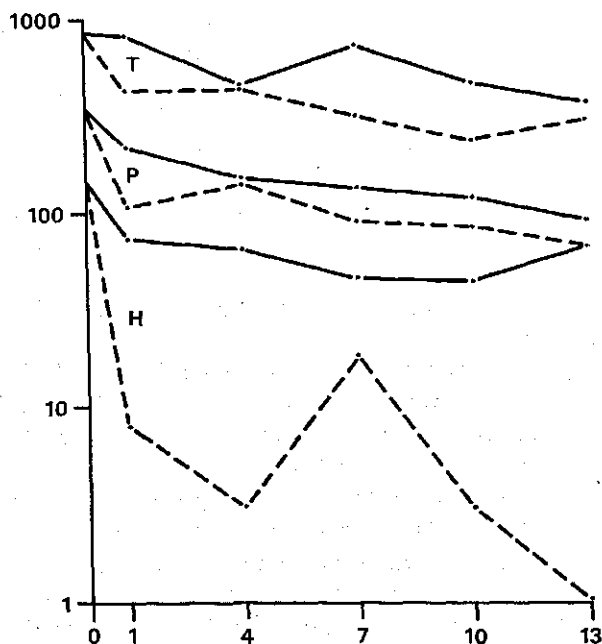

FIG. 16. The course of populations of the genera *Tylenchorhynchus*, *Paratylenchus* and *Helicotylenchus* in fallow Tarthorst soil, continuously kept moist (solid lines), or strongly desiccated (broken lines) at fluctuating environmental conditions during 13 weeks.
 Abscissa: time in weeks.
 Ordinate: number of nematodes in 100 g soil (log. scale).

33%, 20% and about 0% of the original density for *Tylenchorhynchus*, *Paratylenchus* and *Helicotylenchus* respectively. This meant that *Helicotylenchus* was eradicated, whereas fair numbers of *Tylenchorhynchus* and *Paratylenchus* survived the rigid drought treatment.

4.2.2. Desiccation survival in three different soils

A required number of earthen pots were filled with 100 g of moist Westberg soil (sand), Dijkgraaf soil (loamy sand) and Rijnsteeg soil (sandy clay loam) respectively; the soil had not been stored previously. The pots were placed in a greenhouse at average temperatures of 15–18°C during 22 weeks; incidentally the temperature rose to a maximum of 25°C for 1 to 2 hours. The relative humidity of the air fluctuated between 30% and 60%, with occasional short periods of 20% and 90%. The soil in the pots dries out as follows:

	initial pF value	pF value after 2 weeks	pF value after 6 weeks
Westberg soil (sand)	2.5	4.5	5.5
Dijkgraaf soil (loamy sand)	2.3	4.8	5.5
Rijnsteeg soil (sandy clay loam)	2.4	4.7	5.5

After two weeks and then every 4 weeks during a 22 week period, the nematode populations in each soil were determined on 5 replicate pots taken at random. Prior to extraction, the soil in the pots was wetted for 2 days and the nematodes were collected on the 5th day after extraction. Adults and larvae were counted separately.

The results were summarized in table 8 and can be compared with those of the simultaneous experiment in par. 3.1.1. in which the same soils were kept moist. The total number of nematodes in each of the soils was reduced after 2 weeks. In sandy soil, the nematodes had almost vanished. In the loamy sand and the sandy clay loam, reductions were less marked; *Tylenchorhynchus* species were obviously the best survivors. There seemed to be a slightly stronger reduction of larvae than of adults, except for *Paratylenchus* in sand. The reductions could not be wholly attributed to desiccation, since some reduction occurred in wet soil (see par. 3.1.1.), but the numbers of nematodes from dry soil were all significantly lower than those from wet soil, except for larvae of *Paratylenchus* in the sandy clay loam, which practically vanished in wet as well as in dry soil.

TABLE 8. Percentage population density (initial density is 100) of the main plant parasitic nematode genera in three fallow soils exposed to desiccation after 2, 6, 10, 14, 18 and 22 weeks. A = adults, L = larvae. Each percentage is the weighted mean of 5 replicates

Nematodes and soils		Exposure time in weeks					
		2	6	10	14	18	22
<i>Paratylenchus</i> (sand)	A	2	2	0.5	1	0.1	0
	L	17	2	0.3	0	0	0
<i>Helicotylenchus</i> (sand)	A	0	0.5	0.5	0.5	0	0
	L	0.6	0.3	0.6	0.3	0	0.3
<i>Rotylenchus</i> (loamy sand)	A	76	14	8	10	0	0
	L	73	11	4	0	0	0
<i>Tylenchorhynchus</i> (loamy sand)	A	90	41	28	25	21	2
	L	86	38	25	31	21	1
<i>Tylenchorhynchus</i> (sandy clay loam)	A	57	29	11	9	2	1
	L	33	18	11	5	2	1
<i>Helicotylenchus</i> (sandy clay loam)	A	23	4	0.8	0.3	0	0
	L	9	0.5	0.7	0	0	0
<i>Paratylenchus</i> (sandy clay loam)	A	37	14	4	6	0.2	0
	L	2	1	0.2	0.2	0	0

4.3. INVESTIGATIONS ON *TYLENCHORHYNCHUS DUBIUS* AND *ROTYLENCHUS ROBUSTUS*

4.3.1. Active nematode stages

Ellecom soil with *T. dubius* as the only *Tylenchorhynchus* species and PD soil (b) with *R. robustus* as the sole *Rotylenchus* species were both subjected to desiccation under controlled conditions. A number of 90 ml glass jars were

filled with 25 g of soil and placed in a laboratory cabinet at 22 ± 3 °C and $75 \pm 10\%$ relative humidity. The soil in the jars dried out as follows:

	Ellecom soil	PD soil (b)
initial pF value	2.5	1.9
pF after 1 week	4.4	3.0
pF after 3 weeks	5.0	5.0
pF thereafter	5.4-5.7	5.4-5.7

The size and composition of the populations were determined on 5 replicate jars of each soil at the beginning of the experiment, after 3 weeks and further every 4 weeks during a total period of 19 weeks. Prior to extraction, the soil was wetted for 2 days and the nematodes collected after 5 days. The results could be compared with those in par. 3.2.1. in which the same soils were kept wet at one constant moisture level under identical conditions.

The results are summarized in figure 17. Both species were almost completely eradicated after 19 weeks (fig. 17A), whereas the populations did not decrease significantly in the same soils that had been kept moist (cf. fig. 10). The relative percentage decline of *R. robustus* was greater than that of *T. dubius* at all periods. The decline calculated as the mean percentage per week for each period was 13, 7, 11, 18 and 6% for *T. dubius* respectively in the 1st to 5th period and 18, 20, 22, 33% for *R. robustus* in the 1st to 4th period. If the lower activity of *R. robustus* during the extraction (cf. 4.1) is taken into account, which means an increase of all numbers of this nematode by about 20%, the decline of *R. robustus* in the first period was also 13%. The other values did not change.

In both species, males disappeared first, followed by second stage larvae (fig. 17B). The females of both species showed a proportional decrease, which was strongest for *R. robustus*. Fourth and third stage larvae increased proportionally, which indicated that these stages were the best survivors.

These results did not give information on desiccation survival of eggs. If eggs had been present in the soil, it is unknown whether the L2 larvae found were larvae that had survived desiccation or larvae that had hatched from eggs during the three days of soil moistening prior to extraction. Unhatched eggs were lost to a large extent during extraction with the sieves.

4.3.2. Nematode eggs

The purpose of this experiment was to investigate whether eggs survive in dry soil better than active stages and if they hatch when the soil is rewetted. For this purpose, Ellecom soil with active nematodes and eggs of *T. dubius* was exposed to desiccation. The nematodes were extracted by two different methods, one which loses the eggs and another that retains them. In the latter case, hatching of eggs that have survived, should yield a higher number of second stage larvae. Wet soil was extracted similarly for comparison.

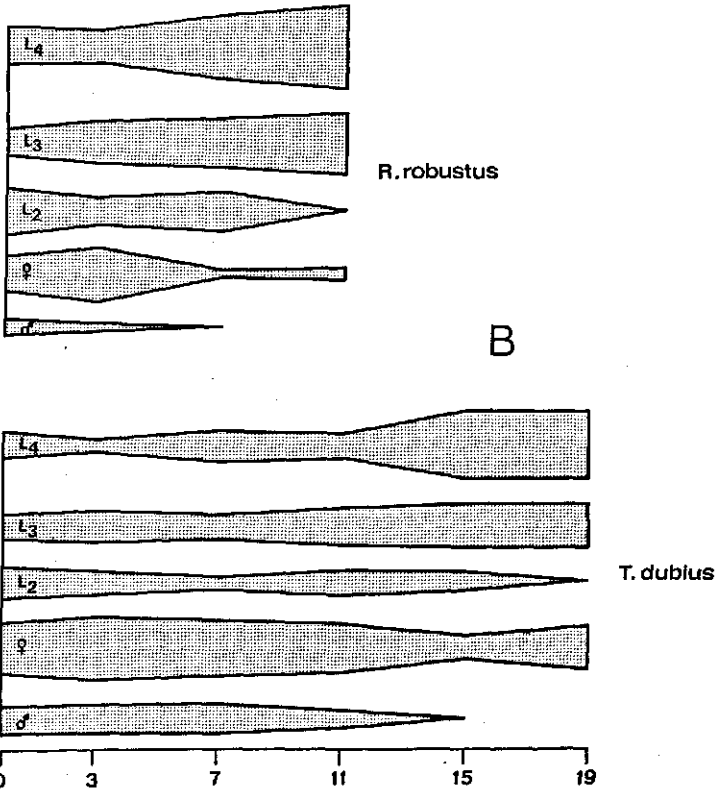
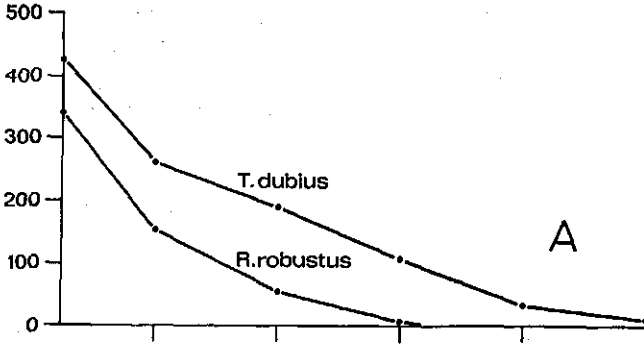

FIG. 17 A. Decline of natural populations of *T. dubius* and *R. robustus* in dry Ellecom and PD soil respectively during a period of 19 weeks.

FIG. 17 B. Composition of the populations of fig. 17A. The sum of the percentages of males (♂), females (♀), L4, L3 and L2 larvae is 100% at each point of time.

Abscissa: time in weeks.

Ordinate fig. 17A: number of nematodes in 25 g of soil.

A number of 90 ml glass jars were filled with 20 g of moist pasture soil which contained gravid females as well as old females and eggs. Two times 5 jars were used for extraction of the moist soil. The soil in two other batches of 5 jars was allowed to dry out at 18–24°C and at 70–80% relative humidity. The pH of the soil increased from 2.7 to about 5.5 in two weeks after which the soil was rewetted. Extraction was carried out the first day, for if this is delayed, desiccated eggs may hatch in the soil and therewith reduce possible differences between the methods of extraction.

Nematodes were extracted from both undesiccated (W) and desiccated soil (D) by the following two methods:

1. Soil was directly placed on a cottonwool filter on a supporting sieve and spread in a 1 mm layer. The filter was placed in a shallow tray with water. This method prevented loss of eggs.
2. Soil was placed in a narrow can with 250 ml of water and stirred for 10 seconds. The soil particles were allowed to settle for 5 seconds and the suspension decanted. This procedure was repeated 3 more times. The final suspension of 1 liter was poured over a single sieve with 44 μ meshes and the filtrate collected again. The majority of active stages was collected on the sieve, while eggs passed through it. The residue on the sieve was washed into a can. The sieved suspension was sieved 5 more times in order to catch all active specimens without retaining the eggs. The residues from the sieve were bulked and this suspension poured over a cottonwool filter and treated as with method 1.

The nematodes were collected from the filters and examined for males, females and three larval stages after 1, 3, 5, 7, 10 and 13 days. It was necessary to keep them so long because hatching of surviving eggs and subsequent passing of the young L2 larvae through the filters requires some time and nematodes from desiccated soil pass through the filters very slowly. After 7 days most of the nematodes had passed through the filters.

The final number of nematodes collected after 13 days are represented in table 9. The decantation method (2) generally yielded fewer nematodes from the desiccated soil than the direct method (1), but the methods caused no significant differences between numbers of nematodes from either soils with one exception: for wet soil the direct method (1) gave significantly more L2 larvae than the decantation method (2). This difference could have two explanations: either a considerable number of L2 larvae from the wet soil were lost by sieving in the decantation method despite all precautions, or a number of eggs had hatched in the wet soil placed directly on cottonwool filters. The latter is most likely since for dry soil no significant difference occurred due to the different extraction methods. This would also indicate that in dry soil no or only few eggs had hatched. Desiccation probably killed most eggs.

As already mentioned, hatching of living eggs and passing of the young L2 larvae through the filters may require some time. In that case, the proportional number of L2 larvae collected after the first catch, or percentage subsequent delivery, would be higher for the wet soil extracted directly (W1) than for the wet soil extracted by decantation (W2), whereas the two extraction methods

TABLE 9. Final numbers of *T. dubius* extracted from 20 g undesiccated (W) and desiccated soil (D) by two different methods (1 & 2), recorded for females (♀), males (♂), L4, L3 and L2 larvae. 1 = direct cottonwool filter method, 2 = decantation method. Each number is the mean of 5 replicates. Significant differences are indicated by arrows.

Soil	Extraction method	Nematodes				
		♀	♂	L4	L3	L2
Undesiccated (W)	1	230	115	329	148	218
	2	278	117	285	159	143
Desiccated (D)	1	224	94	198	135	93
	2	203	75	166	122	86

should give no difference for the desiccated soil if the eggs had been killed. To verify this, subsequent delivery of each developmental stage, between the 1st and 3rd day (period I), the 3rd and 5th day (period II), and the 5th and 7th day (period III), was compared for both methods and both soils. The percentage subsequent delivery can be derived from figure 18, which shows the experimental results as a percentage of the final catch in each case for females, males, L4, L3 and L2 larvae. For dry soil, the two extraction methods gave no significant differences between percentages subsequent delivery of L2 larvae in any of the periods. For wet soil, the direct extraction method (1) yielded a significantly higher percentage subsequent delivery of L2 larvae in period II and III than the decantation method (2). This supports the assumption, that eggs do not survive and hatch in rewetted dry soil. This is substantiated further by the fact that particularly the L2 larvae from W1 in period II are very young larvae, a phenomenon not observed for dry soil. Of other stages only in period I, the subsequent delivery of females from W1 was significantly higher than from W2, but also the actual total numbers of females deviated from the general pattern; W1 gave considerably fewer females than W2 (see table 9). The lower number of females from W1 and their lower activity cannot be explained with confidence, but these observations do not invalidate the observations on L2 larvae.

The conclusion that eggs of *T. dubius* are susceptible to desiccation and that hatching of eggs by no means can be the cause of the better catch of nematodes upon wetting of dry soil appears to be justifiable.

An additional interesting phenomenon is the slowness with which males pass the extraction filters compared to the other stages, as becomes apparent from the marked rise of all curves, also in period II (see fig. 18).

4.3.3. Comparison of *Tylenchorhynchus dubius* and *Rotylenchus robustus*

A soil containing both *T. dubius* and *R. robustus*, viz. PD soil (a) was exposed to desiccation under controlled conditions.

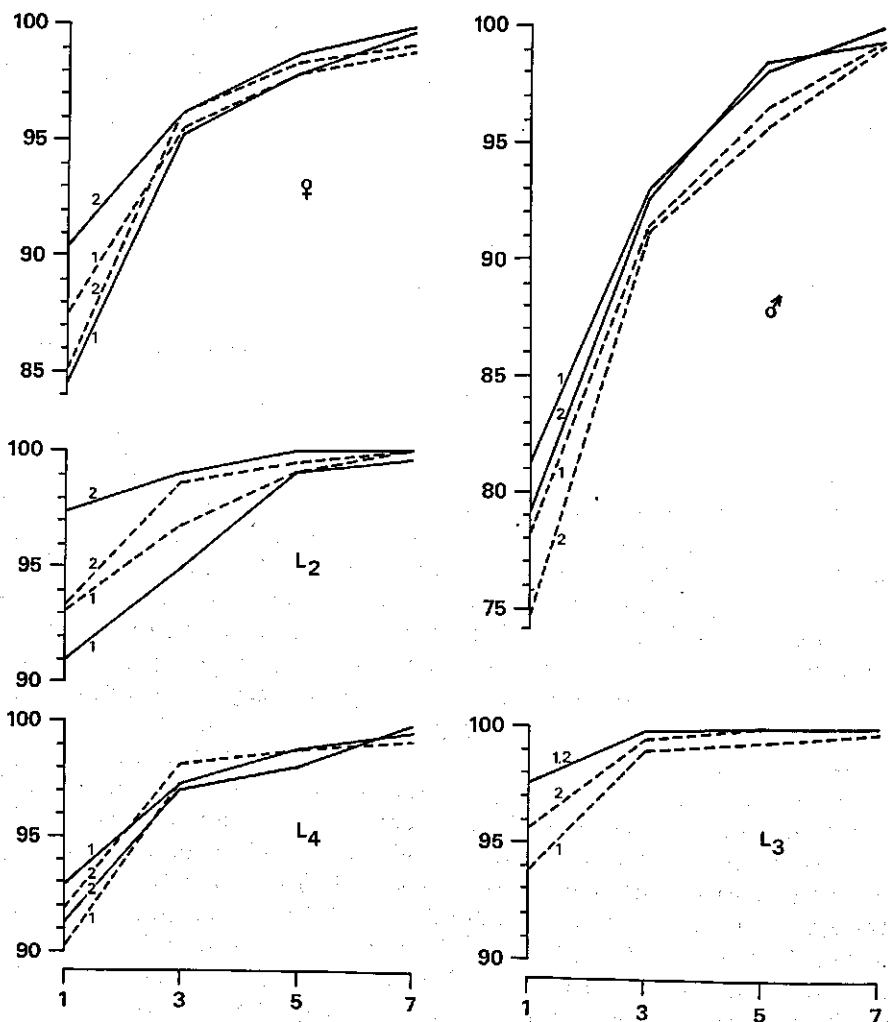

FIG. 18. Percentage of *T. dubius* from wet soil (W, solid lines) and dried soil (D, broken lines), extracted by decantation (1) and by spreading the soil directly on cottonwool filters (2), which passed through the extraction filters after 1, 3, 5 and 7 days, when the catch after 13 days is considered 100%. Separate graphs for females (♀), males (♂), L4, L3 and L2 larvae. Abscissae: time in days. Ordinates: percentage of nematodes.

Glass jars of 90 ml containing 25 g of soil were placed in a climate room at 18°C and 75% relative humidity. The pF value of the soil increased from 3.0 to 5.0 in 2 weeks and to 5.6 in the next 2 weeks, after which hardly any change occurred. The populations were analysed for males, females, and total larvae after 0, 4, 8, 16 and 24 weeks, each time on 5 replicate jars. Prior to extraction the soil was wetted in situ for 3 days and the nematodes collected

after 5 days. Also the effect of soil amendments on desiccation survival was investigated by adding fertilizer and organic manure to separate series of soil in jars. Thus 3 different soil series receiving the same desiccation treatment were obtained:

A – no additions.

B – addition of N.P.K. 12-10-18 fertilizer equivalent to 3300 kg per hectare (the electrical conductivity of the soil solution (saturation extract) increased from 1.2 to 9.1 millimho's per cm).

C – addition of dried cow-house manure equivalent to 10 tons per hectare.

The experiment was carried out simultaneously with the experiments in par. 3.2.2. to 3.2.5, in which the same soil series were subjected to constant and fluctuating, non-extreme moisture levels; the data can be compared.

The results are illustrated in figure 19. Rapid and strong drying almost eradicated *R. robustus* in all three soil series within 4 weeks, although a few nematodes survived up to 24 weeks. These were all L4 and L3 larvae; only an incidental single female survived. For *R. robustus* differences between soil treatments were small, but at the 8th week survival in fertilized soil was significantly better than in the two other soil series. *T. dubius* survived much better than *R. robustus* under the same circumstances. After 24 weeks, 45% on the average was still alive. Males were fully eradicated after 24 weeks. Unlike

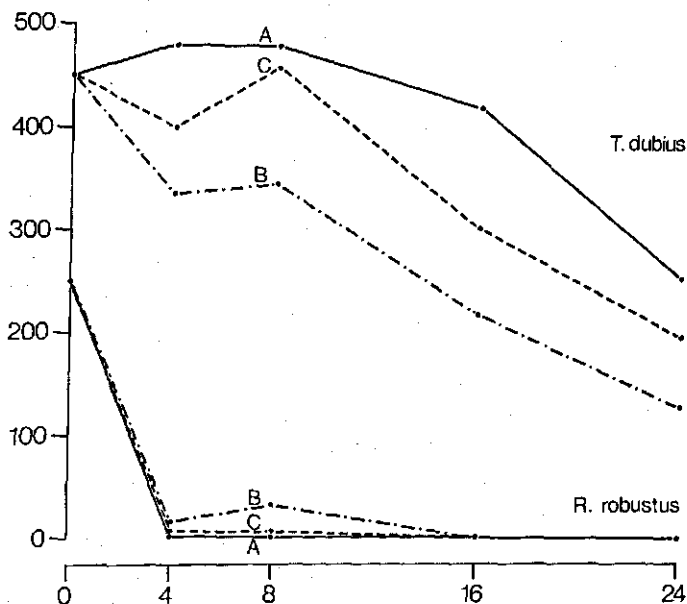

FIG. 19. Decline of natural populations of *T. dubius* and *R. robustus* in dry PD soil, either unamended (A) or amended with fertilizer (B) or organic manure (C), at constant temperature during a period of 24 weeks.

Abcissa: time in weeks.

Ordinate: number of nematodes.

R. robustus, the greatest reduction of *T. dubius* occurred in the soil with fertilizer, followed by soil with organic manure. Differences between the three soil series, which were significant except between A and C at the 8th week, were mainly determined by the reaction of the populations during the first period of desiccation. After the 8th week, the three populations decreased at about the same rate.

4.4. DISCUSSION

The results of experiments on the survival of natural populations of ectoparasites in dry soil have clarified a number of points.

1. Determining desiccation survival of ectoparasitic nematodes in soil requires special sampling and extraction techniques. Otherwise the number of active nematodes present is greatly underestimated. The actual numbers can be some hundreds to some thousands of percentages higher. The soil must be wetted for some time prior to handling it without disturbing the structure, otherwise the nematodes are irrecoverably injured. The final separation of nematodes from fine soil particles by means of filters should continue for several days, because nematodes recovered from desiccation appear to regain activity only slowly. The necessary period of time depends on the nematode species. In laboratory or greenhouse experiments, wetting of soil is simple. In case of sampling a dry field it means that the sampling areas must be watered some time in advance. Determination of the minimum wetting time required will then be useful. Also RÖSSNER (1971) observed increased numbers of nematodes from previously wetted soil.

These findings indicate that the susceptibility of nematode species to drought reported hitherto (1.3.3.) may have been overrated.

2. Many ectoparasitic nematodes appear to survive soil desiccation ($pF > 5$) remarkably well. Prolonged drying, however, can eradicate such populations, which indicates that these nematodes become quiescent or anhydrobiotic, rather than cryptobiotic as in case of the drought-resistant species *Ditylenchus dipsaci*, *Anguina tritici*, etc. Eradication of ectoparasitic species may still take a long time.

3. Susceptibility to desiccation varies distinctly between nematode species.

Species of *Tylenchorhynchus* and *Paratylenchus* are less susceptible than *Helicotylenchus*, and *Rotylenchus robustus* is much more susceptible than *Tylenchorhynchus dubius*. As in moist soil, survival in dry soil appears to be affected by the condition of the nematodes and the related time of crop removal (4.2.2.).

4. Susceptibility to desiccation varies also between developmental stages of the same species. The composition of a population at the onset of desiccation is therefore determinative for both size and composition of the surviving population. For *T. dubius* and *R. robustus* the order of increasing susceptibility is: L4 and L3 larvae; females; males; L2 larvae. A similar order has been reported for *T. dubius* by Sharma (1971), who found this sequence for starvation survival in moist soil.

In view of persistence of a population, good survival of L4 and L3 larvae seems to be obvious, because these stages will be able to reproduce soon after reactivation. At least part of the surviving larvae must then be developing males, as reproduction of *T. dubius* and *R. robustus* takes place by amphimixis. Further differentiation of developmental stages would possibly also prove that the majority of the surviving females are young females.

5. Eggs of ectoparasitic nematodes seem to be very susceptible to desiccation, which contradicts the general assumption that nematode eggs are highly resistant to adverse environmental conditions. It is probably incorrect to attribute the density rise of ectoparasitic nematodes at the onset of the rainy season mainly to hatching of eggs (KHAN, ADHAMI and SAXENA, 1971).

6. The initial rate of desiccation, which among other things can be influenced by soil structure, probably determines the length of the eradication time to a great extent.

7. Manuring of soil may aggravate the initial population decline due to desiccation for certain species, but it may reduce the adverse effect of drying for others (4.2.3.).

The aforementioned data indicate that dry fallow may be an efficient agricultural method of reducing nematode populations, but only with a strong and long-lasting drought. The efficiency depends on various factors:

1. Kind and composition of the nematode community, including species as well as developmental stages, and also whether the nematodes have been without a host for some time.

2. Type and structure of the soil throughout the tilth. This may affect rate as well as degree of desiccation and the depth of drought penetration. Most nematodes occur in the root layer, which is usually the upper 25 cm.

3. Relative humidity and temperature of the atmosphere and soil. These affect, again, rate and degree of desiccation. The extreme values, but also 24 hours sequences are important. The latter may cause temporary moisture fluctuations. It must be noted that temperature may rise above lethal values for nematodes and may therefore by itself be fatal.

More than one quarter of the world's land area consists of arid and semi-arid soils. Completely dry periods of several months, in which at least the top layer of the soil becomes air-dry, are common in these areas. It will be necessary to measure the efficiency of dry fallow in each area by means of field trials before the actual efficacy of this method for nematode control can be judged at its true value. This has not been done up to now.

5. DESICCATION SURVIVAL IN VITRO

Experiments on desiccation survival in soil have the disadvantage that quantitative and qualitative factors related to soil moisture are often not fully known and at any rate hard to control. Direct observation of nematodes in drying soil is also not possible or very difficult. Therefore, it is useful to study the effect of desiccation on nematodes in simplified artificial environments, making use of the relation between moisture tension (or pF') and relative humidity (r.h.) and the relation between r.h. and the composition of aqueous glycerine solutions in a closed container. Application of these principles has been outlined in chapter 2. Thus it is possible to make a continuous range of relative humidities from 99% to 10%.

In these studies desiccation must proceed gradually, as most nematodes are very susceptible to rapid drying. Desiccation in the field also takes place gradually, except perhaps for the very top layer of soil.

In the following in vitro experiments the species *T. dubius* and *R. robustus* are used. Only in the first experiment are many different genera employed.

5.1. GENERAL ASPECTS OF DESICCATION

Soils from four localities were mixed and the nematodes extracted. The resulting suspension comprised a mixture of species in various stages of development and was divided into four batches. The nematodes from three batches were exposed to 100%, 97.7%, or 96.0% r.h., using the membrane filter desiccation technique; the fourth batch of nematodes was kept in tap water. Details on the desiccation procedure are mentioned in table 10. At the end of the treatment all nematodes were individually examined for survival and counted together per genus. The entire experiment was carried out with four replicates. The main ectoparasitic nematodes were: *Tylenchorhynchus* (*dubius*, *quadrifer*, *maximus*, *ornatus* and *tessellatus*), *Helicotylenchus* (*pseudorobustus* and *varicaudatus*), *Rotylenchus* (*robustus*), *Paratylenchus* (*f* and *microdorus*), *Trichodorus* (*pachydermus*), *Criconemoides* (different species).

The results are summarized in table 10. After two days the nematodes still moved freely in the humid atmosphere of 100% r.h. They formed clusters on the membrane filters and showed no signs of shrinkage, although no free water was observed under a dissecting microscope at 50 times magnification. Also upon transfer into water nearly all nematodes immediately became active. The nematodes at 97.7% and 96.0% r.h. were inactive and somewhat shrunken, which indicates that loss of moisture had occurred. Nearly all nematodes regained activity within one hour after wetting. All tested species except *Trichodorus pachydermus* appeared to withstand slight desiccation at 97.7% r.h., which corresponds to pF' 4.50, for two days. At 96.0% r.h. (pF' 4.75)

TABLE 10. Percentage survival of different genera of ectoparasitic nematodes after 2 days exposure to three relative humidities and water, indicated as treatment 1, 2, 3 and 4.

1 = 48 hours at 100% r.h.

2 = 48 hours at 97.7% r.h.

3 = 24 hours at 97.7% r.h. + 24 hours at 96.0% r.h.

4 = 72 hours in a water layer of 2 mm.

Each percentage is the mean of 4 replicates.

Nematode genera	Treatment number (r.h.)				Significant differences according to Tukey's test after analysis of variance
	1 (100)	2 (97.7)	3 (96.0)	4 H ₂ O	
<i>Paratylenchus</i>	98.5	98.1	99.6	97.9	none
<i>Tylenchorhynchus</i>	91.6	90.4	64.6	96.4	3 lower than all others
<i>Rotylenchus</i>	96.7	94.4	93.9	97.4	none
<i>Helicotylenchus</i>	97.0	93.4	86.4	98.3	3 lower than 1 and 4
<i>Criconemoides</i>	100.0	98.2	97.0	92.9	none
<i>Trichodorus</i>	1.0	0.0	0.0	86.4	all treatments lower than 4

survival was not measurably lower than at 100% r.h. for *Paratylenchus*, *Rotylenchus* and *Criconemoides*. *Helicotylenchus* had suffered slightly and *Tylenchorhynchus* markedly. The relatively strong reduction of *Tylenchorhynchus* at 96.0% r.h. was not expected and indicates that one or more *Tylenchorhynchus* species are much more susceptible to desiccation than *T. dubius*. *Trichodorus* is completely eradicated even at 100% r.h. or slightly lower (cf. 2.3). It is at any rate clear that *Trichodorus pachydermus* is extremely susceptible.

5.2. RATE OF DESICCATION

The effect of the rapidity at which nematodes loose moisture was demonstrated by an experiment with females of *T. dubius* and *R. robustus*.

One batch of nematodes was directly transferred from water to 93.0% r.h. Another batch was brought from water to 93.0% r.h. gradually via intermediate relative humidities. The total duration of the treatment was the same for both groups. A third group was also gradually brought to 93.0% r.h., but was kept there longer to equalize about the actual desiccation with that of the rapid desiccation treatment (see table 11). The membrane filter desiccation technique was used; details on the desiccation procedure are given in table 11. The experiment was carried out with 4 replicate batches of 100 nematodes each.

The results are summarized in table 11. Rapid desiccation appeared to be more harmful than gradual desiccation for both species. Especially *R. robustus* was very susceptible to rapid desiccation.

TABLE 11. Percentage survival of females of *T. dubius* and *R. robustus* transferred from water to 93.0% r.h. directly or gradually as indicated by the treatment numbers 1, 2 and 3.

1 = 4 × 12 hrs at 93.0% r.h.

2 = 2 × 12 hrs at 97.7% + 12 hrs at 96.0% + 12 hrs at 93.0% r.h.

3 = 12 hrs at 97.7% + 12 hrs at 96.0% + 3 × 12 hrs at 93.0% r.h.

Each percentage is the mean of 4 replicates.

Nematode species	Treatment number			significant differences according to Tukey's test after analysis of variance
	1	2	3	
<i>T. dubius</i>	83.6	91.0	92.8	treatment 1 lower than 2 and 3
<i>R. robustus</i>	0.0	83.4	80.6	treatment 1 lower than 2 and 3

5.3. DEGREE OF DESICCATION

Females of *T. dubius* and *R. robustus* were exposed to a range of relative humidities, the values of which were based on a range of pF' values increasing with intervals of 0.25 (see also chapter 2). Using the glass slide desiccation technique, the nematodes were gradually dried according to the following schedule, which indicates the final degree of desiccation as well as the rapidity of the process.

r.h. (%)	Number of hours at the indicated r.h.					
100	12	12	12	12	12	12
97.7	156	12	12	12	12	12
96.0		144	12	12	12	12
93.0			132	12	12	12
87.9				120	12	12
79.5					108	12
66.5						96

Survival at each humidity level was determined after the common recovery period of 24 hours in water. The experiment was carried out with 6 replicates of 50 nematodes each.

The results are summarized in figure 20. Both *T. dubius* and *R. robustus* females show a significantly increasing mortality at decreasing relative humidities (increasing pF' values). This is probably due to a greater loss of moisture at the lower humidities. *R. robustus* appears to be more susceptible than *T. dubius*.

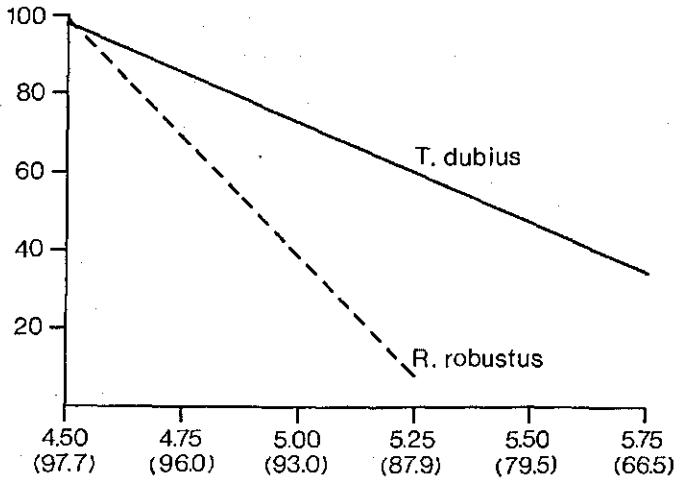

FIG. 20. Regression lines of percentages *T. dubius* and *R. robustus* females surviving 7 days of desiccation in vitro (y), on pF' values corresponding to the relative humidities applied (x) calculated from 6 replicates. r = regression coefficient.

T. dubius: $y = -40.56x + 280.92$ ($r = -0.78$)

R. robustus: $y = -121.20x + 644.70$ ($r = -0.94$)

Abscissa: pF' value and corresponding r.h.

Ordinate: percentage surviving nematodes

5.4. DURATION OF DESICCATION

Prolonged exposure to drought increased mortality of *T. dubius* and *R. robustus* in the soil experiments (cf. 4.3.). The following experiment deals with the effect of duration of desiccation in vitro.

Three times 5 batches of about 150 females of both *T. dubius* and *R. robustus* were gradually transferred to 93.0% r.h. and survival was determined after they remained there for 1, 5, 10, 15 and 20 days. The membrane filter desiccation technique was used. Five batches of nematodes were placed at 97.0% r.h. for 24 hours, next at 96.0% for 12 hours and then at 93.0% for 1, 5, 10, 15 and 20 days respectively for the first to the fifth batch.

The results are summarized in figure 21. The mortality of both species increased with time. Loss of moisture apparently is a gradually proceeding process, of which the rate may depend on the humidity level of the environment and on properties of the nematode. Physiological processes during desiccation may also play a role. After 10 days mortality of both species declined, which may indicate a falling rate of moisture loss. This has been observed earlier with populations of these species in soil (cf. 4.3.). Also here, survival of *R. robustus* was less than that of *T. dubius*.

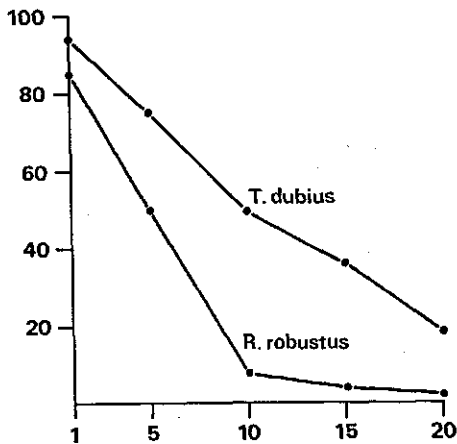

FIG. 21. Survival of *T. dubius* and *R. robustus* females after 1, 5, 10, 15 and 20 days exposure to 93.0% r.h.

Abscissa: exposure time in days.

Ordinate: percentage surviving nematodes.

5.5. FLUCTUATING DEGREES OF DESICCATION

In a dry soil under field conditions, the relative humidity fluctuates due to changing temperatures. Decrease of the temperature during the night will cause a rise of the relative humidity and may even cause condensation, especially in the upper soil layers. Nematodes may therefore often be exposed to strongly fluctuating humidities of the air. This may be favourable to the nematodes because they can take up moisture when the relative humidity is high, but it may also be unfavourable since they have to adjust themselves continuously. The next experiment attempts to clarify this question.

Three batches of 300 nematodes each were gradually brought down to 93.0% r.h. and held there for a certain period. Three other similar batches were exposed to humidities fluctuating between 100 and 93.0% r.h. for the same period. Females of both *T. dubius* and *R. robustus* were tested in this way, using the membrane filter desiccation technique. Details on the desiccation procedure and the results are given in table 12.

TABLE 12. Percentage survival of females of *T. dubius* and *R. robustus* after 4 days exposure to fluctuating and non-fluctuating relative humidities as indicated by the treatment numbers 1 and 2. Each percentage is the mean of three replicates.

1 = 12 hrs at 97.7% + 5 hrs at 96.0% + 3 days and 5 hrs at 93.0% r.h.

2 = 12 hrs at 97.7% + 5 hrs at 96.0% + 5 hrs at 93.0% r.h. and during 3 days: 14 hrs at 100% + 3.5 hrs at 97.7% + 3.5 hrs at 96.0% + 3.5 hrs at 93.0% r.h.

Nematode species	Treatment numbers		Differences between treatments (Analysis of variance, Tukey's test)
	1 (non-fluctuating r.h.)	2 (fluctuating r.h.)	
<i>T. dubius</i>	83.1	90.8	significant
<i>R. robustus</i>	39.8	57.2	significant

For both species, fluctuating humidities are favourable compared with non-fluctuating humidities. Again *T. dubius* is less susceptible to desiccation than *R. robustus*.

5.6. ACTIVE NEMATODE STAGES

The soil experiments indicated that the different developmental stages of *T. dubius* and *R. robustus* may not be equally susceptible to desiccation. This was further investigated in the following experiment in which the 5 active developmental stages, i.e. males, females, fourth, third and second stage larvae of both *T. dubius* and *R. robustus* were tested for desiccation survival at different relative humidities. The nematodes were desiccated exactly in accordance with the schedule in par. 5.3, using the glass slide desiccation technique.

Figure 22 shows the regression lines for all stages of both species. The data on females are the same as those of par. 5.3, as the experiments have been carried out simultaneously. Survival decreases with increasing pF' values or decreasing relative humidities for all stages of both species. Differences in susceptibility to desiccation are reflected by the inclination of the regression lines, i.e.

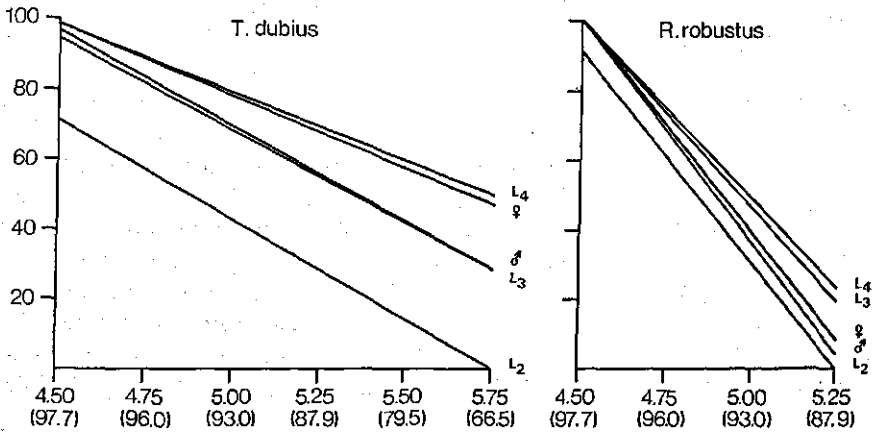

FIG. 22. Regression lines of percentages *T. dubius* and *R. robustus* surviving 7 days of desiccation in vitro (y), on pF' values corresponding to the relative humidities applied (x), calculated from 6 replicates, separately for females (♀), males (♂), L4, L3 and L2 larvae. r = regression coefficient.

Abscissae: pF' value (and corresponding r.h.)

Ordinates: percentage surviving nematodes.

<i>R. robustus</i>	(r)	<i>T. dubius</i>	(r)
♀	$y = -121.20x + 644.70$ (-0.94)	♀	$y = -40.56x + 280.92$ (-0.78)
♂	$y = -126.53x + 668.60$ (-0.98)	♂	$y = -54.48x + 341.86$ (-0.81)
L4	$y = -100.80x + 552.70$ (-0.91)	L4	$y = -39.44x + 275.78$ (-0.81)
L3	$y = -104.27x + 567.40$ (-0.92)	L3	$y = -52.00x + 328.50$ (-0.82)
L2	$y = -121.69x + 638.92$ (-0.93)	L2	$y = -56.86x + 327.65$ (-0.89)

the differences between the regression coefficients, and by the distances between the lines. For *T. dubius* the regression coefficients of the 2nd and the 4th stage larvae differ significantly. The average percentage survival of the 2nd stage larvae is also lower than for all other stages, whereas males and 3rd stage larvae are at a lower level than females and 4th stage larvae except at pF' 4.50. This means that the differences between the stages of *T. dubius* are mainly determined by their susceptibility at the onset of desiccation, whereas 2nd stage larvae are also relatively more susceptible at lower humidities. For *R. robustus*, the average percentage survival of 2nd stage larvae was also lower than that of all other stages and the level of males was lower than that of 4th stage larvae except at pF' 4.50. The regression coefficients show that males and 2nd stage larvae are also significantly more susceptible to increasing desiccation than 3rd and 4th stage larvae. The greater susceptibility of *R. robustus* over *T. dubius*, as recorded already with previous experiments, is very obvious here and appears to hold for all active stages.

5.7. NEMATODE EGGS

Preliminary tests *in vitro* indicated that eggs are more susceptible to desiccation than active nematodes and also that recently laid eggs are more susceptible than older eggs. This is investigated further in the following experiments with eggs of *R. robustus*.

Experiment 1. Batches of about 70 *R. robustus* eggs of different ages, viz. 1, 5, 10 and 15 days after being laid, were exposed to desiccation at 96.0% and 93.0% r.h., after which survival was determined by subsequent hatch in water. Other batches of eggs, all being laid on the same day as the desiccated eggs, were not desiccated and served as controls. There were three replicate batches for each age-group and each treatment. The eggs were obtained by placing 50 gravid females, collected from soil, in a thin layer of tap water on a glass cavity slide. After one day, when about 70 eggs had been laid, the females were removed. The eggs were stored at 20°C until they reached the required age. They were then exposed to desiccation according to the following schedule, using the glass slide desiccation technique.

r.h. (%)	Number of hours at the indicated r.h.	
100	12	12
97.7	12	12
96.0	24	12
93.0		24

After the desiccation treatments, the eggs were placed in tap water again and observed daily.

The final number of hatched eggs, calculated as a percentage of the total number of eggs for each treatment, is given in table 13.

TABLE 13. Percentage hatch of *R. robustus* eggs desiccated at 4 different ages and percentage hatch of non-desiccated eggs (control).

Desiccation treatment	Age of eggs in days				Average
	1	5	10	15	
96.0% r.h.	0	3.7	10.6	63.9	22.3
93.0% r.h.	0	0	1.4	18.5	5.5
Control					95.3

The results leave no doubt regarding the following three points:

- desiccation of eggs reduces their subsequent hatch in water;
- desiccation at 93.0% r.h. is more harmful than desiccation at 96.0% r.h.;
- eggs of 15 days old survive desiccation better than younger eggs.

All these phenomena are statistically significant according to an analysis of variance and Tukey's test.

Figure 23 shows that non-desiccated eggs and 15 days old desiccated eggs hatch differently but in about the same time, for hatching was completed within about 8 days from the first hatch for all batches. Eggs of 15 days desiccated at 93.0% r.h. started hatching 2 days later than those treated at 96.0% r.h. or the controls. Treated eggs of 10 days or younger, if surviving, started hatching 3 to 4 days later than the controls. (This is not represented in figure 23).

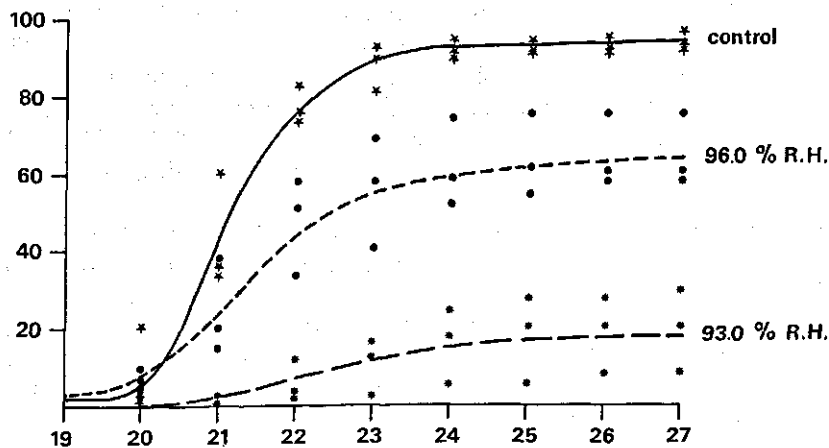

FIG. 23. Cumulative hatch in water of 15 days old *R. robustus* eggs desiccated at 96.0% and 93.0% r.h. and of undesiccated eggs, with time.

Abscissa: age of eggs in days.

Ordinate: percentage hatch.

Experiment 2. Survival of eggs of *R. robustus* was compared with survival of active nematode stages by giving eggs of 15 days a desiccation treatment applied before to active stages, viz. 12 hours at 100% + 12 hours at 97.7% + 12 hours at 96.0% + 132 hours at 93.0% r.h. (cf. 5.3 and 5.6). Survival was determined by subsequent hatch in water. In three replicate batches of 100 eggs, no eggs survived. This means that the L1 and L2 larvae inside the egg are even more susceptible to desiccation than free L2 larvae.

Experiment 3. When the treatment of experiment 2 was given to 70 *Tylenchorhynchus dubius* eggs 7 days old, 26% survived. This indicates that the eggs of *T. dubius* are more drought resistant than the eggs of *R. robustus*.

5.8. INFLUENCE OF INORGANIC SALTS

The possible influence of salts has been excluded in the previous desiccation experiments in vitro by bringing the nematodes in demineralized water shortly before desiccation (see 2.3.). Composition and osmotic pressure of the soil solution, however, may be important for desiccation survival of nematodes, and their effects may be complex. The various salts present in different concentrations have different solubilities. Also the activity coefficients of the salts differ greatly and they change with altering concentrations. Nematodes are known to take up ions and molecules from a solution and to release them (see 1.2). Increasing salt concentrations of the soil solution cause higher salt concentrations inside the nematode which probably depends on the composition and the concentration of the solution. The subsequent effect of desiccation will probably also be influenced by the composition and concentration of salts inside the nematode. Retarded loss of moisture due to the higher osmotic pressure of the nematode must at any rate be expected.

The following experiment explores the questions regarding the effect of inorganic salts on the desiccation of nematodes. After pretreatment in solutions of sodium chloride at different concentrations, females of *T. dubius* and *R. robustus* were exposed to desiccation and examined for survival after transfer into tap water.

Salt treatments. The nematodes were divided into 4 equal batches, a control batch and three batches which were separately placed into a 0.01 N solution of NaCl and treated as follows:

- Series 1: with evaporation prevented. The nematodes remained in the 0.01 N solution for 2.5 days.
- Series 2: with the concentration of the solution increased to 0.05 N in 2.5 days by forced evaporation with a ventilator.
- Series 3: with the concentration of the solution increased to 0.1 N in 2.5 days as in series 2.
- Series 4: with nematodes placed into demineralized water and held there for 2.5 days.

Many specimens, especially of *T. dubius*, did not survive the treatment of series 2 and 3.

Desiccation. The gradual desiccation technique was used (2.3., technique 3). Living nematodes were picked from the different solutions and collected in a drop of the same solution on a glass slide. Before transfer into the humidity chamber, the solution was removed. In the first 24 hours, the relative humidity decreased gradually from 100% to 96.6% and in the following 11 hours to 87.9%, where the nematodes remained for another 24 hours. Examination for survival took place after a 24 hours' recovery period in tap water.

This experiment was carried out with 7 replicates of 150 females per species.

Nematodes pretreated in the 0.05 and 0.1 N solutions were not visibly shrunk after the desiccation treatment, whereas the specimens from water and the 0.01 NaCl solution clearly showed signs of moisture loss.

The data on survival are summarized in table 14. The pretreatment with NaCl solutions appears to influence desiccation survival of both nematodes markedly, although in a different way. Survival of *T. dubius* is highest after pretreatment in demineralized water, whereas survival of *R. robustus* is lowest then. The presence of the salt has increased the chance for survival of *R. robustus* and is harmful to *T. dubius*. The harmful effect on *T. dubius* may be a direct toxic effect of the salt itself on the nematode. This assumption is strengthened by the observation that many specimens of *T. dubius* did not survive pretreatment in the 0.05 and 0.1 N solution of NaCl, whereas *R. robustus* survived quite well.

TABLE 14. Percentage desiccation survival of *T. dubius* and *R. robustus* females at 87.9% r.h. after pretreatment in different solutions of NaCl and in water. Each percentage is the mean of 7 replicates.

Nematode species	Conc. NaCl solution at pretreatment				sign. differences (analysis of variance, Tukey's test)
	0	0.01N	0.05N	0.1N	
<i>T. dubius</i>	64.8	44.3	10.0	0.0	0 > 0.05 and 0.1; 0.01 > 0.1
<i>R. robustus</i>	1.3	16.6	24.3	15.9	0 < all others

To obtain more information on this point, an additional experiment was carried out. About 1000 specimens of *T. dubius* and 200 *R. robustus* were put in the following 5 solutions: demineralized water, 0.005 M NaCl, 0.05 M NaCl, 0.005 M mixed salt solution and 0.05 M mixed salt solution. The mixed salt solution of 0.01 M contained the following salts at the indicated concentrations in gram molecules $\times 10^{-6}$; KCl 872; $\text{Ca}(\text{NO}_3)_2 \cdot 4\text{H}_2\text{O}$ 1695; KNO_3 792; $\text{NaH}_2\text{PO}_4 \cdot \text{H}_2\text{O}$ 239; $\text{MgSO}_4 \cdot 7\text{H}_2\text{O}$ 730; Na_2SO_4 5634; H_3BO_3 61; $\text{MnSO}_4 \cdot \text{H}_2\text{O}$ 201; KI 181; $\text{ZnSO}_4 \cdot 7\text{H}_2\text{O}$ 209. All solutions were allowed to evaporate slowly at 20°C until their volumes decreased to one tenth after 6 weeks. Survival of the nematodes was then determined. The trial was carried out in duplicate.

TABLE 15. Percentage survival of *T. dubius* and *R. robustus* after 6 weeks in various salt solutions at gradually increasing concentrations. Significant differences are linked with arrows.

Initial/Final concentration of the solutions	<i>T. dubius</i>	<i>R. robustus</i>
0	79.0	91.6
0.005/0.05 M salt	76.2	90.6
0.05 /0.5 M salt	71.3	82.8
0.005/0.05 M NaCl	79.9	96.6
0.05 /0.5 M NaCl	51.9	86.3

The results are presented in table 15. The strong solution of NaCl (0.5 M) is more harmful to *T. dubius* than any of the other solutions. This indicates that high concentrations of NaCl are directly toxic to this nematode and may explain the complete killing by desiccation of *T. dubius* pretreated in a 0.1 N solution of NaCl. Low desiccation survival of *T. dubius* pretreated in a 0.05 N NaCl solution may also be caused by an increased concentration of NaCl, or one of its ions, inside the nematode due to water loss by desiccation, despite the fact that a 0.05 N NaCl solution as such is not harmful to this species (see table 15). Also the rate of concentration increase inside the nematode due to desiccation may be of importance. *R. robustus* is not susceptible to treatment with the strong NaCl solution. Better desiccation survival of this nematode species after pretreatment with NaCl in comparison with untreated nematodes, may be caused by a higher osmotic pressure inside the nematode. This may either reduce the amount of water lost or the rate of water loss. Also, physiological changes inside the nematode or of its integument may be responsible for the better tolerance of desiccation after treatment with NaCl.

The overall differences in survival in various salt solutions between *T. dubius* and *R. robustus* (table 15) indicates a higher sensitivity of *T. dubius* to osmotic effects. Resistance to osmotic pressure is therefore not a good indication for desiccation resistance, for under normal conditions *T. dubius* survives desiccation far better than *R. robustus*.

It is at any rate clear that salt solutions may on the one hand kill nematodes and on the other hand induce higher drought resistance. This may occur in drying fields fertilized with comparable dosages.

5.9. INFLUENCE OF CARBON DIOXIDE

The composition of the soil air and particularly the O₂/CO₂ ratio may vary. In very dry soil with little biological activity the soil air may hardly differ from the atmospheric air, which contains about 0.05% CO₂. In soil at about pF'4, when nematodes start losing moisture, the CO₂ content can be at least 10-fold or higher.

In the following experiment the possible influence of a high CO₂ concentration in the air on desiccation survival of nematodes is investigated. Females of *T. dubius* and *R. robustus* were desiccated on a membrane filter as follows: 24 hours at 98.0% r.h., 24 hours at 96.0% and 24 hours at 93.0%. The composition of the air in the humidity chambers was changed by first saturating the water-glycerine mixture with CO₂. After several hours, the air in the chambers was replaced by a gas mixture containing 80% N₂, 10% O₂ and 10% CO₂. This was achieved by pumping an excess of the gas through the chambers. Six hours later, the nematodes were brought into the chambers. The CO₂ content of the air in the chambers was determined before and after desiccation of the nematodes by treating an air sample with barium hydroxide of known normality and then titrating under nitrogen the excess of barium hydroxide with hydrochloric acid. The CO₂ content in the chambers varied from 5% to 15%. For comparison, nematodes were desiccated at unmodified conditions. The experiment was carried out with 3 replicate batches of about 300 nematodes of each species.

The results, summarized in table 16, show that the CO₂ treatments did not cause significant differences, and it must be concluded that the amount of carbon dioxide in the soil air does not influence the process of desiccation. As in previous experiments percentage survival of *T. dubius* was significantly higher than for *R. robustus*.

TABLE 16. Percentage desiccation survival of females of *T. dubius* and *R. robustus* at 93.0% r.h. and at atmospheric (–) and increased (+) CO₂ concentration of the air.

Replicates	<i>T. dubius</i>		<i>R. robustus</i>	
	+CO ₂	–CO ₂	+CO ₂	–CO ₂
1	95.4	93.7	68.3	65.3
2	91.5	93.2	78.2	58.6
3	93.7	94.8	60.1	61.6

5.10. DISCUSSION

The experiments on desiccation survival of ectoparasitic root-infesting nematodes *in vitro* have confirmed some findings on desiccation survival in soil and clarified other aspects of the nematode's response to a shortage of moisture.

Many species of ectoparasitic nematodes can withstand slight desiccation. Populations of 12 species from 5 genera comprising all stages of development were not affected by a few days desiccation at a relative humidity corresponding to pF' 4.5 and the nematodes became active within one hour upon remoistening (5.1.). This implies that these nematodes are able to withstand conditions which are most unfavourable to plants and also that normal life processes in nema-

todes can proceed shortly after rewetting of the soil. About half the number of both the relatively drought-resistant species *Tylenchorhynchus dubius* and the rather susceptible species *Rotylenchus robustus* are able to survive desiccation in vitro at humidities corresponding to pF' 5.0 for one week. These data, together with the results of experiments in soil, provide sufficient evidence to contradict the opinion that only few species of nematodes are able to survive desiccation (ELLENBY, 1969). Tolerance of drought appears to be rather a general phenomenon in plant nematodes.

Susceptibility to desiccation varies for different ectoparasitic nematode species and some species are highly susceptible indeed. This is well demonstrated by the distinct differences in survival between *T. dubius* and *R. robustus* 5.2–5.6) and by the inability of *Trichodorus pachydermus* to survive 2 days at relative humidities near 100% (5.1). The observations on *T. dubius* and *R. robustus* agree with the experimental results of these two species in soil. High susceptibility of *Trichodorus* species to desiccation in soil has been mentioned by RÖSSNER (1971). Corresponding differences between reactions to drought in the field and in vitro have been demonstrated also for L2 larvae of *Heterodera rostochiensis* and *H. schachtii* by ELLENBY (1968a). Experiments by KÄMPFE (1959) failed to show such differences for the same *Heterodera* species, probably due to application of inappropriate desiccation methods. The ability of *T. dubius* to survive rather dry conditions, together with its polyphagy (SHARMA, 1971), may be reasons for its general distribution in the Netherlands and neighbouring countries. It could be spread by wind.

Susceptibility to desiccation varies for different developmental stages of the same species. That the differences between the stages observed in vitro are not fully in conformity with the results from experiments with soil may be explained by different composition of the groups of stages. If, for instance, the in vitro tested females are mainly young females, whereas in soil the young and old specimens are equally numerous, survival in vitro will probably be better than in soil. Unvoluntary selection, while picking certain stages from a mixture of stages for in vitro tests, may also cause such differences.

Eggs of ectoparasitic nematodes appear to be more susceptible to desiccation than active stages, which confirms the finding from experiments with eggs in soil. This is not in agreement with the general assumption that the egg stage is probably one of the most important stages for survival in the life cycle of the nematode. A sticky protein or lipoprotein coat around the egg, as has been observed for eggs of a number of nematode species, should protect it (VAN GUNDY, 1965). A sticky coat has been observed also around eggs of *T. dubius* and *R. robustus*, but nevertheless they are very susceptible to desiccation.

Several other factors generally increase the susceptibility of nematodes to desiccation. These include a high rate, a high degree, and a long duration of desiccation. On the other hand, survival is favourably influenced by intermediate rises of the air humidity, which means that fluctuations of the humidity due to day and night sequences will aid nematode survival during drought, especially in the top layers of the soil.

The carbon dioxide content of the soil air has no influence on desiccation survival.

The chemical composition of the soil solution can probably affect desiccation survival both positively and negatively, by which osmotic pressure of the pseudocoelomic fluid as well as intoxication can play a role. The assumption that susceptibility to osmotic pressure and to desiccation are essentially different is supported by comparable observations on eggs of *Meloidogyne javanica* by WALLACE (1968).

In most reports on desiccation survival of nematodes *in vitro*, survival time had to be measured in minutes (LEES, 1953; ENDO, 1962; ELLENBY, 1968a,b). High rates of desiccation will be mainly responsible for these short periods of survival, as in all cases, the nematodes tested were directly subjected to low humidities. Such desiccation studies with rapid water loss may obscure important phenomena, because relevant observations may be hindered by the speed of the process. On the other hand the importance of a reduced rate of desiccation for better survival has been emphasized earlier for *Panagrellus silusiae*, *Trichostrongylus colubriformis* larvae and larvae of *Haemonchus concortis* (LEES, 1953; ANDERSEN & LEVINE, 1968; ELLENBY, 1968a,b,c). Using interference microscopy ELLENBY (1968) and PERRY and ELLENBY (1972) related differences in ability of nematodes to survive desiccation with rates of water release. In comparative studies with larvae and eggs of *Heterodera rostochiensis*, *H. schachtii* and *Ditylenchus dipsaci* gradually decreasing loss of water was observed for 'resistant' specimens, which was attributed to changing permeability of the cuticle or egg shell during the process of desiccation. The amount or kind of lipids present on or in the cuticle (VAN GUNDY, 1965) may play a role. On the basis of electron microphotographs of the surface of desiccated *R. robustus* specimens, RÖSSNER (1972) assumes that water loss of this nematode is reduced by regular compression of the transverse annules, which shrinks the nematode. Other factors may be also involved in desiccation survival, for ensheathed larvae of *Haemonchus concortis* dry less rapidly than L4 larvae of *Ditylenchus dipsaci*, but *D. dipsaci* is far better at surviving desiccation (ELLENBY, 1968c, 1969). One of these factors may be the nematode's epidermis or a cell membrane separating the epidermis from the cuticle (WRIGHT, 1963; ROGGEN et al., 1967). Most investigators have emphasized the properties and function of the nonliving cuticle, but hardly anything is known about the function of the living epidermis or the presence and function of the mentioned cell membrane with respect to regulation of intake or release of water or other substances.

It appears that many mechanisms may be involved and that the interpretation of the effects of desiccation on nematodes to a large extent is still hypothetical. The complex picture of the various effects of drought on nematodes may be somewhat clarified by following LEVITT's (1972) schemes of drought effects on plants. LEVITT distinguishes between drought stress and the resulting drought strain. Stress may be primary (water deficiency) or secondary (f.i. high salt concentration). Strain may be elastic (non-injurious) and plastic (injurious);

elastic strain may turn into plastic strain with time. Strain may also be direct (dehydration) or indirect (f.i. metabolic). The experiments with ectoparasitic root-infesting nematodes concerned primary as well as secondary stress and elastic as well as plastic strain. It was not established whether the imposed strains were direct or indirect and what the actual mechanisms were.

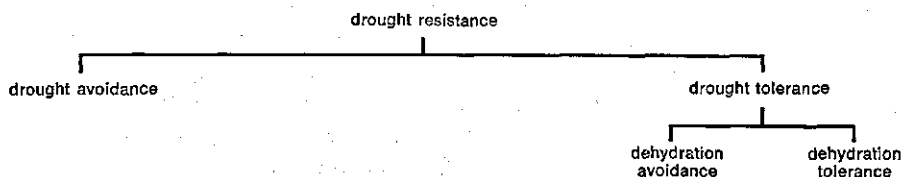

FIG. 24. Primary scheme of drought resistance in nematodes.

Besides causing strain and possibly injury, drought stress may reveal and possibly induce stress resistance, which again may be elastic (preventing elastic strain) or plastic (preventing plastic strain). Two kinds of drought resistance can be distinguished: drought avoidance and drought tolerance; the latter can be subdivided into dehydration avoidance and dehydration tolerance (see fig. 24). Drought avoidance is probably not found in nematodes, but drought tolerance may be common. Examples of dehydration avoidance as well as dehydration tolerance have been mentioned above. Ectoparasitic root-infesting nematodes demonstrate dehydration tolerance, which is less than that for stem and leaf nematodes like f.i. *Ditylenchus dipsaci*, but which is nevertheless much greater than could be expected before our experiments started.

6. SUMMARY

Established nematode populations are very persistent in the soil. It is known that they need sufficient soil moisture for movement, feeding and reproduction (fig. 5), and that there are adverse soil moisture conditions which they cannot survive. The influence of soil moisture on survival of nematodes and nematode populations is the topic of this study. The investigations are made under laboratory conditions and are concentrated on ectoparasitic root-infesting nematodes, particularly *Tylenchorhynchus dubius* and *Rotylenchus robustus*, in fallow soil and in vitro. The animals chosen represent the large group of un-specialized plant-parasitic nematodes, which pass their entire life in the soil and which do not possess any apparent mechanisms against drought. All investigations on populations have been carried out with natural soils and their indigenous nematode populations (2.1.1. and 2.2.1.).

The gross relationships between the three major soil phases and nematodes are summarized in figure 1; the nematodes themselves, though numerous, may be neglected as a factor in soil formation or as a soil component. Figure 2 lists the various soil moisture potentials which may affect nematode survival. The relationships between pF value and soil moisture content (figs. 3 and 6) and between pF' value and relative humidity of the air (fig. 4) are discussed as tools in this study (see also chapter 2). Distinction between soil moisture quality and quantity, and regarding the latter between three essentially different situations, viz. water-saturated soil, unsaturated moist soil and dry soil, appeared to be useful. The limit between unsaturated and dry soil cannot be indicated accurately with respect to nematode biology, because essential data about the physical and chemical properties of nematodes are lacking. The limit may vary for different species, stages of development or even individual nematodes (1.3.3.).

The extensive literature survey (chapter 1) shows that many incidental data are available, but the information is yet too erratic to draw a coherent picture of the relations between soil moisture and nematode survival. This is particularly so because quantity and quality of soil moisture are often not considered separately. One conclusion may be that nematodes generally are proof against moisture conditions which both chemically and physically differ widely from their normal average environment. Reduced activity is the first visible symptom of a reaction to environmental stress, which may affect various species differently (1.2.).

In water-saturated soil, nematode populations were reduced to about 20% after 20 weeks (fig. 9) and there were indications that considerable reduction had occurred already after 12 weeks. This confirms the general opinion that saturated soil is unfavourable for most nematodes due to chemical properties of the soil solution as a result of microbiological activity (1.3.1.).

The results of experiments in unsaturated soil indicate that survival of ecto-

parasitic nematodes in fallow soil at pF values between 0.5 and 4 is not directly affected by soil moisture quantity (figs 10, 11A and 12A). This can also mean that these nematodes are not or hardly active in moist fallow soil (3.3.). Under such conditions also the quality of the soil solution, as influenced by normal manuring, has no measurable influence on survival of populations (figs. 11B,C and 12B,C). Great qualitative modifications by excessive dressings with chemicals may cause damage (table 15), as indicated in the literature (1.3.2.).

Drought is generally considered harmful to nematodes and especially to ectoparasites, although in literature several cases of drought-tolerance in such nematodes are mentioned (table 1). When investigating the response of nematodes to desiccation, the graduality of the processes of dehydration and rehydration appear to be most important. Dehydration must proceed gradually, particularly for in vitro studies, because nematodes are killed by unnatural, rapid loss of water. For that purpose three slightly different desiccation techniques have been developed, making use of the relationship between the concentration of aqueous glycerine solutions and the relative humidity of the air in a closed room (2.3.).

Rehydration of desiccated nematodes and regaining activity thereupon requires time. This necessitates the application of adapted methods for the extraction of nematodes from dry soil, because otherwise only a fraction of the living nematodes would be caught (figs. 13 and 14).

Experiments in soil as well as in vitro have demonstrated that ectoparasitic root-infesting nematodes generally are drought-tolerant to a certain extent (figs. 16, 17A, 19, 20). As already mentioned, desiccation survival depends on the rate of water loss (table 11), but also the degree and duration of desiccation are important (figs. 20 and 21). Diurnal changes of the relative humidity of the soil air aid nematodes to survive (table 12). Both experiments in vivo and in vitro showed great differences in drought-tolerance between nematode species (figs. 16, 17A, 19-22) and also between various stages of development (figs. 17B and 22). The general assumption that nematode eggs are important for restoration of populations upon severe drought, as a result of their exceptional drought-resistance, is contradicted by the experimental results for ectoparasites 4.3.2. and 5.7.).

Regarding the influence of chemical properties of soil moisture in dry(ing) soil, more research, distinguishing primary and secondary effects, appears to be necessary. The experimental results indicate fundamental differences, viz. increased drought-tolerance of one species and intoxication of another species under the same conditions (fig. 19, table 14), and also that loss of water in a dry atmosphere affects nematodes other than loss of water to a surrounding solution (5.10.).

Systematic differentiation of the reactions of nematodes to drought or any other environmental stress, analogous to systems used for plants, seems to be useful (5.10).

Eradication of ectoparasitic root-infesting nematodes in fallow soil merely by maintaining non-extreme soil moisture conditions is hardly possible (figs. 9,

10, 11). Under extreme moisture conditions nematodes can be eradicated, but the process requires a long time (table 8, figs. 9, 16, 17, 19). However, partial nematode control with about 80% mortality, which is comparable with the effect achieved by chemical control, is considered sufficient for safe crop growth. In rapidly and strongly desiccated soil (pF 5.5) 80% mortality can be achieved in a rather short period of time. For a number of susceptible species, such reduction occurred in 4 weeks or less and for more tolerant species the period varied from 10 to more than 24 weeks (table 8, figs. 16, 17, 19). Long lasting periods of severe drought occur in arid and semi-arid areas (4.4). Efficient control of nematodes by dry fallow, possibly in combination with soil tilling at the right time, seems to be possible in these areas.

7. SAMENVATTING

In de bodem voorkomende nematodenpopulaties zijn zeer persistent. Het is bekend dat voor beweging, voeding en vermeerdering van nematoden de aanwezigheid van voldoende bodemvocht vereist is en ook dat zij onder ongunstige vochtomstandigheden dood gaan. In deze studie is de invloed onderzocht van bodemvocht op de overleving van nematoden, in het bijzonder van ectoparasitaire wortelnematoden. De soorten *Tylenchorhynchus dubius* en *Rotylenchus robustus* zijn gekozen als vertegenwoordigers van deze grote groep van planteparasitaire nematoden waarvan de gehele levenscyclus zich in de grond voltrekt. Het onderzoek betreffende populaties is uitgevoerd in het laboratorium en in kassen met natuurlijke onbegroeide gronden en de daarin voorkomende nematoden. Onderzoek naar de invloed van droogte is ten dele ook in vitro uitgevoerd.

In figuur 1 is in grote lijnen het verband tussen de drie bodemfasen en nematoden weergegeven. Het overzicht in figuur 2 geeft de verschillende bodemvochtpotentialen die de overleving van nematoden kunnen beïnvloeden. De relaties tussen de pF-waarde en het vochtgehalte van de grond (fig. 3 en 6) en tussen pF'-waarde en de relatieve luchtvochtigheid (fig. 4) zijn als hulpmiddelen bij dit onderzoek besproken. Ten aanzien van bodemvocht bleek het nuttig te zijn onderscheid te maken tussen kwaliteit en kwantiteit, en voor wat betreft de laatste tussen verzadigde grond, onverzadigde vochtige grond, en droge grond. De grens tussen onverzadigde en droge grond kan met betrekking tot de biologie van nematoden niet nauwkeurig worden aangegeven, omdat de hiervoor noodzakelijke gegevens over de fysische en chemische eigenschappen van nematoden niet bekend zijn. Deze grens kan voor verschillende soorten, ontwikkelingsstadia, of zelfs individuele nematoden verschillend zijn (1.3.3.).

Het literatuuronderzoek (hoofdstuk 1) toont aan, dat hoewel veel op zichzelf staande gegevens beschikbaar zijn, nog geen samenhangend beeld van de relatie tussen bodemvocht en het overleven van nematoden kan worden gegeven. Dit vindt vooral zijn oorzaak in het feit dat kwantiteit en kwaliteit van bodemvocht meestal niet in combinatie worden beschouwd. Als algemene conclusie kan wel worden gesteld dat nematoden doorgaans bestand zijn tegen een milieu dat zowel chemisch als fysisch sterk afwijkt van de normale omstandigheden. De eerste zichtbare reactie op ongunstige omstandigheden is verminderde activiteit van de nematoden, waarbij de soorten verschillend kunnen reageren (1.2).

In met water verzadigde grond werden verscheidene populaties in 20 weken tot ongeveer 20% gereduceerd (fig. 9) en er waren aanwijzingen dat na 12 weken reeds een aanzienlijke daling van het aantal nematoden had plaats gevonden. Dit bevestigt de reeds bestaande mening dat verzadigde grond voor de meeste nematoden ongunstig is, hetgeen wordt toegeschreven aan chemische eigenschappen van de bodemoplossing ten gevolge van microbiologische activiteit onder deze omstandigheden (1.3.1).

De resultaten van experimenten in onverzadigde grond tonen aan dat tussen de pF-waarden 0,5 en 4 de overleving van ectoparasitaire nematoden in braak liggende grond niet direct door de hoeveelheid bodemvocht wordt beïnvloed (fig. 10, 11A en 12 A). Dit houdt tevens in dat deze nematoden niet of nauwelijks actief zijn in onbegroeide vochtige grond (3.3). Onder dezelfde omstandigheden heeft ook de kwaliteit van de bodemoplossing onder invloed van normale bemesting geen waarneembare invloed op de overleving van populaties (fig. 11B,C en 12B,C). Grote kwalitatieve veranderingen door buitengewoon zware bemesting kunnen wel schade veroorzaken (tabel 15), waarvoor ook in de literatuur diverse aanwijzingen zijn (1.3.2).

Droogte wordt algemeen als schadelijk beschouwd voor nematoden, in het bijzonder voor ectoparasieten, hoewel er in de literatuur verscheidene gevallen van droogte-tolerantie worden genoemd (tabel 1). Bij het onderzoek naar de reactie van nematoden op droogte blijkt de geleidelijkheid van zowel het uitdrogings- als het herbevochtigingsproces belangrijk te zijn. Uitdrogen moet, vooral bij proeven in vitro, geleidelijk verlopen, omdat nematoden door onnatuurlijk snel waterverlies worden gedood. Daarom zijn verschillende technieken voor het uitdrogen van nematoden in vitro ontwikkeld. Hierbij wordt gebruik gemaakt van de relatie tussen de dichtheid van water-glycerine mengsels en de relatieve luchtvochtigheid in een afgesloten ruimte (2.3).

Wateropname door uitgedroogde nematoden en het vervolgens weer actief worden, vergt enige tijd. Dit maakt het noodzakelijk om voor de extractie van nematoden uit droge grond methoden toe te passen die afwijken van de gebruikelijke methoden, omdat anders slechts een zeer klein gedeelte van de aanwezige levende nematoden wordt geëxtraheerd. (fig. 13 en 14).

Experimenten in grond en in vitro hebben aangetoond dat veel ectoparasitaire wortelnematoden in bepaalde mate droogte tolereren (fig. 16, 17A, 19 en 20). Het al of niet overleven van uitdroging is afhankelijk van de snelheid waarmee vochtverlies optreedt (tabel 11) en ook van de sterkte en duur van de uitdroging (fig. 20 en 21). Dagelijkse tijdelijke stijgingen van de relatieve luchtvochtigheid maken de overlevingskansen groter (tabel 12). Er zijn duidelijke verschillen waargenomen in droogte-tolerantie tussen nematodensoorten (fig. 16, 17A, 19-22) en ook tussen ontwikkelingsstadia van dezelfde soort (fig. 17B en 22).

De algemene veronderstelling dat eieren van nematoden als gevolg van hun vermeende buitengewone droogteresistentie een belangrijke rol spelen bij het weer opbouwen van populaties na sterke droogte, wordt op basis van proefresultaten voor ectoparasieten tegengesproken (4.3.2 en 5.7).

Voor wat betreft de invloed van chemische eigenschappen van het bodemvocht in droge of drogende grond blijkt meer onderzoek, waarbij primaire en secundaire effecten worden onderscheiden, noodzakelijk. De verkregen resultaten wijzen op fundamentele verschillen, te weten een toenemende droogte-tolerantie bij de ene soort en vergiftiging van een andere soort onder gelijke omstandigheden (fig. 19, tabel 14), en tevens dat waterverlies van een nematode in een droge atmosfeer andere gevolgen heeft dan waterverlies aan een omringende vloeistof (5.10).

Een systematisch onderscheid van de reacties van nematoden op droogte of andere milieufactoren in analogie aan systemen zoals die worden toegepast bij planten lijkt nuttig te zijn (5.10).

Uitroeien van ectoparasitaire wortelnematoden in onbegroeide grond alleen door het handhaven van een niet extreme vochttoestand is nauwelijks mogelijk (fig. 9, 10, 11). Onder extreme omstandigheden kunnen nematoden wel worden uitgeroeid maar dat is een langdurig proces. Onvolledige bestrijding waarbij ongeveer 80% van de populatie wordt gedood, hetgeen vergelijkbaar is met de resultaten van chemische bestrijding, is voor het veilig verbouwen van een gewas meestal voldoende. In snel en sterk uitgedroogde grond (pF 5,5) kan 80% doding in betrekkelijk korte tijd worden bereikt. Voor een aantal droogtegevoelige soorten was dit 4 weken of minder en voor meer bestendige soorten varieerde deze periode van 10 tot meer dan 24 weken (tabel 8, fig. 16, 17, 19). Langdurige perioden van sterke droogte komen in aride en semi-aride gebieden voor (4.4). Een doelmatige bestrijding van nematoden met droge braak, mogelijk in combinatie met grondbewerking op het juiste tijdstip, lijkt in deze gebieden mogelijk.

ACKNOWLEDGMENTS

This study has been carried out at the Laboratory of Nematology of the Agricultural University, Wageningen, under the direction of Dr Ir M. Oostenbrink, to whom I wish to express my gratitude for the opportunity and facilities given, for the freedom in conducting the research and for his constructive criticism.

I would like to thank everybody in the laboratory, especially Mrs M. van de Stigchel-Wijngaard for her skilful assistance, Mr J. Verhaaf for preparing the drawings and Miss M. A. Peters for typing the manuscript.

Many thanks are also due to Dr A. R. P. Janse, Department of Soil Physics, and Prof. Dr W. H. van der Molen, Department of Land and Water Use, for their criticism and discussions, Prof. Dr G. O. Poinar Jr., Division of Entomology, University of California, Berkeley, for scrutinizing the English text, and Mr D. L. J. Dijkstra, Plant Protection Service, for his advice about the statistical calculations.

Furthermore I appreciate the co-operation of the neighbouring laboratories and of the heads and co-workers of the technical service, the workshops and the greenhouses.

REFERENCES

- ANDERSEN, F. L. & LEVINE, N. D. (1968). Effect of desiccation on survival of the free-living stages of *Trichostrongylus colubriformis*. *J. Parasit.* **54** (1): 117-128.
- BANAGE, W. B. & VISSER, S. A. (1965). The effect of some fatty acids and pH on a soil nematode. *Nematologica* **11** (2): 255-262.
- BARKER, K. R. (1968). Seasonal population dynamics of *Belonolaimus longicaudatus*, *M. incognita*, *Pratylenchus zaeae*, *Trichodorus christiei* and *Tylenchorhynchus claytoni* (Abstr.). *Nematologica* **14** (1): 2-3.
- , NUSBAUM, C. J. & NELSON, L. A. (1969). Seasonal population dynamics of selected plant-parasitic nematodes as measured by three extraction procedures. *J. Nematology* **1** (3): 232-239.
- BAXTER, R. I. & BLAKE, C. D. (1969). Some effects of suction on the hatching eggs of *Meloidogyne javanica*. *Ann. appl. Biol.* **63**: 183-190.
- BELL, R. G. (1969). Studies on the decomposition of organic matter in flooded soil. *Soil Biol. Biochem.* **1** (2): 105-116.
- BIRCHFIELD, W. & MARTIN, W. J. (1967). Reniform nematode survival in air-dried soil (Abstr.). *Phytopathology* **57**: 804.
- BIRD, A. F. (1957). Chemical composition of the nematode cuticle. Observations on individual layers and extracts from these layers in *Ascaris lumbricoides* cuticle. *Expl Parasit.* **6**: 383-403.
- (1971). *The structure of nematodes*. Academic Press, Inc., N.Y. & Lond.: 318 p.
- BIRD, G. W. & JENKINS, W. R. (1965). Effect of cranberry bog flooding and low dissolved oxygen concentrations on nematode populations. *Pl. Dis. Repr* **49**: 517-518.
- BLAKE, C. D. (1961). Importance of osmotic potential as a component of the total potential of the soil water on the movement of nematodes. *Nature, Lond.* **192**: 144-145.
- BOLANDER, W. J. & FAULKNER, L. R. (1969). Effects of temperature and dissolved oxygen on survival of *Ditylenchus dipsaci* in water (Abstr.). *Phytopathology* **59**: 1019.
- BREEMEN, N. VAN, ET AL. (1967). Aspects of rice growing in the America's, Asia and the Middle East. Part I. (Dutch text). Landbouwhogeschool, Wageningen: 82 p.
- BRODIE, B. B. & TOLER, R. W. (1966). Survival of *Meloidogyne incognita* in the absence of oxygen. *Phytopathology* **56**: 872.
- BROWN, L. N. (1934). Flooding to control root-knot nematodes. *J. agric. Res.* **47** (1933): 883-888.
- CASTRO, C. E., THOMASON, I. J. & BELD, M. (1970). The dynamics of the permeation of *Aphelenchus avenae* by halo-organic nematicides and other substances. *Phytopathology* **60**: 1287.
- CLARKE, A. J. & SHEPHERD, A. M. (1966). Inorganic ions and the hatching of *Heterodera* spp. *Ann. appl. Biol.* **58**: 497-508.
- COLLIS-GEORGE, N. & WALLACE, H. R. (1968). Supply of oxygen during hatching of the nematode *Meloidogyne javanica* under non-competitive conditions. *Aust. J. biol. Sci.* **21**: 21-35.
- COOPER, A. F., VAN GUNDY, S. D. & STOLZY, L. H. (1970). Nematode reproduction in environments of fluctuating aeration. *J. Nematology* **2** (2): 182-188.
- ROLL, N. A. & VIGLIERCHIO, D. R. (1969). Osmoregulation and the uptake of ions in a marine nematode. *Proc. helminth. Soc. Wash.* **36** (1): 1-9.
- CRONEY, D., COLEMAN, J. D. & BRIDGE, P. M. (1952). The suction of moisture held in soil and other porous materials. *Tech. Pap. Rd Res. Bd* **24**: 1-40.
- CURTIS, G. J. (1964). The effect of potassium chloride on the infestation of sugar beet by beet eelworm, *Heterodera schachtii* Schmidt. *Ann. appl. Biol.* **54**: 269-280.
- DAULTON, R. A. C. & NUSBAUM, C. J. (1962). The effect of soil moisture and relative humidity on the root-knot nematode *Meloidogyne javanica*. *Nematologica* **8** (2): 157-168.
- DECKER, H. (1969). *Phytonematologie*. VEB Deutscher Landwirtschaftsverlag, Berl.: 526 p.

- DROPKIN, V. H., MARTIN, G. C. & JOHNSON, R. W. (1958). Effect of osmotic concentration on hatching of some plant parasitic nematodes. *Nematologica* 3: 115-126.
- DUGGAN, J. J. (1960). Effect of soil drying on the viability of *Heterodera major* cysts. *Nature*, Lond. 185: 554-555.
- ELLENBY, C. (1968a). The survival of desiccated larvae of *Heterodera rostochiensis* and *H. schachtii*. *Nematologica* 14 (4): 544-548.
- (1968b). Desiccation survival in the plant parasitic nematodes, *Heterodera rostochiensis* Wollenweber and *Ditylenchus dipsaci* (Kühn) Filipjev. *Proc. R. Soc.* 169, Ser. B: 203-213.
- (1968c). Desiccation survival of the infective larva of *Haemonchus concortus*. *J. exp. Biol.* 49: 469-475.
- (1969). Dormancy and survival in nematodes. In: *Dormancy and Survival*, H. W. Woolhouse, Cambr. Univ. Press: 83-97. (23. Symp. Soc. exp. Biol., Norwich 1968).
- & GILBERT, A. B. (1958). Influence of certain inorganic ions on the hatching of the potato root celworm, *Heterodera rostochiensis* Wollenweber. *Nature*, Lond. 182: 925-926.
- ENDO, B. Y. (1962). Survival of *Heterodera glycines* at controlled relative humidities. *Phytopathology* 52: 80-88.
- ENO, C. F., BLUE, W. G. & GOOD, J. M. (1955). The effect of anhydrous ammonia on nematodes, fungi, bacteria and nitrification in some Florida soils. *Proc. Soil Sci. Soc. Am.* 19: 55-58.
- EPPE, J. M. (1963). Effects of sugar treatments on the viability of eggs and larvae in *Heterodera glycines* cysts, and larvae and adults of other nematode species. *Pl. Dis. Reprtr* 47: 180-182.
- FAIRBAIRN, D. (1960). The physiology and biochemistry of nematodes. In: *Nematology*, J. N. Sasser & W. R. Jenkins, Univ. N. Carolina Press, Chapel Hill: 267-296.
- FASSULIOTIS, G. (1972). Tolerance of *Hoplolaimus columbus* to high osmotic pressures, desiccation, and high soil temperatures. *J. Nematology* 3 (4) (1971): 309-310.
- FEDER, W. A. (1960). Osmotic destruction of plant parasitic and saprophytic nematodes by the addition of sugars to the soil. *Pl. Dis. Reprtr* 44: 883-885.
- FELDMESSER, J. & FEDER, W. A. (1954). Some effects of altered oxygen tensions on certain plant-parasitic and soil-inhabiting nematodes in vitro. *J. Parasit.* 40, Suppl.: 18.
- & — (1957). Survival of *Radopholus similis* in field soil subjected to drying and to elevated temperatures. *Phytopathology* 47: 11.
- & REBOIS, R. V. (1965). Temperature and moisture effects on *Pratylenchus brachyurus*. *Nematologica* 11 (1): 37-38.
- FIELDING, M. J. (1951). Observations on the length of dormancy in certain plant infecting nematodes. *Proc. helminth. Soc. Wash.* 18 (2): 110-112.
- FISHLER, D. W. & WINCHESTER, W. A. (1965). The effects of flooding on root-knot nematodes in organic soil. *Proc. Soil Crop Sci. Soc. Fla* 24 (1964): 150-154.
- GILLARD, A., D'HERDE, J. & VAN DEN BRANDE, J. (1958). Invloed van koolzuur op het uitkomen der larven van *Heterodera rostochiensis* Woll. *Meded. LandbHoogeschool. OpzoekStns Gent* 23 (3/4): 689-694.
- GODFREY, G. H., OLIVEIRA, J. M. & GITTEL, E. B. H. (1933). The duration of life of the root-knot nematode, *Heterodera radiculicola*, in soils subjected to drying. *Soil Sci.* 35: 185-195.
- GRIFFIN, G. D. & BARKER, K. R. (1966). Effects of soil temperature and moisture on the survival and activity of *Xiphinema americanum*. *Proc. helminth. Soc. Wash.* 33 (2): 126-130.
- GROOTE, G. DE (1960). De werking van Ca-cyanamide als nematicide. *Meded. LandbHoogeschool. OpzoekStns Gent* 25 (3/4): 1097-1106.
- HAFKENSCHIED, H. H. M. (1972). Influence of Cu^{++} ions on *Trichodorus pachydermus* and an extraction method to obtain active specimens. *Nematologica* 17 (4) (1971): 535-541.
- HANNON, C. I. (1963). Longevity of *Radopholus similis* under field conditions. *Pl. Dis. Reprtr* 47: 812-816.
- HOBBSON, A. D., STEPHENSON, W. & BEADLE, L. C. (1952). Studies on the physiology of *Ascaris lumbricoides*. I. *J. exp. Biol.* 29: 1-21.
- , — & EDEN, A. (1952). Studies on the physiology of *Ascaris lumbricoides*. II. *J. exp. Biol.* 29: 22-29.
- HOLLIS, J. P. (1961). Nematode reactions to coal-tar dyes. *Nematologica* 6 (4): 315-325.

- & JOHNSTON, T. (1957). Microbiological reduction of nematode populations in water saturated soils. *Phytopathology* **47**: 16.
- & RODRIGUEZ K., R. (1966). Rapid kill of nematodes in flooded soil. *Phytopathology* **56**: 1015-1019.
- IMAMURA, S. (1931). Nematodes in the paddy field, with notes on their population before and after irrigation. *J. Coll. Agric. imp. Univ. Tokyo* **11**: 193-240.
- JOHNSTON, T. (1957). Further studies on microbiological reduction of nematode populations in water saturated soils. *Phytopathology* **47**: 525-526.
- (1958). The effect of soil moisture on *Tylenchorhynchus martini* and other nematodes. *Proc. La Acad. Sci.* **20**: 52-55.
- KABLE, P. F. & MAI, W. F. (1968). Influence of soil moisture on *Pratylenchus penetrans*. *Nematologica* **14** (1): 101-122.
- KÄMPFE, L. (1959). Zur Physiologie von *Heterodera*. Larven unter Laboratoriumsbedingungen als Testobjekte für Nematizidprüfungen. *Proc. 4. int. Congr. Crop Prot. (Hamb. 1957)*: 605-611.
- KERR, A. & VYTHILINGAM, M. K. (1967). Factors influencing the extraction of nematodes from soil. *Nematologica* **12** (4) (1966): 511-517.
- KHAN, A. M., ADHAMI, A. & SAXENA, S. K. (1971). Population changes of some stylet-bearing nematodes associated with mango (*Mangifera indica* L.). *Indian J. Nematology* **1** (2): 99-105.
- KRADEL, J. (1959). Spurenelementgaben bei Kartoffelnematodenbefall. *NachrBl. dt. PflSchutzdienst, Berl.* **13**: 95-96.
- KRNJAIĆ, D. & KRNJAIĆ, S. (1970). Distribution of nematodes by wind. *Summ. 10. int. Pl. Nematol. Symp. (Pescara, 1970)*: 88.
- KUIPER, K. & LEEUW, W. P. DE (1963). Landbouwpoederkalk als nematocide. *Meded. Landb-Hoogesch. OpzoekStns Gent* **28** (3): 618-622.
- LAAN, P. A. VAN DER (1956). The influence of organic manuring on the development of the potato root eelworm, *Heterodera rostochiensis*. *Nematologica* **1** (2): 112-125.
- LEES, E. (1953). An investigation into the method of dispersal of *Panagrellus silusiae*, with particular reference to its desiccation resistance. *J. Helminth.* **27**: 95-103.
- LEVITT, J. (1972). Responses of plants to environmental stresses. Academic Press, Inc., N.Y. & Lond.: 697 p.
- MARKS, C. F. & SAYRE, R. M. (1964). The effect of potassium on the rate of development of the root-knot nematodes *Meloidogyne incognita*, *M. javanica* and *M. hapla*. *Nematologica* **10** (2): 323-327.
- , THOMASON, I. J. & CASTRO, C. E. (1968). Dynamics of the permeation of nematodes by water, nematocides and other substances. *Expl Parasit.* **22**: 321-337.
- MARTIN, G. C. (1967). Longevity of *Meloidogyne javanica* under conditions of bare fallow in Rhodesia. *Rhodesia agric. J.* **64** (5): 112-114.
- MCGLOHON, N. E., SASSER, J. N. & SHERWOOD, R. T. (1962). Effect of fallowing, desiccation, and soil temperature on certain plant-parasitic nematodes. *Phytopathology* **52**: 20.
- MEAGHER, J. W. (1970). Seasonal fluctuations in numbers of larvae of the cereal cyst nematode (*Heterodera avenae*) and of *Pratylenchus minyus* and *Tylenchorhynchus brevidens* in soil. *Nematologica* **16** (3): 333-347.
- MINTON, N. A., CAIRNS, E. J. & SMITH, A. L. (1960). Effect on root-knot nematode populations of resistant and susceptible cotton. *Phytopathology* **50**: 784-787.
- MYERS, R. F. (1967). Osmoregulation in *Panagrellus redivivus* and *Aphelenchus avenae*. *Nematologica* **12** (4) (1966): 579-586.
- NELSON, D. W. & BREMNER, J. M. (1970). Chemical decomposition of nitrate in soils. *Soil Biol. Biochem.* **2** (3): 203-215.
- NORTON, D. C. (1959). Relationship of nematodes to small grains and native grasses in north and central Texas. *Pl. Dis. Reprtr* **43**: 227-235.
- OOSTENBRINK, M. (1950). Het aardappelaaltje (*Heterodera rostochiensis* Wollenweber). *Versl. Meded. plziektenk. Dienst Wageningen* **115**: 230p.
- (1960). Estimating nematode populations by some selected methods. In: *Nematology*,

- J. N. Sasser & W. R. Jenkins, Univ. N. Carolina Press, Chapel Hill: 439-442.
- (1966). Major characteristics of the relation between nematodes and plants. Meded. LandbHogeschool Wageningen 66-4: 46 p.
- ORR, C. C. & NEWTON, O. H. (1971). Distribution of nematodes by wind. Pl. Dis. Reprtr 55: 61-63.
- OVERMAN, A. J. (1965). The effect of temperature and flooding on nematode survival in fallow sandy soil. Proc. Soil Crop Sci. Soc. Fla 24 (1964): 141-149.
- PEACOCK, F. C. (1957). Studies on root knot nematodes of the genus *Meloidogyne* in the Gold Coast. Part 2. Nematologica 2 (2): 114-122.
- PERRY, V. G. (1953). The awl nematode, *Dolichodorus heterocephalus*, a devastating plant parasite. Proc. helminth. Soc. Wash. 20 (1): 21-27.
- PERRY, R. N. & ELLENBY, C. (1972). Desiccation survival of *Ditylenchus dipsaci*. Abstr. 11. int. Symp. Pl. Nematol. (Reading, 1972): 55.
- PITCHER, R. S. (1968). The host-parasite relations and ecology of *Trichodorus viruliferus* on apple roots, as observed from an underground laboratory. Nematologica 13 (4) (1967): 547-557.
- PRASAD, J. & JHA, K. K. (1969). Variations in nematode populations as affected by soil conditions in Bihar. Indian Phytopath. 22 (3): 314-321.
- RADEWALD, J. D. & TAKESHITA, G. (1964). Desiccation studies on five species of plant-parasitic nematodes in Hawaii. Phytopathology 54: 903.
- RASKI, D. J. ET AL. (1965). Survival of *Xiphinema index* and reservoirs of fanleaf virus in fallowed vineyard soil. Nematologica 11 (3): 349-352.
- REUVER, I. (1959). Untersuchungen über *Paratylenchus amblycephalus* n. sp. (Nematoda, Criconematidae). Nematologica 4 (1): 3-15.
- RHOADES, H. L. (1964). Effect of fallowing and flooding on root-knot in peat soil. Pl. Dis. Reprtr 48: 303-306.
- & LINFORD, M. B. (1961). Biological studies on some members of the genus *Paratylenchus*. Proc. helminth. Soc. Wash. 28 (1): 51-59.
- RODRIGUEZ K., R., JORDAN, J. W. & HOLLIS, J. P. (1965). Nematodes: biological control in rice fields: role of hydrogen sulfide. Science, N.Y. 148: 524-526.
- ROGGEN, D. R., RASKI, D. J. & JONES, N. O. (1967). Further electron microscope observations of *Xiphinema index*. Nematologica 13 (1): 1-16.
- RÖSSNER, J. (1971). Einfluss der Austrocknung des Bodens auf wandernde Wurzelnematoden. Nematologica 17 (1): 127-144.
- (1972). Comparative investigations of nematodes with normal turgor pressure and of desiccated specimens, with the aid of the scanning electron microscope. Abstr. 11. int. Symp. Pl. Nematol. (Reading, 1972): 58-60.
- RUSSELL, E. W. (1962). Soil conditions and plant growth. 9. Edn. Longmans, Lond. & N.Y.: 688 p.
- SAYRE, R. M. (1971). Biotic influences in soil environment. In: Plant Parasitic Nematodes, Vol. 1, B. M. Zuckerman, W. F. Mai & R. A. Rohde, Academic Press Inc., N.Y. & Lond.: 345 p.
- , PATRICK, Z. A. & THORPE, H. J. (1964). Substances toxic to plant parasitic nematodes in decomposing plant residue (Abstr.). Phytopathology 54: 905.
- , — & — (1965). Identification of a selective nematocidal component in extracts of plant residues decomposing in soil. Nematologica 11 (2): 263-268.
- SHARMA, R. D. (1971). Studies on the plant parasitic nematode *Tylenchorhynchus dubius*. Meded. LandbHogeschool Wageningen 71-1: 154 p.
- SPECHT, C. H. & WALKER, J. T. (1969). Survival of *Pratylenchus penetrans* under increased carbon dioxide within soil cylinders (Abstr.). J. Nematology 1 (1): 27-28.
- STAKMAN, W. P. (1968). Bepaling van vochtspanning en vochtgehalte van gronden door middel van dampspanningsevenwichten. Meded. Inst. CultTech. WatHuish. 111: 44 p.
- STEELE, A. E. (1962). Effects of pretreatment of *Heterodera schachtii* cysts with sugar solutions on emergence of larvae in sugar-beet root diffusate. Pl. Dis. Reprtr 46: 43-44.
- STEINER, G. & ALBIN, F. E. (1946). Resuscitation of the nematode *Tylenchus polyhyppnus* n.sp.

- after almost 39 years' dormancy. *J. Wash. Acad. Sci.* 36: 97-99.
- STEPHENSON, W. (1944). The effect of certain inorganic chloride solutions upon the movement of a soil nematode (*Rhabditis terrestris* Stephenson), and upon its bodily size. *Parasitology* 35 (4): 167-172.
- STOLZY, L. H., VAN GUNDY, S. D. & LETEY, J. (1960). Oxygen tolerances of four plant-parasitic nematodes. *Phytopathology* 50: 656.
- THAMES, W. H. & STONER, W. N. (1953). A preliminary trial of low-land culture rice in rotation with vegetable crops as a means of reducing root-knot nematode infestations in the Everglades. *Pl. Dis. Repr* 37: 187-192.
- THISLETHWAYTE, B. (1969). Hatch of eggs of *Pratylenchus penetrans* in various salt solutions (Abstr.). *J. Nematology* 1 (1): 28.
- THOMASON, I. J., CASTRO, C. E., BELSER, N. & BELD, M. (1972). Osmoregulation and the kinetics of permeation of *Aphelenchus avenae* by water. *J. Nematology* 3 (4) (1971): 331.
- UPADHYAY, R. S. (1969). Studies on plant parasitic nematodes - soil factors. Thesis Aligarh Muslim Univ.: 112 + 20 p. (unpublished).
- VAN GUNDY, S. D. (1965). Factors in survival of nematodes. *A. Rev. Phytopath.* 3: 43-68.
- , BIRD, A. F. & WALLACE, H. R. (1967). Aging and starvation of larvae of *Meloidogyne javanica* and *Tylenchulus semipenetrans*. *Phytopathology* 57: 559-571.
- , McELROY, F. D., COOPER, A. F. & STOLZY, L. H. (1968). Influence of soil temperature, irrigation and aeration on *Hemicycliophora arenaria*. *Soil Sci.* 106 (4): 270-274.
- & STOLZY, L. H. (1963). Oxygen diffusion rates and nematode movement in cellulose sponges. *Nature, Lond.* 200: 1187-1189.
- & — (1964). The relationship of oxygen diffusion rates to the survival, movement, and reproduction of *Hemicycliophora arenaria*. *Nematologica* 9 (4) (1963): 605-612.
- & — (1968). Soil aeration and nematode ecology (Abstr.). 1. int. Congr. Pl. Path. (Lond., 1968).
- , —, SZUSZKIEWICZ, T. E. & RACKHAM, R. L. (1962). Influence of oxygen supply on survival of plant parasitic nematodes in soil. *Phytopathology* 52: 628-632.
- VASSALLO, M. A. (1967). The nematocidal power of ammonia. *Nematologica* 13 (1): 155.
- VIGLIERCHIO, D. R., CROLL, N. A. & GORTZ, J. H. (1969). The physiological response of nematodes to osmotic stress and an osmotic treatment for separating nematodes. *Nematologica* 15 (1): 15-21.
- WALKER, J. T. (1969). *Pratylenchus penetrans* (Cobb) populations as influenced by microorganisms and soil amendments. *J. Nematology* 1 (3): 260-264.
- (1971). Populations of *Pratylenchus penetrans* relative to decomposing nitrogenous soil amendments. *J. Nematology* 3 (1): 43-49.
- & MAVRODINEANU, S. (1967). Effect of ammonia on *Pratylenchus penetrans* (Abstr.). *Phytopathology* 57: 345-346.
- WALLACE, H. R. (1956). The emergence of larvae from cysts of the beet eelworm, *Heterodera schachtii* Schmidt, in aqueous solutions of organic and inorganic substances. *Ann. appl. Biol.* 44: 274-282.
- (1958). Movement of eelworms. 2. A comparative study of the movement in soil of *Heterodera schachtii* Schmidt and of *Ditylenchus dipsaci* (Kühn) Filipjev. *Ann. appl. Biol.* 46: 86-94.
- (1963). The biology of plant parasitic nematodes. Edward Arnold Ltd, Lond.: 280 p.
- (1966). The influence of moisture stress on the development, hatch and survival of eggs of *Meloidogyne javanica*. *Nematologica* 12 (1): 57-69.
- (1968a). The influence of aeration on survival and hatch of *Meloidogyne javanica*. *Nematologica* 14 (2): 223-230.
- (1968b). The influence of soil moisture on survival and hatch of *Meloidogyne javanica*. *Nematologica* 14 (2): 231-242.
- & GREET, D. N. (1964). Observations on the taxonomy and biology of *Tylenchorhynchus macrurus* (Goodey, 1932) Filipjev, 1936 and *Tylenchorhynchus icarus* sp. nov. *Parasitology* 54: 129-144.

- WARD, C. H. (1960). Dagger nematodes associated with forage crops in New York. *Phytopathology* **50**: 658.
- WRIGHT, K. A. (1963). Cytology of the bacillary bands of the nematode *Capillaria hepatica* (Bancroft, 1893). *J. Morph.* **112**: 233-245.
- WYSS, U. (1970). Zur Toleranz wandernder Wurzel nematoden gegenüber zunehmender Austrocknung des Bodens und hohen osmotischen Drücken. *Nematologica* **16** (1): 63-73.

CURRICULUM VITAE

Wilfried Rudolf Simons, geboren 11 augustus 1939 te Bussum
Studie landbouwhogeschool, richting tropische cultuurtechniek, 1960/67
Ingenieursdiploma: irrigatie, cultuurtechniek, nematologie, tropische bodemkunde
Rajasthan canal project in India, F.A.O., 1968/69
Landbouwhogeschool, afdeling nematologie, 1969/73