

Network Coding over a Noisy Relay : a Belief Propagation Approach

Sichao Yang

Department of Electrical and Computer Engineering
University of Illinois at Urbana-Champaign
Urbana, IL 61801
syang8@uiuc.edu

Ralf Koetter

Institute for Communications Engineering
Technical University of Munich
80333 Munich, Germany
ralf.koetter@tum.de

Abstract—In recent years, network coding has been investigated as a method to obtain improvements in wireless networks. A typical assumption of previous work is that relay nodes performing network coding can decode the messages from sources perfectly. On a simple relay network, we design a scheme to obtain network coding gain even when the relay node cannot perfectly decode its received messages. In our scheme, the operation at the relay node resembles message passing in belief propagation, sending the logarithm likelihood ratio (LLR) of the network coded message to the destination. Simulation results demonstrate the gain obtained over different channel conditions. The goal of this paper is not to give a theoretical result, but to point to possible interaction of network coding with user cooperation in noisy scenario. The extrinsic information transfer (EXIT) chart is shown to be a useful engineering tool to analyze the performance of joint channel coding and network coding in the network.

I. INTRODUCTION

Since the seminal paper by Ahlswede et al. [1], network coding has been investigated as a potential tool for the design of communication networks in order to let the data transmission rate approach the capacity limit. Some recent work [2–4] studies the application of network coding to wireless networks as a way for providing users with cooperative diversity. All these papers show that network coding does have practical benefits and can substantially improve wireless throughput.

Our paper was motivated by a simple relay network presented in [2]. The structure of the relay network from [2] is shown in Figure 1.(a). There are two sources s_1, s_2 and one destination d . Both sources broadcast their coded messages to the relay and destination. The relay helps the transmission by sending its observation of the sources to the destination. The different point-to-point channels are assumed to be Gaussian and non-interfering in [2]. The crucial assumption in [2] is that the relay node is assumed to be able to decode the messages from both the sources reliably.

We note that even in a single source and single relay network, the accurate capacity is still unknown. In [2], the authors evaluate the performance of the following scheme in the relay network shown in Figure 1.(a): LDPC codes are applied in all point-to-point channels. Let x_1 and x_2 be the bits sent by the sources. Let $\varphi(x) : \{0, 1\} \rightarrow \{+1, -1\}$ be the standard BPSK modulation map. The relay decodes the signal from the source perfectly and it sends $x = \varphi(x_1 \oplus x_2)$ to the

destination. Then, the channel can avail of three observations $y_1 = \varphi(x_1) + n_1, y_2 = \varphi(x_2) + n_2, y = \varphi(x_1 \oplus x_2) + n_r$ from three independent channels. The destination jointly decodes x_1 and x_2 by these three observations. The authors in [2] compare their scheme to a reference scheme, in which the relay spends half of her effort for helping s_1 and half for helping s_2 in a time division manner. The scheme using network coding shows a significant improvement.

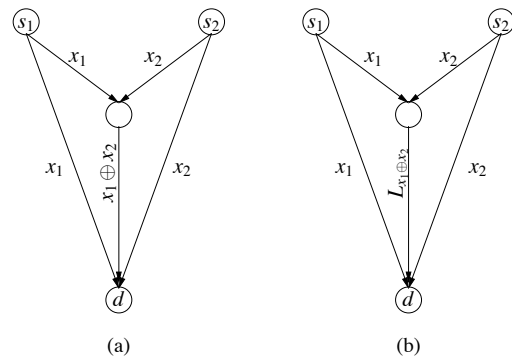

Fig. 1. Network coding over a noisy relay by belief propagation

In [2], as well as other previous work such as [3,4], a fundamental assumption is that the relay node is able to decode the source messages reliably. This assumption limits their investigation to the cases that the channels from sources to the relay have good quality and the channel codes applied are strong enough. However, in reality, the relay may be far away from the sources so that the channels from sources to the relay are subject to high noise or severe fading.

In this paper, we aim to investigate how network coding gain may be achieved in a wireless networks even when the transmission to the relay can not be recovered perfectly. The basic idea of our scheme is the following: Instead of decoding the messages from the sources, the relay node mimics a message passing belief propagation setup, transmitting the logarithm likelihood ratio (LLR) of the network coded message to the destination as shown in Figure 1.(b). Recently, soft decoding was investigated as a way to improve cooperative communication [5, 6]. We consider this approach a step towards reconciling network coding and user cooperation in noisy

environment and show the network throughput improvement in our scheme. Moreover, we hope that our work provides initiative in rethinking the channel code design rules for the cooperation in wireless networks.

The paper is organized as follows. In Section II, the system model and our scheme is introduced in details. In Section III, the numerical results are presented. In Section IV, the EXIT chart over the system is studied for performance analysis. In Section V, conclusions are made and some future directions are discussed.

II. SYSTEM MODEL

In this section, we introduce the system model in details. We study the relay network shown in Figure 1, which has the identical topology as the network studied in [2]. Two sources s_1 and s_2 are independent binary random sources with equal probability for 0 and 1. All the channels are Gaussian channels. All point-to-point channels are interference-free, so that the relay is able to receive a network coded message in one time slot and the destination is able to run an iterative decoding algorithm synchronously. We further assume that the network is symmetric: the two channels from the sources to the relay have the same quality and the two channels from the sources to the destination have the same quality.

We use the following notations for the noise and signal-to-noise ratio (SNR) on different channels:

- N_{sd} , SNR_{sd} : Noise and SNR on the channel from the sources to the destination.
- N_{sr} , SNR_{sr} : Noise and SNR on the channel from the sources to the relay.
- N_{rd} , SNR_{rd} : Noise and SNR on the channel from the relay to the destination.

A systematic view of our scheme is shown in Figure 2.

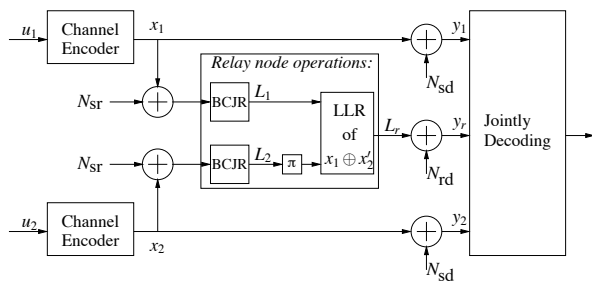

Fig. 2. Block diagram of the system

We use convolutional codes as channel codes, which is simple for the performance analysis and illuminative when we demonstrate our ideas. The relay node operation includes three steps:

Step 1: The BCJR algorithms are run to derive the LLR for the messages from each sources. In Figure 2, L_1 and L_2 denote the LLR of messages from s_1 and s_2 respectively.

Step 2: Permute LLRs of a codeword from s_2 , which decrease the channel dependency of the three messages sent to the destination.

Step 3: Calculate the LLR of the network coded message by

$$L_r = \log \left(\frac{e^{L_1} + e^{L_2}}{1 + e^{L_1 + L_2}} \right)$$

The destination receives three messages: $y_1 = \varphi(x_1) + N_{sd}$, $y_2 = \varphi(x_2) + N_{sd}$, and $y_r = L_r + N_{rd}$, where L_r is transmitted as analog value. The destination run an iterative decoding algorithm based on these three observations. The iterative message passing between two convolutional decoders are shown in Figure 3.

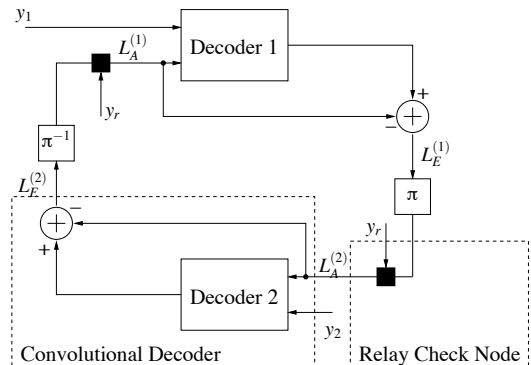

Fig. 3. Iterative decoding

The additional operators between the convolutional decodes stand for the relay check, of which the indicate function is

$$T(x_1, x'_2, x) = \begin{cases} 1, & \text{if } x = x_1 \oplus x'_2. \\ 0, & \text{otherwise.} \end{cases} \quad (1)$$

Clearly, if the quality of relay channels is extremely bad, the decoder appears to be two separate convolutional decoders. If the quality of relay channel and the relay information L_r are extremely good, the decoder appears to be a simple turbo decoder. However, note that, in contrast to classical turbo codes, all code bits in the two convolutionally coded data streams are coupled because $x_1 + x'_2$ is known.

III. SIMULATION RESULTS

We study the performance of the scheme presented in section II by simulation. In the simulation, we use the systematic rate $\frac{1}{2}$ recursive convolutional codes in the original Turbo codes [7] as the channel code, for which the code generator is

$$G(D) = \left(1, \frac{1 + D^4}{1 + D + D^2 + D^3 + D^4} \right). \quad (2)$$

We investigate the system performance under different channel conditions. The simulation results are shown in Figure 4 and Figure 5. The figures show the bit error probability (BER) of the system in a combination of different values of SNR_{sr} , SNR_{sd} and SNR_{rd} . In Figure 4, SNR_{sr} is 5dB. In Figure 5, SNR_{sr} is 0dB. In both of the figures, the Y-axis is the BER and X-axis is SNR_{sd} . The different curves in a figure stand for the different SNR_{rd} , where $\text{SNR}_{rd} = -\infty$

implies there is no relay. Obviously, if the channel condition from sources to relay is better, more gain is obtained through network coding. In Figure 5, when SNR_{sr} is 0dB, i.e., the channels are not so good, there are still significant performance improvement.

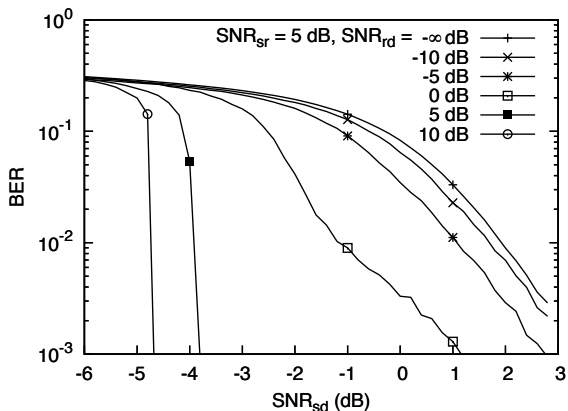

Fig. 4. Bit error rate (BER) of the system with $\text{SNR}_{\text{sr}} = 5\text{dB}$

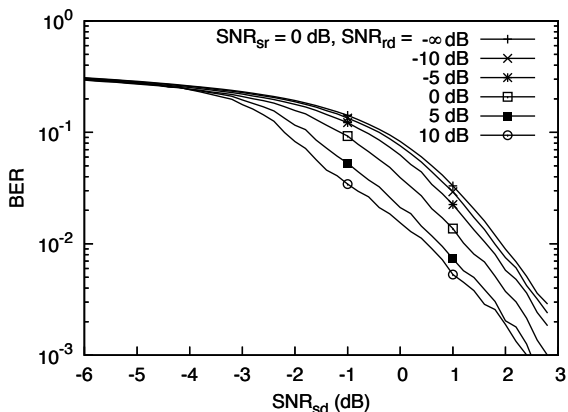

Fig. 5. Bit error rate (BER) of the system with $\text{SNR}_{\text{sr}} = 0\text{dB}$

IV. PERFORMANCE ANALYSIS BY EXIT CHART

We briefly describe in this section a standard analysis tool called an extrinsic information transfer (EXIT) chart to ease the selection of system parameters, such as the channel code in the system. An EXIT chart, first developed by Stephan ten Brink [8], is a technique to aid the construction of good iteratively-decoded error-correcting codes (in particular low-density parity-check (LDPC) codes and Turbo codes). EXIT charts were built on the concept of extrinsic information developed in the Turbo coding community. For the EXIT analysis, each component of the decoder (for example a convolutional decoder of a Turbo code, the LDPC parity-check nodes or the LDPC variable nodes) is modeled as a device mapping a sequence of random variables \mathbf{y} and \mathbf{L}_i to a new sequence of random variables \mathbf{L}_o , where \mathbf{y} is the channel observation and \mathbf{L}_i and \mathbf{L}_o are interpreted as LLRs for some random source X_i and X_o . For iterations between

the components, the extrinsic information is usually measured by mutual information $I(X_i, L_i)$ and $I(X_o, L_o)$.

A key assumption in EXIT chart analysis is that the messages to and from a component of the decoder can be described by a sequence of single numbers, the a-priori information \mathbf{L}_i and extrinsic information \mathbf{L}_o . This is for example true when the sequence of observations \mathbf{y} is from a binary erasure channel. Otherwise, a crucial assumption in ten Brink's analysis is that the sequence of information is reasonably approximated by observations \mathbf{y} from a Gaussian channel.

In this paper, the decoder has four different components as shown in Figure 3: two convolutional decoders and two relay check nodes. In the following discussion, we study the EXIT charts of the two components marked in Figure 3. The EXIT charts of the other two components are the same by symmetry.

Here we assume that both y_r , the observation of the relay check node, and y_2 the observation of the convolutional decoder are from Gaussian channels. That is,

$$\begin{aligned} y_2 &= \varphi(x_2) + N_{\text{sd}} \\ y_r &= \varphi(x_1 \oplus x_2) + N_r \end{aligned}$$

where N_{sd} is the actually noise in the channels from the sources to the destination and N_r is assumed to be an approximation of the noise on a concatenation of the channel from a source to the relay and the channel from the relay to the destination. We let $X^{(1)}$ and $X^{(2)}$ denote the random sources from s_1 and s_2 .

The EXIT chart of the relay node is shown in Figure 6. Clearly, if the channel condition on the relay is bad, the information from the other decoder barely pass through. However, if the channel condition on the relay is good enough, all the information from the other decoder passes through.

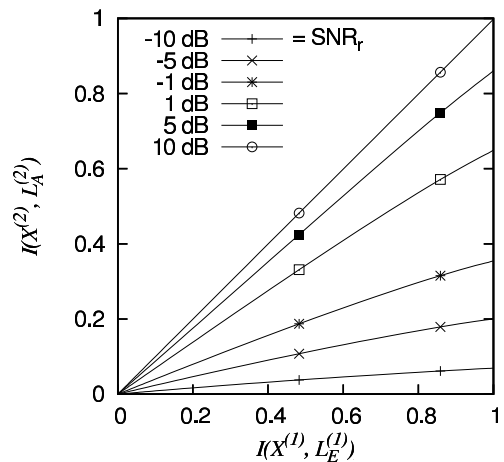

Fig. 6. EXIT charts of the relay check node

The EXIT chart of convolutional decoders were extensively studied in many papers. For illustration of our way in analyzing the system, we draw the EXIT chart of the convolutional decoder with generator (2) in Figure 7.

We analyze the system performance by the iteration of extrinsic information. As shown in Figure 3, the extrinsic

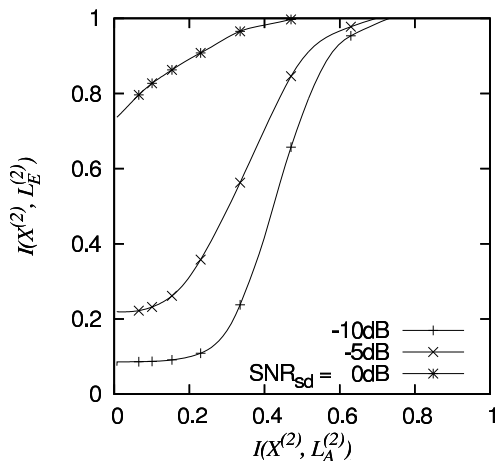

Fig. 7. EXIT charts of the convolutional decoder

information of decoder 1 is $I(X^{(1)}, L_E^{(1)})$. After permutation, it changes to be the input of the relay check node. The output of the relay check node is $I(X^{(2)}, L_A^{(2)})$, which is the a-priori information of decoder 2. After the decoding process, the extrinsic information of decoder 2, $I(X^{(2)}, L_E^{(2)})$, is derived. In Figure 8, the iteration of the extrinsic information is shown in the case that $\text{SNR}_{\text{sd}} = -5\text{dB}$ and $\text{SNR}_{\text{r}} = 1\text{dB}$.

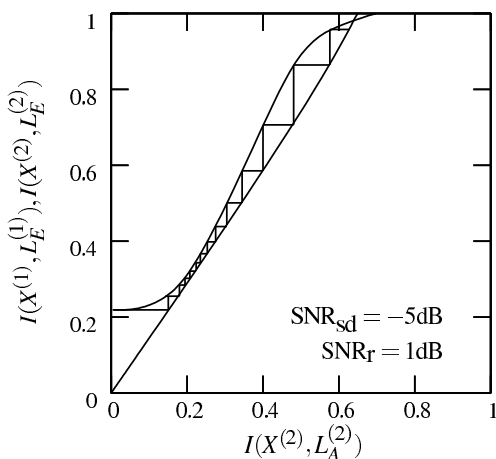

Fig. 8. EXIT Charts and decoding trajectory of the system

For a successful decoding, there must be a clear path between the curves so that iterative decoding can proceed from 0 bit of extrinsic information to 1 bit of extrinsic information. To make an optimal code, the two transfer curves need to lie close to each other. This observation is supported by the theoretical result that for capacity to be reached for a code over a binary-erasure channel there must be no gap between the curves and also by the insight that a large number of iterations are required for information to be spread throughout all bits of a code. As shown in Figure 8, the iteration stops at a point with almost 1 bit extrinsic information and two curves are very close. Therefore, in case that $\text{SNR}_{\text{sd}} = -5\text{dB}$ and $\text{SNR}_{\text{r}} = 1\text{dB}$, the convolutional code with generator (2) is good channel code for such channels. However, if either

SNR_{sd} or SNR_{r} decreased, the two curves will intersect at the middle of the chart. Channel codes stronger than the codes in (2) are required for reliable communication between the sources and the destination.

V. CONCLUSIONS AND FUTURE WORKS

In the paper, we investigate the users' network coding gain when the relay is noisy in a simple relay network. We use EXIT charts in studying the performance of joint channel coding and network coding schemes.

Wireless networks are subject to various crucial physical limits such as channel capacity, power, and chip speed. The ultimate goal is to build theory background and design engineering tools in finding optimal channel codes, i.e. codes with lower complexity and low error probability. By taking advantage of cooperative diversity gain such as network coding, some weak channel codes can be found for reliable communication in a wireless network though they may work outside of a point-to-point channel capacity limit in the network.

Some problems are interesting to explore in the future. In the simple relay network presented in this paper, if the channel conditions from two sources to the relay and the destination are different, it's not always better to do network coding than just to decode forward or amplify forward the source with better channel condition. It's important to design schemes which adapt to the channel conditions. Furthermore, we design our scheme in a tentative way by assuming that the signals from the relay to the destination are analog. It will be interesting to investigate how the quantization of the signals affects the performance system by rate-distortion theory.

ACKNOWLEDGEMENT

The authors gratefully acknowledge the useful discussion with Lei Ying and Prof. Bruce Hajek, University of Illinois at Urbana-Champaign.

REFERENCES

- [1] R. Ahlswede, N. Cai, S. R. Li, and R. W. Weung, "Network information flow," *IEEE Transaction on Information Theory*, vol. 46, no. 4, pp. 1204–1216, 2000.
- [2] C. Hausl, F. Schrechenbach, and I. Oikonomidis, "Iterative network and channel decoding on a tanner graph," in *Proceedings of the 39th Annual Allerton Conference on Communication, Control and Computing*, 2005.
- [3] Y. Chen, S. Kishore, and J. Li, "Wireless diversity through network coding," in *Proceedings of IEEE Wireless Communications and Networking Conference*, 2006.
- [4] S. Katti, H. Rahul, W. Hu, D. Katabi, M. Médard, and J. Crowcroft, "XORs in the air: Practical wireless network coding," in *Proceedings of the 2006 conference on Applications, technologies, architectures, and protocols for computer communications*, 2006.
- [5] Y. Li, B. Vucetic, T. F. Wong, and M. Dohler, "Distributed turbo coding with soft information relaying in multihop relay networks," *IEEE Journal on Selected Areas in Communications*, vol. 24, no. 11, 2006.
- [6] H. H. Sneessens and L. Vandendorpe, "Soft decode and forward improves cooperative communications," in *Proc. IEEE 3G*, London, United Kingdom, Nov. 2005.
- [7] C. Berrou, A. Glavieux, and P. Thitimajshima, "Near shannon limit error-correcting coding and decoding: Turbo codes (1)," in *Proceedings of IEEE International Conference on Communications*, Geneva, Switzerland, May 1993, pp. 1064–1070.
- [8] S. ten Brink, "Convergence of iterative decoding," *Electronics Letters*, vol. 35, no. 10, May 1999.