

Northumbria Research Link

Citation: Mirzaei, Mohammad Amin, Nazari-Heris, Morteza, Mohammadi-Ivatloo, Behnam, Zare, Kazem, Marzband, Mousa, Shafie-Khah, Miadrez, Anvari-Moghaddam, Amjad and Catalao, Joo P. S. (2021) Network-Constrained Joint Energy and Flexible Ramping Reserve Market Clearing of Power- and Heat-Based Energy Systems: A Two-Stage Hybrid IGDT-Stochastic Framework. IEEE Systems Journal, 15 (2). pp. 1547-1556. ISSN 1932-8184

Published by: IEEE

URL: <https://doi.org/10.1109/JSYST.2020.2996952>
<<https://doi.org/10.1109/JSYST.2020.2996952>>

This version was downloaded from Northumbria Research Link:
<http://nrl.northumbria.ac.uk/id/eprint/43422/>

Northumbria University has developed Northumbria Research Link (NRL) to enable users to access the University's research output. Copyright © and moral rights for items on NRL are retained by the individual author(s) and/or other copyright owners. Single copies of full items can be reproduced, displayed or performed, and given to third parties in any format or medium for personal research or study, educational, or not-for-profit purposes without prior permission or charge, provided the authors, title and full bibliographic details are given, as well as a hyperlink and/or URL to the original metadata page. The content must not be changed in any way. Full items must not be sold commercially in any format or medium without formal permission of the copyright holder. The full policy is available online: <http://nrl.northumbria.ac.uk/policies.html>

This document may differ from the final, published version of the research and has been made available online in accordance with publisher policies. To read and/or cite from the published version of the research, please visit the publisher's website (a subscription may be required.)

Network-Constrained Joint Energy and Flexible Ramping Reserve Market Clearing of Power and Heat-Based Energy Systems: A Two-Stage Hybrid IGDT-Stochastic Framework

Mohammad Amin Mirzaei, Morteza Nazari-Heris, *Student Member, IEEE*, Behnam Mohammadi-Ivatloo, *Senior Member, IEEE*, Kazem Zare, *Senior Member, IEEE*, Mousa Marzband, *Senior Member, IEEE*, Miadreza Shafie-khah, *Senior Member, IEEE*, Amjad Anvari Moghaddam, *Senior Member, IEEE*, João P. S. Catalão, *Senior Member, IEEE*

Abstract—This study proposes a new two-stage hybrid stochastic- information gap-decision theory (IGDT) based on network-constrained unit commitment (NCUC) framework. The model is applied for the market-clearing of joint energy and flexible ramping reserve in integrated heat and power-based energy systems. The uncertainties of load demands and wind power generation are studied using the Monte Carlo simulation method and IGDT, respectively. The proposed model considers both risk-averse and risk-seeker strategies, which enables the independent system operator (ISO) to provide flexible decisions in meeting system uncertainties in real-time dispatch. Moreover, the effect of feasible operating regions (FOR) of the combined heat and power (CHP) plants on energy and flexible ramping reserve market and operation cost of the system is investigated. The proposed model is implemented on a test system to verify the effectiveness of the introduced two-stage hybrid framework. The analysis of the obtained results demonstrates that the variation of heat demand is effective on power and flexible ramping reserve supplied by CHP units.

Index Terms—Flexible ramping reserve, market clearing, stochastic programming, information gap-decision theory (IGDT), combined heat and power, hybrid IGDT- stochastic.

Manuscript received x x, x; revised x x, x; accepted x x, x. (Corresponding author: Behnam Mohammadi-Ivatloo.)

Mohammad Amin Mirzaei, Morteza Nazari-Heris, and Kazem Zare are with the Faculty of Electrical and Computer Engineering, University of Tabriz, Tabriz 5166616471, Iran (e-mail: aminmirzaei780@yahoo.com; m.nazari@ieec.org; kazem.zare@tabrizu.ac.ir).

Behnam Mohammadi-Ivatloo is with the Faculty of Electrical and Computer Engineering, University of Tabriz, Tabriz 5166616471, Iran, and also with the Institute of Research and Development, Duy Tan University, Da Nang 550000, Vietnam (email: bmohammadi@tabrizu.ac.ir).

Mousa Marzband is with the Faculty of Engineering and Environment, Northumbria University, Newcastle upon Tyne NE1 8ST, UK, and also with Center of Research Excellence in Renewable Energy and Power Systems, King Abdulaziz University, Jeddah, Saudi Arabia (e-mail: mousa.marzband@northumbria.ac.uk).

Miadreza Shafie-khah is with the School of Technology and Innovations, University of Vaasa, 65200 Vaasa, Finland (e-mail: mshafiek@uva.fi).

Amjad Anvari-Moghaddam is with the Department of Energy Technology, Aalborg University, Aalborg 9920, Denmark, and also with the Faculty of Electrical and Computer Engineering, University of Tabriz, Tabriz 5166616471, Iran (e-mail: aam@et.aau.dk).

João P. S. Catalão is with the Faculty of Engineering of the University of Porto and INESC TEC, Porto 4200-465, Portugal (e-mail: catalao@fe.up.pt).

Nomenclature

Index:

t Time interval

i	Generation unit
r	Wind turbine
b, b'	Electric network buses
j	Electric network loads
L	Transmission line of electric network
s	Scenario
Constants:	
NT	Sum of time intervals
NC	Number of CHP plants
NG	Number of non-CHP plants
NW	Number of wind power turbines
NB	Number of buses
NQ	Number of heat loads
NJ	Number of electric loads
a, b, c, d, e, f	Cost coefficients of the CHP unit
P_i^{\max} / P_i^{\min}	Upper/lower capacity of unit i (MW)
RU_i / RD_i	Ramp-up/down of unit i (MW)
T_i^{On} / T_i^{Off}	Minimum up/down time of unit i (MW)
X_L	Reactance of electric line L (Ω)
PF_L^{\max}	Power transmission capacity of electric line L (MW)
$D_{j,t}$	Forecasted electricity demand at time t (MW)
$D_{j,t,s}$	Forecasted electricity demand at time t in scenario s (MW)
$HD_{q,t}$	Forecasted heat demand at time t (MW)
$HD_{q,t,s}$	Forecasted heat demand at time t in scenario s (MW)
$RFRU_i / RFRD_i$	Requirement of upward/downward flexible ramping reserve at time t (MW)
$C_{i,t}^{FRU} / C_{i,t}^{FRD}$	Upward/downward flexible ramping reserve cost of unit i at time t (\$/MWh)
$P_{r,t}^f$	Forecasted wind power (MW)
Variables:	
F_i^C	Cost function of unit i (\$)
First-stage variables	
$SU_{i,t}, SD_{i,t}$	Start-up/shut-down cost of unit i (\$)
$P_{i,t}$	Power dispatch of unit i (MW)
$H_{i,t}$	Heat generation of CHP unit (MWh)
$P_{r,t}$	Wind power dispatch (MW)

$PF_{L,t}$	Line flow at line L (MW)
$\delta_{b,t}$	Voltage angle of network buses
$FRU_{i,t} / FRD_{i,t}$	Upward/downward flexible ramping reserve provided by unit i (MW)
$I_{i,t}$	Binary on/off status indicator of unit i
$X_{i,t-1}^{on} / X_{i,t-1}^{off}$	On/off time of unit i

Second-stage variables

$\Delta P_{i,t,s}^U / \Delta P_{i,t,s}^D$	Adjusted upward/downward power dispatch of unit i (MW)
$\Delta H_{i,t,s}^U / \Delta H_{i,t,s}^D$	Adjusted upward/downward heat generation of CHP unit (MWh)
$PF_{L,t,s}$	Line flow at line L and scenario s (MW)
$\delta_{b,t,s}$	Voltage angle of buses at scenario s

I. INTRODUCTION

Recently, significant interests have been observed in harvesting renewable energy due to global concerns on climate changes and the decrement of fossil fuels [1]. The annual wind production will achieve 2182 TWh by 2030 according to the statistics reported by International Energy Agency (IEA) [2]. Considering the uncertainties associated with power generation of wind turbines and photovoltaic systems as the most popular renewable energy sources, different solutions are proposed for handling such issues. Flexible ramping products (FRPs) are defined as practical solution approaches to deal with uncertainties of power load demand and predicted renewable power production, which are products providing additional upward and downward flexible ramping [3]. Such products are introduced as FRPs in California independent system operator (CAISO) market and ramp capability in the Midwest ISO (MISO) market [4, 5].

The difference between the application of FRPs with respect to other power market services such as frequency regulation, spinning reserve and non-spinning reserve should be highlighted. In fact, certain pre-determined contingencies of the power network at each time are managed by the above-mentioned services. In addition, spinning and non-spinning reserves play a role in performing up-ramping flexibility; however, FRPs cover both up-ramping and down-ramping services. Moreover, 5-min intervals and several seconds are checking time intervals for FRPs and frequency regulation, respectively [4]. Several studies have focused on such products in unit commitment (UC) problem. Flexible ramping products of ISO market has been incorporated in real-time stochastic UC in [4] without consideration of transmission limits. In [6], a market clearing of joint energy and flexible ramping reserve for coordinated electricity and natural gas networks has been studied in the presence of demand response programs. In this reference, the authors have concentrated on the impact of natural gas network constraints in flexible ramping reserve scheduling of gas-fired units. The effect of emerging flexible resources such as electric vehicles, demand response programs and bask storage systems on generation scheduling, sniping reserve and flexible ramping reserve of generation units and system operation cost has been investigated in [7].

Combined heat and power (CHP) plants are practical solutions in supplying the heat and power demands of industrial, commercial and residential sectors. CHP plants are able to recover wasted heat in the conversion process of fossil fuels to power and heat. They take advantages of increasing the efficiency of power and heat supply to 90% and decreasing the gases emissions nearly 13-18% [8]. The other advantages of the CHP units are improving the reliability of delivered energy and security of supply [9]. It should be noted that the generated heat and power by the CHP plants have mutual dependency, which is defined as feasible operating region (FOR). Considering the significant advantages of CHP units in terms of cost savings and reduction of gas emissions, penetration of such technologies in providing heat and power demand of networks has been increased. Accordingly, several remarkable works have been done in the area of optimal operation of CHP plants in power networks. The authors have studied the optimal operation of CHP units in renewable energy-based microgrid in [10], where autoregressive integrated moving average (ARIMA) concept has been implemented to produce the wind power output scenario. The UC problem for CHP-based microgrids has been studied in [11] considering fuel cell and battery storage systems. The uncertainties of load demand and power market price are modeled in this study by using scenario-based modeling method. The authors have proposed a CHP-based market clearing model in [12], where the effect of constraints of power and heat network is investigated on the daily operation cost.

Information gap-decision theory (IGDT) is a robust decision modeling method for severe uncertain parameters, does not need probability distribution function of the uncertain parameters unlike other uncertainty modeling methods such as Monte Carlo simulation (MCS) concept and scenario-based modeling procedures. In addition, this method does not need to determine the maximum radius of uncertain parameter, which takes advantages of flexibility rate of the model in defining different strategies for the operator. Actually, the IGDT aims to obtain maximum uncertainty radius for uncertainty parameters in a way that the objective function is satisfied in the predefined interval. In power systems, IGDT is applied for bidding strategy challenges in electricity networks [13], UC problem [14] and restoration of distribution networks [15]. In [16], a self-scheduling model is studied based on IGDT method, which aims to obtain the maximum profit of generation company considering the uncertainty associated with power market price. In [17], IGDT concept is developed for modeling uncertainty of wind power generation in UC problem considering demand response programs. The profit of heat and power generation plants has been maximized using an IGDT model in [18] considering the uncertainty of the power market price. A robust framework based on IGDT procedure is proposed in [19] for studying SCUC problem in the presence of Latium-Ion energy storage technologies, where the uncertainty of load demand is taken into account. A robust NCUC scheme is introduced in [14] based on IGDT method considering energy storage system, demand response programs, and transmission switching.

Table I classifies the literature in modeling and investigating network-constrained unit commitment (NCUC) problem by providing a summary of uncertainty parameters and models. To the best knowledge of the authors, the network-constrained market clearing of joint energy and flexible ramping reserve for integrated heat and power systems under a hybrid optimization approach has not been discussed. Thus, this study proposes a novel two-stage hybrid IGDT-stochastic NCUC procedure for market clearing problem of joint energy and flexible ramping reserve in energy systems with penetration of CHP plants and wind turbines. An overall view of the proposed scheme has been demonstrated in Fig. 1. The main contributions of this paper can be highlighted as follows:

- The proposed two-stage hybrid IGDT-stochastic NCUC framework contains a here-and-now decision-making process in the first stage and wait-and-see procedure in the second one. The proposed model considers both risk-averse and risk-seeker strategies, which enables ISO to provide flexible decisions in meeting system uncertainties in real-time dispatch
- This study introduces a novel network-constrained market-clearing model of joint energy and flexible ramping reserve in integrated heat and power-based energy environment. The impact analysis of FOR of the cogeneration units on the participation of such units in energy and flexible ramping reserve market and operation cost of the system is performed.
- The uncertainties associated with system heat and power load demands and power production of the wind turbines are studied in the proposed model employing stochastic programming and IGDT approach to achieve an almost realistic market environment. Accordingly, the proposed model takes the advantages of increasing the flexibility and reliability of the market clearing operation in real-time dispatch when system encounters with different uncertainty scenarios.

The remainder of this paper is organized as follows: The problem formulation of the proposed network-constrained joint energy and flexible ramping reserve market clearing model is provided in Section II. The application of hybrid approach in the NCUC problem is provided in Section III. Section IV introduces the case study, the obtained results, and the associated analysis. Finally, the paper is concluded in Section V.

Table I. Comparison of the literature with the current work

References	CHP	Uncertainties			Uncertainty modeling method	FRPs
		Heat load	Electric load	Wind		
[6]			✓	✓	Stochastic	✓
[7]			✓	✓	Stochastic	✓
[20]				✓	Robust	
[12]	✓				Deterministic	
[19]			✓		IGDT	
[17]				✓	IGDT	
Proposed model	✓	✓	✓	✓	Hybrid IGDT-Stochastic	✓

II. PROBLEM FORMULATION

The proposed two-stage hybrid IGDT-stochastic NCUC model clears energy and flexible ramping reserve market, simultaneously in energy systems containing combined heat

and power, thermal units and wind turbines. The objective of the proposed model is hourly scheduling of generation units and flexible ramping reserve to minimize the operation cost of system. Uncertainties of wind power generation and heat and electricity demands are taken into account in the proposed model. Firstly, the two-stage stochastic problem is considered studying the heat and electricity demands uncertainty. Then, the IGDT will be adapted for dealing with uncertainty of wind power generation in Section III. Finally, the two-stage hybrid IGDT-stochastic model is presented. This section provides the objective function and constraints of the proposed model.

A. The proposed stochastic NCUC problem

The proposed stochastic NCUC framework contains two stages which is formulated as (1), where the first stage includes the cost of power generation, start-up/down and flexible ramping reserve. On the other hand, the second stage contains the adjustment of power due to fluctuations of power and heat loads in real-time dispatch which is defined as different scenarios. First, the stochastic programming is developed for the proposed model, which will be updated in the following sub-sections to implement the hybrid stochastic-IGDT concept. A mixed integer nonlinear programming is considered for the proposed model, which includes the power generation cost of thermal and CHP units and flexible ramping reserve cost for such plants.

$$\begin{aligned}
OF_b = \min & \sum_{t=1}^{NT} \sum_{i \in NG} \left[F_i^c(P_{i,t}) + SU_{i,t} + SD_{i,t} \right. \\
& \left. C_{i,t}^{DRU} FRU_{i,t} + C_{i,t}^{FRD} FRD_{i,t} \right] \\
& + \sum_{t=1}^{NT} \sum_{i \in NC} \left[F_i^c(P_{i,t}, H_{i,t}) + SU_{i,t} + SD_{i,t} \right. \\
& \left. C_{i,t}^{DRU} FRU_{i,t} + C_{i,t}^{FRD} FRD_{i,t} \right] \\
& + \sum_{t=1}^{NT} \sum_{s=1}^{NS} \pi_s \left[\sum_{i \in NG} (F_i^c(\Delta P_{i,t,s}^U) - F_i^c(\Delta P_{i,t,s}^D)) \right. \\
& \left. + \sum_{i \in NC} (F_i^c(\Delta P_{i,t,s}^U, \Delta H_{i,t,s}^U) - F_i^c(\Delta P_{i,t,s}^D, \Delta H_{i,t,s}^D)) \right] \quad (1)
\end{aligned}$$

B. Equality and inequality constraints of generation units

The thermal and CHP plants offer upward and downward flexible ramping reserves based on their ramp-up and ramp-down capability, which can be realistic considering the fluctuations in real-time dispatch. Accordingly, the following equations are stated including the power adjustment in the second stage:

$$0 \leq FRU_{i,t} \leq R_i^{up} \quad (2a)$$

$$0 \leq FRU_{i,t} + \Delta P_{i,t,s}^U \leq R_i^{up} \quad (2b)$$

$$0 \leq FRD_{i,t} \leq R_i^{dn} \quad (3a)$$

$$0 \leq FRD_{i,t} + \Delta P_{i,t,s}^D \leq R_i^{dn} \quad (3b)$$

The energy and flexible ramping reserve offered by the thermal and CHP plants should be limited to the lower and upper bounds in first and second stages as follows:

$$P_{i,t} + FRU_{i,t} \leq P_i^{\max} I_{i,t} \quad (4a)$$

$$P_{i,t} + \Delta P_{i,t,s}^U + FRU_{i,t} \leq P_i^{\max} I_{i,t} \quad (4b)$$

$$P_{i,t} - FRD_{i,t} \geq P_i^{\min} I_{i,t} \quad (5a)$$

$$P_{i,t} - \Delta P_{i,t,s}^D - FRD_{i,t} \geq P_i^{\min} I_{i,t} \quad (5b)$$

The power and heat generated by CHP plants have mutual dependency, which is called FOR. The FOR of the CHP type considered in this paper is shown in Fig. 2, which can be formulated in first stage and second stage as follows:

$$P_{CHP,t} + FRU_{CHP,t} - P_{CHP}^A - \frac{P_{CHP}^A - P_{CHP}^B}{H_{CHP}^A - H_{CHP}^B} (H_{CHP,t} - H_{CHP}^A) \leq 0 \quad (6a)$$

$$P_{CHP,t} + \Delta P_{CHP,t,s}^U + FRU_{CHP,t} - P_{CHP}^A - \frac{P_{CHP}^A - P_{CHP}^B}{H_{CHP}^A - H_{CHP}^B} (H_{CHP,t} + \Delta H_{CHP,t,s}^U - H_{CHP}^A) \leq 0 \quad (6b)$$

$$P_{CHP,t} - FRD_{CHP,t} - P_{CHP}^B - \frac{P_{CHP}^B - P_{CHP}^C}{H_{CHP}^B - H_{CHP}^C} \times (H_{CHP,t} - H_{CHP}^B) \geq -(1 - V_{CHP,t}) M \quad (7a)$$

$$P_{CHP,t} - \Delta P_{CHP,t,s}^D - FRD_{CHP,t} - P_{CHP}^B - \frac{P_{CHP}^B - P_{CHP}^C}{H_{CHP}^B - H_{CHP}^C} \times (H_{CHP,t} - \Delta H_{CHP,t,s}^D - H_{CHP}^B) \geq -(1 - V_{CHP,t}) M \quad (7b)$$

$$P_{CHP,t} - FRD_{CHP,t} - P_{CHP}^C - \frac{P_{CHP}^C - P_{CHP}^D}{H_{CHP}^C - H_{CHP}^D} \times (H_{CHP,t} - H_{CHP}^C) \geq -(1 - V_{CHP,t}) M \quad (8a)$$

$$P_{CHP,t} - \Delta P_{CHP,t,s}^D - FRD_{CHP,t} - P_{CHP}^C - \frac{P_{CHP}^C - P_{CHP}^D}{H_{CHP}^C - H_{CHP}^D} \times (H_{CHP,t} - \Delta H_{CHP,t,s}^D - H_{CHP}^C) \geq -(1 - V_{CHP,t}) M \quad (8b)$$

$$0 \leq H_{CHP,t} \leq H_{CHP}^A I_{CHP,t} \quad (9a)$$

$$0 \leq H_{CHP,t} + \Delta H_{CHP,t,s}^U - \Delta H_{CHP,t,s}^D \leq H_{CHP}^A I_{CHP,t} \quad (9b)$$

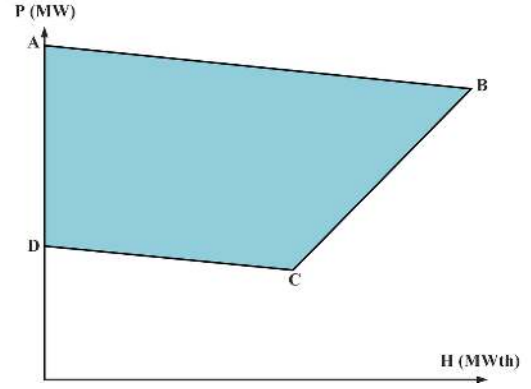

Fig. 2. FOR of the CHP plant

C. Network constraints

Power balance of the electrical energy network should be considered to provide the load demand by the generated power of thermal units, CHP plants and wind power production considering the power flow between the system buses. The power load balance and power flow between system nodes as well as limitation of limitations of power flow in first and second stage can be provided as follows:

$$\sum_{i=1}^{NU_b} P_{i,t} + \sum_{r=1}^{NW_b} P_{r,t}^f - \sum_{j=1}^{NJ_b} D_{j,t} = \sum_{L=1}^{NL_b} PF_{L,t}^0 \quad (10a)$$

$$\sum_{i=1}^{NU_b} (P_{i,t} + \Delta P_{i,t,s}^U - \Delta P_{i,t,s}^D) + \sum_{r=1}^{NW_b} P_{r,t}^f - \sum_{j=1}^{NJ_b} D_{j,t,s} = \sum_{L=1}^{NL_b} PF_{L,t,s} \quad (10b)$$

$$PF_{L,t}^0 = \frac{\delta_{b,t}^0 - \delta_{b',t}^0}{x_L} \quad (11a)$$

$$PF_{L,t,s} = \frac{\delta_{b,t,s} - \delta_{b',t,s}}{x_L} \quad (11b)$$

$$-PF_L^{\max} \leq PF_{L,t}^0 \leq PF_L^{\max} \quad (12a)$$

$$-PF_L^{\max} \leq PF_{L,t,s} \leq PF_L^{\max} \quad (12b)$$

The needed upward/downward flexible ramping of the system at each time interval should be satisfied by

$$\sum_{i=1}^{NU} FRU_{i,t} \geq RFRU_t \quad (13)$$

$$\sum_{i=1}^{NU} FRD_{i,t} \geq RFRD_t \quad (14)$$

It is assumed that the ISO has introduced a ramp prediction tool for determining the value of needed upward/downward flexible ramping of the system for following the variation of net load in real-time dispatch stage.

The heat balance of the network verifies the balance between heat generation of the CHP plants and heat load of the network considering the uncertainty associated with heat load in the second stage of the proposed model:

$$\sum_{i=1+NG}^{NC} H_{i,t} = \sum_{q=1}^{NQ} HD_{q,t} \quad (15a)$$

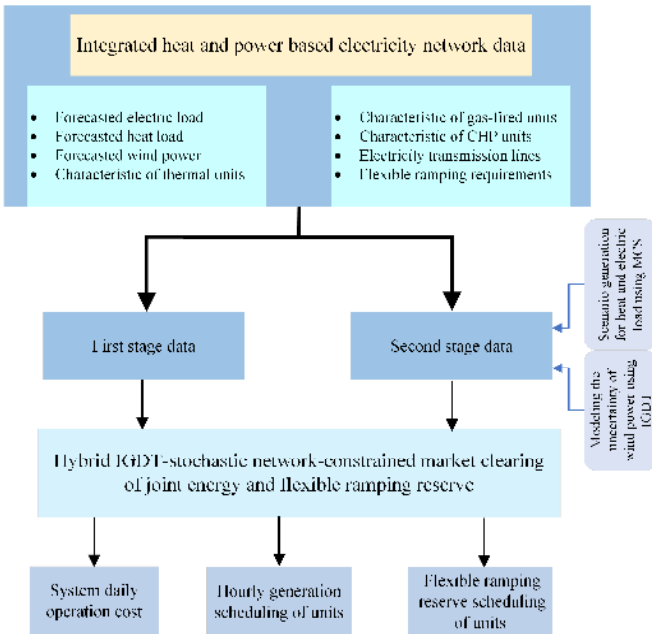

Fig. 1. An overall perspective of the proposed model

$$\sum_{i=1+NG}^{NC} (H_{i,t} + \Delta H_{i,t,s}^U - \Delta H_{i,t,s}^D) = \sum_{q=1}^{NQ} HD_{q,t,s} \quad (15b)$$

It should be noted that the minimum up-time and down-time limitations, ramp-up and ramp-down rates equations are also considered in this study, which are presented in [21, 22] by details.

III. APPLICATION OF HYBRID IGDT-STOCHASTIC ON THE NCUC PROBLEM

In this study, the stochastic and IGDT models are developed for handling uncertainties associated with wind power productions and heat and power load demands.

A. IGDT principles

The IGDT model does not require extra information such as a probability distribution function or fuzzy membership set of uncertain parameters. Such model obtains an optimal solution with high accuracy and practicality level unlike the stochastic modeling concept [23, 24], which determines the output variables dependent on the stochastic scenarios. The mathematical definition of uncertain parameters set can be stated by

$$U = U(\bar{\Psi}, \alpha) = \left\{ \Psi : \left| \frac{\Psi - \bar{\Psi}}{\bar{\Psi}} \right| \leq \alpha \right\} \quad (16)$$

Where, $\bar{\Psi}$ is the forecasted value of the uncertain parameter Ψ . Moreover, α is the maximum deviation of the uncertain parameter from the forecasted value, which is defined as uncertain unknown radius for the decision maker. An optimization problem under the IGDT technique can be formulated as a bi-level optimization problem by (17) and (18), which describe two strategies of risk-averse (RA) and risk-seeker (RS), respectively.

$$\alpha_r = \max \left\{ \alpha : \left(\max_{\Psi \in U(\bar{\Psi}, \alpha)} OF_c \leq \Delta_c = (1 + \beta_r) OF_b \right) \right\} \quad (17)$$

$$\alpha_o = \min \left\{ \alpha : \left(\min_{\Psi \in U(\bar{\Psi}, \alpha)} OF_o \leq \Delta_o = (1 - \beta_o) OF_b \right) \right\} \quad (18)$$

Where Δ_c and Δ_o are the satisfactory values of the objective function depending on β_r and β_o , which are obtained by the decision maker. β_r is the robustness level against the increment of the objective function concerning the basic condition value. β_o is the opportuneness level against the decrease of the objective function with respect to the basic condition value.

B. Hybrid IGDT-stochastic model

The proposed hybrid IGDT-stochastic NCUC model clears the joint energy and flexible ramping reserve market of CHP-based energy systems dealing with the uncertainties associated with electric and heat load demands and wind power generation using stochastic programming and IGDT, respectively. A simplified structure for the proposed hybrid IGDT-stochastic NCUC scheme is demonstrated in Fig. 3.

The NCUC problem for energy and flexible ramping reserve market clearing model based on two-stage hybrid IGDT- stochastic concept can be formulated using RA and RS strategies. In the RS strategy, the uncertain parameter has an unfavorable effect on the objective function. As a result, the system operator estimates a higher cost due to the undesirable variations of wind power. Since only a reduction in wind power generation has an adverse effect on the objective function, the proposed model can be stated as a single-level problem, which shows as follows :

$$\alpha_r = \max \alpha \quad (19)$$

$$\sum_{i=1}^{NU_b} (P_{i,t} + \Delta P_{i,t,s}^U - \Delta P_{i,t,s}^D) + \sum_{r=1}^{NW_b} P_{r,t}^f (1 - \alpha) - \sum_{j=1}^{NJ_b} D_{j,t,s} = \sum_{L=1}^{NL_b} PF_{L,t,s} \quad (20)$$

$$OF_c = \sum_{t=1}^{NT} \sum_{i \in NG} \left[F_i^c(P_{i,t}) + SU_{i,t} + SD_{i,t} \right] + \sum_{t=1}^{NT} \sum_{i \in NC} \left[C_{i,t}^{DRU} FRU_{i,t} + C_{i,t}^{FRD} FRD_{i,t} \right] \quad (21)$$

$$+ \sum_{t=1}^{NT} \sum_{s=1}^{NS} \pi_s \left[\sum_{i \in NG} (F_i^c(\Delta P_{i,t,s}^U) - F_i^c(\Delta P_{i,t,s}^D)) + \sum_{i \in NC} (F_i^c(\Delta P_{i,t,s}^U, \Delta H_{i,t,s}^U) - F_i^c(\Delta P_{i,t,s}^D, \Delta H_{i,t,s}^D)) \right] \quad (22)$$

$$OF_c \leq (1 + \beta_r) OF_b \quad (22)$$

$$0 \leq \beta_r \leq 1 \quad (23)$$

$$Eqs.(2) - (10a), (11a) - (15b) \quad (24)$$

The RS strategy aims to increase the chance of positive effect of uncertain parameter on the objective function. In this strategy, the uncertainty of wind power generation is the desired event. Since only an increase in wind power generation has a desired effect on the objective function, the proposed model can be defined as a single-level problem, which shows as follows :

$$\alpha_o = \min \alpha \quad (25)$$

$$\sum_{i=1}^{NU_b} (P_{i,t} + \Delta P_{i,t,s}^U - \Delta P_{i,t,s}^D) + \sum_{r=1}^{NW_b} P_{r,t}^f (1 + \alpha) - \sum_{j=1}^{NJ_b} D_{j,t,s} = \sum_{L=1}^{NL_b} PF_{L,t,s} \quad (26)$$

$$OF_c = \sum_{t=1}^{NT} \sum_{i \in NG} \left[F_i^c(P_{i,t}) + SU_{i,t} + SD_{i,t} \right] + \sum_{t=1}^{NT} \sum_{i \in NC} \left[C_{i,t}^{DRU} FRU_{i,t} + C_{i,t}^{FRD} FRD_{i,t} \right] \quad (27)$$

$$+ \sum_{t=1}^{NT} \sum_{s=1}^{NS} \pi_s \left[\sum_{i \in NG} (F_i^c(\Delta P_{i,t,s}^U) - F_i^c(\Delta P_{i,t,s}^D)) + \sum_{i \in NC} (F_i^c(\Delta P_{i,t,s}^U, \Delta H_{i,t,s}^U) - F_i^c(\Delta P_{i,t,s}^D, \Delta H_{i,t,s}^D)) \right] \quad (28)$$

$$OF_c \leq (1 - \beta_o) OF_b \quad (28)$$

$$0 \leq \beta_o \leq 1 \quad (29)$$

$$\text{Eqs. (2) - (10a), (11a) - (15b)} \quad (30)$$

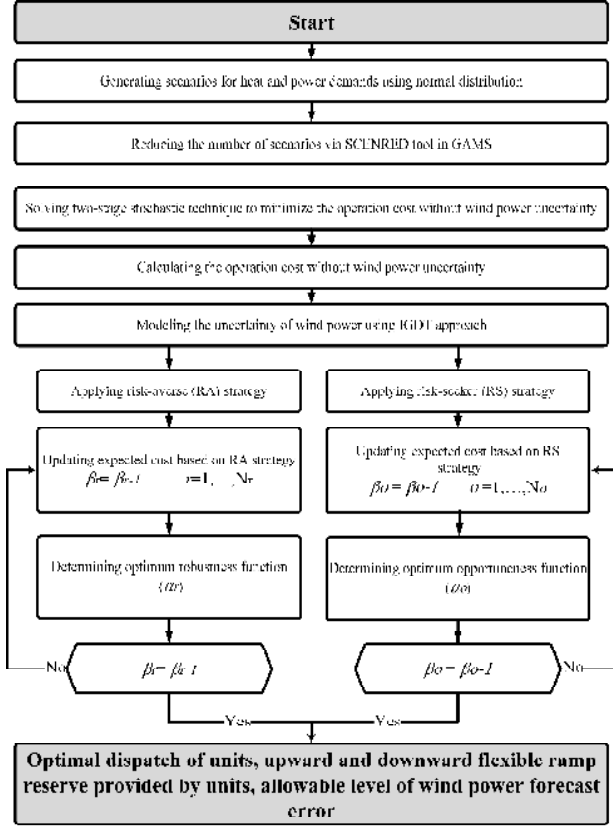

Fig. 3. Flowchart of the proposed hybrid IGDT-stochastic framework

IV. CASE STUDY AND SIMULATION RESULTS

The proposed model has been implemented on a case study in order to evaluate the performance of the model. The studied test system has been shown in Fig. 4, which is a 6-bus system including a CHP unit, two thermal plants, and a wind power generation unit. The power load demands are connected to buses 3, 4 and 5, and the heat load demand is connected to the CHP unit. The cost coefficients of the CHP unit and thermal plants are provided in Table II. The characteristics of FOR of the CHP unit, which is shown in Fig. 2, are adopted from [10] and scaled for achieving a 205 MW CHP unit. In addition, Table III includes technical characteristics of the generation units. The required up/down-ward flexible ramping reserve for each time interval is adopted from [6]. The offer for up/down-ward flexible ramping reserve cost of the CHP and thermal units considered as 20% of the first-order cost coefficient of each unit [6]. The forecasted energy demands and wind power production are shown in Fig. 3. The parameters of transmission lines are adopted from [25].

Three cases are considered in order to verify the high performance of the proposed model. The running time for all three cases is 5.3, 8.4 and 11.9 seconds, respectively. The three cases considered are studied as follows:

A. Case 1: Two-stage stochastic NCUC problem without FRPs

In this case, the uncertainties of electric and heat loads have been considered in the proposed two-stage NCUC problem. The forecasted error of the electric and heat loads follows a normal distribution function with a 10% standard deviation. The Monte Carlo simulation has been developed for generating 1000 scenarios. The number of generated scenarios has been decreased to 5 suitable scenarios utilizing the Fast-Backward method in GAMS/SCENRED [26]. The flexible ramping products have not been considered in this case. The scheduling of power generation of the production plants, including thermal plants G1 and G2 and cogeneration unit have been demonstrated in Fig. 5. The CHP unit has the maximum power supply with respect to other generation units, and it is participated in the whole-time interval for supplying heat demand in the whole-time interval. The expensive power generation plant G2 has co-operated in supply power demand in on-peak hours. The operation cost of the system, in this case, is obtained as \$115991.88.

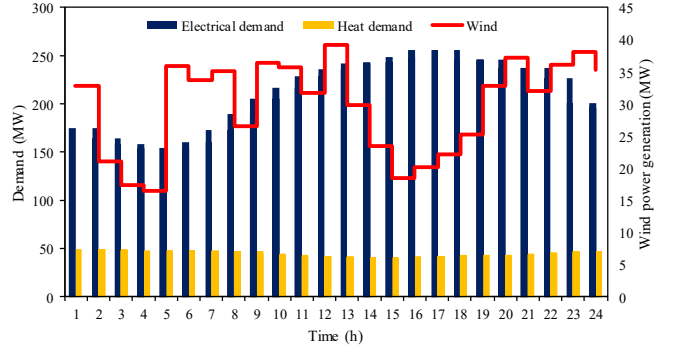

Fig. 3. The forecasted energy demand and wind power

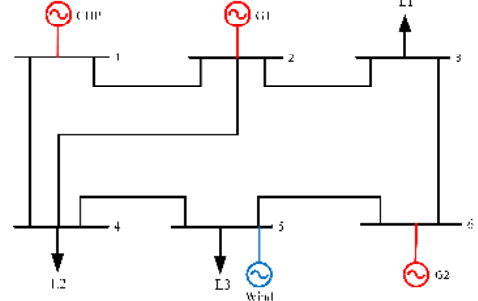

Fig. 4. The studied test system

Table II: Cost coefficients of the CHP and thermal units

	a (\$/MW ²)	b (\$/MW)	c (\$/h)	d (\$/MWth ²)	e (\$/MWth)	f (\$/MWth)
CHP	0.0345	14.5	110.41	0.03	4.2	0.031
G1	0.001	32.63	129.97	0	0	0
G2	0.005	17.7	137.41	0	0	0

Table III: Technical characteristics of the CHP and thermal units

	P_{min} (MW)	P_{max} (MW)	H_{min} (MWth)	H_{max} (MWth)	Initial status (h)	T_i^{On}	T_i^{Off}
CHP	68	205	0	150	4	1	1
G1	10	100	0	0	-3	2	3
G2	10	20	0	0	-1	1	1

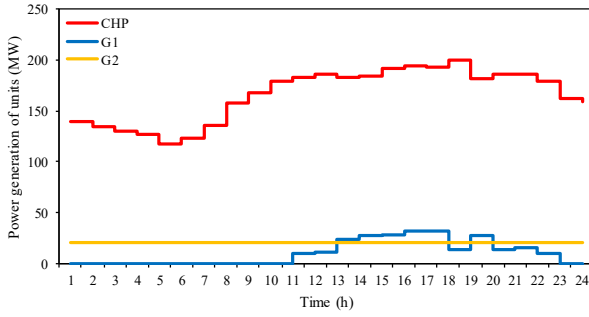

Fig. 5. Power generation scheduling of the plants in case 1

B. Case 2: Two-stage stochastic NCUC problem with FRPs

In this case, the flexible ramping products have been investigated in the proposed two-stage stochastic NCUC problem. The scheduling of flexible ramping reserve by the generation units have been demonstrated in Fig. 6. As seen in this figure, the whole upward ramping is provided by CHP unit between $t=1$ to $t=15$. On the other hand, a part of upward ramping is supplied by expensive thermal unit G1 between $t=13$ to $t=19$ due to the FOR of the CHP plant, which results to increment of the daily operation cost of the system. In addition, total upward ramping is supplied by the CHP unit between $t=20$ to $t=24$ by decrement of system electric load. Fig. 7 shows the effect of consideration of flexible ramping product on power generation scheduling of the plants. As seen in this figure, it is economical to assign a part of power dispatch of the CHP unit to upward ramp by decreasing the power generation of this unit, which causes an increment in power generation of G1. Increasing the power generation of G1 due to consideration of flexible ramping products results in higher operation cost. Accordingly, the operation cost has been increased to \$119990.99 in this case including \$116734.277 production cost and \$3256.713 flexible ramping reserve cost, which has attained a 3.4% increment with respect to the first case. Table IV describes the effect of consideration of FRPs on the served load in real-time dispatch due to variations of net load. It is assumed that the net load is increased by 15% in real-time dispatch. As can be seen, although considering flexible ramp products increases the operation cost of the day-ahead market, but it leads to a decrease in load shedding in $t=10$ and $t=11$, which enhances the system's reliability. In fact, considering flexible ramp products, the G1 unit is participated in $t=9$ and $t=10$ to increase the flexibility of the CHP unit to provide FRPs for handling net-load variabilities in real-time dispatch.

Heat production of the CHP unit has been illustrated in Fig. 8 for three different heat load levels. Variation of heat load has been studied for investigating the effect of heat load on power production and the flexible ramping reserve of the CHP unit. Moreover, Figures 9 and 10 depict the effect of variations of the heat load on hourly dispatch and upward ramping provided by the CHP and G1 units. As it is evident, increasing the heat load by 40% results in the lower power production of the CHP plant, which is related to the FOR limitation of the CHP unit. Accordingly, the sum of power generated and upward ramping of the CHP plant has been decreased in 1.4 heat load, which is effective in increasing the power generation and upward ramping of G1. The effect of heat load variations on the system

operation cost is provided in Table V. As seen in this table, the increment of the heat load caused to higher operation cost of the non-CHP units due to the mutual dependency of the power and heat networks.

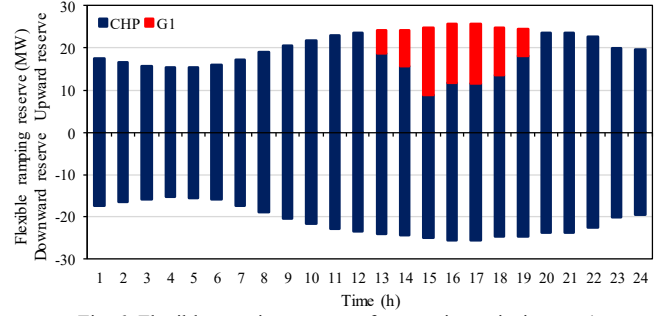

Fig. 6. Flexible ramping reserve of generation units in case 1

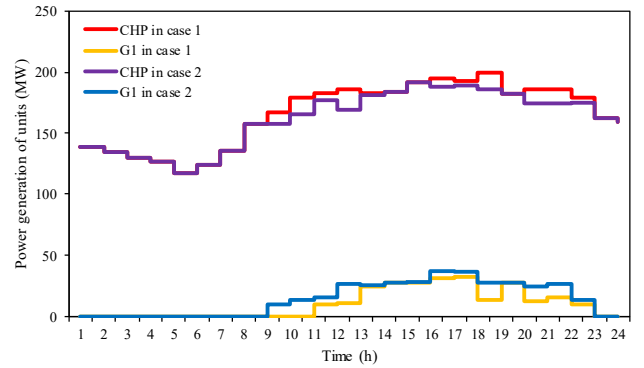

Fig. 7. Power generation scheduling of the plants in cases 1 and 2

Table IV. The effect of consideration of flexible ramp products on the served load in real-time dispatch

Time (h)	Net load in real-time dispatch (MW)	Maximum available power (MW)		Load shedding (MW)	
		Without FRPs	With FRPs	Without FRPs	With FRPs
1	201.4685	225	225	0	0
2	189.9225	225	225	0	0
3	182.5119	225	225	0	0
4	177.9395	225	225	0	0
5	178.319	225	225	0	0
6	184.552	225	225	0	0
7	199.3985	225	225	0	0
8	218.96	225	225	0	0
9	236.394	225	275	11.39	0
10	249.78	225	275	24.78	0
11	262.9015	285.626	285	0	0
12	271.515	299.234	289.112	0	0
13	278.507	302.539	290.611	0	0
14	280.14	302.918	301.999	0	0
15	286.189	306.351	300.984	0	0
16	294.1585	307.282	302.539	0	0
17	294.4	289.04	303.304	0	0
18	283.751	302.71	312.507	0	0
19	282.8655	287.971	311.431	0	0
20	272.9525	290.469	302.765	0	0
21	272.9065	285	302.71	0	0
22	261.211	285.626	300.076	0	0
23	231.2075	275	275	0	0
24	226.2625	225	225	0	0

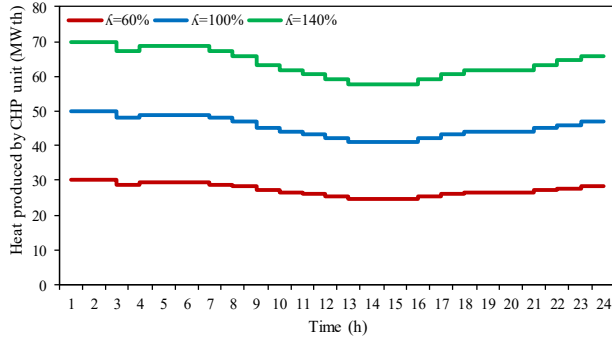

Fig. 8. Heat generation of the CHP unit for variation of heat load in case 2

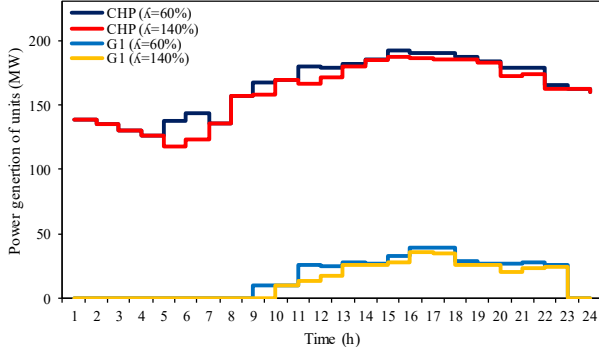

Fig. 9. Power generation scheduling of the plants for different heat load demands in case 2

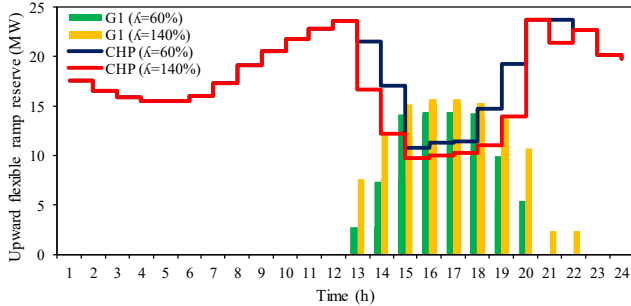

Fig. 10. Flexible ramping reserve scheduling of the plants for different heat load demands in case 2

Table V. The effect of heat load variations on operation cost of the system in case 2

	κ		
	60%	100%	140%
Operation cost of non-CHP units (\$)	22825.564	24901.57	25707.432

C. Case 3: Two-stage hybrid IGDT- stochastic NCUC problem with FRPs

In this case, the proposed hybrid stochastic-IGDT model has been analyzed for modeling the uncertainty of wind power generation and heat and power loads. The robustness parameter β_r has been increased from 0 to 0.04 by 0.01 step in order to evaluate different strategies of RA operation. The basic operation cost OF_b has been considered as the operation cost in case 2 as \$119990.99. Fig. 11 demonstrates the optimum robustness function α versus the robustness parameter β_r . As seen in this figure, the critical operation cost α is increased by increasing β_r , which means that ISO considers a vast range of the error forecasts of wind power generation in real-time dispatch (i.e. second stage of the proposed model).

The effect of β_r on the wind power generation under RA strategy is depicted in Fig. 13. As can be seen, by increasing β_r the generated wind power is reduced which leads to an increase in power generation of thermal units and the daily operation cost. The critical operation cost for $\beta_r=0.01$ and $\beta_r=0.04$ is equal to \$121,190.9 and \$124,790.63, which defines that ISO decides on a more robust strategy against the forecast error of wind power generation in real-time dispatch for $\beta_r=0.04$. In fact, in this strategy, ISO reduces the effect of wind power uncertainty on unbalancing generation and consumption in the real-time dispatch by increasing the day-ahead operation cost. Such unbalance can result in power market price spike or disrupting the reliability of the system in real-time. The robust power production of CHP and G1 for different robustness parameters has been shown in Fig. 12. As seen in this figure, the power generation of the CHP and G1 is increased for a higher level of β_r , which results in obtaining a more robust strategy against the wind power uncertainty. In order to evaluate opportunity strategy, opportunistic parameter β_o is increased between 0.01 and 0.04 by 0.01 steps for evaluating the opportunity strategy, where ISO is an optimist to the uncertainty of the wind power generation in real-time dispatch. The impact of β_o on the wind power generation under RS strategy is shown in Fig. 14. As can be seen, by increasing β_o the generated wind power is increase which leads to a decrease in the daily operation cost. The variation of optimum opportunistic function α against the variation of opportunistic parameter β_o is demonstrated in Fig. 13. As seen in this figure, by increasing the opportunistic parameter β_o the operation cost is decreased, and the optimum opportunistic function α is increased. In fact, ISO utilizes a more optimistic viewpoint by increasing β_o .

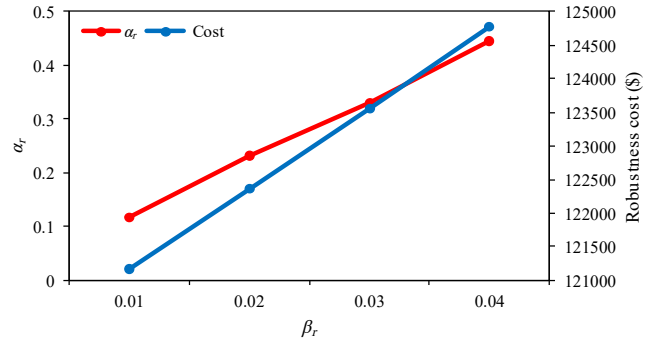

Fig. 11. Variation of robustness optimum function against robustness parameter in case 3

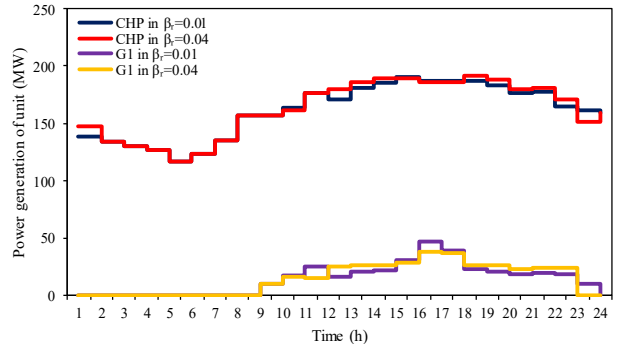

Fig. 12. Robust power generation for different robustness parameters in case 3

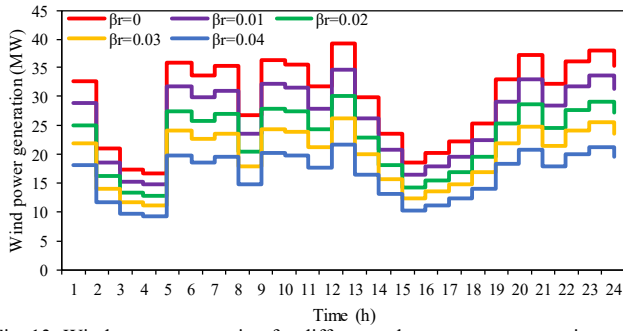

Fig. 13. Wind power generation for different robustness parameters in case 3

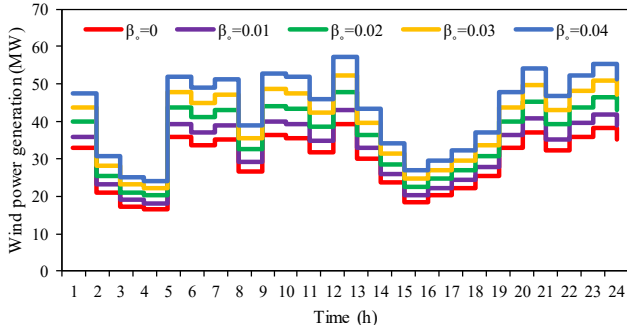

Fig. 14. Wind power generation for different opportuneness parameters in case 3

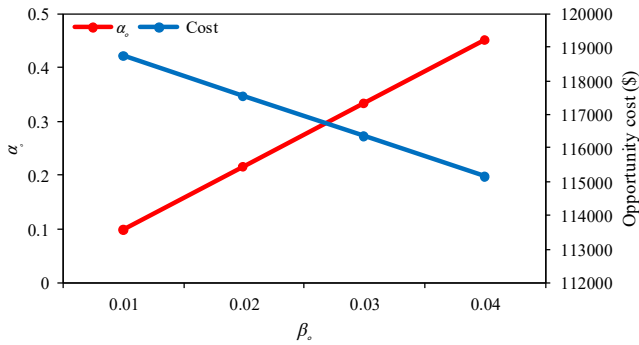

Fig. 15. Variation of opportunity optimum function against opportunistic parameter in case 3

V. CONCLUSION

This study introduced a network-constrained market clearing of joint energy and flexible ramping reserve for integrated heat and power energy systems. A novel two-stage hybrid IGDT-stochastic NCUC for the introduced market clearing was presented considering uncertainties of heat and power demands and wind power generation, which were handled using the Monte Carlo simulation method and IGDT, respectively. The proposed model considered both risk-seeker and risk-averse strategies enabling ISO to provide flexible decision versus uncertainties in real-time dispatch. The effect of consideration of FRPs in day-ahead market on production scheduling of the plants and operation cost of the system was investigated. In addition, the effect of FOR of the CHP units in their cooperation in energy and flexible ramping reserve markets and system operation cost were analyzed. The simulation results demonstrated that:

- Although considering FRPs led to an increment in operation cost of the day-ahead market by 3.4%, but it had a positive impact on reliability improvement by decreasing the load shedding in the real-time dispatch by 100%.

- The power and flexible ramping reserve provided by the CHP unit was a function of heat load variations, so that, by increasing heat load, the power and reserve provided by the CHP unit were decreased by 0.8% and 3.9%, respectively.
- The introduced hybrid approach facilitated the system operator to take benefit of both stochastic and IGDT methods, simultaneously.

REFERENCES

- [1] A. Alabdulwahab, A. Abusorrah, X. Zhang, and M. Shahidehpour, "Stochastic security-constrained scheduling of coordinated electricity and natural gas infrastructures," *IEEE Systems Journal*, vol. 11, pp. 1674-1683, 2015.
- [2] "IEA, World Energy Outlook. 2011. [Online]. Available: <http://www.worldenergyoutlook.org/weo2011/>."
- [3] Q. Wang and B.-M. Hodge, "Enhancing power system operational flexibility with flexible ramping products: A review," *IEEE Transactions on Industrial Informatics*, vol. 13, 2016.
- [4] B. Wang and B. F. Hobbs, "Real-time markets for flexiramp: A stochastic unit commitment-based analysis," *IEEE Transactions on Power Systems*, vol. 31, pp. 846-860, 2016.
- [5] N. Navid, G. Rosenwald, and D. Chatterjee, "Ramp capability for load following in the MISO markets," *Midwest Independent System Operator*, vol. 20, 2011.
- [6] X. Zhang, L. Che, M. Shahidehpour, A. Alabdulwahab, and A. Abusorrah, "Electricity-natural gas operation planning with hourly demand response for deployment of flexible ramp," *IEEE Transactions on Sustainable Energy*, vol. 7, pp. 996-1004, 2016.
- [7] E. Heydarian-Forushani, M. E. H. Golshan, M. Shafie-khah, and P. Siano, "Optimal Operation of Emerging Flexible Resources Considering Sub-Hourly Flexible Ramp Product," *IEEE Transactions on Sustainable Energy*, vol. 9, pp. 916-929, 2018.
- [8] M. Nazari-Heris, B. Mohammadi-Ivatloo, G. B. Gharehpetian, and M. Shahidehpour, "Robust short-term scheduling of integrated heat and power microgrids," *IEEE Systems Journal*, pp. 1-9, 2018.
- [9] E. A. M. Ceseña, N. Good, A. L. Syri, and P. Mancarella, "Techno-economic and business case assessment of multi-energy microgrids with co-optimization of energy, reserve and reliability services," *Applied Energy*, vol. 210, pp. 896-913, 2018.
- [10] M. Alipour, B. Mohammadi-Ivatloo, and K. Zare, "Stochastic scheduling of renewable and CHP-based microgrids," *IEEE Transactions on Industrial Informatics*, vol. 11, pp. 1049-1058, 2015.
- [11] M. Nazari-Heris, S. Abapour, and B. Mohammadi-Ivatloo, "Optimal economic dispatch of FC-CHP based heat and power micro-grids," *Applied Thermal Engineering*, vol. 114, pp. 756-769, 2017.
- [12] L. Deng, Z. Li, H. Sun, Q. Guo, Y. Xu, R. Chen, *et al.*, "Generalized locational marginal pricing in a heat-and-electricity-integrated market," *IEEE Transactions on Smart Grid*, vol. 10, pp. 6414-6425, 2019.
- [13] S. Shafiee, H. Zareipour, A. M. Knight, N. Amjady, and B. Mohammadi-Ivatloo, "Risk-constrained bidding and offering strategy for a merchant compressed air energy storage plant," *IEEE Transactions on Power Systems*, vol. 32, pp. 946-957, 2017.
- [14] A. Nikoobakht and J. Aghaei, "IGDT-based robust optimal utilisation of wind power generation using coordinated flexibility resources," *IET Renewable Power Generation*, vol. 11, pp. 264-277, 2016.
- [15] K. Chen, W. Wu, B. Zhang, and H. Sun, "Robust restoration decision-making model for distribution networks based on information gap decision theory," *IEEE Transactions on Smart Grid*, vol. 6, pp. 587-597, 2015.
- [16] B. Mohammadi-Ivatloo, H. Zareipour, N. Amjady, and M. Ehsan, "Application of information-gap decision theory to risk-constrained self-scheduling of GenCos," *IEEE Transactions on Power Systems*, vol. 28, pp. 1093-1102, 2013.
- [17] A. Soroudi, A. Rabiee, and A. Keane, "Information gap decision theory approach to deal with wind power uncertainty in unit commitment," *Electric Power Systems Research*, vol. 145, pp. 137-148, 2017.
- [18] J. Aghaei, V. G. Agelidis, M. Charwand, F. Raesi, A. Ahmadi, A. E. Nezhad, *et al.*, "Optimal robust unit commitment of CHP plants in electricity markets using information gap decision theory," *IEEE Transactions on Smart Grid*, vol. 8, pp. 2296-2304, 2017.

- [19] A. Ahmadi, A. E. Nezhad, and B. Hredzak, "Security-Constrained Unit Commitment in Presence of Lithium-Ion Battery Storage Units using Information-Gap Decision Theory," *IEEE Transactions on Industrial Informatics*, 2018.
- [20] C. Shao, X. Wang, M. Shahidehpour, X. Wang, and B. Wang, "Security-constrained unit commitment with flexible uncertainty set for variable wind power," *IEEE Transactions on Sustainable Energy*, vol. 8, pp. 1237-1246, 2017.
- [21] M. I. Alizadeh, M. P. Moghaddam, and N. Amjadi, "Multistage Multiresolution Robust Unit Commitment With Nondeterministic Flexible Ramp Considering Load and Wind Variabilities," *IEEE Transactions on Sustainable Energy*, vol. 9, pp. 872-883, 2018.
- [22] A. Alabdulwahab, A. Abusorrah, X. Zhang, and M. Shahidehpour, "Stochastic security-constrained scheduling of coordinated electricity and natural gas infrastructures," *IEEE Systems Journal*, vol. 11, pp. 1674-1683, 2017.
- [23] M. A. Mirzaei, M. Nazari-Heris, B. Mohammadi-Ivatloo, K. Zare, M. Marzband, and A. Anvari-Moghaddam, "A Novel Hybrid Framework for Co-Optimization of Power and Natural Gas Networks Integrated With Emerging Technologies," *IEEE Systems Journal*, 2020.
- [24] M. Hemmati, B. Mohammadi-Ivatloo, M. Abapour, and A. Anvari-Moghaddam, "Optimal Chance-Constrained Scheduling of Reconfigurable Microgrids Considering Islanding Operation Constraints," *IEEE Systems Journal*, 2020.
- [25] M. A. Mirzaei, A. Sadeghi-Yazdankhah, B. Mohammadi-Ivatloo, M. Marzband, M. Shafie-khah, and J.P.S. Catalão, "Integration of emerging resources in IGDT-based robust scheduling of combined power and natural gas systems considering flexible ramping products," *Energy*, vol. 189, p. 116195, 2019.
- [26] M. A. Mirzaei, A. S. Yazdankhah, B. Mohammadi-Ivatloo, M. Marzband, M. Shafie-khah, and J.P.S. Catalão, "Stochastic network-constrained co-optimization of energy and reserve products in renewable energy integrated power and gas networks with energy storage system," *Journal of cleaner production*, vol. 223, pp. 747-758, 2019.