

Neuromodeling of Microwave Circuits Exploiting Space-Mapping Technology

John W. Bandler, *Fellow, IEEE*, Mostafa A. Ismail, *Student Member, IEEE*,
 José Ernesto Rayas-Sánchez, *Senior Member, IEEE*,
 and Qi-Jun Zhang, *Senior Member, IEEE*

Abstract— For the first time, we present modeling of microwave circuits using artificial neural networks (ANN's) based on space-mapping (SM) technology. SM-based neuromodels decrease the cost of training, improve generalization ability, and reduce the complexity of the ANN topology with respect to the classical neuromodeling approach. Five creative techniques are proposed to generate SM-based neuromodels. A frequency-sensitive neuromapping is applied to overcome the limitations of empirical models developed under quasi-static conditions. Huber optimization is used to train the ANN's. We contrast SM-based neuromodeling with the classical neuromodeling approach as well as with other state-of-the-art neuromodeling techniques. The SM-based neuromodeling techniques are illustrated by a microstrip bend and a high-temperature superconducting filter.

Index Terms— CAD, design automation, microstrip filters, microwave circuits, neural network applications, neuromodeling, neural space mapping, optimization methods, space mapping.

I. INTRODUCTION

A POWERFUL new concept in neuromodeling of microwave circuits based on space-mapping (SM) technology is presented. The ability of artificial neural networks (ANN's) to model high-dimensional and highly nonlinear problems is exploited in the implementation of the SM concept. By taking advantage of the vast set of empirical models already available, SM-based neuromodels decrease the number of electromagnetic (EM) simulations for training, improve generalization ability, and reduce the complexity of the ANN topology with respect to the classical neuromodeling approach.

The following five innovative techniques are proposed to create SM-based neuromodels for microwave circuits:

- 1) space-mapped neuromodeling (SMN);
- 2) frequency-dependent space-mapped neuromodeling (FDSMN);

Manuscript received March 26, 1999; revised July 12, 1999. This work was supported in part by the Natural Sciences and Engineering Research Council of Canada under Grant OGP0007239 and under Grant STPO201832, and by the Micronet Network of Centres of Excellence. The work of J. E. Rayas-Sánchez was supported by the Consejo Nacional de Ciencia y Tecnología, and by the Instituto Tecnológico y de Estudios Superiores de Occidente.

J. W. Bandler is with the Simulation Optimization Systems Research Laboratory, Department of Electrical and Computer Engineering, McMaster University, Hamilton, Ont., Canada L8S 4K1, and is also with the Bandler Corporation, Dundas, Ont., Canada L9H 5E7.

M. A. Ismail and J. E. Rayas-Sánchez are with the Simulation Optimization Systems Research Laboratory, Department of Electrical and Computer Engineering, McMaster University, Hamilton, Ont., Canada L8S 4K1.

Q.-J. Zhang is with the Department of Electronics, Carleton University, Ottawa, Ont., Canada K1S 5B6.

Publisher Item Identifier S 0018-9480(99)08438-0.

- 3) frequency space-mapped neuromodeling (FSMN);
- 4) frequency-mapped neuromodeling (FMN);
- 5) frequency partial-space-mapped neuromodeling (FPSM).

Except for SMN, all these approaches establish a frequency-sensitive neuromapping to expand the frequency region of accuracy of the empirical models already available for microwave components that were developed using quasi-static analysis. We contrast our approach with the classical neuromodeling approach, as well as with other state-of-the-art neuromodeling techniques.

Huber optimization is used to efficiently train the ANN's as a powerful alternative to the popular backpropagation algorithm [1]. The SM-based neuromodeling techniques are illustrated by two case studies: a microstrip right-angle bend and a high-temperature superconducting (HTS) quarter-wave parallel coupled-line microstrip filter.

II. SM CONCEPT

SM is a novel concept for circuit design and optimization, which combines the computational efficiency of coarse models with the accuracy of fine models. The coarse models are typically empirical equivalent-circuit engineering models, which are computationally very efficient, but often have a limited validity range for their parameters, beyond which the simulation results may become inaccurate. On the other hand, detailed or "fine" models can be provided by an electromagnetic (EM) simulator or even by direct measurements: they are very accurate, but central processing unit (CPU) intensive. The SM technique establishes a mathematical link between the coarse and the fine models, and directs the bulk of CPU intensive evaluations to the coarse model, while preserving the accuracy and confidence offered by the fine model. The SM technique was originally developed by Bandler *et al.* [2].

Let the vectors \mathbf{x}_c and \mathbf{x}_f represent the design parameters of the coarse and fine models, respectively, and $\mathbf{R}_c(\mathbf{x}_c)$ and $\mathbf{R}_f(\mathbf{x}_f)$ the corresponding model responses. \mathbf{R}_c is much faster to calculate, but less accurate than \mathbf{R}_f .

As illustrated in Fig. 1, the aim of SM optimization is to find an appropriate mapping \mathbf{P} from the fine model parameter space \mathbf{x}_f to the coarse model parameter space \mathbf{x}_c

$$\mathbf{x}_c = \mathbf{P}(\mathbf{x}_f) \quad (1)$$

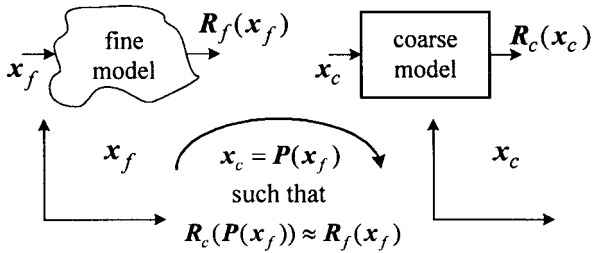

Fig. 1. Illustration of the aim of SM.

such that

$$R_c(P(x_f)) \approx R_f(x_f). \quad (2)$$

Once the mapping is found, the coarse model can be used for fast and accurate simulations.

III. NEUROMODELING MICROWAVE CIRCUITS

The ability to learn and generalize from data, the nonlinear processing nature, and the massively parallel structure make the ANN particularly suitable in modeling high-dimensional and highly nonlinear problems, as in the case of microwave circuits.

The size of an ANN model does not grow exponentially with dimension and, in theory, can approximate any degree of nonlinearity to any desired level of accuracy, provided a deterministic relationship between input and target exists [3]. The most widely used ANN paradigm in the microwave arena [1] is the multilayer perceptron (MLP), which is usually trained by the well-established backpropagation algorithm.

ANN models are computationally more efficient than EM or physics-based models and can be more accurate than empirical models. It has been demonstrated [4], [5] that ANN's are suitable models for microwave circuit yield optimization and statistical design.

For microwave problems, the learning data is usually obtained by either EM simulation or by measurement. Large amounts of learning data are typically needed to ensure model accuracy. This is very expensive since the simulation/measurements must be performed for many combinations of different values of geometrical, material, process, and input signal parameters. This is the principal drawback of classical ANN modeling. Without sufficient learning samples, the neural models may not be reliable.

A popular alternative to reduce the dimension of the learning set is to carefully select the learning points using the design of experiments (DoE) methodology. Another way to speed up the learning process is proposed in [1] by means of preliminary neural clusterization of similar responses using the self-organizing feature map (SOM) approach.

Innovative strategies have been proposed to reduce the learning data needed and to improve the generalization capabilities of an ANN by incorporating empirical models: the hybrid EM-ANN modeling approach, the prior knowledge input (PKI) modeling method, and the knowledge-based ANN (KBNN) approach.

In the hybrid EM-ANN modeling approach [6], the difference in S -parameters between the available coarse model

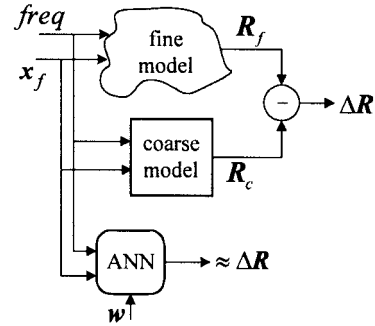

Fig. 2. EM-ANN neuromodeling concept [6].

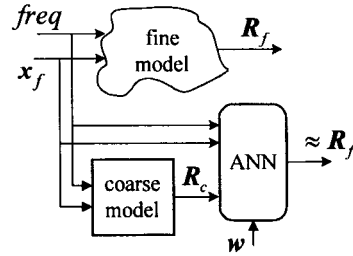

Fig. 3. PKI neuromodeling concept [6].

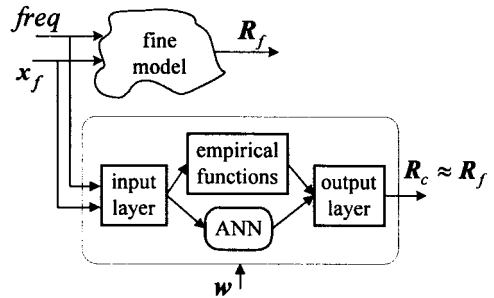

Fig. 4. KBNN neuromodeling concept [7].

and fine model is used to train the corresponding ANN, as illustrated in Fig. 2, reducing the number of fine model simulations due to a simpler input-output relationship.

For the PKI method [6], the coarse model output is used as input for the ANN in addition to the other inputs (physical parameters and frequency). The ANN is trained such that its response is approximately equal to the fine model response, as illustrated in Fig. 3. The PKI approach has shown better accuracy than the EM-ANN approach, but it requires a more complex ANN.

In the KBNN approach [7], the microwave empirical or semianalytical information is incorporated into the internal structure of the ANN, as illustrated in Fig. 4. KBNN's are nonfully connected networks, with a layer assigned to the microwave knowledge in the form of single or multidimensional functions. Since these empirical functions are used for some neurons instead of standard activation functions, KBNN's do not follow a regular MLP and are trained using methods other than the conventional backpropagation.

IV. SM-BASED NEUROMODELING

We propose innovative schemes to combine SM technology and ANN for the modeling of high-frequency components. The

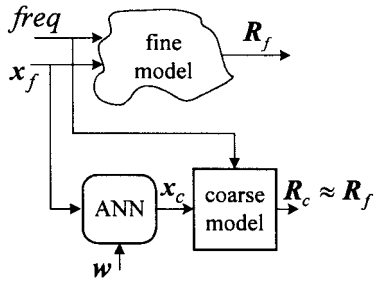

Fig. 5. SMN concept.

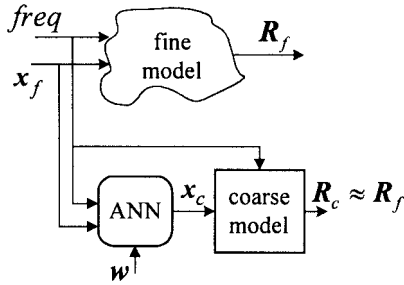

Fig. 6. FDSMN concept.

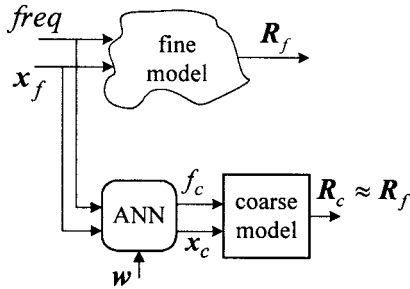

Fig. 7. FSMN concept.

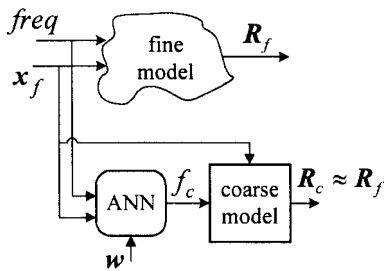

Fig. 8. FMN concept.

fundamental idea is to construct a nonlinear multidimensional vector mapping function \mathbf{P} from fine to coarse input space using an ANN. This can be done in a variety of ways, to make better use of the coarse-model information for developing the neuromodel. The implicit knowledge in the coarse model not only allows us to decrease the number of learning points needed, but also to reduce the complexity of the ANN and to improve the generalization performance.

In the SMN approach, the mapping from the fine to the coarse parameter space is implemented by an ANN. Fig. 5 illustrates the SMN concept. We have to find the optimal set of the internal parameters of the ANN, such that the coarse model

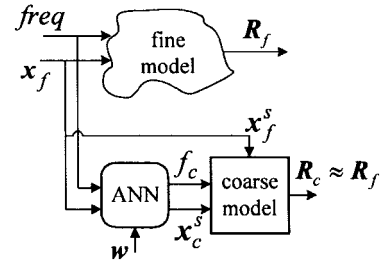

Fig. 9. FPSMN concept.

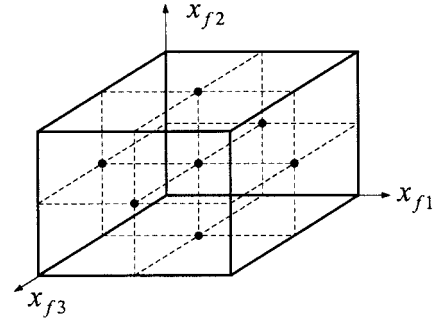

Fig. 10. Three-dimensional star distribution for the learning base points.

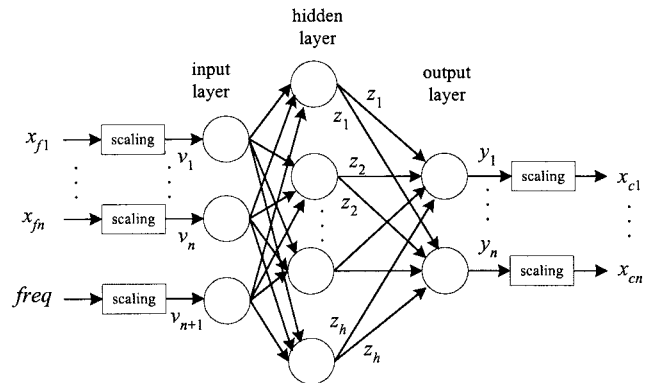

Fig. 11. Implementing the frequency-dependent neuromapping with a three-layer perceptron, as in Fig. 6.

 TABLE I
 REGION OF INTEREST FOR THE MICROSTRIP RIGHT-ANGLE BEND

Parameter	Minimum value	Maximum value
W	20 mil	30 mil
H	8 mil	16 mil
ϵ_r	8	10
$freq$	1 GHz	41 GHz

response is as close as possible to the fine model response for all the learning points.

The mapping can be found by solving the optimization problem

$$\min_{\mathbf{w}} \|\mathbf{e}_1^T \quad \mathbf{e}_2^T \quad \cdots \quad \mathbf{e}_l^T\|^T \quad (3)$$

where vector \mathbf{w} contains the internal parameters of the neural network (weights, bias, etc.) selected as optimization variables,

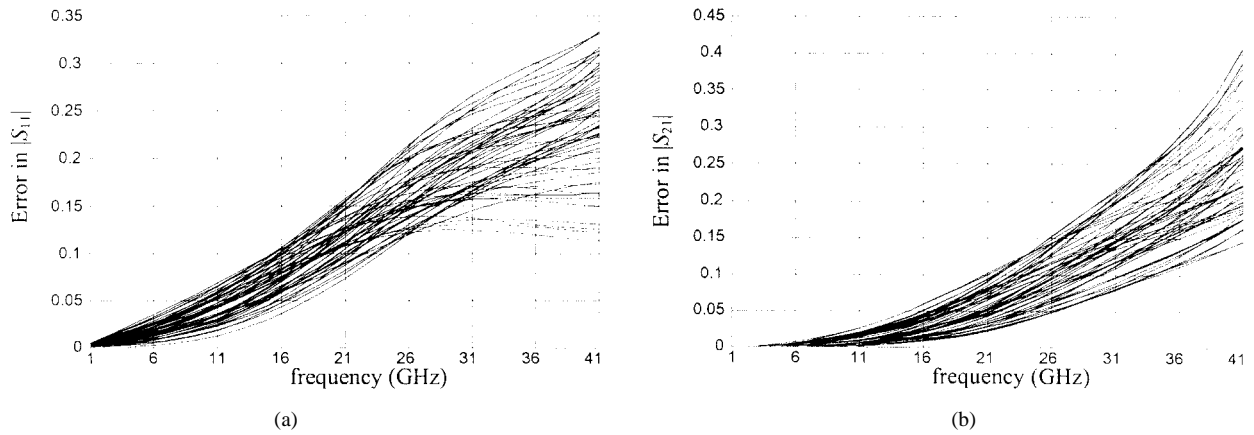

Fig. 12. Comparison between *em* and Gupta model of a right-angle bend. (a) Error in $|S_{11}|$ with respect to *em*. (b) Error in $|S_{21}|$ with respect to *em*.

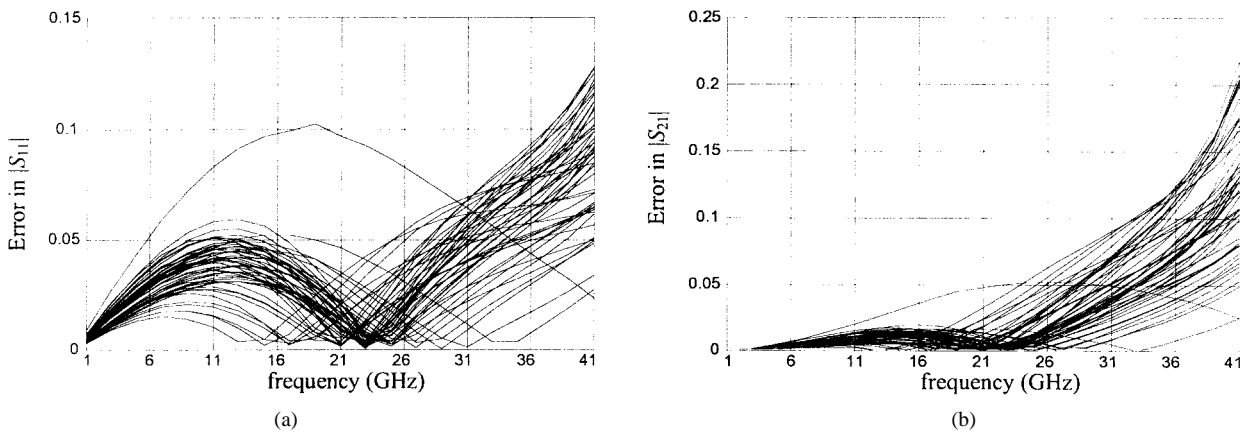

Fig. 13. Comparison between *em* and SMN model of a right-angle bend. (a) Error in $|S_{11}|$ with respect to *em*. (b) Error in $|S_{21}|$ with respect to *em*.

l is the total number of learning samples, and \mathbf{e}_k is the error vector given by

$$\mathbf{e}_k = \mathbf{R}_f(\mathbf{x}_{f_i}, freq_j) - \mathbf{R}_c(\mathbf{x}_c, freq_j) \quad (4a)$$

$$\mathbf{x}_c = \mathbf{P}(\mathbf{x}_{f_i}) \quad (4b)$$

with

$$i = 1, \dots, B_p \quad (5a)$$

$$j = 1, \dots, F_p \quad (5b)$$

$$k = j + F_p(i - 1) \quad (5c)$$

where B_p is the number of training base points for the input design parameters and F_p is the number of frequency points per frequency sweep. It is seen that the number of learning samples is $l = B_p F_p$. The specific characteristics of \mathbf{P} depend on the ANN paradigm chosen whose internal parameters are in \mathbf{w} .

Once the mapping is found, i.e., once the ANN is trained, a space-mapped neuromodel for fast accurate evaluations is immediately available.

A. Including Frequency in the Neuromapping

Many of the empirical models already available for microwave circuits were developed using methods for quasi-static analysis: they usually yield good accuracy over a limited

TABLE II
REGION OF INTEREST FOR THE HTS FILTER

Parameter	Minimum value	Maximum value
W	7 mil	7 mil
H	20 mil	20 mil
ϵ_r	23.425	23.425
loss tang	3×10^{-5}	3×10^{-5}
L_0	50 mil	50 mil
L_1	175 mil	185 mil
L_2	190 mil	210 mil
L_3	175 mil	185 mil
S_1	18 mil	22 mil
S_2	75 mil	85 mil
S_3	70 mil	90 mil
$freq$	3.901 GHz	4.161 GHz

range of low frequencies. A method to directly overcome this limitation is by establishing a frequency-sensitive mapping from the fine to the coarse input spaces. This is realized by considering frequency as an extra input variable of the ANN that implements the mapping.

In the FDSMN approach, illustrated in Fig. 6, both coarse and fine models are simulated at the same frequency, but the mapping from the fine to coarse parameter space is dependent on the frequency. The mapping is found by solving the same

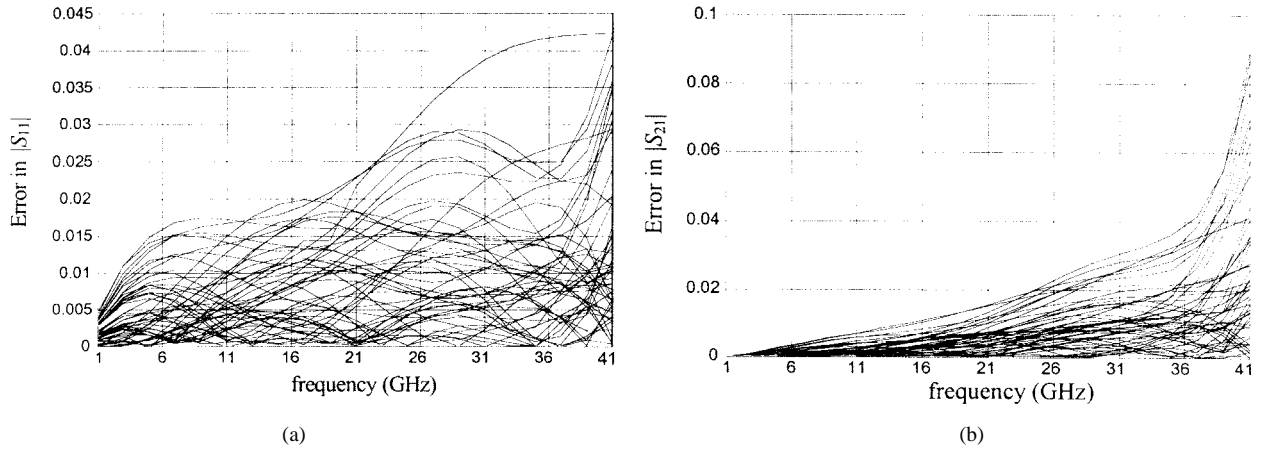

Fig. 14. Comparison between *em* and FDSMN model of a right-angle bend. (a) Error in $|S_{11}|$ with respect to *em*. (b) Error in $|S_{21}|$ with respect to *em*.

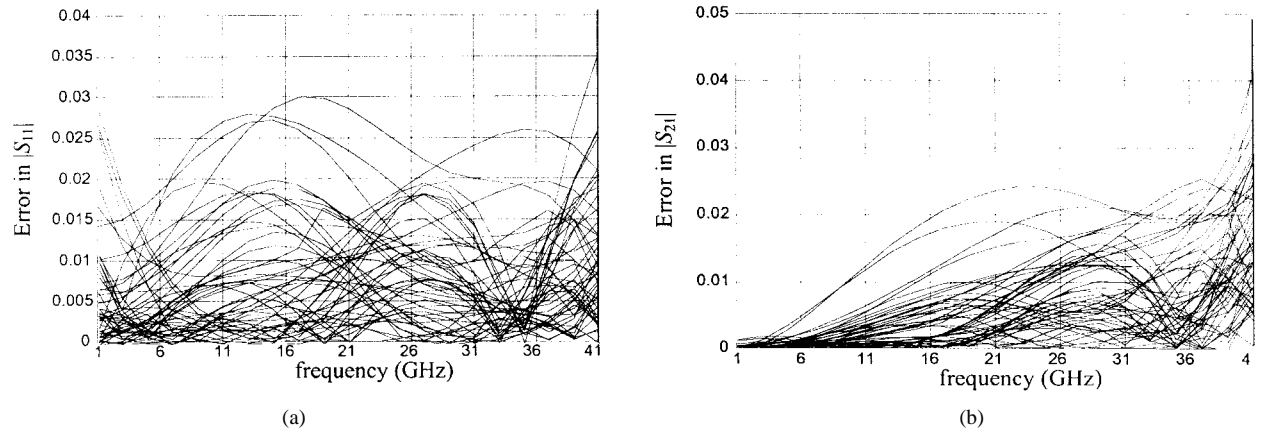

Fig. 15. Comparison between *em* and FSMN model of a right-angle bend. (a) Error in $|S_{11}|$ with respect to *em*. (b) Error in $|S_{21}|$ with respect to *em*.

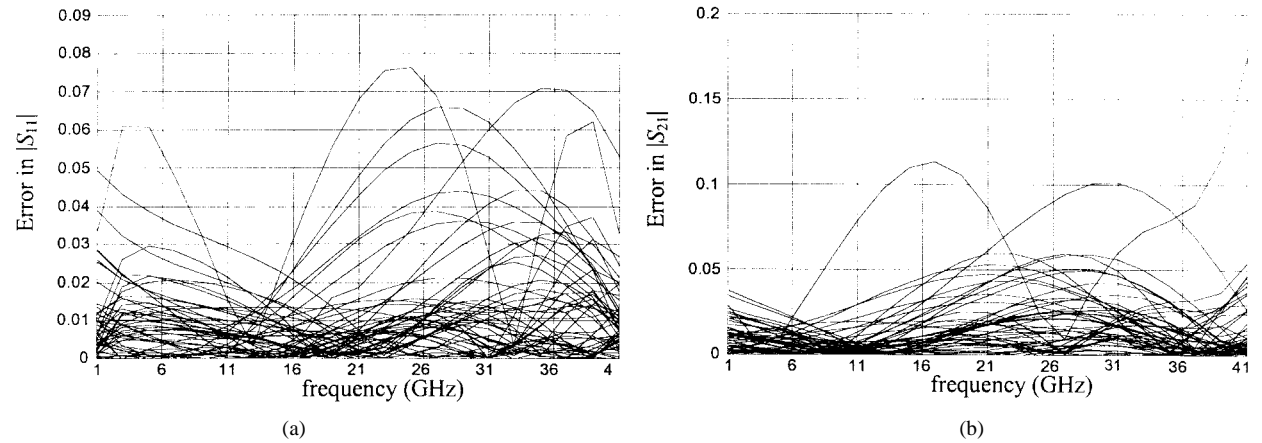

Fig. 16. Comparison between *em* and classical neuromodel of a right-angle bend. (a) Error in $|S_{11}|$ with respect to *em*. (b) Error in $|S_{21}|$ with respect to *em*.

optimization problem stated in (3), but substituting (4) by

$$\mathbf{e}_k = \mathbf{R}_f(\mathbf{x}_{f_i}, freq_j) - \mathbf{R}_c(\mathbf{x}_c, freq_j) \quad (6a)$$

$$\mathbf{x}_c = \mathbf{P}(\mathbf{x}_{f_i}, freq_j). \quad (6b)$$

With a more comprehensive domain, the FSMN technique establishes a mapping not only for the design parameters, but also for the frequency variable, such that the coarse model is simulated at a mapped frequency f_c to match the fine model

response. This is realized by adding an extra output to the ANN that implements the mapping, as shown in Fig. 7. The mapping is found by solving the same optimization problem stated in (3), but interchanging (4) by

$$\mathbf{e}_k = \mathbf{R}_f(\mathbf{x}_{f_i}, freq_j) - \mathbf{R}_c(\mathbf{x}_c, f_c) \quad (7a)$$

$$\begin{bmatrix} \mathbf{x}_c \\ f_c \end{bmatrix} = \mathbf{P}(\mathbf{x}_{f_i}, freq_j). \quad (7b)$$

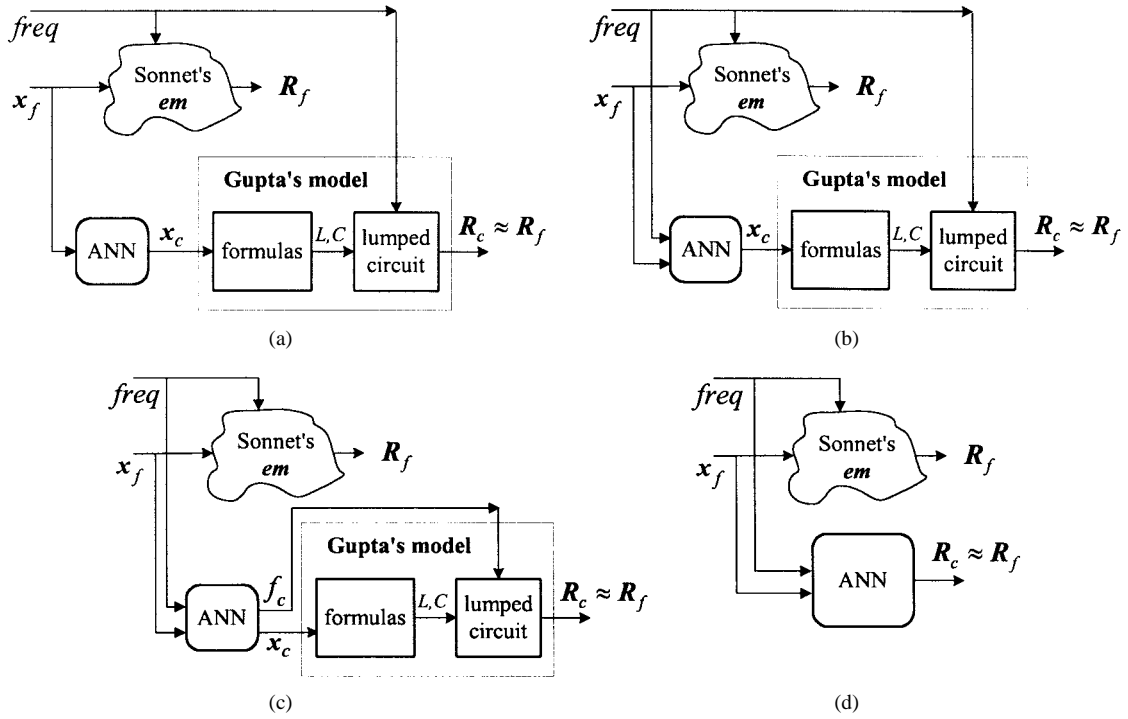

Fig. 17. Different neuromodeling approaches for the right-angle bend. (a) SMN. (b) FDSMN. (c) FSMN. (d) Classical neuromodeling.

It is not uncommon to find microwave problems where the coarse model behaves almost as the fine model does, but with a shifted frequency response, i.e., the shapes of the responses are nearly identical, but shifted. For those cases, a good alignment between both responses is achieved by simulating the coarse model at a different frequency. The FMN technique implements this strategy, as shown in Fig. 8, by simulating the coarse model with the same physical parameters used by the fine model, but at a mapped frequency f_c to align both responses. The mapping is found by solving the same optimization problem stated in (3), but replacing (4) by

$$\mathbf{e}_k = \mathbf{R}_f(\mathbf{x}_{f_i}, \text{freq}_j) - \mathbf{R}_c(\mathbf{x}_{f_i}, f_c) \quad (8a)$$

$$f_c = P(\mathbf{x}_{f_i}, \text{freq}_j). \quad (8b)$$

Mapping the whole set of physical parameters, as in the SMN, FDSMN, and FSMN techniques, might lead to singularities in the coarse model response during training. This problem is overcome by establishing a partial mapping for the physical parameters, making even more efficient use of the implicit knowledge in the coarse model. Mapping only some of the physical parameters can be enough to obtain acceptable accuracy in the neuromodel for many microwave problems. This allows us a significant reduction in the ANN complexity with respect to the SMN, FDSMN, and FSMN techniques and a significant reduction in the training time because less optimization variables are used. FDSMN is illustrated in Fig. 9. The mapping for this technique is found by solving the same optimization problem stated in (3), but replacing (4) by

$$\mathbf{e}_k = \mathbf{R}_f(\mathbf{x}_{f_i}, \text{freq}_j) - \mathbf{R}_c(\mathbf{x}_{f_i}^s, \mathbf{x}_c^s, f_c) \quad (9a)$$

$$\begin{bmatrix} \mathbf{x}_c^s \\ f_c \end{bmatrix} = P(\mathbf{x}_{f_i}, \text{freq}_j) \quad (9b)$$

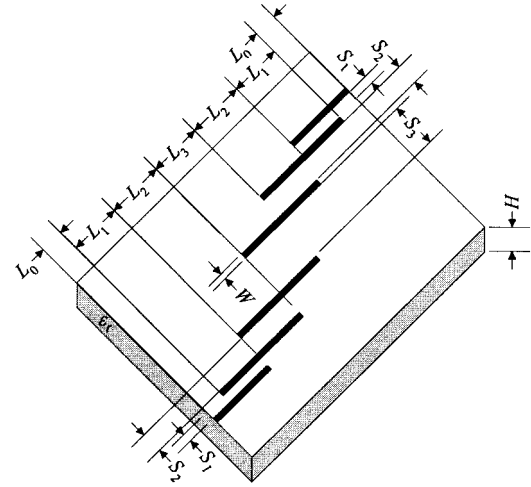

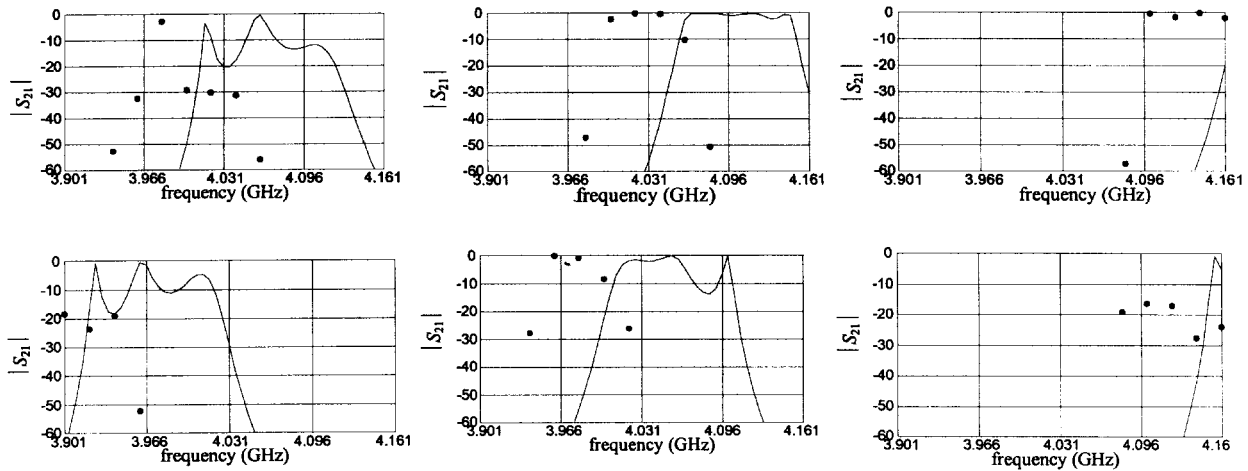

Fig. 19. Typical responses of the HTS filter using *em* (•) and OSA90/hope model (—) before any neuromodeling at three learning and three testing points.

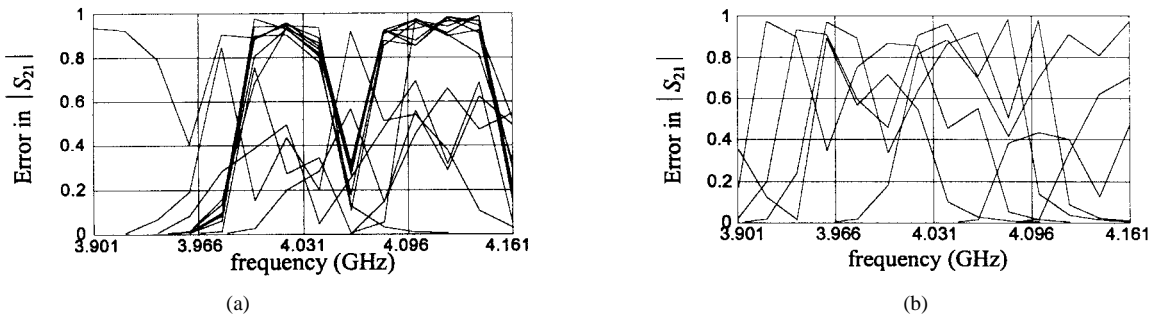

Fig. 20. Coarse model error with respect to *em* before any neuromodeling. (a) In the learning set. (b) In the testing set.

is chosen assuming that the coarse model is actually a good model and, therefore, the mapping is not necessary. In other words, $\mathbf{w}^{(1)}$ is chosen such that the ANN implements a unit mapping $\mathbf{P}(\mathbf{x}_c = \mathbf{x}_f$ and/or $f_c = freq$). This is applicable to the five proposed SM-based neuromodeling techniques.

The ANN must be trained to learn the mapping between the coarse and fine input spaces within the region of interest. In order to keep a reduced set of learning data samples, an n -dimensional star distribution for the base learning points is considered in this paper, as in [8] (see Fig. 10). It is seen that the number of learning base points for a microwave circuit with n design parameters is $B_p = 2n + 1$.

Since we want to maintain a minimum number of learning points (or fine evaluations), the complexity of the ANN is critical. It is well known that too small an ANN cannot approximate the desired input–output relationship, while ANN’s with too many internal parameters perform correctly on the learning set, but give poor generalization ability. We have to use the simplest ANN that gives adequate training error and acceptable generalization performance.

C. Mapping with a Three-Layer Perceptron

A possible scheme to implement the mapping using a three-layer perceptron with h hidden neurons, for both the SMN approach as well as the FDSMN approach, is illustrated in Fig. 11. Here, the total number of optimization variables for (3) is $2h(n + 1) + n$, where n is the number of physical

parameters to be mapped and h is the number of hidden neurons. The adaptation of this paradigm to all the other three cases is realized by considering an additional output for the mapped frequency f_c and disabling the corresponding inputs and/or outputs.

In this work, we considered sigmoid functions as well as hyperbolic tangent functions to implement the nonlinear activation functions for the neurons in the hidden layer.

V. CASE STUDIES

A. Microstrip Right-Angle Bend

Consider a microstrip right-angle bend with the following input parameters: conductor width W , substrate height H , substrate dielectric constant ϵ_r , and operating frequency $freq$. Three neuromodels exploiting SM technology are developed for the region of interest shown in Table I.

Gupta’s model [9], consisting of a lumped LC circuit whose parameter values are given by analytical functions of the physical quantities W , H , and ϵ_r , is taken as the “coarse” model and implemented in OSA90/hope.¹ Sonnet’s *em*² is used

¹OSA90/hope Version 4.0, formerly Optimization Systems Associates Inc., Dundas, Ont., Canada, now HP EEsof Division, Hewlett-Packard Company, Santa Rosa, CA.

²*em* Version 4.0b, Sonnet Software Inc., Liverpool, NY.

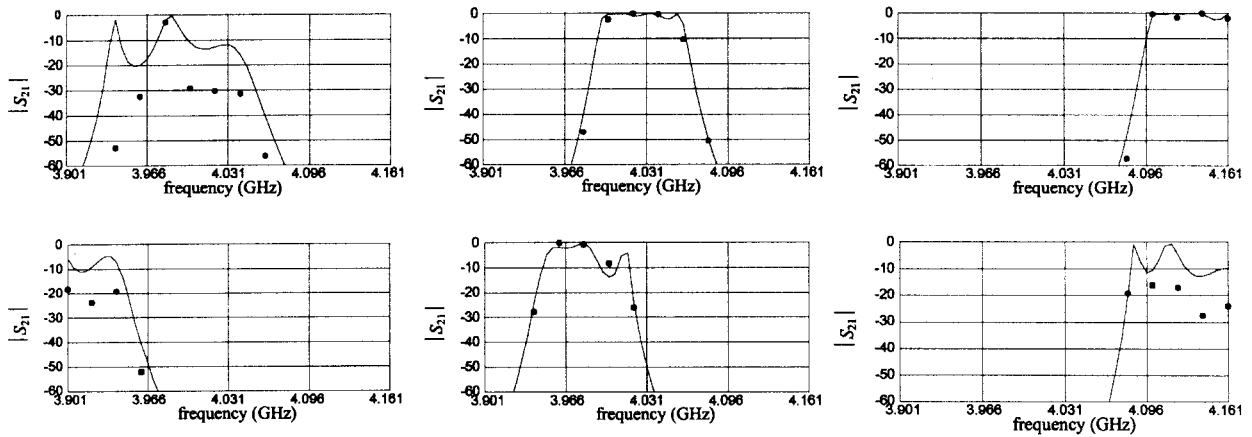

Fig. 21. Typical responses of the HTS filter using *em* (•) and FMN model (—) at the same three learning and three testing points as in Fig. 19.

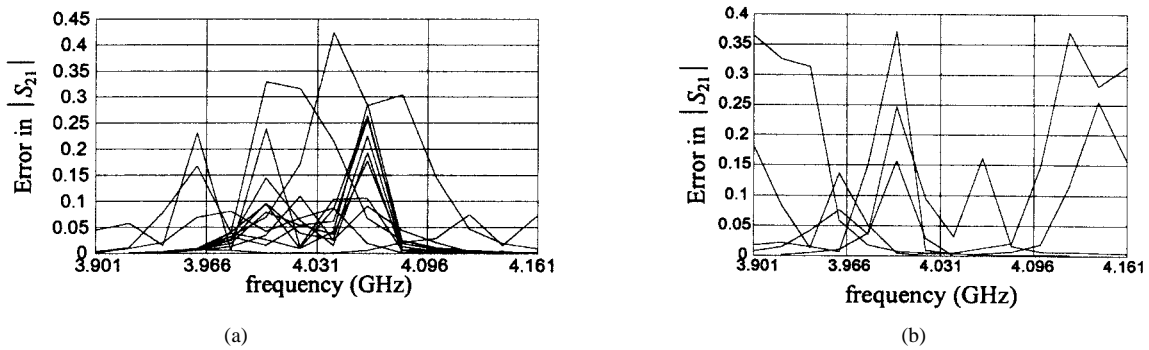

Fig. 22. FMN model error with respect to *em*. (a) In the learning set. (b) In the testing set.

as the fine model. To parameterize the structure, the Geometry Capture [10] technique available in Empipe³ is utilized.

The coarse and fine models are compared in Fig. 12 using 50 random test base points with uniform statistical distribution within the region of interest ($F_p = 21$, 1050 test samples). Gupta's model, in this region of physical parameters, yields acceptable results for frequencies less than 10 GHz.

With a star distribution for the learning base points ($n = 3, B_p = 7$), 147 learning samples ($l = 147$) are used for three SM-based neuromodels, and the corresponding ANN's were implemented and trained within OSA90/hope. Huber optimization was employed as the training algorithm, exploiting its robust characteristics for data fitting [11].

Fig. 13 shows the results for the SMN model implemented with a three-layer perceptron with three input neurons, six hidden neurons, and three output neurons (3LP:3-6-3). An FDSMN model is developed using a 3LP:4-7-3, and the improved results are shown in Fig. 14. In Fig. 15, the results for the FSMN model with a 3LP:4-8-4 are shown, which are even better (as expected). To implement the FSMN approach, an OSA90 child program is employed to simulate the coarse model with a different frequency variable using Datapipe. It is seen that the FSMN model yields excellent results for the whole frequency range of interest, overcoming the frequency limitations of the empirical model by a factor of four.

³Empipe Version 4.0, formerly Optimization Systems Associates Inc., Dundas, Ont., Canada, now HP EEs of Division, Hewlett-Packard Company, Santa Rosa, CA.

To compare these results with those from a classical neuromodeling approach, an ANN was developed using *NeuroModeler*.⁴ Training the ANN with the same 147 learning samples, the best results were obtained for a 3LP:4-15-4 trained with the conjugate gradient and quasi-Newton methods. Due to the small number of learning samples, this approach did not provide good generalization capabilities, as illustrated in Fig. 16. To produce similar results to those in Fig. 15 using the same ANN complexity, the learning samples have to increase from 147 to 315.

Fig. 17 summarizes the different neuromodeling approaches applied to this case study.

B. HTS Quarter-Wave Parallel Coupled-Line Microstrip Filter

Fig. 18 illustrates an HTS quarter-wave parallel coupled-line microstrip filter to be modeled in the region of interest shown in Table II. L_1 , L_2 , and L_3 are the lengths of the parallel coupled-line sections and S_1 , S_2 , and S_3 are the gaps between the sections. The width W is the same for all the sections as well as for the input and output microstrip lines of length L_0 . A lanthanum-aluminate substrate with thickness H and dielectric constant ϵ_r is used. The metallization is considered lossless. Two SM-based neuromodels are developed in the region of interest, taking as design parameters $\mathbf{x}_f = [L_1 \ L_2 \ L_3 \ S_1 \ S_2 \ S_3]^T$.

⁴*NeuroModeler* Version 1.0, Carleton Univ., Ottawa, Ont., Canada.

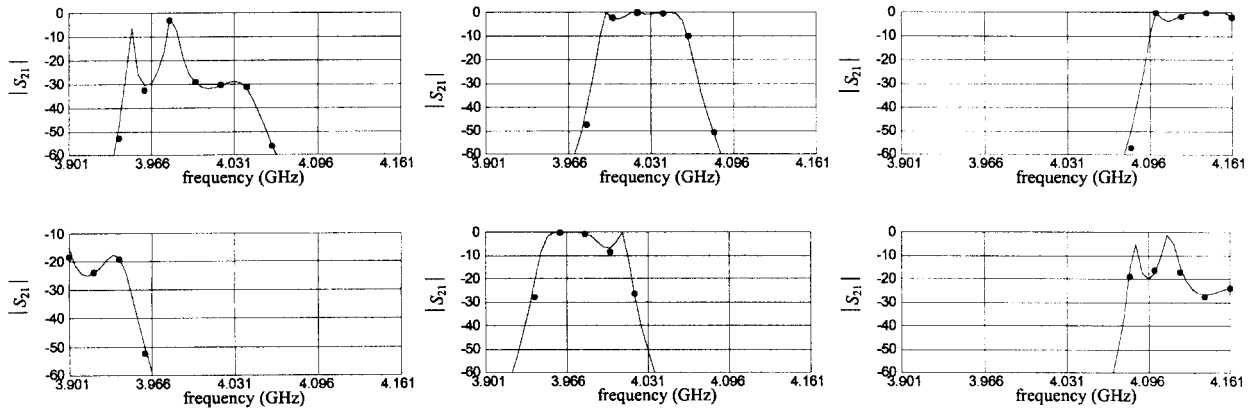

Fig. 23. Typical responses of the HTS filter using *em* (•) and FPSMN model (—) at the same three learning and three testing points as in Fig. 19.

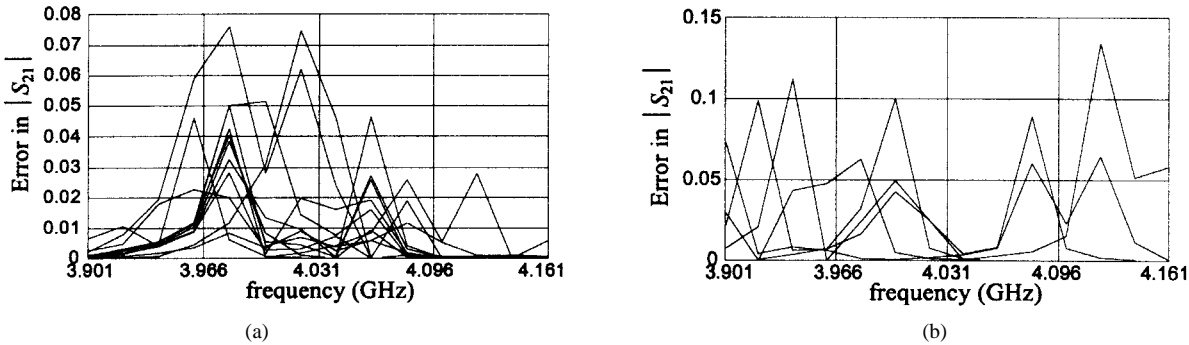

Fig. 24. FPSMN model error with respect to *em*. (a) In the learning set. (b) In the testing set.

It has been already shown [12] that the responses of this narrow bandwidth filter are very sensitive to dimensional changes. Sonnet’s *em* driven by Empipe was employed as the fine model, using a high-resolution grid with a 1 mil × 1 mil cell size.

Sections of OSA90/hope built-in linear elements microstrip line (MSL) and two-conductor symmetrical coupled microstrip lines (MSCL) connected by circuit theory over the same microstrip substrate definition (MSUB) are taken as the “coarse” model.

Typical responses of the coarse and fine models before any neuromodeling are shown in Fig. 19, using a frequency step of 0.02 GHz ($F_p = 14$). About 10 h of CPU simulation time was needed for a single-frequency sweep on an HP C200-RISC workstation. Following a multidimensional star distribution ($n = 6$), 13 learning base points are used ($l = 182$). To evaluate the generalization performance, seven testing base points not seen in the learning set are used.

The coarse and fine models before neuromodeling are compared in Fig. 20, at both the learning and testing sets, showing very large errors in the coarse model with respect to *em* due to a shifting in its frequency response, as seen in Fig. 19.

To explore the effects of simulating the coarse model at a mapped frequency, an FMN model (see Fig. 8) implemented with a 3LP:7-5-1 is developed using Huber optimization. The FMN approach yields good frequency alignment between both responses, as shown in Fig. 21. The corresponding training and generalization errors are shown in Fig. 22.

Excellent results are obtained for the FPSMN modeling approach (see Fig. 9), taking $\mathbf{x}_c^s = [L_{1c} S_{1c}]^T$ and $\mathbf{x}_f^s = [L_2 L_3 S_2 S_3]^T$ and using a 3LP:7-7-3 trained with Huber optimization. As illustrated in Fig. 23, an outstanding agreement between the fine model and FPSMN model is achieved. The learning and generalization performance is shown in Fig. 24.

As a final test, both the FPSMN model and fine model are simulated at three different base points using a very fine frequency sweep, with a frequency step of 0.005 GHz. Remarkable matching is obtained, as illustrated in Fig. 25.

VI. CONCLUSIONS

We present novel applications of SM technology to the neuromodeling of microwave circuits. Five powerful techniques to generate SM-based neuromodels are described and illustrated: SMN, FDSMN, FSMN, FMN, and FPSMN. These techniques exploit the vast set of empirical models already available, decrease the number of fine model evaluations needed for training, improve generalization ability, and reduce the complexity of the ANN topology with respect to the classical neuromodeling approach. Frequency-sensitive neuromapping is demonstrated to be a clever strategy to expand the usefulness of empirical models that were developed using quasi-static analysis. FMN is presented as an effective method to align frequency-shifted responses. By establishing a partial mapping for the physical parameters, a more efficient use of the implicit knowledge in the coarse model is achieved. As an original alternative to the classical backpropagation algorithm, Huber

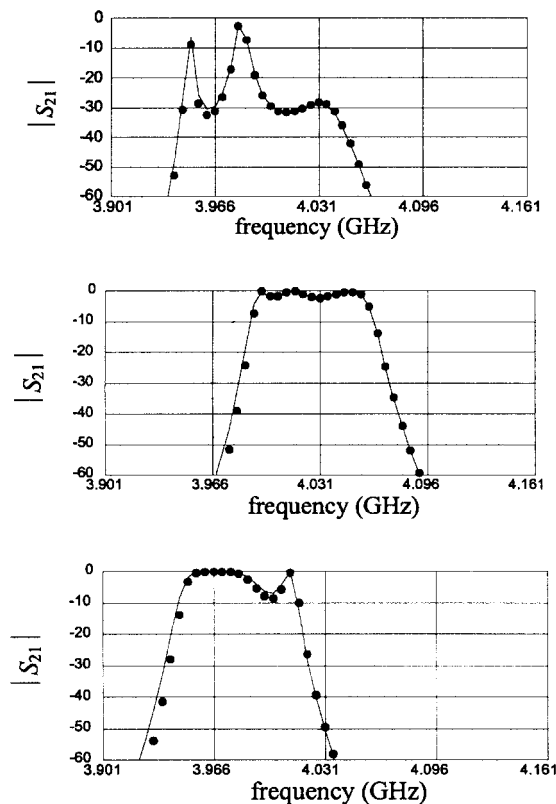

Fig. 25. Comparison between the HTS filter response using *em* (●) and FPSMN model (—) at some learning and testing points using a fine frequency sweep.

optimization is employed to efficiently train the neuromapping, exploiting its robust characteristics for data fitting.

ACKNOWLEDGMENT

The authors thank Dr. J. C. Rautio, Sonnet Software Inc., Liverpool, NY, for making *em* available.

REFERENCES

- [1] P. Burrascano and M. Mongiardo, "A review of artificial neural networks applications in microwave CAD," *Int. J. RF Microwave Computer-Aided Eng. (Special Issue Applicat. ANN to RF and Microwave Design)*, vol. 9, pp. 158–174, 1999.
- [2] J. W. Bandler, R. M. Biernacki, S. H. Chen, P. A. Grobelny, and R. H. Hemmers, "Space mapping technique for electromagnetic optimization," *IEEE Trans. Microwave Theory Tech.*, vol. 42, pp. 2536–2544, Dec. 1994.
- [3] H. White, A. R. Gallant, K. Hornik, M. Stinchcombe, and J. Wooldridge, *Artificial Neural Networks: Approximation and Learning Theory*. Oxford, U.K.: Blackwell, 1992.
- [4] A. H. Zaabab, Q. J. Zhang, and M. S. Nakhla, "A neural network modeling approach to circuit optimization and statistical design," *IEEE Trans. Microwave Theory Tech.*, vol. 43, pp. 1349–1358, June 1995.
- [5] P. Burrascano, M. Dionigi, C. Fancelli, and M. Mongiardo, "A neural network model for CAD and optimization of microwave filters," in *IEEE MTT-S Int. Microwave Symp. Dig.*, Baltimore, MD, 1998, pp. 13–16.
- [6] P. Watson and K. C. Gupta, "EM-ANN models for microstrip vias and interconnects in multilayer circuits," *IEEE Trans. Microwave Theory Tech.*, vol. 44, pp. 2495–2503, Dec. 1996.
- [7] F. Wang and Q. J. Zhang, "Knowledge-based neuromodels for microwave design," *IEEE Trans. Microwave Theory Tech.*, vol. 45, pp. 2333–2343, Dec. 1997.
- [8] R. M. Biernacki, J. W. Bandler, J. Song, and Q. J. Zhang, "Efficient quadratic approximation for statistical design," *IEEE Trans. Circuits Syst.*, vol. 36, pp. 1449–1454, Nov. 1989.

- [9] K. C. Gupta, R. Garg, and I. J. Bahl, *Microstrip Lines and Slotlines*. Norwood, MA: Artech House, 1979.
- [10] J. W. Bandler, R. M. Biernacki, and S. H. Chen, "Parameterization of arbitrary geometrical structures for automated electromagnetic optimization," in *IEEE MTT-S Int. Microwave Symp. Dig.*, San Francisco, CA, 1996, pp. 1059–1062.
- [11] J. W. Bandler, S. H. Chen, R. M. Biernacki, L. Gao, K. Madsen, and H. Yu, "Huber optimization of circuits: A robust approach," *IEEE Trans. Microwave Theory Tech.*, vol. 41, pp. 2279–2287, Dec. 1993.
- [12] J. W. Bandler, R. M. Biernacki, S. H. Chen, W. J. Getsinger, P. A. Grobelny, C. Moskowitz, and S. H. Talisa, "Electromagnetic design of high-temperature superconducting microwave filters," *Int. J. Microwave Millimeter-Wave Computer-Aided Eng.*, vol. 5, pp. 331–343, 1995.



John W. Bandler (S'66–M'66–SM'74–F'78) studied at the Imperial College of Science and Technology, London, U.K., from 1960 to 1966. He received the B.Sc. (Eng.), Ph.D., and D.Sc. (Eng.) degrees from the University of London, London, U.K., in 1963, 1967, and 1976, respectively.

In 1966, he joined Mullard Research Laboratories, Redhill, Surrey, U.K. From 1967 to 1969, he was a Post-Doctorate Fellow and Sessional Lecturer at the University of Manitoba, Winnipeg, Man., Canada. In 1969, he joined McMaster University, Hamilton, Ont., Canada, where he is currently a Professor of electrical and computer engineering. He has served as Chairman of the Department of Electrical Engineering and Dean of the Faculty of Engineering. He currently directs research in the Simulation Optimization Systems Research Laboratory. He is also a member of the Micronet Network of Centres of Excellence. He was President of Optimization Systems Associates Inc. (OSA), which he founded in 1983, until November 20, 1997, the date of acquisition of OSA by the Hewlett-Packard Company (HP), Santa Rosa, CA. OSA introduced the computer-aided engineering (CAE) systems RoMPE in 1988, HarPE in 1989, OSA90 and OSA90/hope in 1991, Empipe in 1992, Empipe3D, and EmpipeExpress in 1996. OSA created the product *empath* in 1996, which was marketed by Sonnet Software Inc., Liverpool, NY. He is also currently President of Bandler Corporation, Dundas, Ont., Canada, which he founded in 1997. He has published over 310 papers, and has contributed to *Modern Filter Theory and Design* (New York: Wiley-Interscience, 1973) and to *Analog Methods for Computer-Aided Analysis and Diagnosis* (New York: Marcel Dekker, 1988). Four of his papers have been reprinted in *Computer-Aided Filter Design* (New York: IEEE Press, 1973), one in each of *Microwave Integrated Circuits* (Norwood, MA: Artech House, 1975), *Low-Noise Microwave Transistors and Amplifiers* (New York: IEEE Press, 1981), *Microwave Integrated Circuits, 2nd ed.* (Norwood, MA: Artech House, 1985), *Statistical Design of Integrated Circuits* (New York: IEEE Press, 1987), and *Analog Fault Diagnosis* (New York: IEEE Press, 1987). He joined the Editorial Boards of the *International Journal of Numerical Modeling* (1987), *International Journal of Microwave and Millimeterwave Computer-Aided Engineering* (1989), and *Optimization and Engineering* (1998). He was guest editor for a special issue on "Optimization-oriented microwave CAD" of the *International Journal of Microwave and Millimeter-Wave Computer-Aided Engineering* (1997).

Dr. Bandler is a fellow of the Royal Society of Canada, a fellow of the Institution of Electrical Engineers (IEE), U.K., a member of the Association of Professional Engineers of the Province of Ontario (Canada), and a member of the Massachusetts Institute of Technology (MIT) Electromagnetics Academy. He was an associate editor of the IEEE TRANSACTIONS ON MICROWAVE THEORY AND TECHNIQUES (1969–1974), and has continued serving as a member of the Editorial Board. He was guest editor for a Special Issue on "Computer-oriented microwave practices" (1974), "Process-oriented Microwave CAD and Modeling" (1992), and "Automated circuit design using electromagnetic simulators" (1997) of the IEEE TRANSACTIONS ON MICROWAVE THEORY AND TECHNIQUES. He is currently co-chairman of the IEEE MTT-1 Technical Committee on Computer-Aided Design. He received the 1994 Automatic Radio Frequency Techniques Group (ARFTG) Automated Measurements Career Award.



Mostafa A. Ismail (S'98) was born in Cairo, Egypt, on May 21, 1968. He received the B.Sc. degree (with distinction) in electronics and communications engineering and the Masters Degree in engineering mathematics from Cairo University, Cairo, Egypt, in 1991 and 1995, respectively, and is currently working toward the Ph.D. degree at McMaster University, Hamilton, Ont., Canada.

In October 1991, he joined the Department of Engineering Mathematics and Physics, Faculty of Engineering, Cairo University. In September 1997, he joined the Department of Electrical and Computer Engineering, McMaster University. His research is carried out in the Simulation Optimization Systems Research Laboratory. He is interested in microwave device modeling, computer-aided design, and modeling of microwave circuits and neural networks.



José Ernesto Rayas-Sánchez (S'88–M'89–SM'95) was born in Guadalajara, Jalisco, Mexico, on December 27, 1961. He received the B.Sc. degree in electronics engineering from the Instituto Tecnológico y de Estudios Superiores de Occidente (ITESO), Guadalajara, Mexico, in June 1984, and the Masters degree in electrical engineering from the Instituto Tecnológico y de Estudios Superiores de Monterrey (ITESM), Monterrey, Mexico, in June 1989, and is currently working toward the Ph.D. degree in electrical engineering at McMaster University, Hamilton, Ont., Canada.

From 1989 to 1997 he was a Full-Time Professor in the Electrical and Computer Engineering Department, ITESO. His research is focused on the development of novel methods and techniques for computer-aided modeling, design and, optimization of analog wireless electronic circuits and devices exploiting SM and ANN's.

Mr. Rayas-Sánchez was the recipient of a 1997 Consejo Nacional de Ciencia y Tecnología (CONACYT) scholarship.

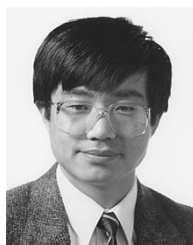

Qi-Jun Zhang (S'84–M'85–SM'95) received the B.Eng. degree from the East China Engineering Institute, Nanjing, China, in 1982, and the Ph.D. degree from McMaster University, Hamilton, Ont., Canada, in 1987, both in electrical engineering.

From 1982 to 1983, he was with the Institute of Systems Engineering, Tianjin University, Tianjin, China. From 1988 to 1990, he was a Research Engineer with Optimization Systems Associates Inc., Dundas, Ont., Canada, where he developed advanced software for microwave modeling, simulation, and optimization. In 1990, he joined the Department of Electronics, Carleton University, Ottawa, Ont., Canada, where he is currently a Professor. His research interests are neural-network and optimization techniques for high-speed and high-frequency circuit design. He co-edited *Modeling and Simulation of High-Speed VLSI Interconnects* (Norwell, MA: Kluwer, 1994). He was a guest editor of the Special Issue on Applications of Artificial Neural Networks to RF and Microwave Design for the *International Journal of RF and Microwave CAE* (New York: Wiley, 1999).

Dr. Zhang is a member of the Association of Professional Engineers of Ontario.