

# We are IntechOpen, the world's leading publisher of Open Access books Built by scientists, for scientists

5,900

Open access books available

145,000

International authors and editors

180M

Downloads

Our authors are among the

154

Countries delivered to

TOP 1%

most cited scientists

12.2%

Contributors from top 500 universities



WEB OF SCIENCE™

Selection of our books indexed in the Book Citation Index  
in Web of Science™ Core Collection (BKCI)

Interested in publishing with us?  
Contact [book.department@intechopen.com](mailto:book.department@intechopen.com)

Numbers displayed above are based on latest data collected.  
For more information visit [www.intechopen.com](http://www.intechopen.com)



---

# Nonlinear Adaptive Signal Processing Improves the Diagnostic Quality of Transabdominal Fetal Electrocardiography

---

Radek Martinek, Radana Kahankova, Hana Skukova,  
Jaromir Konecny, Petr Bilik, Jan Zidek and  
Homer Nazeran

Additional information is available at the end of the chapter

<http://dx.doi.org/10.5772/64068>

---

## Abstract

The abdominal fetal electrocardiogram (fECG) conveys valuable information that can aid clinicians with the diagnosis and monitoring of a potentially at risk fetus during pregnancy and in childbirth. This chapter primarily focuses on noninvasive (external and indirect) transabdominal fECG monitoring. Even though it is the preferred monitoring method, unlike its classical invasive (internal and direct) counterpart (transvaginal monitoring), it may be contaminated by a variety of undesirable signals that deteriorate its quality and reduce its value in reliable detection of hypoxic conditions in the fetus. A stronger maternal electrocardiogram (the mECG signal) along with technical and biological artifacts constitutes the main interfering signal components that diminish the diagnostic quality of the transabdominal fECG recordings. Currently, transabdominal fECG monitoring relies solely on the determination of the fetus' pulse or heart rate (FHR) by detecting RR intervals and does not take into account the morphology and duration of the fECG waves (P, QRS, T), intervals, and segments, which collectively convey very useful diagnostic information in adult cardiology. The main reason for the exclusion of these valuable pieces of information in the determination of the fetus' status from clinical practice is the fact that there are no sufficiently reliable and well-proven techniques for accurate extraction of fECG signals and robust derivation of these informative features. To address this shortcoming in fetal cardiology, we focus on adaptive signal processing methods and pay particular attention to nonlinear approaches that carry great promise in improving the quality of transabdominal fECG monitoring and consequently impacting fetal cardiology in clinical practice. Our investigation and experimental results by using clinical-quality synthetic data generated by our novel fECG signal generator suggest that adaptive neuro-fuzzy inference systems could produce a significant advancement in fetal monitoring during pregnancy and childbirth. The possibility of using a single device to

leverage two advanced methods of fetal monitoring, namely noninvasive cardiotocography (CTG) and ST segment analysis (STAN) simultaneously, to detect fetal hypoxic conditions is very promising.

**Keywords:** adaptive signal processing, adaptive neuro-fuzzy inference system, fetal electrocardiogram, transabdominal monitoring, noninvasive cardiotocography, non-invasive ST segment analysis (STAN)

## 1. Introduction

The fetal electrocardiogram (fECG) is a recoding of the electrical activity of the fetal heart and provides clinically significant information about the physiological state of a fetus during pregnancy and labor. Early detection of hypoxic states (hypoxemia, hypoxia, and asphyxia) achieved by fECG signal monitoring can ensure the fetus' well-being during these stages. For greater detail please see [1–3].

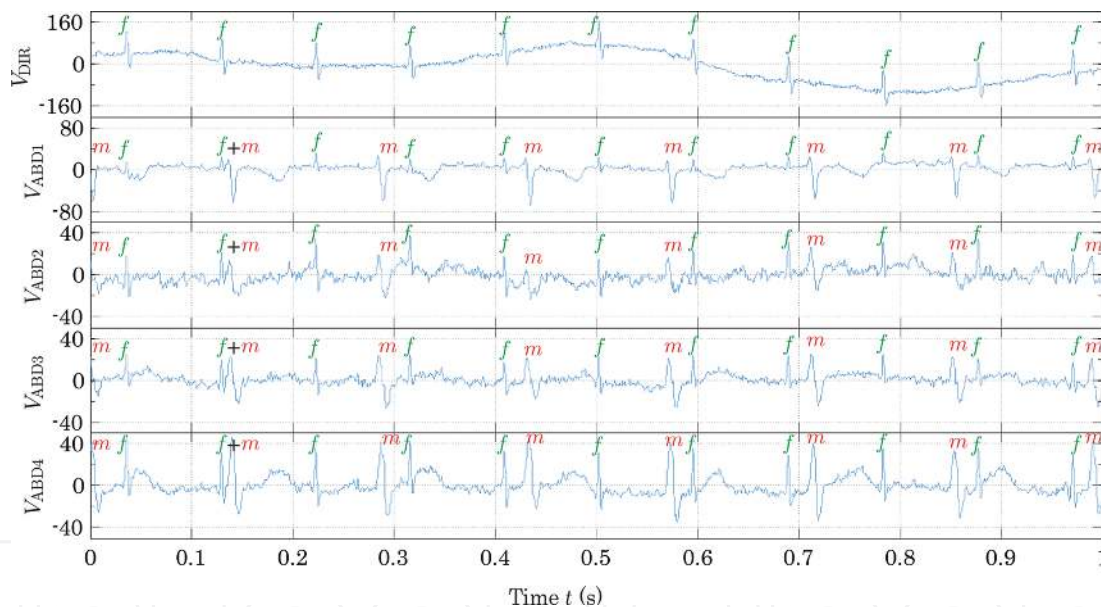
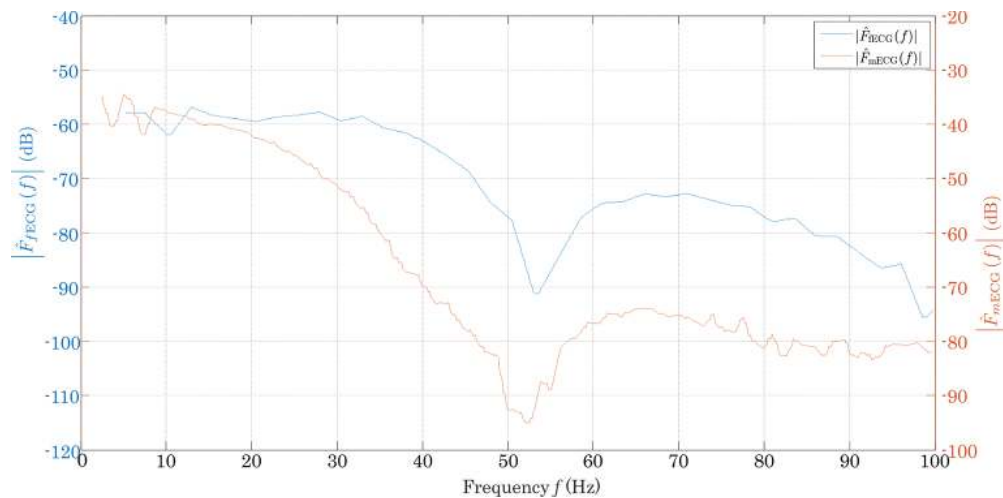

**Figure 1.** Real recordings of ECG signals by using the invasive and noninvasive techniques (f—fetal QRS, m—maternal QRS).

In clinical practice two methods are used to record fECG signals: invasive and noninvasive. The first one is direct and is performed transvaginally by using an Invasive Scalp Electrode (ISE). This approach is considered to be accurate as the fECG signals are recorded directly from the fetal's scalp without interference from the maternal heart (see **Figure 1**, the upper trace). However, it poses problems and risks to both the mother and the child (such as infections). In the noninvasive technique, multichannel skin bioelectrodes are placed on the mother's abdomen, and the simultaneous maternal (mECG) and fetal (fECG) signals, called the transabdominal or abdominal ECG (aECG), is acquired (See **Figure 1**, the lower 4 traces). This approach is convenient, noninvasive, and can be used during pregnancy and labor. However,

there is a significant amount of overlap between fECG and mECG signals in addition to other undesirable signals such as bioelectric potentials (maternal muscle activity-mEMG, fetal movement activity, potentials generated by respiration and gastric activity, as well as power line interference [4,5], that deteriorate the quality of the afECG signals. **Figure 1** shows examples of fECG signals acquired by the invasive ( $V_{DIR}$ ) and noninvasive ( $V_{ABD1}-V_{ABD4}$ ) approaches.

We observe that the strong mECG and the weak fECG signals overlap in both time-domain (**Figure 1**) and frequency-domain (**Figure 2**). Therefore, filtering the mECG component from the composite aECG signal to produce diagnostic quality fECG is a very challenging signal processing task. Currently only a fraction of the vast amount of diagnostic information in the aECG is available to be used in clinical practice. Therefore, maximizing information extraction from aECG (in addition to cardiotocography—CTG) signals for the timely and reliable detection of fetal hypoxia is of tremendous clinical interest and could significantly impact the advancements in obstetrics.



**Figure 2.** Abdominally recorded fECG and mECG in the frequency domain.

To address this signal processing challenge, many different approaches have been proposed to reliably detect fECG signals, but with varying degrees of success [4]. The holy grail of research in fetal electrocardiography is to fully recover the fECG signal and analyze its *morphology*, which produces valuable information on the fetus' status and health. The majority of recent techniques are mainly focused on the detection of the fetal heart rate (the intervals between R waves) with only a small portion being able to fully isolate the clinically useful ST interval and consequently perform accurate ST segment analysis (STAN) along with CTG. The only commercially available unit that has a built-in ability to perform STAN is Neovita Medical's STAN S31. For a detailed description of this device, please see Ref. [6]. **Figure 3** shows an example of a real-time STAN. Fetal heart rate (fHR) and T/QRS are continuously displayed on the screen. These parameters are important in diagnosing hypoxic states. An increase in the ST segment and T wave as quantified by the ratio of the T wave to the QRS complex amplitude (T/QRS) has been associated with the different forms of the physiological

responses expected in hypoxia (metabolic acidosis, myocardial glycogenolysis, etc.). For a more detailed explanation please see Reference [1].

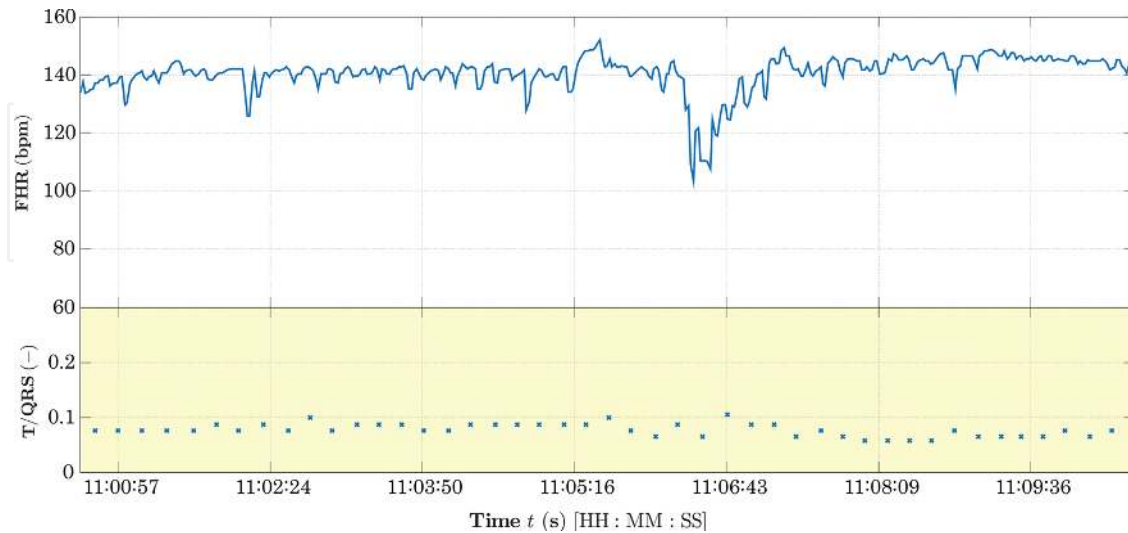

**Figure 3.** Real-time ST Analysis (Fetal Heart Rate, T wave and QRS complex ratio) using Matlab application.

A critical review of the current signal processing literature reveals that adaptive signal processing and soft computing methods are rapidly growing research areas and offer great promise to address some of the most challenging signal separation, pattern recognition, and classification problems in different areas of medicine including Obstetrics.

Driven by these advancements and promises, in the methods section we will first present a theoretical overview of the advanced signal processing (both nonadaptive and adaptive) techniques that have been applied to the extraction (separation) of fECG from aECG signals, and will choose a subset based upon their advantages. We will mainly focus on the Least Mean Squares (LMS) and Recursive Least Squares (RLS) algorithms [62]. Secondly, we will look at soft computing methods and describe how they have the ability to enhance the performance of adaptive signal processing algorithms in achieving better outcomes when processing biomedical signals. Then we will pay special attention to adaptive neuro-fuzzy inference systems (ANIFS) [60,63], which are considered to be the most significant in fetal electrocardiography research.

To provide a comparative analysis of the performance of our selected adaptive algorithms and their enhanced realizations using soft computing approaches, in the results section, we will report the outcomes of a number of experiments that we devised by using aECG (identical to clinical) signals generated by our novel LabVIEW-Based Multi-Channel Noninvasive Abdominal Maternal-Fetal Electrocardiogram Signal Generator [7,8]. This abdominal fECG signal generator allows us to realistically simulate all types of signal contaminations (both biological and nonbiological) affecting the quality of aECG signals.

Our experimental results were evaluated using both subjective and objective criteria. For the objective evaluation, we used the SNR values before and after processing, the RMSE value,



and the required processing time for the selected data samples. These performance metrics (parameters) are defined in separate subsections of the methods section.

In conclusion, our experimental results using synthetically-generated (identical to clinical) data produced by our novel system revealed that it was possible to effectively extract fECG signals and significantly refine their diagnostic quality to enable reliable ST segment and CTG signal analysis. Refined aECG monitoring systems with built-in STAN and CTG analysis capabilities will pave the way for the timely and reliable detection of fetal hypoxia during pregnancy and labor, which is of tremendous clinical interest. These enhanced fECG monitoring systems will significantly impact the future advancements in Obstetrics.

## 2. Methods

### 2.1. fECG signal elicitation or extraction

Interference elimination can be implemented using a single-or a multi-channel source signal. These signals are then processed by various methods, which are used for fECG signal extraction, as shown in **Figure 4**. These methods are divided into two categories: nonadaptive and adaptive, depending on the system’s inability or ability to accommodate unexpected changes.

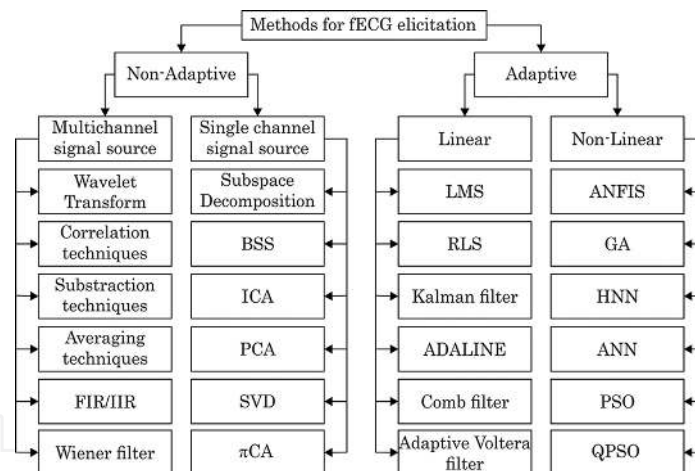

Figure 4. Summary of methods for fECG elicitation.

### 2.2. Nonadaptive methodologies

The Nonadaptive methodologies used for fECG signal extraction include Wavelet Transform-Based Techniques [9–11], Correlation Methods [12], Subtraction Methodologies [13], Single Value Decomposition (SVD) [14], Independent Component Analysis (ICA) and Blind Subspace Separation (BSS) [15–17], as well as Averaging Techniques [18].

The drawback of the nonadaptive techniques is that they are time-invariant in nature. Their time-invariance limitation has been overcome by the adaptive methods, which are more effective in reducing the overlapping noise (such as mECG) in time and frequency domains.

Nonadaptive methods are useful for data pre-processing or for noise elimination in case of classic ECGs [4].

### 2.3. Adaptive methodologies

Different variants of adaptive filters have been used for mECG signal cancellation and fECG signal extraction. These methods consist of training an adaptive or a matched filter for either removing the mECG signal using one or several maternal reference channels [19] or directly training the filter for extracting the fetal QRS complexes [20].

The existing adaptive filtering methods for maternal component elimination require a reference mECG channel that is morphologically similar to the contaminating waveform, or require several linearly independent channels to reconstruct any morphologic shape from the Ref. [21].

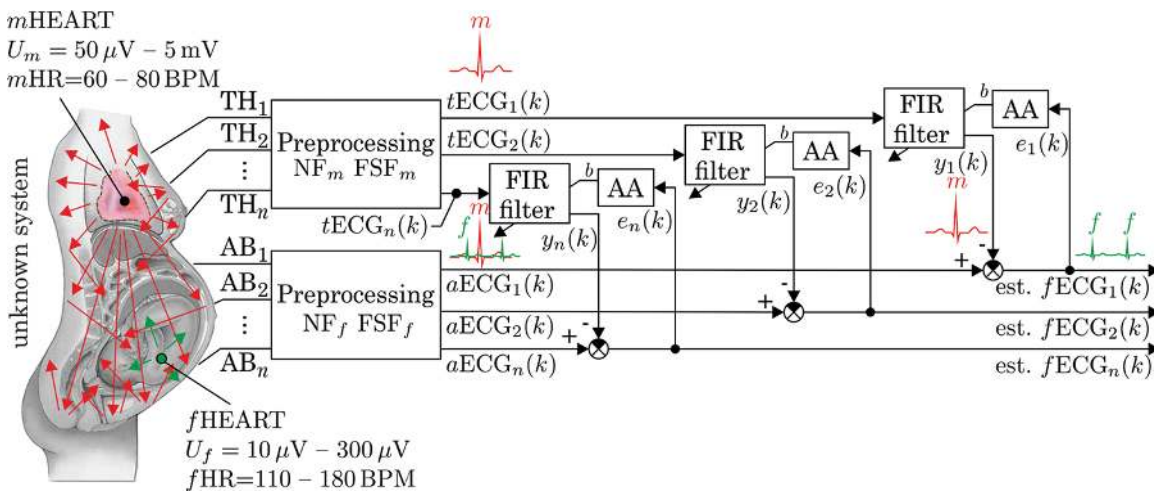

Figure 5. A theoretical multichannel adaptive noise (mECG and interferences) cancellation system.

Several approaches for mECG signal cancellation and fECG signal extraction have been used. The adaptive filters can be trained to extract the fetal QRS complexes directly or to estimate and remove the mECG component using reference maternal channels. The reference mECG signal can be recorded from the electrodes placed on the mother's thorax, or reconstructed from several abdominal channels that are linearly independent. The limitation of these approaches, which influences their performance, is that the morphology of the mECG signals highly depends on the electrode locations. Thus, the reconstruction of the complete ECG morphology from a linear combination of the reference electrodes is not always possible.

There are many different methodologies to extract fECG signals using adaptive filters based on one or several maternal reference channels (as shown in Figure 5). These methodologies include the LMS and RLS Algorithms, Artificial Intelligence (AI) Techniques, Fuzzy Inference Systems (FISs) [22,23], Genetic Algorithms (GA), and Bayesian Adaptive Filtering Frameworks which comprise Kalman Filters.

### 2.3.1. Linear adaptive methods

As mentioned before, adaptive methods can be linear or nonlinear. The linear methods for fECG signal extraction include algorithms such as LMS [24,25] RLS [24,26], Comb Filter [27], Adaptive Volterra Filter [28], Kalman Filter [29,30] or Adaptive Linear Networks (ADALINE) [31].

An adaptive filter is one that is characterized by the ability to self-adjust its coefficients according to an optimized training algorithm which is driven by a back-propagated error signal. Adaptive filters are used in noise cancellation applications to remove the noise adaptively from a signal and to improve the Signal to Noise Ratio (SNR) [4].

Simply said, it is a technique for the adaptive elimination of undesired signals (such as the maternal component) from the abdominal signal to obtain the fECG signal. The system can self-adjust to the existing circumstances and optimize its results.

### 2.3.2. An example: an adaptive noise cancellation system for fECG signal extraction

A theoretical multichannel adaptive noise cancellation system, shown in **Figure 5**, illustrates an adaptive elicitation technique of the fECG as an example. It consists of two kinds of input signals recorded from multiple leads: the abdominal ECG signals ( $AB_1$ – $AB_n$ ) and the thoracic ECG signals ( $TH_1$ – $TH_n$ ). Each abdominal signal consists of both maternal and fetal signals and serves as the primary input. The thoracic signal is considered to be completely maternal and is used as the reference input. Finite Impulse Response (FIR) Filter weights of the adaptive systems are updated by training algorithms based on the back-propagated error signal, which is the desired fECG signal ( $fECG_1$ – $fECG_n$ ). The maternal component is considered as noise to be eliminated. Each of the adaptive systems produces a signal, which is an approximation of the noise. This signal is subtracted from the abdominal ECG (aECG) signal so that the error signal that is back-propagated to the training algorithm is the fetal ECG signal with some noise.

Linear methods have limited performance in processing nonlinear or degenerate mixtures of signal and noise. In fact, fECG signals are not always linearly separable from undesirable signals contaminating them [32]. That is also a reason why linear algorithms yield better results when tested with synthetic data compared to those tested with real data. As the underlying physiological processes in the human body exhibit nonlinear behavior it seems more reasonable to use nonlinear methods for the construction of accurate and functional adaptive filters [22,32] to achieve better outcomes.

This chapter primarily focuses on the LMS- and RLS-based FIR Adaptive Filtering Methods. In the sections below we present mathematical descriptions for the most important methods such as LMS, Normalized LMS (NLMS), RLS, and Fast Transversal Filter (FTF).

## 2.4. Theoretical background

The Least Mean Squares (LMS) Algorithms are classified as adaptive filters that can change their coefficients to become a system that produces the least mean squares of the error (the



difference between the desired and the actual) signal. It is a stochastic gradient descent method in that the filter is only adapted based on the error at the current time [33].

#### 2.4.1. Standard LMS

The Standard LMS Algorithm performs the following operations to update the coefficients of an adaptive filter:

- Calculates the corresponding output signal from the adaptive filter by using the following equation:

$$y(k) = \sum_{i=0}^{N-1} w(k)x(k-i) = \mathbf{w}^T(k)\mathbf{x}(k). \quad (1)$$

- Calculates the error signal  $e(k)$  that denotes the difference between additional input signal  $d(k)$  and  $y(k)$  by using the following equation:

$$e(k) = d(k) - y(k). \quad (2)$$

- Updates the filter coefficients by using the following equation:

$$\mathbf{w}(k+1) = \mathbf{w}(k) + 2\mu e(k)\mathbf{x}(k), \quad (3)$$

where  $\mu$  is the step size of the adaptive filter, is the filter coefficients vector, and  $\mathbf{w}(k)$  is the input signal to a linear filter at time. Step size is a crucial parameter that can improve the convergence speed of the adaptive filter. It determines both how quickly and how closely the adaptive filter converges to the filter solution [34].

#### 2.4.2. Normalized LMS (NLMS) algorithm

The NLMS Algorithm is a modified form of the standard LMS Algorithm. The NLMS Algorithm updates the coefficients of an adaptive filter by using the following equation:

$$\mathbf{w}(k+1) = \mathbf{w}(k) + \mu e(k) \frac{\mathbf{x}(k)}{\|\mathbf{x}(k)\|^2}. \quad (4)$$

It is obvious that the NLMS Algorithm is almost identical to the Standard LMS Algorithm except that the NLMS Algorithm has a time-varying step size  $\mu(k)$ , [34].

#### 2.4.3. The recursive least square (RLS) algorithm

Unlike the LMS Algorithm, which reduces the mean square error, the principle of the RLS Algorithm is that it recursively finds the coefficients that minimize a weighted linear least

squares cost function relating to the input signals. In the case of the RLS Algorithm, the input signals are considered deterministic, while for the LMS Algorithm, they are considered stochastic. Compared to most of its competitors, the RLS Algorithm exhibits extremely fast convergence. However, this benefit comes at the cost of high computational complexity.

The standard RLS Algorithm performs the following operations to update the coefficients of an adaptive filter:

- Calculates the output signal of the adaptive filter:

$$y(k) = \mathbf{w}^T(k-1)\mathbf{x}(k). \quad (5)$$

- Calculates estimation error  $e(k)$  by using the following equation:

$$e(k) = d(k) - y(k). \quad (6)$$

- Updates the filter coefficients by using the following equation:

$$\mathbf{w}(k+1) = \mathbf{w}^T(k) + e(k)\mathbf{K}(k), \quad (7)$$

where  $\mathbf{w}(k)$  is the filter coefficients vector and  $\mathbf{K}(k)$  is the gain vector and is defined by the following equation:

$$\mathbf{K}(k) = \frac{P(k)\mathbf{u}(k)}{\lambda + \mathbf{u}^T(k)P(k)\mathbf{u}(k)}. \quad (8)$$

$P(k)$  is the inverse correlation matrix of the input signal.  $P(k)$  has the following initial value:

$$P(k) = \begin{bmatrix} \delta^{-1} & 0 & \dots & 0 \\ 0 & \delta^{-1} & \dots & 0 \\ \dots & \dots & \dots & \dots \\ 0 & 0 & \dots & \delta^{-1} \end{bmatrix}, \quad (9)$$

where  $\delta$  is the regularization factor. The standard RLS Algorithm uses the following equation to update this inverse correlation matrix.

$$P(k+1) = \lambda^{-1}P(k) - \lambda^{n-1}\mathbf{K}(k)\mathbf{u}^T(k)P(k). \quad (10)$$

- Repeats all the steps for the next iteration ( $k+1$ ).

The selection of the forgetting factor  $\lambda$  depends on the number of the samples  $k$  as follows:

$$k = \frac{\lambda}{1 - \lambda}. \quad (11)$$

If the analyzed signal is stationary,  $\lambda$  should be chosen as unity. Otherwise,  $\lambda$  should be smaller than the unity to track the nonstationary portion of the signals. The performance index takes into account the most recent errors as calculated by the most recent  $k^{\text{th}}$  iteration [35].

#### 2.4.4. Fast transversal filter (FTF)

The complexity of the classical RLS Algorithm (related to the speed of convergence) was the main reason for the inclusion of the FTF (Fast Transversal Filter) Algorithm. A detailed description of the algorithm is very extensive, complicated, and beyond the scope of this chapter. Its detailed formula derivation can be found in Ref. [36].

## 2.5. Soft computing methods

Biological systems including the human body and most of the real-world physical systems are highly involved nonlinear dynamical systems with a large degree of variability, imprecision, and uncertainty. As such, it is impossible for humans to find tractable solutions to problems associated with these systems without using powerful computing technologies. This is mainly attributable to the extensive amount of required data and processing time. In general, a nonlinear system is capable of generating quantitative or qualitative information. Quantitative information is represented by accurate numerical values, which are acquired by conventional modeling and mathematics. These conventional methods of data acquisition are rigorous and their results have to be precise, certain or categorically true or false. Precision and certainty of calculations are attainable at a higher computational cost. On the contrary, qualitative information contains knowledge or experience that can be expressed in natural language (e.g., big, medium, small). Qualitative information is processed by “soft” approaches called soft computing or artificial intelligence. Soft computing is a collection of methodologies that are able to tolerate imprecision and uncertainty and exploit these attributes to achieve robust and low-cost solutions. These methods aim to imitate the way the human brain processes information.

It is very difficult to describe real-world systems by classical mathematics, and it has been established that processing purely quantitative information is not efficient and represents a huge computational burden. New research has shown that nonlinear systems are substantially better modeled by artificial intelligence. These facts have led to the development of new intelligent soft computing methods. In current practice, these methods find various applications in software engineering, signal processing, and optimization. Soft computing methods comprised of fuzzy logic, artificial neural networks, evolutionary algorithms, and hybrid algorithms, are distinguishable from other computational techniques by exhibiting a tolerance for imprecision and uncertainty. Another advantage of soft computing methods is in their ability to adapt and learn, which makes them very suitable for adaptive filtering applications

where their training algorithms allow them to adapt the system's parameters to existing conditions.

The application of soft computing methods in the processing of fECG signals is still in its infancy. However, the rapid development of computing processor technology and computational intelligent algorithms in the last three decades has provided new impetus for advancing fetal cardiology. To date, a number of soft computing-based approaches have been introduced to tackle fECG signal extraction. These include Adaptive Linear Neural Network (ADALINE), [8,37], Genetic Algorithms (GA), [20,21], ANFIS [32,34,38], and ANFIS trained with Particle Swarm Optimization (PSO) [1,2]. In [37] authors used an ADALINE trained with the LMS Algorithm for suppression of mECG signals. The ADALINE was trained to eliminate the maternal component from the aECG. This was carried out by subtraction of the mECG from the aECG. The resultant error signal was equal to the fECG. Neural networks were also used in [8], in combination with FIR filters. Taking advantage of the combined capabilities of soft computing methods and digital FIR or IIR (Infinite Impulse Response) filters is now common. For example, in [20] authors proposed to apply low pass FIR filtering optimized by a Genetic Algorithm (GA). The GA-modified coefficients of the FIR filter produced the best possible results for fECG signal extraction. A comparison of the results yielded by this method with those produced by methods using the LMS and NLMS Algorithms showed that the quality of filtering using the GA with eight bits and ten iterations was equal to those of the other methods. Better results were achieved by using IIR instead of FIR filters [21]. An ANFIS tuned by PSO was considered to be an efficient tool for the extraction of not only the QRS complexes, but also all the components of the fECG signal. This level of performance has not been achieved by leveraging any other two leading methods to date. With this overview in mind, in the section below we describe the extraction of fECG signals by using ANFIS.

### *2.5.1. ANFIS theoretical background*

An Adaptive Neuro-fuzzy System (ANFIS) is a hybrid adaptive network based on a Sugeno-type fuzzy inference system (FIS) implemented into a feed-forward artificial neural network framework [39–44]. It uses a neuro-adaptive learning algorithm to determine the relationship between the input and output data sets. This learning algorithm can be hybrid or use back propagation. The advantage of an ANFIS lies in its ability to combine the “cleverness” of the Artificial Neural Networks (ANNs) and Fuzzy Inference Systems (FISs) in learning nonlinearities, which complement each other. A FIS incorporates human knowledge into the system in contrast to an ANN, which is capable of optimizing the ANFIS' parameters in implementing the learning process. To ensure correct and smooth running of the ANFIS, a number of fundamental considerations has to be made:

- The ANFIS should be single output.
- The FIS has to be the Sugeno model of zero or first order.
- The number of rules should correspond to the number of membership functions.
- The output membership function should be constant or linear.

### 2.5.2. ANFIS architecture

The original Jang's ANFIS architecture consists of five feed-forward interconnected layers, namely: a fuzzy layer, a product layer, a normalized layer, a de-fuzzification layer, and a total output layer [45]. In each layer several nodes are included and described by the node function. The nodes in these layers have an adaptive or a fixed nature and the difference between them is shown graphically in **Figure 6**, in which circles indicate the fixed nodes whereas squares represent the adaptive ones. The elementary ANFIS architecture has two initial inputs and one total single-value output. The rule base of the Sugeno FIS model is constituted by two IF-THEN rules in the following form [45]:

$$\text{IF}(x \text{ is } A_1) \text{ and } (y \text{ is } B_1) \text{ THEN } (f_1 = p_1x + q_1y + r_1). \quad (12)$$

$$\text{IF}(x \text{ is } A_2) \text{ and } (y \text{ is } B_2) \text{ THEN } (f_2 = p_2x + q_2y + r_2). \quad (13)$$

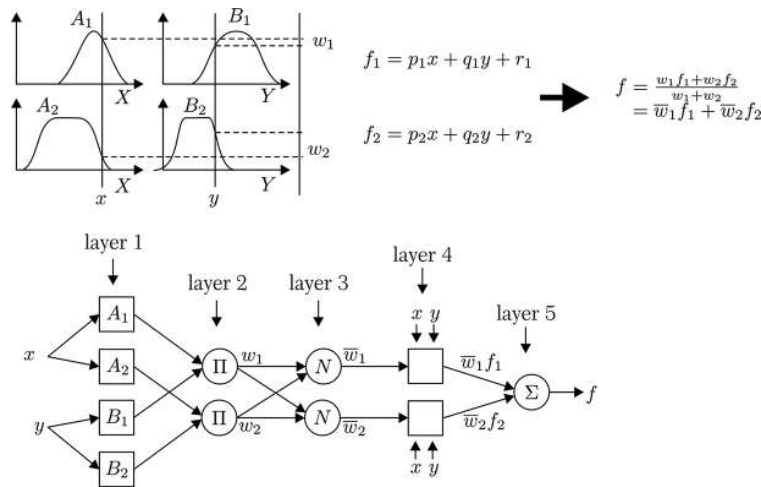

**Figure 6.** Fundamental scheme of ANFIS architecture.

where  $x$  and  $y$  are initial inputs;  $A_i$  and  $B_i$  are the nonlinear fuzzy sets also called a remise section;  $f_i$  is the output of the system; and  $p_i$ ,  $q_i$ , and  $r_i$  are linear design parameters, which are determined during the training process.

**Layer 1:** The first layer of this architecture is an adaptive layer used for fuzzification of input variables. Each node represents the input value of a linguistic variable. The node function associated with the output of each node is

$$O_{1,i} = \mu_{A_i}(x); \text{ for } i = 1, 2, \dots, \quad (14)$$

$$O_{1,i} = \mu_{B_{i-2}}(y); \text{ for } i = 3, 4, \dots, \quad (15)$$



where  $x$  (or  $y$ ) are inputs of the node  $i$ ,  $A_i$  (or  $B_{i-1}$ ) are linguistic labels and  $\mu_{A_i}(x)$ , respectively;  $\mu_{B_{i-2}}(y)$  can accept any fuzzy membership function. In conclusion,  $0_{1,i}$  is an expression of the membership function, in other words a membership grade, which indicates how much given  $x$  (or  $y$ ) satisfies quantifier  $A_i$  (or  $B_i$ ). The membership function can acquire several shapes including bell-shaped, triangular, and trapezoidal or Gaussian. For illustration we will use a bell-shaped Membership Function (MF) (Eq. 16).

$$\mu_{A_i}(x) = \frac{1}{1 + \left| \frac{(x - c_i)}{a_i} \right|^{2b_i}} \cdot \mu_{A_i}(x) = \frac{1}{1 + \left| \frac{(x - c_i)}{a_i} \right|^{2b_i}} \quad (16)$$

Parameters  $a_i$ ,  $b_i$  and  $c_i$  in Eq. (16) change the shape of the MF degree. Its value ranges from 0 to 1, where 0 is equal to the minimum value and 1 is equal to the maximum value.

**Layer 2:** The nodes in the second layer multiply the output signals from the previous layer. The output of this layer denotes  $O_{2,i}$  and is described as:

$$O_{2,i} = w_i = \mu_{A_i}(x)\mu_{B_i}(y); \text{ for } i = 1, 2. \quad (17)$$

**Layer 3:** The normalized layer labeled N contains a function to calculate the normalized firing strength. The output is labeled  $O_{3,i}$ .

$$O_{3,i} = \bar{w}_i = \frac{w_i}{w_1 + w_2}; \text{ for } i = 1, 2. \quad (18)$$

**Layer 4:** All nodes in this layer are adaptive. The node function has the form given below:

$$O_{4,i} = \bar{w}_i f_i = \bar{w}_i (p_i x + q_i y + r_i), \text{ for } i = 1, 2, \quad (19)$$

where output  $O_{4,i}$  defines a de-fuzzified (crisp) relationship between the input and output of this layer, is a firing strength desired in the normalized layer  $p_i$ ,  $q_i$  and  $r_i$  are linear adaptive parameters also called consequent parameters.

**Layer 5:** The last and fixed layer calculates the total output of the system.

$$O_{5,i} = \sum_i \bar{w}_i f_i = \frac{\sum_i \bar{w}_i f_i}{\sum_i \bar{w}_i}. \quad (20)$$

The output  $O_{5,i}$  is derived from the summation of incoming signals from Layer 4.

### 2.5.3. Hybrid learning algorithm

The hybrid learning algorithm in the ANFIS tunes the parameters of the Sugeno type FIS. It is a combination of the LMS and the Back-propagation Gradient Descent Algorithm (BPG). Each part of the hybrid algorithm is focused on a different part of the rule base in the ANFIS architecture. The premise (antecedent) parameters are adjusted by the BPG Algorithm and the consequent parameters are tuned by the LMS Algorithm. With respect to this distribution, the hybrid learning algorithm is divided into two passes, which are regularly repeated with every epoch. These passes are called “forward” and “backward” passes. **Figure 7** depicts the scheme of the hybrid learning algorithm. This hybrid algorithm converges much faster than the original pure back-propagation algorithm, as the latter reduces the search space dimensions [46,47].

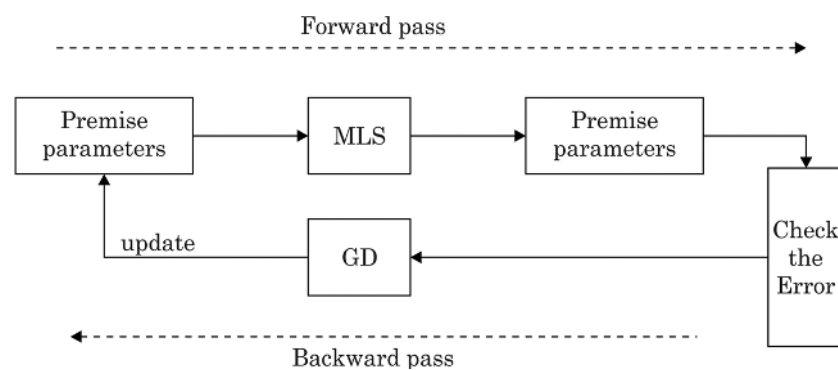

**Figure 7.** Block diagram for the hybrid-learning algorithm.

## 2.6. Definition of the parameters

The measurement of the quality of the fECG extraction procedures is based on the absence of noise and the degree of similarity between the recovered fECG signals and the ideal fECG signals, where the main parameters can be helpful to control the effectiveness of the fECG extraction and Signal to noise ratio (SNR).

### 2.6.1. Signal to noise ratio (SNR)

The relation between signal and noise is described by the SNR. To evaluate the filtering quality by the SNR, it is essential to calculate this ratio before and after filtering. The SNR before filtering is labeled  $SNR_{IN}$  and the SNR after filtering is labeled  $SNR_{OUT}$ . Based on  $SNR_{IN}$  and  $SNR_{OUT}$ , it is possible to track the improvement of the SNR after filtering. Their expressions are as follows:

$$SNR_{IN} = 10 \cdot \log_{10} \log_{10} \left( \frac{\sum_{i=1}^{N-1} [\text{sig}_{org}(i)]^2}{\sum_{i=1}^{N-1} [\text{sig}_{noise}(i) - \text{sig}_{org}(i)]^2} \right), \quad (21)$$

where  $\text{sig}_{\text{org}}$  is the desired signal equal to an ideal fECG and  $\text{sig}_{\text{noise}}$  is a disturbing noise. This signal corresponds to a simulated mECG after passing through the unknown environment of the human body. Please clarify this sentence. Since the disturbance noise is a sum of the ideal fECG and mECG after they pass through the human body, it is necessary to subtract these two signals from each other in the denominator,  $\text{SNR}_{\text{OUT}}$  defines:

$$\text{SNR}_{\text{OUT}} = 10 \cdot \log_{10} \left( \frac{\sum_{i=1}^{N-1} [\text{sig}_{\text{org}}(i)]^2}{\sum_{i=1}^{N-1} [\text{sig}_{\text{rec}}(i) - \text{sig}_{\text{org}}(i)]^2} \right), \quad (22)$$

where  $\text{sig}_{\text{org}}$  denotes the original signal (ideal fECG) and  $\text{sig}_{\text{rec}}(i)$  the signal recovered by the algorithm.

It is possible to evaluate the effectiveness of the proposed adaptive method by finding the difference between  $\text{SNR}_{\text{IN}}$  and  $\text{SNR}_{\text{OUT}}$ .

The SNR quantifies the relation between the fetal ECG signal and the rest of the undesired components (mECG). In the general fECG inverse problem, this is not an operative definition of the SNR, since it requires knowing the contribution of the fetal ECG signal and the noise. Since our signals are synthetic, this information is available.

### 2.6.2. Mean square error (MSE) and root mean square error (RMSE)

The primary statistical measure used is a mean or a squared prediction error function. This evolved into widespread use of the mean squared prediction error as a performance measure, often shortened to simply the mean square error (MSE). It is a useful tool used for an evaluation of prediction, which reflects the degree of inaccuracy between an estimated and an original output described by:

$$\text{MSE} = \frac{1}{n} \sum_{i=1}^n (\text{sig}_{\text{rec}}(i) - \text{sig}_{\text{org}}(i))^2, \quad (23)$$

where  $\text{sig}_{\text{org}}$  denotes the original signal (ideal fECG) and  $\text{sig}_{\text{rec}}$  the signal recovered by the algorithm.

MSE is often replaced by RMSE defined by:

$$\text{RMSE} = \frac{1}{n} \sqrt{\sum_{i=1}^n (\text{sig}_{\text{rec}}(i) - \text{sig}_{\text{org}}(i))^2}. \quad (24)$$

where  $\text{sig}_{\text{org}}$  denotes the original signal (ideal fECG) and  $\text{sig}_{\text{rec}}$  the signal recovered by the algorithm.

RMSE is a measure of the differences between values predicted by a model or an estimator and the values observed. The closer this value is to zero the more accurate is the system.

## 2.7. Generation of test data form experiments

To objectively assess the results of fECG signal extraction approaches by using the quality metrics defined above (SNR, RMSE, and others), knowledge of the reference signals (mECG and ideal fECG) is essential. That is not possible in case of the clinical (real) data (as the reference fECG signal is missing). On the other hand, most commonly used synthetic data are often too idealized and do not include the influence of the nonlinear environment of the human body. That is the reason why most fECG signal extraction methods, which are considered successful when tested with idealized synthetic data do not produce useful results when tested with clinical (real) data.

Acknowledging the limitations associated with idealized synthetic data used in testing fECG signal processing algorithms, we took advantage of our novel fECG signal generator [7,8] to generate clinically realistic data [42] for our experiments. Our fECG signal generator is unique in many respects. It is designed to simulate the fetal heart activity while special attention is given to the fetal heart development in relation to the fetus' anatomy, physiology, and pathology. The noninvasive signal generator enables many parameters to be set, including Fetal Heart Rate (fHR), Maternal Heart Rate (mHR), Gestational Age, fECG interferences (biological and technical artifacts), as well as other fECG signal characteristics. Furthermore, based on the change in the fHR and in the T wave-to-QRS complex ratio (T/QRS), the generator enables manifestations of hypoxic states (hypoxemia, hypoxia, and asphyxia) to be monitored while complying with clinical recommendations for classifications in cardiocography (CTG) and fECG ST segment analysis (STAN).

As described in detail elsewhere [7,8], the generator can produce realistic synthetic signals (identical to those acquired in clinical practice) with pre-defined properties for as many input as desired ( $n$ ), see **Figure 5**. Such signals are well suited to the testing of existing and new methods of fECG processing [22,23,42].

The experiments were realized with six inputs, i.e., four channel combinations ( $TE_2 \leftrightarrow BA_1$ ;  $TE_2 \leftrightarrow BA_2$ ;  $TE_2 \leftrightarrow BA_3$ ;  $TE_1 \leftrightarrow BA_4$ ), which were processed collaterally by four independent adaptive systems.

For all the analyzed methods, the same starting parameters were selected according to clinical recommendations for CTG and STAN evaluations [42] as follows:

- record duration  $t = 03:00$  (mm:ss), sample rate  $f_s = 1$  kHz, quantization step 0.1 mV,
- ideal mECG from thoracic electrodes  $TH_1$  and  $TH_2$  with variable MHR in the 65–85 bpm range,
- ideal fECG from abdominal electrodes  $AB_1$ ,  $AB_2$ ,  $AB_3$  and  $AB_4$  with the FHR in the 110–150 bpm range and the T/QRS complex in the 0.05–0.15 mV range,
- unwanted interference created in the human body modeled by empirical nonlinear transformation,

- SNR in for individual lead combinations and  $TH_1-AB_1 = -16.00$  dB;  $TH_2-AB_3 = -27.70$  dB;  $TH_1-AB_2 = -33.01$  dB;  $TH_2-AB_4 = -23.35$  dB,
- gestational age of fetus = 40 weeks (this parameter influences the length of each element of the fECG),
- for all of the adaptive algorithms used in the experiments the filter length was  $N = 32$ .

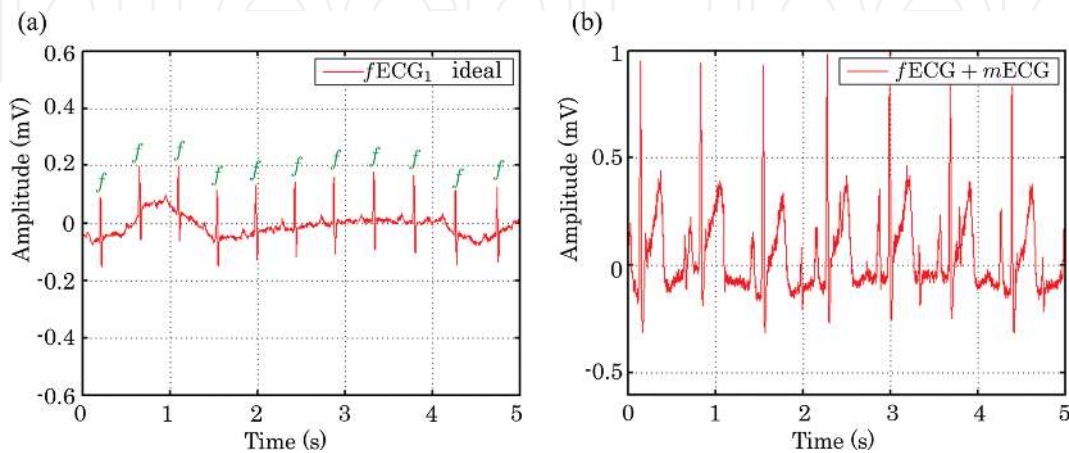

Figure 8. (a) Ideal fECG signal modelled by generator, (b) noisy fECG recordings modelled by generator.

To implement the required computational complexity, all experiments were performed by using a Personal Computer (PC) with a 3 GHz quad-core processor and 4 GB of RAM, please see Ref. [6]. **Figure 8a** shows the waveforms of the ideal and (**Figure 8b**) noisy fECG signals for the channel combination  $TE_1 \leftrightarrow BA_1$ , which were generated using the software-controlled generator.

### 3. Results and discussions

#### 3.1. Experimental results: testing linear adaptive algorithms

The test signals generated by our generator were first processed by the LMS, NLMS, RLS and FTF Algorithms. The ideal combination of the selected settings for these functions was based on the input and output Signal to Noise Ratios (SNRs) as well as Root Mean Square Error (RMSE).

**Figures 9** and **10** show the outputs of the adaptive systems for each one of the algorithms tested for the signals recorded by channels  $TE_1 \leftrightarrow AE_1$ . **Figure 9a** shows results of filtering aECG signals using the LMS algorithm and **Figure 9b** using NLMS algorithm. The LMS algorithm provides better results than NLMS algorithm; however, NLMS algorithm is more computational (processing time) expensive (see **Table 1**).



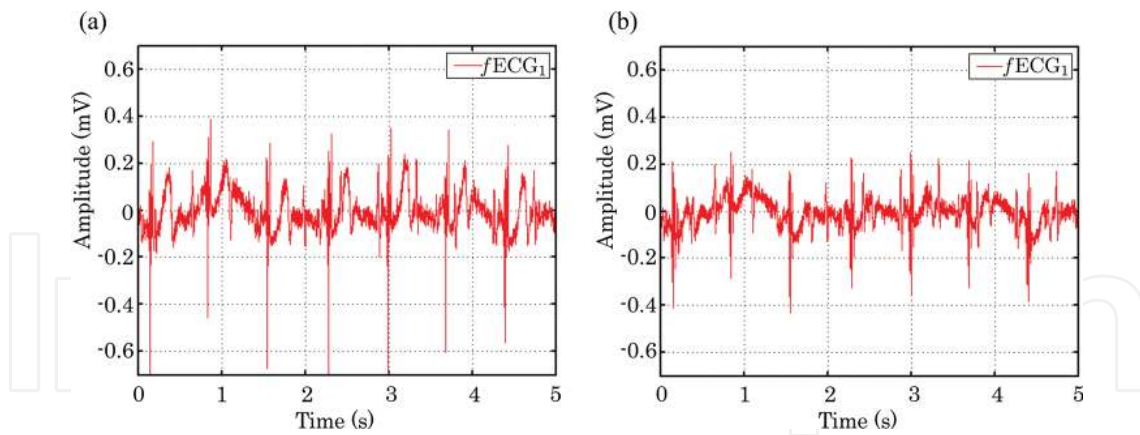

**Figure 9.** Output waveforms—results of filtering aECG signals (a) using the LMS and (b) using NLMS algorithms.

Name of adaptive filter used		Electrode combination	SNR <sub>in</sub> (dB)	SNR <sub>out</sub> (dB)	SNR <sub>imp</sub> (dB)	RMSE (-)	Processing time (min:s)
LMS-based filters	LMS	TE <sub>1</sub> ↔ AE <sub>1</sub>	-16.0036	-11.1935	4.8101	0.1388	00:57
		TE <sub>2</sub> ↔ AE <sub>2</sub>	-33.0132	-32.1204	0.8928	0.4273	
		TE <sub>2</sub> ↔ AE <sub>3</sub>	-27.7029	-21.1847	6.5182	0.1997	
		TE <sub>1</sub> ↔ AE <sub>4</sub>	-23.3521	-22.2700	1.0821	0.3125	
	NLMS	TE <sub>1</sub> ↔ AE <sub>1</sub>	-16.0036	-9.3647	6.6389	0.0996	01:15
		TE <sub>2</sub> ↔ AE <sub>2</sub>	-33.0132	-28.0695	4.9437	0.2283	
		TE <sub>2</sub> ↔ AE <sub>3</sub>	-27.7029	-20.3672	7.3357	0.1823	
		TE <sub>1</sub> ↔ AE <sub>4</sub>	-23.3521	-19.5769	3.7792	0.2340	
RLS-based filters	RLS	TE <sub>1</sub> ↔ AE <sub>1</sub>	-16.0036	-5.5187	10.4849	0.0843	01:49
		TE <sub>2</sub> ↔ AE <sub>2</sub>	-33.0132	-25.5992	7.4140	0.1379	
		TE <sub>2</sub> ↔ AE <sub>3</sub>	-27.7029	-17.6624	10.0405	0.1196	
		TE <sub>1</sub> ↔ AE <sub>4</sub>	-23.3521	-15.8197	7.5324	0.1078	
	FTF	TE <sub>1</sub> ↔ AE <sub>1</sub>	-16.0036	-6.2045	9.7991	0.0889	01:28
		TE <sub>2</sub> ↔ AE <sub>2</sub>	-33.0132	-25.5174	7.4985	0.2146	
		TE <sub>2</sub> ↔ AE <sub>3</sub>	-27.7029	-18.2309	9.4720	0.1794	
		TE <sub>1</sub> ↔ AE <sub>4</sub>	-23.3521	-16.2830	7.0691	0.1617	

**Table 1.** Experimental results for LMS, NLMS, RLS, and FTF adaptive algorithms using synthetic fECG and mECG signals generated by our novel simulator.

**Figure 10a** shows results of filtering aECG signals using the RLS algorithm and **Figure 10b** using FTF algorithm. The RLS algorithm provides a bit better than FTF algorithm, nevertheless RLS algorithm is more computational expensive than RLS algorithm (see **Table 1**).

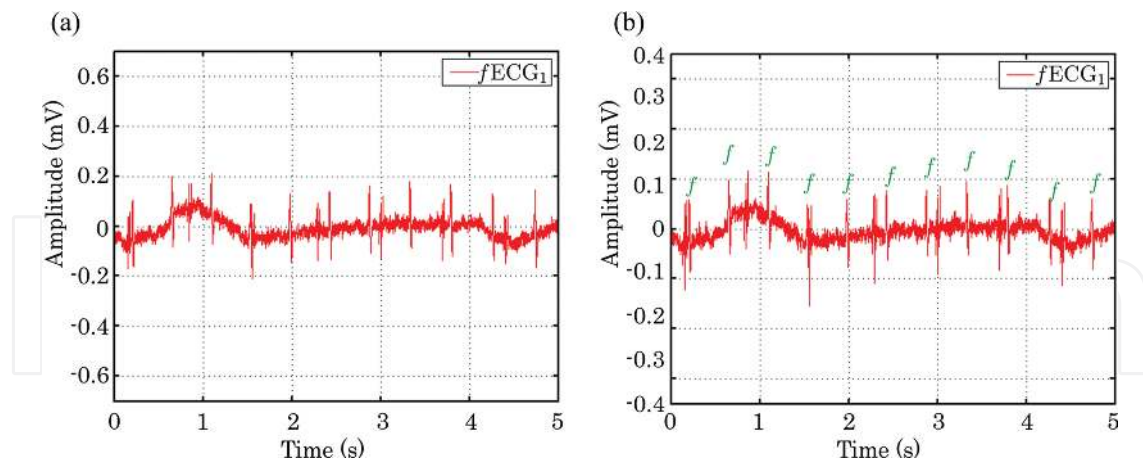

Figure 10. Output waveforms—results of filtering aECG signals (a) using the RLS and (b) using FTF algorithms.

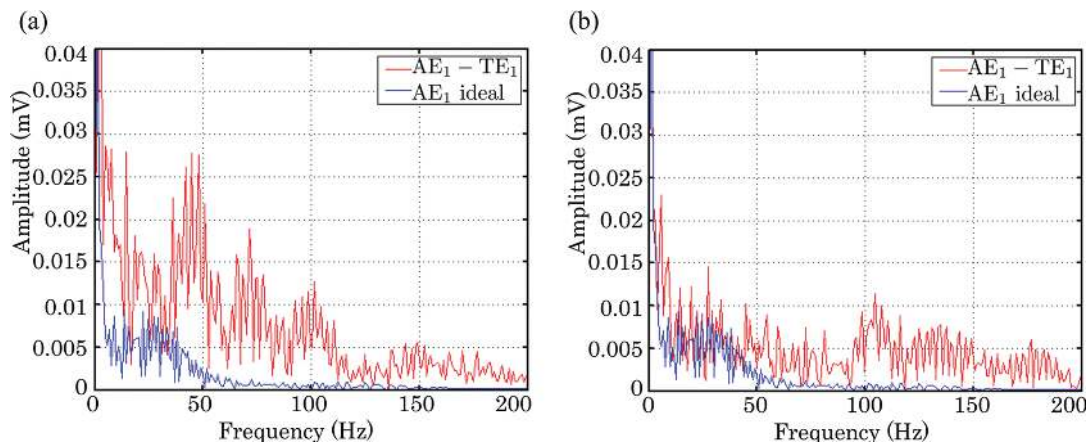
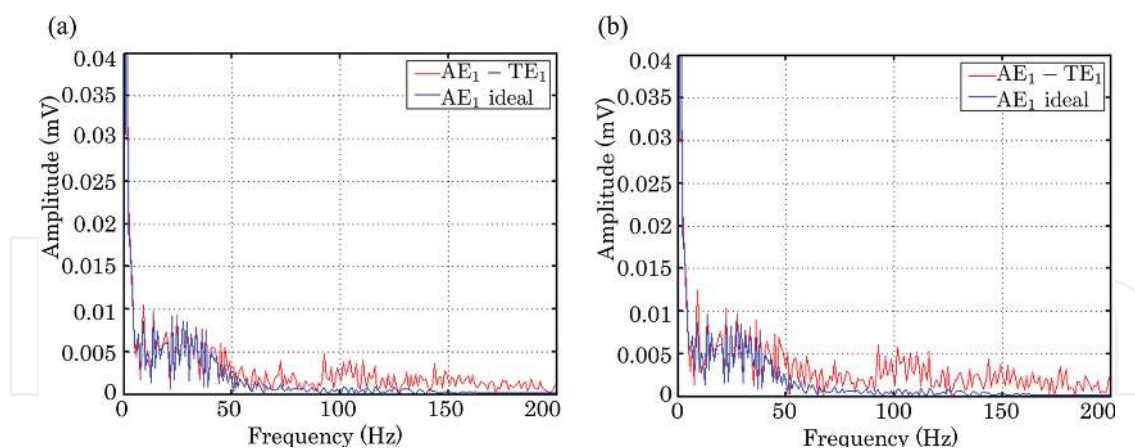

Figure 11. Amplitude spectrum—results of filtering aECG signals (a) using the LMS and (b) using NLMS Algorithms.

Figures 11 and 12 show the amplitude spectrums of the ideal fECG and the spectrum of the adaptive system output. Figure 11a shows amplitude spectrum of filtering aECG signals using the LMS algorithm and Figure 11b using the NLMS algorithm.

Figure 12a shows amplitude spectrum of filtering aECG signals using the RLS algorithm and Figure 12b using the FTF algorithm.

Table 1 shows the experimental results for the adaptive algorithms. The results presented in Table 1 and Figures 9–12 show some improvements in the frequency and time domains as measured by the quality parameters SNR and RMSE. The experimental results revealed that the RLS-based filters (RLS—Figures 10a and 12a and FTF—Figures 10b and 12b, Algorithms) produced the best outcomes. The computational times (1:49 and 1:28 s, respectively) for these algorithms were longer due to their complexity.



**Figure 12.** Amplitude spectrum—results of filtering aECG signals (a) using the RLS and (b) using FTF Algorithms.

Our experimental results described above indicate that the morphological differences between the original (ideal) and the recovered fECG signals are so significant that such processed signals cannot be satisfactorily used to detect fetal hypoxic conditions. These differences are mainly attributable to nonlinearities in the human body model. Therefore, to reduce these differences and consider the impact of the human body, nonlinear (Soft-computing) adaptive methods were used as described in the following section.

### 3.2. Experimental results: testing adaptive neuro-fuzzy inference systems

To evaluate the effectiveness of the ANFIS-based fECG filtering approach, we devised experiments using ANFISs with hybrid learning algorithms. These systems were tested with uniquely synthesized data, which comport well with real data acquired from clinical practice. Different ANFIS architectures were implemented. These structures were labeled as ANFIS1 to ANFIS5 and their parameters are summarized in **Table 2**.

	ANFIS structure				
	ANFIS 1	ANFIS 2	ANFIS 3	ANFIS 4	ANFIS 5
TNN	21	53	101	165	245
NLP	12	48	108	192	300
NNP	12	24	36	48	60
TNP	24	72	144	240	360
NFR	4	16	36	64	100

TNN—Total Number of Nodes, NLP—Number of Linear Parameters, NNP—Number of Nonlinear Parameters, TNP—Total Number of Parameters, NFR—Number of Fuzzy Rules.

**Table 2.** Details of ANFIS structures used in our experiments.

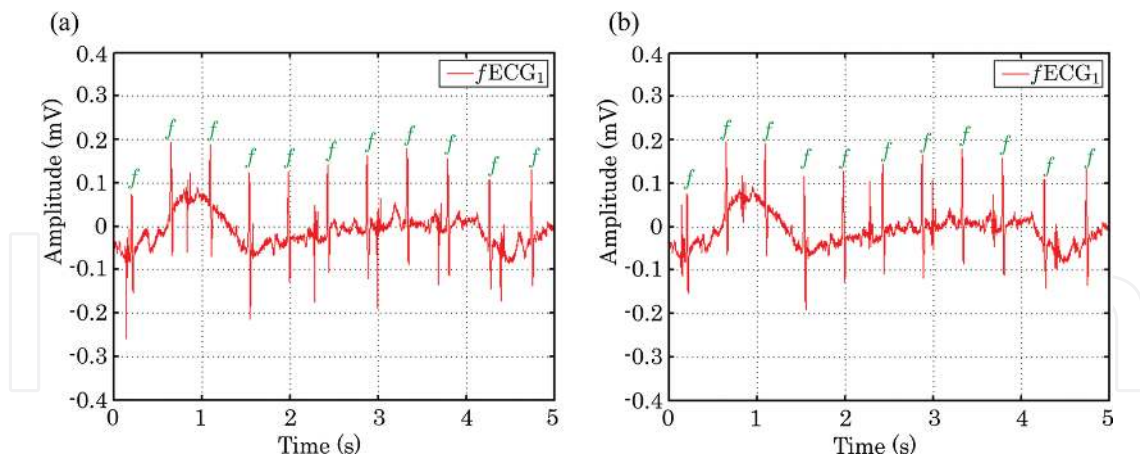

Figure 13. Output waveforms—results of filtering aECG signals (a) using ANFIS1 and (b) using ANFIS2.

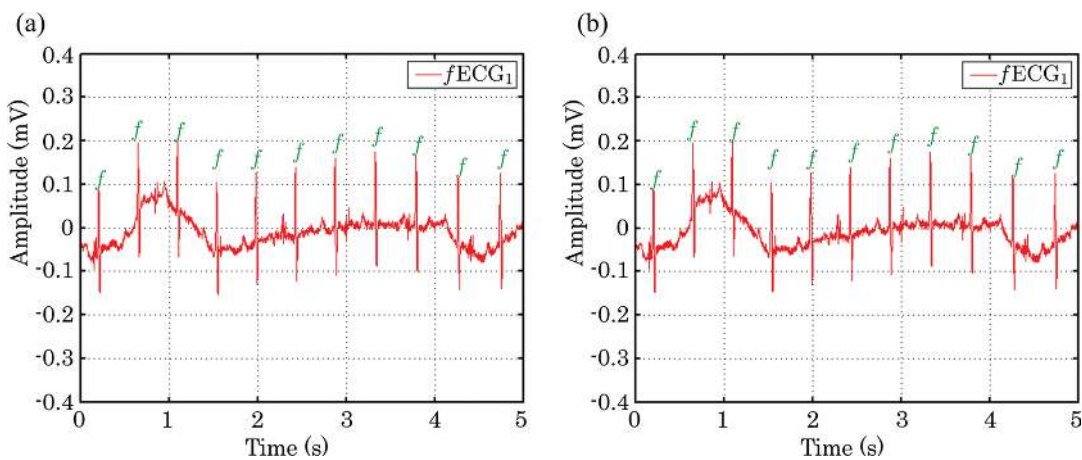

Figure 14. Output waveforms—results of filtering aECG signals (a) using ANFIS3 and (b) using ANFIS4.

Figures 13 and 14, display the output waveforms (filtering results) for each ANFIS structure used in the experiments. Figure 13a shows results of filtering aECG signals using ANFIS1, (Figure 13b) ANFIS2.

Figure 14a shows results of filtering aECG signals using ANFIS3, (Figure 14b) ANFIS4. The ANFIS systems provide better results than conventional adaptive algorithms (LMS, NLMS, RLS, FTF) in time and frequency (Figures 15 and 16) domain.

Tables 2, 3 shows that different ANFIS structures produced different filtering results as measured by the performance metrics. The results of more complex ANFIS structures were almost identical and are not presented here. We observe that by increasing the complexity of the ANFIS structure, its computing power grows disproportionately but the improvement in filtering quality is not that significant. This fact helps us decide not to consider more complex ANFIS structures for online filtering. With this in mind, ANFIS3 seems to be the most appropriate structure for online filtering and produces acceptable results.



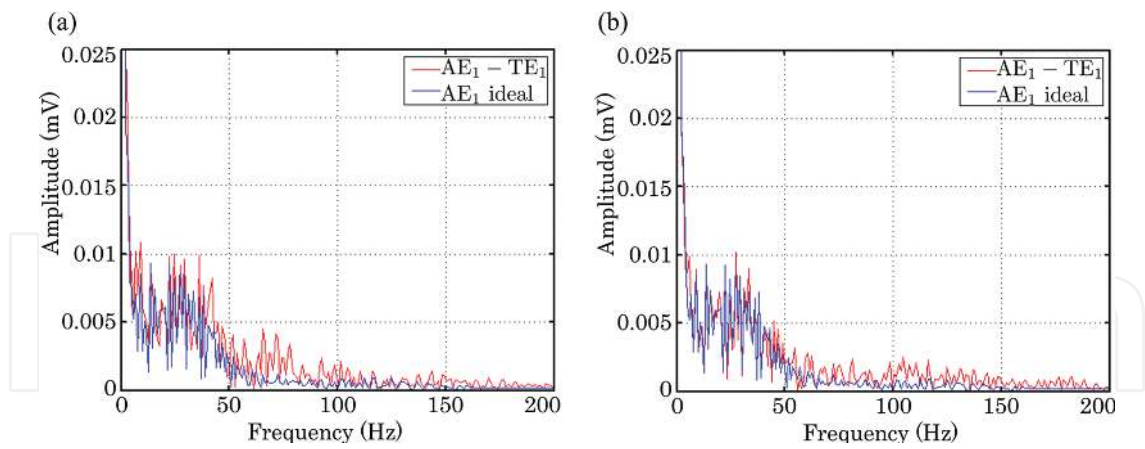

Figure 15. Amplitude spectrum—results of filtering aECG signals (a) using ANFIS1 and (b) using ANFIS2.

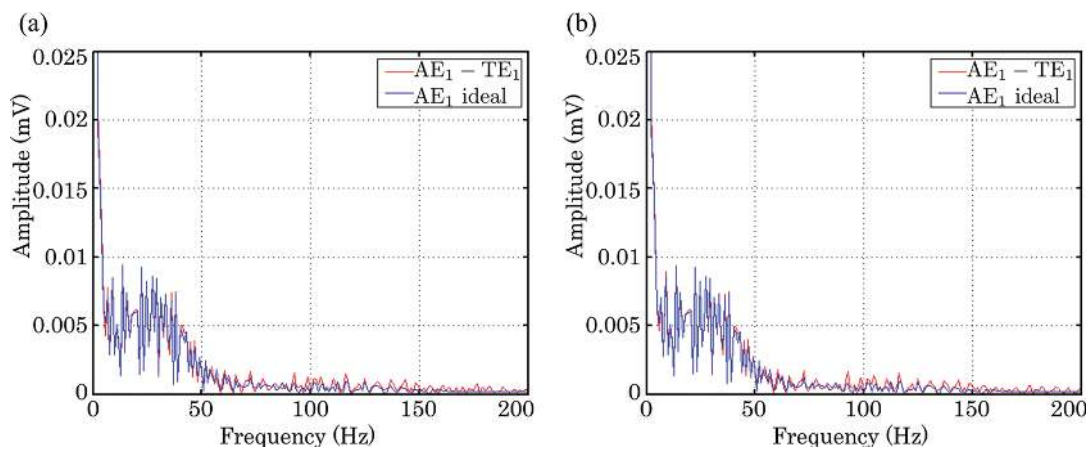

Figure 16. Amplitude spectrum—results of filtering aECG signals (a) using ANFIS3 and (b) using ANFIS4.

Figures 15 and 16 show the amplitude spectrums illustrating the filtering results achieved by ANFISs. Figure 15a shows the results for ANFIS1 and Figure 15b for ANFIS2. Each graphs illustrates the ideal fECG amplitude spectrum (Ideal AE1) together with the amplitude spectrum of the output signal from adaptive system used for each ANFIS structure.

Figure 16a shows the results for ANFIS3 and Figure 16b for ANFIS4. The results are summarized in Table 3.

Figure 17 shows the relationship between SNR<sub>in</sub> and SNR<sub>out</sub> for ANFIS1-ANFIS5. Over 100 independent experiments were performed to obtain the results reported here. We observe that these systems achieve very similar results but the processing time increases significantly with the growing complexity of their architectures.

The main advantage of the results reported here, which distinguishes them from many findings reported in the literature, is that these are achieved and tested by using clinical-quality synthetic data (identical to the real data generated by the underlying nonlinear physiological systems in the human body), thanks to the in-built capabilities of our unique signal generator.



This ensures objective assessment of the fECG signal separation quality based on quantitative performance measures (SNR, RMSE, SNR<sub>in</sub> and SNR<sub>out</sub>).

Name of adaptive filter used	Electrodes combination	SNR <sub>in</sub> (dB)	SNR <sub>out</sub> (dB)	SNR <sub>imp</sub> (dB)	RMSE (-)	Processing time (min:s)	
Adaptive neuro-fuzzy inference system	ANFIS 1	TE <sub>1</sub> ↔ AE <sub>1</sub>	-16.0036	-7.5799	8.4237	0.1380	01:53
		TE <sub>2</sub> ↔ AE <sub>2</sub>	-33.0132	-16.1208	16.8924	0.2723	
		TE <sub>2</sub> ↔ AE <sub>3</sub>	-27.7029	-13.7670	13.9359	0.2190	
		TE <sub>1</sub> ↔ AE <sub>4</sub>	-23.3521	-12.6453	10.7068	0.1526	
	ANFIS 2	TE <sub>1</sub> ↔ AE <sub>1</sub>	-16.0036	-3.0966	12.9070	0.0595	03:33
		TE <sub>2</sub> ↔ AE <sub>2</sub>	-33.0132	-7.9803	25.0329	0.1479	
		TE <sub>2</sub> ↔ AE <sub>3</sub>	-27.7029	-8.5094	19.1935	0.1361	
		TE <sub>1</sub> ↔ AE <sub>4</sub>	-23.3521	-6.1662	17.1859	0.0989	
	ANFIS 3	TE <sub>1</sub> ↔ AE <sub>1</sub>	-16.0036	-1.0318	14.9718	0.0046	06:31
		TE <sub>2</sub> ↔ AE <sub>2</sub>	-33.0132	-3.7510	29.2622	0.0562	
		TE <sub>2</sub> ↔ AE <sub>3</sub>	-27.7029	-2.4146	25.2883	0.0533	
		TE <sub>1</sub> ↔ AE <sub>4</sub>	-23.3521	-1.1298	22.2223	0.0384	
	ANFIS 4	TE <sub>1</sub> ↔ AE <sub>1</sub>	-16.0036	-0.3004	15.7032	0.0043	12:48
		TE <sub>2</sub> ↔ AE <sub>2</sub>	-33.0132	-3.6457	29.3675	0.0554	
		TE <sub>2</sub> ↔ AE <sub>3</sub>	-27.7029	-2.3999	25.3030	0.0582	
		TE <sub>1</sub> ↔ AE <sub>4</sub>	-23.3521	-1.1056	22.2465	0.0381	
	ANFIS 5	TE <sub>1</sub> ↔ AE <sub>1</sub>	-16.0036	-0.3009	15.7027	0.0043	18:52
		TE <sub>2</sub> ↔ AE <sub>2</sub>	-33.0132	-3.5974	29.4158	0.0590	
		TE <sub>2</sub> ↔ AE <sub>3</sub>	-27.7029	-2.4017	25.3012	0.0453	
		TE <sub>1</sub> ↔ AE <sub>4</sub>	-23.3521	-1.0327	22.3194	0.0373	

**Table 3.** Experimental results for ANFIS 1—ANFIS 5 using synthetic fECG and mECG signals generated by our novel simulator.

We should emphasize that as the ECG signals in their path from the thorax to the abdominal electrodes experience nonlinearities, the linear adaptive algorithms that are only suitable for the fHR estimation are insufficient to capture their necessary morphological details to facilitate accurate ST segment analysis (STAN). We observed that the morphological differences between the original (ideal) and recovered fECG signals by using these linear algorithms are so significant that the recovered signals cannot be used to reliably detect fetal hypoxic conditions. In other words, when clinical-quality synthetic data such as those produced by our software-controlled generator were used, adaptive algorithms were unable to adequately suppress the undesirable signals, particularly the mECG signals. For this reason, besides the

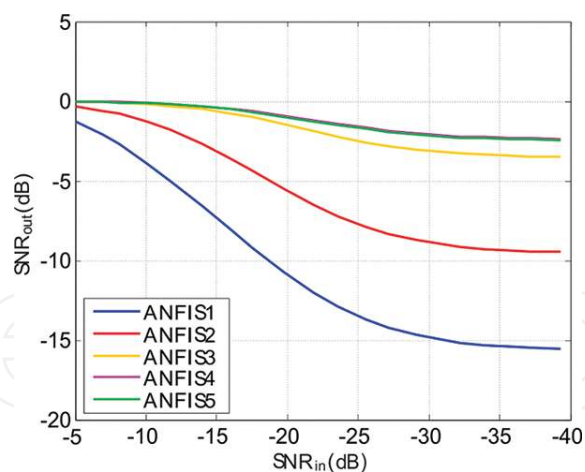

Figure 17. The Relationship between SNR<sub>in</sub> and SNR<sub>out</sub> for ANFIS31-ANFIS5.

classical adaptive approaches, soft computing techniques had to be used in our experiments to produce acceptable outcomes.

Comparing the results of ANFIS (Table 1) and adaptive algorithms (Table 3) for fECG extraction, it is demonstrated that ANFIS produces better results based upon SNR and RMSE improvements. A general disadvantage of using ANFISs is their longer processing time during network training, especially in the more sophisticated networks, which are necessary for more complex systems. From our experimental results in (Table 1), it is evident that the final values of SNR<sub>outs</sub> are closely related to SNR<sub>ins</sub>.

## 4. Conclusion

In this chapter we focused on the use of advanced adaptive signal processing methods and highlighted the advantage of nonlinear methods such as adaptive neuro-fuzzy inference systems in enabling researchers to develop more reliable and accurate approaches in extracting diagnostic quality fECG signals and consequently facilitate the accurate detection of hypoxic conditions during pregnancy and labor. We included recent research findings from the most relevant engineering and medical literature and added our own contributions to the field. It is important to emphasize that currently only a fraction of the vast amount of diagnostic information in the abdominal ECG is used in clinical practice. Therefore, maximizing information extraction from fECG and CTG signals for the timely and reliable detection of fetal hypoxia is of tremendous clinical interest. This is a major challenge in signal processing and modern obstetrics as accurate determination of the fetus' status during pregnancy and labor is highly dependent on the quality of abdominal ECG monitoring, fECG signal filtering, and the consequent analysis of CTG and ST segments. In this chapter we also used a novel multichannel adaptive system that was designed, implemented, and validated by the authors to generate clinical-quality data and test and compare a variety of relevant signal processing algorithms. The primary component of this system is its adaptive block and the associated

back-propagated mechanism that requires two inputs for each channel: the desired and the actual.

Our experimental results using clinical-quality synthetic data generated by our novel signal generator revealed that it offers the potential to significantly refine the diagnostic quality of the noninvasive aECG signals. We could safely conclude that following the approach presented in this chapter researchers and clinicians could acquire high quality fetal heartbeat and uterine contraction data and extract clinically significant features for reliable and accurate detection of hypoxic conditions in the fetus. As such, we are hopeful that our contribution here facilitates the development and advancement of new diagnostic methods based on transabdominal CTG + STAN. We envision that the future of fetal monitoring will greatly benefit from sophisticated diagnostic instrumentation equipped with state-of-the-art transabdominal CTG and STAN capabilities.

## Author details

Radek Martinek<sup>1\*</sup>, Radana Kahankova<sup>1</sup>, Hana Skukova<sup>1</sup>, Jaromir Konecny<sup>1</sup>, Petr Bilik<sup>1</sup>, Jan Zidek<sup>1</sup> and Homer Nazeran<sup>2</sup>

\*Address all correspondence to: [radek.martinek@vsb.cz](mailto:radek.martinek@vsb.cz)

<sup>1</sup> Department of Cybernetics and Biomedical Engineering, VSB-Technical University of Ostrava, Ostrava-Poruba, Czech Republic

<sup>2</sup> Department of Electrical and Computer Engineering, University of Texas El Paso, El Paso, TX, USA

## References

- [1] Amer-Wahlin I., Hellsten Ch., Noren H., Hagberg H., Herbst A., Kjellmer Ingemar, Lilja h., Lindoff C., Mansson M., Martensson L., others. Cardiotocography only versus cardiotocography plus ST analysis of fetal electrocardiogram for intrapartum fetal monitoring: a Swedish randomised controlled trial. *The Lancet*. 2001;358(9281):534–538.
- [2] Freeman R. K., Garite T. J., Nageotte M. P., Miller L. A. *Fetal heart rate monitoring*. Lippincott Williams & Wilkins, Philadelphia; 2012.
- [3] Soothill P. W., Nicolaides K. H., Campbell S. Prenatal asphyxia hyperlacticaemia hypoglycaemia and erythroblastosis in growth retarded fetuses. *BMJ*. 1987;294(6579): 1051–1053.

- [4] Jagannath D. J., Selvakumar A. I. Issues and research on foetal electrocardiogram signal elicitation. *Biomedical Signal Processing and Control*. 2014;10(1):224–244. doi:10.1016/j.bspc.2013.11.001
- [5] Burattini L., Agostinelli A., Grillo M., Biagini A., Giuliani C., Burattini L., Fioretti S., Di Nardo F., Giannubilo S. R., Ciavattini A. Noninvasive fetal electrocardiography: an overview of the signal electrophysiological meaning, recording procedures, and processing techniques. *Annals of Noninvasive Electrocardiology*. 2015;20(4):303–313. doi:10.1111/anec.12259
- [6] Neoventa [Internet]. <http://www.neoventa.com/products/stan>. Accessed 2015-05-31
- [7] Martinek R., Kelnar M., Vojcinak P., Koudelka P., Vanus J, Bilik P., Janku P, Nazeran H., Zidek J. Virtual simulator for the generation of patho-physiological foetal ECGs during the prenatal period. *Electronics Letters*. 2015;51(22):1738–1740.
- [8] Martinek R., Kelnar M., Koudelka P., Vanus J., Bilik P., Janku P., Nazeran H., Zidek J. A novel LabVIEW-based multi-channel non-invasive abdominal maternal-fetal electrocardiogram signal generator. *Physiological Measurement*. 2016;37(2):238.
- [9] Datian Ye, Xuemei Ouyang. Application of wavelet analysis in detection of fetal ECG. In: *Engineering in Medicine and Biology Society, 1996. Bridging Disciplines for Biomedicine. Proceedings of the 18th Annual International Conference of the IEEE;* 1996. p. 1043–1044.
- [10] Khamene Ali, Negahdaripour Shahriar. A new method for the extraction of fetal ECG from the composite abdominal signal. *IEEE Transactions on Biomedical Engineering*. 2000;47(4):507–516.
- [11] Karvounis E. C., Papaloukas C., Fotiadis Dimitrios I., Michalis L. K. Fetal heart rate extraction from composite maternal ECG using complex continuous wavelet transform. In: *Computers in Cardiology, 2004;* 2004. p. 737–740.
- [12] Shi Zhenwei, Zhang Changshui. Semi-blind source extraction for fetal electrocardiogram extraction by combining non-Gaussianity and time-correlation. *Neurocomputing*. 2007;70(7):1574–1581.
- [13] Bergveld Piet, Meijer Wietze JH. A new technique for the suppression of the MEEG. *IEEE Transactions on Biomedical Engineering*. 1981;(4):348–354.
- [14] Al-Zaben A, Al-Smadi A. Extraction of foetal ECG by combination of singular value decomposition and neuro-fuzzy inference system. *Physics in Medicine and Biology*. 2005;51(1).
- [15] De Lathauwer Lieven, De Moor Bart, Vandewalle Joos. Fetal electrocardiogram extraction by blind source subspace separation. *IEEE Transactions on Biomedical Engineering*. 2000;47(5):567–572.

- [16] Sameni R., Jutten Ch., Shamsollahi H. B. What ICA provides for ECG processing: application to noninvasive fetal ECG extraction. In: IEEE International Symposium on Signal Processing and Information Technology, 2006; 2006. p. 656–661.
- [17] Marossero D. E., Erdogmus D., Euliano N., Principe J. C., Hild K. E. Independent components analysis for fetal electrocardiogram extraction: a case for the data efficient Mermaid algorithm. In: 2003 IEEE 13th Workshop on Neural Networks for Signal Processing, 2003. NNSP'03; 2003. p. 399–408. doi:10.1109/NNSP.2003.1318039.
- [18] Hon E. H., Lee S. T. Averaging techniques in fetal electrocardiography. *Medical Electronics and Biological Engineering*. 1964;2(1):71–76.
- [19] Outram NJ, Ifeakor EC, Van Eetvelt PWJ, Curnow JSH. Techniques for optimal enhancement, feature extraction of fetal electrocardiogram. In: *IEE Proceedings Science, Measurement and Technology*; 1995. p. 482–489.
- [20] Favret A. G. Computer matched filter location of fetal R-waves. *Medical and Biological Engineering*. 1968;6(5):467–475.
- [21] Widrow B., Glover Jr J. R., McCool J. M., Kaunitz J., Williams Ch. S., Hearn R. H., Zeidler J. R., Dong Jr E., Goodlin R. C. Adaptive noise cancelling: principles and applications. *Proceedings of the IEEE*. 1975;63(12):1692–1716.
- [22] Martinek R., Kelnar M., Koudelka P., Vanus J, Bilik P., Janku P., Nazeran H., Zidek J. Enhanced processing and analysis of multi-channel noninvasive abdominal foetal ECG signals during labor and delivery. *Electronics Letters*. 2015;51(22):1744–1746.
- [23] Martinek R, Zidek J. Refining the diagnostic quality of the abdominal fetal electrocardiogram using the techniques of artificial intelligence. *Przeglad Elektrotechniczny*. 2012;88(12 B):155–160.
- [24] Swarnalatha R, Prasad DV. A novel technique for extraction of FECG using multi stage adaptive filtering. *Journal of Applied Sciences*. 2010;10(4):319–324.
- [25] Wu Shuicai, Shen Yanni, Zhou Zhuhuang, Lin Lan, Zeng Yanjun, Gao Xiaofeng. Research of fetal ECG extraction using wavelet analysis and adaptive filtering. *Computers in Biology and Medicine*. 2013;43(10):1622–1627.
- [26] Poularikas Alexander D, Ramadan Zayed M. *Adaptive filtering primer with MATLAB*. CRC Press, Boca Raton; 2006.
- [27] Wei Zheng, Xueyun Wei, Hongxing Liu, others. Noninvasive fetal ECG estimation using adaptive comb filter. *Computer Methods and Programs in Biomedicine*. 2013;112(1).
- [28] Shadaydeh Maha, Xiao Yegui, Kriedieh Ward Rabab. Extraction of fetal ECG using adaptive Volterra filters. In: *16th European Signal Processing Conference, 2008; 2008*. p. 1–5.



- [29] Sameni R., Shamsollahi M. B., Jutten Ch., Babaie-Zadeh M. Filtering noisy ECG signals using the extended Kalman filter based on a modified dynamic ECG model. In: *Computers in Cardiology*, 2005; 2005. p. 1017–1020.
- [30] Niknazar M., Rivet B., Jutten Ch. Fetal ECG extraction by extended state Kalman filtering based on single-channel recordings. *IEEE Transactions on Biomedical Engineering*. 2013;60(5):1345–1352.
- [31] Bin Ibne Reaz Mamun, Wei Lee Sze. Adaptive linear neural network filter for fetal ECG extraction. In: *Proceedings of International Conference on Intelligent Sensing and Information Processing*, 2004; 2004. p. 321–324.
- [32] Sameni Reza. Extraction of fetal cardiac signals from an array of maternal abdominal recordings [dissertation]. Sharif University of Technology, Tehran, Iran; 2008.
- [33] Alexander Thomas S. Adaptive signal processing: theory and applications. Springer Science & Business Media, New York; 2012.
- [34] National instruments. Least mean square (LMS) Adaptive filter—developer zone—national instruments. [Internet]. 10. June 2009. Accessed 26-2-2016
- [35] Akay Metin. Biomedical signal processing. Academic Press, Cambridge; 2012.
- [36] Cioffi J. M., Kailath T. Fast, recursive-least-squares transversal filters for adaptive filtering. *IEEE Transactions on Acoustics, Speech and Signal Processing*. 1984;32(2): 304–337.
- [37] Martinez M., Calpe J., Soria E., Guerrero J. F., Camps G., Gomez L. Methods to evaluate the performance of fetal electrocardiogram extraction algorithms. In: *Computers in Cardiology* 2001; 2001. p. 253–256.
- [38] Mahfuz Ejaz, Wang Chunyan, Ahmad M Omair. A high-throughput DLMS adaptive algorithm. In: *IEEE International Symposium on Circuits and Systems*, 2005. ISCAS 2005; 2005. p. 3753–3756.
- [39] Suja Priyadharsini S, Edward Rajan S, Saranya S. An efficient soft-computing technique for extracting fetal. In: *Programmable Device Circuits and Systems*; 2011. p. 1–7.
- [40] Nasiri Maryam. Fetal electrocardiogram signal extraction by ANFIS trained with PSO method. *International Journal of Electrical and Computer Engineering*. 2012;2:247 (IAES Institute of Advanced Engineering and Science).
- [41] Martinek R., Sincl A., Vanus J., Kelnar M., Bilik P., Machacek Z., Zidek J. Modelling of fetal hypoxic conditions based on virtual instrumentation. In: *Proceedings of the Second International Afro-European Conference for Industrial Advancement AECIA* 2015; 2016. p. 249–259.
- [42] Martinek R., Zidek J. A system for improving the diagnostic quality of fetal electrocardiogram. *Przegląd Elektrotechniczny (Electrical Review)*, R. 2012;88:164–173.

- [43] Caydas U., Hascalik A., Ekici S. An adaptive neuro-fuzzy inference system (ANFIS) model for wire-EDM. *Expert Systems with Applications*. 2009;36(3):6135–6139.
- [44] Jang Jyh-Shing Roger. ANFIS: adaptive-network-based fuzzy inference system. *IEEE Transactions on Systems Man and Cybernetics*. 1993;23(3):665–685.
- [45] Swarnalatha R, Prasad DV. Maternal ECG cancellation in abdominal signal using ANFIS and wavelets. *Applied Science*. 2010;10:868–877.
- [46] Martinek R. The Use of complex adaptive methods of signal processing for refining the diagnostic quality of the [dissertation]. VSB—Technical University of Ostrava; 2014.
- [47] Nguyen Hung T, Prasad Nadipuram R, Walker Carol L, Walker Elbert A. A first course in fuzzy and neural control. CRC press, Boca Raton; 2002.
- [48] Wang Peizhuang, Tan Shaohua. Soft computing and fuzzy logic. *Soft Computing*. 1997;1(1):35–41.
- [49] Zadeh Lotfi A. Soft computing and fuzzy logic. *IEEE Software*. 1994;11(6):48.
- [50] Zadeh Lotfi A. Fuzzy logic=computing with words. *IEEE Transactions on Fuzzy Systems*. 1966;4(2):103–111.
- [51] Zadeh Lofti A. Fuzzy logic, neural networks, and soft computing. *Communications of the ACM*. 1994;37(3):77–85.
- [52] Camps-Valls Gustavo, Martinez-Sober Marcelino, Soria-Olivas Emilio, Magdalena-Benedito Rafael, Calpe-Maravilla Javier, Guerrero-Martinez Juan. Foetal ECG recovery using dynamic neural networks. *Artificial Intelligence in Medicine*. 2004;31(3):197–209.
- [53] Kedir-Talha M, Guettouche MA, Bousbia-Salah A. Combination of a FIR filter with a genetic algorithm for the extraction of a fetal ECG. In: *Proceedings of International Conference on Circuit, Systems and Signals (CSS10)*, Malta, September 2010, p. 76; 2010.
- [54] Kam Amit, Cohen Arnon. Detection of fetal ECG with IIR adaptive filtering and genetic algorithms. In: *1999 IEEE International Conference on Acoustics, Speech, and Signal Processing*, 1999; 1999. p. 2335–2338.
- [55] Kezi Selva Vijila CP, Kanagasabapathy S. Johnson. Adaptive neuro fuzzy inference system for extraction of fecg. In: *Annual IEEE India Conference—Indicon*; 2005. p. 224–227. doi:10.1109/INDCON.2005.1590160.
- [56] Assaleh Khaled. Extraction of fetal electrocardiogram using adaptive neuro-fuzzy inference systems. *IEEE Transactions on Biomedical Engineering*. 2007;54(1):59–68.
- [57] Jalaliddine Sateh, Hutchens Chriswell G, Strattan Robert D, Coberly William A. ECG data compression techniques—a unified approach. *IEEE Transactions on Biomedical Engineering*. 1990;37(4):329–343.

- [58] Wen He, Meng Zhuo, Teng Zhaosheng, Guo Siyu, Yang Yuxiang. Comparative study of influence of noise on power frequency estimation of sine wave using interpolation FFT. *Fluctuation and Noise Letters*. 2014;13(03)
- [59] Wen He, Teng Zhaosheng, Guo Siyu. Triangular self-convolution window with desirable sidelobe behaviors for harmonic analysis of power system. *IEEE Transactions on Instrumentation and Measurement*. 2010;59(3):543–552.
- [60] Martinek R., Kelnar M., Vanus J., Bilik P., Zidek J. A robust approach for acoustic noise suppression in speech using ANFIS. *Journal of Electrical Engineering*. 2015;66(6):301–310.
- [61] Kromer Pavel, Prauzek Michal, Musilek Petr. Harvesting-aware control of wireless sensor nodes using fuzzy logic and differential evolution. In: 2014 Eleventh Annual IEEE International Conference on Sensing, Communication, and Networking Workshops (SECON Workshops); 2014. p. 51–56.
- [62] Martinek R., Zidek J. Use of adaptive filtering for noise reduction in communications systems. In: 2010 International Conference on Applied Electronics (AE). 2010; p. 1–6.
- [63] Martinek R., Zidek J. The real implementation of ANFIS channel equalizer on the system of software-defined radio. *IETE Journal of Research*. 2014;60(2):183–193.