

NONLINEAR PHENOMENA IN POWER ELECTRONICS

Soumitro Banerjee

*Department of Electrical Engineering
Indian Institute of Technology
Kharagpur — 721302, India*

All power electronic circuits share the following properties:

- **Switches** make the circuit toggle between two or more different topologies (different sets of differential equations) at different times.
- **Storage elements** (inductors and capacitors) absorb energy from a circuit, store it and return it.
- The switching times are nonlinear functions of the variables to be controlled (mostly the output voltage).

The basic source of nonlinearity:

feedback controlled switching

In addition there are “parasitic” nonlinearities —

1. the nonlinear $v - i$ characteristics of switches,
2. nonlinear inductances and capacitances,
3. electromagnetic couplings between components.

However, the main source of nonlinearity is the ubiquitous **switching element** — which makes all power electronic systems strongly nonlinear even if all components are assumed to be ideal.

Therefore

Power electronics engineers/researchers are invariably dealing with nonlinear problems.

Example 1: The voltage-mode controlled buck converter

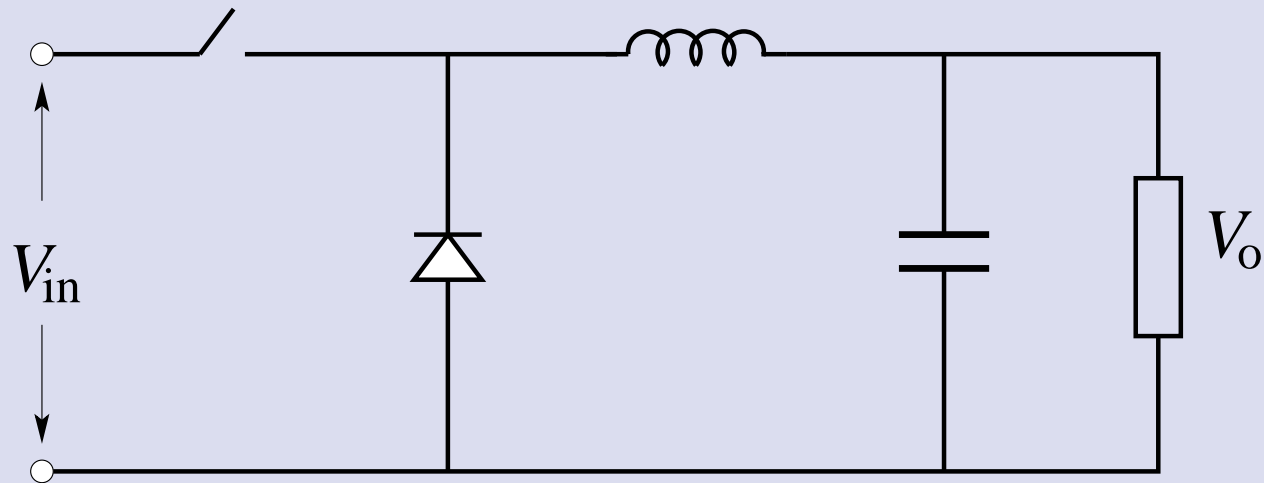

Example 1: The voltage-mode controlled buck converter

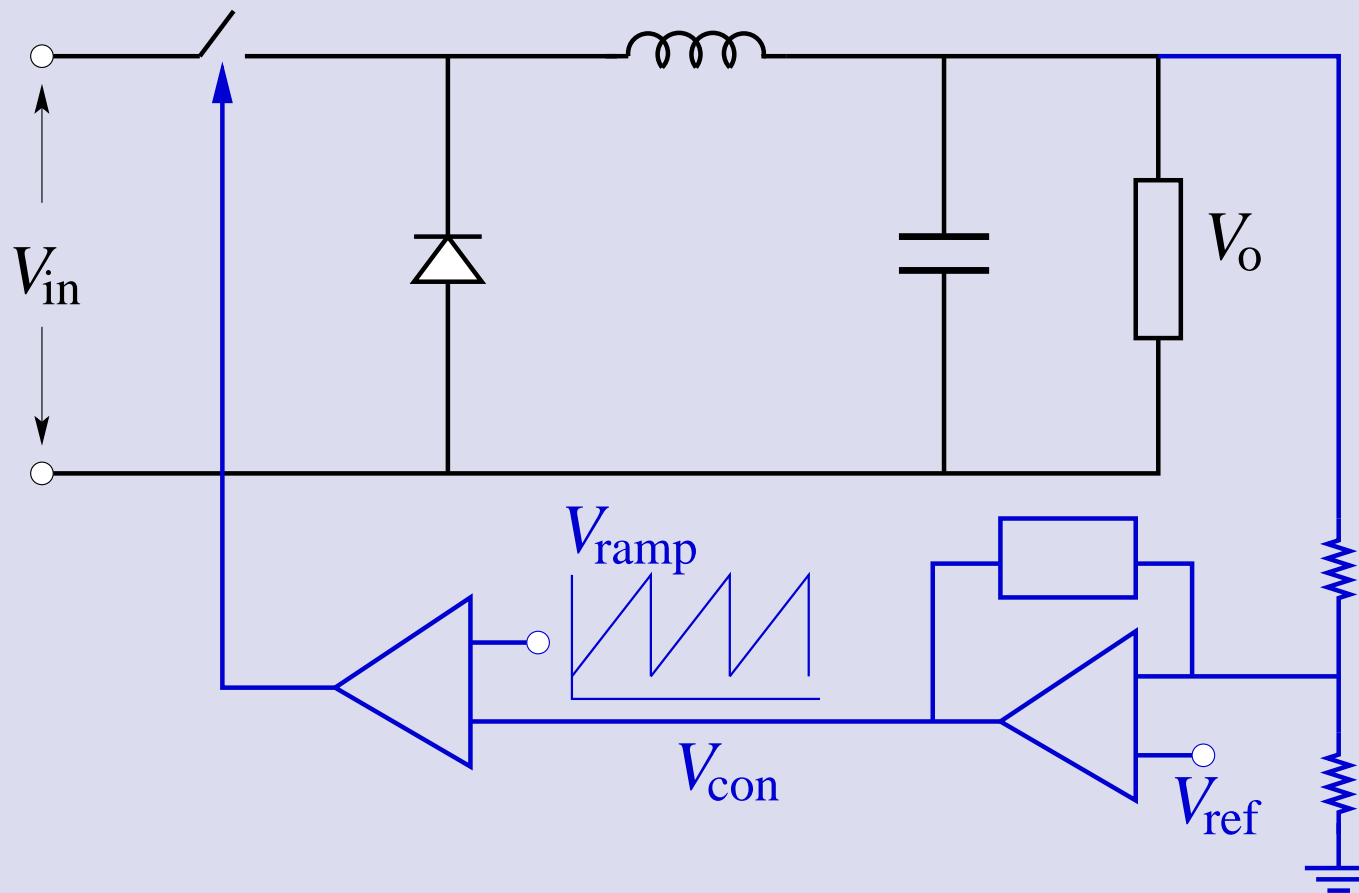

Example 1: The voltage-mode controlled buck converter

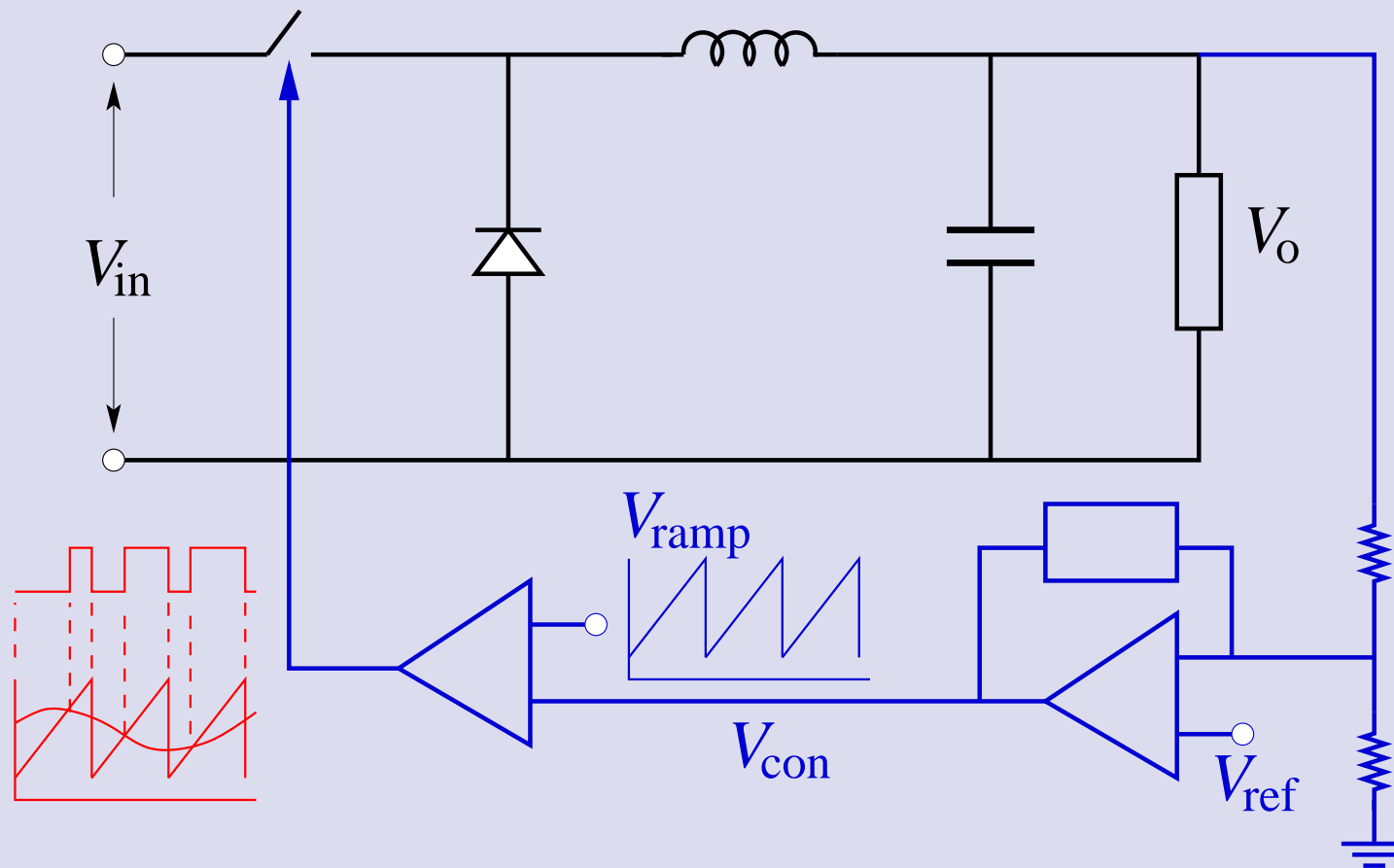

Nominal periodic behavior

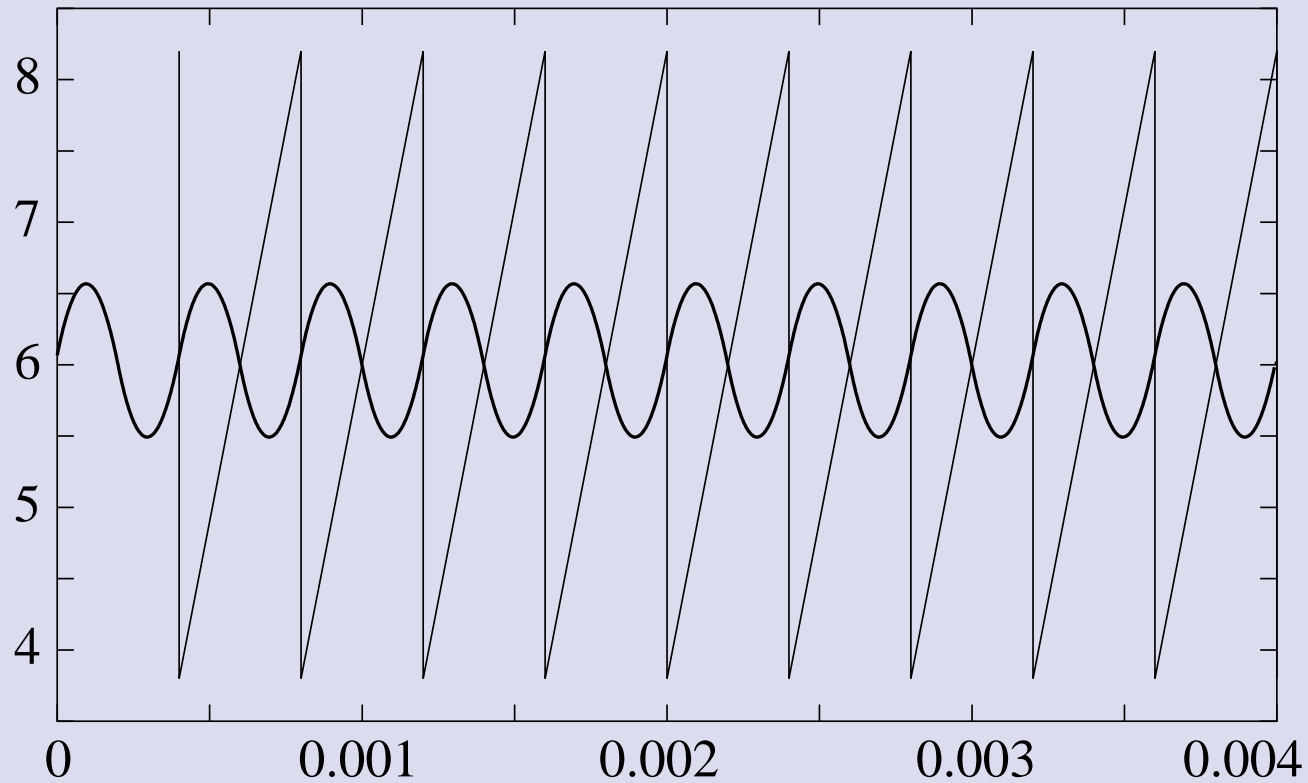

(a)

But such a behavior occurs only within certain limits of the external parameters.

Change of behaviour due to fluctuation of input voltage:

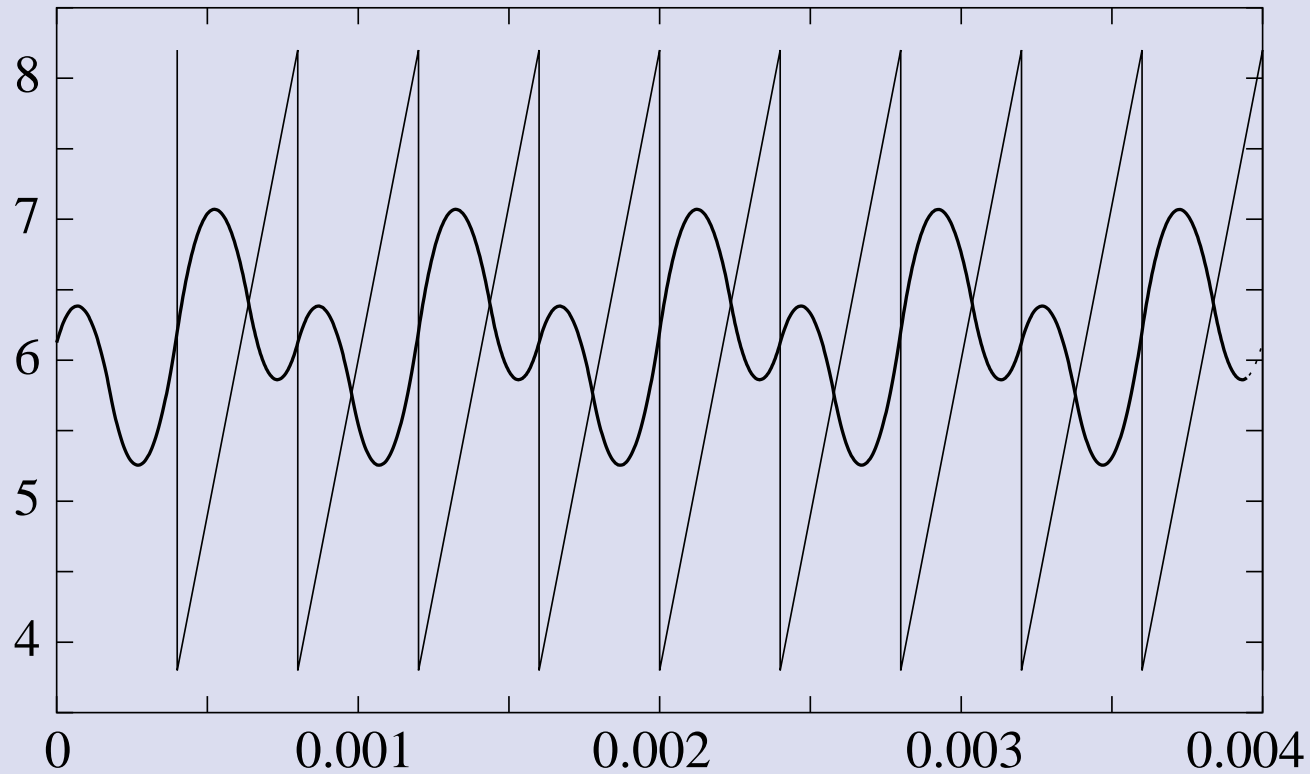

(b)

The change in behavior occurred when the input voltage changed from $V_{in} = 24 \text{ V}$ to $V_{in} = 25 \text{ V}$.

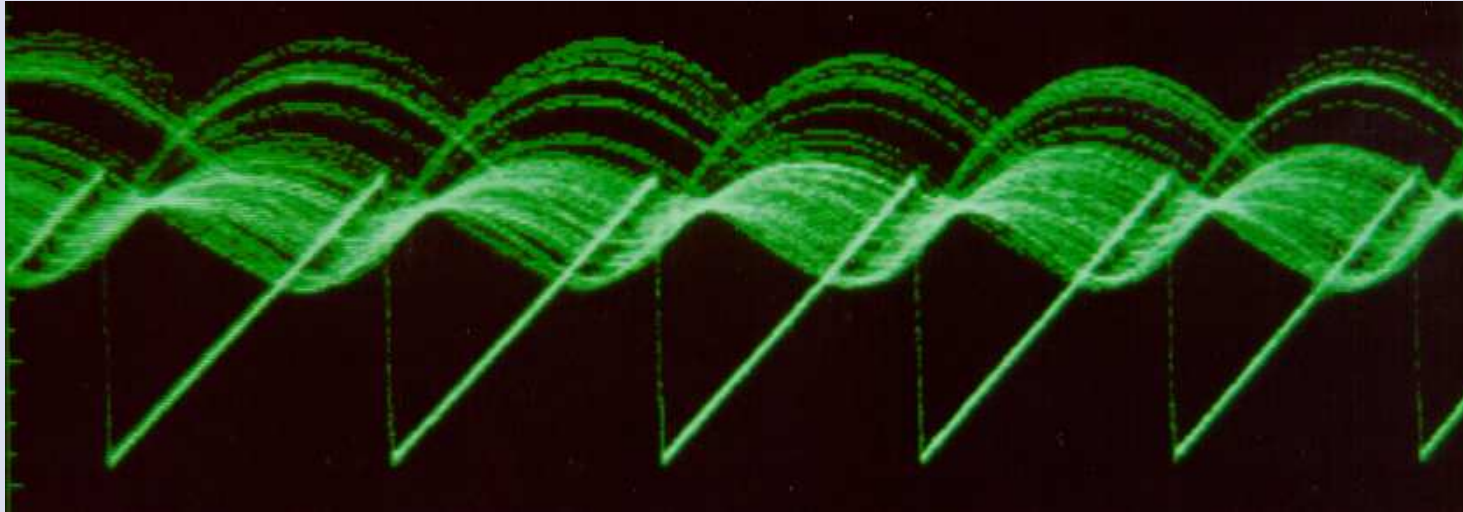

When V_{in} is increased to 35V, the behavior becomes aperiodic, or
chaotic.



(a)

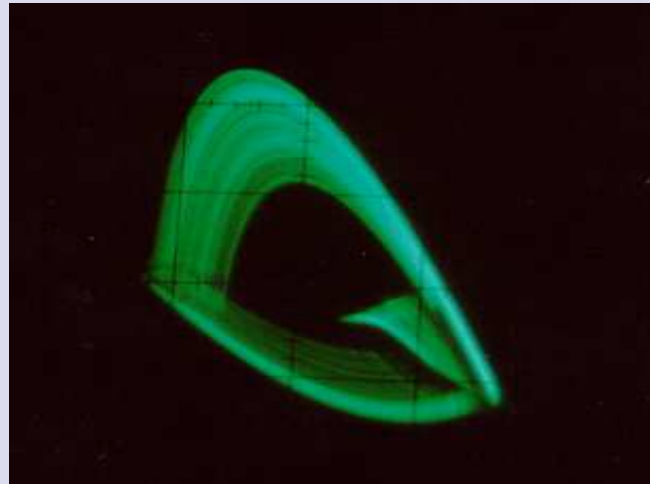

(b)

(a) The experimental period-2 attractor
and (b) the chaotic attractor.

CHAOS

- Aperiodic waveform
- Seemingly random, noise-like behavior
- Completely deterministic
- The orbit is sensitively dependent on the initial condition
- Statistical behaviour (average values of state variables, power spectrum etc.) completely predictable.
- Unstable at every equilibrium point, but globally stable.
Waveform bounded.

Example 2: The current mode controlled boost converter

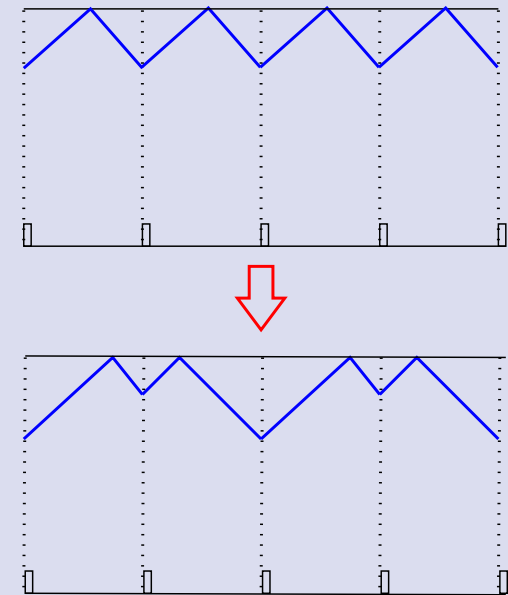
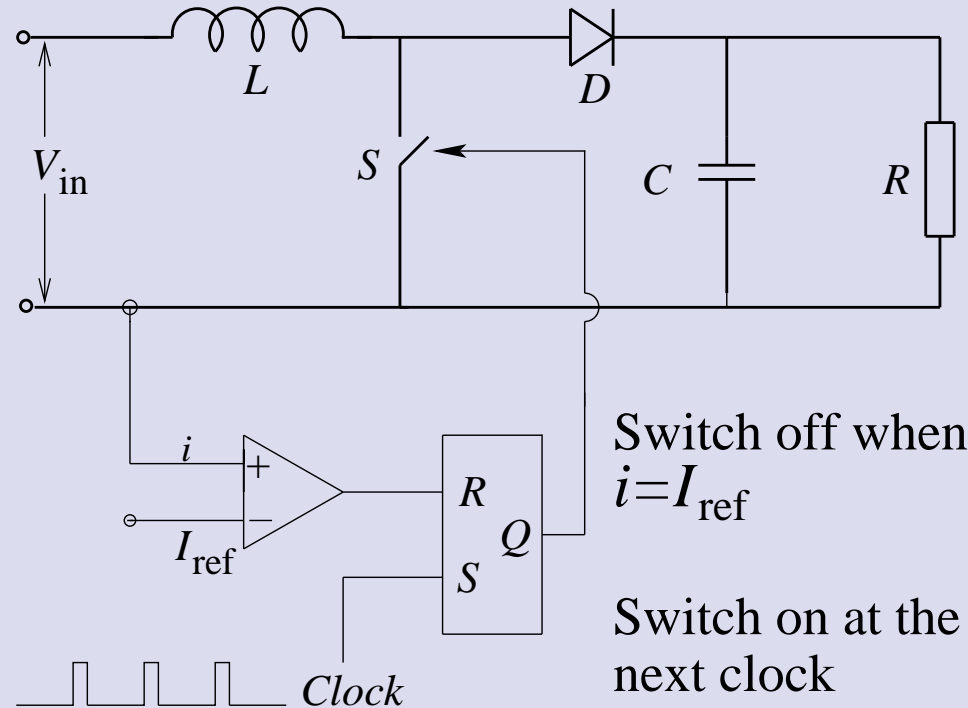

Instability and transition to period-2 subharmonic at the critical duty ratio of 0.5.

How to probe such phenomena?

- Averaged model

$$\frac{dx}{dt} = f(x, \mu, t)$$

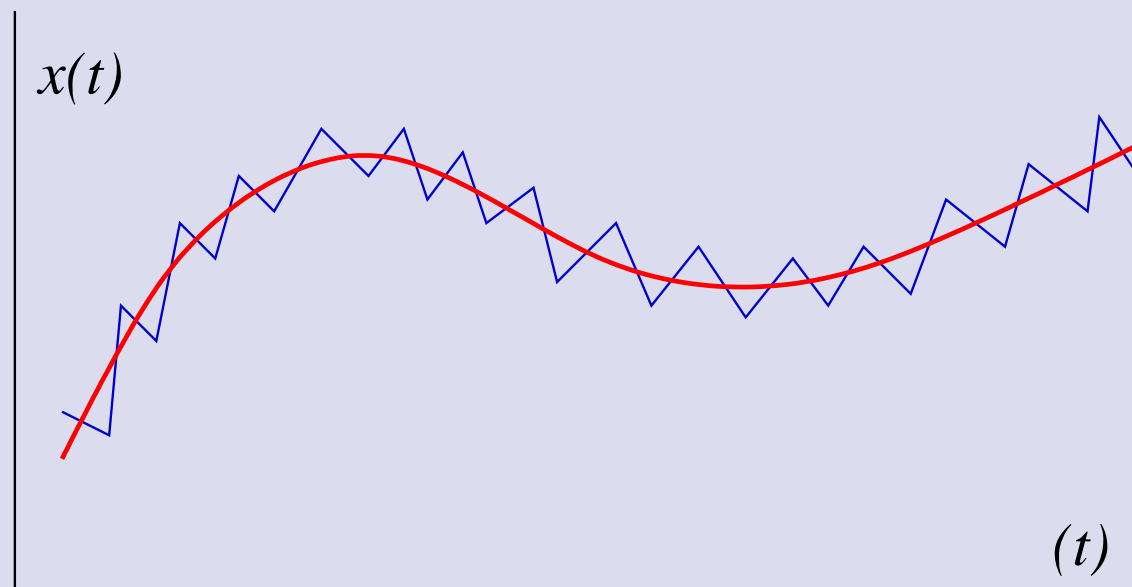

Simple, but details destroyed. Eliminates nonlinear effects.

- Sampled-data (discrete) model

$$x_{n+1} = f(x_n, \mu)$$

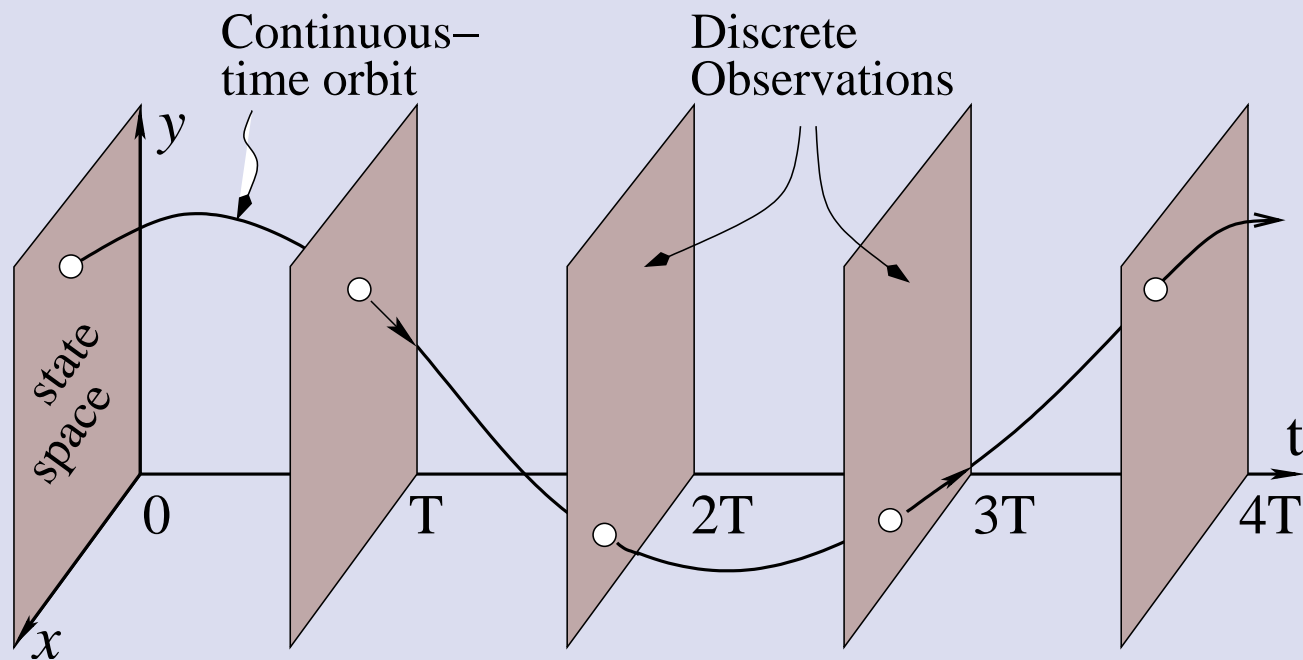

Relatively complex, but accurate. Captures nonlinearity.

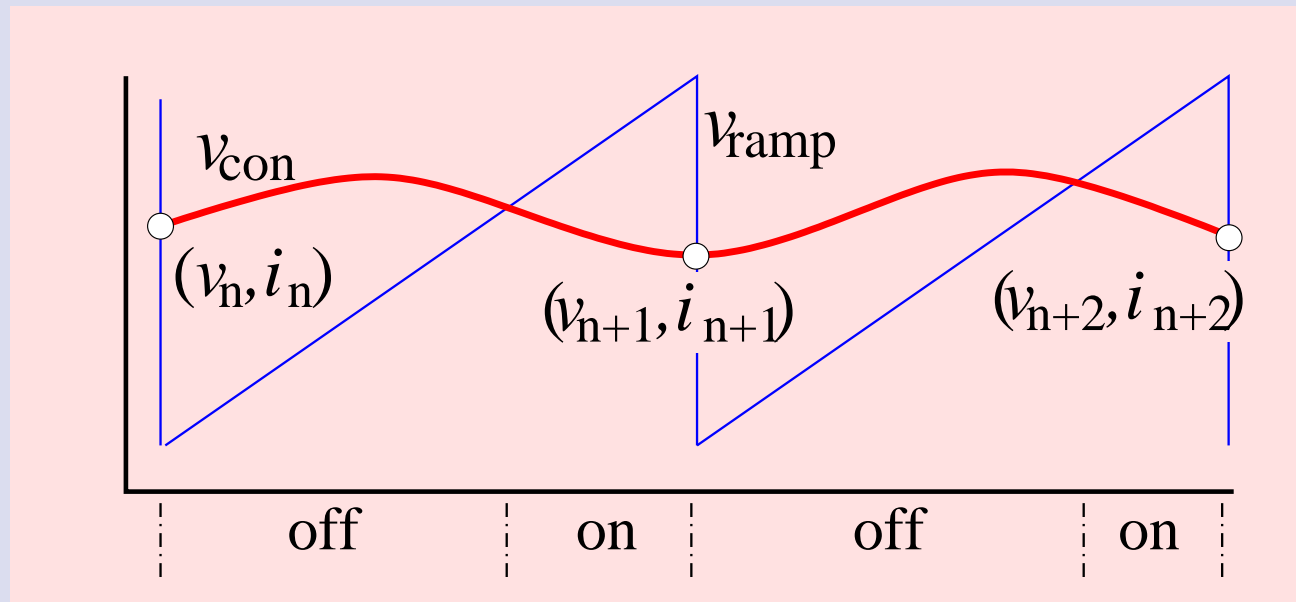

Sampled data model: $(v_n, i_n) \mapsto (v_{n+1}, i_{n+1})$

The procedure: stacking of solutions

- Start from an initial condition (x_n, y_n) at a clock instant.
- Using the on-time equation and the value of I_{ref} , obtain the length of the on-period.
- Obtain the state vector at the end of the on-period.
- Use this state vector as the initial condition in the off-time equations, and evolve for $(T - T_{\text{on}})$. This gives (x_{n+1}, y_{n+1}) at the next clock instant.

Thus we obtain the map

$$(x_{n+1}, y_{n+1}) = f(x_n, y_n)$$

Dynamics in discrete time

Iterate the map starting from any initial condition.

Obtain a sequence of points in the discrete state space.

Plot the discrete-time evolution, called the “phase-portrait”.

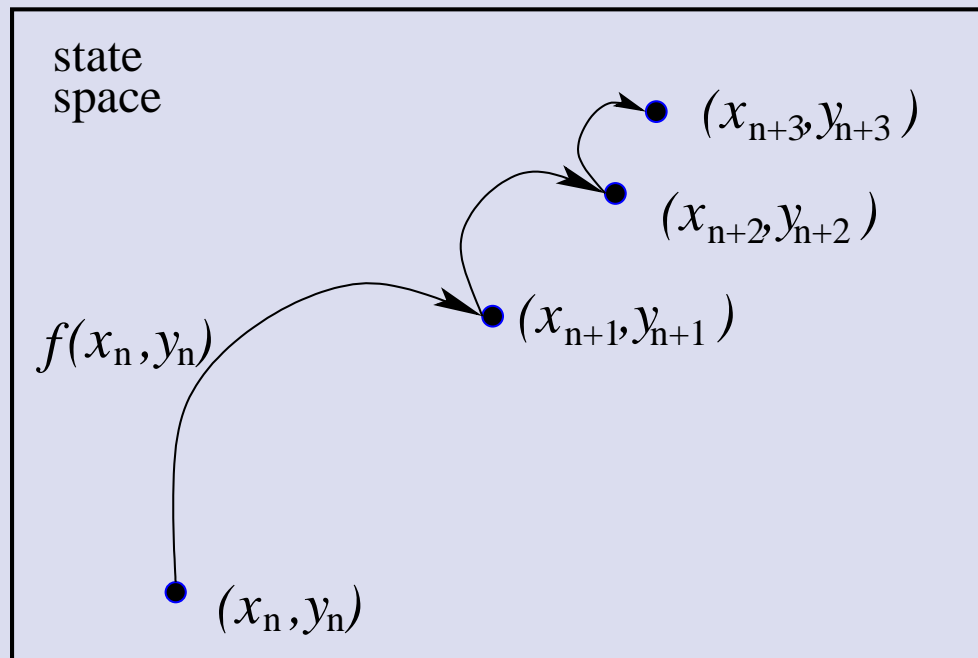

For periodic systems, after some initial transient, all the iterates fall on the same point in the discrete state space. The fixed point of the map is stable \longrightarrow **period-1 attractor**.

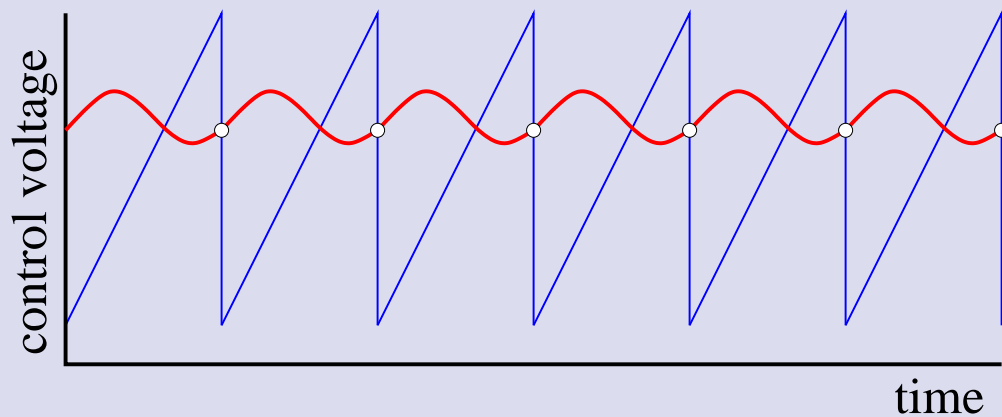

Continuous-time

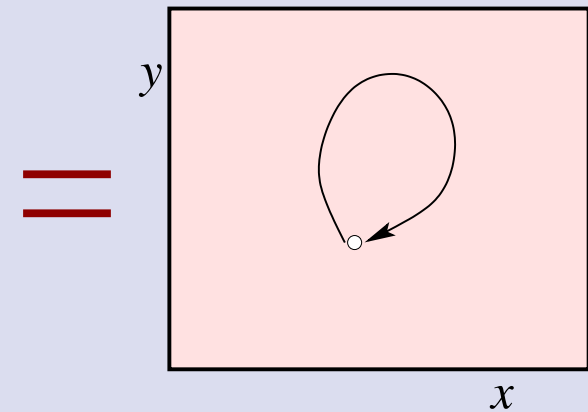

Discrete-time

If the system is period-2 (the same state repeats after 2 clocks), there will be 2 points in the discrete-time state space

→ period-2 attractor.

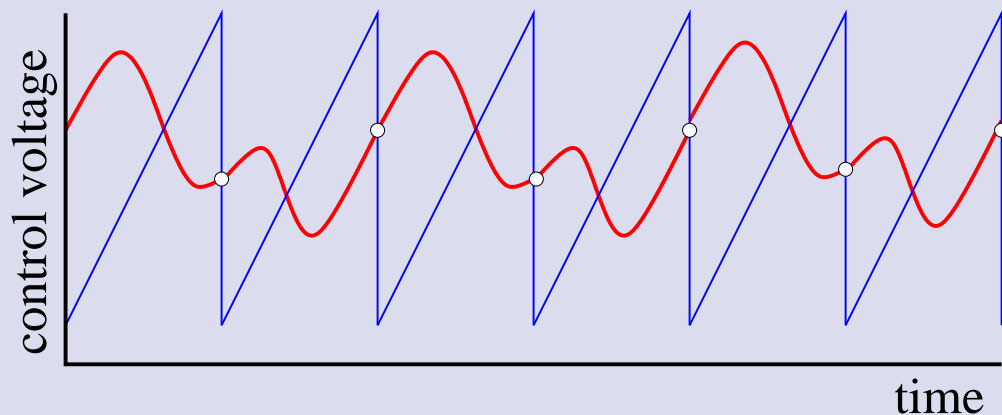

Continuous-time

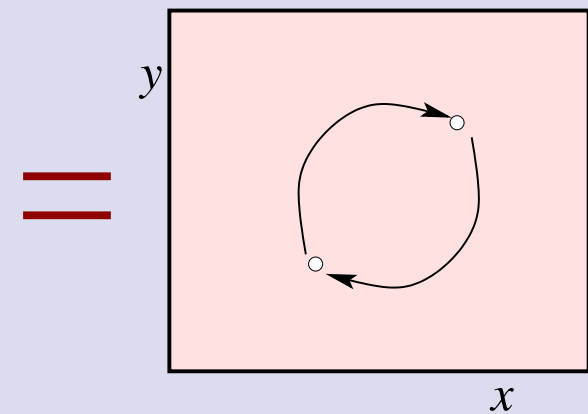

Discrete-time

If the system is period- n (the same state repeats after n clocks), there will be n points \longrightarrow **period- n attractor**.

If a system is chaotic, there will be an infinite number of points in the phase portrait. \longrightarrow **chaotic attractor**.

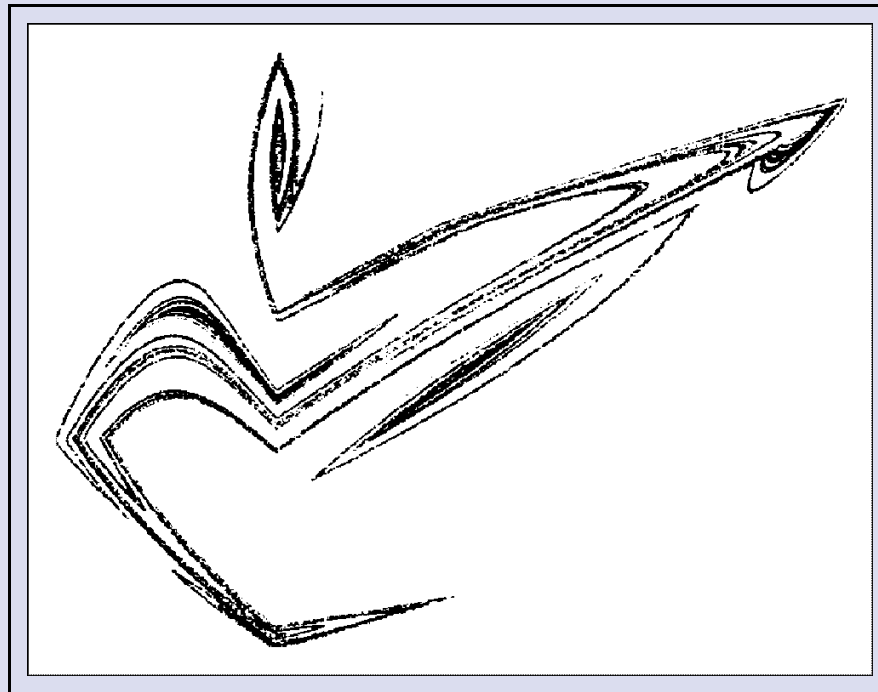

The phase portrait for the buck converter in the chaotic mode.

Question: Why, and in what ways, does the system behaviour change with the change in a parameter?

Studied through **Bifurcation diagrams**
(panoramic view of stability status).

- Sampled variable at steady state versus parameter, e.g., $i_L(nT)$ vs. R .
- Bifurcation diagrams can be plotted against the variation of any of the system parameters, e.g., V_{in} , R , I_{ref} etc.

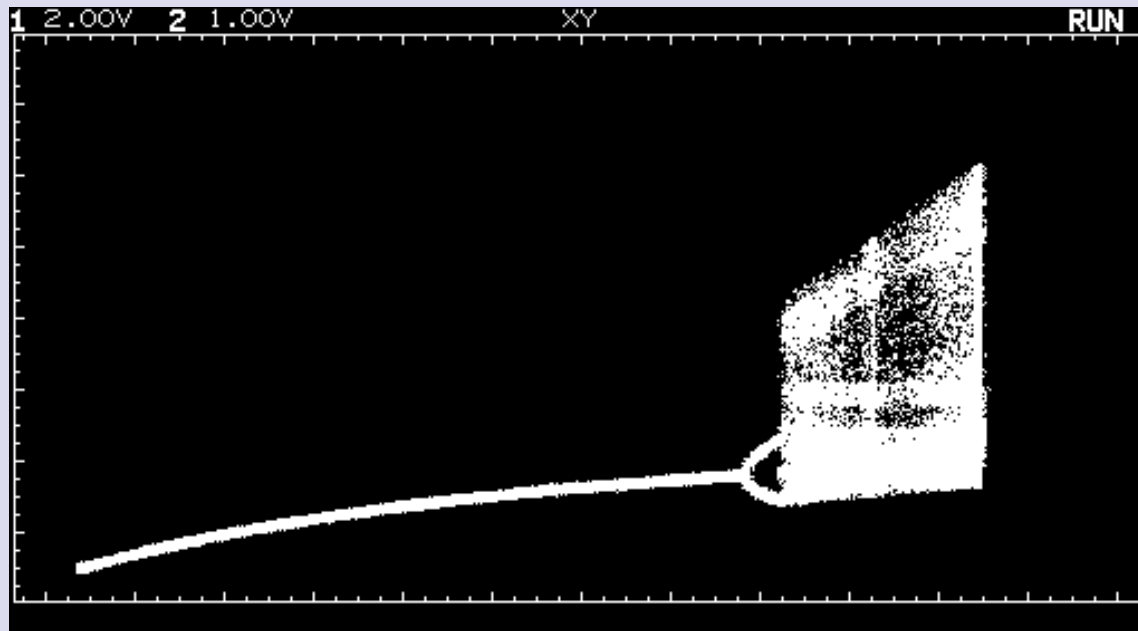

An experimental bifurcation diagram of the buck converter.

x-coordinate: input voltage V_{in} ,

y-coordinate: sampled value of the control voltage.

Parameter values are: $R = 86\Omega$, $C = 5\mu\text{F}$, $L = 2.96\text{mH}$, $V_U = 8.5\text{V}$,
 $V_L = 3.6\text{V}$, clock speed 11.14 kHz.

What is a bifurcation?

- Nothing but loss of stability.
- In a linear system, a loss of stability means the system collapses.
- In a nonlinear system, when a periodic orbit loses stability, some other orbit may become stable.
- Thus, at a specific parameter value, one may observe a qualitative change in the character of the orbit. This is a bifurcation.

Bifurcation: qualitative change in system behaviour with the change of a parameter

Study of bifurcations:

- Derive a discrete time map $x_{n+1} = f(x_n, \mu)$.
- Obtain the fixed point $x_{n+1} = x_n$.
- Examine the Jacobian at the fixed point and find the loci of the eigenvalues when a bifurcation parameter is varied.
- Identify the condition for the eigenvalue(s) moving out the unit circle in the complex plane.

Two types of bifurcation seen in power electronics

- ① **Smooth bifurcations** (found in other systems as well)
- ② **Border collision** (characteristic of power electronics)
Abrupt change of behavior due to a structural change

Structural change in switching converters = Alteration in topological sequence e.g., change of operating mode, reaching a saturation boundary.

**For voltage
mode control:**

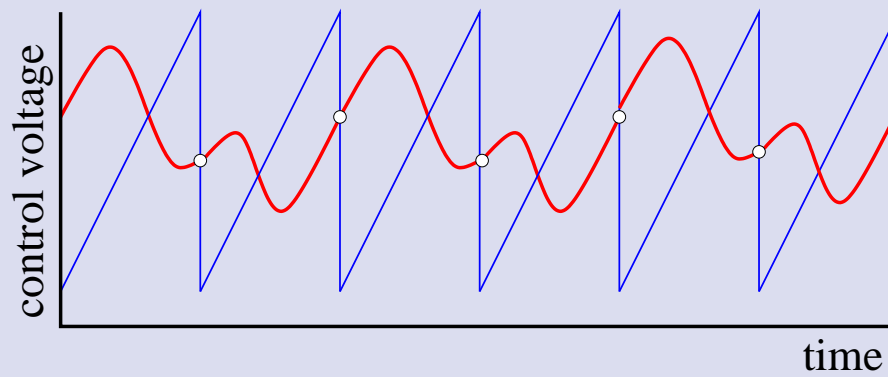
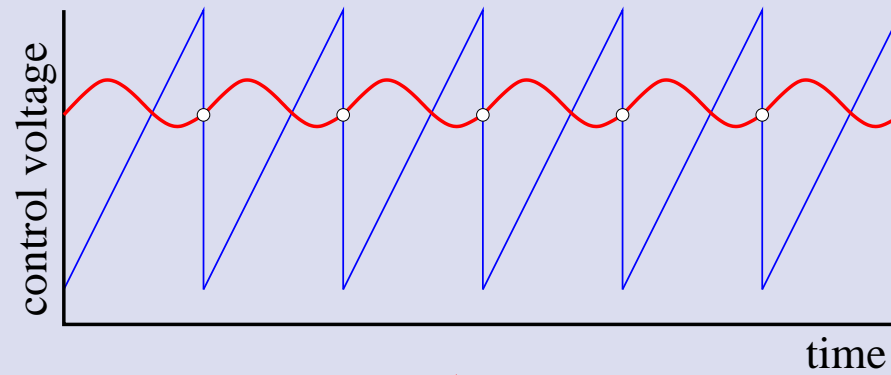

Loss of stability,
No structural change
(smooth bifurcation)

Structural change
(border collision bifurcation)

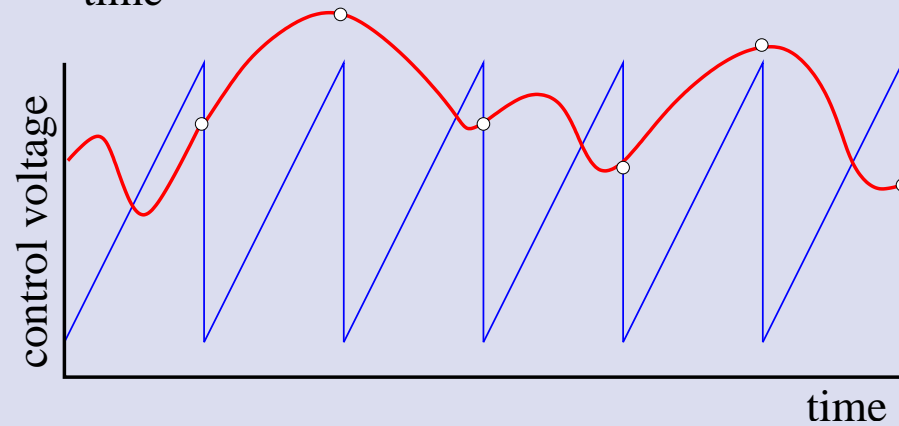

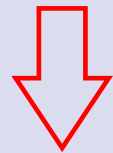
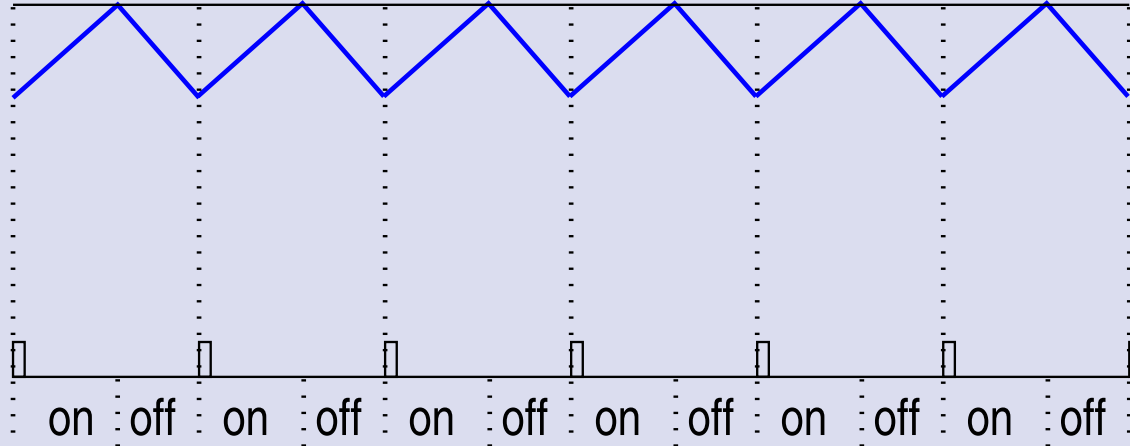

Loss of stability, No structural change
(Smooth bifurcation)

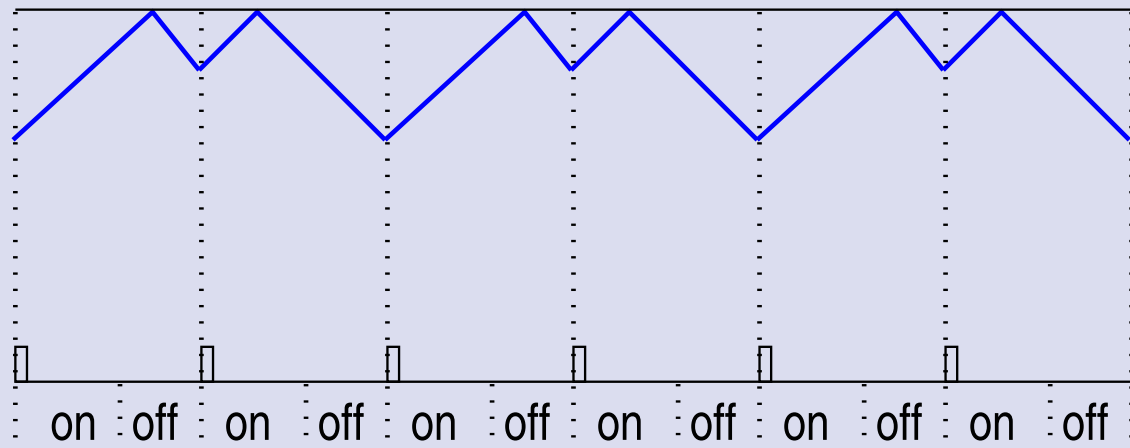

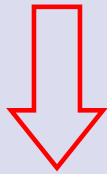
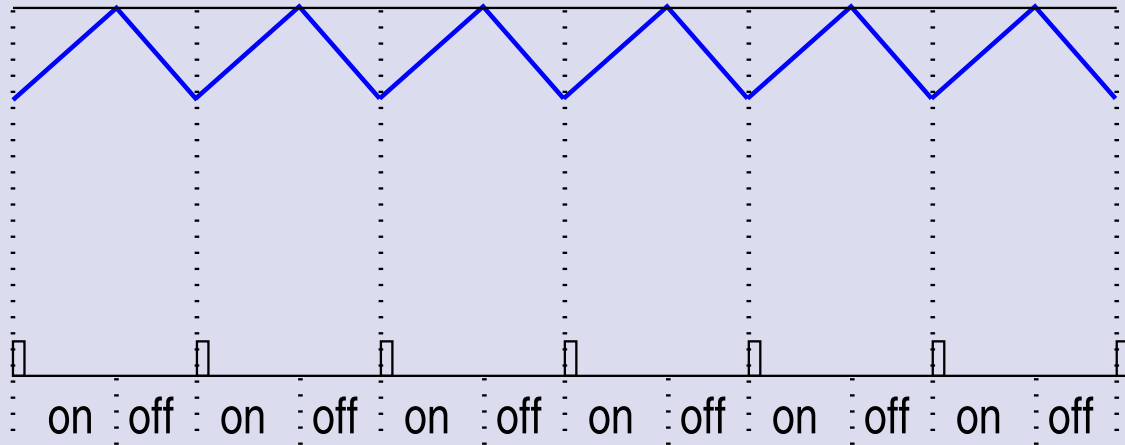

Change of topological sequence
(involves Border collision bifurcation)

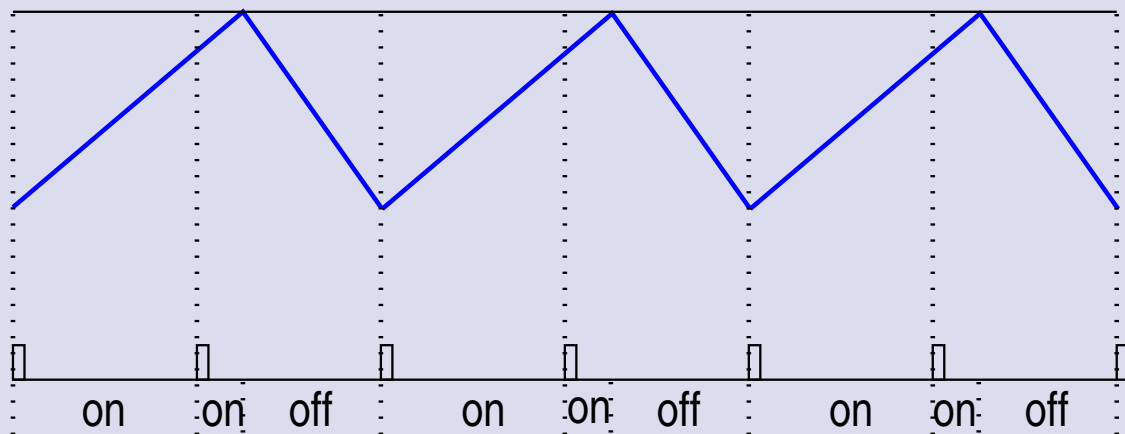

The two classes of bifurcations

Smooth bifurcations

- Loss of stability without structural change
- Standard appearance of bifurcation diagrams, e.g., period doubling cascade, periodic windows etc.

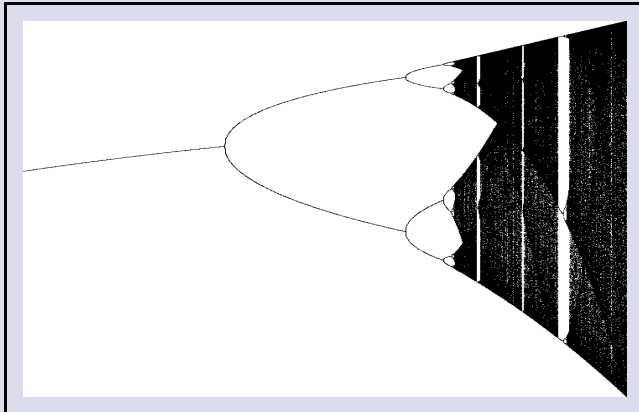

Border collision

- Loss of stability due to structural change
- Non-standard appearance in bifurcation diagrams, e.g., bendings, sudden transition to chaos.

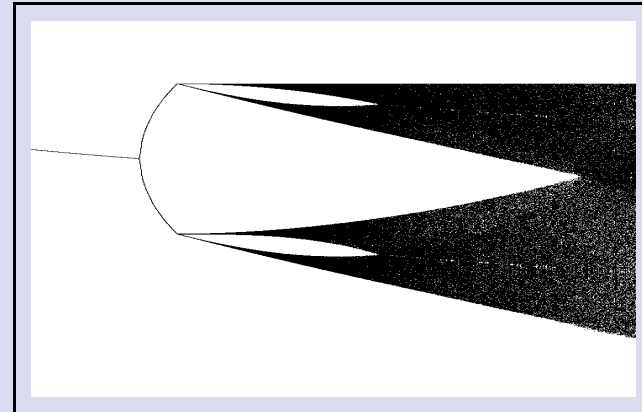

How to analyse such loss of stability of power converters?

Bifurcation theory can help.

A bifurcation occurs when a fixed point of the discrete map loses stability.

⇒ At least one eigenvalue crosses the unit circle.

If the map is smooth, there are three possibilities:

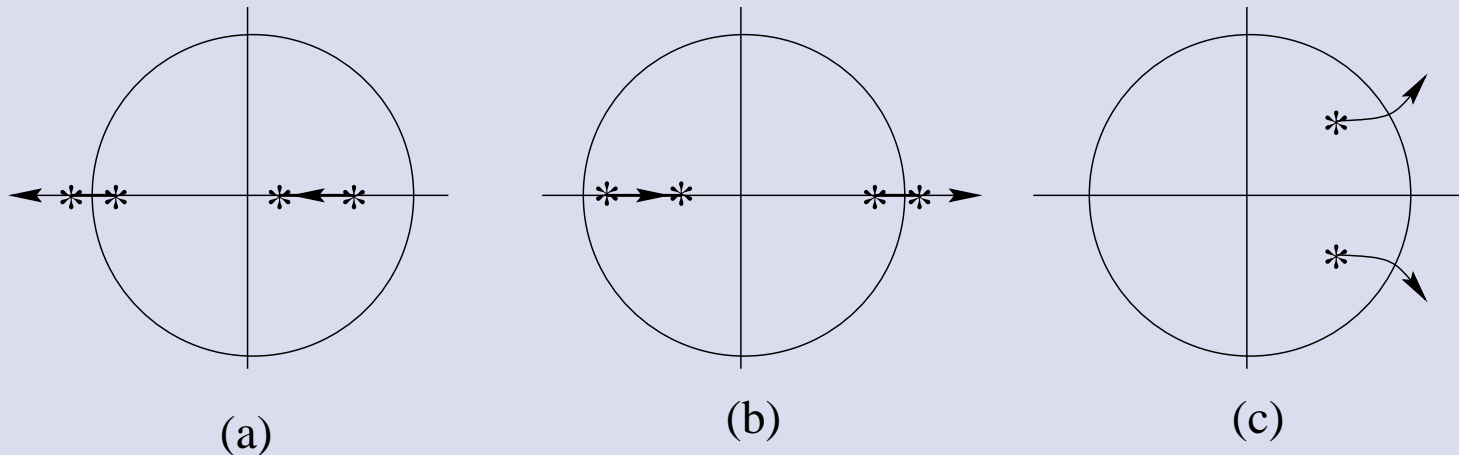

(a) **A period doubling bifurcation:**

eigenvalue crosses the unit circle on the negative real line,

(b) **A saddle-node or fold bifurcation:**

an eigenvalue touches the unit circle on the positive real line,

(c) **A Hopf or Naimark-Sacker bifurcation:**

a complex conjugate pair of eigenvalues cross the unit circle.

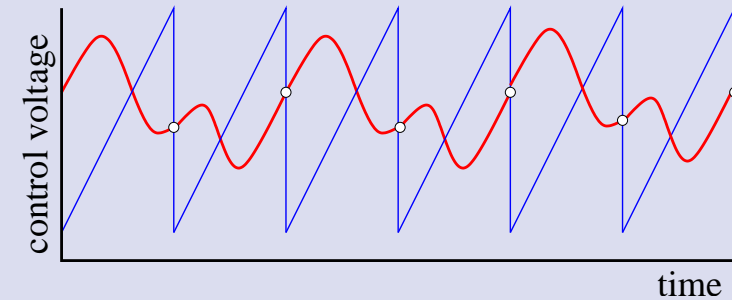
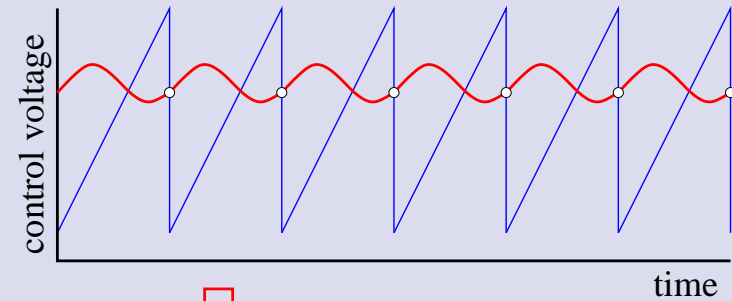
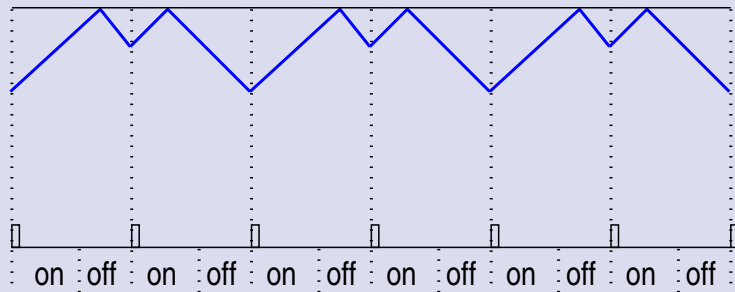
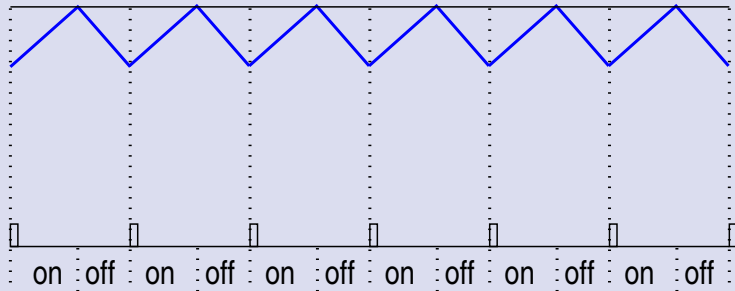

Examples of period-doubling bifurcation, associated with one eigenvalue becoming -1 .

Common in all feedback-controlled dc-dc converters.

A **saddle-node bifurcation** results in the creation of a new orbit (or the destruction of an existing orbit).

A new periodic orbit coming into being may imply

- Destruction of chaos for a range of parameters (periodic window)
- Creation of coexisting attractors (multistability).

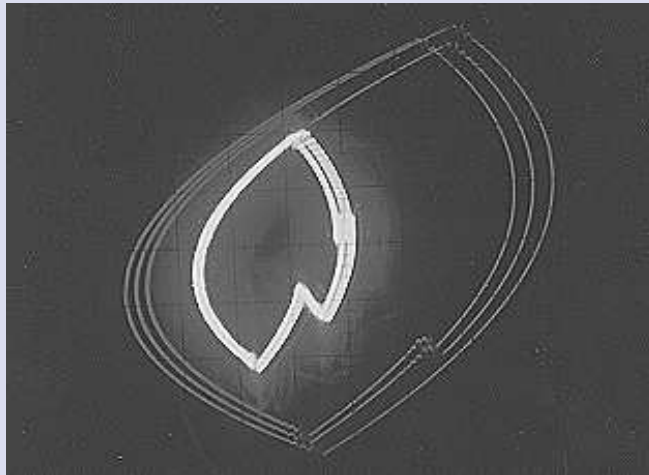

A **Naimark-Sacker bifurcation** causes a periodic orbit change into a quasiperiodic orbit.

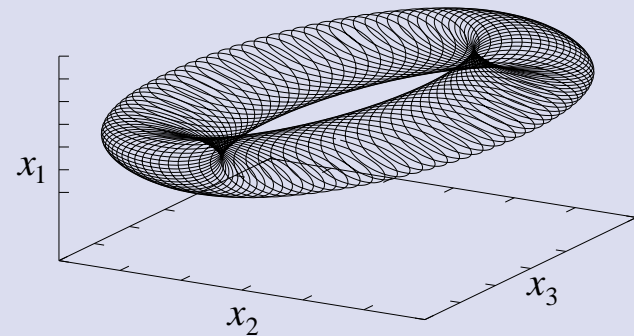
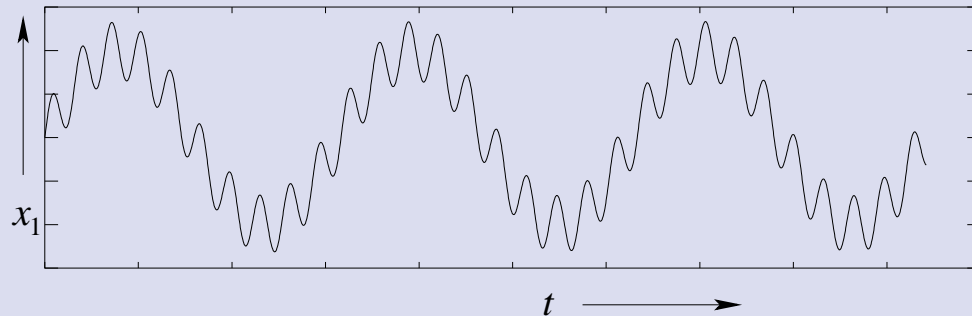

(Combination of two incommensurate frequencies.)

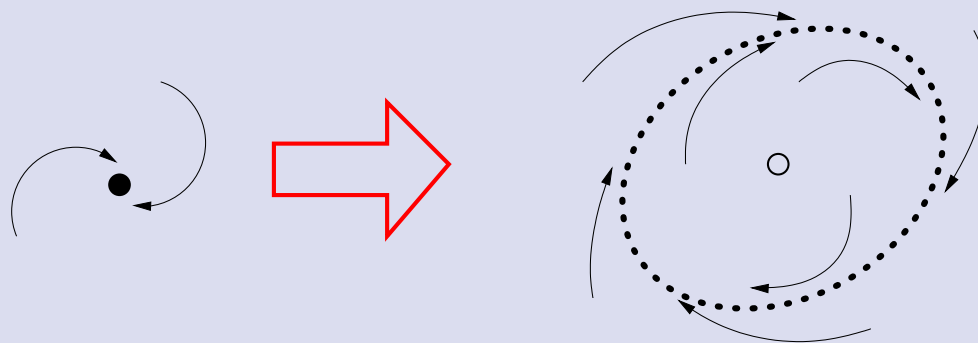

In discrete time,

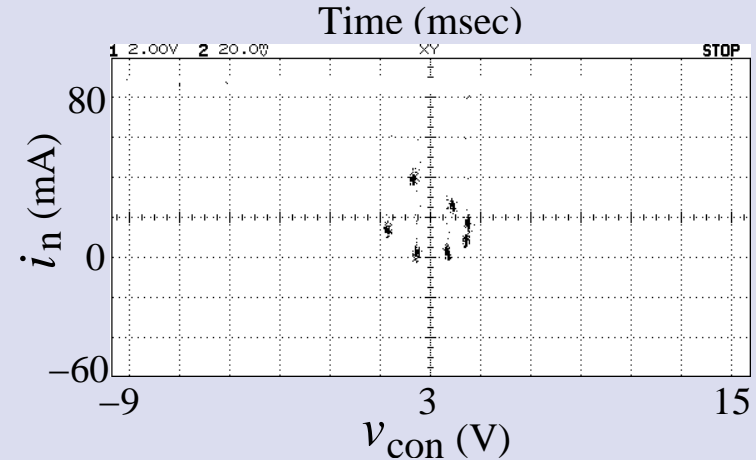
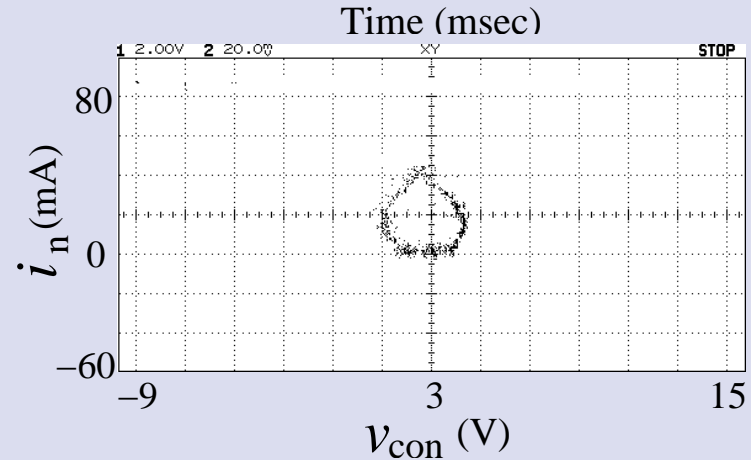
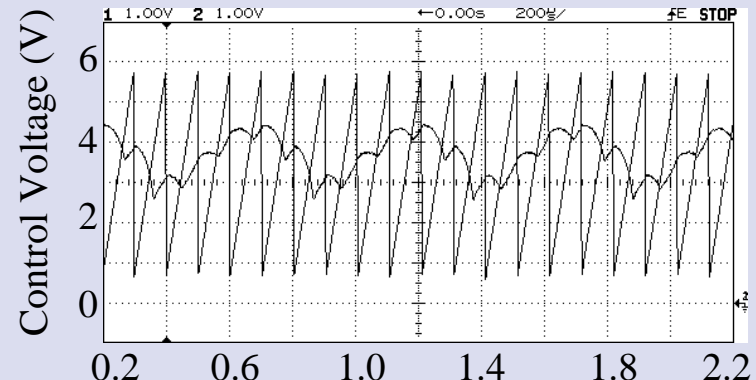
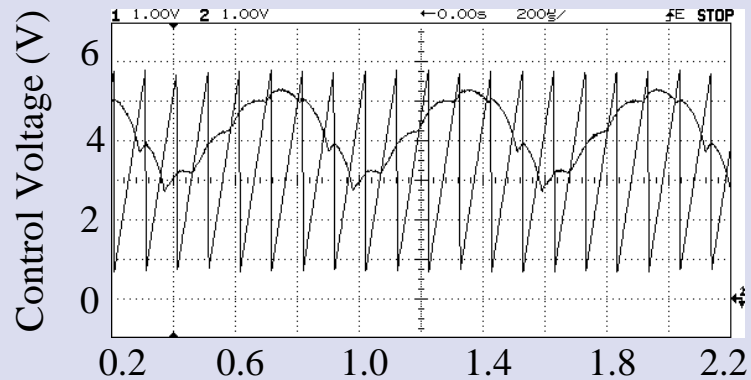

Quasiperiodic and mode-locked periodic behavior in a PWM buck converter. Slow scale instability. Can also be predicted with the averaged model.

These are the three possible ways that a converter can lose stability *without structural change*, i.e., without alteration of topological sequence.

How can we analyse the loss of stability caused by structural change?

It has been found that sampled data modeling of all power electronic circuits yield **piecewise smooth maps**.

- The discrete state space is divided into two or more compartments with different functional forms of the map.
- The compartments are separated by **borderlines**. The Jacobian changes discontinuously across the borderlines.

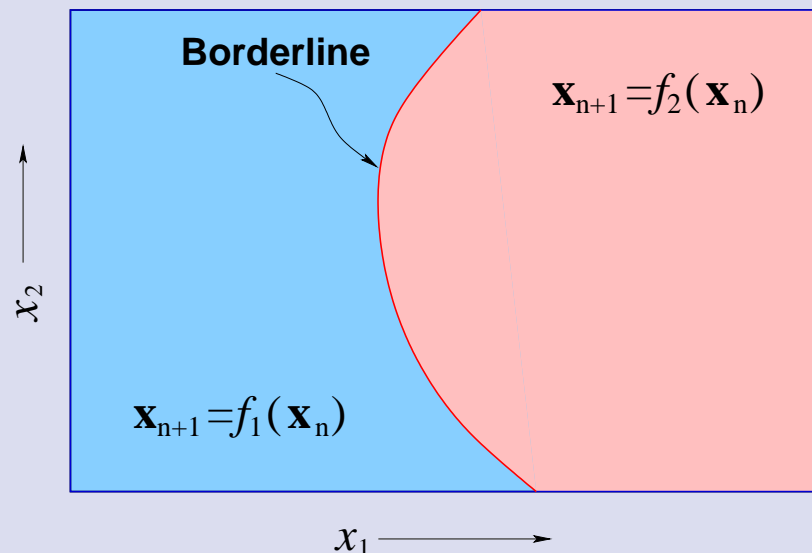

The current mode controlled boost converter

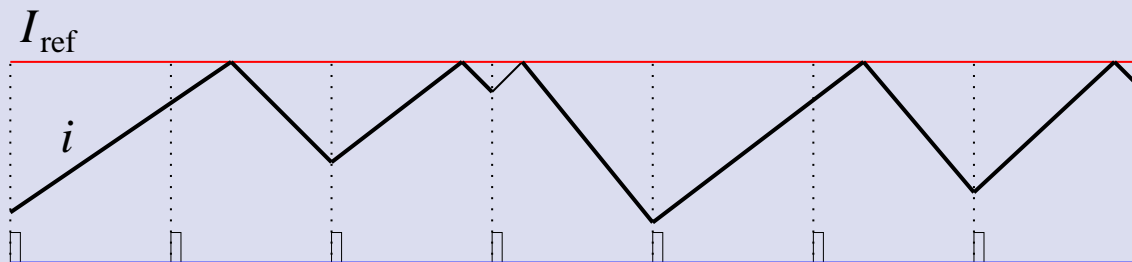
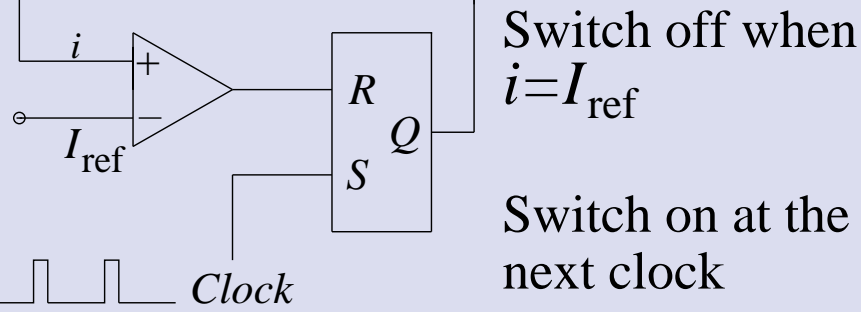
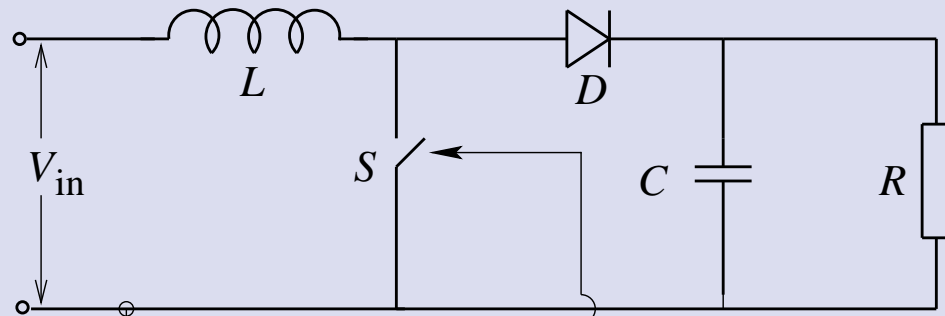

Structure of discrete state space in in current mode controlled converters

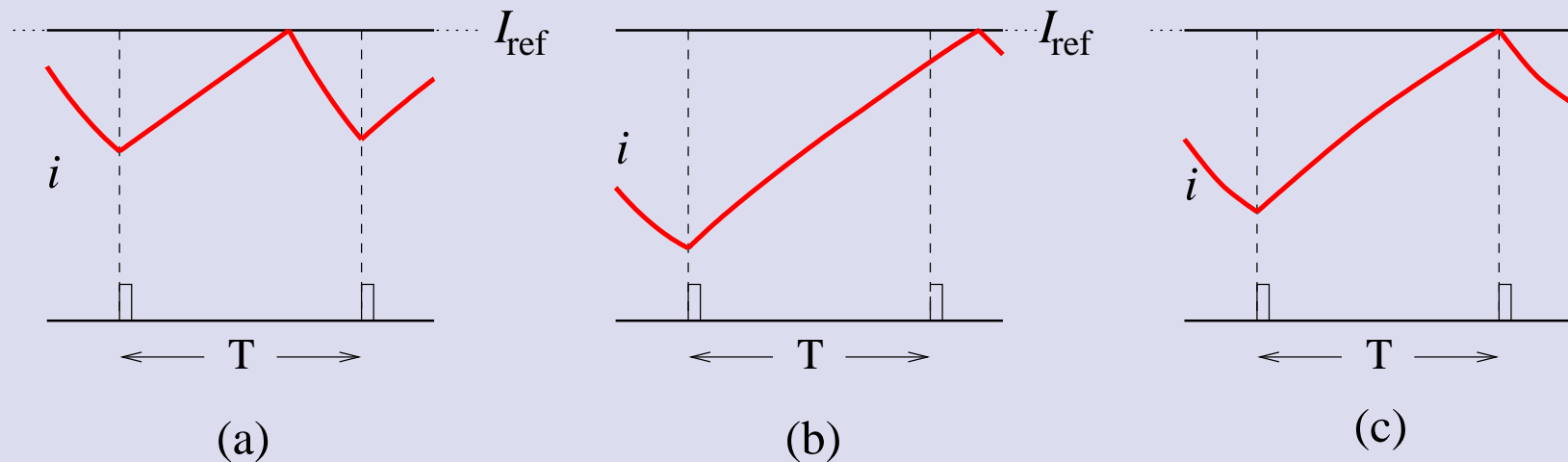

(a) and (b): The two possible types of evolution between two consecutive clock instants yielding two different functional forms in the sampled-data model and (c): the borderline case.

↳ Piecewise smooth map.

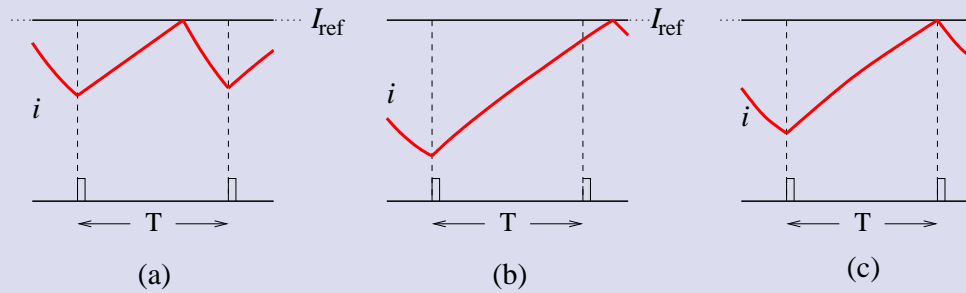

Case (a): $i_{n+1} = f_1(i_n) = \left(1 + \frac{m_2}{m_1}\right) I_{\text{ref}} - m_2 T - \frac{m_2}{m_1} i_n.$

Case (b): $i_{n+1} = f_2(i_n) = i_n + m_1 T$

Boderline: $I_b = I_{\text{ref}} - m_1 T$

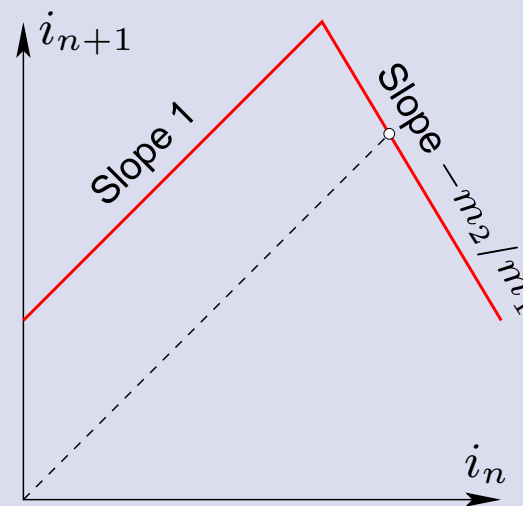

Structure of discrete state space in voltage mode controlled converters

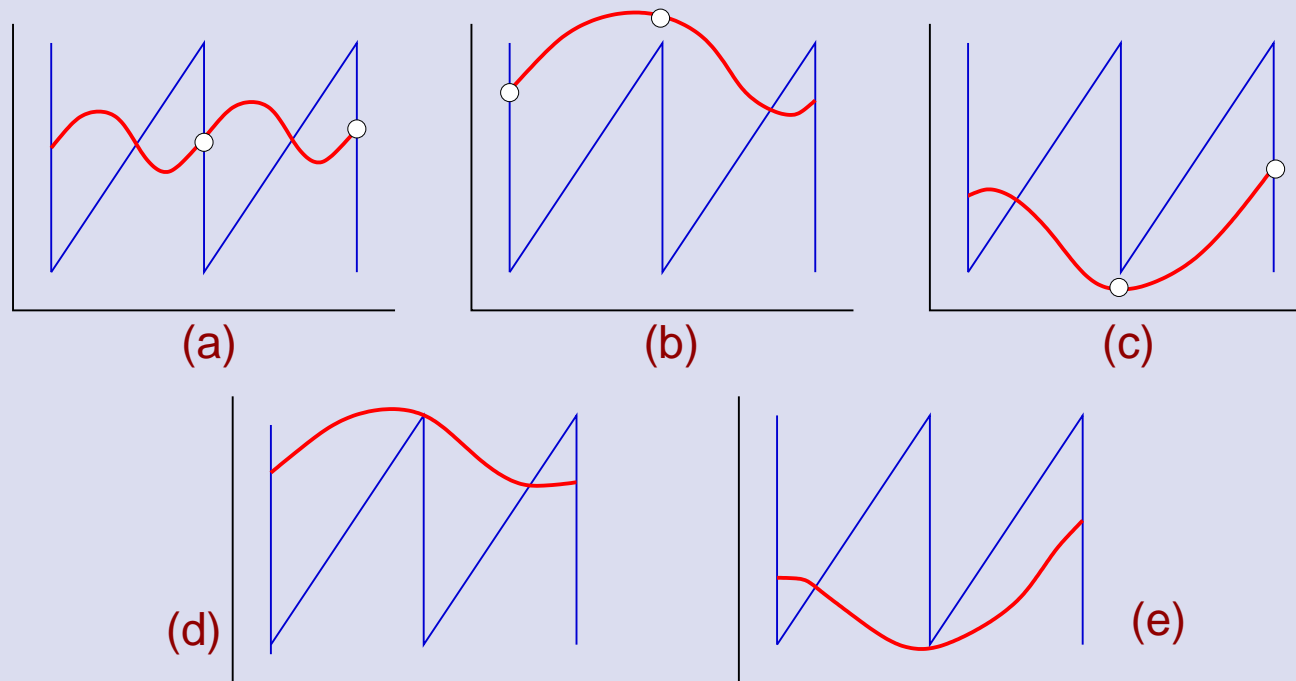

(a), (b) and (c): The three possible types of evolution between two consecutive clock instants, and (d) and (e): the “grazing” situations that create the borderlines.

⇒ Piecewise smooth map.

Dynamics of Piecewise Smooth Maps

- If a fixed point loses stability while in either side, the resulting bifurcations can be categorized under the generic classes for smooth bifurcations.
- But what if a fixed point crosses the borderline as some parameter is varied?

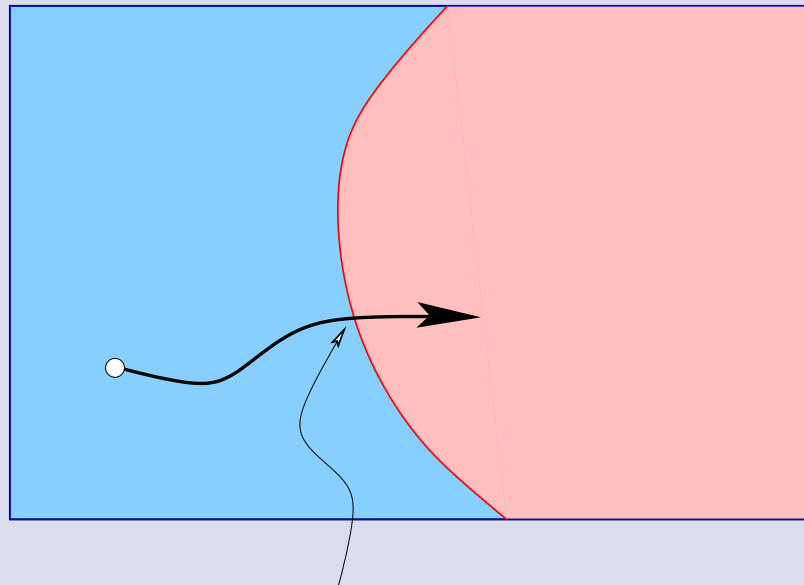

The Jacobian elements discretely change at this point

- The eigenvalues may jump from any value to any other value across the unit circle.
- The resulting bifurcations are called *Border Collision Bifurcations*.

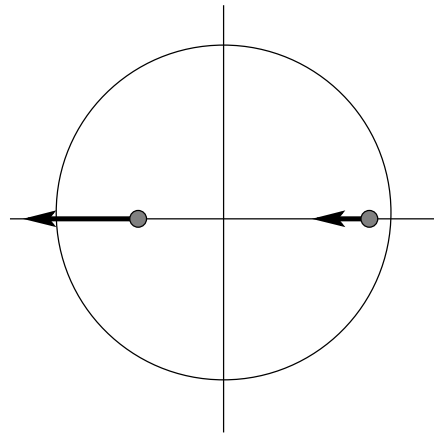

Continuous movement of eigenvalues in a smooth bifurcation

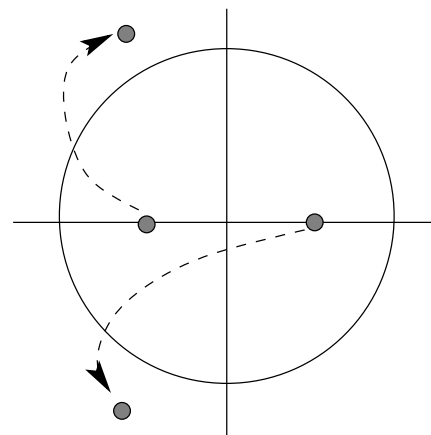

Discontinuous jump of eigenvalues in a border collision bifurcation

Theories have been developed that can predict the outcome of a border collision bifurcation (which orbit will become stable) depending on the eigenvalues of the Jacobian matrix at the two sides of the border. These transitions are usually sudden and abrupt.

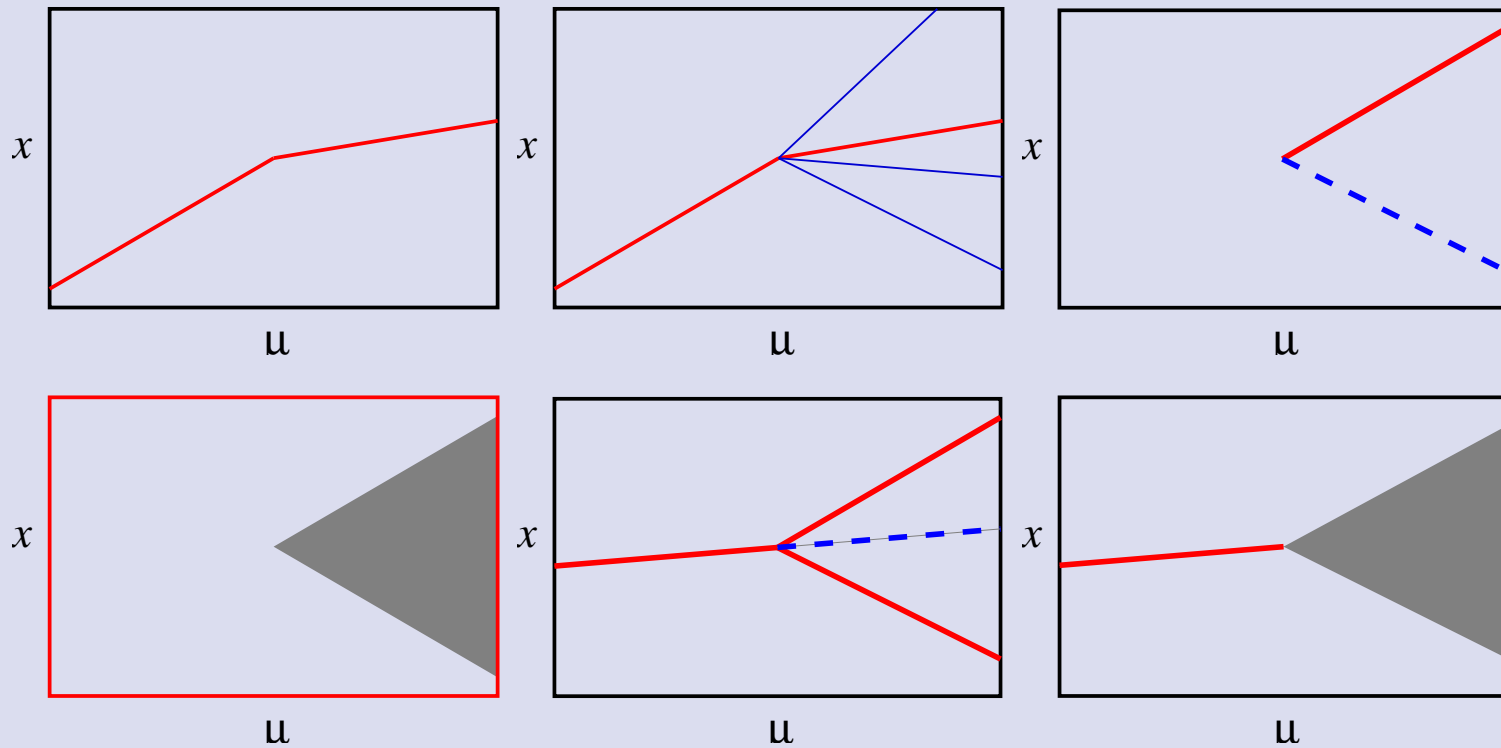

As a system parameter is varied, the change of dynamical behavior of power converters exhibit a succession of smooth and border collision bifurcations.

- Generally the first bifurcation from a normal period-1 operation is of smooth type.
- The development of a smooth bifurcation sequence (e.g., a period-doubling cascade) is interrupted by border collision bifurcations.

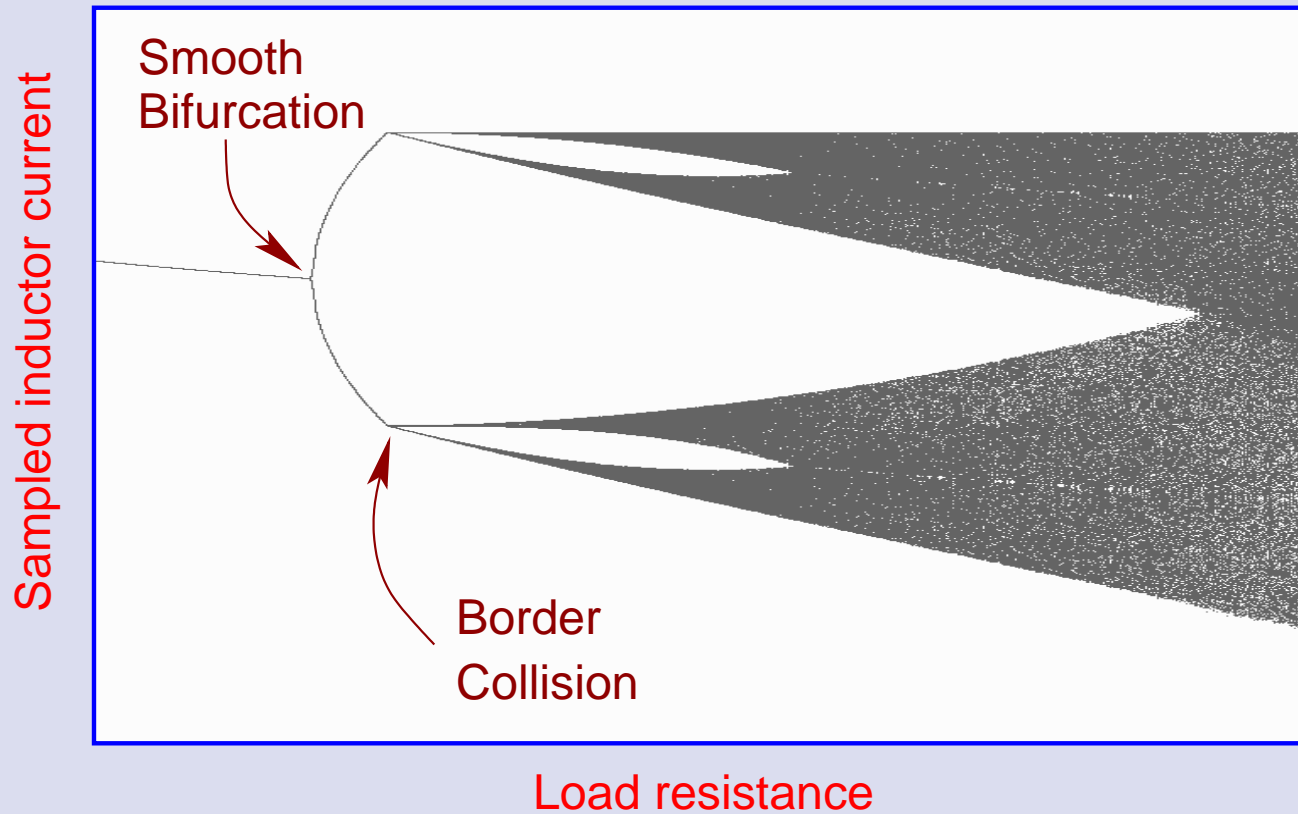

Bifurcation diagram of the boost converter with load resistance as variable parameter.

Which type of instability is likely in which converter?

1. Voltage mode controlled buck converter (PWM-2): The first bifurcation is always period doubling. Subsequently period doubling cascade interrupted by border collision, leading to direct transition to chaos. Hamill and Deane (1990,1992), Fossas and Olivar (1996), Chakrabarty and Banerjee (1996)
2. Voltage mode controlled boost converter (PWM-2): Hopf bifurcation leading to quasiperiodicity. Tse (1997)
3. Voltage mode controlled converters (PWM-1): Hopf bifurcation leading to quasiperiodic and mode-locked periodic orbits. Period doubling also occurs. El Aroudi et al. (2000), Maity and Banerjee (2007)

4. Current mode controlled boost converter: The first bifurcation is always period doubling. Subsequently period doubling cascade interrupted by border collision, leading to direct transition to chaos. Hamill and Deane (1990,1992,1995), Chakrabarty and Banerjee (1997), Chan and Tse (1997),
5. Current mode controlled Ćuk converter: Period doubling route to chaos, truncated by border collision. Tse and Chan (1995)
6. Converters operated in DCM: Period doubling. Tse (1994)
7. Converters undergoing transition from DCM to CCM: border collision bifurcation leading to quasiperiodicity. Maity and Banerjee (2007)

In many applications the operating point constantly changes with time:

- Power factor correction power supplies;
- Dc-AC inverters;
- Audio amplifiers using dc-dc converters.

Bifurcations are expected even under normal operating condition.

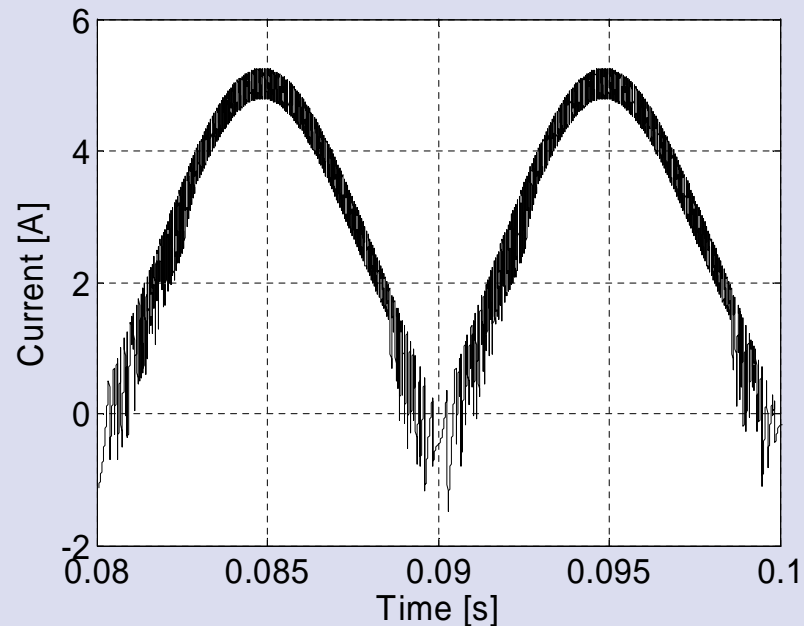

How to analyze the stability of power electronic circuits?

If the initial condition is perturbed and the solution converges back to the orbit, then the orbit is stable. The stability margin can be assessed from the rate of convergence.

Suppose the initial condition is given a perturbation $\delta x(t_0)$. If the original trajectory and the perturbed trajectory evolve for a time t ,

$$\delta x(t) = \Phi \delta x(t_0).$$

Here Φ is the state transition matrix.

The properties of Φ :

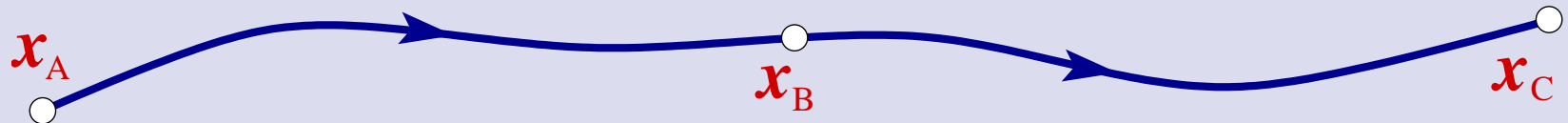

$$\text{If } \mathbf{x}_B = \Phi_{AB} \mathbf{x}_A, \quad \mathbf{x}_C = \Phi_{BC} \mathbf{x}_B$$

$$\text{then } \delta \mathbf{x}_B = \Phi_{AB} \delta \mathbf{x}_A, \quad \delta \mathbf{x}_C = \Phi_{BC} \delta \mathbf{x}_B$$

$$\text{and } \delta \mathbf{x}_C = \Phi_{AC} \delta \mathbf{x}_A, \quad \Phi_{AC} = \Phi_{BC} \Phi_{AB}$$

For LTI systems, the state transition matrix can be obtained as the matrix exponential

$$\Phi(t, t_0) = e^{\mathbf{A}(t-t_0)}$$

so that the perturbation at time t can be written as

$$\delta \mathbf{x}(t) = e^{\mathbf{A}(t-t_0)} \delta \mathbf{x}_0.$$

Suppose we are able to find the state transition matrices during the ON period and the OFF period:

$$\delta \mathbf{x}(dT) = \mathbf{A}_1 \delta \mathbf{x}(0)$$

$$\delta \mathbf{x}(T) = \mathbf{A}_2 \delta \mathbf{x}(dT)$$

The product $\mathbf{A}_2 \cdot \mathbf{A}_1$ does not give the state transition matrix over the whole cycle. One has to take into account how the perturbations change when they cross the border.

M. A. Aizerman and F. R. Gantmakher, "On the stability of periodic motions," *Journal of Applied Mathematics and Mechanics* (translated from Russian), 1958, pages 1065-1078.

$$\Delta \mathbf{x}(t_{B+}) = \mathbf{S} \Delta \mathbf{x}(t_{B-}),$$

where \mathbf{S} , the “jump matrix” or “saltation matrix”, can be expressed as

$$\mathbf{S} = \mathbf{I} + \frac{(\mathbf{f}_+ - \mathbf{f}_-) \mathbf{n}^T}{\mathbf{n}^T \mathbf{f}_- + \partial h / \partial t}.$$

\mathbf{f}_- : RHS of the differential equations before switching

\mathbf{f}_+ : RHS of the differential equations after switching

$h(\mathbf{x}, t) = 0$: the switching condition (a surface in the state space)

\mathbf{I} : the identity matrix

\mathbf{n} : the vector normal to the switching surface.

The state transition matrix over the complete clock cycle, called the *monodromy matrix* is expressed as

$$\Phi_{\text{cycle}}(T, 0) = \mathbf{S}_2 \times \Phi_{\text{off}}(T, dT) \times \mathbf{S}_1 \times \Phi_{\text{on}}(dT, 0),$$

where \mathbf{S}_1 is the saltation matrix related to the first switching event, and \mathbf{S}_2 is that related to the second switching event.

The monodromy matrix then relates the perturbation at the end of the clock period to that at the beginning:

$$\Delta \mathbf{x}(T) = \Phi(T, 0) \Delta \mathbf{x}(0).$$

The eigenvalues of the monodromy matrix are also called the Floquet multipliers. If all the eigenvalues are inside the unit circle, perturbations will die down and the system is stable.

The voltage mode controlled buck converter:

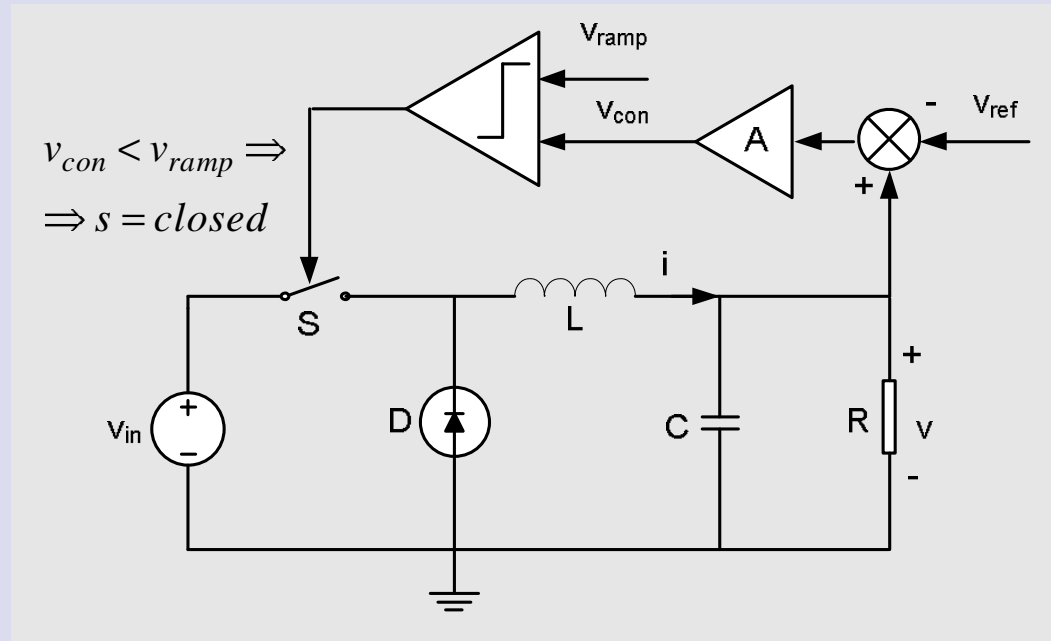

$$\frac{di(t)}{dt} = \begin{cases} \frac{v_{in} - v(t)}{L}, & \text{S is conducting} \\ -\frac{v(t)}{L}, & \text{S is blocking.} \end{cases}, \quad \frac{dv(t)}{dt} = \frac{i(t) - \frac{v(t)}{R}}{C}$$

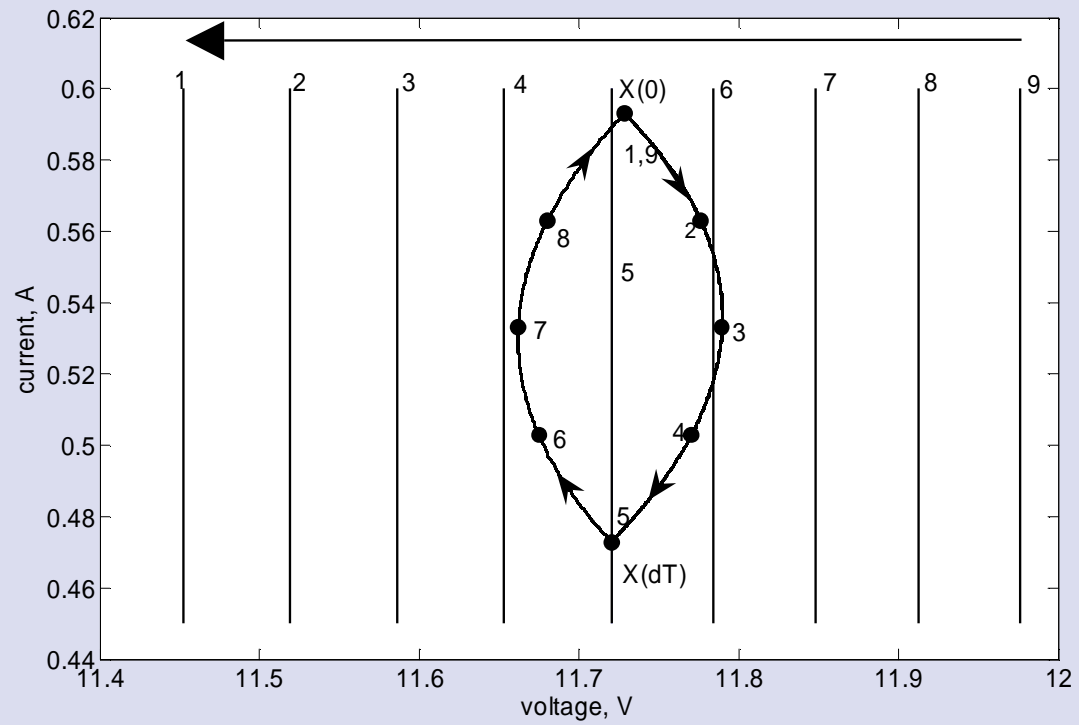
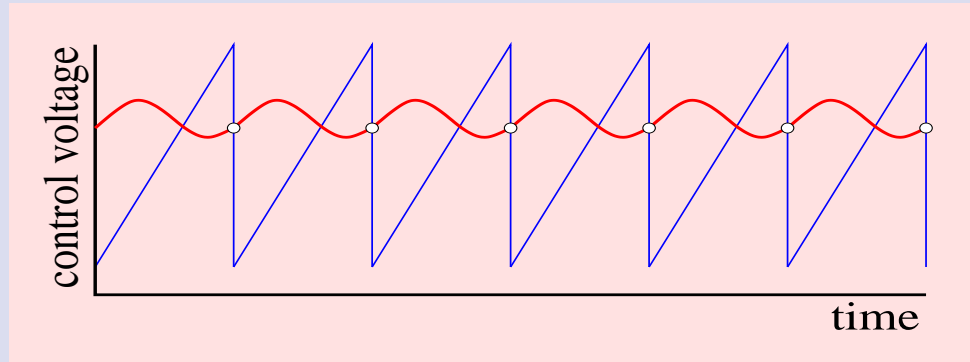

The switching hypersurface (h) is given by

$$h(\mathbf{x}(t), t) = x_1(t) - V_{\text{ref}} - \frac{v_{\text{ramp}}(t)}{A} = 0,$$
$$v_{\text{ramp}}(t) = V_L + (V_U - V_L) \left(\frac{t}{T} \bmod 1 \right)$$

The normal to the hypersurface is:

$$\mathbf{n} = \nabla h(\mathbf{x}(t), t) = \begin{bmatrix} \frac{\partial h(\mathbf{x}(t), t)}{\partial x_1(t)} \\ \frac{\partial h(\mathbf{x}(t), t)}{\partial x_2(t)} \end{bmatrix} = \begin{bmatrix} 1 \\ 0 \end{bmatrix}$$

By defining $x_1(t) = v(t)$ and $x_2(t) = i(t)$, the system equations are

$$\dot{\mathbf{x}} = \begin{cases} \mathbf{A}_s \mathbf{x} + \mathbf{B} \mathbf{u}, & A(x_1(t) - V_{\text{ref}}) < v_{\text{ramp}}(t), \\ \mathbf{A}_s \mathbf{x}, & A(x_1(t) - V_{\text{ref}}) > v_{\text{ramp}}(t). \end{cases}$$

Where,

$$\mathbf{A}_s = \begin{bmatrix} -1/RC & 1/C \\ -1/L & 0 \end{bmatrix}, \quad \mathbf{B} \mathbf{u} = \begin{bmatrix} 0 \\ 1/L \end{bmatrix} V_{\text{in}}$$

When the state goes from the off state to the on state,

$$\mathbf{f}_{p-} = \lim_{t \uparrow t_{\Sigma}} \mathbf{f}_{-}(\mathbf{x}(t)) = \begin{bmatrix} x_2(t_{\Sigma})/C - x_1(t_{\Sigma})/RC \\ -x_1(t_{\Sigma})/L \end{bmatrix},$$
$$\mathbf{f}_{p+} = \lim_{t \downarrow t_{\Sigma}} \mathbf{f}_{+}(\mathbf{x}(t)) = \begin{bmatrix} x_2(t_{\Sigma})/C - x_1(t_{\Sigma})/RC \\ (V_{\text{in}} - x_1(t_{\Sigma}))/L \end{bmatrix}.$$

where t_{Σ} is the switching instant.

Thus

$$\mathbf{f}_{p+} - \mathbf{f}_{p-} = \begin{bmatrix} 0 \\ \frac{V_{\text{in}}}{L} \end{bmatrix},$$

$$(\mathbf{f}_{p+} - \mathbf{f}_{p-}) \mathbf{n}^T = \begin{bmatrix} 0 & 0 \\ \frac{V_{\text{in}}}{L} & 0 \end{bmatrix},$$

$$\mathbf{n}^T \mathbf{f}_{p-} = \frac{x_2(t_\Sigma)}{C} - \frac{x_1(t_\Sigma)}{RC}.$$

$$\begin{aligned} \frac{\partial h(\mathbf{x}(t), t)}{\partial t} &= \frac{\partial \left(x_1(t) - V_{\text{ref}} - \frac{TV_L + (V_U - V_L)t}{AT} \right)}{\partial t} \\ &= -\frac{V_U - V_L}{AT}. \end{aligned}$$

Hence the saltation matrix is calculated as

$$\mathbf{S} = \begin{bmatrix} 1 & 0 \\ \frac{V_{\text{in}}/L}{\frac{x_2(t_\Sigma) - x_1(t_\Sigma)/R}{C} - \frac{V_U - V_L}{AT}} & 1 \end{bmatrix}$$

For a buck converter with the parameters

$$V_{\text{in}} = 24V, V_{\text{ref}} = 11.3V, L = 20mH, R = 22\Omega, C = 47\mu F, \\ A = 8.4, T = 1/2500s, V_L = 3.8V \text{ and } V_U = 8.2V$$

the switching instant was calculated to be $0.4993 \times T$.

The state at the switching instants are

$$\mathbf{x}(0) = \begin{bmatrix} 12.0222 \\ 0.6065 \end{bmatrix} \quad \text{and} \quad \mathbf{x}(d'T) = \begin{bmatrix} 12.0139 \\ 0.4861 \end{bmatrix}.$$

The saltation matrix is calculated as

$$S = \begin{bmatrix} 1 & 0 \\ -0.4639 & 1 \end{bmatrix}$$

The state matrix is

$$A_s = \begin{bmatrix} -1/RC & 1/C \\ -1/L & 0 \end{bmatrix} = \begin{bmatrix} 967.12 & 21276.6 \\ -50 & 0 \end{bmatrix}.$$

The state transition matrices for the two pieces of the orbit are:

1. Off period:

$$\Phi(d'T, 0) = e^{\mathbf{A}_s d'T} = \begin{bmatrix} 0.8058 & 3.8366 \\ -0.0090 & 0.9802 \end{bmatrix}$$

2. On period:

$$\Phi(T, d'T) = e^{\mathbf{A}_s dT} = \begin{bmatrix} 0.8052 & 3.8468 \\ -0.0090 & 0.9800 \end{bmatrix}.$$

Hence the monodromy matrix is

$$\begin{aligned}\Phi(T, 0, \mathbf{x}(0)) &= \Phi(T, d'T) \cdot \mathbf{S} \cdot \Phi(d'T, 0) \\ &= \begin{bmatrix} -0.8238 & 0.0131 \\ -0.3825 & -0.8184 \end{bmatrix}\end{aligned}$$

The eigenvalues are $-0.8211 \pm 0.0708j$ implying that at the above parameter values the system is stable.

An idea for increasing the stability margin:

$$\Phi(T, 0, \mathbf{x}(0)) = \Phi(T, d'T) \cdot \mathbf{S} \cdot \Phi(d'T, 0)$$

The state transition matrices for the ON and OFF periods are given by the parameters and the duty ratio. Set by the user's specs.

There is another handle: the saltation matrix.

$$\mathbf{S} = \mathbf{I} + \frac{(\mathbf{f}_+ - \mathbf{f}_-)\mathbf{n}^T}{\mathbf{n}^T \mathbf{f}_- + \partial h / \partial t}$$

- $\partial h / \partial t$ can be manipulated by varying the slope of the ramp.
- n^T can be manipulated by using current feedback along with voltage feedback.

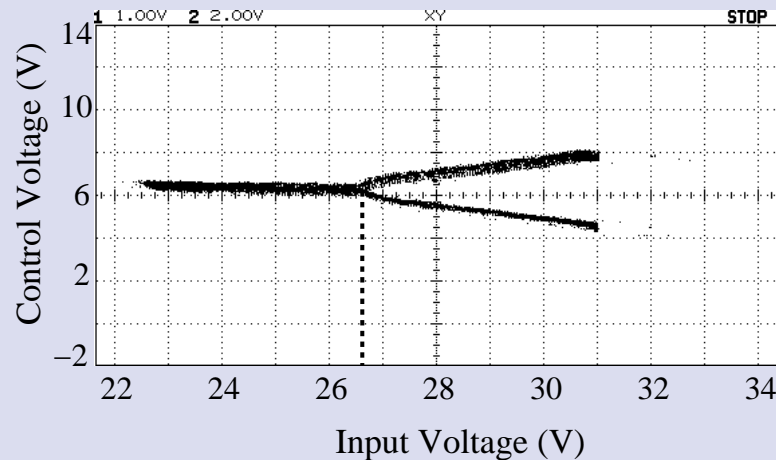

(a)

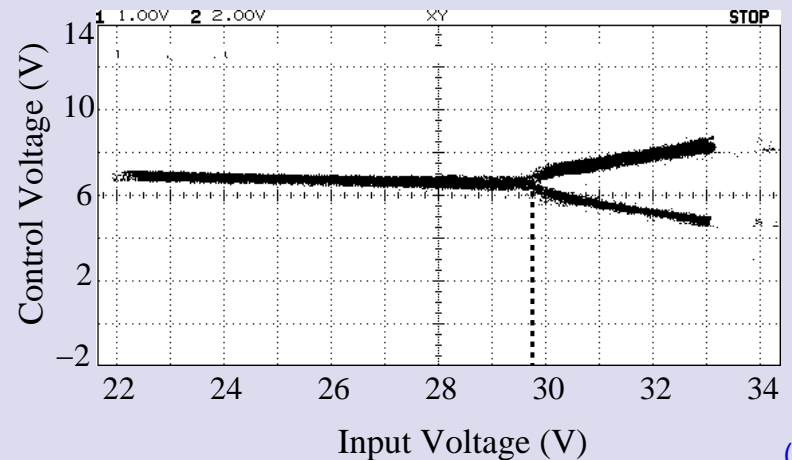

(b)

The experimentally obtained bifurcation diagrams (a) under normal PWM-2 control, and (b) when the secondary control loop is added, with $\delta V_U = 0.7$ V.

Take home message:

- All power electronic circuits are strongly nonlinear systems.
- Power converters may exhibit subharmonics and chaos for specific parameter ranges. Linear analysis does not predict these instabilities.
- Smooth as well as nonsmooth (or border collision) bifurcations occur in such converters.
- To analyse the smooth bifurcations, one has to obtain the eigenvalues of the monodromy matrix. To analyse the border collision bifurcations, one has to obtain the eigenvalues of the same periodic orbit before and after border collision.
- Bifurcation theory helps in delimiting the parameter space and in devising better controllers to avoid instability,.

For further reading:

1. Soumitro Banerjee and George C. Verghese, (Editors) *“Nonlinear Phenomena in Power Electronics: Attractors, Bifurcations, Chaos, and Nonlinear Control”*, IEEE Press, 2001.
2. C. K. Tse, *“Complex Behavior of Switching Power Converters,”* CRC Press, USA, 2003.
3. Z. T. Zhusubaliyev and E. Mosekilde, *“Bifurcations and Chaos in Piecewise-Smooth Dynamical Systems”*, World Scientific, Singapur, 2003.

THANK YOU