

NOVEL BAND-PASS SUBSTRATE INTEGRATED WAVEGUIDE (SIW) FILTER BASED ON COMPLEMENTARY SPLIT RING RESONATORS (CSRRS)

X.-C. Zhang, Z.-Y. Yu, and J. Xu

Institute of Applied Physics
University of Electronic Science and Technology of China
Chengdu 610054, China

Abstract—A novel band-pass Substrate Integrated Waveguide (SIW) filter based on Complementary Split ring Resonators (CSRRs) is presented in this work. Three different CSRrs cells are etched in the top plane of the SIW for transmission zero control. A demonstration band-pass filter is designed, fabricated and measured. It agreed with the simulated results well.

1. INTRODUCTION

Very recently, Complementary split ring resonators (CSSRs) (see Fig. 1) elements have been proposed for the synthesis of negative permittivity and left-handed (LH) metamaterials in planar configuration [2–4]. As explained in [2], CSRrs are the dual counterparts of split ring resonators (SRRs), also depicted in Fig. 1, which were proposed by pendry in 1999 [1]. It has been demonstrated that CSRrs etched in the ground plane or in the conductor strip of planar transmission media (microstrip or CPW) provide a negative effective permittivity to the structure, and signal propagation is precluded (stopband behavior) in the vicinity of their resonant frequency [2]. CSSRs have been applied to the design of compact band-pass filters with high performance and controllable characteristics [5, 6].

Recently, a new concept “Substrate Integrated Waveguide (SIW)” has already attracted much interest in the design of microwave and millimeter-wave integrated circuits. The SIW is synthesized by placing two rows of metallic via-holes in a substrate. The field distribution in an SIW is similar to that in a conventional rectangular waveguide. Hence, it takes the advantages of low cost, high Q-factor etc., and can

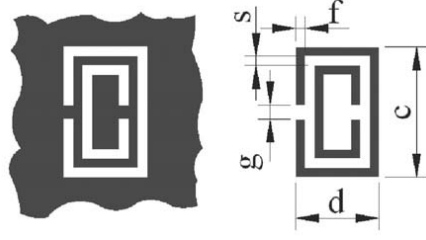

Figure 1. Geometries of the CSRRs and the SRRs, grey zones represent the metallization.

easily be integrated into microwave and millimeter wave integrated circuits. This technology is also feasible for waveguides in low-temperature co-fired ceramic (LTCC) [8]. The SIW components such as filter, multiplexers, and power dividers have been studied by researchers in [8–11].

In this paper, a band-pass SIW filter based on CSRRs is proposed for the first time. The filter is consisted of the input and output coupling line with the CSRRs loaded SIW. Using the high-pass characteristic of SIW and band-stop characteristic of CSSRs, a band-pass SIW filter is designed and fabricated. The plane taper transition can successfully transform microstrip energy to the SIW. The filter is integrated in a standard printed circuit board (PCB).

2. FILTER DESIGN

2.1. Substrate Integrated Waveguide

The SIW features high-pass characteristics, it was demonstrated in [5] that a TE_{10} -like mode in the SIW has dispersion characteristics that are almost identical with the mode of a dielectric filled rectangular waveguide with an equivalent width. This equivalent width is the effective width of the SIW, namely, (see Fig. 2) can be approximated as follows:

$$a_{eqv} = a - \frac{d^2}{0.95 \cdot b} \quad (1)$$

Then, the cutoff frequency for the SIW can be defined as $f_c = (c/2\epsilon_r \cdot a_{eqv})$, in which C is the light velocity in vacuum. Based on this property, existing design techniques for rectangular waveguide can be used in a straightforward way to analyze and design various components just knowing a_{eqv} of the SIW. In this case, the SIW geometry size can be initially designed by (1).

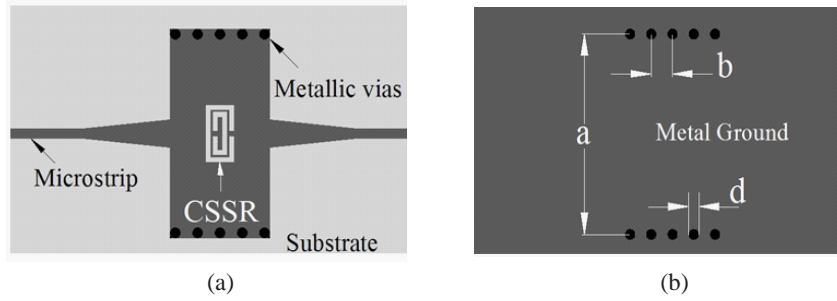

Figure 2. Layout of a SIW with CSSR etched in the top substrate side, (a) top layer, (b) bottom layer.

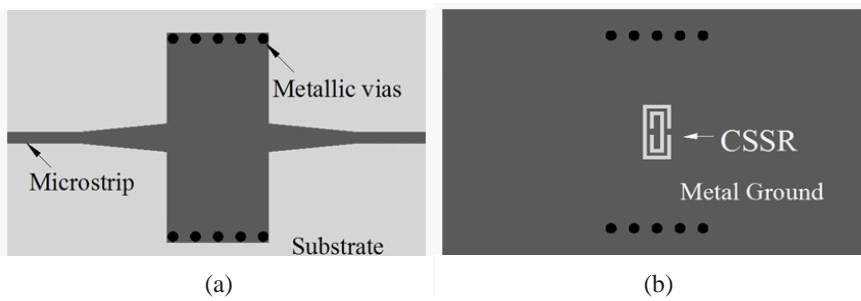

Figure 3. Layout of a SIW with CSSR etched in the bottom substrate side, (a) top layer, (b) bottom layer.

2.2. CSSR Loaded SIW

Figure 2 shows the Layout of a SIW with CSSRs etched in the top substrate. Fig. 3 shows the Layout of a SIW with CSSRs etched in the bottom substrate. Let us now analyze the CSSRs loaded SIW. Since CSSRs are etched in centre of the top layer or bottom layer, and they are mainly excited by the electric field induced by the SIW (as for TE_{10} mode), this coupling can be modeled by connecting the SIW capacitance to the CSSRs. According to this, the proposed lumped-element equivalent circuit for the CSSR loaded SIW is that depicted in Fig. 4. As long as the electrical size of the CSSRs is small, the structures can be described by means of lumped elements. In these models, L is the SIW inductance, C is the coupling capacitance between the SIW and the CSSR. The resonator is described by means of a parallel tank [12], L_c and C_c being the reactive elements and R accounting for losses. In view of this model, the transmission zero

frequency which nulls the shunt impedance is defined as:

$$f_z = \frac{1}{2\pi\sqrt{L_s(C_s + C)}} \quad (2)$$

In order to demonstrate the viability of the proposed technique, we have applied it to the determination of the electrical parameters of the single cell CSSRs loaded SIW. Both structures of Fig. 2 and Fig. 3 have been simulated on RT/Duroid 5880 substrate (dielectric constant $\epsilon_r = 2.22$, thickness $h = 0.254$ mm and $\tan \delta = 0.002$). CSSRs dimensions are $c = 4$ mm, $d = 2$ mm, $f = 0.3$ mm, $s = 0.2$ mm and $g = 0.4$ mm, and SIW dimensions are $a = 14$ mm, $d = 0.8$ mm and $b = 1.6$ mm, respectively. The width of the access lines is 0.76 mm. The simulated (using CST Microwave Studio) S-parameters of Fig. 2 and Fig. 3 are shown in Fig. 5. It can be clearly found that these structures exhibit similar characteristics except Fig. 2 has higher stop-band attenuation than Fig. 3.

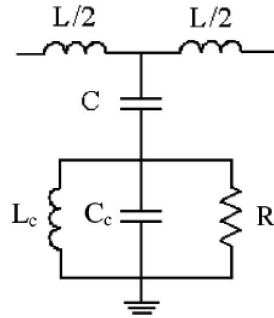

Figure 4. The depicted equivalent circuit models of Fig. 2 and Fig. 3.

2.3. SIW-CSSRs Band-pass Filter

If we alter the geometry parameters of CSRRs cell by decreasing the dimension, f_z of the CSRRs cell increase dramatically. Therefore, appropriately choosing geometry dimensions of CSRRs cell, f_z of the transmission response could be tuned into an arbitrary frequency range. For example, to implement a stop-band from 9.5 to 11 GHz by three transmission zeros, three CSSRs cells are needed to generate these transmission zeros at the frequencies 9.55 GHz, 10.17, and 10.85 GHz respectively. In addition, the dimensions of the CSSRs cells are adjusted individually according to the above transmission zeros frequencies.

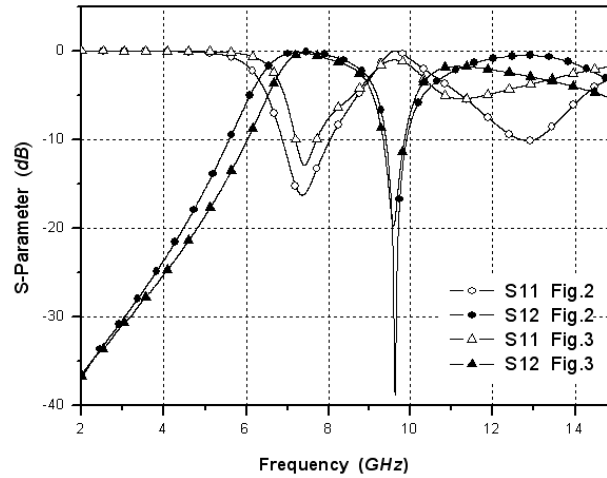

Figure 5. Simulate frequency response corresponding to the basic cell of Fig. 2 (thin line) and Fig. 3 (thick line).

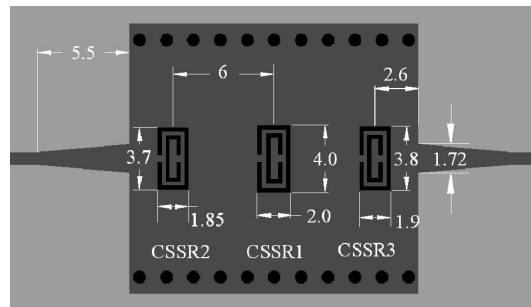

Figure 6. Configuration for the proposed SIW Filter (unit: mm), $d = 2$ mm, $s = 0.2$ mm, $g = 0.4$ mm, $a = 14$ mm, $d = 0.8$ mm and $b = 1.6$ mm.

3. FABRICATION AND MEASUREMENTS

Figure 7 shows the photograph of the SIW-CSSRs band-pass filter. The substrate used in the filter is RT/Duroid 5880 which has permittivity of 2.22, height of 0.254 mm. The optimized geometry parameters are shown in Fig. 6. Fig. 7 shows the Photograph of the proposed band-pass filter. The simulation and measurement results of the filter are plotted in Fig. 8. The filter is designed with bandwidth of 23% (7.2 GHz–9.1 GHz), the insertion loss of about 0.3 dB, and the return loss of about 20 dB at 12 GHz. The measured insertion and return

losses are about 2.16 dB and 11.6 dB at pass-band. The filter shows a broad-bandwidth, but is well agreed with the simulation data, except the return loss.

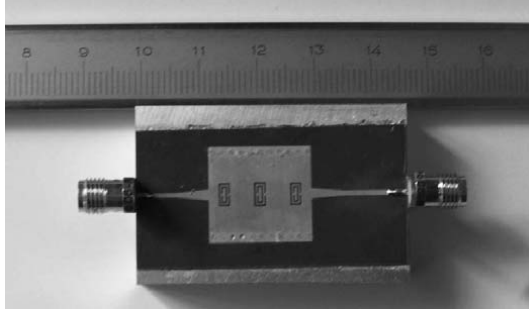

Figure 7. Photograph of the proposed BPF.

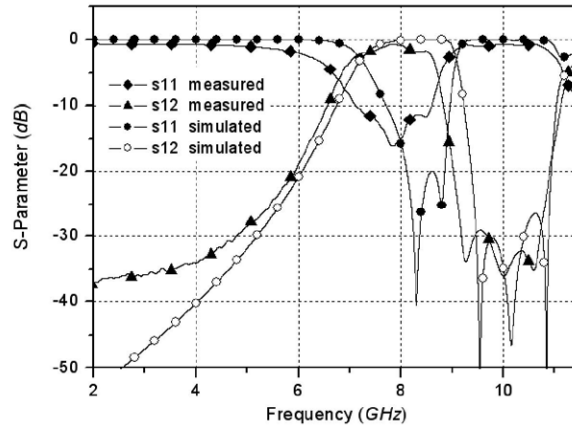

Figure 8. The measured results compared with full-wave simulation results for the proposed filter.

4. CONCLUSION

A novel band-pass substrate integrated waveguide (SIW) filter based on CSRWs is proposed. This filter is very suitable for application in low cost and compact size microwave and millimeter wave planar circuits by mature PCB technology. Experimental filter has been built and measured. Measured results are in good agreement with computed results.

REFERENCES

1. Pendry, J. B., A. J. Holden, D. J. Robbins, and W. J. Stewart, "Magnetism from conductors and enhanced nonlinear phenomena," *IEEE Trans. Microw. Theory Tech.*, Vol. 47, No. 11, Nov. 1999.
2. Falcone, F., T. Lopetegi, J. D. Baena, R. Marqués, F. Martín, and M. Sorolla, "Effective negative- ϵ stop-band microstrip lines based on complementary split ring resonators," *IEEE Microw. Wireless Compon. Lett.*, Vol. 14, No. 6, 280–282, Jun. 2004.
3. Burokur, S. N., M. Latrach, and S. Toutain, "Analysis and design of waveguides loaded with split-ring resonators," *Journal of Electromagnetic Waves and Applications*, Vol. 19, No. 11, 1407–1421, 2005.
4. Xu, W., L. W. Li, H. Y. Yao, T. S. Yeo, and Q. Wu, "Lefthanded material effects on waves modes and resonant frequencies: filled waveguide structures and substrate-loaded patch antennas," *Journal of Electromagnetic Waves and Applications*, Vol. 19, No. 15, 2033–2047, 2005.
5. Bonache, J., I. Gil, J. García-García, and F. Martín, "Novel microstrip bandpass filters based on complementary split-ring resonators," *IEEE Trans. Microw. Theory Tech.*, Vol. 54, No. 1, 265–271, Jan. 2006.
6. Bonache, J., F. Martin, I. Gil, J. Garcia-Garcia, R. Marques, and M. Sorolla, "Microstrip bandpass filters with wide bandwidth and compact dimensions," *Microw. Opt. Technol. Lett.*, Vol. 46, No. 4, 343–346, Aug. 2005.
7. Cassivi, Y., L. Perregrini, P. Arcioni, M. Bressan, K. Wu, and G. Conciauro, "Dispersion characteristics of substrate integrated rectangular waveguide," *IEEE Microw. Wireless Compon. Lett.*, Vol. 12, No. 9, 333–335, Sep. 2002.
8. Lee, J. H., P. Stephane, P. J. Papapolymerou, L. Joy, and M. M. Tentzeris, "Low-loss LTCC cavity filters using system-on-package technology at 60 GHz," *IEEE Trans. Microwave Theory Tech.*, Vol. 53, No. 12, 3817–3824, Dec. 2005.
9. Germain, S., D. Deslandes, and K. Wu, "Development of substrate integrated waveguide power dividers," *Proc. IEEE Canadian Conf. Electrical Computer Engineering (CCECE'03)*, Vol. 3, 1921–1924, May 4–7, 2003.
10. Dealandes, D. and K. Wu, "Single-substrate integration techniques for planar circuits and waveguide filters," *IEEE Trans. Microwave Theory Tech.*, Vol. 51, 593–596, February 2003.

11. Che, W., E. Yung, and K. Wu, "Millimeter-wave ferrite phase shifter in substrate integrated waveguide (SIW)," *IEEE Int. AP-S Symp. Dig.*, 887–890, Jun. 2003.
12. Baena, J. D., J. Bonache, F. Martín, R. Marqués, F. Falcone, T. Lopetegui, M. A. G. Laso, J. García-García, I. Gil, M. Flores, and M. Sorolla, "Equivalent-circuit models for splitting resonators and complementary split ring resonators coupled to planar transmission lines," *IEEE Trans. Microw. Theory Tech.*, Vol. 53, No. 4, 1451–1461, Apr. 2005.