

On flow properties, fibre distribution, fibre orientation and flexural behaviour of FRC

— [Source link](#) 

Patrick Stähli, Rocco Custer, Jan G. M. van Mier

Institutions: ETH Zurich

Published on: 01 Jan 2008 - Materials and Structures (Springer Netherlands)

Topics: Fiber-reinforced concrete and Flexural strength

Related papers:

- [High mechanical performance of fibre reinforced cementitious composites: the role of “casting-flow induced” fibre orientation](#)
- [Flowability of fibre-reinforced concrete and its effect on the mechanical properties of the material](#)
- [Distribution and orientation of fibers in steel fiber reinforced concrete](#)
- [Simple tools for fiber orientation prediction in industrial practice](#)
- [Assessment of fibre orientation in ultra high performance fibre reinforced concrete and its effect on flexural strength](#)

Share this paper:    

View more about this paper here: <https://typeset.io/papers/on-flow-properties-fibre-distribution-fibre-orientation-and-2j1i8pud4r>

On flow properties, fibre distribution, fibre orientation and flexural behaviour of FRC

Journal Article**Author(s):**

Stähli, Patrick; Custer, Rocco; Mier, Jan G.M. van

Publication date:

2008

Permanent link:

<https://doi.org/10.3929/ethz-b-000003934>

Rights / license:

[In Copyright - Non-Commercial Use Permitted](#)

Originally published in:

Materials and Structures 41(1), <https://doi.org/10.1617/s11527-007-9229-x>

On flow properties, fibre distribution, fibre orientation and flexural behaviour of FRC

Patrick Stähli · Rocco Custer ·
Jan G. M. van Mier

Received: 6 October 2006 / Accepted: 29 January 2007 / Published online: 22 February 2007
© RILEM 2007

Abstract For improving the mechanical properties of fibre reinforced concrete one can either increase the fibre content, use hybrid fibre systems, or one can attempt to align fibres in the direction of stress. In this paper, it is attempted to use the flow-properties of the fresh (self-compacting) concrete to change the fibre distribution and orientation. Using a single mixture of fibre reinforced concrete, containing 3% of 30 mm long straight steel fibres, the fibre distribution and orientation was determined in three different parts of a ‘U-shaped specimen’ where the concrete could flow in three different directions. The fibre distribution and orientation was determined from a CT-scan. Flexural tests show that the mechanical behaviour depends on the fibre distribution and orientation, which can be affected by changing the viscosity of the fresh mixture.

Keywords Fibre alignment · Fibre orientation · Fibre distribution · Flow profile · Flexural strength

1 Introduction

Compaction may have a significant influence on the properties of fibre reinforced concrete. In particular fibre orientation and fibre distribution may be affected, especially when vibration needles are inserted in the fresh concrete. With the development of self-compacting concrete, the use of vibrational energy for compaction has become obsolete, and with current generation of superplasticizers it is possible to develop self-compacting fibre concrete as well [1–4]. Increasing the amount of fibres may have a positive effect on the mechanical properties, but because fibres are not all necessarily aligned in the direction of stress, the effectivity is debatable. Better would be to align fibres in the direction of stress, which might lead to improved performance of FRC in a structure, probably against lower cost. Not only strength should be considered, but also ductility.

Aligning fibres has been tried in the past under a variety of circumstances. Recently a method based on magnetic fields was proposed by Linsel [5]. For SIFCON, fibre alignment can be achieved by sprinkling fibres in a narrow space, or in very thin elements [6, 7]. Moreover, during extrusion

P. Stähli (✉) · R. Custer · J. G. M. van Mier
Department of Civil Engineering, ETH Zurich,
Institute for Building Materials, 8093 Zurich,
Switzerland
e-mail: pstaehli@ethz.ch

R. Custer
e-mail: rcuster@student.ethz.ch

J. G. M. van Mier
e-mail: jvanmier@ethz.ch

of FRC, fibres align in the longitudinal direction as well (see for example [8]), leading to quite some anisotropy with, probably the related differences in properties in the different directions.

As mentioned, the development of self-compacting concrete leads to easier placement of the fresh material, and the fibre distribution and orientation is not affected since compaction becomes obsolete. An interesting idea is to investigate to what extent the flow properties of the fresh material can be used to affect the fibre distribution and orientation, and to see if a possible influence on the mechanical properties emerges. In this short paper some preliminary experiments are reported that confirm that the idea is basically correct, and that mechanical properties are improved when fibres are aligned. After a description of the used materials and specimens, results of Computer Tomography experiments using the CT-scanner at University Hospital Zurich are presented. Next the results from mechanical experiments are given, and a possible explanation of the observed behaviour is debated.

2 Material, specimens and fresh concrete tests

As mentioned, the aim of this research was to determine the influence of the flow behaviours of fibre reinforced concrete (i) on the orientation and distribution of the fibres and (ii) on the mechanical properties. Three mixtures, which only differ in the amount of super plasticizer, were investigated. Table 1 gives detail information about the mentioned mixtures and Fig. 1 shows an image of the used fibres.

Because of available techniques to determine the fibre orientation and fibre distribution (namely CT-scan combined with manual counting), relatively large fibres were used (Fig. 1). Such large fibres have the advantage that they can be detected by means of medical computer tomography with a resolution of 0.4 mm. Moreover, because of their size large fibres can also be easily counted manually. The theoretical number of fibres per cm^2 in a cross-section, in a material with 3 vol% of fibres is 10, which simplifies manual counting as well. To ensure that the fresh

Table 1 Mix proportions for the three different mixtures (values are for 1 m^3 concrete)

	Mixture 1	Mixture 2	Mixture 3
Cement CEM I 52.5R*	1,008 kg	1,006 kg	1,004 kg
Fly ash	169 kg	169 kg	168 kg
Silica fume	95 kg	95 kg	95 kg
Sand 0–1 mm	760 kg	758 kg <td 757 kg	
W/b-ratio	0.17	0.17	0.17
Ø6/30 mm steel fibres (volume percentage)	3	3	3
Super plasticizer (weight percentage of the cement)	1.8	2.0	2.2

* Classification according to EN 197-1 (Cement type I (Portland cement) with a standard compression strength of 52.5 MPa)

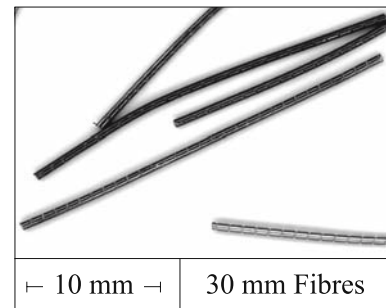

Fig. 1 Ø6/30 mm steel fibre

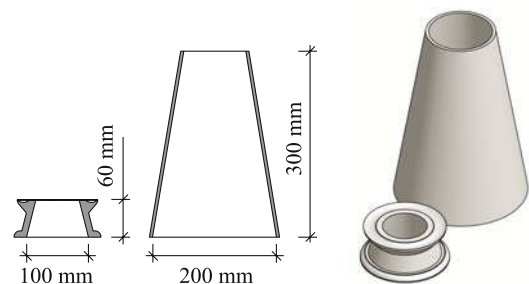

Fig. 2 Small and large slump flow cones

concrete is influenced by the super-plasticizer only, for all the mixtures the mix procedure was the same. After mixing cement, fly ash, microsilica and sand with water and superplasticizer for 4 min, the fibres were added and the concrete mixture was mixed for another 4 min. The fresh concrete behaviour was determined by performing small and large slump flow tests. The geom-

etry of the two slump flow cones is given in Fig. 2. The air content was also measured. All results are gathered in Table 2.

Table 2 shows that the flow behaviours of the mixtures really differ. This result was expected and shows that with only small changes in the amount of super plasticizer, the diameter of the slump flows can be changed significantly. With an increasing slump flow the air content decreases due to the fact that a better flowing concrete also better vents.

In order to determine the influence of the fresh concrete behaviour on the fibre distribution and orientation, and on the mechanical properties, a so-called ‘U-mould’ was developed. This U-shaped mould was designed in such a way that the concrete first flows down (Fig. 3, branch ‘A’), secondly, flows horizontally (Fig. 3, branch ‘B’), and finally rises again (Fig. 3, branch ‘C’). After demoulding the 3 specimens (prisms of size $70 \times 70 \times 280 \text{ mm}^3$) were cut out, one from each branch of the ‘U-specimen’. The prisms fitted in the pendulum-bar four-point bending test set-up that was recently developed at the Institute for Building Materials [3]. From the bending tests the ‘elastic’ flexural strength was determined and the global load-deformation diagrams. To determine the fibre distribution and fibre orientation the specimens were tomographed in a medical CT-scanner (see paragraph 2). From one

‘U-specimen’ three prisms, each from a different location, were analysed (see Fig. 3, prisms marked ‘A’, ‘B’ and ‘C’ for the ‘falling’ ‘horizontal’ and ‘rising’ parts of the ‘U-specimen’, respectively).

To avoid that the material would fall into the mould during the casting process and the fibres would align, or even segregate, due to the free fall of the material, the U-mould was tilted and the material could flow from the shovel into the mould. This procedure was applied for all the mixtures. Images of the casting process are given in Fig. 4.

3 Fibre orientation and fibre distribution from CT-Scan experiments

To analyse the fibre distribution and orientation in the interior of a specimen the specimen can be cut into slices and the fibres can be counted, or it can be computer tomographed and the 3D reconstructed specimen can be cut into virtual slices that can be analysed. The advantage of the tomography is that it is a non-destructive method and specimens can be used for other experiments, for example pendulum-bar four-point bending tests. One specimen of each mixture and branch was tomographed in a Siemens SOMATOM Sensation 64 at the University Hospital in Zurich with a resolution of 0.4 mm per voxel. Figure 5 shows a reconstructed specimen.

In order to compare the specimens, two different sections were analysed: a cross-section and a longitudinal section as shown in Fig. 6. The images of the longitudinal section showed how the fibres were aligned in the specimen and the cross-section could be taken to confirm the results

Table 2 Results from the fresh concrete tests

	Mixture 1	Mixture 2	Mixture 3
Small slump flow Ø (cm)	16	20	22.5
Large slump flow Ø (cm)	45	59	64
Air content (%)	5.1	5.0	4.2

Fig. 3 ‘U-shaped mould’ with locations where three $70 \times 70 \times 70 \text{ mm}^3$ prisms are cut-out after hardening

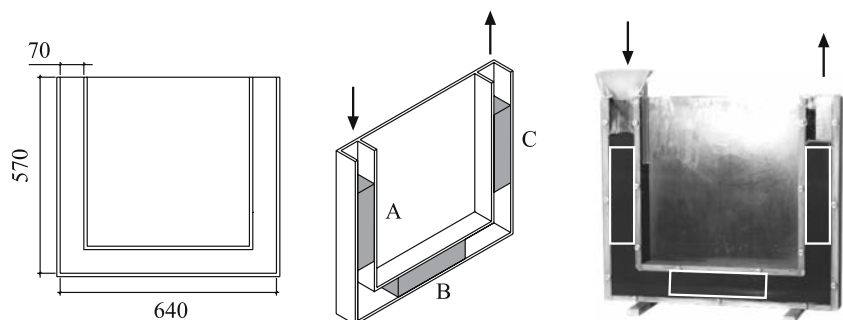



Fig. 4 Casting of the ‘U-shaped’ specimen: the mould is given an inclination to prevent free fall of the concrete along the “A”-side

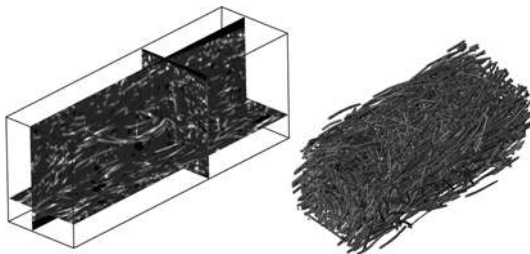

Fig. 5 Left: Three different orthogonal slices through a reconstructed FRC specimen from a CT-scan. Right: 3D reconstruction of the steel fibres only

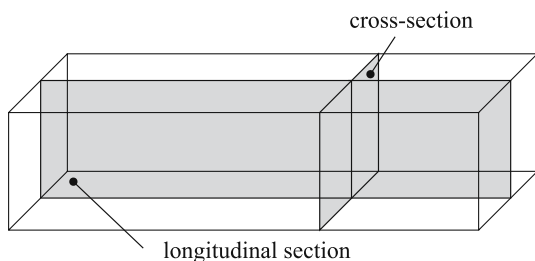

Fig. 6 Nomenclature for the different cross-sections used in the paper

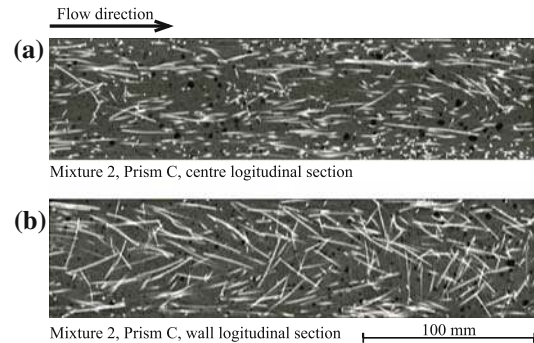

Fig. 7 Longitudinal sections of the centre of a specimen and a section near to the mould

from the longitudinal section, i.e. the more the fibres are aligned the less fibres can be seen/ counted in the cross-section [4]. The longitudinal section also gave an idea about the flow profile of the fresh concrete (Fig. 7b).

Figure 7 shows two longitudinal sections of the “C” prism (rising branch) from Mixture 2, one section of the centre of the prism (top image) and one of the areas near the wall (bottom image). This figure clearly shows that fibres align with the flow of the concrete. It can also be seen that the faster the concrete flows (center part of Fig. 7a) the better fibres align. Moreover, it appears that the flow velocity is not constant over the whole cross-section because the fibres are not aligned over the whole area. In the centre the flow is faster than near the walls, which is typical for a material like fresh concrete [9]. What remains, however, is the question about the shape of the flow profile. A flow profile can be deduced from the image of the longitudinal section near the mould/wall (Fig. 7b). A possible model is given in Fig. 14, which will be discussed further-on in this paper.

A comparison of the fibre distribution and alignment between the different mixtures can be made by comparing images of centre longitudinal sections of “B” prisms (horizontal branch). Figure 8 shows such an image of a centre longitudinal section for each mixture. The top of each image corresponds to the top surface of prism “B” during casting and hardening. In Mixture 1 the fibre alignment and distribution is similar to the one from Fig. 7 (i.e. wall longitudinal section), which leads to the assumption that flow profiles in

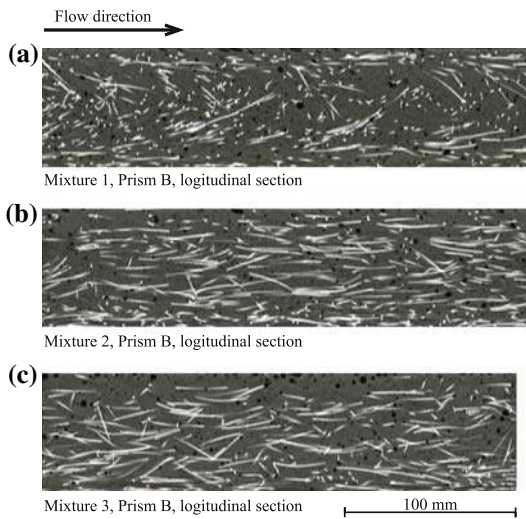

Fig. 8 Longitudinal centre sections of the prisms “B” for each of the three tested mixtures

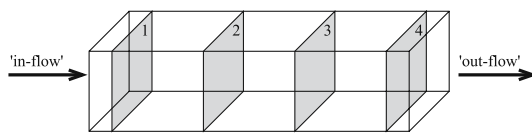
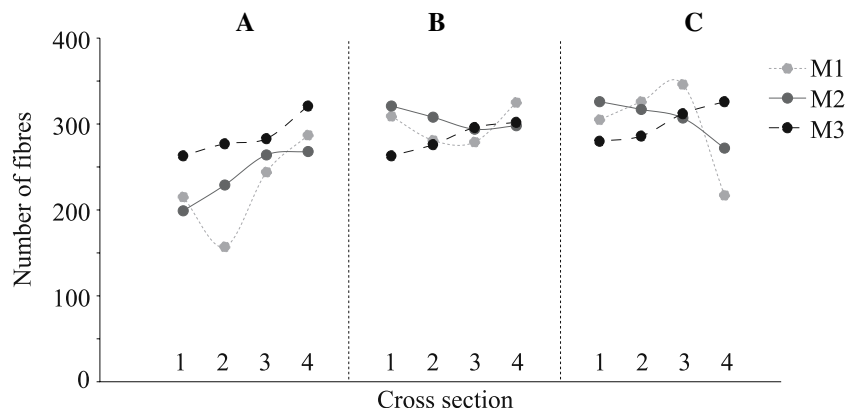

Fig. 9 Analysed cross-sections in a prism

longitudinal sections are equal. Figure 8 also shows that the better the concrete flows the more the fibres align. In mixture 1, with a small slump flow of 16 cm, hardly any fibre alignment can be observed, while in mixtures 2 and 3 (with 20 and 22.5 cm slump flow diameter, respectively), the fibres were nicely aligned in the direction of concrete flow. Another phenomenon that can be observed is the fibre segregation in mixture 3.

Fig. 10 Results from the fibre counting of the various cross-sections for mixtures 1–3 and the prism positions “A”, “B” and “C”



Segregation can have a negative effect in constructions where a constant tensile stress over the whole cross-section is expected. However, also a positive effect could emerge, for example, in a flexural beam with the majority of fibres aligned along the tensile stressed part of the beam.

The total number of fibres in four different cross-sections of each prism were counted and investigated. Figure 9 shows the location of the analysed cross-sections. Two cross-sections in the middle of the prism and at each end of the prism (in-flow and out-flow) a cross-section were analysed and the results are presented in Fig. 10.

For quantitative assessment of the fibre alignment the total number of fibres in a cross-section was determined. The more fibres that can be counted in a cross-section the better fibres are aligned, under the assumption that fibres are uniformly distributed. If the fibres are perpendicular to the cross-section, and uniformly distributed, most fibres can be counted; if the fibres are parallel to the cross-section, and uniformly distributed, least fibres can be counted [4]. The variation of the numbers of fibres per cross-section in the prisms is shown in Fig. 10. It can be seen that the different cross-sections have different total numbers of fibres but the progress of the number of fibres in the prisms is more or less constant. Figure 10 shows that the progress of the counted fibres in the “A” prisms increases from the ‘in-flow’ to the ‘out-flow’, which means that the alignment of the fibres increases with the flow distance. The total fibres-count also increases with the flow

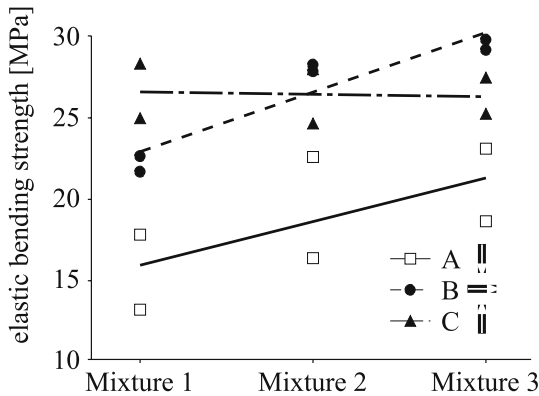
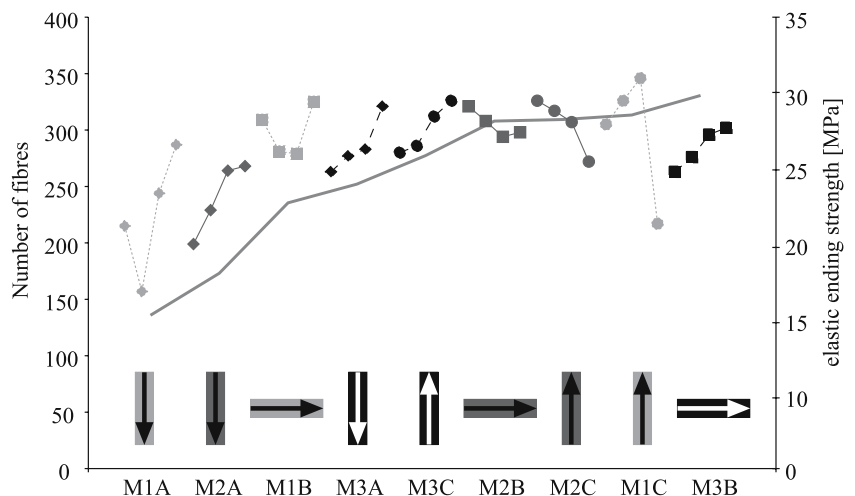

Fig. 11 Results from the four-point bending test

ability of the fresh concrete. By comparing the three mixtures, mixture 1 shows least fibres and mixture 3 has most fibres, or in different words less viscous concretes have an improved fibre alignment. The “B” and “C” columns show that the total fibres-count in mixture 3 decreases due to fibre segregation. The concrete viscosity is thus an important parameter; if the material is not viscous enough, segregation may occur, but it will depend on the typical structural application whether this is beneficial or not. The discontinuity of the progress of mixture 1 in the “C” prism is caused by the fact that the material did not ‘level-out’ properly and the specimen was cut out only 2 cm from the end of the rising branch of the ‘U-specimen’.

Fig. 12 Comparison between the counted fibres per cross-section (left Y-Axes) and the bending strength (right Y-Axes). The solid line shows the results from the four-point bending test; dots, squares and diamonds are results from fibre counting



4 Discussion: fibre distribution and flexural behaviour

In order to determine the mechanical properties four-point bending tests were performed. The specimens were the same as used for the CT-scans. To normalize the results the elastic bending strength ($f_{bmax} = M_{max}/W$) was calculated and all the results are presented in Fig. 11. Figure 11 clearly shows that the bending strength increases with the increasing ‘flow-ability’, except in the “C” prisms, where the fibre segregation seems to have a negative influence on the bending strength. Nevertheless the bending strength is still on a relatively high level of 25 MPa. The fibre segregation is also the reason why the bending strength of the “C” prism from mixture 3 is lower than the bending strength of the “B” prism from mixture 3. The progress of the bending strength of the

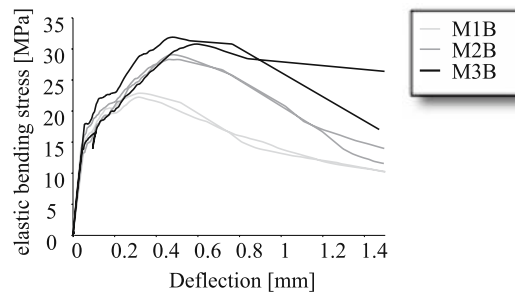
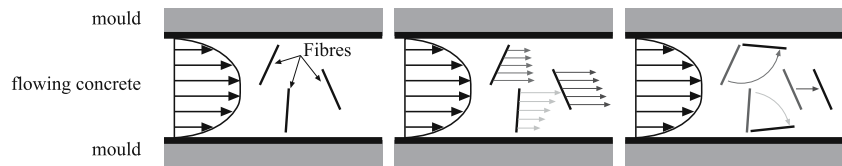

Fig. 13 Elastic bending stress versus deflection diagram from four-point bending test on “B” prisms



Fig. 14 Explanation for fibre alignment in flowing concrete



“C” prisms in Fig. 11 is constant: the bending strength does not increase with the increase of the ‘flow-ability’ due to the fibre-segregation. The material was not able to transport the fibres all the way up to the “C” prisms but the fibres that travelled the whole distance were aligned. Thus, the increase of strength due to fibre alignment and the decrease due to segregation seem to compensate. For the “B” prisms were an increase of bending strength of 40% was measured, the effects of fibre alignment and fibre segregation amplify. Finally the “A” prisms are only influenced by the alignment of the fibres: an increase of the bending strength of 30% was observed.

In Fig. 12 the prisms were arranged according to their bending strength; in Fig. 13, examples of stress-deformation curves, derived from four-point bending tests are shown. It can be seen that with increasing fibre-count per cross-section the bending strength increases as well. This diagram shows that the alignment of the fibres improves the mechanical properties of fibre reinforced concrete. But why do fibres align? To the authors opinion the fibres align because of the flow profile. A possible simplified model is shown in Fig. 14. Different flow velocities affect the fibres and may cause the fibres to rotate in such a way that they align with the flow of the material. The effect is stronger at higher flow velocity or when the velocity can affect the fibre for longer time, (i.e. lower viscosity or longer flow duration). Suggestions of different flow velocities can be derived from Fig. 7b and to a less extent from Fig. 8a. More experiments and numerical simulations should have to be carried out for validating the above mentioned model.

5 Conclusions

From the relatively small number of experiments, the following conclusions can be drawn:

- Fibres align with the flow of the fresh concrete (see for example Fig. 8b).
- When the fresh concretes flows through a mould, a certain flow profile develops, most likely due to frictional restraint along the walls of the mould (Figs. 7b and 14).
- There is a correlation between bending strength and fibre alignment: better fibre-alignment leads to a higher bending strength (see Fig. 12).
- Fibre segregation can lead to a much higher bending strength than expected due to fibre alignment only, at least as long as the segregated fibres are located along the tensile stressed part of the beam.
- The strength of a structure made of fibre reinforced concrete is dependent of the fibre alignment and fibre distribution, which both can be influenced by the viscosity of the fresh concrete.
- After a certain flow distance the bending strength due to fibre alignment does not increase any further.

Acknowledgements The authors are indebted to the colleagues at the Institute of Building Materials, Dr. Pavel Trtik, the University Hospital Zurich and Mr. Roger Schmid. Support by Holcim and Degussa (BASF) is gratefully acknowledged.

References

1. Grünewald S (2004) Performance-based design of self-compacting fibre reinforced concrete. Ph.D. Thesis, Delft University of Technology
2. Markovic I (2006) High-performance hybrid-fibre concrete. Ph.D. Thesis, Delft University of Technology
3. Stähli P, Van Mier JGM (2004) Three-fibre-type hybrid fibre concrete. In: Li VC et al (eds) Proceedings 5th international conference on ‘Fracture Mechanics of Concrete and Concrete Structures’ (FraMCoS-V), April 12–16, 2004, Vail, Colorado, pp 1105–1112

4. Stähli P, Van Mier JGM (2007) Manufacturing, fibre anisotropy and fracture of hybrid fibre concrete. *Eng Frac Mech* 74:223–242
5. Linsel S (2005) Magnetische Positionierung von Stahlfasern in zementösen Medien Magnetic positioning of steel fibres in cementitious medias. Ph.D. Thesis, Technische Universität Berlin
6. Van Mier JGM, Timmers G (1992) Shear fracture in slurry infiltrated fibre concrete (SIFCON). In: Reinhardt HW, Naaman AE (eds) *Proceedings RILEM/ACI workshop on high performance fibre reinforced cement composites*. Mainz, June 24–26, 1991, E&FN Spon/Chapman & Hall, London/New York, pp 348–360
7. Van Mier JGM, Timmers G (1996) *Werkwijze en Inrichting voor de Vervaardiging van een Gewapend Constructie-Element en een Dergelijk Constructiedeel (Device for Manufacturing a Reinforced Construction Element)*, Dutch patent No. 1000285, submitted July 25, 1995, granted November 6, 1996 (in Dutch)
8. Shao Y, Shah SP (1997) Mechanical properties of PVA reinforced cement composites fabricated by extrusion processing. *ACI Mater J* 94(6):555–564
9. Tattersall GH, Banfill PFG (1983) *The Rheology of fresh concrete*, Pitman Books Limited, ISBN: 0-273-08558-1