

 Open access • Journal Article • DOI:10.1007/S00791-003-0118-8

On numerical simulation of flow through oil filters — Source link

Oleg Iliev, Vsevolod Laptev

Published on: 01 Mar 2004 - Computing and Visualization in Science (Springer Berlin Heidelberg)

Topics: Filter (signal processing) and Computer simulation

Related papers:

- [Boundary conditions at a naturally permeable wall](#)
- [A calculation of the viscous force exerted by a flowing fluid on a dense swarm of particles](#)
- [Coupling Fluid Flow with Porous Media Flow](#)
- [On the Boundary Condition at the Surface of a Porous Medium](#)
- [Momentum transfer at the boundary between a porous medium and a homogeneous fluid-I. Theoretical development](#)

Share this paper:    

View more about this paper here: <https://typeset.io/papers/on-numerical-simulation-of-flow-through-oil-filters-473oahexws>



Fraunhofer Institut
Techno- und
Wirtschaftsmathematik

O. Iliev, V. Laptev

On Numerical Simulation of Flow Through Oil Filters

© Fraunhofer-Institut für Techno- und Wirtschaftsmathematik ITWM 2003

ISSN 1434-9973

Bericht 51 (2003)

Alle Rechte vorbehalten. Ohne ausdrückliche, schriftliche Genehmigung des Herausgebers ist es nicht gestattet, das Buch oder Teile daraus in irgendeiner Form durch Fotokopie, Mikrofilm oder andere Verfahren zu reproduzieren oder in eine für Maschinen, insbesondere Datenverarbeitungsanlagen, verwendbare Sprache zu übertragen. Dasselbe gilt für das Recht der öffentlichen Wiedergabe.

Warennamen werden ohne Gewährleistung der freien Verwendbarkeit benutzt.

Die Veröffentlichungen in der Berichtsreihe des Fraunhofer ITWM können bezogen werden über:

Fraunhofer-Institut für Techno- und
Wirtschaftsmathematik ITWM
Gottlieb-Daimler-Straße, Geb. 49

67663 Kaiserslautern

Telefon: +49 (0) 6 31/2 05-32 42

Telefax: +49 (0) 6 31/2 05-41 39

E-Mail: info@itwm.fraunhofer.de

Internet: www.itwm.fraunhofer.de

Vorwort

Das Tätigkeitsfeld des Fraunhofer Instituts für Techno- und Wirtschaftsmathematik ITWM umfasst anwendungsnahe Grundlagenforschung, angewandte Forschung sowie Beratung und kundenspezifische Lösungen auf allen Gebieten, die für Techno- und Wirtschaftsmathematik bedeutsam sind.

In der Reihe »Berichte des Fraunhofer ITWM« soll die Arbeit des Instituts kontinuierlich einer interessierten Öffentlichkeit in Industrie, Wirtschaft und Wissenschaft vorgestellt werden. Durch die enge Verzahnung mit dem Fachbereich Mathematik der Universität Kaiserslautern sowie durch zahlreiche Kooperationen mit internationalen Institutionen und Hochschulen in den Bereichen Ausbildung und Forschung ist ein großes Potenzial für Forschungsberichte vorhanden. In die Berichtreihe sollen sowohl hervorragende Diplom- und Projektarbeiten und Dissertationen als auch Forschungsberichte der Institutsmitarbeiter und Institutsgäste zu aktuellen Fragen der Techno- und Wirtschaftsmathematik aufgenommen werden.

Darüberhinaus bietet die Reihe ein Forum für die Berichterstattung über die zahlreichen Kooperationsprojekte des Instituts mit Partnern aus Industrie und Wirtschaft.

Berichterstattung heißt hier Dokumentation darüber, wie aktuelle Ergebnisse aus mathematischer Forschungs- und Entwicklungsarbeit in industrielle Anwendungen und Softwareprodukte transferiert werden, und wie umgekehrt Probleme der Praxis neue interessante mathematische Fragestellungen generieren.



Prof. Dr. Dieter Prätzel-Wolters
Institutsleiter

Kaiserslautern, im Juni 2001

On Numerical Simulation of Flow Through Oil Filters

Oleg Iliev¹, Vsevolod Laptev²

Fraunhofer Institut für Techno und Wirtschaftsmathematik D-67663 Kaiserslautern, Germany
(iliev@itwm.fhg.de; laptev@itwm.fhg.de)

Received: date / Revised version: date

Abstract. This paper concerns numerical simulation of flow through oil filters. Oil filters consist of filter housing (filter box), and a porous filtering medium, which completely separates the inlet from the outlet. We discuss mathematical models, describing coupled flows in the pure liquid subregions and in the porous filter media, as well as interface conditions between them. Further, we reformulate the problem in fictitious regions method manner, and discuss peculiarities of the numerical algorithm in solving the coupled system. Next, we show numerical results, validating the model and the algorithm. Finally, we present results from simulation of 3-D oil flow through a real car filter.

Key words oil filters, coupled flow in plain and porous media, Navier-Stokes, Brinkman, numerical simulation

1 Introduction

The purpose of oil filters (e.g., Fig.1) is to filter out (small) dirt particles from the oil. Several challenging mathematical problems have to be solved to support the design of oil filters: detailed simulation of coupled flows through filters (i.e., through pure liquid interior of the filter housing and through the porous filtering media); modeling and simulation of capturing of dirt particles by the filtering media, interaction of flow and deformable filtering media, optimal shape design, etc. Here we discuss the first of these problems, i.e. coupled flows simulations. The main aspects in this case are:

- choice of an adequate mathematical model for the flow in each of subregions;
- usage of proper interface conditions between different media;
- development of efficient numerical algorithms and software;
- validation of models and algorithms and usage of correct input parameters (e.g., permeability, viscosity, etc.).



Fig. 1. Top pan (left) and bottom pan (right) of a filter housing;

The existing commercial CFD software packages do not provide a complete solution of this problem. They usually do not use precise interface conditions, and/or do not use proper numerical algorithms (some details are specified below). On the other hand, the academic research on this subject is also not completed, as it is seen from discussions below.

The mathematical model in our case is based on laminar incompressible isothermal Navier-Stokes equations (see, e.g. [4]) for the flow in pure liquid zones, and the Brinkman extension to Darcy model [2, 9] for the flow in the porous zone. The Darcy model needs to be extended by Brinkman term at least in two cases: to account for some kinds of boundary conditions, and to describe more adequately the flow in the case of high porosity. Usually, the porosity of filtering media (see Fig.2) is more than 90%.

Interface conditions between plain and porous media are subject to extensive research carried out by physicists, engineers and mathematicians. In this work we use continuous stress tensor interface conditions (see, for example, [1] and references therein). A more detailed discussion on this subject is presented in the following section.

Numerical algorithms for solving the coupled system can be conventionally subdivided into two groups. In the first group are algorithms, using different systems of equations in different subdomains (e.g., Navier-Stokes in liquid zones, and Darcy or Brinkman in the porous zones), and coupling them through the interface condi-

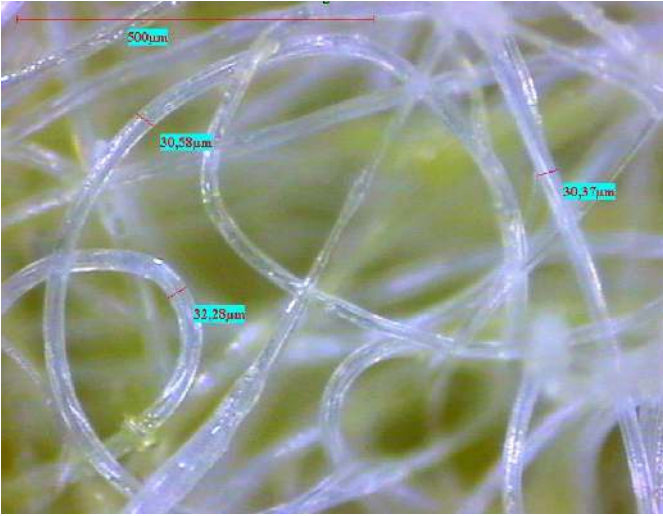

Fig. 2. Large magnification of filter material

tions. Such algorithms are (naturally) based on domain decomposition (DD). This approach has an advantage: one can use existing algorithms and software for solving Navier-Stokes equations and for solving porous media flows. But it also has a drawback: the convergence (at least for the additive and multiplicative versions of DD) might be slow in the case when the inlet and the outlet are completely separated by the porous medium. For more details on this approach see, for example, [10] and references therein.

In the second group are algorithms, using one system of equations in the whole domain. Such a system is sometimes called Navier-Stokes-Brinkman system. For a mathematical justification of such a reformulation of the problem (done from the point of view of the fictitious regions method), see [1] and references therein. In some of commercial CFD software (e.g. Star-CD, etc.) the Navier-Stokes-Brinkman system is solved by algorithms developed for the Navier-Stokes system modified so that the main term describing the flow through porous media is treated explicitly (i.e., taken from the previous time step in the unsteady case, or taken from the previous iteration in the algorithms for steady problems). As it can be expected, such algorithms converge very slowly (or even do not converge) in the case when the porous medium separates the inlet and the outlet. Another approach is used here: the permeability-related terms in the equations are treated implicitly.

The usage of correct parameters might be critical for some of the applications. The manufacturers continuously offer new filtering media, and usually their permeability is not known. The traditional approach here is to calculate the permeability on the basis of laboratory experiments. A more advanced approach is to use microstructure simulations (see for details [18]). In this case, a picture of a piece of the filtering medium is taken (say, by X-ray computer tomography), and after that 3-D image analysis is performed in order to obtain a computer representation of the microstructure of the porous material. Next, one solves Stokes equations in the com-



Fig. 3. A schematic drawing of a vertical cross-section of the filter

plex microlevel-geometry, to calculate permeability on the basis of homogenization theory [13]. Among others, this approach has an advantage: it is a natural component of virtual material design [18].

The paper is organized as follows. The mathematical models are given in the next section. Governing equations for flow in the pure liquid part and in the porous medium, interface conditions, as well as reformulating of the problem in fictitious regions method manner, are discussed there. The third section is devoted to the numerical algorithm and its validation. The fourth section presents computational results. These are results devoted to the validation of the model by comparing micro- and macro- solutions for model geometries; results from simulations with permeability tensor for anisotropic medium; and results from simulation of 3-D oil flow through a car filter. Finally, some conclusions are formulated.

2 Mathematical Model

2.1 Governing Equations

Oil filters consist of filter housing (filter box), and a porous filter medium, separating the inlet and the outlet. A vertical cross-section of a filter is schematically shown in Fig.3. The oil enters the filter housing through an inlet section in the bottom pan (it can be seen at the left top corner of the bottom pan on Fig.1), and leaves it through a tube on the top pan. The pure fluid regions (below and above the filtering medium) are denoted by Ω_f , and the porous region (filtering medium) is denoted by Ω_p .

The flow in the pure liquid region, Ω_f , is described by incompressible isothermal Navier-Stokes equations (or by Stokes equations, in the case of slow flow):

$$-\mu \Delta \mathbf{u} + (\rho \mathbf{u}, \nabla) \mathbf{u} + \nabla p = \mathbf{f}_{NS}, \quad \text{in } \Omega_f \quad (1)$$

$$\nabla \cdot \mathbf{u} = 0$$

where

$$\Delta \mathbf{u} = [\Delta u^1, \dots, \Delta u^N]^T,$$

$$(\mathbf{u}, \nabla) \mathbf{u} = [(\mathbf{u}, \nabla u^1), \dots, (\mathbf{u}, \nabla u^N)]^T.$$

Here $\mathbf{u} = (u^1, \dots, u^N)^T$, ($N = 2, 3$) stands for the velocity vector, p stands for the pressure, μ stands for the viscosity, and ρ stands for the density.

Often, the Darcy model is used to describe saturated flow in porous media [2, 9]:

$$\mu K^{-1} \mathbf{u} = \mathbf{f}_D - \nabla p, \quad \text{in } \Omega_p \quad (2)$$

$$\nabla \cdot \mathbf{u} = 0$$

The permeability tensor is denoted by \mathbf{K} in the above equation. An extension of this model, namely, Brinkman model [2,9] is usually used in order to account for the high porosity of the porous media or to impose a no-slip conditions on solid walls:

$$-\nabla \cdot (\mu_{eff} \nabla \mathbf{u}) + \mu \mathbf{K}^{-1} \mathbf{u} = \mathbf{f}_B - \nabla p \quad \text{in } \Omega_p \quad (3)$$

$$\nabla \cdot \mathbf{u} = 0$$

where μ_{eff} is an effective viscosity which can be different from μ . On the other hand, \mathbf{K} is very small (proportional to the second power of average pore diameter) and one can expect that (2) and (3) give similar solutions in Ω_p apart from interfaces.

2.2 Interface conditions between plain and porous media

Currently, there are three most popular approaches: (i) formulation of coupling conditions at a micro-level; (ii) formulation of coupling conditions between the Darcy model in the porous media and the Navier-Stokes equations in the free fluid region; (iii) formulation of coupling conditions between Brinkman model in the porous media and the Navier-Stokes equations.

Microscopical model. The porous medium is represented as a connected domain of pore space filled with the fluid and the flow is governed by Navier-Stokes (or Stokes) equations there. This model is completed with no-penetration and no-slip boundary conditions on the boundaries of the solid skeleton, the latter having a very complex geometrical structure. In fact, in this case there is no need in coupling conditions, because one and the same model, namely Navier-Stokes equations, is valid all over the computational domain. This approach is physically correct, but it seems to be inappropriate for applications with real porous media since it needs an unrealistic amount of CPU time/memory resources. Anyway, this model is useful for theoretical purposes, such as deriving macroscopic models for porous media, validations of models and algorithms (see, for example, Section 4. below), etc.

Macroscopic model with the Darcy law in porous media. This is the most common, and at the same time, mathematically the most difficult case. (1) and (2) are completely different systems of PDE and need different number of interface conditions. In [11] a classification of possible qualitative situations is given from an asymptotic point of view. Further development is in [7].

In the case of a parallel flow over a porous plate, the Beavers-Joseph condition for the tangential velocity was proposed and experimentally validated in [3] and later on mathematically justified (see [8] for further details). Although this condition is not justified in the general case, it is widely used in practical computations.

Macroscopic model with Brinkman equation in porous media. In this case, the equations in the porous media (3), and equations in the fluid region, (1) are of the same type. Two types of coupling conditions can be found in the literature. A more common choice till now are condi-

tions of continuous velocity, and continuity of the normal component of the stress tensor:

$$\mathbf{u}|_{S_p} - \mathbf{u}|_{S_f} = 0$$

$$\mathbf{n} \cdot (\mu_{eff} \nabla \mathbf{u} - p \mathbf{I})|_{S_p} - \mathbf{n} \cdot (\mu \nabla \mathbf{u} - p \mathbf{I})|_{S_f} = 0 \quad (4)$$

where S_p and S_f means the same interface S seen from porous and fluid parts, respectively. Such conditions would naturally arise, if for some reasons (say, in the domain decomposition approach), we divide into subdomains the fluid region, where the Navier-Stokes equations are valid. These conditions are used, for example, in [1,12], and we also use them. Another possibility is the stress jump conditions proposed recently by J.A.Ochoa-Tapia, S.Whitaker (see [14]). We are going to discuss them in more details in a forthcoming paper.

2.3 Reformulated problem

Brinkman model (3) for the porous media, Ω_p , Navier-Stokes equations (1) for the fluid region, Ω_f , and continuous stress tensor interface conditions (4), are reformulated, so that a single system of partial differential equations is governing the flow in the pure liquid and in the porous media. This is done in the fictitious regions method manner. The coefficients of the equations vary in the way, reducing this single system to Navier-Stokes equations in the liquid zone, and to Brinkman-like model in the porous media. For theoretical justification of this approach in the case of Stokes flow, see, for example, [1]. The Navier-Stokes-Brinkman-type system in the whole domain reads:

$$-\nabla \cdot (\tilde{\mu} \nabla \mathbf{u}) + (\rho \mathbf{u}, \nabla) \mathbf{u} + \underbrace{\mu \tilde{\mathbf{K}}^{-1} \mathbf{u}}_{\text{Darcy law}} + \underbrace{\nabla p = \tilde{\mathbf{f}}}_{\text{Navier-Stokes}} \quad (5)$$

$$\nabla \cdot \mathbf{u} = 0$$

In this case, the tilde-quantities are defined as follows:

$$\tilde{\mu} = \begin{cases} \mu & \text{in } \Omega_f, \\ \mu_{eff} & \text{in } \Omega_p. \end{cases}$$

$$\tilde{\mathbf{f}} = \begin{cases} \mathbf{f}_{NS} & \text{in } \Omega_f, \\ \mathbf{f}_B & \text{in } \Omega_p. \end{cases}$$

$$\tilde{\mathbf{K}}^{-1} = \begin{cases} \mathbf{0} & \text{in } \Omega_f, \\ \mathbf{K}^{-1} & \text{in } \Omega_p. \end{cases}$$

Note, that this approach allows also for representing a solid region by the same equations [1].

3 Numerical Algorithm

3.1 Finite volume discretization

Before discretizing the governing system of equations (5), we reformulate the problem once more using the fictitious regions method. This time we embed the complicated filter domain, $\Omega_f \cup \Omega_p$, into a more regular domain

(e.g., an parallelepiped). There are a lot of papers, discussing the usage of the fictitious regions method (FRM) in conjunction with Navier-Stokes equations. Because our governing equations (5) are a perturbation of Navier-Stokes equations, we use FRM in the same manner. An advantage of the fictitious regions method is that it allows to use the orthogonal Cartesian grid.

We consider a nonuniform staggered Cartesian grid (3D or 2D), which is an union of control volumes (CVs), related to the pressure (such CVs are called here CV-p, pressure unknowns are related to the centers of these volumes). We suppose, that each such control volume is completely filled with one of the phases: either solid, or fluid, or porous. That is, interfaces between different media appear between control volumes for the pressure, CV-p, only. We use the classical staggered grid ([4,17]). Velocity components are related to the CV-p faces (see Fig.4). The finite volume method is used to discretize the governing equations. The momentum equations are discretized in shifted control volumes. For example, the rectangular $ABCD$ (see Fig.4) is used to discretize the first momentum equation in the point G . The discretization of the Navier-Stokes equations on the staggered grid is well known (see, for example, [4,17]), therefore we will discuss here only the peculiarities of the discretization, related to extension of Navier-Stokes equations to Navier-Stokes-Brinkman system. In this case one has to account for (possible) jumps in viscosity, and for permeability-related term.

We omit *tilde* in the expressions below, when this does not cause misunderstanding. Let us denote by κ^1 the first row of \mathbf{K}^{-1} . Note, that we consider the case of full permeability tensor. Then, the first momentum equation, written in divergence form, reads:

$$-\nabla \cdot \underbrace{(\tilde{\mu} \nabla u^1 - \rho u^1 \mathbf{u} - p \mathbf{e}^1)}_{\boldsymbol{\omega}} + \mu \kappa^1 \mathbf{u} = f^1 \quad (6)$$

As it is seen, we introduced in (6) an auxiliary vector, $\boldsymbol{\omega}$, in order to shorten further description. To obtain a discretized equation for u_{ij}^1 in point G (in 2D), we integrate equation (6) over $ABCD$ (see Fig.4):

$$-\int_{\partial ABCD} \boldsymbol{\omega} \mathbf{n} + \int_{ABCD} (\mu \kappa^1 \mathbf{u} - f^1) = 0$$

and approximate the integrals using discrete variables. The evaluation of the volumetric integral gives us

$$\int_{ABCD} (\mu \kappa^1 \mathbf{u} - f^1) \approx \mu \mathbf{u}(\mathbf{G}) \int_{ABCD} \kappa^1 - \int_{ABCD} f^1.$$

Further, the integral over the east face, CD , is evaluated as

$$\int_{CD} \boldsymbol{\omega} \mathbf{n} \approx [\tilde{\mu}_{i+1,j} \frac{u_{i+1,j}^1 - u_{i,j}^1}{h_{i+1}} - \rho u^1(\mathbf{E})^2 - p_{i+1,j}] |CD|.$$

Next, consider the integral over the north face, BC :

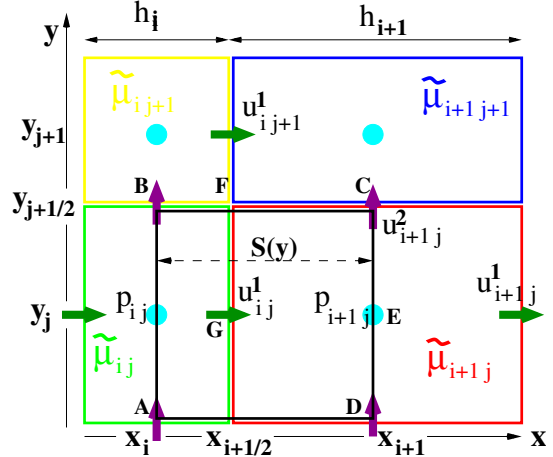

Fig. 4. Grid: control volumes for pressure and shifted CVs for velocity components

$$\int_{BC} \boldsymbol{\omega} \mathbf{n} \approx M (u_{i,j+1}^1 - u_{i,j}^1) - \rho u^1(\mathbf{F}) u^2(\mathbf{F}) |BC|$$

Here $|BC|$ denotes the length of BC , $u^1(\mathbf{E})$ denotes the value of u^1 at point E , etc. The variables of integration are not specified in the integrals above, they are clear from the context. Velocities at intermediate points $u^2(\mathbf{G})$, $u^1(\mathbf{E})$, $u^1(\mathbf{F})$, $u^2(\mathbf{F})$ can be interpolated from the discrete velocities on the respective grids, due to continuity of \mathbf{u} everywhere. M in the last equation above is given by

$$M^{-1} = \int_{y_j}^{y_{j+1}} \frac{dy}{\int_{S(y)} \tilde{\mu} dx}.$$

Integrals over AB and AD are similar to those over CD and BC , respectively.

For the convective terms we use the central difference scheme (for small Reynolds numbers); deferred correction scheme (see, e.g. [15], p.77, for moderate Reynolds numbers) and first order upwind scheme (for high Reynolds numbers).

Let us recall that due to the fictitious regions method used here, we do not need to treat explicitly the porous-fluid interfaces. They are accounted for by an accurate calculation of coefficients $\tilde{\mu}$, \mathbf{K} . During the discretization in a near wall CV, one can treat its neighbour CV, occupied by solid, as a porous CV with extremely small permeability, or with extremely high viscosity, or both (thanks to the usage of the fictitious domain method [1]). Due to the object-oriented implementation, it is also possible to exclude the solid part from computational domain and to use a fictive velocity outside the domain (see the implementation of Dirichlet boundary conditions in [17], p. 194,198).

Discretization of the momentum equations for other velocity components is straightforward. To complete the description of the discretization, we should note that inlet boundary conditions (prescribed velocity), as well as

outlet boundary conditions, are specified and discretized in the classical way (see, for example, [17]).

After discretizing the Navier-Stokes-Brinkman system (5), we obtain a nonlinear system of algebraic equations. It is linearized via the Picard method, i.e. the velocity in the convective terms are taken from the previous iteration. Further, to solve the linearized system, we use a decoupling via a projection method. Namely, we adopt SIMPLE and SIMPLE-C algorithms. In the case of an anisotropic tensor, we treat the diagonal part implicitly, while the off-diagonal terms are taken from the previous iteration and are added to the right hand sides. In this way, at each SIMPLE iteration we solve non-symmetric systems of linear algebraic equations, corresponding to each of the momentum equations, and a system of linear algebraic equations corresponding to the pressure correction equation. ILU preconditioned BiCGStab is used in the first case, while ILU preconditioned CG is used in the second case.

The entire algorithm is implemented as a C++ program for general 2D and 3D geometry. SparseLib++, IML++ are used to solve systems of linear algebraic equations. Visualization is done in MatLab.

3.2 Validation of the algorithm

In the case of pure fluid flow (i.e., empty Ω_p subregion), the algorithm automatically solves the Navier-Stokes equations. The standard lid-driven cavity flow was used as a benchmark in this case, and we find that our results are in good agreement with the results of [5].

To test the algorithm for solving (Navier-)Stokes-Brinkman system, we consider a 2D flow in a channel, partially filled with isotropic ($K = K1$) porous media (see Fig. 5). The channel is long enough, so that far away from the inlet (around $x = 1.4$ in the considered case) the horizontal velocity u^1 is practically independent from the horizontal coordinate x : $u^1(x, y) \approx u^1(y)$. Then $u^2(x, y) \approx 0$, and $p(x, y) \approx p(x)$ in each subregion. The 2D Navier-Stokes equations (1), Brinkman system (3), and interface conditions (4), in this case can be considered as a system of ordinary differential equations (ODE) with respect to y , with the pressure gradient treated as a parameter.

$$\begin{aligned} \mu_{eff} \frac{d^2 u^1}{dy^2} - \frac{\mu}{K} u^1 &= \frac{P_2 - P_1}{x_2 - x_1}, \quad y \in (0, 0.13) \\ \mu \frac{d^2 u^1}{dy^2} &= \frac{P_2 - P_1}{x_2 - x_1}, \quad y \in (0.13, 0.25) \\ u^1(0) &= u^1(0.25) = 0, \\ \mu_{eff} \frac{du^1}{dy}(0.13 - 0) &= \mu \frac{du^1}{dy}(0.13 + 0) \end{aligned} \quad (7)$$

Here we consider a particular case when the height of the channel is equal to 0.25, the height of the porous layer is equal to 0.13. For a fixed pressure gradient, this system can be solved analytically. To compare the 2D numerical with the 1D analytical solution, we first solve the 2D problem (see Fig. 5), using the Navier-Stokes-Brinkman system and the above described algorithm.

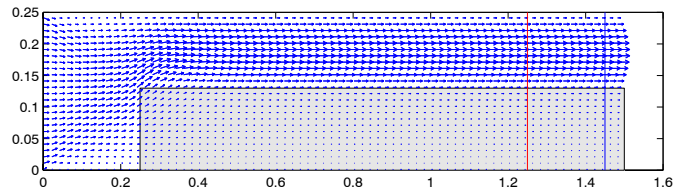

Fig. 5. Flow in a channel partially filled with porous media

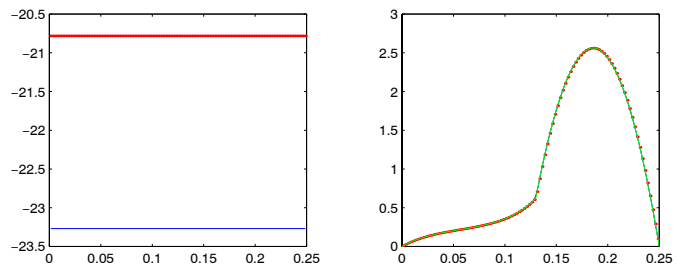

Fig. 6. Comparison of the 2D numerical solution with the analytic solution of 1D problem. Left: constant pressures along y at $x = x_1$ (top) and at $x = x_2$ (bottom); Right: 1D analytical solution (continuous green line) vs 2D numerical velocity profiles at $x = x_1$ and $x = x_2$

Next, we check that $u^1(x, y) \approx u^1(y)$ and that the pressure P_1 at $x_1 = 1.25$ (red line on Fig.5) and the pressure P_2 at $x_2 = 1.45$ (blue line), are constants in y -direction (see Fig.6(left) for plots of P_1 and P_2 along y). Further we solve (7) analytically using the constants P_1 and P_2 . Three lines are plotted in Fig.6 (right): Continuous (green) line represents the analytical solution of the system of ODEs (7); dashed red line represents 2-D numerical solutions $u^1(x_1, y)$ at point x_1 ; and dashed blue line represents 2-D numerical solution $u^1(x_2, y)$ at x_2 . The three lines practically overlap each other. Permeability $k = 0.000174$, viscosity $\mu = 0.01$ and $\mu_{eff}/\mu = 5$ are used in this case.

4 Computational Results

4.1 Validation of the model

To validate the model, we consider two model problems, when the geometry of the porous medium can be resolved by the grid. The idea is to compare solution at a micro level, when the Stokes equations are governing the flow in the complex (micro) geometry, with the solution at a macro level, when the (Navier-)Stokes-Brinkman model is used. The two model problems we consider are the following.

Problem A: flow in a channel, partially occupied by a porous medium. The micro geometry is presented at Fig.7. Stokes equations are solved in the complex geometry here. The macro geometry is presented at Fig.8. The complex geometry between $x = 0.3$ and $x = 1.2$ (Fig.7) is replaced by a porous medium here, and the (Navier-)Stokes-Brinkman system is solved for the whole channel. In this case the flow is mainly perpendicular to the porous medium.

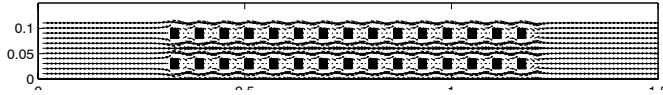

Fig. 7. Validation of the model: micro geometry A



Fig. 8. Validation of the model: macro geometry A

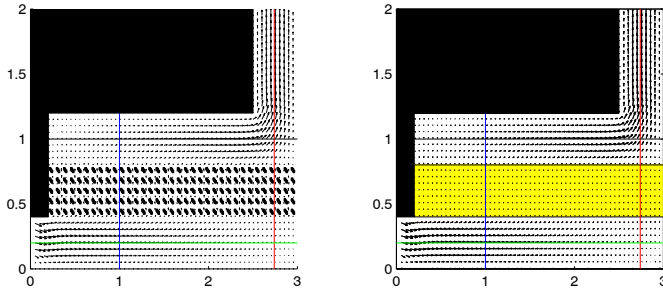

Fig. 9. Micro-(left) and macro-(right) geometry for the validation *Problem B*

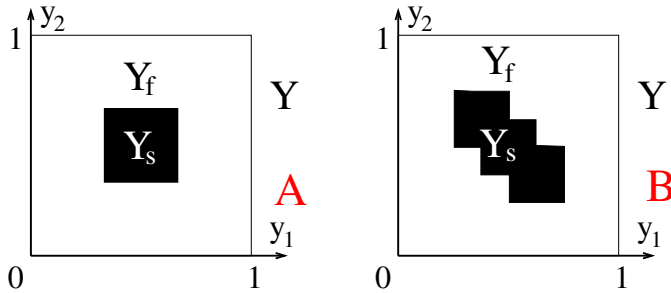

Fig. 10. Geometry of unit cells at a micro level for *Problem A* (left), and for *Problem B* (right).

Problem B: flow in a region imitating the cross-section of a filter, see Fig.9 for micro and macro geometry). In this case the flow is more complicated, there are areas where the flow is perpendicular to the porous medium and areas, where it is parallel to the porous medium.

As it was mentioned above, the (Navier-)Stokes-Brinkman system is solved in the two macro-geometries. The permeabilities in both cases are calculated on the base of homogenization theory (see, e.g. [13]). Let us briefly recall that auxiliary unit cell problems are to be solved in order to calculate the permeability. The geometry of the unit cells is given at Fig.10.

The auxiliary cell problem (see [13] for notations and for theoretical justification) is formulated as follows

$$\begin{cases} -\Delta_y \mathbf{w}^i(y) + \nabla_y \pi^i(y) = \mathbf{e}^i, \\ \nabla_y \cdot \mathbf{w}^i(y) = 0, & \text{in } Y_f; \\ \mathbf{w}^i = 0 \text{ on } \partial Y_s, & \int_{Y_f} \pi^i(y) = 0, \\ \text{periodic } \mathbf{w}^i, \pi^i, & i = 1, 2. \end{cases}$$

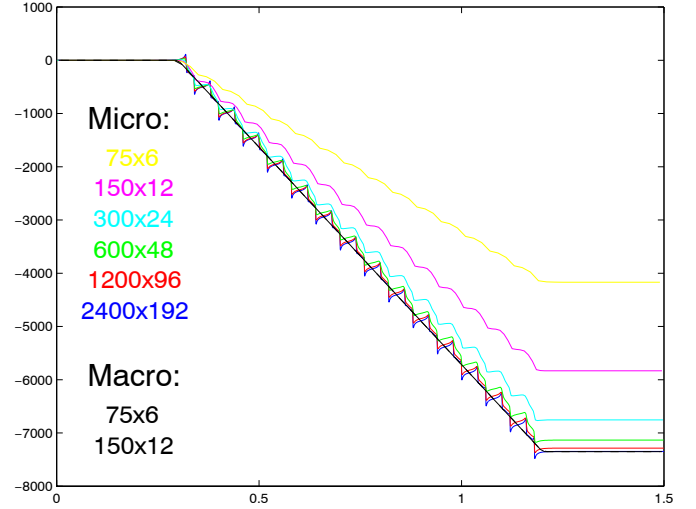

Fig. 11. Validation of the model, *Problem A*: solutions at micro-level vs solutions at macro level

Further, the permeability tensor is calculated as

$$K_{ij} = \int_{Y_f} w_j^i(y) dy$$

Following this approach, the permeability for *geometry A* was calculated on the basis of [6], while the permeability for *geometry B* is due to [16]. The two permeability tensors are

$$K_A = \begin{pmatrix} 0.034 & 0 \\ 0 & 0.034 \end{pmatrix}, \quad K_B = \begin{pmatrix} 0.0194 & -0.004 \\ -0.004 & 0.0194 \end{pmatrix}$$

Note, that because the above unit cell problem is solved in dimensionless setting, we have to rescale the calculated permeability before using it in our dimensional computations. From the particular geometry, it follows that the rescaling factor is 0.06^2 for the *Problem A*, and 0.08^2 for the *Problem B*.

On a microlevel, as well as on a macro-level, the problems are solved on a nested sequence of grids, in order to monitor also the convergence behaviour of the algorithms. Fig.11 represents numerical solutions of micro and macro problems for the *geometry A*. The pressure along the horizontal line $y = 0.04$ is plotted there. One can observe the expected oscillations of the micro solution within the porous medium. Because the macro-problem is very simple, it is solved very accurately even on a coarse grid. On the other hand, the grid for the micro-solution has to be significantly refined, in order to achieve the desired accuracy. The picture demonstrates very well the proximity of the (averaged) micro solution and the macro solution.

Fig.12 demonstrates similar results for *Problem B*. The plots of the pressure along the vertical lines $x_1 = 1.0$ and $x_2 = 2.75$ are combined there with plots of the pressure along horizontal lines $y_1 = 0.25$ and $y_2 = 1.0$. The solution of the micro-problem is represented by continuous lines, while the solution at a macro level is pre-

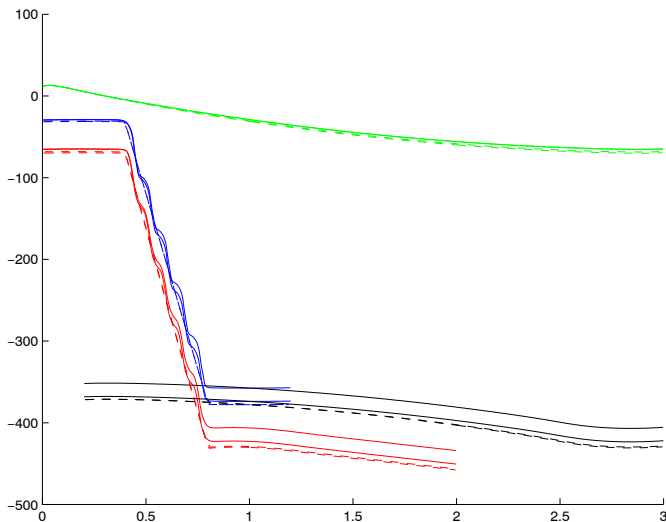

Fig. 12. Numerical solution at micro level vs solution at macro level

sented by dashed lines. Shorter lines with steeper pressure gradient and oscillating micro solutions represent the solution along vertical lines. The following grids are used in micro- simulations: 600×400 , 1200×800 . Grids 300×200 and 150×100 are used for macro- simulations. As in the previous case, one can observe the proximity of the micro- and macro- solutions.

4.2 Anisotropic filter medium

In order to get an impression about the influence of the anisotropy of the porous medium, we simulate coupled flows in one and the same geometry, but with isotropic and with anisotropic permeability tensors, respectively. The Navier-Stokes-Brinkman system is solved in this case, the permeability tensors are given by

$$\mathbf{K}_{is} = \begin{pmatrix} 0.0174 & 0 \\ 0 & 0.0174 \end{pmatrix}, \quad \mathbf{K}_{anis} = \begin{pmatrix} 0.0174 & -0.0139 \\ -0.0139 & 0.0174 \end{pmatrix}$$

As it can be expected, the anisotropy significantly changes the velocity field, as well as the pressure drop across the filter.

4.3 3D car filter

After all the validations, the developed software was used in the numerical simulation of 3-D oil flow through the car filter, shown in Fig.1. In collaboration with an industrial partner, we determined the permeability of the filtering media (which is isotropic in this case), and validated the simulations in comparison with laboratory measurements. Pressure (colors) and velocity vectors (arrows) in two horizontal cross-sections are presented in Fig.14 and Fig.15. Such information is used by designers, in particular, for locating ribs (these are elements

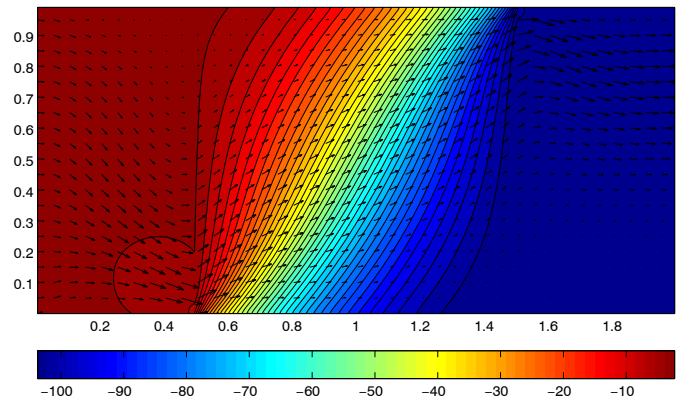
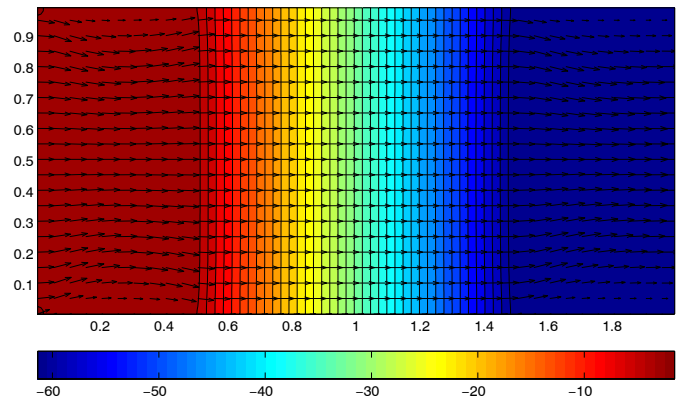

Fig. 13. Pressure (colors) and velocity vectors (arrows) for coupled flow through isotropic (top) and through anisotropic (bottom) porous media.

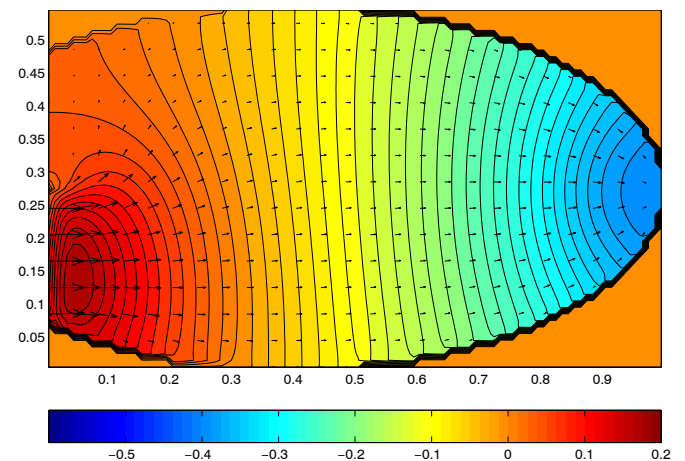

Fig. 14. Pressure and velocity at horizontal cross-section near the bottom

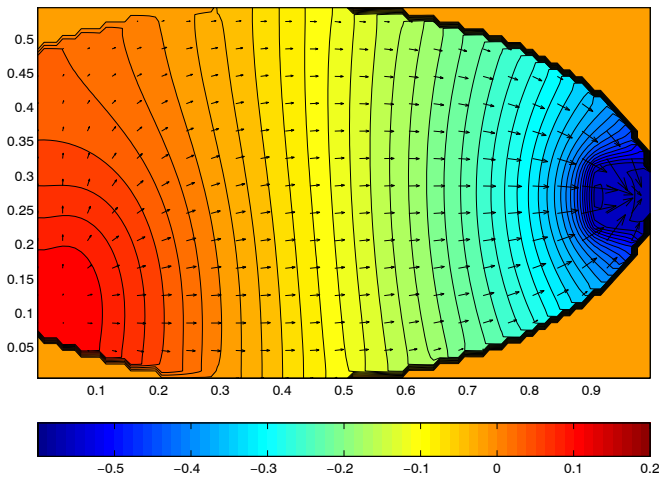

Fig. 15. Pressure and velocity at horizontal cross-section near the top

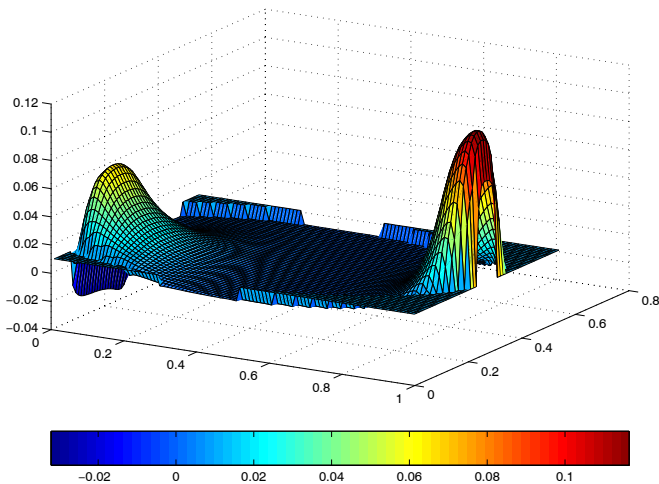

Fig. 16. Mass flow rate from the upper surface of filtering media

of the top pan, which have the task to support the soft filtering medium).

Very useful information is presented in Fig.16. The mass flow rate from the upper surface of the filtering media is shown there. It can be seen, that the filtering medium is very non-uniformly loaded in this case.

5 Conclusions

The Navier-Stokes-Brinkman system can be successfully used for simulating flows in plain and in porous media. The numerical algorithm presented here works very well for simulating coupled flows both, with isotropic and with anisotropic permeability tensors. The numerical simulations of 3-D oil flow through car filters provide useful information, which assist engineers in designing filters with better performance.

References

1. Ph. Angot : Analysis of singular perturbations on the Brinkman problem for fictitious domain models of viscous flows. *Math. Meth. Appl. Sci.* **22** (1999) 1395–1412.
2. J. Bear, Y. Bachmat: *Introduction to modeling of transport phenomena in porous media*. Kluwer Academic Publishers, Dordrecht etc., 1990.
3. G.S. Beavers, D.D. Joseph : Boundary conditions at a naturally permeable wall. *J. Fluid Mech.* **30** (1967) 197–207.
4. C.A.J.Fletcher : *Computational techniques for fluid dynamics. Vol. 2: Specific techniques for different flow categories*. Springer, Berlin etc., 1991.
5. U. Ghia, K.N. Ghia, C.T. Shin : High-Re solutions for incompressible flow using the Navier-Stokes equations and a multigrid method. *J.Comput. Phys.* **48** (1982) 387-411.
6. O. Iliev, D.Stoyanov: On a flexible tool for upscaling porous media flow problems. *J. Theoretical and Applied Mechanics.* **31**, No.1 (2001) 18-30.
7. W. Jäger, A. Mikelić : On the boundary conditions at the contact interface between a porous medium and a free fluid. *Ann. Sc. Norm. Super. Pisa, Cl. Sci.,IV.* **23** (1996) 403-465.
8. W. Jäger, A. Mikelic, N. Neuss : Asymptotic analysis of the laminar viscous flow over a porous bed. *SIAM J. Sci. Comput.* **22** (2001) 2006-2028.
9. M. Kaviany: *Principles of Heat Transfer in Porous media* Springer, New York etc., 1991.
10. W.J. Layton, F. Schieweck, I. Yotov: Coupling Fluid Flow with Porous Media Flow. Universität Magdeburg, Fakultät für Mathematik, Preprint **22** (2001) 1-24.
11. T. Levy, E. Sanchez-Palencia : On boundary conditions for fluid flow in porous media. *Int. J Engng Sci* **13** (1975) 923–940.
12. N. Massarotti, P. Nithiarasu, O.C. Zienkiewicz : Porous-Fluid Interface Problems. A Characteristic-Based-Split (CBS) Procedure. ECCOMAS 2000, Barcelona 11-14 Sep. 2000.
13. A. Mikelić : Homogenization theory and applications to filtration through porous media. *Filtration in Porous Media and Industrial Applications*. Centro Internazionale Matematico Estivo (C.I.M.E.) Series, Lecture Notes in Mathematics, Springer, (2000), 1-86.
14. J.A. Ochoa-Tapia, S. Whitaker : Momentum transfer at the boundary between a porous medium and a homogeneous fluid. I. Theoretical development., II. Comparison with experiment. *Int.J.Heat Mass Transfer*, **38**, (1995) 2635–2656.
15. J.H. Ferziger, M. Peric: *Computational methods for fluid dynamics*. Springer, Berlin, 1996.
16. S. Rief, Private communication
17. H.K. Versteeg, W. Malalasekera, *An Introduction to Computational Fluid Dynamics* Longman Scientific & Technical, Malaysia, 1995.
18. Fraunhofer Institut für Techno und Wirtschaftsmathematik, Kaiserslautern, Germany. Annual Reports 2000, 2001. <http://www.itwm.fhg.de> (Menu: Publications.Annual Report.2000; Annual Report.2001)

The PDF-files of the following reports are available under:
www.itwm.fraunhofer.de/rd/presse/berichte

1. D. Hietel, K. Steiner, J. Struckmeier
A Finite - Volume Particle Method for Compressible Flows

We derive a new class of particle methods for conservation laws, which are based on numerical flux functions to model the interactions between moving particles. The derivation is similar to that of classical Finite-Volume methods; except that the fixed grid structure in the Finite-Volume method is substituted by so-called mass packets of particles. We give some numerical results on a shock wave solution for Burgers equation as well as the well-known one-dimensional shock tube problem.
(19 pages, 1998)

2. M. Feldmann, S. Seibold
Damage Diagnosis of Rotors: Application of Hilbert Transform and Multi-Hypothesis Testing

In this paper, a combined approach to damage diagnosis of rotors is proposed. The intention is to employ signal-based as well as model-based procedures for an improved detection of size and location of the damage. In a first step, Hilbert transform signal processing techniques allow for a computation of the signal envelope and the instantaneous frequency, so that various types of non-linearities due to a damage may be identified and classified based on measured response data. In a second step, a multi-hypothesis bank of Kalman Filters is employed for the detection of the size and location of the damage based on the information of the type of damage provided by the results of the Hilbert transform.

Keywords: Hilbert transform, damage diagnosis, Kalman filtering, non-linear dynamics
(23 pages, 1998)

3. Y. Ben-Haim, S. Seibold
Robust Reliability of Diagnostic Multi-Hypothesis Algorithms: Application to Rotating Machinery

Damage diagnosis based on a bank of Kalman filters, each one conditioned on a specific hypothesized system condition, is a well recognized and powerful diagnostic tool. This multi-hypothesis approach can be applied to a wide range of damage conditions. In this paper, we will focus on the diagnosis of cracks in rotating machinery. The question we address is: how to optimize the multi-hypothesis algorithm with respect to the uncertainty of the spatial form and location of cracks and their resulting dynamic effects. First, we formulate a measure of the reliability of the diagnostic algorithm, and then we discuss modifications of the diagnostic algorithm for the maximization of the reliability. The reliability of a diagnostic algorithm is measured by the amount of uncertainty consistent with no-failure of the diagnosis. Uncertainty is quantitatively represented with convex models.

Keywords: Robust reliability, convex models, Kalman filtering, multi-hypothesis diagnosis, rotating machinery, crack diagnosis
(24 pages, 1998)

4. F.-Th. Lentjes, N. Siedow
Three-dimensional Radiative Heat Transfer in Glass Cooling Processes

For the numerical simulation of 3D radiative heat transfer in glasses and glass melts, practically applicable mathematical methods are needed to handle such problems optimal using workstation class computers. Since the exact solution would require super-computer capabilities we concentrate on approximate solutions with a high degree of accuracy. The following approaches are studied: 3D diffusion approximations and 3D ray-tracing methods.
(23 pages, 1998)

5. A. Klar, R. Wegener
A hierarchy of models for multilane vehicular traffic
Part I: Modeling

In the present paper multilane models for vehicular traffic are considered. A microscopic multilane model based on reaction thresholds is developed. Based on this model an Enskog like kinetic model is developed. In particular, care is taken to incorporate the correlations between the vehicles. From the kinetic model a fluid dynamic model is derived. The macroscopic coefficients are deduced from the underlying kinetic model. Numerical simulations are presented for all three levels of description in [10]. Moreover, a comparison of the results is given there.
(23 pages, 1998)

Part II: Numerical and stochastic investigations

In this paper the work presented in [6] is continued. The present paper contains detailed numerical investigations of the models developed there. A numerical method to treat the kinetic equations obtained in [6] are presented and results of the simulations are shown. Moreover, the stochastic correlation model used in [6] is described and investigated in more detail.
(17 pages, 1998)

6. A. Klar, N. Siedow
Boundary Layers and Domain Decomposition for Radiative Heat Transfer and Diffusion Equations: Applications to Glass Manufacturing Processes

In this paper domain decomposition methods for radiative transfer problems including conductive heat transfer are treated. The paper focuses on semi-transparent materials, like glass, and the associated conditions at the interface between the materials. Using asymptotic analysis we derive conditions for the coupling of the radiative transfer equations and a diffusion approximation. Several test cases are treated and a problem appearing in glass manufacturing processes is computed. The results clearly show the advantages of a domain decomposition approach. Accuracy equivalent to the solution of the global radiative transfer solution is achieved, whereas computation time is strongly reduced.
(24 pages, 1998)

7. I. Choquet
Heterogeneous catalysis modelling and numerical simulation in rarified gas flows
Part I: Coverage locally at equilibrium

A new approach is proposed to model and simulate numerically heterogeneous catalysis in rarefied gas flows. It is developed to satisfy all together the following points:

- 1) describe the gas phase at the microscopic scale, as required in rarefied flows,
- 2) describe the wall at the macroscopic scale, to avoid prohibitive computational costs and consider not only crystalline but also amorphous surfaces,
- 3) reproduce on average macroscopic laws correlated with experimental results and
- 4) derive analytic models in a systematic and exact way. The problem is stated in the general framework of a non static flow in the vicinity of a catalytic and non porous surface (without aging). It is shown that the exact and systematic resolution method based on the Laplace transform, introduced previously by the author to model collisions in the gas phase, can be extended to the present problem. The proposed approach is applied to the modelling of the EleyRideal and LangmuirHinshelwood recombinations, assuming that the coverage is locally at equilibrium. The models are developed considering one atomic species and extended to the general case of several atomic species. Numerical calculations show that the models derived in this way reproduce with accuracy behaviors observed experimentally.
(24 pages, 1998)

8. J. Ohser, B. Steinbach, C. Lang
Efficient Texture Analysis of Binary Images

A new method of determining some characteristics of binary images is proposed based on a special linear filtering. This technique enables the estimation of the area fraction, the specific line length, and the specific integral of curvature. Furthermore, the specific length of the total projection is obtained, which gives detailed information about the texture of the image. The influence of lateral and directional resolution depending on the size of the applied filter mask is discussed in detail. The technique includes a method of increasing directional resolution for texture analysis while keeping lateral resolution as high as possible.
(17 pages, 1998)

9. J. Orlik
Homogenization for viscoelasticity of the integral type with aging and shrinkage

A multiphase composite with periodic distributed inclusions with a smooth boundary is considered in this contribution. The composite component materials are supposed to be linear viscoelastic and aging (of the nonconvolution integral type, for which the Laplace transform with respect to time is not effectively applicable) and are subjected to isotropic shrinkage. The free shrinkage deformation can be considered as a fictitious temperature deformation in the behavior law. The procedure presented in this paper proposes a way to determine average (effective homogenized) viscoelastic and shrinkage (temperature) composite properties and the homogenized stressfield from known properties of the components. This is done by the extension of the asymptotic homogenization technique known for pure elastic nonhomogeneous bodies to the nonhomogeneous thermoviscoelasticity of the integral noncon-

olution type. Up to now, the homogenization theory has not covered viscoelasticity of the integral type. SanchezPalencia (1980), Francfort & Suquet (1987) (see [2], [9]) have considered homogenization for viscoelasticity of the differential form and only up to the first derivative order. The integral modeled viscoelasticity is more general than the differential one and includes almost all known differential models. The homogenization procedure is based on the construction of an asymptotic solution with respect to a period of the composite structure. This reduces the original problem to some auxiliary boundary value problems of elasticity and viscoelasticity on the unit periodic cell, of the same type as the original non-homogeneous problem. The existence and uniqueness results for such problems were obtained for kernels satisfying some constraint conditions. This is done by the extension of the Volterra integral operator theory to the Volterra operators with respect to the time, whose 1 kernels are space linear operators for any fixed time variables. Some ideas of such approach were proposed in [11] and [12], where the Volterra operators with kernels depending additionally on parameter were considered. This manuscript delivers results of the same nature for the case of the spaceoperator kernels.
(20 pages, 1998)

10. J. Mohring

Helmholtz Resonators with Large Aperture

The lowest resonant frequency of a cavity resonator is usually approximated by the classical Helmholtz formula. However, if the opening is rather large and the front wall is narrow this formula is no longer valid. Here we present a correction which is of third order in the ratio of the diameters of aperture and cavity. In addition to the high accuracy it allows to estimate the damping due to radiation. The result is found by applying the method of matched asymptotic expansions. The correction contains form factors describing the shapes of opening and cavity. They are computed for a number of standard geometries. Results are compared with numerical computations.
(21 pages, 1998)

11. H. W. Hamacher, A. Schöbel

On Center Cycles in Grid Graphs

Finding "good" cycles in graphs is a problem of great interest in graph theory as well as in locational analysis. We show that the center and median problems are NP hard in general graphs. This result holds both for the variable cardinality case (i.e. all cycles of the graph are considered) and the fixed cardinality case (i.e. only cycles with a given cardinality p are feasible). Hence it is of interest to investigate special cases where the problem is solvable in polynomial time. In grid graphs, the variable cardinality case is, for instance, trivially solvable if the shape of the cycle can be chosen freely. If the shape is fixed to be a rectangle one can analyze rectangles in grid graphs with, in sequence, fixed dimension, fixed cardinality, and variable cardinality. In all cases a complete characterization of the optimal cycles and closed form expressions of the optimal objective values are given, yielding polynomial time algorithms for all cases of center rectangle problems. Finally, it is shown that center cycles can be chosen as rectangles for small cardinalities such that the center cycle problem in grid graphs is in these cases completely solved.
(15 pages, 1998)

12. H. W. Hamacher, K.-H. Küfer

Inverse radiation therapy planning - a multiple objective optimisation approach

For some decades radiation therapy has been proved successful in cancer treatment. It is the major task of clinical radiation treatment planning to realize on the one hand a high level dose of radiation in the cancer tissue in order to obtain maximum tumor control. On the other hand it is obvious that it is absolutely necessary to keep in the tissue outside the tumor, particularly in organs at risk, the unavoidable radiation as low as possible.

No doubt, these two objectives of treatment planning - high level dose in the tumor, low radiation outside the tumor - have a basically contradictory nature. Therefore, it is no surprise that inverse mathematical models with dose distribution bounds tend to be infeasible in most cases. Thus, there is need for approximations compromising between overdosing the organs at risk and underdosing the target volume.

Differing from the currently used time consuming iterative approach, which measures deviation from an ideal (non-achievable) treatment plan using recursively trial-and-error weights for the organs of interest, we go a new way trying to avoid a priori weight choices and consider the treatment planning problem as a multiple objective linear programming problem: with each organ of interest, target tissue as well as organs at risk, we associate an objective function measuring the maximal deviation from the prescribed doses.

We build up a data base of relatively few efficient solutions representing and approximating the variety of Pareto solutions of the multiple objective linear programming problem. This data base can be easily scanned by physicians looking for an adequate treatment plan with the aid of an appropriate online tool.
(14 pages, 1999)

13. C. Lang, J. Ohser, R. Hilfer

On the Analysis of Spatial Binary Images

This paper deals with the characterization of microscopically heterogeneous, but macroscopically homogeneous spatial structures. A new method is presented which is strictly based on integral-geometric formulae such as Crofton's intersection formulae and Hadwiger's recursive definition of the Euler number. The corresponding algorithms have clear advantages over other techniques. As an example of application we consider the analysis of spatial digital images produced by means of Computer Assisted Tomography.
(20 pages, 1999)

14. M. Junk

On the Construction of Discrete Equilibrium Distributions for Kinetic Schemes

A general approach to the construction of discrete equilibrium distributions is presented. Such distribution functions can be used to set up Kinetic Schemes as well as Lattice Boltzmann methods. The general principles are also applied to the construction of Chapman Enskog distributions which are used in Kinetic Schemes for compressible Navier-Stokes equations.
(24 pages, 1999)

15. M. Junk, S. V. Raghurame Rao

A new discrete velocity method for Navier-Stokes equations

The relation between the Lattice Boltzmann Method, which has recently become popular, and the Kinetic Schemes, which are routinely used in Computational Fluid Dynamics, is explored. A new discrete velocity model for the numerical solution of Navier-Stokes equations for incompressible fluid flow is presented by combining both the approaches. The new scheme can be interpreted as a pseudo-compressibility method and, for a particular choice of parameters, this interpretation carries over to the Lattice Boltzmann Method.
(20 pages, 1999)

16. H. Neunzert

Mathematics as a Key to Key Technologies

The main part of this paper will consist of examples, how mathematics really helps to solve industrial problems; these examples are taken from our Institute for Industrial Mathematics, from research in the Technomathematics group at my university, but also from ECMI groups and a company called TecMath, which originated 10 years ago from my university group and has already a very successful history.
(39 pages (4 PDF-Files), 1999)

17. J. Ohser, K. Sandau

Considerations about the Estimation of the Size Distribution in Wicksell's Corpuscle Problem

Wicksell's corpuscle problem deals with the estimation of the size distribution of a population of particles, all having the same shape, using a lower dimensional sampling probe. This problem was originally formulated for particle systems occurring in life sciences but its solution is of actual and increasing interest in materials science. From a mathematical point of view, Wicksell's problem is an inverse problem where the interesting size distribution is the unknown part of a Volterra equation. The problem is often regarded ill-posed, because the structure of the integrand implies unstable numerical solutions. The accuracy of the numerical solutions is considered here using the condition number, which allows to compare different numerical methods with different (equidistant) class sizes and which indicates, as one result, that a finite section thickness of the probe reduces the numerical problems. Furthermore, the relative error of estimation is computed which can be split into two parts. One part consists of the relative discretization error that increases for increasing class size, and the second part is related to the relative statistical error which increases with decreasing class size. For both parts, upper bounds can be given and the sum of them indicates an optimal class width depending on some specific constants.
(18 pages, 1999)

18. E. Carrizosa, H. W. Hamacher, R. Klein, S. Nickel

Solving nonconvex planar location problems by finite dominating sets

It is well-known that some of the classical location problems with polyhedral gauges can be solved in polynomial time by finding a finite dominating set, i.e. a finite set of candidates guaranteed to contain at least one optimal location. In this paper it is first established that this result holds

for a much larger class of problems than currently considered in the literature. The model for which this result can be proven includes, for instance, location problems with attraction and repulsion, and location-allocation problems.

Next, it is shown that the approximation of general gauges by polyhedral ones in the objective function of our general model can be analyzed with regard to the subsequent error in the optimal objective value. For the approximation problem two different approaches are described, the sandwich procedure and the greedy algorithm. Both of these approaches lead - for fixed epsilon - to polynomial approximation algorithms with accuracy epsilon for solving the general model considered in this paper.

Keywords: Continuous Location, Polyhedral Gauges, Finite Dominating Sets, Approximation, Sandwich Algorithm, Greedy Algorithm
(19 pages, 2000)

19. A. Becker

A Review on Image Distortion Measures

Within this paper we review image distortion measures. A distortion measure is a criterion that assigns a "quality number" to an image. We distinguish between mathematical distortion measures and those distortion measures in-cooperating a priori knowledge about the imaging devices (e.g. satellite images), image processing algorithms or the human physiology. We will consider representative examples of different kinds of distortion measures and are going to discuss them.

Keywords: Distortion measure, human visual system
(26 pages, 2000)

20. H. W. Hamacher, M. Labbé, S. Nickel,
T. Sonneborn

Polyhedral Properties of the Uncapacitated Multiple Allocation Hub Location Problem

We examine the feasibility polyhedron of the uncapacitated hub location problem (UHL) with multiple allocation, which has applications in the fields of air passenger and cargo transportation, telecommunication and postal delivery services. In particular we determine the dimension and derive some classes of facets of this polyhedron. We develop some general rules about lifting facets from the uncapacitated facility location (UFL) for UHL and projecting facets from UHL to UFL. By applying these rules we get a new class of facets for UHL which dominates the inequalities in the original formulation. Thus we get a new formulation of UHL whose constraints are all facet-defining. We show its superior computational performance by benchmarking it on a well known data set.

Keywords: integer programming, hub location, facility location, valid inequalities, facets, branch and cut
(21 pages, 2000)

21. H. W. Hamacher, A. Schöbel

Design of Zone Tariff Systems in Public Transportation

Given a public transportation system represented by its stops and direct connections between stops, we consider two problems dealing with the prices for the customers: The fare problem in which subsets of stops are already aggregated to zones and "good" tariffs have to be found in the existing zone system. Closed form solutions for the fare problem are presented for three objective functions. In the zone problem the design of the zones is part of the problem. This problem is NP

hard and we therefore propose three heuristics which prove to be very successful in the redesign of one of Germany's transportation systems.
(30 pages, 2001)

22. D. Hietel, M. Junk, R. Keck, D. Teleaga:

The Finite-Volume-Particle Method for Conservation Laws

In the Finite-Volume-Particle Method (FVPM), the weak formulation of a hyperbolic conservation law is discretized by restricting it to a discrete set of test functions. In contrast to the usual Finite-Volume approach, the test functions are not taken as characteristic functions of the control volumes in a spatial grid, but are chosen from a partition of unity with smooth and overlapping partition functions (the particles), which can even move along prescribed velocity fields. The information exchange between particles is based on standard numerical flux functions. Geometrical information, similar to the surface area of the cell faces in the Finite-Volume Method and the corresponding normal directions are given as integral quantities of the partition functions. After a brief derivation of the Finite-Volume-Particle Method, this work focuses on the role of the geometric coefficients in the scheme.
(16 pages, 2001)

23. T. Bender, H. Hennes, J. Kalcsics,
M. T. Melo, S. Nickel

Location Software and Interface with GIS and Supply Chain Management

The objective of this paper is to bridge the gap between location theory and practice. To meet this objective focus is given to the development of software capable of addressing the different needs of a wide group of users. There is a very active community on location theory encompassing many research fields such as operations research, computer science, mathematics, engineering, geography, economics and marketing. As a result, people working on facility location problems have a very diverse background and also different needs regarding the software to solve these problems. For those interested in non-commercial applications (e.g. students and researchers), the library of location algorithms (LoLA) can be of considerable assistance. LoLA contains a collection of efficient algorithms for solving planar, network and discrete facility location problems. In this paper, a detailed description of the functionality of LoLA is presented. In the fields of geography and marketing, for instance, solving facility location problems requires using large amounts of demographic data. Hence, members of these groups (e.g. urban planners and sales managers) often work with geographical information too. To address the specific needs of these users, LoLA was linked to a geographical information system (GIS) and the details of the combined functionality are described in the paper. Finally, there is a wide group of practitioners who need to solve large problems and require special purpose software with a good data interface. Many of such users can be found, for example, in the area of supply chain management (SCM). Logistics activities involved in strategic SCM include, among others, facility location planning. In this paper, the development of a commercial location software tool is also described. The tool is embedded in the Advanced Planner and Optimizer SCM software developed by SAP AG, Wall-dorf, Germany. The paper ends with some conclusions and an outlook to future activities.

Keywords: facility location, software development,

geographical information systems, supply chain management.
(48 pages, 2001)

24. H. W. Hamacher, S. A. Tjandra

Mathematical Modelling of Evacuation Problems: A State of Art

This paper details models and algorithms which can be applied to evacuation problems. While it concentrates on building evacuation many of the results are applicable also to regional evacuation. All models consider the time as main parameter, where the travel time between components of the building is part of the input and the overall evacuation time is the output. The paper distinguishes between macroscopic and microscopic evacuation models both of which are able to capture the evacuees' movement over time.

Macroscopic models are mainly used to produce good lower bounds for the evacuation time and do not consider any individual behavior during the emergency situation. These bounds can be used to analyze existing buildings or help in the design phase of planning a building. Macroscopic approaches which are based on dynamic network flow models (minimum cost dynamic flow, maximum dynamic flow, universal maximum flow, quickest path and quickest flow) are described. A special feature of the presented approach is the fact, that travel times of evacuees are not restricted to be constant, but may be density dependent. Using multi-criteria optimization priority regions and blockage due to fire or smoke may be considered. It is shown how the modelling can be done using time parameter either as discrete or continuous parameter.

Microscopic models are able to model the individual evacuee's characteristics and the interaction among evacuees which influence their movement. Due to the corresponding huge amount of data one uses simulation approaches. Some probabilistic laws for individual evacuee's movement are presented. Moreover ideas to model the evacuee's movement using cellular automata (CA) and resulting software are presented. In this paper we will focus on macroscopic models and only summarize some of the results of the microscopic approach. While most of the results are applicable to general evacuation situations, we concentrate on building evacuation.
(44 pages, 2001)

25. J. Kuhnert, S. Tiwari

Grid free method for solving the Poisson equation

A Grid free method for solving the Poisson equation is presented. This is an iterative method. The method is based on the weighted least squares approximation in which the Poisson equation is enforced to be satisfied in every iterations. The boundary conditions can also be enforced in the iteration process. This is a local approximation procedure. The Dirichlet, Neumann and mixed boundary value problems on a unit square are presented and the analytical solutions are compared with the exact solutions. Both solutions matched perfectly.

Keywords: Poisson equation, Least squares method, Grid free method
(19 pages, 2001)

26. T. Götz, H. Rave, D. Reinel-Bitzer,
K. Steiner, H. Tiemeier

Simulation of the fiber spinning process

To simulate the influence of process parameters to the melt spinning process a fiber model is used and coupled with CFD calculations of the quench air flow. In the fiber model energy, momentum and mass balance are solved for the polymer mass flow. To calculate the quench air the Lattice Boltzmann method is used. Simulations and experiments for different process parameters and hole configurations are compared and show a good agreement.

Keywords: Melt spinning, fiber model, Lattice Boltzmann, CFD
(19 pages, 2001)

27. A. Zemitis

On interaction of a liquid film with an obstacle

In this paper mathematical models for liquid films generated by impinging jets are discussed. Attention is stressed to the interaction of the liquid film with some obstacle. S. G. Taylor [Proc. R. Soc. London Ser. A 253, 313 (1959)] found that the liquid film generated by impinging jets is very sensitive to properties of the wire which was used as an obstacle. The aim of this presentation is to propose a modification of the Taylor's model, which allows to simulate the film shape in cases, when the angle between jets is different from 180°. Numerical results obtained by discussed models give two different shapes of the liquid film similar as in Taylor's experiments. These two shapes depend on the regime: either droplets are produced close to the obstacle or not. The difference between two regimes becomes larger if the angle between jets decreases. Existence of such two regimes can be very essential for some applications of impinging jets, if the generated liquid film can have a contact with obstacles.

Keywords: impinging jets, liquid film, models, numerical solution, shape
(22 pages, 2001)

28. I. Ginzburg, K. Steiner

Free surface lattice-Boltzmann method to model the filling of expanding cavities by Bingham Fluids

The filling process of viscoplastic metal alloys and plastics in expanding cavities is modelled using the lattice Boltzmann method in two and three dimensions. These models combine the regularized Bingham model for viscoplastic with a free-interface algorithm. The latter is based on a modified immiscible lattice Boltzmann model in which one species is the fluid and the other one is considered as vacuum. The boundary conditions at the curved liquid-vacuum interface are met without any geometrical front reconstruction from a first-order Chapman-Enskog expansion. The numerical results obtained with these models are found in good agreement with available theoretical and numerical analysis. *Keywords: Generalized LBE, free-surface phenomena, interface boundary conditions, filling processes, Bingham viscoplastic model, regularized models*
(22 pages, 2001)

29. H. Neunzert

»Denn nichts ist für den Menschen als Menschen etwas wert, was er nicht mit Leidenschaft tun kann«

Vortrag anlässlich der Verleihung des Akademiepreises des Landes Rheinland-Pfalz am 21.11.2001

Was macht einen guten Hochschullehrer aus? Auf diese Frage gibt es sicher viele verschiedene, fachbezogene Antworten, aber auch ein paar allgemeine Gesichtspunkte: es bedarf der »Leidenschaft« für die Forschung (Max Weber), aus der dann auch die Begeisterung für die Lehre erwächst. Forschung und Lehre gehören zusammen, um die Wissenschaft als lebendiges Tun vermitteln zu können. Der Vortrag gibt Beispiele dafür, wie in angewandter Mathematik Forschungsaufgaben aus praktischen Alltagsproblemstellungen erwachsen, die in die Lehre auf verschiedenen Stufen (Gymnasium bis Graduiertenkolleg) einfließen; er leitet damit auch zu einem aktuellen Forschungsgebiet, der Mehrskalalanalyse mit ihren vielfältigen Anwendungen in Bildverarbeitung, Materialentwicklung und Strömungsmechanik über, was aber nur kurz gestreift wird. Mathematik erscheint hier als eine moderne Schlüsseltechnologie, die aber auch enge Beziehungen zu den Geistes- und Sozialwissenschaften hat.

Keywords: Lehre, Forschung, angewandte Mathematik, Mehrskalalanalyse, Strömungsmechanik
(18 pages, 2001)

30. J. Kuhnert, S. Tiwari

Finite pointset method based on the projection method for simulations of the incompressible Navier-Stokes equations

A Lagrangian particle scheme is applied to the projection method for the incompressible Navier-Stokes equations. The approximation of spatial derivatives is obtained by the weighted least squares method. The pressure Poisson equation is solved by a local iterative procedure with the help of the least squares method. Numerical tests are performed for two dimensional cases. The Couette flow, Poiseuille flow, decaying shear flow and the driven cavity flow are presented. The numerical solutions are obtained for stationary as well as instationary cases and are compared with the analytical solutions for channel flows. Finally, the driven cavity in a unit square is considered and the stationary solution obtained from this scheme is compared with that from the finite element method.

Keywords: Incompressible Navier-Stokes equations, Meshfree method, Projection method, Particle scheme, Least squares approximation
AMS subject classification: 76D05, 76M28
(25 pages, 2001)

31. R. Korn, M. Krekel

Optimal Portfolios with Fixed Consumption or Income Streams

We consider some portfolio optimisation problems where either the investor has a desire for an a priori specified consumption stream or/and follows a deterministic pay in scheme while also trying to maximize expected utility from final wealth. We derive explicit closed form solutions for continuous and discrete monetary streams. The mathematical method used is classical stochastic control theory.

Keywords: Portfolio optimisation, stochastic control, HJB equation, discretisation of control problems.
(23 pages, 2002)

32. M. Krekel

Optimal portfolios with a loan dependent credit spread

If an investor borrows money he generally has to pay higher interest rates than he would have received, if he had put his funds on a savings account. The classical model of continuous time portfolio optimisation ignores this effect. Since there is obviously a connection between the default probability and the total percentage of wealth, which the investor is in debt, we study portfolio optimisation with a control dependent interest rate. Assuming a logarithmic and a power utility function, respectively, we prove explicit formulae of the optimal control.

Keywords: Portfolio optimisation, stochastic control, HJB equation, credit spread, log utility, power utility, non-linear wealth dynamics
(25 pages, 2002)

33. J. Ohser, W. Nagel, K. Schladitz

The Euler number of discretized sets - on the choice of adjacency in homogeneous lattices

Two approaches for determining the Euler-Poincaré characteristic of a set observed on lattice points are considered in the context of image analysis { the integral geometric and the polyhedral approach. Information about the set is assumed to be available on lattice points only. In order to retain properties of the Euler number and to provide a good approximation of the true Euler number of the original set in the Euclidean space, the appropriate choice of adjacency in the lattice for the set and its background is crucial. Adjacencies are defined using tessellations of the whole space into polyhedrons. In \mathbb{R}^3 , two new 14 adjacencies are introduced additionally to the well known 6 and 26 adjacencies. For the Euler number of a set and its complement, a consistency relation holds. Each of the pairs of adjacencies (14:1; 14:1), (14:2; 14:2), (6; 26), and (26; 6) is shown to be a pair of complementary adjacencies with respect to this relation. That is, the approximations of the Euler numbers are consistent if the set and its background (complement) are equipped with this pair of adjacencies. Furthermore, sufficient conditions for the correctness of the approximations of the Euler number are given. The analysis of selected microstructures and a simulation study illustrate how the estimated Euler number depends on the chosen adjacency. It also shows that there is not a uniquely best pair of adjacencies with respect to the estimation of the Euler number of a set in Euclidean space.

Keywords: image analysis, Euler number, neighborhood relationships, cuboidal lattice
(32 pages, 2002)

34. I. Ginzburg, K. Steiner

Lattice Boltzmann Model for Free-Surface Flow and Its Application to Filling Process in Casting

A generalized lattice Boltzmann model to simulate free-surface is constructed in both two and three dimensions. The proposed model satisfies the interfacial boundary conditions accurately. A distinctive feature of the model is that the collision processes is carried out only on the points occupied partially or fully by the fluid. To maintain a sharp interfacial front, the method includes an anti-diffusion algorithm. The unknown distribution functions at the interfacial region are constructed according to the first order Chapman-Enskog analysis. The interfacial boundary conditions are satis-

fied exactly by the coefficients in the Chapman-Enskog expansion. The distribution functions are naturally expressed in the local interfacial coordinates. The macroscopic quantities at the interface are extracted from the least-square solutions of a locally linearized system obtained from the known distribution functions. The proposed method does not require any geometric front construction and is robust for any interfacial topology. Simulation results of realistic filling process are presented: rectangular cavity in two dimensions and Hammer box, Campbell box, Sheffield box, and Motorblock in three dimensions. To enhance the stability at high Reynolds numbers, various upwind-type schemes are developed. Free-slip and no-slip boundary conditions are also discussed.

Keywords: Lattice Boltzmann models; free-surface phenomena; interface boundary conditions; filling processes; injection molding; volume of fluid method; interface boundary conditions; advection-schemes; upwind-schemes
(54 pages, 2002)

35. M. Günther, A. Klar, T. Materne, R. Wegener

Multivalued fundamental diagrams and stop and go waves for continuum traffic equations

In the present paper a kinetic model for vehicular traffic leading to multivalued fundamental diagrams is developed and investigated in detail. For this model phase transitions can appear depending on the local density and velocity of the flow. A derivation of associated macroscopic traffic equations from the kinetic equation is given. Moreover, numerical experiments show the appearance of stop and go waves for highway traffic with a bottleneck.

Keywords: traffic flow, macroscopic equations, kinetic derivation, multivalued fundamental diagram, stop and go waves, phase transitions
(25 pages, 2002)

36. S. Feldmann, P. Lang, D. Prätzel-Wolters
Parameter influence on the zeros of network determinants

To a network $N(q)$ with determinant $D(s; q)$ depending on a parameter vector $q \in \mathbb{R}^r$ via identification of some of its vertices, a network $N^\wedge(q)$ is assigned. The paper deals with procedures to find $N^\wedge(q)$, such that its determinant $D^\wedge(s; q)$ admits a factorization in the determinants of appropriate subnetworks, and with the estimation of the deviation of the zeros of D^\wedge from the zeros of D . To solve the estimation problem state space methods are applied.

Keywords: Networks, Equicofactor matrix polynomials, Realization theory, Matrix perturbation theory
(30 pages, 2002)

37. K. Koch, J. Ohser, K. Schladitz
Spectral theory for random closed sets and estimating the covariance via frequency space

A spectral theory for stationary random closed sets is developed and provided with a sound mathematical basis. Definition and proof of existence of the Bartlett spectrum of a stationary random closed set as well as the proof of a Wiener-Khinchine theorem for the power spectrum are used to two ends: First, well known second order characteristics like the covariance

can be estimated faster than usual via frequency space. Second, the Bartlett spectrum and the power spectrum can be used as second order characteristics in frequency space. Examples show, that in some cases information about the random closed set is easier to obtain from these characteristics in frequency space than from their real world counterparts.

Keywords: Random set, Bartlett spectrum, fast Fourier transform, power spectrum
(28 pages, 2002)

38. D. d'Humières, I. Ginzburg
Multi-reflection boundary conditions for lattice Boltzmann models

We present a unified approach of several boundary conditions for lattice Boltzmann models. Its general framework is a generalization of previously introduced schemes such as the bounce-back rule, linear or quadratic interpolations, etc. The objectives are two fold: first to give theoretical tools to study the existing boundary conditions and their corresponding accuracy; secondly to design formally third-order accurate boundary conditions for general flows. Using these boundary conditions, Couette and Poiseuille flows are exact solution of the lattice Boltzmann models for a Reynolds number $Re = 0$ (Stokes limit).

Numerical comparisons are given for Stokes flows in periodic arrays of spheres and cylinders, linear periodic array of cylinders between moving plates and for Navier-Stokes flows in periodic arrays of cylinders for $Re < 200$. These results show a significant improvement of the overall accuracy when using the linear interpolations instead of the bounce-back reflection (up to an order of magnitude on the hydrodynamics fields). Further improvement is achieved with the new multi-reflection boundary conditions, reaching a level of accuracy close to the quasi-analytical reference solutions, even for rather modest grid resolutions and few points in the narrowest channels. More important, the pressure and velocity fields in the vicinity of the obstacles are much smoother with multi-reflection than with the other boundary conditions.

Finally the good stability of these schemes is highlighted by some simulations of moving obstacles: a cylinder between flat walls and a sphere in a cylinder.
Keywords: lattice Boltzmann equation, boundary conditions, bounce-back rule, Navier-Stokes equation
(72 pages, 2002)

39. R. Korn
Elementare Finanzmathematik

Im Rahmen dieser Arbeit soll eine elementar gehaltene Einführung in die Aufgabenstellungen und Prinzipien der modernen Finanzmathematik gegeben werden. Insbesondere werden die Grundlagen der Modellierung von Aktienkursen, der Bewertung von Optionen und der Portfolio-Optimierung vorgestellt. Natürlich können die verwendeten Methoden und die entwickelte Theorie nicht in voller Allgemeinheit für den Schulunterricht verwendet werden, doch sollen einzelne Prinzipien so heraus gearbeitet werden, dass sie auch an einfachen Beispielen verstanden werden können.

Keywords: Finanzmathematik, Aktien, Optionen, Portfolio-Optimierung, Börse, Lehrerweiterbildung, Mathematikunterricht
(98 pages, 2002)

40. J. Kallrath, M. C. Müller, S. Nickel

Batch Presorting Problems: Models and Complexity Results

In this paper we consider short term storage systems. We analyze presorting strategies to improve the efficiency of these storage systems. The presorting task is called Batch PreSorting Problem (BPSP). The BPSP is a variation of an assignment problem, i. e., it has an assignment problem kernel and some additional constraints. We present different types of these presorting problems, introduce mathematical programming formulations and prove the NP-completeness for one type of the BPSP. Experiments are carried out in order to compare the different model formulations and to investigate the behavior of these models.

Keywords: Complexity theory, Integer programming, Assignment, Logistics
(19 pages, 2002)

41. J. Linn

On the frame-invariant description of the phase space of the Folgar-Tucker equation

The Folgar-Tucker equation is used in flow simulations of fiber suspensions to predict fiber orientation depending on the local flow. In this paper, a complete, frame-invariant description of the phase space of this differential equation is presented for the first time.

Key words: fiber orientation, Folgar-Tucker equation, injection molding
(5 pages, 2003)

42. T. Hanne, S. Nickel

A Multi-Objective Evolutionary Algorithm for Scheduling and Inspection Planning in Software Development Projects

In this article, we consider the problem of planning inspections and other tasks within a software development (SD) project with respect to the objectives quality (no. of defects), project duration, and costs. Based on a discrete-event simulation model of SD processes comprising the phases coding, inspection, test, and rework, we present a simplified formulation of the problem as a multiobjective optimization problem. For solving the problem (i. e. finding an approximation of the efficient set) we develop a multiobjective evolutionary algorithm. Details of the algorithm are discussed as well as results of its application to sample problems.

Key words: multiple objective programming, project management and scheduling, software development, evolutionary algorithms, efficient set
(29 pages, 2003)

43. T. Bortfeld, K.-H. Küfer, M. Monz, A. Scherrer, C. Thieke, H. Trinkaus

Intensity-Modulated Radiotherapy - A Large Scale Multi-Criteria Programming Problem -

Radiation therapy planning is always a tight rope walk between dangerous insufficient dose in the target volume and life threatening overdosing of organs at risk. Finding ideal balances between these inherently contradictory goals challenges dosimetrists and physicians in their daily practice. Today's planning systems are typically based on a single evaluation function that measures the quality of a radiation treatment plan. Unfortunately, such a one dimensional approach can-

not satisfactorily map the different backgrounds of physicians and the patient dependent necessities. So, too often a time consuming iteration process between evaluation of dose distribution and redefinition of the evaluation function is needed.

In this paper we propose a generic multi-criteria approach based on Pareto's solution concept. For each entity of interest - target volume or organ at risk a structure dependent evaluation function is defined measuring deviations from ideal doses that are calculated from statistical functions. A reasonable bunch of clinically meaningful Pareto optimal solutions are stored in a data base, which can be interactively searched by physicians. The system guarantees dynamical planning as well as the discussion of tradeoffs between different entities.

Mathematically, we model the upcoming inverse problem as a multi-criteria linear programming problem. Because of the large scale nature of the problem it is not possible to solve the problem in a 3D-setting without adaptive reduction by appropriate approximation schemes.

Our approach is twofold: First, the discretization of the continuous problem is based on an adaptive hierarchical clustering process which is used for a local refinement of constraints during the optimization procedure. Second, the set of Pareto optimal solutions is approximated by an adaptive grid of representatives that are found by a hybrid process of calculating extreme compromises and interpolation methods.

Keywords: multiple criteria optimization, representative systems of Pareto solutions, adaptive triangulation, clustering and disaggregation techniques, visualization of Pareto solutions, medical physics, external beam radiotherapy planning, intensity modulated radiotherapy
(31 pages, 2003)

44. T. Halfmann, T. Wichmann

Overview of Symbolic Methods in Industrial Analog Circuit Design

Industrial analog circuits are usually designed using numerical simulation tools. To obtain a deeper circuit understanding, symbolic analysis techniques can additionally be applied. Approximation methods which reduce the complexity of symbolic expressions are needed in order to handle industrial-sized problems. This paper will give an overview to the field of symbolic analog circuit analysis. Starting with a motivation, the state-of-the-art simplification algorithms for linear as well as for nonlinear circuits are presented. The basic ideas behind the different techniques are described, whereas the technical details can be found in the cited references. Finally, the application of linear and nonlinear symbolic analysis will be shown on two example circuits.

Keywords: CAD, automated analog circuit design, symbolic analysis, computer algebra, behavioral modeling, system simulation, circuit sizing, macro modeling, differential-algebraic equations, index
(17 pages, 2003)

45. S. E. Mikhailov, J. Orlik

Asymptotic Homogenisation in Strength and Fatigue Durability Analysis of Composites

Asymptotic homogenisation technique and two-scale convergence is used for analysis of macro-strength and fatigue durability of composites with a periodic structure under cyclic loading. The linear damage

accumulation rule is employed in the phenomenological micro-durability conditions (for each component of the composite) under varying cyclic loading. Both local and non-local strength and durability conditions are analysed. The strong convergence of the strength and fatigue damage measure as the structure period tends to zero is proved and their limiting values are estimated.

Keywords: multiscale structures, asymptotic homogenization, strength, fatigue, singularity, non-local conditions
(14 pages, 2003)

46. P. Domínguez-Marín, P. Hansen, N. Mladenović, S. Nickel

Heuristic Procedures for Solving the Discrete Ordered Median Problem

We present two heuristic methods for solving the Discrete Ordered Median Problem (DOMP), for which no such approaches have been developed so far. The DOMP generalizes classical discrete facility location problems, such as the p-median, p-center and Uncapacitated Facility Location problems. The first procedure proposed in this paper is based on a genetic algorithm developed by Moreno Vega [MV96] for p-median and p-center problems. Additionally, a second heuristic approach based on the Variable Neighborhood Search metaheuristic (VNS) proposed by Hansen & Mladenovic [HM97] for the p-median problem is described. An extensive numerical study is presented to show the efficiency of both heuristics and compare them.

Keywords: genetic algorithms, variable neighborhood search, discrete facility location
(31 pages, 2003)

47. N. Boland, P. Domínguez-Marín, S. Nickel, J. Puerto

Exact Procedures for Solving the Discrete Ordered Median Problem

The Discrete Ordered Median Problem (DOMP) generalizes classical discrete location problems, such as the N-median, N-center and Uncapacitated Facility Location problems. It was introduced by Nickel [16], who formulated it as both a nonlinear and a linear integer program. We propose an alternative integer linear programming formulation for the DOMP, discuss relationships between both integer linear programming formulations, and show how properties of optimal solutions can be used to strengthen these formulations. Moreover, we present a specific branch and bound procedure to solve the DOMP more efficiently. We test the integer linear programming formulations and this branch and bound method computationally on randomly generated test problems.

Keywords: discrete location, Integer programming
(41 pages, 2003)

48. S. Feldmann, P. Lang

Padé-like reduction of stable discrete linear systems preserving their stability

A new stability preserving model reduction algorithm for discrete linear SISO-systems based on their impulse response is proposed. Similar to the Padé approximation, an equation system for the Markov parameters involving the Hankel matrix is considered, that here however is chosen to be of very high dimension. Although this equation system therefore in general cannot be solved exactly, it is proved that the approxi-

mate solution, computed via the Moore-Penrose inverse, gives rise to a stability preserving reduction scheme, a property that cannot be guaranteed for the Padé approach. Furthermore, the proposed algorithm is compared to another stability preserving reduction approach, namely the balanced truncation method, showing comparable performance of the reduced systems. The balanced truncation method however starts from a state space description of the systems and in general is expected to be more computational demanding.

Keywords: Discrete linear systems, model reduction, stability, Hankel matrix, Stein equation
(16 pages, 2003)

49. J. Kallrath, S. Nickel

A Polynomial Case of the Batch Presorting Problem

This paper presents new theoretical results for a special case of the batch presorting problem (BPSP). We will show that this case can be solved in polynomial time. Offline and online algorithms are presented for solving the BPSP. Competitive analysis is used for comparing the algorithms.

Keywords: batch presorting problem, online optimization, competitive analysis, polynomial algorithms, logistics
(17 pages, 2003)

50. T. Hanne, H. L. Trinkaus

knowCube for MCDM – Visual and Interactive Support for Multicriteria Decision Making

In this paper, we present a novel multicriteria decision support system (MCDSS), called knowCube, consisting of components for knowledge organization, generation, and navigation. Knowledge organization rests upon a database for managing qualitative and quantitative criteria, together with add-on information. Knowledge generation serves filling the database via e.g. identification, optimization, classification or simulation. For "finding needles in haystacks", the knowledge navigation component supports graphical database retrieval and interactive, goal-oriented problem solving. Navigation "helpers" are, for instance, cascading criteria aggregations, modifiable metrics, ergonomic interfaces, and customizable visualizations. Examples from real-life projects, e.g. in industrial engineering and in the life sciences, illustrate the application of our MCDSS.

Key words: Multicriteria decision making, knowledge management, decision support systems, visual interfaces, interactive navigation, real-life applications.
(26 pages, 2003)

51. O. Iliev, V. Laptev

On Numerical Simulation of Flow Through Oil Filters

This paper concerns numerical simulation of flow through oil filters. Oil filters consist of filter housing (filter box), and a porous filtering medium, which completely separates the inlet from the outlet. We discuss mathematical models, describing coupled flows in the pure liquid subregions and in the porous filter media, as well as interface conditions between them. Further, we reformulate the problem in fictitious regions method manner, and discuss peculiarities of the numerical algorithm in solving the coupled system. Next, we show numerical results, validating the model and the

algorithm. Finally, we present results from simulation of 3-D oil flow through a real car filter.

Keywords: oil filters, coupled flow in plain and porous media, Navier-Stokes, Brinkman, numerical simulation
(8 pages, 2003)

Status quo: May 2003