

# On the binding of electrons to nitromethane: Dipole and valence bound anions

R. N. Compton<sup>a)</sup> and H. S. Carman, Jr.

Oak Ridge National Laboratory, P. O. Box 2008, Oak Ridge, Tennessee 37831-6125

C. Desfrancois, H. Abdoul-Carmine, and J. P. Schermann

Université Paris-Nord, Institut Galilée/Laboratoire de Physique des Lasers/Unité de Recherche, Associée au CNRS-URA 282, 93439 Villetaneuse, France

J. H. Hendricks, S. A. Lyapustina, and K. H. Bowen

Johns Hopkins University, Department of Chemistry, Charles and 34th Streets, Baltimore, Maryland 21218

(Received 28 December 1995; accepted 9 May 1996)

Conventional (valence) and dipole-bound anions of the nitromethane molecule are studied using negative ion photoelectron spectroscopy, Rydberg charge exchange and field detachment techniques. Reaction rates for charge exchange between Cs(*ns,nd*) and Xe(*nf*) Rydberg atoms with CH<sub>3</sub>NO<sub>2</sub> exhibit a pronounced maximum at an effective quantum number of  $n^* \approx 13 \pm 1$  which is characteristic of the formation of dipole-bound anions [ $\mu(\text{CH}_3\text{NO}_2) = 3.46 \text{ D}$ ]. However, the breadth ( $\Delta n \approx 5$ , FWHM) of the *n*-dependence of the reaction rate is also interpreted to be indicative of direct attachment into a valence anion state via a "doorway" dipole anion state. Studies of the electric field detachment of CH<sub>3</sub>NO<sub>2</sub><sup>-</sup> formed through the Xe(*nf*) reactions at various *n* values provide further evidence for the formation of both a dipole-bound anion as well as a contribution from the valence bound anion. Analysis of the field ionization data yields a dipole electron affinity of  $12 \pm 3 \text{ meV}$ . Photodetachment of CH<sub>3</sub>NO<sub>2</sub><sup>-</sup> and CD<sub>3</sub>NO<sub>2</sub><sup>-</sup> formed via a supersonic expansion nozzle ion source produces a photoelectron spectrum with a long vibrational progression indicative of a conventional (valence bound) anion with a substantial difference in the equilibrium structure of the anion and its corresponding neutral. Assignment of the origin ( $v' = 0, v'' = 0$ ) transitions in the photoelectron spectra of CH<sub>3</sub>NO<sub>2</sub><sup>-</sup> and CD<sub>3</sub>NO<sub>2</sub><sup>-</sup> yields adiabatic electron affinities of  $0.26 \pm 0.08$  and  $0.24 \pm 0.08 \text{ eV}$ , respectively. © 1996 American Institute of Physics. [S0021-9606(96)02831-0]

## INTRODUCTION

Presently there is considerable interest in the formation and structure of dipole-bound anions, i.e., the binding of electrons to highly polar molecules. The wave functions describing these anions are much more diffuse (resembling that of a highly excited state) than that of a more tightly bound conventional "valence" anion. A number of molecules are expected to exhibit both "valence" and "dipole" bound anions. The calculation of an accurate binding energy for "pure" dipole-bound anions represents a serious challenge to quantum chemistry as a result of the large number of very diffuse wave functions necessary to adequately represent these states.<sup>1</sup> These calculations become even more complicated when the molecule possesses a lower energy valence anion configuration as well as a dipole-bound state.<sup>2</sup> For the specific case of nitromethane, Adamowicz has calculated a dipole-bound electron affinity of  $\approx 3 \text{ meV}$ . Other studies<sup>3</sup> show that in the CH<sub>3</sub>NO<sub>2</sub><sup>-</sup> valence state the -CNO<sub>2</sub> group becomes nonplanar with a dihedral angle of  $148.5^\circ$  between the NO<sub>2</sub> plane and the CN bond. Thus, the dipole and valence adiabatic states are coupled through a breakdown of the Born-Oppenheimer approximation perhaps as a result of the wagging motion of the -NO<sub>2</sub> group.

Fermi and Teller<sup>4</sup> were the first to predict that a fixed (nonrotating) dipole should bind an electron or positron provided that the dipole moment is larger than  $1.625 \text{ D}$ . In the

late 1960s numerous other theoretical studies provided confirmation of this result (for an interesting historical account of this development see Turner<sup>5</sup>). In 1960, Wallis, Herman and Milnes<sup>6</sup> showed that the electron binding energy as a function of the dipole moment is a very small value (less than a typical rotational energy) and exhibits a slow increase up to about  $2 \text{ D}$ . Their calculations show a very steep increase of the binding energy above about  $2.2 \text{ D}$ . Following these results, Crawford and Garrett<sup>7</sup> employed calculations using a more realistic molecular potential to suggest that molecules whose dipole moment is above  $\approx 2 \text{ D}$  should permanently bind an electron.

Presently, ground state dipole-bound anions have been produced by free electron attachment under high pressure nozzle expansion conditions,<sup>8,9</sup> e.g., (HF)<sub>2</sub><sup>-</sup>, (HCl·H<sub>2</sub>O)<sup>-</sup>, uracil<sup>-</sup> (H<sub>2</sub>O·CH<sub>3</sub>CN)<sup>-</sup>, (H<sub>2</sub>O)<sub>2</sub><sup>-</sup> by dissociative electron attachment to clusters, e.g., ((CH<sub>3</sub>CN)<sub>*n*</sub>)<sup>-</sup><sup>10</sup> and by photodissociation of the I· acetone and I· acetonitrile complex to produce I atoms and dipole-bound negative ions.<sup>11</sup> One can also take advantage of the fact that in dipole-bound anions, electrons are in very diffuse orbitals which turn out to be well-matched by those of Rydberg atoms excited in the appropriate quantum states. The Rydberg electron technique (RET) has thus also proved to be an excellent method for selectively producing these fragile anions.<sup>12-14</sup> This method uses atoms excited in Rydberg states by means of tunable lasers as a source of well-controlled very low energy electrons. These atoms collide with thermal or supersonic beams of

<sup>a)</sup>Corresponding author.

polar molecules or clusters resulting in the transfer of their external electron, giving birth to anions which are stabilized against the reverse process, autodetachment, by the presence of the Rydberg ionic core. A crucial point of the RET method is that charge exchange reaction rates exhibit pronounced maxima in the cross sections due to the necessity of rather good orbital “matching” for efficient electron transfer to polar molecules. These maxima appear at specific values of the effective quantum number  $n^*$  (principal quantum number values corrected for angular momentum  $l$ -dependent quantum defects),  $n_{\max}^*$ , which decrease with increasing dipole moment.<sup>14</sup> The range of effective principal quantum numbers around each  $n_{\max}^*$  are also very narrow ( $\Delta n^*/n_{\max}^* \approx 1/5$ , where  $\Delta n^*$  represents the FWHM). The electron affinities for the dipole-bound anions produced by Rydberg charge exchange were deduced from measurements of the thresholds for electron detachment by an electric field.<sup>14</sup> As predicted by theory,<sup>6,7</sup> a marked increase in binding energy with dipole moment was observed above  $\sim 2.5$  D (0.5 meV for  $\mu=2.66$  D to 11.5 meV for  $\mu=3.92$  D). Molecules with dipole moments of 2.33 and 2.52 D were not observed to form dipole-bound anions, probably as a result of their fragile nature.

A number of free-radicals are known to exhibit both dipole-bound anion states and more tightly bound conventional (valence) anions. The groups of Brauman<sup>15</sup> and Lineberger<sup>16</sup> have reported very narrow resonance features in the photodetachment spectrum corresponding to rotationally excited shape and Feshbach resonances for many dipole-bound radical anions. Clary has calculated<sup>17</sup> the energy levels and widths of the rotational resonances for two of these;  $\text{CH}_2\text{CN}^-$  and  $\text{CH}_2\text{CHO}^-$ . His calculations confirm the experimental observations that the widths of these resonances increase (lifetimes decrease) with increasing energy above threshold. The implication of these results to the reverse process, electron attachment, was also considered by Clary and Henshaw<sup>18</sup> with the result that the exothermic (or thermo-neutral) electron attachment rate coefficient depends upon  $B^{1/2}/T$ , where  $B$  is the molecular rotor constant and  $T$  is the temperature.

In a series of experiments, Compton *et al.* reported Rydberg charge exchange<sup>13</sup> and fast atom charge transfer reactions<sup>19</sup> with nitromethane to produce  $\text{CH}_3\text{NO}_2^-$ . The latter experiment provided an estimate of the valence electron affinity for  $\text{CH}_3\text{NO}_2$  of  $0.35 \pm 0.2$  eV (K reactions) and  $0.44 \pm 0.2$  eV (Cs reactions). Free electron attachment to  $\text{CH}_3\text{NO}_2$  produces a short-lived anion ( $T < 1 \mu\text{s}$ ) which was found to be stabilized by three body collisions in an electron swarm.<sup>13</sup> The observed three-body rate coefficient was seen to increase with buffer gas in the order of He to  $\text{CH}_4$  to  $\text{CO}_2$ , as expected. However, an anomalously large three-body attachment coefficient was observed for acetone. It was suggested<sup>13</sup> that “The rather large three-body rate coefficient for acetone could be due in part to a reaction of virtual acetone negative ions with  $\text{CH}_3\text{NO}_2$  to form stable negative ions.” Based upon the above discussion, it is reasonable to suggest that electron attachment to temporary dipole negative ion states of acetone  $\text{CH}_3\text{COCH}_3^-$  as discussed by

Clary<sup>17</sup> due to its large dipole moment is followed quickly by charge exchange to the  $\text{CH}_3\text{NO}_2$  molecule either directly into the valence anion state or through the dipole state of  $\text{CH}_3\text{NO}_2^-$ . In the latter sense, the dipole anion would be considered as a doorway state to conventional anion formation. This suggestion is partially supported by recent observations of dipole–dipole charge exchange by Popple *et al.*<sup>20</sup> The experiments reported herein are specifically designed to explore the dynamic relationship between the “dipole” and “valence” anion states of nitromethane.

## EXPERIMENTAL METHODS

Theoretically,  $\text{CH}_3\text{NO}_2^-$  cannot be treated as a pure dipole or pure valence state. However, it is useful to discuss separately the two experimental methods which are employed to probe the two extreme limits where the anions are more “valencelike” or “dipolelike.” Moreover, one can consider, in a very crude approximation, the nitromethane molecule as consisting of two nearly independent moieties, as far as electron attachment is concerned, the methyl group and the nitro group. In the pure dipole state, the excess electron is mostly found on the  $\text{CH}_3$  side while in the valence state it is mostly located on the nitro group. In this study, the valence anion states are examined using photodetachment while information on the dipole states is gained through Rydberg electron attachment.

*Valence anions:* negative ion photoelectron spectroscopy at Johns Hopkins University was employed to determine the adiabatic electron affinities EA’s for  $\text{CH}_3\text{NO}_2$  and  $\text{CD}_3\text{NO}_2$ . Details of the experimental apparatus and procedure have been previously described.<sup>21</sup> Briefly, nitromethane negative ion currents of up to 500 pA were produced from a supersonic nozzle expansion ion source in which the nitromethane vapor was coexpanded with 7 atm of Ar through a 25  $\mu\text{m}$  nozzle heated to 50 °C. The mass-selected negative ion beam was crossed with an argon ion laser beam operating intracavity at 488 nm. A small solid angle of photodetached electrons was then passed through a hemispherical electron energy analyzer with an energy resolution of approximately 30 meV (FWHM). In addition, beams of  $(\text{CH}_3\text{NO}_2)_{2,3}^-$  were also formed and photodetached. In a supersonic nozzle expansion ion source, low energy electrons are injected from a biased filament directly into the expansion jet (just outside the nozzle orifice) in the presence of a weak axial magnetic field. A microplasma is formed and anions are extracted from it.<sup>22</sup> Under the conditions of this experiment, the many collisions experienced by the anions should allow for relaxation to their ground state configuration.

*Dipole anions:* Charge exchange reactions between excited Rydberg atoms and pulsed supersonic beams of helium seeded with nitromethane were studied both at the Oak Ridge National Laboratory using Cs(*ns,nd*) Rydberg atoms<sup>23</sup> and at the University of Paris-Nord using Xe(*nf*) Rydberg atoms.<sup>24</sup> The negative ions were mass-analyzed by time-of-flight spectroscopy ( $m/\Delta m \approx 100$ ). Monomer anions  $\text{CH}_3\text{NO}_2^-$  as well as cluster anions  $(\text{CH}_3\text{NO}_2)_{2-5}^-$  were observed under usual conditions. It appeared necessary to sup-

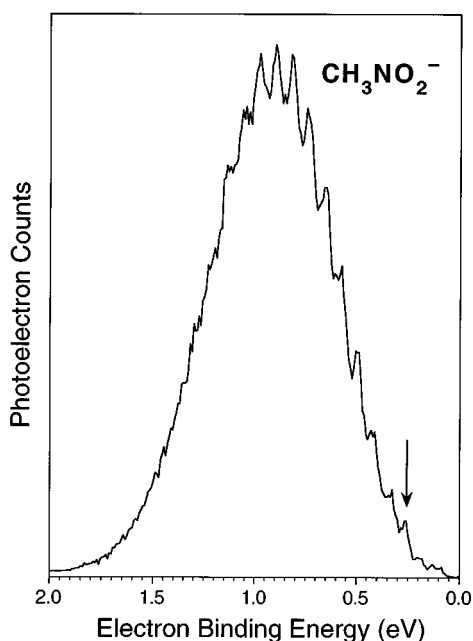

FIG. 1. Laser photodetachment photoelectron spectrum of  $\text{CH}_3\text{NO}_2^-$  anions. The arrow denotes the origin transition which is equated to the electron affinity ( $0.26 \pm 0.08$  eV) of  $\text{CH}_3\text{NO}_2$ .

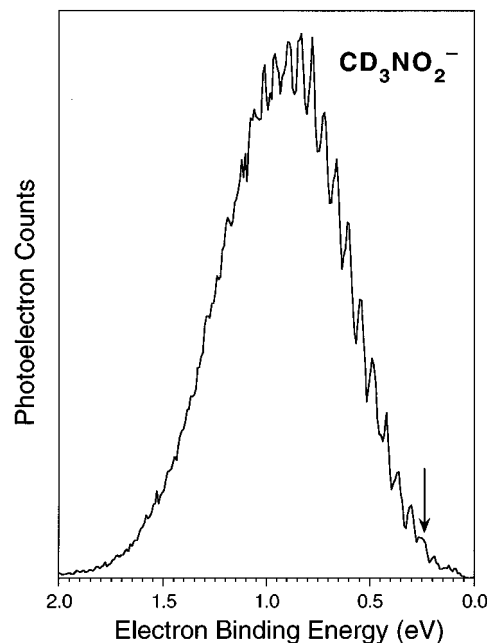

FIG. 2. Laser photodetachment photoelectron spectrum of  $\text{CD}_3\text{NO}_2^-$  anions. The arrow denotes the origin transition which is equated to the electron affinity ( $0.24 \pm 0.08$  eV) of  $\text{CD}_3\text{NO}_2$ .

press cluster formation by either using an effusive beam or by varying the time delay between the opening of the molecular pulsed valve at very short values.<sup>23</sup> At larger delay times, the monomer anion signals did not correspond to direct Rydberg electron attachment to monomers, but rather to attachment to dimers and larger clusters followed by evaporation leading to monomers. Both of these experiments have been described previously.<sup>23,24</sup>

## RESULTS AND CONCLUSIONS

The laser photoelectron (photodetachment) spectra for both  $\text{CH}_3\text{NO}_2^-$  (Fig. 1) and  $\text{CD}_3\text{NO}_2^-$  (Fig. 2) do not show the sharp low electron binding energy spectral feature that is characteristic of dipole-bound anion photoelectron spectra [see Refs. 8 and 9]. Instead, they exhibit long vibrational progressions superimposed upon a broad envelope. This is an indication that the equilibrium geometry of the anion is substantially different from that of the neutral and that the excess electron binding is covalent.

This is consistent with a number of theoretical and experimental studies of the nitromethane anion.<sup>3,25</sup> Since the main goal in performing these experiments was the determination of the adiabatic electron affinity of nitromethane, it was necessary to identify the origin ( $v'=0$ ,  $v''=0$ ) of the vibrational progressions for  $\text{CH}_3\text{NO}_2^-$  and  $\text{CD}_3\text{NO}_2^-$  spectra. The photoelectron spectra presented in Fig. 1 and Fig. 2 show neutral vibrational spacings of  $645 \pm 70$   $\text{cm}^{-1}$  and  $484 \pm 70$   $\text{cm}^{-1}$ , respectively. (The error bar is the width of a single channel of the collected photoelectron spectrum). These observed spacings match the neutral  $-\text{NO}_2$  bending mode of  $655$   $\text{cm}^{-1}$  and the  $-\text{NO}_2$  ‘‘wag’’ of  $607$   $\text{cm}^{-1}$  for the  $\text{CH}_3\text{NO}_2$  molecule and the neutral  $\text{NO}_2$  wag of  $545$   $\text{cm}^{-1}$

for the  $\text{CD}_3\text{NO}_2$  molecule.<sup>26</sup> Following the vibrational progression in either photoelectron spectrum down in electron binding energy to its last well-defined and equally-spaced peak, we find the upper limits for these EA's for  $\text{CH}_3\text{NO}_2$  and  $\text{CD}_3\text{NO}_2$ . The lower limits for these EA's are defined by identifying the last discernable peaks at the low electron binding energy ends of these spectra. This brackets the value of EA for  $\text{CH}_3\text{NO}_2$  between  $0.26$  and  $0.08 \pm 0.02$  eV and for  $\text{CD}_3\text{NO}_2$  between  $0.24$  and  $0.08 \pm 0.02$  eV. The actual value of EA is unlikely to be toward the lower end of these windows, because in our experience,<sup>8</sup> in cases where conventional and dipole-bound anions have comparable electron binding energies, both states are observed in the photoelectron spectrum. We do not see the dipole-bound feature in the spectra of either the nitromethane anion or its deuterated analog, suggesting that the electron binding energy of the conventional anion is somewhat greater than that of the dipole-bound anion. We conclude that the above mentioned intervals represent both the upper and the lower limits to the value of adiabatic electron affinity of  $\text{CH}_3\text{NO}_2$  and  $\text{CD}_3\text{NO}_2$ . Additional considerations in identifying the origin transition come from the earlier experiments by Compton *et al.*<sup>19</sup> measuring energy thresholds for charge exchange between  $\text{CH}_3\text{NO}_2/\text{CD}_3\text{NO}_2$  molecules and fast alkali atoms. There, the following values of the EA's were reported:  $0.43 \pm 0.2$  and  $0.35 \pm 0.2$  eV for  $\text{CH}_3\text{NO}_2$  colliding with Cs and K atoms, respectively, and  $0.39 \pm 0.2$  eV for  $\text{CD}_3\text{NO}_2$  colliding with Cs atoms. Thus, we assign the peaks at the arrows marked on the spectra as the origin transitions for  $\text{CH}_3\text{NO}_2$  and  $\text{CD}_3\text{NO}_2$ , and determine the corresponding values of EA's as  $0.26 \pm 0.08$  and  $0.24 \pm 0.08$  eV respectively. The er-

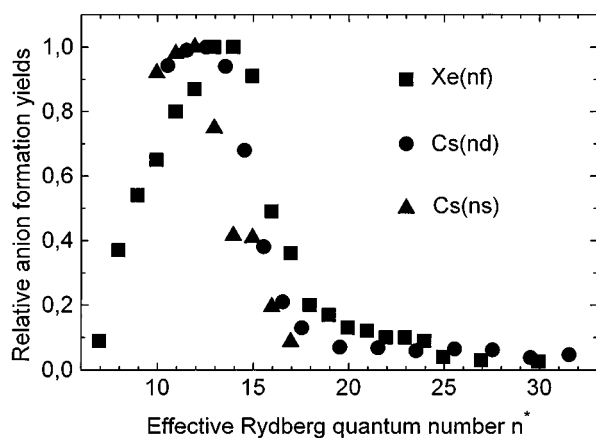

FIG. 3. Relative rate constants for the production of  $\text{CH}_3\text{NO}_2^-$  anions in electron transfer reactions between laser excited  $\text{Cs}(ns)$ ,  $\text{Cs}(nd)$ , and  $\text{Xe}(nf)$  Rydberg atoms and nitromethane molecules.

ror bar in this case reflects the uncertainty in choosing the origin peak.

Photodetachment from the potential surface of the anion to that of the neutral at the equilibrium geometry of the anion is accessing highly excited vibrational states of the nitro group. This is reasonable since it is the geometry of this group that undergoes the most significant changes upon the addition of an extra electron to the molecule. Similar conclusions were reached in other studies of alkali charge transfer<sup>27</sup> with nitromethane. Noteworthy is the fact that the same wagging motion of the  $-\text{NO}_2$  group is likely to be responsible for a breakdown of the Born–Oppenheimer approximation in this system.

Finally, it is important to note that ion source conditions were widely varied in an unsuccessful effort to produce the dipole-bound nitromethane anion with the supersonic expansion ion source. It is significant that many dipole-bound anion species have been made with this source.<sup>8,9</sup> As mentioned above, the signature of its occurrence would have been a sharp photoelectron peak occurring at a low electron binding energy. We conclude that any dipole-bound anions which might have been produced were relaxed by collisions into the valence anion state.

Figure 3 shows the experimentally measured  $\text{CH}_3\text{NO}_2^-$  yield as a function of the effective principal quantum number,  $n^*$ , for collisions between  $\text{Cs}(ns, nd)$  and  $\text{Xe}(nf)$  Rydberg atoms and nitromethane molecules entrained in a supersonic jet of He. All the data are relative to the reaction rate for  $\text{SF}_6^-$  formation. It is rather difficult to accurately determine the absolute rate coefficients, therefore all the data have been normalized to unity at their maximum value. The maxima for all three collision pairs occur at  $n^* \approx 13 \pm 1$  and there is very little difference observed with the angular momentum,  $l$  of the Rydberg atom, or the core,  $\text{Cs}^+$  or  $\text{Xe}^+$ . The  $n$  dependence of the reaction rate for  $\text{CH}_3\text{NO}_2$  is, however, somewhat different from that found previously for a series of over 12 molecules which have dipole moments (2.66–3.92 D) above the effective critical moment of  $\approx 2.5$

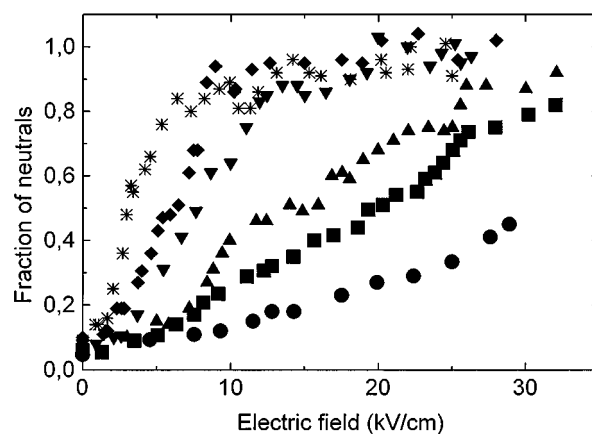

FIG. 4. Fraction of  $\text{CH}_3\text{NO}_2$  neutrals detected after field detachment of the corresponding anions, as a function of the applied electric field. Anions were obtained in charge exchange collisions with laser-excited  $\text{Xe}(nf)$  Rydberg atoms, in absence of dimer production. The different curves correspond to anions produced from Rydberg atoms with different principal quantum number  $n$  (stars  $n=19$ , lozenges  $n=16$ , down triangles  $n=13$ , up triangles  $n=11$ , squares  $n=10$ , circles  $n=8$ ).

$D$ ,<sup>7</sup> but do *not* possess a bound valence ground state negative ion configuration. In studies of this type, the  $n^*$  dependence of the rate constant for the formation of pure dipole-bound anions exhibited a sharply peaked function which can be characterized by  $\Delta n^*/n_{\text{max}}^* \approx 1/5$  where  $\Delta n$  represents the FWHM spread about the peak at  $n^*$ . For the case of nitromethane, however, the width of the  $n$  dependence is considerably larger ( $\Delta n^*/n_{\text{max}}^* \approx \frac{1}{2}$ ). Also, a tail in the  $\text{CH}_3\text{NO}_2^-$  signal persists to large  $n$  indicative of a “free” electron attachment process. This contribution at high  $n^*$  (above  $\approx 25$ ) is attributed to evaporative electron attachment to pre-existing dimers (and larger polymers) present in the nozzle jet. The mass spectrum for reactions using a series of  $\text{Cs}(n-s, nd)$  states presented in Fig. 3 reveals the presence of  $(\text{CH}_3\text{NO}_2^-)_{n=1-4}$  anions. RET reactions with beams containing only monomers produce anions only at  $n^*$  values below 20. The Rydberg core is apparently not capable of stabilizing the short-lived  $\text{CH}_3\text{NO}_2^-$  formed by the attachment of the “slow” electrons brought up to the molecule by the high  $n$  Rydberg atom. As discussed in the Introduction,  $\text{CH}_3\text{NO}_2$  undergoes three-body electron attachment in the high pressure electron swarm experiments. However, the  $\text{CH}_3\text{NO}_2^-$  initially formed in the RET reaction is apparently too short lived to be stabilized by the presence of the distant  $\text{Cs}^+$  or  $\text{Xe}^+$  ion core.

Measurements of the electric field detachment of  $\text{CH}_3\text{NO}_2^-$  anions formed for different  $n^*$  provides information relative to the interpretation of the anomalously wide  $n^*$  dependence. Figure 4 displays the fraction of neutrals produced via electric field detachment as a function of the applied electric field for anions produced at various  $n^*$  for  $\text{Xe}(nf)$ . The complexity of these curves as compared to that for the “pure” dipole-bound anion cases makes an exact interpretation difficult. Qualitatively, the “threshold” for the occurrence of field detachment increases with decreasing  $n$

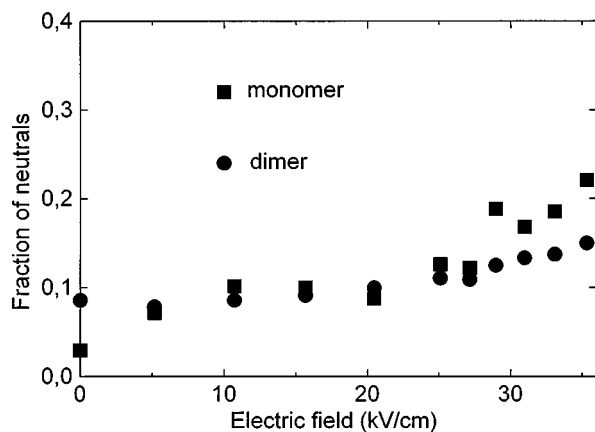

FIG. 5. Fraction of  $\text{CH}_3\text{NO}_2$  neutrals detected after field detachment of the corresponding anions, as a function of the applied electric field, in presence of dimer formation. Squares correspond to nitromethane monomer anions which originate from dimer anion evaporations and circles correspond to dimer anions, obtained in charge exchange collisions with laser-excited  $\text{Xe}(25f)$  Rydberg atoms.

from  $n=19$  to  $n=8$ . At  $n=8$  and 10, in fact, field detachment is very difficult and only a small fraction of the ions are detached even at a field of 35 kV/cm. We interpret this as partial stabilization of the initially produced anions by the Rydberg core. At high  $n^*$  in the region above  $n_{\text{max}}^*$ , ( $n^*=13-19$ ), where the ionic core is expected to be weakly effective at stabilization, a threshold can be identified corresponding to electron affinities of 6 to 23 meV. These values are consistent with the electron affinities derived from the empirical relationship,  $E_{db} = [(23)/(n_{\text{max}}^*)^{2.8}]$  eV established previously.<sup>28</sup> For anions formed at lower  $n^*$  the “threshold” for field detachment is broadened and shifted to such an extent that no unique binding energy can be assigned. Field detachment experiments reflect the efficiency of the anion stabilization processes. For example, evaporation from a dimer anion takes place at the expense of anion internal energies and leaves the anions nearly totally relaxed. This is shown in Fig. 5 where anions produced by evaporation from nitromethane dimers and larger clusters are in valence states and are not observed to be field-detached with the electric fields applied. Photoelectron spectra of the dimer and trimer anions (Fig. 6) confirmed the increased binding energies of these cluster anions. The stabilization shift due to solvation is  $0.66 \pm 0.01$  eV for the first solvent molecule and  $0.58 \pm 0.01$  eV for the second one in the case of both hydrogenated and fully deuterated nitromethane. The profile of the spectra in each instance repeats the envelope of the corresponding monomer which indicates that in a cluster anion the excess charge is still localized on a single nitromethane molecule.

The field detachment curves shown in Fig. 4 also appear to exhibit structures which can be described as inflexions followed by plateaus. We interpret these steps as evidence that the initially produced dipole-bound state has undergone partial stabilization by collisions with the Rydberg core which couples the dipole state with the valence state. The

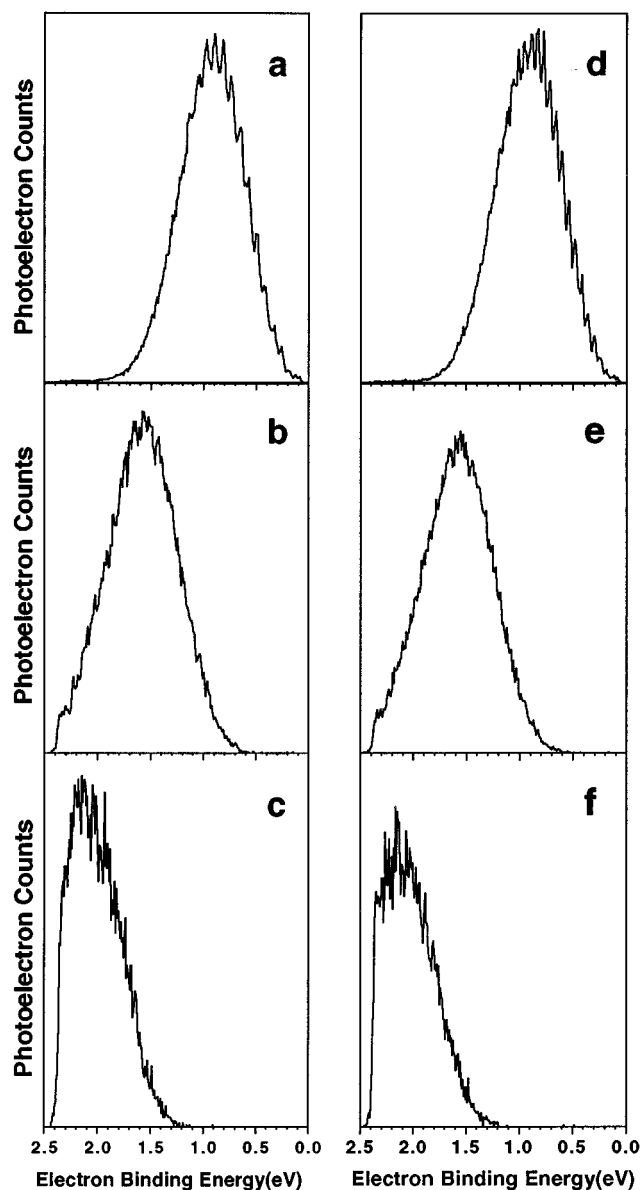

FIG. 6. Laser photodetachment (photoelectron) spectra of  $(\text{CH}_3\text{NO}_2)_n^-$  ( $(\text{CH}_3\text{NO}_2)_n$ ) $_{n=0-2}$  and  $(\text{CD}_3\text{NO}_2)_n^-$  ( $(\text{CD}_3\text{NO}_2)_n$ ) $_{n=0-2}$ : (a)  $\text{CH}_3\text{NO}_2^-$ . (b)  $(\text{CH}_3\text{NO}_2)_2^-$ . (c)  $(\text{CH}_3\text{NO}_2)_3^-$ . (d)  $\text{CD}_3\text{NO}_2^-$ . (e)  $(\text{CD}_3\text{NO}_2)_2^-$ . (f)  $(\text{CD}_3\text{NO}_2)_3^-$ .

spacing of these steps correspond to energies in the range of approximately 3–8 meV. This would imply that there is an internal energy of the anion of this order of magnitude which could increase the effective binding energy by this amount. This energy is too large to correspond to a rotational energy and is too small to correspond to a typical vibration. One possibility is internal hindered rotational motion. The CN torsion frequency for the  $\text{CH}_3\text{NO}_2$  molecule corresponds to 2.6 meV and increases to 27 meV in the valence anion as a result of the tetrahedral structure of the ground state of the anion (increased hindrance of the torsional motion).<sup>3</sup> Thus we assign the “breaks” in the field detachment curves to field ionization of a mixed dipole–valence state in which the low energy torsional frequency gives rise to fast vibrational

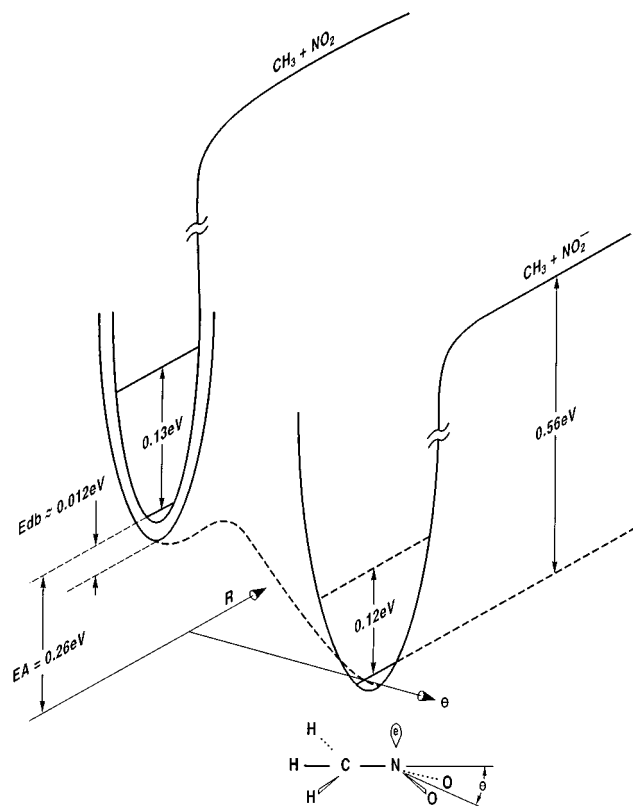

FIG. 7. Potential energy surfaces for  $\text{CH}_3\text{NO}_2$  and  $\text{CH}_3\text{NO}_2^-$  anions. The surface representing the dipole-bound anion lies ( $\sim 0.012$  eV) below that of  $\text{CH}_3\text{NO}_2$  and the valence-bound anion lies 0.26 eV below the neutral.

(pseudo rotational) field induced autoionization. The degree of admixture of dipole and valence anion states will be determined partially by the collisional stabilization (value of  $n^*$ ) by the ionic core, as evidenced by the data in Fig. 4.

It is instructive to consider the dynamic interaction between the adiabatic dipole and valence anion states in nitromethane. Figure 7 represents a simplified two-dimensional picture of the adiabatic potential energy surface for  $\text{CH}_3\text{NO}_2^-$  constructed from the data introduced above. In this picture, the  $\text{CH}_3\text{NO}_2^-$  state at the equilibrium geometry of the neutral is dominated by the dipole field. As the molecule is distorted to the “bent” equilibrium geometry of the valence state, the excess electron density begins to shift to the  $-\text{NO}_2$  end of the molecule. For small angular tilt of the  $-\text{NO}_2$  group we assume that the energy level increases, producing a small barrier to the formation of the ground valence state. Thus, in this picture the dipole state is a metastable state whose lifetime is determined by vibrational coupling with the anion ground state.

Free electrons can temporarily attach into the valence anion state via nuclear excited Feshbach resonances as well as into dipole-supported shape and Feshbach resonances in the continuum. The system is then a superposition of dipole and valence states eventually exiting again into the continuum. In this case, the dipole states act as a separate doorway to the eventual formation of a stable valence anion. A very similar mechanism was advanced by Wetmore *et al.*<sup>29</sup>

for electron attachment to the acetaldehyde enolate molecule. For the case of RET reactions, the dipole-bound anion states are initially bound. Coupling between the pure dipole and valence state occurs through a breakdown of the Born–Oppenheimer approximation and the ratio of the time spent in the pure dipole,  $\text{D}^-$ , to valence state,  $\text{V}^-$ , is given by the ratio of the density of states  $\rho_{\text{D}^-}/\rho_{\text{V}^-}$ . We estimate that  $\text{CH}_3\text{NO}_2^-$  has  $\sim 190$  states with energy less than 0.26 eV. Also, the density of states for the valence anion  $\rho_{\text{V}^-}$  is roughly  $2.8 \times 10^3/\text{eV}$ . If we assume a single dipole state at this energy then  $\rho_{\text{D}^-}/\rho_{\text{V}^-} \approx 3 \times 10^{-4}$ . Since  $\rho_{\text{D}^-} \ll \rho_{\text{V}^-}$ , we expect the system to spend most of its time in the valence configuration. If the anion initially possesses internal energy (“hot bands”) and this energy is not removed by the third body, autodetachment into the continuum is possible through the mixed state interaction. In nozzle expansion experiments, this is of low probability. However, it could become important in room temperature or hot effusive beam reactions. The important point is that the presence of valence anion states provides a pathway to vibrational autoionization not present in pure dipole anion states.

*Note added in proof:* G. L. Gutsev and R. J. Bartlett have recently calculated the valence-bound and dipole-bound electron affinities for  $\text{CH}_3\text{NO}_2$  to be 0.223 eV and 13 meV, respectively. These values agree well with our experimental values of 0–265.08 eV and  $12 \pm 3$  meV.

## ACKNOWLEDGMENTS

K. H. Bowen wishes to thank the National Science Foundation (CHE-9007445) for support of the work at Johns Hopkins University. R. N. Compton thanks the Institut Galilée/Laboratoire de Physique des Lasers for support during his stay in Paris where this manuscript was prepared and to the National Science Foundation (CHE-9508609). H. S. Carman, Jr., is presently employed at Eastman Chemical Company, Kingsport, Tennessee, 37662-5150. R. N. Compton gratefully acknowledges many comments from C. E. Klots and W. R. Garrett.

<sup>1</sup>K. D. Jordan and J. Simons, *Chem. Rev.* **87**, 535 (1987).

<sup>2</sup>L. Adamowicz, *J. Chem. Phys.* **91**, 7787 (1989).

<sup>3</sup>F. Ramondo, *Can. J. Chem.* **70**, 314 (1992).

<sup>4</sup>E. Fermi and E. Teller, *Phys. Rev.* **72**, 406 (1947).

<sup>5</sup>J. E. Turner, *Am. J. Phys.* **45**, 758 (1977).

<sup>6</sup>R. F. Wallis, R. Herman, and H. W. Milnes, *J. Mol. Spectrosc.* **4**, 51 (1960).

<sup>7</sup>O. H. Crawford, *Mol. Phys.* **20**, 585 (1971); W. R. Garrett, *Phys. Rev. A* **3**, 961 (1971); O. H. Crawford and W. R. Garrett, *J. Chem. Phys.* **66**, 4968 (1977).

<sup>8</sup>J. H. Hendricks, S. A. Lyapustina, H. L. de Clercq, J. T. Snodgrass, and K. H. Bowen, *J. Chem. Phys.* **104**, 7788 (1996).

<sup>9</sup>J. V. Coe, G. H. Lee, J. G. Eaton, S. T. Arnold, H. W. Sarkas, K. H. Bowen, C. Ludewigt, H. Haberland, D. R. Worsnop, *J. Chem. Phys.* **92**, 3980 (1990); K. H. Bowen and J. G. Eaton, *The Structure of Small Molecules and Ions*, edited by R. Naaman and Z. Vager (Plenum, New York, 1988), pp. 147–169; S. T. Arnold, J. G. Eaton, H. W. Sarkas, K. H. Bowen, C. Ludewigt, and H. Haberland, *Z. Phys. D* **20**, p. 9 (1991); H. Haberland and K. H. Bowen, in *Clusters of Atoms and Molecules II*, edited by H. Haberland (Springer, Berlin, 1994) pp. 134–153; J. H. Hendricks, H. L. deClercq, S. A. Lyapustina, C. A. Fancher, T. P. Lippa, J. M. Collins, S. T. Arnold, G. H. Lee, and K. H. Bowen, in *Structure and*

- Dynamics of Clusters* (Proceedings of the Yamada Conference), edited by T. Kondow (Universal Academy, Tokyo, 1995).
- <sup>10</sup>R. Hashemi and E. Illenberger, *J. Phys. Chem.* **95**, 6402 (1991).
- <sup>11</sup>C. E. H. Dessent, C. G. Bailey, and M. A. Johnson, *J. Chem. Phys.* **102**, 6335 (1995).
- <sup>12</sup>T. Sugiura and A. Arakawa, in *Proceedings of the International Conference on Mass Spectroscopy*, (University of Tokyo, Tokyo, 1970), p. 848.
- <sup>13</sup>J. A. Stockdale, F. J. Davis, R. N. Compton, and C. E. Klots, *J. Chem. Phys.* **60**, 4279 (1974).
- <sup>14</sup>C. Desfrancois, N. Khelifa, A. Lisfi, J. P. Schermann, J. G. Eaton, and K. H. Bowen, *J. Chem. Phys.* **95**, 7760 (1991) and C. Desfrancois, B. Baillon, J. P. Schermann, S. T. Arnold, J. H. Hendricks, and K. H. Bowen, *Phys. Rev. Lett.* **72**, 48 (1994); C. Desfrancois, H. Abdoul-Carime, N. Khelifa, and J. P. Schermann, *ibid.* **73**, 2436 (1994).
- <sup>15</sup>See E. A. Brinkman, S. Berger, J. Marks, and J. I. Brauman, *J. Phys. Chem.* **99**, 7586 (1993), and other references herein.
- <sup>16</sup>See A. S. Mullin, K. K. Murray, C. P. Schulz, and W. C. Lineberger, *J. Phys. Chem.* **97**, 10281 (1993).
- <sup>17</sup>D. C. Clary, *J. Phys. Chem.* **92**, 3123 (1988).
- <sup>18</sup>D. C. Clary, J. P. Henshaw, *Int. J. Mass Spectrosc. Ion Phys.* **80**, 31 (1987).
- <sup>19</sup>R. N. Compton, P. W. Reinhardt, and C. D. Cooper, *J. Chem. Phys.* **69**, 4360 (1978).
- <sup>20</sup>R. A. Popple, C. D. Finch, and F. B. Dunning, *Chem. Phys. Lett.* (1995).
- <sup>21</sup>J. V. Coe, J. T. Snodgrass, C. B. Friedhoff, K. M. McHugh, and K. H. Bowen, *J. Chem. Phys.* **84**, 618 (1986).
- <sup>22</sup>J. V. Coe, J. T. Snodgrass, C. B. Friedhoff, K. M. McHugh, and K. H. Bowen, *J. Chem. Phys.* **87**, 4302 (1987).
- <sup>23</sup>H. S. Carman, Jr., C. E. Klots, and R. N. Compton, *J. Chem. Phys.* **90**, 2580 (1989).
- <sup>24</sup>C. Desfrancois, N. Khelifa, A. Lisfi, and J. P. Schermann, *J. Chem. Phys.* **96**, 5009 (1992).
- <sup>25</sup>B. C. Gilbert and M. Trenwith, *J. Chem. Soc. Perkins Trans.* **14**, 2010 (1973).
- <sup>26</sup>C. Trinquecoste, M. Rey-Lafon, and M.-T. Forel, *Spectrochim. Acta A* **30**, 813 (1974).
- <sup>27</sup>R. F. M. Lobo, A. M. C. Moutinho, K. Lachman, and J. Los, *J. Chem. Phys.* **95**, 166 (1991).
- <sup>28</sup>C. Desfrancois, *Phys. Rev. A* **51**, 3667 (1995).
- <sup>29</sup>R. W. Wetmore, H. F. Schaeffer III, P. C. Hiberty, and J. I. Brauman, *J. Am. Chem. Soc.* **102**, 5470 (1980).