

# On the Performance of Hybrid Digital-Analog Coding for Broadcasting Correlated Gaussian Sources

Hamid Behroozi, *Member, IEEE*, Fady Alajaji, *Senior Member, IEEE*, and Tamás Linder, *Senior Member, IEEE*

**Abstract**—We consider the problem of sending a bivariate Gaussian source  $S = (S_1, S_2)$  across a power-limited two-user Gaussian broadcast channel. User  $i$  ( $i = 1, 2$ ) observes the transmitted signal corrupted by Gaussian noise with power  $\sigma_i^2$  and desires to estimate  $S_i$ . We study hybrid digital-analog (HDA) joint source-channel coding schemes and analyze the region of (squared-error) distortion pairs that are simultaneously achievable. Two cases are considered: 1) broadcasting with bandwidth compression, and 2) broadcasting with bandwidth expansion. We modify and adapt HDA schemes of Wilson *et al.* [1] and Prabhakaran *et al.* [2], originally proposed for broadcasting a single common Gaussian source, in order to provide achievable distortion regions for broadcasting correlated Gaussian sources. For comparison, we also extend the outer bound of Soundararajan *et al.* [3] from the matched source-channel bandwidth case to the bandwidth mismatch case.

**Index Terms**—Gaussian broadcast channel, bandwidth compression/expansion, joint source-channel coding, hybrid digital-analog (HDA) coding, Costa coding, Wyner-Ziv coding, layered coding, uncoded transmission.

## I. INTRODUCTION

WE consider the reliable transmission of a correlated bivariate Gaussian source  $S = (S_1, S_2)$  across a power-limited two-user Gaussian broadcast channel. One motivation of our study is the problem of sending a correlated vector source such as the pair (temperature, pressure) of a reactor to monitoring sites. Different components of the source could have their own fidelity requirements instead of an average or total distortion measure even though they are jointly coded.

First let us consider the problem of broadcasting a single memoryless source to two destinations. A Gaussian source sequence of mean zero and variance  $\sigma_S^2$  is to be transmitted across a Gaussian two-user broadcast channel with power

Paper approved by J. Kliewer, the Editor for Iterative Methods and Cross-Layer Design of the IEEE Communications Society. Manuscript received August 8, 2010; revised June 18, 2011.

This work was supported in part by a Postdoctoral Fellowship from the Ontario Ministry of Research and Innovation (MRI), and by the Natural Sciences and Engineering Research Council (NSERC) of Canada. The material in this paper was presented in part at the IEEE International Symposium on Information Theory (ISIT), Seoul, Korea, June 2009, and at the IEEE Information Theory Workshop (ITW), Taormina, Italy, Oct. 2009.

H. Behroozi was with the Department of Mathematics and Statistics, Queen's University, Kingston, Ontario, Canada. He is now with the Electrical Engineering Department, Sharif University of Technology, Tehran, Iran (e-mail: behroozi@sharif.edu).

F. Alajaji and T. Linder are with the Department of Mathematics and Statistics, Queen's University, Kingston, Ontario, K7L 3N6, Canada (e-mail: {fady, linder}@mst.queensu.ca).

Digital Object Identifier 10.1109/TCOMM.2011.101011.100483

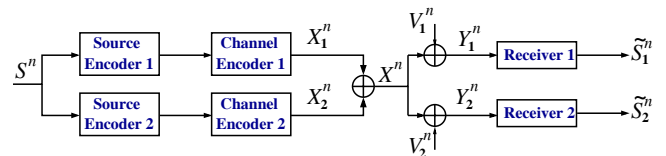

Fig. 1. Broadcasting a single memoryless Gaussian source using separate source-channel codes. Source encoder 1 is an optimal encoder with rate  $R_1$ , source encoder 2 is an optimal encoder for the residual error of encoder 1 with rate  $R_2 - R_1$ . The two codes are superpositioned and transmitted across a power-limited Gaussian two-user broadcast channel.

constraint  $P$  and with respective noise variances  $N_1$  and  $N_2$  ( $N_1 > N_2$ ) (e.g., see [4]). For this example, it is known that uncoded transmission performs better than the best separate source-channel code (see, e.g., [5]–[8]). Let  $C_1 = \frac{1}{2} \log(1 + \frac{P}{N_1})$  and  $C_2 = \frac{1}{2} \log(1 + \frac{P}{N_2})$  be, respectively, the capacities of the two underlying point-to-point channels. If separate source and channel coding is used, i.e., the Gaussian source is optimally quantized and the quantization bits are encoded with a capacity-achieving channel code (see Fig. 1), the mean squared-error (MSE) pair of achievable distortions satisfies

$$D_1 = \frac{\sigma_S^2}{1 + \frac{(1-\gamma)P}{\gamma P + N_1}}; \quad D_2 = \frac{\sigma_S^2}{\left(1 + \frac{(1-\gamma)P}{\gamma P + N_1}\right) \left(1 + \frac{\gamma P}{N_2}\right)}, \quad (1)$$

where  $\gamma$  can be chosen in  $[0, 1]$  to provide the desired tradeoff between  $D_1$  and  $D_2$ . Since the Gaussian problem we consider is successively refinable [7], [9], this result follows from combining  $R_i = R(D) = \frac{1}{2} \log(\frac{\sigma_S^2}{D})$  with the pair of achievable rates for a broadcast channel as  $R_1 = \frac{1}{2} \log(1 + \frac{(1-\gamma)P}{\gamma P + N_1})$  and  $R_2 = R_1 + \frac{1}{2} \log(1 + \frac{\gamma P}{N_2})$  [4], [7]. Note that for each value of  $\gamma$ , we can design a channel code that provides a particular achievable rate pair (which gives an specific distortion pair). However, applying uncoded transmission yields the following distortion pair:

$$D_1 = \frac{\sigma_S^2}{1 + \frac{P}{N_1}}; \quad D_2 = \frac{\sigma_S^2}{1 + \frac{P}{N_2}}. \quad (2)$$

These distortions are clearly not simultaneously achievable by separate source-channel codes. This simple example provides a multi-user scenario where analog information is more valuable than digital information. In a similar spirit, this paper considers broadcasting correlated Gaussian sources and aims to characterize MSE distortion pairs that are simultaneously

achievable at the two receivers using hybrid digital-analog (HDA) coding schemes.

Shannon proved that the separate (independent) design of source and channel coding is an optimal strategy for a fixed channel signal-to-noise ratio (CSNR) in ergodic point-to-point communication systems (where optimality in terms of reproducing the source at the destination within a prescribed fidelity is achieved asymptotically as the coding/decoding delay and complexity increase without bound) [10]. Such a scheme is often referred to as a digital tandem source-channel coding scheme. There are two inherent problems associated with the digital tandem scheme: the “leveling-off effect” and the “threshold effect” [11], [12]. Since the system typically performs well at a certain designed CSNR, the system performance does not improve with increased CSNR (leveling-off effect), and it degrades drastically when the true CSNR falls beneath the designed CSNR (threshold effect). It is also known that this conceptually simple coding scheme does not in general lead to the optimal performance theoretically attainable (OPTA) in networks; see e.g. [4], [13].

On the other hand, for the point-to-point transmission of a single Gaussian source through an additive white Gaussian noise (AWGN) channel, it is well known (e.g., see [5], [13]) that if the channel and source bandwidths are equal, simple uncoded transmission achieves OPTA. Uncoded (or analog) transmission in this case (and in the rest of this paper) means scaling the encoder input subject to the channel power constraint and transmitting without explicit channel coding. The optimality of uncoded transmission in some multi-user communication systems was recently shown in [14]–[16].

In order to exploit the advantages of both analog transmission and digital techniques, a family of HDA schemes were introduced in the literature, see e.g., [1], [2], [7], [12], [17]–[26]. These methods usually offer better distortion performance than the purely analog or digital schemes; they do not suffer from the leveling-off effect, have a less severe threshold effect [18] compared to digital tandem source-channel coding schemes, and they can asymptotically achieve Shannon’s OPTA limit at the designed CSNR. The case of broadcasting a single memoryless Gaussian source with bandwidth mismatch between the source and the channel using HDA schemes is considered in [18], [20]. Bross *et al.* [27] show that there exists a continuum of HDA schemes with optimal performance for the transmission of a Gaussian source over an average-power-limited Gaussian channel with matched bandwidth. Tian and Shamai [28] generalize this result to the mismatched bandwidth case. In [29] Gao and Tuncel propose two new schemes for transmitting a Gaussian source over a Gaussian channel. These schemes directly generalize previous result of [27] by making better use of the dirty-paper coding auxiliary random variable. A complete characterization of the set of achievable distortion pairs in transmitting a Gaussian source with memory over an arbitrarily colored Gaussian broadcast channel with matched bandwidth is presented in [2]. In [30] inner and outer bounds for the distortion region in broadcasting a Gaussian mixture source is provided. Broadcasting a common source to multiple receivers having different correlated side information is investigated in [31]–[34]. An HDA coding scheme for broadcasting a common source to two receivers with matched

bandwidth having different correlated side information is proposed in [35], where the authors show that under certain conditions their scheme achieves the same performance as in point-to-point communication simultaneously at both receivers and is thus optimal. In [36], an HDA scheme is presented for the problem of sending a parallel Gaussian source over a white Gaussian broadcast channel.

Related work on broadcasting correlated sources can be found in [3], [16], [37]–[45]. Lossless transmission of finite alphabet sources is considered in [37]–[41], [46], and uncoded transmission for broadcasting correlated Gaussian sources is evaluated in [16]. It is shown in [16] that the uncoded scheme is optimal below a certain CSNR-threshold. In [47], we introduce a layered HDA scheme for broadcasting a bivariate Gaussian source with matched bandwidth. A complete characterization of the achievable distortion region in sending a bivariate Gaussian source over bandwidth-matched Gaussian broadcast channel was recently derived in [44], [45]. In a recent manuscript [48], the problem of broadcasting two correlated Gaussian sources using optimal separate source and channel codes is studied, where it is shown that the proposed scheme is very competitive for any bandwidth compression/expansion scenario. However, as mentioned before, separation based digital schemes suffer from the threshold effect while the HDA considered offer better performance in the presence of CSNR mismatch. The problem of sending a pair of finite alphabet correlated sources through a broadcast channel with correlated side information at the receivers is studied in [41]. A lattice-based hybrid coding is proposed in [3] for broadcasting independent as well as correlated Gaussian sources in the case of matched bandwidth. The authors in [3] show that their proposed scheme is optimal for broadcasting independent sources and performs better than separate source/channel coding for broadcasting correlated sources below a certain CSNR-threshold.

Our system model is illustrated in Fig. 2. We aim to determine achievable distortion regions using HDA schemes for two cases: 1) broadcasting with bandwidth compression, i.e., broadcasting with  $\lambda$  channel uses per source sample, where  $\lambda < 1$ , and 2) broadcasting with bandwidth expansion, where  $\lambda > 1$ . To the best of our knowledge, apart from [3], [16], [44], [45] and the recent result of [48], in which the problem of broadcasting correlated Gaussian sources is analyzed, there are no explicit distortion-regions in the literature for broadcasting correlated Gaussian sources. We are also not aware of any prior work discussing HDA schemes for broadcasting correlated Gaussian sources with bandwidth mismatch.

This paper reports on progress towards solving this difficult problem. We evaluate the performance of layered coding schemes for broadcasting correlated Gaussian sources and provide explicit expressions for the achievable distortion regions. Such schemes, which extend the HDA schemes of Wilson *et al.* [1] and Prabhakaran *et al.* [2] for the broadcasting of a single common Gaussian source, judiciously mix various coding strategies, ranging from HDA joint source-channel coding, Costa dirty paper coding [49], and Wyner-Ziv coding. Although the distortions are derived explicitly (in closed-form expressions) for all proposed schemes, a general and analytical

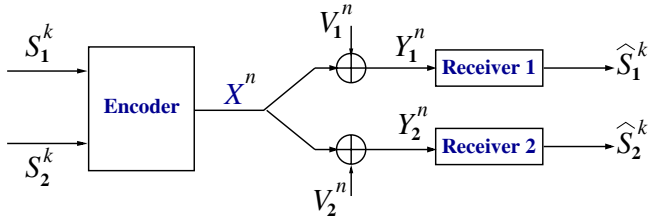

Fig. 2. Broadcasting correlated Gaussian sources over a two-user power-limited Gaussian broadcast channel. Receiver  $i$  aims to obtain an estimate of its corresponding source component,  $S_i^k$ , to within fidelity  $D_i$  ( $i = 1, 2$ ).

performance comparison of those schemes is quite difficult. In fact, the problem of finding an optimal power allocation policy among layers in order to optimize the achievable overall end-to-end distortion pairs is still open. Instead, we numerically evaluate the achievable distortion regions of different schemes and only present the best scheme in each bandwidth mismatch case. In addition, we provide an outer bound for the achievable distortion region and compare the achievable regions to that outer bound. In the case of bandwidth compression, a scheme combining analog transmission, superposition and Costa coding is presented. For bandwidth expansion, we introduce a hybrid Wyner-Ziv (HWZ) scheme, which consists of an analog layer and two layers each consisting of a Wyner-Ziv coder followed by a channel coder. In [50] we showed that our HWZ scheme performs similarly to the adapted Reznic-Feder-Zamir scheme, originally proposed in [20] for broadcasting a common Gaussian source to two users. Numerical examples<sup>1</sup> indicate that there is a gap between the achievable distortion regions and the outer region for both bandwidth mismatch cases and the construction of new schemes that can close or narrow this gap remains an interesting and challenging future direction.

The remainder of this paper is organized as follows. In Section II, we present the system model and problem statement. We derive the achievable distortion regions of HDA schemes with bandwidth compression and expansion in Sections III and IV, respectively. An outer region for broadcasting correlated Gaussian sources with mismatched bandwidth is provided in Section V. In Section VI, the boundaries of the distortion regions for the presented HDA schemes as well as the outer bound in both bandwidth mismatch cases are compared via numerical examples. An example involving our layered scheme with analog transmission and Costa coding of [47] is also presented; it is observed that the layered scheme's achievable region matches the outer bound region, indicating its potential optimality. Conclusions are given in Section VII.

## II. PROBLEM STATEMENT

Consider broadcasting correlated Gaussian sources (or equivalently a bivariate Gaussian source) across a two-user power-limited Gaussian broadcast channel. User  $i$  ( $i = 1, 2$ ) receives the transmitted signal corrupted by Gaussian noise with power  $N_i$  and aims to estimate source  $S_i$ . We assume

<sup>1</sup>Although in general the comparison for few examples may not provide a general insight into optimality, a similar behavior was observed by evaluating the achievable distortion regions in many other examples with different system parameters.

that  $N_1 > N_2$  and hence call user 1 the weak user and user 2 the strong user. Let  $S_1$  and  $S_2$  be correlated Gaussian random variables and let  $\{(S_1(t), S_2(t))\}_{t=1}^\infty$  be a stationary Gaussian memoryless vector source with marginal distribution that of  $(S_1, S_2)$ . We assume that  $S_1(t)$  and  $S_2(t)$  have zero mean and variance  $\sigma_{S_1}^2$  and  $\sigma_{S_2}^2$ , respectively, and correlation coefficient  $\rho \in (-1, 1)$ .

We represent the first  $k$  instances of the first and second source components by the data sequences  $S_1^k = (S_1(1), S_1(2), \dots, S_1(k))$  and  $S_2^k = (S_2(1), S_2(2), \dots, S_2(k))$ , respectively. The two-user Gaussian broadcast channel with receivers estimating the bivariate source components is shown in Fig. 2. Data sequences  $S_1^k$  and  $S_2^k$  are jointly encoded to  $X^n = \varphi(S_1^k, S_2^k)$ , where the encoder function is of the form

$$\varphi : \mathbb{R}^k \times \mathbb{R}^k \rightarrow \mathbb{R}^n. \quad (3)$$

The bandwidth compression/expansion ratio is defined by  $\lambda = \frac{n}{k}$  channel uses per source sample. We aim to find achievable distortion regions of HDA schemes for broadcasting with bandwidth compression where  $\lambda < 1$  (we specifically concentrate on  $\lambda = \frac{1}{2}$ ) and bandwidth expansion where  $\lambda > 1$  (in particular we set  $\lambda = 2$ ). The transmitted sequence  $X^n$  is average-power limited to  $P > 0$ , i.e.,

$$\frac{1}{n} \sum_{t=1}^n E[|X(t)|^2] \leq P. \quad (4)$$

User  $i$  observes the transmitted signal  $X(t)$  corrupted by a Gaussian noise  $V_i(t)$  with power (variance)  $N_i$ , so that at time  $t$  the receiver observes

$$Y_i(t) = X(t) + V_i(t), \quad i = 1, 2 \quad (5)$$

where  $V_i(t) \sim \mathcal{N}(0, N_i)$  are independently distributed over  $i$  and  $t$ , and are independent of  $X(t)$ . Based on the channel output  $Y_i^n$ , receiver  $i$  provides an estimate  $\hat{S}_i^k$  of the  $i$ th component of the source,  $S_i^k$ . We consider the average MSE distortion  $\Delta_i = \frac{1}{k} E[\sum_{t=1}^k |S_i(t) - \hat{S}_i(t)|^2]$ . The reconstructed signal at receiver  $i$  can be described by  $\hat{S}_i^k = \psi_i(Y_i^n)$ , where decoder functions are mappings

$$\psi_i : \mathbb{R}^n \rightarrow \mathbb{R}^k, \quad i = 1, 2. \quad (6)$$

Let  $\mathcal{F}^{(k,n)}(P)$  denote all encoder and decoder functions  $(\varphi, \psi_1, \psi_2)$  that satisfy (3)–(6). For a particular coding scheme  $(\varphi, \psi_1, \psi_2)$ , the performance is determined by the channel power constraint  $P$  and incurred distortion pairs  $\Delta_1$  and  $\Delta_2$  at both receivers. For any given power constraint  $P$ , the distortion region  $\mathcal{D}$  is defined as the closure of the convex hull of the set of all distortion pairs  $(D_1, D_2)$  for which  $(P, D_1, D_2)$  is achievable, where a power-distortion pair  $(P, D_1, D_2)$  is achievable if for any  $\delta > 0$ , there exist sufficiently large integers  $k$  and  $n = \lambda k$ , encoding and decoding functions  $(\varphi, \psi_1, \psi_2) \in \mathcal{F}^{(k,n)}(P)$ , such that  $\Delta_i \leq D_i + \delta$  ( $i = 1, 2$ ).

### III. DISTORTION REGION FOR BANDWIDTH COMPRESSION: LAYERING WITH ANALOG, SUPERPOSITION AND COSTA CODING

We consider the problem of broadcasting a bivariate Gaussian source with 2:1 bandwidth compression. We desire to transmit  $k = 2n$  samples of a bivariate Gaussian source  $(S_1^k, S_2^k)$  in  $n$  uses of a power-limited broadcast channel to two users. The two-user broadcast channel has the power constraint  $P$ . We split both components of the bivariate Gaussian source into two equal length parts, i.e., we split  $2n$  samples of each source vector  $S_i^{2n}$  into two vectors of length  $n$ :  $S_{i,1}^n$  and  $S_{i,2}^n$ .

In this scheme, we will closely follow the notation and code constructions in [1]. Here we only give a high-level description and analysis of the schemes without detailed proofs. In particular, in many steps of the analysis we treat finite-blocklength coding schemes as idealized systems with asymptotically large blocklengths. Detailed proofs can be given following arguments in [1], where a layering structure is introduced for broadcasting a memoryless Gaussian source. Here, we adapt this scheme for broadcasting a bivariate Gaussian source with a change in the structure of the second layer.

In the first (analog) transmission layer, a linear combination of the first  $n$  samples of the bivariate Gaussian source components are scaled such that the power of the transmitted signal in this layer  $X_a^n$  becomes  $P_a$ . Here  $X_a(t) = \alpha \sum_{i=1}^2 a_i S_{i,1}(t)$ , where  $\alpha = \sqrt{\frac{P_a}{a_1^2 \sigma_{S_1}^2 + a_2^2 \sigma_{S_2}^2 + 2a_1 a_2 \rho \sigma_{S_1} \sigma_{S_2}}}$ . This layer is meant for both strong and weak users. Now fix  $P_1$  and  $P_2$  to satisfy  $P = P_a + P_1 + P_2$ .

In the second and the third layers, we work on the remaining  $n$  samples of the source components, i.e.,  $S_{1,2}^n$  and  $S_{2,2}^n$ , respectively. In the second layer, we use two merged streams,  $X_{11}^n$  and  $X_{12}^n$ . The second part of the first component of the source,  $S_{1,2}^n$ , is broadcasted to two users. The first source encoder is an optimal source encoder with rate [4, Section 15.1.3]  $R_1'' = I(X_{11}; Y_1) = \frac{1}{2} \log(1 + \frac{(1-\gamma)P_1}{\gamma P_1 + P_a + P_2 + N_1})$ , where  $I(\cdot; \cdot)$  denotes the mutual information. The second source encoder is an optimal encoder for the residual error of the first encoder with rate  $R_2'' - R_1'' = I(X_{12}; Y_2 | X_{11}) = \frac{1}{2} \log(1 + \frac{\gamma P_1}{P_a + P_2 + N_2})$ . Then, we encode the quantization bits with capacity-achieving channel codes and transmit the resulting streams with powers  $(1-\gamma)P_1$  and  $\gamma P_1$ , respectively.

In the third layer, which is meant for the strong user,  $n$  samples of the second component of the source,  $S_{2,2}^n$  are Wyner Ziv coded using the estimate of  $S_{1,2}^n$  at the receiver as side information. The Wyner-Ziv index,  $m_2 \in \{1, 2, \dots, 2^{nR_2'}\}$ , is then encoded using Costa's "dirty paper" coding that treats both  $X_a^n$  and  $X_1^n$  as interference and uses power  $P_2 = P - P_a - P_1$ . Let  $U_2$  be an auxiliary random variable given by  $U_2 = X_2 + \alpha_2(X_a + X_1)$ , where  $X_2 \sim \mathcal{N}(0, P_2)$ ,  $X_1$  and  $X_a$  are independent of each other and  $\alpha_2 = \frac{P_2}{P_2 + N_2}$ . We generate a length  $n$  i.i.d. Gaussian codebook  $\mathcal{U}_2$  with  $2^{nI(U_2; Y_2)}$  codewords, where each component of the codeword is Gaussian with zero mean and variance  $P_2 + \alpha_2^2(P_a + P_1)$ , and each codeword is then randomly placed into one of  $2^{nR_2'}$  bins with  $R_2' = I(U_2; Y_2) - I(U_2; X_a, X_1) = \frac{1}{2} \log(1 + \frac{P_2}{N_2})$ . Let  $i(U_2^n)$  be the index of the bin containing  $U_2^n$ . For a given  $m_2$ , we look for an  $U_2^n$  such that  $i(U_2^n) = m_2$

and  $(U_2^n, X_a^n, X_1^n)$  are jointly typical. Then, we transmit  $X_2^n = U_2^n - \alpha_2(X_a^n + X_1^n)$ . We linearly combine all three layers and transmit  $X^n = X_a^n + X_1^n + X_2^n$ .

An achievable distortion-region can be obtained by varying  $P_a, P_1$  and  $P_2$  subject to  $P = P_a + P_1 + P_2$ . For a given  $P_a, P_1$  and  $P_2$ , the achievable distortion pairs can be computed as follows. At the decoder, we look for an  $X_{11}^n$  that is jointly typical with  $Y_1^n$ . The weak user estimates  $S_{1,1}^k = (S_{1,1}^n, S_{1,2}^n)$  by MMSE estimation from the received signal  $Y_1^n$  and the decoded  $X_{11}^n$ . The decoder reconstructs the sequence  $S_{1,2}^n$  as  $\hat{S}_{1,2}(i) = k_{12} X_{11}(i)$ . Then an estimate of the first component,  $S_{1,1}^n$ , can be obtained as  $\hat{S}_{1,1}(i) = k_{11}(Y_1(i) - X_{11}(i))$  where  $k_{11} = \frac{\alpha(a_1 \sigma_{S_1}^2 + a_2 \rho \sigma_{S_1} \sigma_{S_2})}{\gamma P_1 + P_a + P_2 + N_1}$ .

Thus, the overall distortion seen at the weak user is [1]:

$$D_1 = \frac{n}{k} D_{11} + (1 - \frac{n}{k}) D_{12} = \frac{1}{2} D_{11} + \frac{1}{2} D_{12}, \quad (7)$$

where  $D_{1j}$  ( $j = 1, 2$ ) is the MMSE distortion in estimating  $S_{1,j}^n$  from  $Y_1^n$  and  $U_1^n$ . Since in the second layer we require a rate of one channel use per source symbol, and the Gaussian source is successively refinable, by combining the Gaussian rate-distortion function with the pairs of achievable rates for a broadcast channel  $(R_1'', R_2'')$ , the corresponding achievable distortion pairs are:  $\sigma_{S_1}^2 2^{-2R_1''}$  and  $\sigma_{S_1}^2 2^{-2R_2''}$ . The weak user forms an MMSE estimate of  $S_{1,2}^n$  with the following distortion:

$$D_1 = \frac{1}{2} \left( \sigma_{S_1}^2 - \frac{\alpha^2 (a_1 \sigma_{S_1}^2 + a_2 \rho \sigma_{S_1} \sigma_{S_2})^2}{\gamma P_1 + P_a + P_2 + N_1} \right) + \frac{1}{2} \frac{\sigma_{S_1}^2}{1 + \frac{(1-\gamma)P_1}{\gamma P_1 + P_a + P_2 + N_1}}. \quad (8)$$

At the strong user, based on joint typicality, first an estimate of  $S_{1,2}^n$  can be obtained as  $\hat{S}_{1,2}(i) = k X_{12}(i)$  within distortion

$$D_{12}^* = \frac{1}{1 + \frac{\gamma P_1}{P_a + P_2 + N_2}} \times \frac{\sigma_{S_1}^2}{1 + \frac{(1-\gamma)P_1}{\gamma P_1 + P_a + P_2 + N_1}}.$$

This estimate acts as side information for obtaining the estimate of  $S_{2,2}^n$  using the decoded Wyner-Ziv bits. The resulting distortion for the strong user is thus given by

$$D_2 = \frac{1}{2} \left( \sigma_{S_2}^2 - \frac{\alpha^2 (a_2 \sigma_{S_2}^2 + a_1 \rho \sigma_{S_1} \sigma_{S_2})^2}{P_a + P_2 + N_2} \right) + \frac{1}{2} \sigma_{S_2}^2 \left( 1 - \rho^2 \left( 1 - \frac{D_{12}^*}{\sigma_{S_1}^2} \right) \right) \left( 1 + \frac{P_2}{N_2} \right)^{-1}. \quad (9)$$

Finally, note that if we set  $\rho = 1$  and  $\sigma_{S_1}^2 = \sigma_{S_2}^2$ , then the results of [1], [22], which currently appear to be the best known results for broadcasting a Gaussian source with bandwidth compression, are obtained.

### IV. DISTORTION REGION FOR BANDWIDTH EXPANSION: LAYERING WITH ANALOG AND WYNER-ZIV CODING (HWZ SCHEME)

We want to transmit  $k$  samples of a bivariate Gaussian source  $S^k = (S_1^k, S_2^k)$  in  $n = \lambda k$  uses of a power-limited broadcast channel to two users where  $\lambda > 1$  (we specifically concentrate on  $\lambda = 2$ ). The two-user broadcast channel has the power constraint  $P$ . We propose an HDA scheme, which

we refer to as the HWZ scheme, and provide an achievable distortion region. In [50] we also adapt the proposed HDA scheme for broadcasting a common source by Reznic, Feder and Zamir [20] to the problem of broadcasting correlated sources. Numerical examples indicate that both schemes have similar performance.

This scheme comprises three layers, an analog layer and two layers each consisting of a Wyner-Ziv coder followed by a channel coder. The scheme is similar to the one proposed in [1] for broadcasting a single memoryless Gaussian source with bandwidth compression except for the following: 1) Here we consider broadcasting correlated Gaussian sources. 2) The second layer in the scheme of [1] is an HDA Costa coding while here it is a Wyner-Ziv coder followed by a channel coder. 3) Since we consider broadcasting with bandwidth expansion, only the codewords of the second layer and the third layer (digital layers) are merged together, and then the transmitted sequence is obtained by multiplexing the codeword of the analog layer with the codeword of the digital layer, while in [1] the codewords of all three layers are merged as bandwidth compression is examined.

Block diagrams of the encoder and the decoder are shown in Fig. 3. In the first layer, the analog transmission layer, a linear combination of the  $k$  samples of the bivariate Gaussian source components are scaled such that the power of the transmitted signal,  $X_a^k$ , in this layer is  $P$ . Thus at time  $t$  we have  $X_a(t) = \alpha \sum_{i=1}^2 a_i S_i(t)$  where  $\alpha = \sqrt{\frac{P}{a_1^2 \sigma_{S_1}^2 + a_2^2 \sigma_{S_2}^2 + 2a_1 a_2 \rho \sigma_{S_1} \sigma_{S_2}}}$ . In the second layer,  $n - k = k$  samples of the first component of the source,  $S_1^k$  are Wyner Ziv coded at rate  $R_1' = I(X_{1d}; Y_{1d}) = \frac{1}{2} \log(1 + \frac{P_1}{P_2 + N_1})$  using an estimate of  $S_1^k$  at the receiver as side information. The Wyner-Ziv index,  $m_1' \in \{1, 2, \dots, 2^{kR_1'}\}$  is then encoded treating the third layer message as a noise and the codeword  $X_{1d}^{n-k}$  with power  $P_1$  is transmitted. In the third layer, which is meant for the strong user, the second component of the source,  $S_2^k$ , is also Wyner Ziv coded at rate  $R_2' = I(X_{2d}; Y_{2d} | X_{1d}) = \frac{1}{2} \log(1 + \frac{P_2}{N_2})$  using the estimate of  $S_2^k$  at the receiver as side information. The Wyner-Ziv index,  $m_2' \in \{1, 2, \dots, 2^{kR_2'}\}$ , is then encoded that treats  $X_{1d}^{n-k}$  as interference and uses power  $P_2$  such that  $P_1 + P_2 = P$ . As shown in Fig. 3, the transmitted sequence is obtained by multiplexing (in time) the codeword of the analog layer  $X_a^k$  with the codeword of the digital layer,  $X_d^{n-k} = X_{1d}^{n-k} + X_{2d}^{n-k}$ . Thus, the transmitted sequence can be represented as  $X^n = [X_a^k, X_d^{n-k}]$ .

At the decoder, from the received first  $k$  components of  $Y_1^n = [Y_{1a}^k, Y_{1d}^{n-k}]$ , an MMSE estimate of  $S_1^k$  as  $\hat{S}_{1a}^k$  can be obtained with an average distortion

$$D_{11} = \sigma_{S_1}^2 |_{\hat{S}_{1a}} = \sigma_{S_1}^2 - \frac{\alpha^2 (a_1 \sigma_{S_1}^2 + a_2 \rho \sigma_{S_1} \sigma_{S_2})^2}{P + N_1},$$

where  $\hat{S}_{1a}(i) = E[S_1(i) | Y_{1a}(i)] = k_1 Y_{1a}(k)$  and  $k_1 = \frac{\alpha (a_1 \sigma_{S_1}^2 + a_2 \rho \sigma_{S_1} \sigma_{S_2})}{P + N_1}$ . Since the Wyner-Ziv index  $m_1'$  must be decoded by the weak user, it is imposed that

$$\frac{k}{2} \log \left( \frac{D_{11}}{D_1} \right) = \frac{n-k}{2} \log \left( 1 + \frac{P_1}{P_2 + N_1} \right). \quad (10)$$

Therefore, the overall average distortion at the weak user can be expressed as

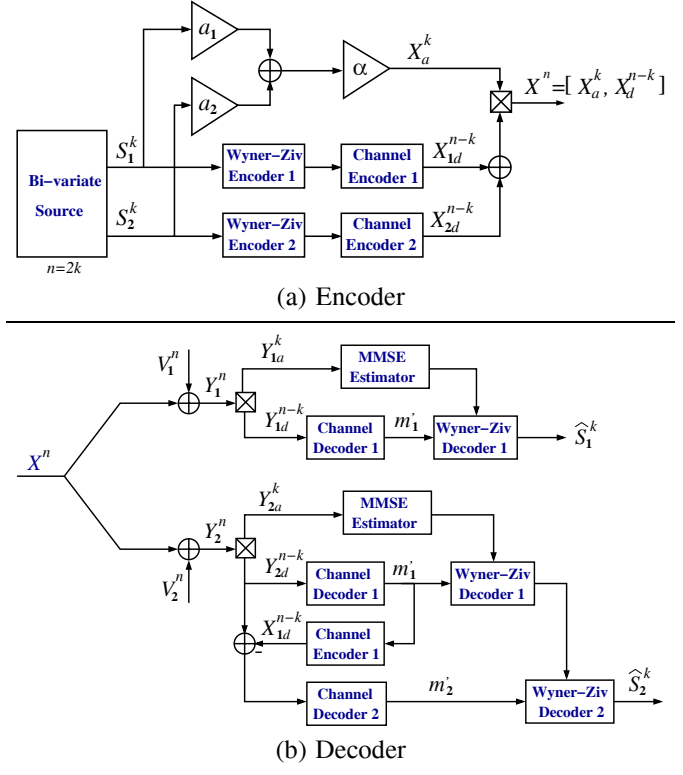

Fig. 3. Broadcasting a bivariate source  $S^k = (S_1^k, S_2^k)$  with bandwidth expansion: the HWZ scheme.

$$D_1 = D_{11} \left( 1 + \frac{P_1}{P_2 + N_1} \right)^{1-\lambda}. \quad (11)$$

At the strong user we want to make use of all transmitted layers. Since the transmitted sequence of the second layer (which carries information about  $S_1$ ) should be decoded by both the weak and the strong users, we ensure that we are able to obtain an estimate of  $S_1$  at the strong user as  $\hat{S}_{12}$ . However, at the strong user, our aim is to obtain an estimate of the second component of the source,  $S_2$ . Based on both the analog and the third layer transmitted sequences, and also the available side information at the strong user (i.e.,  $\hat{S}_{12}$ ), we obtain an estimate of  $S_2$ .

At first, from the analog layer, the strong user forms an estimate of the first component of the source,  $S_1^k$  with MMSE distortion

$$D_{11}^* = \sigma_{S_1}^2 - \frac{\alpha^2 (a_1 \sigma_{S_1}^2 + a_2 \rho \sigma_{S_1} \sigma_{S_2})^2}{P + N_2}. \quad (12)$$

Then, an estimate of the first component of the source can be obtained within distortion

$$D_1^* = D_{11}^* \left( 1 + \frac{P_1}{P_2 + N_1} \right)^{1-\lambda}. \quad (13)$$

This estimate acts as side information that can be used in obtaining the estimate of  $S_2^k$  for the strong user using the decoded Wyner-Ziv bits. Using the decoding condition for the Wyner-Ziv index  $m_2'$ , the overall distortion for the strong user in estimating  $S_2^k$  can be obtained as

$$D_2 = D_2^* \left( 1 + \frac{P_2}{N_2} \right)^{1-\lambda}, \quad (14)$$



where

$$D_2^* = \sigma_{S_2}^2 \left( 1 - \rho^2 \left( 1 - \frac{D_1^*}{\sigma_{S_1}^2} \right) \right). \quad (15)$$

## V. OUTER BOUND REGION

In [3], [16], [51], by assuming the knowledge of  $S_1^k$  at the receiver of the strong user, outer bounds for broadcasting correlated Gaussian sources with matched bandwidth were developed. By making minor modifications to the proof of Theorem 1 in [3], the following result can be obtained:

*Lemma 1:* The distortion region for broadcasting correlated Gaussian sources with bandwidth mismatch ratio  $\lambda$  consists of all pairs  $(D_1, D_2)$  such that

$$\begin{cases} D_1 & \geq \sigma_{S_1}^2 \left( 1 + \frac{(1-\eta)P}{\eta P + N_1} \right)^{-\lambda} \\ D_2 & \geq \sigma_{S_2}^2 (1 - \rho^2) \left( 1 + \frac{\eta P}{N_2} \right)^{-\lambda} \end{cases} \quad (16)$$

where  $\eta \in [0, 1]$ .

Here, we have assumed that the receiver of the strong user has access to the other source component; this is a reasonable assumption when the correlation coefficient is small. However, this outer bound might not be tight for high values of the correlation coefficient. To extend this outer bound, we assume that the decoder have access to a noisy version of the other source component,  $S'_1$ . Let  $S'_1 = \gamma S_1 + \nu$  with  $\nu$  being independent of  $S_1$ ,  $\sigma_\nu^2 = \sigma_{S_1}^2 (1 - \gamma^2)$  and  $\gamma \in [0, 1]$ . We obtain the following bound which includes (16) as an special case where  $\gamma = 1$ :

$$\begin{cases} D_1 & \geq \sigma_{S_1}^2 \left( 1 + \frac{(1-\eta)P}{\eta P + N_1} \right)^{-\lambda} \\ D_2 & \geq \max_{\gamma} \left\{ \sigma_{S_2}^2 (1 - \gamma^2 \rho^2) \left( 1 + \frac{P(1-\gamma^2(1-\eta))}{N_2} \right)^{-\lambda} \right\} \end{cases} \quad (17)$$

## VI. NUMERICAL RESULTS

*Example 1 (Bandwidth Compression):* We transmit  $k = 2n$  samples of a bivariate Gaussian source  $(S_1^k, S_2^k)$  with the covariance matrix  $\Lambda = \begin{bmatrix} 1 & \rho \\ \rho & 1 \end{bmatrix}$  in  $n$  uses of a power-limited broadcast channel to two users (weak and strong) with observation noise variances  $N_1 = -5$  dB and  $N_2 = 0$  dB, respectively. The distortion region for the scheme presented in Section III is shown in Fig. 4 for two different correlation coefficients,  $\rho = 0.2$  and  $\rho = 0.8$ . For comparison, we also depict the outer bound given by (17) for the set of all achievable distortion pairs in broadcasting correlated Gaussian sources. The outer bound is tight only for small values of the correlation coefficient and thus it is only shown for  $\rho = 0.2$ .

*Example 2 (Bandwidth Expansion):* We transmit  $k$  samples of a bivariate Gaussian source  $S^k = (S_1^k, S_2^k)$  with the covariance matrix  $\Lambda = \begin{bmatrix} 1 & \rho \\ \rho & 1 \end{bmatrix}$  in  $n = 2k$  uses of a power-limited broadcast channel to two users with observation noise variances  $N_1 = -5$  dB and  $N_2 = 0$  dB, respectively. The two-user broadcast channel has the power constraint  $P = 3$  dB. The boundaries of the outer bound in (17) and of the distortion region for the scheme of Section IV are shown in Fig. 5(a)-(b)

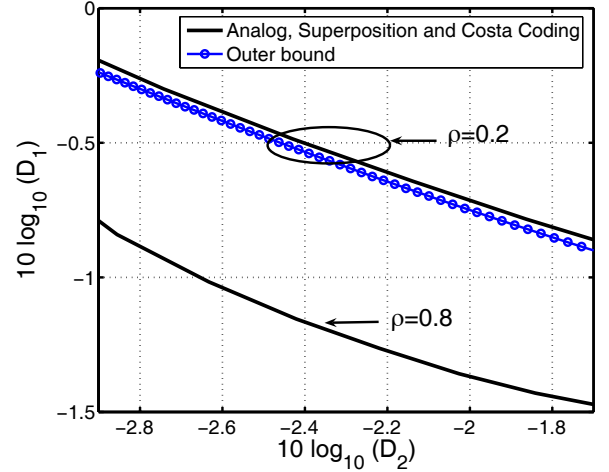

Fig. 4. Distortion region of an HDA coding scheme in broadcasting with bandwidth compression. System parameters are  $P = 0$  dB,  $N_1 = -5$  dB and  $N_2 = 0$  dB.

for two different values of the correlation coefficient,  $\rho = 0.2$  and  $\rho = 0.8$ . We observe that there is a gap between the achievable distortion region and the outer region.

*Example 3 (Matched Bandwidth):* We transmit  $n$  samples of a bivariate Gaussian source with covariance matrix  $\Lambda = \begin{bmatrix} 1 & 0.2 \\ 0.2 & 1 \end{bmatrix}$  in  $n$  uses of a power-limited broadcast channel to two users with observation noise variances  $N_1 = -5$  dB and  $N_2 = 0$  dB, respectively. The broadcast channel has the power constraint  $P = 0$  dB. The boundaries of the distortion region for the layering with analog and Costa coding scheme which we introduced in [47, Section III.B] as well as the lattice-based coding scheme of [3] are shown in Fig. 6. The outer bound in (16) of Lemma 1 is also shown. We observe that layering with analog transmission and Costa coding outperforms both uncoded transmission and lattice-based coding. Surprisingly, the outer bound is exactly on the boundary of our scheme. Based on several additional numerical evaluations and also by comparing the distortion region of our achievable scheme with the optimal distortion region, recently derived in [44], we conjecture that the proposed HDA JSCC scheme an optimal transmission scheme.

## VII. CONCLUSIONS

We considered HDA coding schemes for the transmission of a bivariate correlated Gaussian source over a power-limited two-user Gaussian broadcast channel. In particular, layered JSCC schemes were analyzed under mismatched bandwidth assumptions and their achievable distortion regions were derived. Variations of these schemes have previously been used in the literature for broadcasting a single memoryless Gaussian source. We also adapted the distortion outer bound of [3] in broadcasting correlated Gaussian sources with matched bandwidth to the bandwidth mismatch case. Numerical examples reveal a gap between their achievable distortion regions and the outer region. Further research is needed into developing improved coding schemes to close this gap.

(a)  $\rho = 0.2$ (b)  $\rho = 0.8$ 

Fig. 5. Achievable distortion region of the HWZ scheme and the outer bound region in broadcasting with bandwidth expansion. System parameters are  $\Lambda = \begin{bmatrix} 1 & \rho \\ \rho & 1 \end{bmatrix}$ ,  $P = 3$  dB,  $N_1 = -5$  dB and  $N_2 = 0$  dB.

## REFERENCES

- [1] M. Wilson, K. Narayanan, and G. Caire, "Joint source channel coding with side information using hybrid digital analog codes," *IEEE Trans. Inf. Theory*, vol. 56, no. 10, pp. 4922–4940, Oct. 2010.
- [2] V. M. Prabhakaran, R. Puri, and K. Ramchandran, "Colored Gaussian source-channel broadcast for heterogeneous (analog/digital) receivers," *IEEE Trans. Inf. Theory*, vol. 54, no. 4, pp. 1807–1814, Apr. 2008.
- [3] R. Soundararajan and S. Vishwanath, "Hybrid coding for Gaussian broadcast channels with Gaussian sources," in *Proc. IEEE ISIT*, June 2009.
- [4] T. M. Cover and J. A. Thomas, *Elements of Information Theory*, 2nd edition. John Wiley & Sons, 2006.
- [5] T. J. Goblick, "Theoretical limitations on the transmission of data from analog sources," *IEEE Trans. Inf. Theory*, vol. 11, no. 4, pp. 558–567, Oct. 1965.
- [6] M. D. Trott, "Unequal error protection codes: theory and practice," in *Proc. IEEE Inf. Theory Workshop*, June 1996, p. 11.
- [7] B. Chen and G. W. Wornell, "Analog error-correcting codes based on chaotic dynamical systems," *IEEE Trans. Commun.*, vol. 46, no. 7, pp. 881–890, July 1998.
- [8] M. C. Gastpar, "Separation theorems and partial orderings for sensor network problems," in Saligrama, Venkatesh, editor, *Networked Sensing Information and Control*. Springer, 2008.
- [9] W. H. R. Equitz and T. M. Cover, "Successive refinement of information," *IEEE Trans. Inf. Theory*, vol. 37, no. 2, pp. 269–275, Mar. 1991.

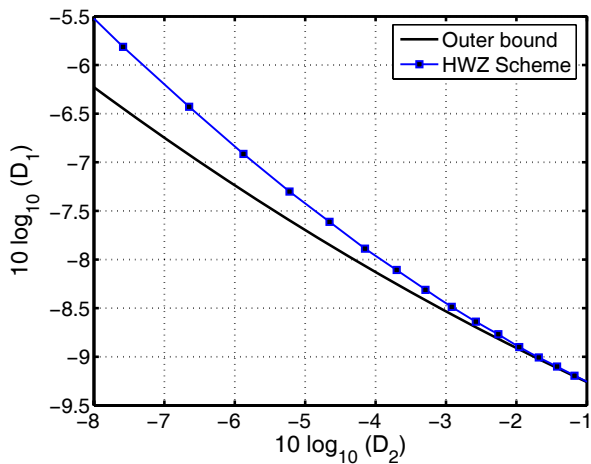
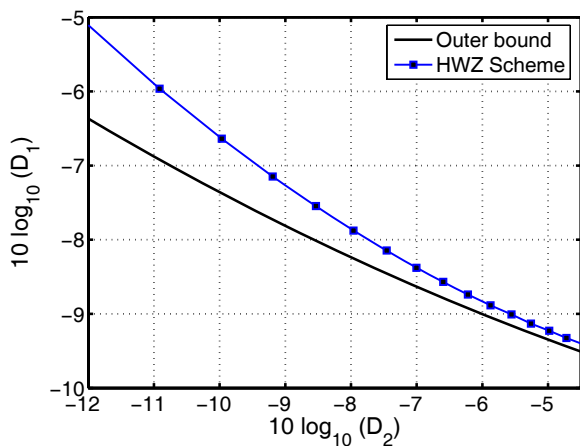
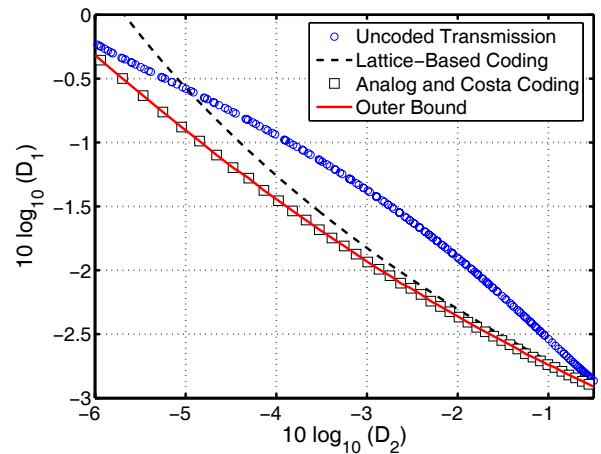

Fig. 6. Distortion regions in broadcasting a bivariate Gaussian source across a power-limited two-user Gaussian broadcast channel with matched bandwidth. System parameters are  $\rho = 0.2$ ,  $P = 0$  dB,  $N_1 = -5$  dB and  $N_2 = 0$  dB.

- [10] C. E. Shannon, "A mathematical theory of communication," *Bell Syst. Technical J.*, vol. 27, pp. 379–423, pp. 623–656, 1948.
- [11] —, "Communication in the presence of noise," *Proc. IRE*, vol. 37, no. 1, pp. 10–21, Jan. 1949.
- [12] M. Skoglund, N. Phamdo, and F. Alajaji, "Hybrid digital-analog source-channel coding for bandwidth compression/expansion," *IEEE Trans. Inf. Theory*, vol. 52, no. 8, pp. 3757–3763, Aug. 2006.
- [13] M. Gastpar, B. Rimoldi, and M. Vetterli, "To code, or not to code: lossy source channel communication revisited," *IEEE Trans. Inf. Theory*, vol. 49, no. 5, pp. 1147–1158, May 2003.
- [14] M. Gastpar, "Uncoded transmission is exactly optimal for a simple Gaussian sensor network," *IEEE Trans. Inf. Theory*, vol. 54, no. 11, pp. 5247–5251, Nov. 2008.
- [15] A. Lapidoth and S. Tinguely, "Sending a bi-variate Gaussian over a Gaussian MAC," *IEEE Trans. Inf. Theory*, vol. 56, no. 6, pp. 2714–2752, June 2010.
- [16] S. Bross, A. Lapidoth, and S. Tinguely, "Broadcasting correlated Gaussians," *IEEE Trans. Inf. Theory*, vol. 56, no. 7, pp. 3057–3068, July 2010.
- [17] S. Shamai, S. Verdú, and R. Zamir, "Systematic lossy source/channel coding," *IEEE Trans. Inf. Theory*, vol. 44, no. 2, pp. 564–579, Mar. 1998.
- [18] U. Mittal and N. Phamdo, "Hybrid digital-analog (HDA) joint source-channel codes for broadcasting and robust communications," *IEEE Trans. Inf. Theory*, vol. 48, no. 5, pp. 1082–1102, May 2002.
- [19] S. Sesia, G. Caire, and G. Vivier, "Lossy transmission over slow-fading AWGN channels: a comparison of progressive, superposition and hybrid approaches," in *Proc. IEEE ISIT*, Sep. 2005.
- [20] Z. Reznic, M. Feder, and R. Zamir, "Distortion bounds for broadcasting with bandwidth expansion," *IEEE Trans. Inf. Theory*, vol. 52, no. 8, pp. 3778–3788, Aug. 2006.
- [21] J. M. Lervik, A. Grovlen, and T. A. Ramstad, "Robust digital signal compression and modulation exploiting the advantages of analog communications," in *Proc. IEEE GLOBECOM*, Nov. 1995, pp. 1044–1048.
- [22] V. M. Prabhakaran, R. Puri, and K. Ramchandran, "Hybrid analog-digital strategies for source-channel broadcast," in *Proc. 43rd Allerton Conf. Commun., Contr., Comput.*, Sep. 2005.
- [23] C. T. K. Ng, D. Gündüz, A. J. Goldsmith, and E. Erkip, "Minimum expected distortion in Gaussian layered broadcast coding with successive refinement," in *Proc. IEEE ISIT*, June 2007, pp. 2226–2230.
- [24] C. Tian, A. Steiner, S. Shamai, and S. Diggavi, "Successive refinement via broadcast: optimizing expected distortion of a Gaussian source over a Gaussian fading channel," *IEEE Trans. Inf. Theory*, vol. 54, no. 7, pp. 2903–2918, July 2008.
- [25] K. Bhattad, K. R. Narayanan, and G. Caire, "On the distortion SNR exponent of some layered transmission schemes," *IEEE Trans. Inf. Theory*, vol. 54, no. 7, pp. 2943–2958, July 2008.
- [26] Y. Wang, F. Alajaji, and T. Linder, "Hybrid digital-analog coding with bandwidth compression for Gaussian source-channel pairs," *IEEE Trans. Commun.*, vol. 57, no. 4, pp. 997–1012, Apr. 2009.
- [27] S. Bross, A. Lapidoth, and S. Tinguely, "Superimposed coded and

- uncoded transmissions of a Gaussian source over the Gaussian channel," in *Proc. IEEE ISIT*, July 2006, pp. 2153–2155.
- [28] C. Tian and S. Shamai, "A unified coding scheme for hybrid transmission of Gaussian source over Gaussian channel," in *Proc. IEEE ISIT*, July 2008.
- [29] Y. Gao and E. Tuncel, "New hybrid digital/analog schemes for transmission of a Gaussian source over a Gaussian channel," *IEEE Trans. Inf. Theory*, vol. 56, no. 12, pp. 1782–1799, Dec. 2010.
- [30] Z. Reznic, R. Zamir, and M. Feder, "Joint source-channel coding of a Gaussian mixture source over the Gaussian broadcast channel," *IEEE Trans. Inf. Theory*, vol. 48, no. 3, pp. 776–781, Mar. 2002.
- [31] E. Tuncel, "Slepian-Wolf coding over broadcast channels," *IEEE Trans. Inf. Theory*, vol. 52, no. 4, pp. 1469–1482, Apr. 2006.
- [32] D. Gündüz and E. Erkip, "Reliable cooperative source transmission with side information," in *Proc. IEEE Inf. Theory Workshop*, July 2007.
- [33] J. Nayak, E. Tuncel, and D. Gündüz, "Wyner-Ziv coding over broadcast channels: digital schemes," *IEEE Trans. Inf. Theory*, vol. 56, no. 4, pp. 1782–1799, Apr. 2010.
- [34] D. Gündüz, J. Nayak, and E. Tuncel, "Wyner-Ziv coding over broadcast channels using hybrid digital/analog transmission," in *Proc. IEEE ISIT*, July 2008.
- [35] Y. Gao and E. Tuncel, "On optimality of a hybrid digital/analog scheme for Wyner-Ziv coding over broadcast channels," in *Proc. IEEE ISIT*, June 2010.
- [36] V. M. Prabhakaran, R. Puri, and K. Ramchandran, "Hybrid digital-analog codes for source-channel broadcast of Gaussian sources over Gaussian channels," arXiv:1101.5207v1.
- [37] T. S. Han and M. H. M. Costa, "Broadcast channels with arbitrarily correlated sources," *IEEE Trans. Inf. Theory*, vol. 33, no. 5, pp. 641–650, Sep. 1987.
- [38] G. Kramer and C. Nair, "Comments on 'broadcast channels with arbitrarily correlated sources,'" in *Proc. IEEE ISIT*, June 2009.
- [39] S. Choi and S. S. Pradhan, "Transmission of correlated messages over the broadcast channel," in *Proc. 39th Ann. Conf. Inf. Sci. Syst.*, Mar. 2005.
- [40] —, "A graph-based framework for transmission of correlated sources over broadcast channels," *IEEE Trans. Inf. Theory*, vol. 54, no. 7, pp. 2841–2856, July 2008.
- [41] W. Kang and G. Kramer, "Broadcast channel with degraded source random variables and receiver side information," in *Proc. IEEE ISIT*, July 2008, pp. 1711–1715.
- [42] T. Coleman, E. Martinian, and E. Ordentlich, "Joint source-channel decoding for transmitting correlated sources over broadcast networks," in *Proc. IEEE ISIT*, July 2006, pp. 2144–2147.
- [43] Y. Zhong, F. Alajaji, and L. L. Campbell, "Error exponents for asymmetric two-user discrete memoryless source-channel systems," in *Proc. IEEE ISIT*, June 2007, pp. 1736–1740.
- [44] C. Tian, S. N. Diggavi, and S. Shamai, "The achievable distortion region of bivariate Gaussian source on Gaussian broadcast channel," in *Proc. IEEE ISIT*, June 2010.
- [45] C. Tian, S. Diggavi, and S. Shamai, "The achievable distortion region of bivariate Gaussian source on Gaussian broadcast channel," submitted to *IEEE Trans. Inf. Theory*, arXiv:1006.0644v1, June 2010.
- [46] P. Minero and Y.-H. Kim, "Correlated sources over broadcast channels," arXiv:0902.1591v1.
- [47] H. Behroozi, F. Alajaji, and T. Linder, "Hybrid digital-analog joint source-channel coding for broadcasting correlated Gaussian sources," in *Proc. IEEE ISIT*, June 2009.
- [48] Y. Gao and E. Tuncel, "Separate source-channel coding for broadcasting correlated Gaussians," arXiv/1104.0230.
- [49] M. Costa, "Writing on dirty paper," *IEEE Trans. Inf. Theory*, vol. 29, no. 3, pp. 439–441, May 1983.
- [50] H. Behroozi, F. Alajaji, and T. Linder, "Broadcasting correlated Gaussian sources with bandwidth expansion," in *Proc. IEEE ITW*, Oct. 2009.
- [51] S. Bross, A. Lapidath, and S. Tinguely, "Broadcasting correlated Gaussians," in *Proc. IEEE ISIT*, July 2008.

**Hamid Behroozi** (S'04-M'08) received the B.Sc. degree from University of Tehran, Tehran, Iran, the M.Sc. degree from Sharif University of Technology, Tehran, Iran, and the Ph.D. degree from Concordia University, Montreal, QC, Canada, all in Electrical Engineering in 2000, 2003, and 2007, respectively. From 2007 to 2010, he was a Postdoctoral Fellow in the Department of Mathematics and Statistics, Queen's University, Kingston, ON, Canada. He is currently an Assistant Professor in the Electrical Engineering Department, Sharif University of Technology, Tehran, Iran. His research interests include information theory, joint source-channel coding, and cooperative communications.

Dr. Behroozi is the recipient of several academic awards including Ontario Postdoctoral Fellowship awarded by the Ontario Ministry of Research and Innovation (MRI), Quebec Doctoral Research Scholarship awarded by the Government of Quebec (FQRNT), Hydro Quebec Graduate Award, and Concordia University Graduate Fellowship.

**Fady Alajaji** (S'90-M'94-SM'00) received the B.E. degree with distinction from the American University of Beirut, Lebanon, and the M.Sc. and Ph.D. degrees from the University of Maryland, College Park, all in electrical engineering, in 1988, 1990, and 1994, respectively. He held a postdoctoral appointment in 1994 at the Institute for Systems Research, University of Maryland.

In 1995, he joined the Department of Mathematics and Statistics, Queen's University, Kingston, ON, Canada, where he is currently a Professor of mathematics and engineering. Since 1997, he has also been cross-appointed in the Department of Electrical and Computer Engineering at the same university. His research interests include information theory, digital communications, error control coding, joint source-channel coding, and data compression.

Dr. Alajaji currently serves as Area Editor and Editor for Source and Source-Channel Coding for the IEEE TRANSACTIONS ON COMMUNICATIONS. He served as co-chair of the 1999 Canadian Workshop on Information Theory, co-chair of the Technical Program Committee (TPC) of the 2004 Biennial Symposium on Communications, and a TPC member of several international conferences and workshops. He received the Premier's Research Excellence Award from the Province of Ontario.

**Tamas Linder** (S'92-M'93-SM'00) was born in Budapest, Hungary, in 1964. He received the M.S. degree in electrical engineering from the Technical University of Budapest in 1988, and the Ph.D. degree in electrical engineering from the Hungarian Academy of Sciences in 1992.

He was a Postdoctoral Researcher with the University of Hawaii, Honolulu, in 1992 and a Visiting Fulbright Scholar with the Coordinated Science Laboratory, University of Illinois at Urbana-Champaign, during 1993–1994. From 1994 to 1998, he was a faculty member with the Department of Computer Science and Information Theory, Technical University of Budapest. From 1996 to 1998, he was also a Visiting Research scholar with the Department of Electrical and Computer Engineering, University of California, San Diego. In 1998, he joined Queen's University, where he is now a Professor of Mathematics and Engineering with the Department of Mathematics and Statistics. His research interests include communications and information theory, source coding and vector quantization, machine learning, and statistical pattern recognition.

Dr. Linder received the Premier's Research Excellence Award of the Province of Ontario in 2002 and the Chancellor's Research Award of Queen's University in 2003. He was an Associate Editor for Source Coding of the IEEE TRANSACTIONS ON INFORMATION THEORY during 2003–2004.