



Beh, KC., Doufexi, A., & Armour, SMD. (2009). On the performance of SU-MIMO and MU-MIMO in 3GPP LTE downlink. In *IEEE 20th International Symposium on Personal, Indoor and Mobile Radio Communications, 2009 (PIMRC 2009), Tokyo, Japan* (pp. 1482 - 1486). Institute of Electrical and Electronics Engineers (IEEE).  
<https://doi.org/10.1109/PIMRC.2009.5450347>

Peer reviewed version

Link to published version (if available):  
[10.1109/PIMRC.2009.5450347](https://doi.org/10.1109/PIMRC.2009.5450347)

[Link to publication record in Explore Bristol Research](#)  
PDF-document

## University of Bristol - Explore Bristol Research

### General rights

This document is made available in accordance with publisher policies. Please cite only the published version using the reference above. Full terms of use are available:  
<http://www.bristol.ac.uk/red/research-policy/pure/user-guides/ebr-terms/>

# On the Performance of SU-MIMO and MU-MIMO in 3GPP LTE Downlink

Kian Chung Beh, Angela Doufexi, Simon Armour  
Centre for Communication Research, University of Bristol, Woodland Road, Bristol, BS8 1UB, U.K

**Abstract** - LTE (Long Term Evolution) is a next major step in mobile radio communications, and will be introduced as Release 8 in the 3rd Generation Partnership Project (3GPP). The new evolution aims to reduce delays, improve spectrum flexibility and reduce cost for operators and end users [1]. To fulfil these targets, new enabling technologies need to be integrated into the current 3G radio network architectures. Multiple Input and Multiple Output (MIMO) is one of the crucial enabling technologies in the LTE system particularly in the downlink to achieve the required peak data rate. The unitary codebook based precoding technique is proposed in the standard to increase the capacity of the system. This paper presents a link level analysis of the LTE downlink and an investigation of the performance of both Single User (SU) MIMO and Multi User (MU) MIMO with codebook based unitary precoding.

## I. INTRODUCTION

Multiple-Input Multiple-Output (MIMO) communication techniques have been studied extensively in the recent past. There are two popular techniques which have drawn much attention due to their promising capability to increase the spectral efficiency and reliability. One of the techniques is space-time block coding (STBC) [2], which is able to achieve full transmit diversity and enable reliable communication. Thus in LTE, an Alamouti based Space-Frequency Block Coding (SFBC) technique is proposed in the standard. However the transmit diversity based method does not provide a linearly increasing channel capacity as the number of transmit and receive element grows simultaneously. Another technique that is also proposed in the LTE standard is spatial multiplexing (SM) or Vertical Bell Labs Layered Space-Time (V-BLAST) [3] which aims to increase the ultimate spectral efficiency. However, this technique is limited by the transmission environment and highly dependent on the channel characteristics, which are determined by antenna configuration and richness of scattering. The performance degrades severely when the spatial channel correlation is high, e.g. in a line of sight (LOS) scenario.

SM employs multiple antennas at the transmitter and the receiver to provide simultaneous transmission of multiple parallel data streams over a single radio link. According to the latest LTE specification [4], multi-antenna transmission with 2 and 4 transmit antennas are supported. The most common configuration is expected to be 2x2 (particularly in earlier systems) and thus only this configuration is considered in this paper. Spatial multiplexing of multiple modulation symbol streams to a single user equipment (UE) using a same time-frequency resource is referred to as Single-User MIMO (SU-MIMO). However, additional diversity can be exploited in the spatial domain besides the diversity in the time and frequency domains. Scheduling different UEs on different spatial streams over the same time frequency resource is referred to as MU-MIMO and can give more flexibility to the scheduler. MU-MIMO can also be referred to as Spatial Division Multiple Access (SDMA) and

is expected to achieve the most overall system performance gain.

One of the key improvements of the LTE spectral efficiency is through the use of a codebook based unitary precoding, also known as per user unitary and rate control (PU2RC). Precoding is essentially a generalized beamforming scheme where the multiple streams of the signals are emitted from the transmit antennas with independent and appropriate weighting so as to increase the link throughput at the receiver output. Unitary precoding is able to suppress the co-channel interference (CCI) efficiently through orthogonal precoding vectors and increase the MU-MIMO capacity even with limited feedback. Details of the precoding scheme in LTE will be given in the next section. Though MU-MIMO offers greater flexibility in the spatial domain, it requires additional signalling overhead for different spatial layers and for the preferred precoding matrix. The complexity of resource allocation at the base station is also inevitably increased.

The rest of this paper is organized as follows. The codebook based precoding technique is described in Section II. In Section III, the system and channel model will be presented. Simulation results are presented and discussed in Section IV. Section V concludes the paper.

## II. UNITARY CODEBOOK BASED PRECODING

The purpose of the precoding is to optimize the transmissions to the characteristics of the radio channel so that when the signals are received, they can be more easily separated back into the original data streams. When used appropriately, precoding can achieve significant spectral efficiency improvement and many precoding methods been proposed in the literature. Non-linear methods such as Dirty paper coding (DPC) [5] can achieve the optimal performance but deployment of DPC in real-time is infeasible due to high complexity. Some linear precoding methods such as channel inversion method [6], Block Diagonalization [7] (BD) and codebook based precoding [8] have also been proposed. In particular, the codebook based precoding method has received considerable attention recently as this linear precoding method has been adopted in the LTE specification due to its practicality and simplicity.

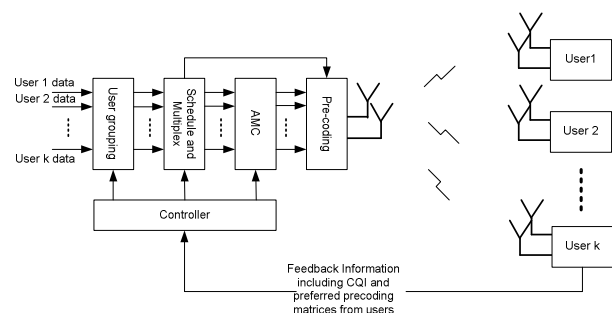

Figure 1: Configuration of MU-MIMO System

In this codebook based scheme, a UE only needs to find out a most suitable matrix (e.g. capacity maximising) from the codebook and feedback the corresponding index to the base station (BS). Thus, this scheme keeps the overhead and system complexity at a reasonable level but with considerable improvements in error performance. The configuration of the simulated MU-MIMO with precoding is shown in Figure 1.

One of the requirements for the pre-coder is that it must be unitary and orthogonal. The proposed unitary pre-coder for LTE is the Fourier basis pre-coder given in [8]. According to [9], only the codebook size of 2 is currently supported. As a reference for comparison purposes, a linear precoding matrix obtained by using the singular value decomposition method (SVD) is also considered. SVD is optimal in terms of error performance but has higher complexity and requires higher overhead.

A MIMO system with  $N_t$  transmit antennas and  $N_r$  receiver antennas is considered. Precoding is performed at every OFDMA sub-band or physical resource block (PRB). Assuming perfect timing and synchronization, the received signal at the UE for the  $k$ th PRB can be represented by:

$$Y(k) = H(k)E(k)X(k) + N(k) \quad (1)$$

where  $H(k)$  is the complex channel between the transmitter and receiver antennas,  $E(k)$  is the precoding matrix,  $X(k)$  is the transmit vector and  $N(k)$  is the additive white Gaussian noise which can be modelled as independent and distributed according to  $CN(0, N_0)$ . In MIMO detection, a linear receiver is designed to detect the transmitted data. Zero Forcing (ZF) or Minimum Mean Squared Error (MMSE) detection criterions are often used. In order to obtain a good performance with reasonable complexity, a linear MMSE receiver is adopted at the UE in this paper. The linear MMSE receivers can be obtained from [10]:

$$G_{(k)}^{MMSE} = [E(k)'H(k)'H(k)E(k) + (MN_0/\varepsilon_s)I_M]^{-1} E(k)'H(k)' \quad (2)$$

where  $M$  is the number of data streams,  $\varepsilon_s$  is the total transmit energy. The received signal  $Y(k)$  is then multiplied by  $G(k)$  to obtain the detected data stream,  $\hat{S}(k)$  for the  $k$ th PRB.

$$\begin{aligned} \hat{S}(k) &= G(k) * Y(k) \\ &= \hat{X}(k) + \hat{N}(k) \end{aligned} \quad (3)$$

For a 2x2 SM system, the MIMO channels have two subspaces that can be considered as 2 data streams transmitting through 2 parallel sub-channels. For data stream  $m$  at every PRB, the UE  $j$  computes the effective SINR for every data stream. The SINR for each data stream can be calculated from [10]:

$$SINR_m^{(MMSE)} = \frac{\varepsilon_s}{MN_0[E(k)'H(k)'H(k)E(k) + (MN_0/\varepsilon_s)I_M]^{-1}} - 1 \quad (4)$$

In the case of SU-MIMO SM, both the spatial streams will be allocated to the same UE. Thus in this work, the allocation is proposed to be based on the sum of achievable capacity of both spatial streams. The achievable data rate for PRB  $k$  is given by:

$$r_k = \sum_m \log_2(1 + SINR_m) \quad (5)$$

The scheduler then uses this feedback information to allocate the PRB to the UE with the highest achievable data rate  $r_k$ .

Since each of the spatial streams can be allocated and scheduled independently in MU-MIMO 2x2 SM, the UE  $j$  calculates the capacity data rate of each spatial layer and feeds that back to the BS. The data rate is calculated on a PRB basis by using:

$$r_k^m = \log_2(1 + SINR_m) \quad (6)$$

Again, for every PRB, the scheduler allocates each spatial layer to different UE(s), where channel conditions of the corresponding layer are the best. In the case of SISO and SFBC, the resource allocation is based on the channel gain, where the detailed description is well known and hence omitted here due to limited space.

In order to maximize the capacity of a precoded system, the most suitable precoding matrix needs to be based on the feedback from all users to transmit on each PRB. Two feedback strategies, namely full feedback scheme and partial feedback scheme are considered and compared. In the full feedback scheme, a UE feeds back a channel quality indicator (CQI) value for every matrix in the codebook, which gives more flexibility and accurate CQI information for scheduling. In the partial feedback scheme, the UE only feeds back a CQI value for the preferred matrix. In the UE, the preferred precoding matrix for a PRB is chosen by selecting the highest average SINR that is perceived by the user. Based on the feedback, the scheduler at BS chooses the precoding matrix with the highest sum capacity and apply to the PRB. In the full feedback scheme, when a precoding matrix for the PRB is chosen, the corresponding SINR can be fed into the scheduler which provides a more accurate CQI information than the partial feedback scheme. Users with the highest SINR for each stream will be selected and the selected users will then be precoded to share the same time and frequency resources to maximize the system capacity. In the case of MU-MIMO, the amount of feedback increases by  $M$  times compared to SU-MIMO, depending on the number of spatial layers. In the full feedback scheme, the amount of feedback is further increased by  $G$  folds, where  $G$  depends on the size of the codebook. In practice, a partial feedback strategy will be used where only the CQI value of the best precoding matrix is fed back.

### III SYSTEM AND CHANNELMODEL

The performance analysis is performed in the downlink of a 3GPP LTE OFDMA system. In the LTE, the total bandwidth in a system is divided into sub-channels, denoted as physical resource blocks (PRBs). Resources are allocated per PRB rather than individual subcarrier. In this paper, a 10MHz system bandwidth is assumed. The key parameters of the LTE OFDMA downlink system assumed are given Table 11. There are 50 PRBs in the 10MHz system, each consisting of 12 neighbouring sub-carriers. The sub-carrier bandwidth is 15 kHz and the PRB bandwidth is 180kHz. To feedback all the CQI for all the subcarriers is impractical in system design as this will create an enormous amount of overhead. Therefore, a single channel quality indicator (calculated from the average quality of the 12 sub-carriers) can be fed back for each PRB and is assumed to be perfectly known at the BS. Perfect channel estimation is also assumed. A 24 bits Cyclic Redundancy Check (CRC) enables error detection at the receiver.

Notation:  $\top$  is used to denote transposition,  $'$  to denote conjugate transposition,  $^{-1}$  to denote matrix inversion,  $^+$  to denote matrix pseudo-inverse and  $I_M$  to denote the  $M \times M$  identity matrix

In the case where frequency domain (PRB) dynamic allocation is employed, 10 users are simulated in the system unless otherwise stated. Due to the increased computational complexity and the insignificant gain of power control in the frequency domain dynamic allocation, equal power allocation is assumed throughout the simulation.

In the simulation, a channel remains the same during a packet transmission. The channel model used in the simulation is the Spatial Channel Model Extension [11] (SCME) Urban Macro scenario which is specified in 3GPP [12]. SCME provides a reduced variability tapped delay-line model which is well suited for link level as well as system level simulation. To evaluate the performance of MIMO schemes in LTE, different scenarios have been considered. Antenna spacing at the BS with  $0.5\lambda$ -spacing,  $4\lambda$ -spacing and  $10\lambda$ -spacing are considered. Users with  $0.5\lambda$ ,  $4\lambda$  and  $10\lambda$  spacing have an average correlations of 0.9 (very high) 0.5 (low) and 0.1 (very low) respectively. 2000 independently and identically distributed (i.i.d.) channel realisations are considered in each simulation.

Table 1: Parameters for LTE OFDMA downlink

Transmission BW		10 MHz
Time Slot/Sub-frame duration		0.5ms/1ms
Sub-carrier spacing		15kHz
Sampling frequency		15.36MHz (4x3.84MHz)
FFT size		1024
Number of occupied sub-carriers		601
Number of OFDM symbols per time slot (Short/Long CP)		7/6
CP length ( $\mu$ s/samples)	Short	(4.69/72)x6
	Long	(5.21/80)x1
		(16.67/256)

As specified in [4], three data modulation schemes are supported. These are QPSK, 16QAM and 64QAM. Six Modulation and Coding Schemes (MCS) levels are considered in this paper, as shown in table 2. The spectral efficiency of MIMO schemes is slightly reduced due to additional pilot overheads.

Table 2: Modulation and Coding Schemes

Mode	Modulation	Coding Rate	Data bits per time slot (1x1), (2x2)	Bit Rate (Mbps)
1	QPSK	1/2	4000/7600	8/15.2
2	QPSK	3/4	6000/11400	12/22.8
3	16 QAM	1/2	8000/15200	16/30.4
4	16 QAM	3/4	12000/22800	24/45.6
5	64 QAM	1/2	12000/22800	24/45.6
6	64 QAM	3/4	18000/34200	36/68.4

## IV. SIMULATION RESULTS

### A. LTE Downlink Link Level Simulation

Figure 2 shows the PER performance of a SISO scenario in the LTE OFDMA system for various MCS in the urban macro scenario. From the figure, it can be seen that an UE will be out of service when the SNR is below 0dB while the UE will be at the highest MCS at approximately 24dB given that PER transmission target of 10% is often expected by the operators. It is also worth mentioning that Mode 4, i.e. 16QAM  $\frac{3}{4}$  coding rate becomes obsolete for these channel conditions since it is outperformed by 64QAM  $\frac{1}{2}$  coding rate over the whole SNR range and gives the same nominal data rate. Since MIMO is supposed to be the better choice for

higher spectral efficiency, SISO performance is mainly simulated for comparison purposes.

Figure 3 shows the PER performances of the MIMO 2x2 SFBC for the LTE OFDMA system for different MCS in the urban macro scenario. From the figure, it can be seen that SFBC generally achieved a clear diversity gain of up to 7dB compared to the SISO scenario for all transmission modes. In particular, higher gain can be obtained for transmission modes with higher coding rate, e.g.  $\frac{3}{4}$  coding rate as more diversity gain can be obtained to improve the performance of the channel coding. However in the case of SFBC, the peak data rate remains the same but higher throughput can be expected for the same SNR compared to the SISO. To investigate the performance of SFBC in ill conditioned channels, scenarios with various correlation factors are simulated and presented. From Figure 4 it can be seen that the performance of SFBC is not affected much by the correlation of the channels. The performance drops by approximately 1-2dB in highly correlated channels even for high MCS.

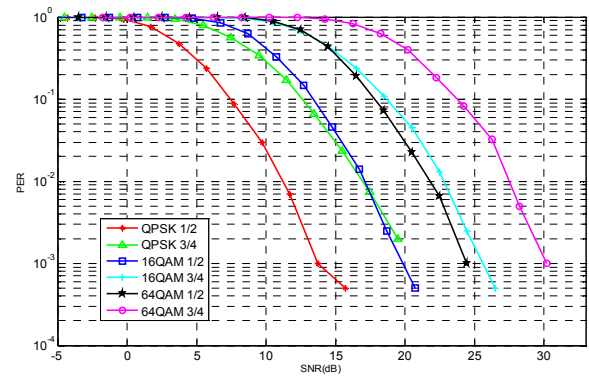

Figure 2: SISO PER Performance for Urban Macro channel

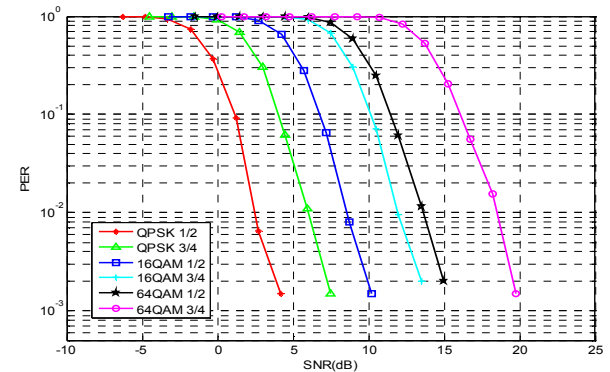

Figure 3: MIMO 2x2 SFBC PER Performance for Urban Macro channel with very low correlation (0.1)

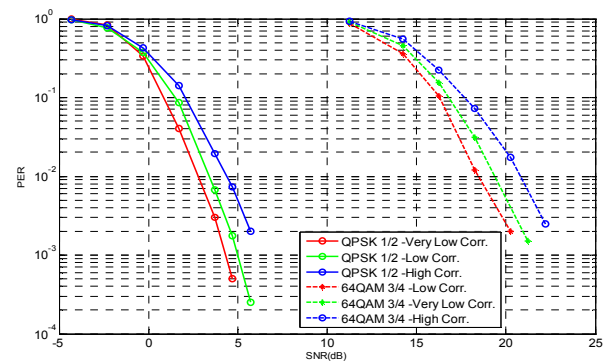

Figure 4: MIMO 2x2 SFBC PER Performance for QPSK  $\frac{1}{2}$  rate and 64QAM  $\frac{3}{4}$  rate with different correlation modes

Figure 5 shows the PER performances of the MIMO 2x2 SM LTE OFDMA system for various MCS in the urban macro scenario. Figure 5 shows that to achieve the same level of

PER performance as in the SISO case, the SM generally requires slightly higher SNR for all the MCS. Nevertheless, in the case of 2x2 SM, data rate can be almost doubled due to the simultaneous transmission of multiple parallel data streams. Performance of spatial multiplexing is highly dependent on the channel characteristics, which is determined by antenna configuration and richness of scattering. Therefore, from Figure 6 it can be seen that the SM performance is reduced by approximately 3 dB when the correlation of the channel increases from 0.1 to 0.5. When the correlation of the channel becomes very high, e.g. 0.9, 2x2 SM becomes almost unusable, especially at high MCS.

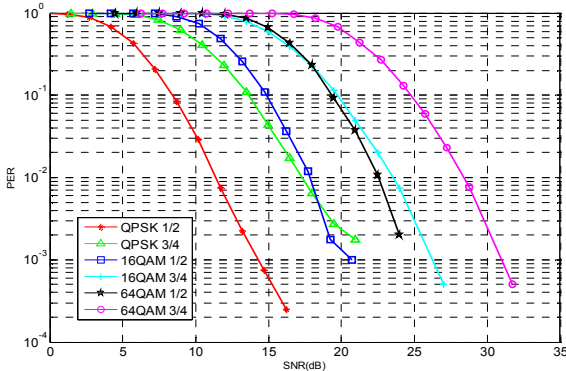

Figure 5: MIMO 2x2 SM PER Performance for Urban Macro channel with very low correlation (0.1)

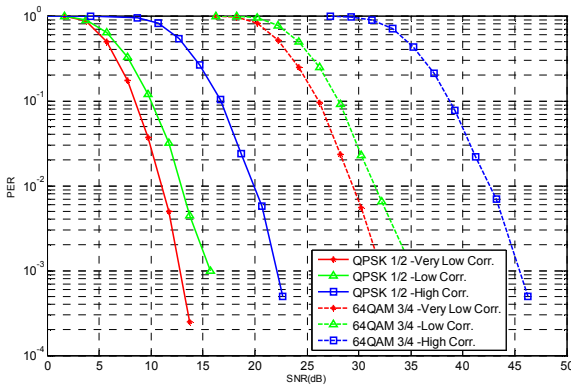

Figure 6: MIMO 2x2 SM PER Performance for QPSK  $\frac{1}{2}$  rate with different correlation factors

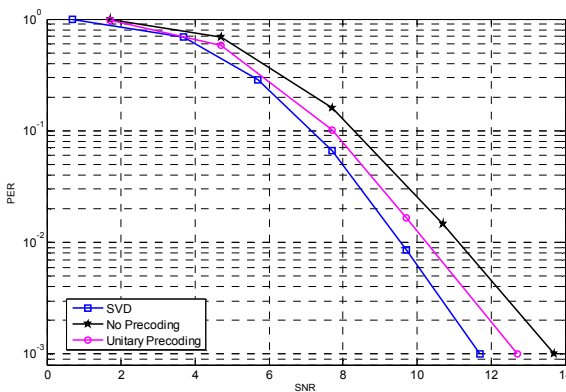

Figure 7: PER Performance of 2x2 SM with unitary precoding

Figure 7 shows the PER performance of MIMO 2x2 SM with unitary precoding in comparison to the SVD and non-coded system for the QPSK  $\frac{1}{2}$  rate transmission mode. From the figure it can be seen that unitary precoding of size 2 outperforms the non-coded system by approximately 1dB. SVD, on the other hand offers the best performance but full channel state information is required at the base station. However in this case, no multi-user diversity is exploited. That will be investigated in the following section.

### B. SU-MIMO and MU-MIMO with Unitary Precoding

In this section, the performance with dynamic sub-channel (PRB) allocation in frequency domain is presented for both SISO and MIMO schemes. A greedy algorithm is employed to exploit the inherent multi-user diversity.

Figure 8 shows that the PER performance of SU-MIMO SM is 4 dB better than the MIMO SM in QPSK  $\frac{1}{2}$  rate mode. MU-MIMO SM with full feedback is another 2-3 dB better than the SU-MIMO SM. The significant additional gain of MU-MIMO SM is attributed to the ability to exploit both the spatial and spectral multi-user diversity gain. The full feedback scheme is superior to the partial feedback scheme because of its greater flexibility and accurate CQI information when selecting PRBs.

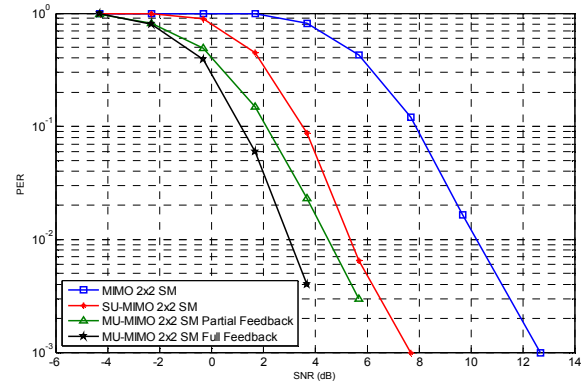

Figure 8: PER performance of SU-MIMO and MU-MIMO SM

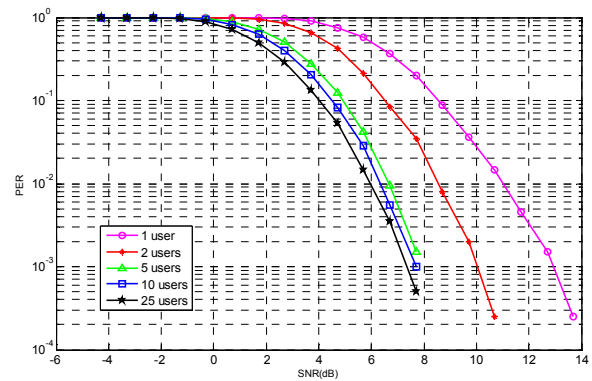

Figure 9: PER Performance of SU-MIMO SM with different numbers of users

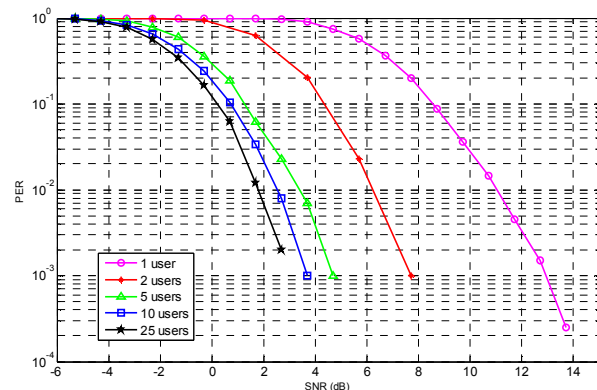

Figure 10: PER Performance of MU-MIMO SM with different numbers of users

Figure 9 and Figure 10 show the PER performance of the SU-MIMO and MU-MIMO SM with different number of users in the system respectively. As the number of users is increased from 1 to 25, the PER performances of both the SU-MIMO and MU-MIMO SM with unitary precoding gradually increases as a result of richer spectral multi-user diversity gains. However, in the case of MU-MIMO SM, more gain can be achieved through the additional dimension

of diversity in the spatial domain. MU-MIMO SM can therefore achieve similar level of diversity gain even with fewer users in the system.

### C. Throughput Performance Analysis

The average achievable throughput for SISO and MIMO schemes in the urban macro scenario is presented and compared in Figure 11 and Figure 12. The achievable throughput is given by:  $Throughput = R(1-PER)$ , where  $R$  and  $PER$  are the bit rate and the packet error rate for a specific mode respectively. The throughput envelope is obtained by using ideal adaptive modulation and coding (AMC) based on the (throughput) optimum switching point.

From Figure 11, it can be seen that a maximum spectral efficiency of 3.6bits/Hz/s can be achieved in a SISO scenario at an average SNR of 27dB. In the case of MIMO 2x2 SFBC, this maximum spectral efficiency can be achieved at an average SNR of approximately 19dB, an 8dB gain in comparison to the SISO scenario. SISO is completely outperformed by SFBC across the whole SNR range. For the MIMO 2x2 SM, a spectral efficiency up to 6.84bits/Hz/s can be achieved at an average SNR of 30dB. It can be seen that the switching point between the SFBC and SM is approximately 20dB. However, this is only applicable to low correlated channels. For highly correlated channels, the performance of the SM will degrade significantly while high correlation only has minimal effect on SFBC. Thus for highly correlated channels, the switching point is shifted to approximately 28dB.

Figure 12 shows the average throughput performance of the LTE system where dynamic allocation in frequency domain is employed. In this case, low correlated channels are assumed. SU-SISO is again outperformed by SU-SFBC across all the SNR range but with reduced margin. SM also achieves more diversity gain than the SFBC in terms of the frequency domain dynamic allocation. The switching point has been shifted to a smaller SNR value, at approximately 8dB. The SU-MIMO SM allows for almost doubling the throughput of a SU-SISO system but only at high SNR. However when the additional spatial diversity can be exploited, the MU-MIMO SM can provide almost double the throughput across the whole SNR range. MU-MIMO SM with full feedback outperforms all other schemes except SU-SFBC at very low SNRs. The partial feedback scheme is marginally inferior to the full feedback scheme. However, these results are only applicable to the scenario where all the users have very low correlated channels. MU-MIMO SM schemes also require additional signalling overheads in the uplink that will reduce the overall spectral efficiency.

### V. CONCLUSION

In this paper, a thorough analysis of LTE downlink including codebook based unitary precoding is presented. Simulation results have shown that the performance gain of unitary precoding in a conventional single user MIMO scenario is limited. When spectral and multi-user diversity are exploited, significant gains can be achieved. Additional diversity in the spatial domain can be achieved when the same time-frequency resources are shared among different users. MU-MIMO SM with full feedback achieves superior performance than all other schemes but at the cost of higher signalling overhead and scheduling complexity.

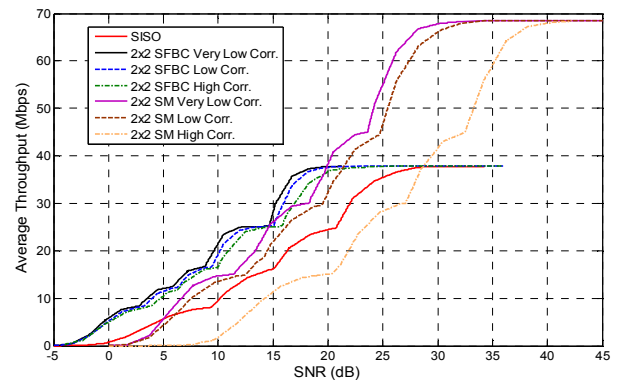

Figure 11: Average Throughput of SISO, MIMO 2x2 SM and MIMO 2x2 SFBC with different correlation factors

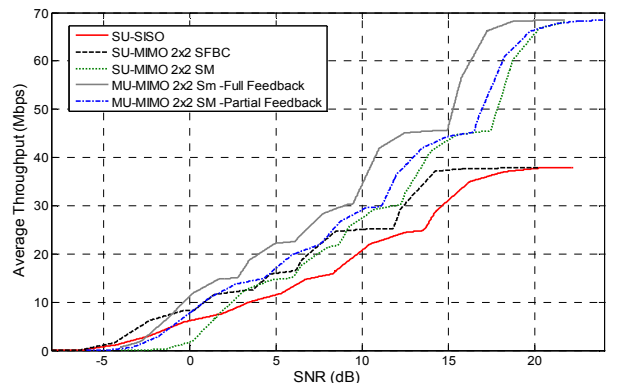

Figure 12: Average Throughput of SISO and MIMO schemes with frequency domain allocation at very low correlation channels

### ACKNOWLEDGEMENTS

This project is funded as part of the Core 4 Research Programme of the Virtual Centre of Excellence in Mobile & Personal Communications, Mobile VCE, ([www.mobilevce.com](http://www.mobilevce.com)), whose funding support, including that of EPSRC is gratefully acknowledged.

### REFERENCES

- [1] "3GPP; Technical Specification Group Radio Access Network; Requirements for E-UTRA and E-UTRAN (R7)", 3GPP TR 25.913 V7.3.0, March, 2006. [Online] Available:<http://www.3gpp.org/ftp/Specs/html-info/25913.htm>
- [2] S. Alamouti, "A simple transmit diversity technique for wireless communications", IEEE JSAC, Vol. 16, No. 8, pp. 1451-1458, 1998
- [3] Gerard J. Foschini, Glen D. Golden, Reinaldo A. Valenzuela, and Peter W. Wolniansky, "Simplified Processing for High Spectral Efficiency Wireless Communication Employing Multi-Element Arrays", IEEE Transactions on Selected Areas in Communications, Vol. 17, No. 11, Nov 1999
- [4] "Technical Specification Group Radio Access Network; (E-UTRA) and (E-UTRAN): Overall Description", 3GPP TS 36.300 V8.4.0, Mar.08 [Online]: <http://www.3gpp.org/ftp/Specs/html-info/36300.htm>
- [5] M.Costa, "Writing on Dirty Paper", IEEE Trans. Information Theory, vol. 29, no. 3, May 1983, pp. 439 - 441
- [6] T. Haustein, C.von Helmolt, E. Jorswieck, et al, ; Performance of MIMO systems with channel inversion', IEEE 55<sup>th</sup> VTC, vol. 1, May 2002, pp. 35-39
- [7] Q. H. Spencer, A. L. Swindlehurst, and M. Haardt, ' Zero-forcing methods for downlink spatial multiplexing in multiuser MIMO channels' IEEE Trans. Signal Processing, Vol. 52, no. 2, Feb. 2004, pp. 461-471
- [8] R1-051353, Samsung, "Downlink MIMO for EUTRA," 3GPP RAN1 #43, Seoul, Korea, November 2005.
- [9] "Technical Specification Group Radio Access Network; (E-UTRA) and (E-UTRAN): Physical Channels and Modulation", 3GPP TS 36.211 V8.4.0, Sept 08. [Online]: <http://www.3gpp.org/ftp/Specs/html-info/36211.htm>
- [10] David J.Love, Robert W. Health, ' Limited Feedback Unitary Precoding for Spatial Multiplexing Systems', IEEE Transactions on Information Theory, Vol. 51, No.8, August 2005
- [11] D.S.Baum, J.Hansen, J.Salo, "An interim channel model for beyond-3G systems: extending the 3GPP spatial channel model (SCM)", VTC 2005 Spring, Volume 5, Page 3132 - 3136
- [12] "Spatial channel model for MIMO simulations", 3GPP TR 25.996 V6.1.0, Sep'03. [Online]: <http://www.3gpp.org/ftp/Specs/html-info/25996.htm>