



AALBORG UNIVERSITY
DENMARK

Aalborg Universitet

Online Vce measurement method for wear-out monitoring of high power IGBT modules

Beczkowski, Szymon; Ghimire, Pramod; de Vega, Angel Ruiz; Munk-Nielsen, Stig; Rannestad, Bjørn; Thøgersen, Paul

Published in:

Proceedings of the 15th European Conference on Power Electronics and Applications, EPE 2013

DOI (link to publication from Publisher):

[10.1109/EPE.2013.6634390](https://doi.org/10.1109/EPE.2013.6634390)

Publication date:

2013

Document Version

Early version, also known as pre-print

[Link to publication from Aalborg University](#)

Citation for published version (APA):

Beczkowski, S., Ghimire, P., de Vega, A. R., Munk-Nielsen, S., Rannestad, B., & Thøgersen, P. (2013). Online Vce measurement method for wear-out monitoring of high power IGBT modules. In *Proceedings of the 15th European Conference on Power Electronics and Applications, EPE 2013* IEEE Press.
<https://doi.org/10.1109/EPE.2013.6634390>

General rights

Copyright and moral rights for the publications made accessible in the public portal are retained by the authors and/or other copyright owners and it is a condition of accessing publications that users recognise and abide by the legal requirements associated with these rights.

- Users may download and print one copy of any publication from the public portal for the purpose of private study or research.
- You may not further distribute the material or use it for any profit-making activity or commercial gain
- You may freely distribute the URL identifying the publication in the public portal -

Take down policy

If you believe that this document breaches copyright please contact us at vbn@aub.aau.dk providing details, and we will remove access to the work immediately and investigate your claim.

Online V_{ce} measurement method for wear-out monitoring of high power IGBT modules

Szymon Bęczkowski*, Pramod Ghimre,
Angel Ruiz de Vega, Stig Munk-Nielsen
Aalborg University
Pontoppidanstræde 101
9220 Aalborg, Denmark
*sbe@et.aau.dk

Bjørn Rannestad, Paul Thøgersen
KK Electronic A/S
Bøgildvej 3Sdf
7430 Ikast, Denmark

Keywords

Measurement, reliability, IGBT, diode, ageing.

Abstract

A simple V_{ce} online monitoring circuit is presented in this paper. It allows an accurate wear out prediction of IGBT modules, in high-power applications, during normal converter operation. Bipolar measurement allows monitoring of both IGBT and antiparallel diode. The circuit uses two serial connected diodes to sense the V_{ce} voltage with millivolt accuracy. One diode acts as a protection to block high DC voltage present on input terminals. When the device is conducting the voltage on the second diode is measured to compensate for the voltage drop on the protection diode thus eliminating voltage offset due to diodes' forward voltage temperature dependency. Using four diodes one can monitor voltages on all power devices in a converter leg.

Introduction

High power IGBT modules are the weakest part of the power converter due to continuous exposition to temperature cycles predominantly created by the conduction power losses in the chip [1]. During operation, the IGBT modules start to degrade and ultimately fail to function. There are several failure mechanisms that are connected to module failures: bond wire fatigue (bond wire lift off and heel cracking), aluminum reconstruction, die cracking, corrosion, solder fatigue, solder voids and burnouts [2].

The prior prediction or warning for the degradation of power module helps to maintain the converter and schedule the IGBT replacement before switch failure occurs. This lowers the downtime of wind turbines, especially for the off shore wind farm where sea conditions may greatly extend it [3].

Standard multichip IGBT module consists of separate layers of wire bond, chip and substrate solder, ceramic substrate, bus bar solder and casing. The coefficients of expansion (CTE) of the material from each layer do not match with the consecutive layers. Due to unmatched CTE, the temperature variations create stress on each layer of module. The Al bond wire lift-off as shown in figure 1 and solder joint crack are the dominating failures in the standard IGBT module [4].

Research has shown, that V_{ce} is the dominant monitoring parameter to detect the degradation of the IGBT module [5-7]. V_{ce} is main temperature dependent parameter and it increases with the corresponding increase in junction temperature. Typically, the V_{ce} is measured offline due to high degree of accuracy needed for this measurement and high voltage input range to the measurement circuit. The online V_{ce} measurement technique can be used to predict the wear out status of IGBT modules during normal converter period.

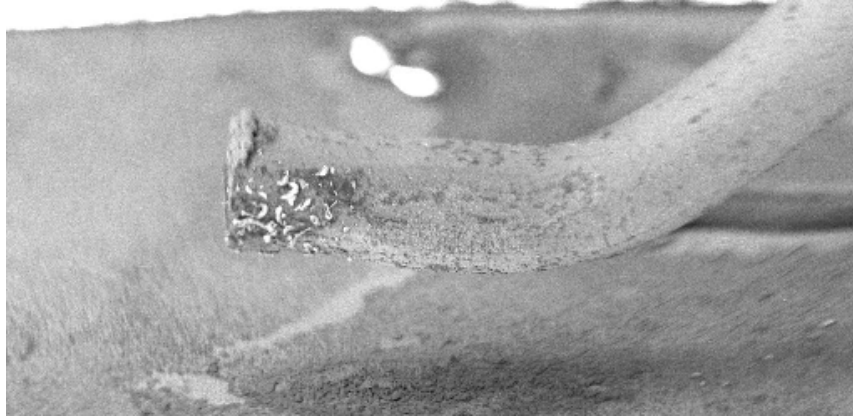

Fig. 1: Bond wire lift-off (42× magnification).

Off-line V_{ce} measurement method

An accelerated lifetime measurement of IGBT modules setup (fig. 2a) has been presented [8, 9]. The measurement setup has the ability of testing the DUT in application specific operating point. Test procedures consisted of one to two weeks converter operation. Every five minutes, the test was halted, the V_{ce} and V_f of respective devices were measured and the test was resumed.

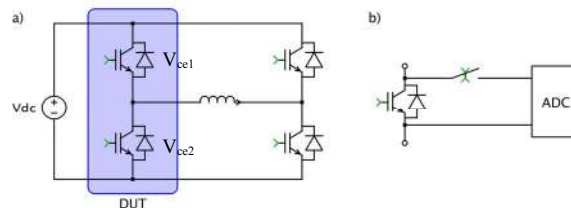

Fig. 2: a) Test bench for offline V_{ce} measurement, b) ADCs connected to both IGBTs in the DUT module via a reed relay.

V_{ce} and V_f measurement were performed by connecting an ADC to the selected device with a relay, when the transistor or diode were conducting (fig. 2b). The converter had to be stopped for the measurements because of the slow reaction time of the relay, which was around 3ms.

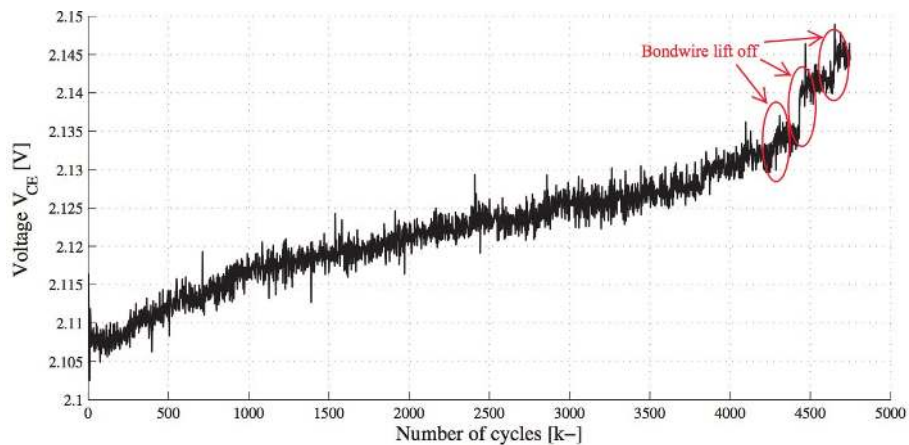

Fig. 3: Measured IGBT V_{ce} voltage with three bond wire lift-off events observed [9].

The measurement ADC was a 12bit $\pm 5V$ device with resolution of 2.44 mV. During tests, an increase of approximately 40mV in V_{ce} voltage was observed before the Infineon FF1000R17IE4 module had

failed. Separate, sharp voltage steps were observed in the voltage (fig. 3), corresponding to bond wire liftoff events.

An online measurement allows the measurement of the converter parameters during its operation. In the offline measurement process, the converter is disconnected from the main power source, which is not realizable to implement in a field operation. Moreover, the on-state voltage and junction temperature during switching operation will be higher than in the offline operation. In addition to this, a thermal coupling between IGBT and chip inside power module will not be similar in the online and offline operation. Because of the slow operation of the relay in the offline measurement, the temperature of the coolant decreases; consequently this reduces the junction temperature of the IGBT during the measurement process.

On-line V_{ce} measurement method

The V_{ce} measurement circuit uses similar technique as well known desaturation protection. IGBT gate drivers use this technique to protect the transistors against short-circuit and overload currents [10, 11]. The V_{ce} voltage is sensed to detect if the transistor current enters saturation region.

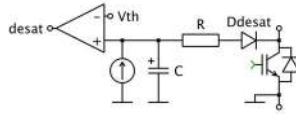

Fig. 4: Typical desaturation protection circuit.

Protection circuitry (fig. 4) contains a current source that forward biases the D_{desat} diode when the IGBT is on. The V_{ce} voltage (with D_{desat} forward voltage offset) is compared to predefined V_{th} threshold voltage. A RC filter protects the comparator and provides necessary blanking time. When the transistor is off, the blocking voltage is present on the D_{desat} diode.

Similar schemes are used in online junction temperature measurement [12, 13]. They utilize an active switch or a passive clamping circuit to protect the sensitive ADC against high voltage that can be present on the IGBT.

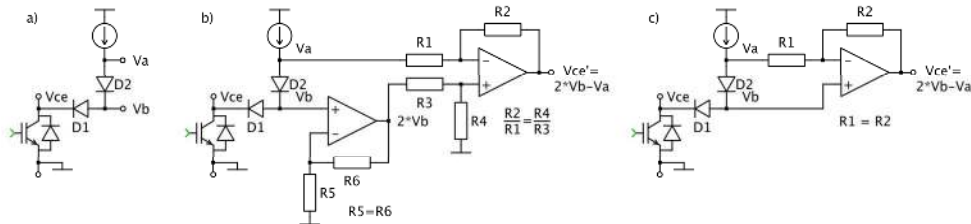

Fig. 5: V_{ce} measurement: a) basic measurement circuit, b) V_{ce} calculation using differential operational amplifier, c) simplified measurement circuit with gain equal to one.

Figure 5a shows the principle of V_{ce} measurement system operation. Two diodes are connected in series and a current source forward-biases them during the transistor on time. When the transistor is off, the $D1$ diode is blocking the V_{ce} voltage, protecting the measurement circuitry from damage. Additional low-leakage diode, antiparallel to diode $D2$ (not shown in the schematic), is required so that only $D1$ diode blocks high voltage. Assuming the two diodes are identical ($V_{D1} = V_{D2}$), the V_{ce} voltage may be measured by subtracting the voltage drop on diode $D2$ from the V_b potential.

$$V_{ce} = V_b - V_{D2} = V_b - (V_a - V_b) = 2V_b - V_a \quad (1)$$

This mathematical function can be realized using a circuit shown in figure 5b. First, the V_b voltage is amplified with a gain of two ($R5 = R6$). A differential amplifier subtracts the V_a voltage from the $2 \cdot V_b$ voltage. In this circuit, there is a possibility of changing the gain of the differential amplifier to fully utilize the ADC voltage range.

If the gain of the differential amplifier is set to one, then the R3 and R4 resistors form a voltage divider with the ratio of 0.5. Because of this, the voltage on the non-inverting pin of the operational amplifier is equal to V_b , therefore the circuit can be simplified to the form shown in figure 5c. The output voltage of the amplifier is tracking the V_{ce} voltage. If the amplifier is supplied with bipolar voltage, the circuit will operate for both positive and negative V_{ce} , therefore the IGBT antiparallel diode voltage V_f can also be measured.

In order for the measurement circuit to meet the desired specifications, the two diodes: D1 and D2 need to meet certain criteria:

1. The current through the two diodes should be equal. Connecting diodes' common terminals to high impedance input of the amplifier fulfills this condition.
2. The diodes should be thermally coupled to keep the junction temperatures on similar level. This can be done e.g. by using a two diode in a single package.
3. Two diodes still need to have similar forward voltage temperature coefficients.

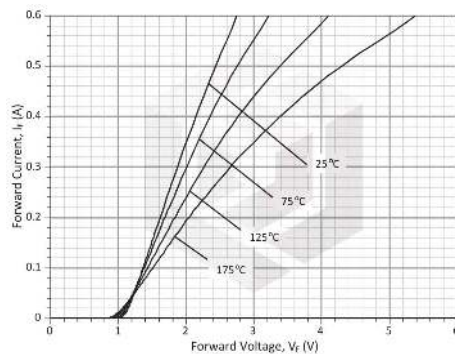

Fig. 6: Current-voltage characteristics of a high-voltage 2kV SiC diode [14].

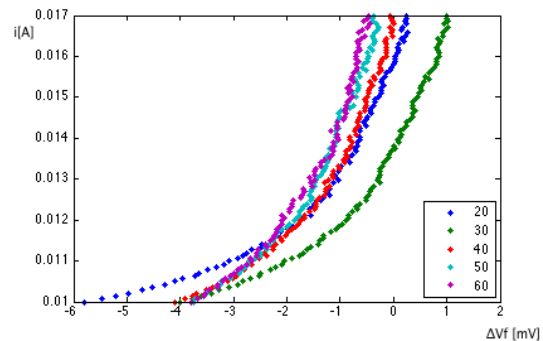

Fig. 7: Voltage difference between two measurement diodes at various ambient temperatures.

Low power SiC Schottky diodes have the best characteristics to be used in the measurement circuit: high breakdown voltage, negligible reverse recovery and zero forward voltage thermal coefficient (fig. 6) at certain current level.

A BY203 2kV diode was chosen as a measurement diode due to low reverse recovery and high blocking voltage. Two, randomly selected diodes, were analyzed. Their current-voltage characteristics were compared at a range of ambient temperatures. Results, shown in figure 7, show the difference in forward voltage is dependent on the measurement current. Based on these results, the test current was set to 10mA.

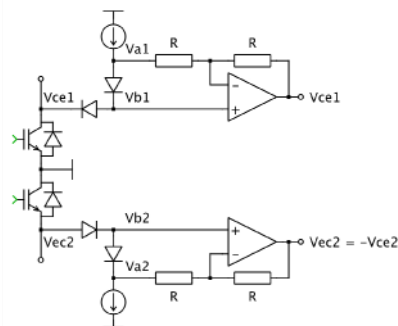

Fig. 8: Online measurement system capable of measuring V_{ce1} , V_{ce2} , V_{f1} and V_{f2}



Fig. 9: Prototype of measurement system

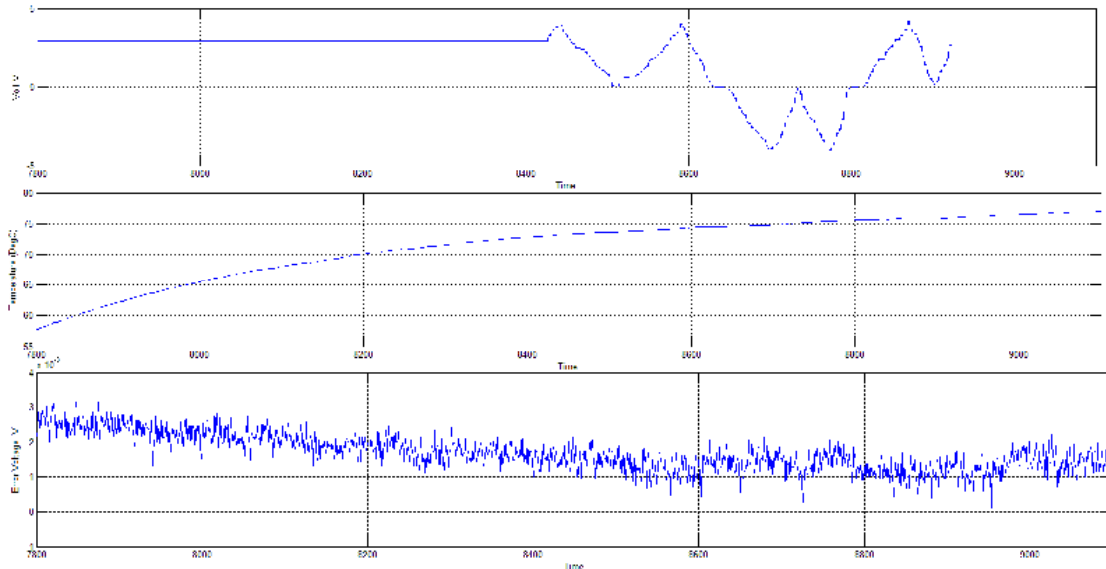

Fig. 10: Prototype board test measurement: (top) input V_{ce} voltage, (middle) ambient temperature and (bottom) error voltage = $V_{ce} - V_{out}$.

The measurement circuit has been designed to achieve accuracy around 1mV. A $\pm 5V$ 14-bit ADC with resolution of 0.61mV has been chosen. Analog circuitry has been designed so that ageing and temperature effects will be lower than $\frac{1}{2}$ of the LSB. A MAX9633 amplifier has been chosen so that the V_{os} temperature variation and the settling time conditions are satisfied. MAX5490 100k precision voltage divider has been used to assure thermal and time stability. Adding a 25k Ω series resistor on the non-inverting input compensates amplifier's bias current. The ADC works with external voltage reference REF5025 capable of maintaining half bit accuracy within the desired temperature range. The outputs of the two amplifiers (fig. 8) are connected to two-channel AD7367 14-bit bipolar ADC, with $\pm 5V$ input range. The circuit has been built (fig. 9) and tested in the laboratory (fig. 10).

On-line measurements

In order to test the circuit's capabilities setup shown in figure 2 was used to generate a 6Hz sinusoidal current waveform. Both inductor current and V_{ce1} were sampled in the middle of PWM pulse. Resulting current and voltage waveforms are plotted in figure 11.

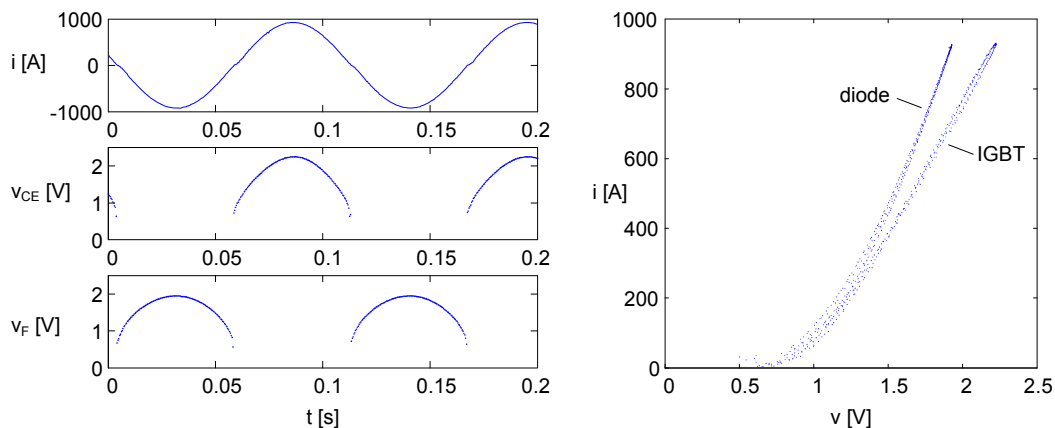

Fig. 11: (left) measured phase current and corresponding V_{ce} and V_f voltages and (right) corresponding IGBT and diode forward characteristics measured during converter operation.

In order to compare the new on-line measurement circuit to the off-line one, the setup shown in figure 2 was again used.

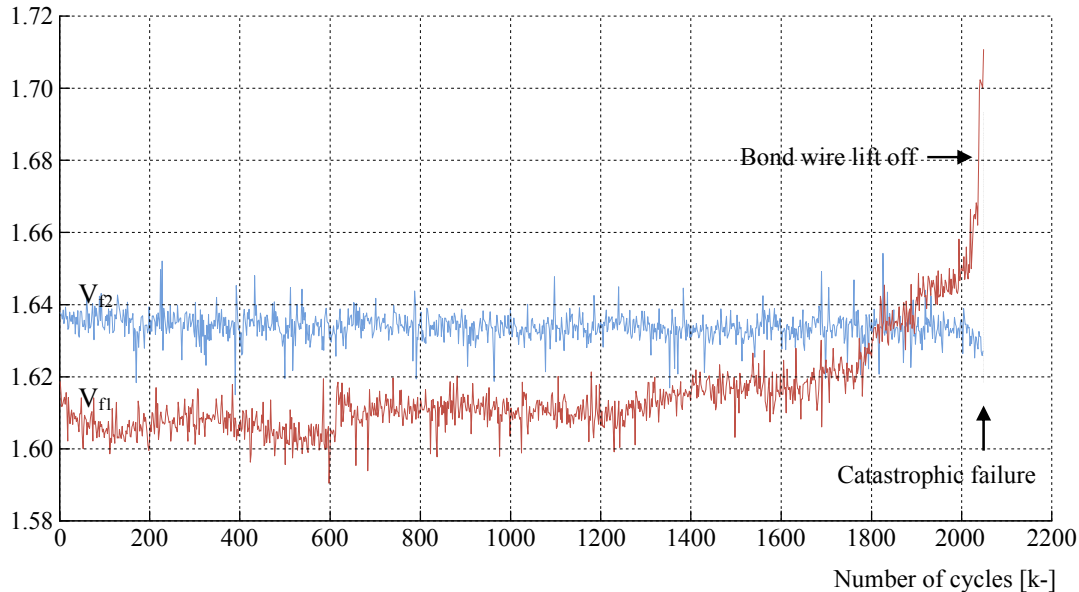

Fig. 12: Measured diode voltages V_{f1} and V_{f2} .

Recorded data (fig. 12) shows a bond wire liftoff in the top diode just before module's catastrophic failure. A step in V_{f1} after 610k cycles was caused by setup maintenance.

Conclusions

A simple measurement circuit capable of on-line V_{ce} and V_f measurement was presented. The circuit allows millivolt accuracy measurements and, at the same time, protects ADC against high voltage present at the input terminals.

The measurement circuit can be easily incorporated into current and new converter designs. Voltage information can be used to monitor the health of semiconductor devices. Additionally V_{ce} voltage can provide junction temperature information contributing to e.g. protection or control circuitry.

References

- [1] Yang, S., Bryant, A., Mawby, P., Xiang, D., Ran, Li., Tavner, P. An industry-based survey of reliability in power electronic converters. IEEE Transaction on industry application, Vol. 47, No. 3, 2011.
- [2] Ciappa, M. Selected failure mechanisms of modern power modules. Microelectronics reliability, 42(4), 653-667.
- [3] Van Bussel, G. J. W. Offshore wind energy, the reliability dilemma. In Proceedings of the International Conference (pp. 2-6).
- [4] Pedersen, K. B., Pedersen, K. Bond wire lift-off in IGBT modules due to thermomechanical induced stress. In Power Electronics for Distributed Generation Systems (PEDG), 2012 3rd IEEE International Symposium on (pp. 519-526). IEEE.
- [5] Smet, V., Forest, F., Huselstein, J.-J., Richardeau, F., Khatir, Z., Lefebvre, S., Berkani, M. Ageing and failure modes of IGBT modules in high-temperature power cycling. IEEE transaction on industrial electronics, Vol. 58, No. 10, 2011.
- [6] Hensler, A., Ltz, Josef., Zill, J., Bayerer, R. Method and test assembly for power cycling tests at inverter conditions. PCIM 2010.
- [7] Scheuermann, U., Schmidt, R. Investigations on the VCE (T)-Method to Determine the Junction Temperature by Using the Chip Itself as Sensor. Proc. PCIM09, CD-ROM. Nuremberg.
- [8] Nielsen, R. O., Due, J., Munk-Nielsen, S. Innovative measuring system for wear-out indication of high power IGBT modules. In Energy Conversion Congress and Exposition (ECCE), 2011 IEEE (pp. 1785-1790). IEEE.

- [9] Due, J., Munk-Nielsen, S., Nielsen, R. Lifetime investigation of high power IGBT modules. In Power Electronics and Applications (EPE 2011), Proceedings of the 2011-14th European Conference on (pp. 1-8). IEEE.
- [10] US5500616 desaturation protection circuit
- [11] HCPL-316J 2.5 Amp Gate Drive Optocoupler with Integrated (VCE) Desaturation Detection and Fault Status Feedback datasheet
- [12] Kim, Y. S., Sul, S. K. On-line estimation of IGBT junction temperature using on-state voltage drop. In Industry Applications Conference, 1998. Thirty-Third IAS Annual Meeting. The 1998 IEEE (Vol. 2, pp. 853-859). IEEE.
- [13] Koenig, A., Plum, T., Fidler, P., De Doncker, R.W. On-line junction temperature measurement of CoolMOS devices. In Power Electronics and Drive Systems, 2007. PEDS'07. 7th International Conference on (pp. 90-95). IEEE.
- [14] GeneSiC GBP3SHT24-89 Silicon Carbide Power Shottky Diode datasheet