

OPTIMAL DESIGN OF CAPAMAN (CASSINO PARALLEL MANIPULATOR) WITH PRESCRIBED WORKSPACE

Erika Ottaviano and Marco Ceccarelli

Laboratory of Robotics and Mechatronics
DiMSAT – University of Cassino
Via Di Biasio 43 - 03043 Cassino (Fr), Italy
e-mail: ceccarelli@ing.unicas.it

Abstract

CaPaMan (Cassino Parallel Manipulator) is a 3-Degree Of Freedom spatial parallel manipulator that has been designed at the Laboratory of Robotics and Mechatronics, in Cassino. In this paper we present a formulation for an optimum design for CaPaMan architecture when the workspace is suitably prescribed.

1. Introduction

Parallel architectures have inherent advantages for many applications with respect to serial manipulators: rigidity, accurate positioning, high velocities. Recently, spatial parallel mechanisms address great interest because they can be used for many applications in industrial and medical fields, or as machine tools.

Although the most popular parallel mechanism is a 6-Degrees Of Freedom (DOF), [1], 3-DOF parallel architectures have interested many researchers because of the simplicity and less expensive design and manufacturing. Waldron placed a 3-DOF mechanism between the wrist and the hand of a 10-DOF serial parallel manipulator, [2], Tsai analyzed in [3] a 3-DOF translational manipulator.

Obtaining high performances requires to chose suitable mechanism dimensions especially as there is much larger variation in the performances of parallel architectures according to the dimensions than for classical serial ones. Optimization methodologies have long been applied to mechanism synthesis. Indeed, with the development of manipulators for performing a wide range of tasks, the introduction of performance indices or criterion, which are used to characterize the manipulator, has become very important. A number of different optimization criterion for

manipulators may be appropriate depending on the resources and general nature of tasks to be performed. The choice of any of the criteria for a given set of data, would result into a manipulator whose performances does not necessarily match the optimum values of the other criteria. Consequently, one of the problems facing the designer is how to choose performance criteria and justify the optimality of different designs, [4]. Several performances criterion could be taken into account for design purposes, as for example workspace, singularities, stiffness, and dexterity.

Many researchers have addressed the optimization of the workspace of manipulators. In fact, it is one of the most important properties because workspace determines geometrical limits on the task that can be performed. Most of the done work is related to maximize the workspace. Gosselin and Guillot presented in [5] an algorithm for the workspace optimization of planar manipulators, where the objective is to obtain a workspace, which is as close as possible to a prescribed working area. In this case no discretization is involved because the workspace is specified through the description of its boundary. Boudreau and Gosselin used in [6] a genetic algorithm for the synthesis of planar 3-DOF parallel manipulators. The algorithm optimizes architectural parameters to obtain a workspace as close as possible to a prescribed one. Dexterity has recently emerged has a measure for manipulator kinematic performance. The condition number of the Jacobian matrix is known to be the measure of the kinematic accuracy of the manipulator. This can be thought of as the ability of the manipulator to arbitrarily change its position and orientation, or apply forces and torques in arbitrary directions. The Jacobian matrix represents the mapping of both velocities and forces between the actuators and end-effector, and thus any measure of dexterity may be expressed in terms of properties of the Jacobian matrix. Gosselin and Angeles optimized a planar 3-DOF parallel manipulator for dexterity in [7]. Moreover, a global dexterity index based on the condition number is defined in [8] to characterize the kinematic accuracy of a manipulator over its whole workspace. Staoughton and Arai designed a Stewart platform by considering the weighted sum of dexterity and workspace volume, [9].

Dynamics is related with higher precision and faster motion control of manipulators. Ma and Angeles introduced a measure of dynamic performance of manipulators, based on dynamic isotropy condition in [10].

In this paper we present a formulation for optimum design of the CaPaMan (Cassino Parallel Manipulator) architecture, a 3-DOF spatial parallel manipulator, in order to obtain designed parameters of a robot whose position workspace is suitably prescribed. A numerical example is reported to show the feasibility of the proposed formulation that could be extended for a more general design problem.

The approach is focused on workspace characteristics, particularly size and shape of the workspace of CaPaMan manipulator. An optimization of design parameters has been carried out taking into account constraints such as joint limits and link interference for a given position workspace.

2. CaPaMan Architecture

CaPaMan (Cassino Parallel Manipulator) is composed by a fixed plate FP that is connected to a movable plate MP by means of three leg mechanisms. Each of these is composed by an articulated parallelogram AP, a prismatic joint SJ and a connecting bar CB, Fig.1. CB may translate along the prismatic guide of SJ keeping its vertical posture while the BJ allows the MP to rotate in the space. Each AP plane is rotated of $\pi/3$ with respect to the neighbor one. A built prototype is shown in Fig. 2. Design parameters of a k leg mechanism ($k = 1, 2, 3$) are identified through: a_k , which is the length of the frame link; b_k , which is the length of the input crank; c_k , which is the length of the coupler link; d_k , which is the length of the follower crank; h_k , which is the length of the connecting bar. The kinematic variables are: α_k , which is the input crank angle; s_k , which is the stroke of the prismatic joint. The size of MP and FP are given by r_p and r_f , respectively, where H is the center point of MP, O is the center point of FP, H_k is the center point of the k BJ and O_k is the middle point of the frame link a_k , Fig. 1. MP is driven by the three leg mechanisms through the corresponding articulation points H_1, H_2, H_3 , so that the device is a 3 DOF spatial mechanism. In order to describe the motion of MP with respect to FP a world frame OXYZ has been assumed as fixed to FP and a moving frame $HX_pY_pZ_p$ has been fixed to MP. Particularly, OXYZ has been fixed with Z-axis orthogonal to the FP plane, X-axis as coincident with the line joining O to O_1 , and Y-axis to give a Cartesian reference frame. The moving frame $HX_pY_pZ_p$ has been fixed in an analogous way to the movable plate MP with Z_p orthogonal to the MP plane, X_p axis as coincident to the line joining H to H_1 and Y_p to give a Cartesian frame.

In this paper we have approached the problem with design parameters as $a_k = c_k$, $b_k = d_k$, h_k , s_{kmin} , s_{kmax} , α_{kmin} and α_{kmax} for three legs and r_p for the MP of CaPaMan when the size and shape of workspace are suitably prescribed.

3. Workspace Volume

It is well known that parallel manipulators have a rather limited and complex workspace. At the same time, the size and shape of the workspace can be considered as the main design criterion.

Discretization algorithms are usually used to determine manipulator workspace. They consist in discretizing the 3-dimensional space, solving the Inverse Kinematics for each point, and verifying the constraints that limit the workspace. Such discretization algorithms are used by most of researchers and can be applied to any type of architecture. They clearly require big amount of disk space for storing computed data. An optimization method for a 3-DOF translational parallel platform

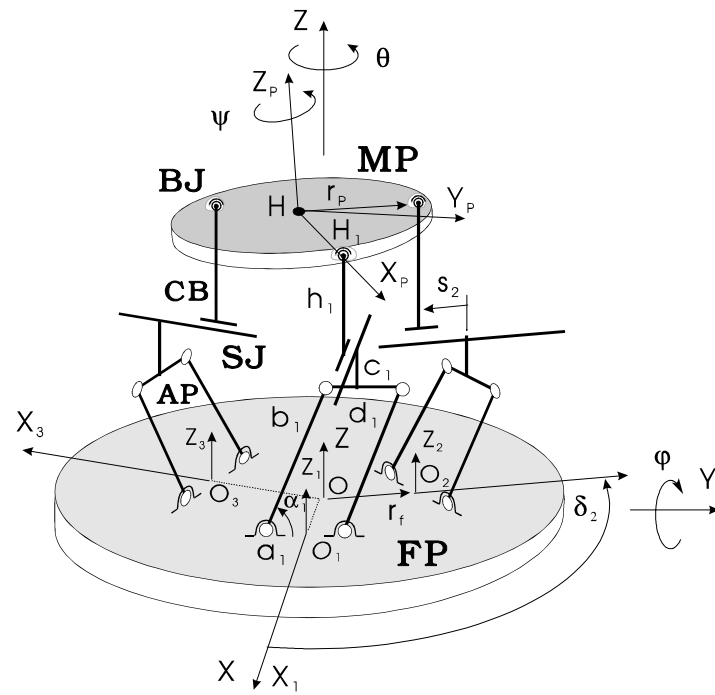

Fig. 1 Kinematic chain and design parameters of CaPaMan (Cassino Parallel Manipulator).

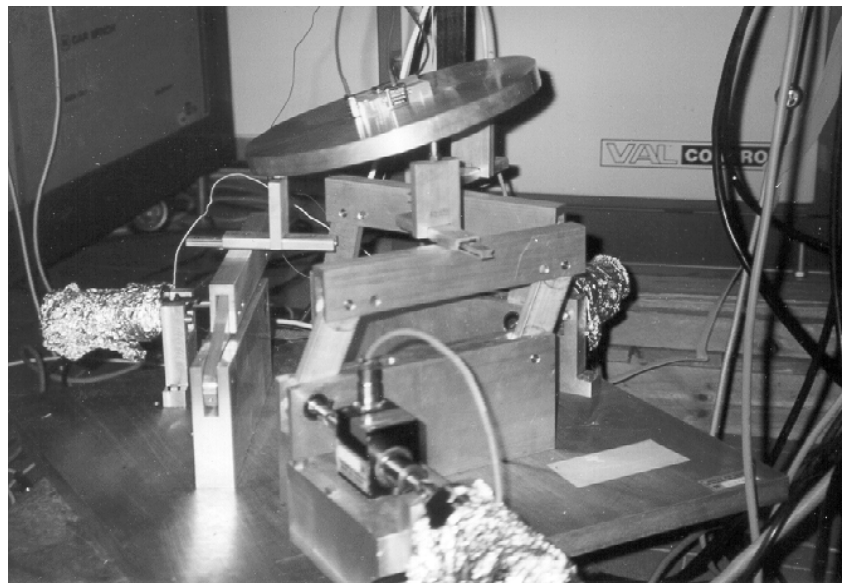

Fig. 2 A built prototype of CaPaMan at the Laboratory of Robotics and Mechatronics in Cassino.

based on maximum total volume of the manipulator workspace, which has been numerically approximated by using Monte Carlo method has been studied in [11].

Geometric methods, on the other hand, are fast and accurate. This kind of approach was introduced by Gosselin in [12]. Later Merlet extended geometric approach by including limited ranges, passive joints and link interference, [13].

Like all parallel kinematic mechanisms, the workspace of CaPaMan has a complex volume shape. For analysis purposes the workspace volume can be approximated by the largest parallelepiped V^* containing CaPaMan workspace. It is possible to point out that also largest sphere can be used, a more detailed description of the workspace will be described in future works. This work illustrates only the usage of the workspace module required for design optimization. Thus, the design problem is to find the size of design parameters such that the workspace volume V^* , which is a numerical approximation of the real volume, is as close as possible to a prescribed volume V' , as shown in Fig. 3.

Particularly, the complexity of workspace evaluation has been simplified by using a parallelepiped that contains the thin umbrella shaped workspace volume. The CaPaMan workspace volume can be numerically approximated by considering a parallelepiped workspace volume V^* , which can be evaluated as

$$V^* = \Delta x \Delta y \Delta z \quad (1)$$

where

$$\begin{aligned} \Delta x &= x_{\max} - x_{\min} \\ \Delta y &= y_{\max} - y_{\min} \\ \Delta z &= z_{\max} - z_{\min} \end{aligned} \quad (2)$$

in which x_{\max} and x_{\min} are the maximum and the minimum reaches along X-axis; and so on. Each one of the extreme reaches in Eq. (2) can be evaluated by considering the position analysis in order to obtain the position workspace. The position analysis for workspace determination can be carried out by using the expressions, [14; 15]

$$\begin{aligned} x &= \frac{y_3 - y_2}{\sqrt{3}} - \frac{r_p}{2} (1 - \sin \phi) \cos(\psi - \theta) \\ y &= y_1 - r_p (\sin \psi \cos \theta + \cos \psi \sin \phi \sin \theta) \\ z &= \frac{z_1 + z_2 + z_3}{3} \end{aligned} \quad (3)$$

where

$$\begin{aligned}
\psi &= \tan^{-1} \left[\sqrt{3} \frac{z_3 - z_2}{2z_1 - z_2 - z_3} \right] \\
\theta &= \sin^{-1} \left[2 \frac{y_1 + y_2 + y_3}{3r_p(1 + \sin \phi)} \right] - \psi \\
\phi &= \cos^{-1} \left[\pm \frac{2}{3r_p} \sqrt{z_1^2 + z_2^2 + z_3^2 - z_1z_2 - z_2z_3 - z_1z_3} \right] \quad (z \geq z_1 \Rightarrow +; z < z_1 \Rightarrow -)
\end{aligned} \tag{4}$$

when the input motion for the legs $k=1,2,3$ gives

$$\begin{aligned}
y_k &= b_k \cos \alpha_k \\
z_k &= b_k \sin \alpha_k + h_k
\end{aligned} \tag{5}$$

The limits on the sliding joint affect mainly the lower and internal part of the workspace yet. In particular it has been possible to observe that the mechanical limits s_{kmax} of the prismatic joint greatly affect the shape of the workspace. As it decreases the workspace assumes parallelepiped shape. As it increases it assumes the characteristic shape of an umbrella, Fig.3.

4. A Formulation for an Optimum Design

Optimization of manipulator workspace volume is dependent upon of determining the workspace of a parallel manipulator for a set of design variables and it is often based on a discretization of the workspace of the manipulator.

In this section a design procedure for the CaPaMan architecture has been formulated such that its workspace volume is as close as possible to the prescribed one.

We assume $r_p = r_f$, $a_k = c_k$, $b_k = d_k$, so that fixed and movable plates have the same dimensions, and links of the APs have the same dimensions, in order to ensure the characteristic CaPaMan design.

The design value $r_f = r_p$ has also been assumed to avoid prismatic joints with too large values of the strokes s_k . The size of the prismatic guides can be conveniently designed through s_{kmax} .

The link length a_k can be conveniently determined by taking into account the condition that can express avoidance of link interference among APs. The crank link can intersect the follower of neighbor AP when is aligned with the frame link. The symmetric design of CaPaMan gives an equilateral triangle whose sides are the

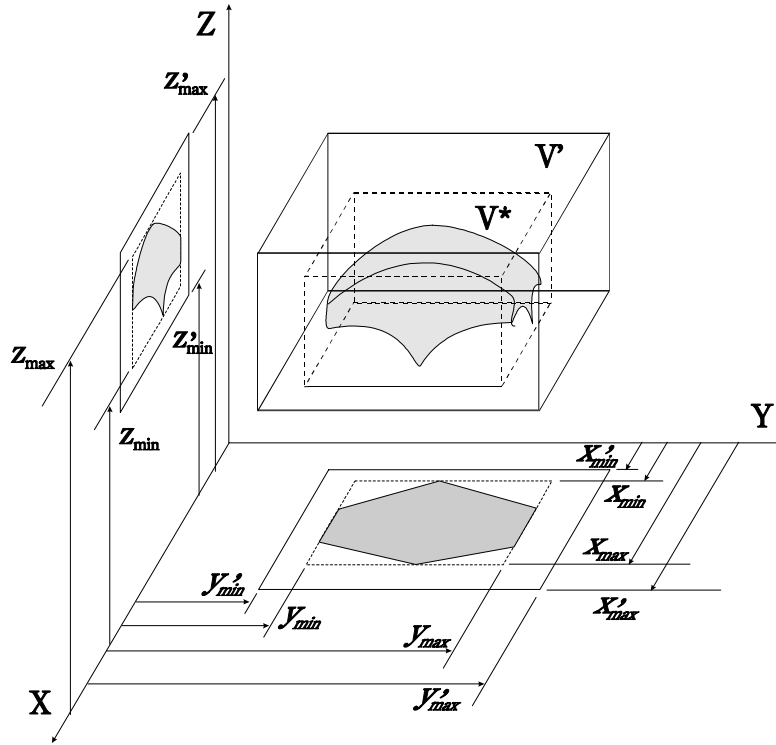

Fig. 3 The proposed numerical approximation for the workspace volume of CaPaMan.

distance ($a_k + b_k + d_k$). The collision avoidance is ensured when $3r_p$ is greater than the corresponding height of the above-mentioned triangle in case of collision avoidance. This can be expressed as, [16],

$$a_k < 2 (\sqrt{3}r_p - b_k) \quad (6)$$

in order to avoid interference between links during the motion since the tilting angle for MP is limited by the size of APs. In addition we assume $s_{kmin} = s_{kmax}$ equal to the value s_{max} in order to design symmetric prismatic guides. Consequently the architecture of CaPaMan can be defined by the design parameters a_k , b_k , h_k , α_{kmin} , α_{kmax} , s_{max} .

Designing a manipulator for a specific task means that the manipulation must be performed inside a prescribed volume. Thus, the design problem is to find the size of an architecture such that the workspace volume is as close as possible to a prescribed volume V' .

The optimum design problem can be formulated as

$$\min(L) = \min(a_k^2 + b_k^2 + h_k^2 + s_{k\max}^2 + r_p^2) \quad (7)$$

in which L can be considered the size measure of the manipulator whose dimension is desirable to be at a minimum value. In fact, the objective function in Eq.(7) prescribes that the synthesized CaPaMan architecture will give the minimum value of L . In addition, one can prescribe that the workspace volume of synthesized CaPaMan architecture will be included in a parallelepiped volume V^* , Fig. 3, which is the best approximation to the given parallelepiped volume V' . In order to complete the design characterization and use prescribed data, as shown in Fig.3, the optimization problem is also subject to the constraints

$$\begin{aligned} x_{\max} &\leq x'_{\max} \\ y_{\max} &\leq y'_{\max} \\ z_{\max} &\leq z'_{\max} \end{aligned} \quad (8)$$

where the left hand values correspond to the workspace volume V^* and the prime values describe the prescribed parallelepiped V' . Similarly, constraint equations are considered for minimum reaches x_{\min} , y_{\min} and z_{\min} .

In addition, some practical constraints can be included in order to obtain feasible practical solutions for design parameters like for example

$$a_m \leq a_k \leq a_M \quad (9)$$

where a_m and a_M are minimum and maximum values for dimension a_k . Similarly we can prescribe suitable range for the size of AP links, joint stroke, s_{\max} and swinging limits, $\alpha_{k\min}$ and $\alpha_{k\max}$ of the input joint.

The optimum design for CaPaMan architecture has been formulated by Eqs. (7) to (9) by taking into account only workspace characteristics to give the smallest manipulator fitting the prescribed workspace. In addition, the formulation of Eqs. (1) to (5) for workspace evaluation is useful and computationally efficient.

5. Numerical Example and Discussion

The optimum design problem has been defined by Eqs. (7) to (9) and it is highly

non-linear. The design process is iterative and time consuming in order to give a solution that can be not unique and indeed can be a local minimum. A critical issue for proposed optimum design procedure seems to be the choice of a proper initial guess solution. For the proposed numerical example we have chosen an architecture near to the current architecture of the CaPaMan prototype as initial guess solution with volume $V_0 = 194220 \text{ mm}^3$ evaluated by using Eqs. (1) and (5). We have also chosen a prescribed parallelepiped V' whose dimensions are $100 \times 100 \times 60 \text{ mm}^3$. The initial parallelepiped workspace has approximately the same size of the prescribed one with the aim of checking alternative solutions to values of the design parameters for the built prototype of CaPaMan. The constr optimization algorithm of the Matlab Optimization Toolbox, [17], has been used to solve optimal parameter values.

Figure 4 shows the workspace of the optimum designed CaPaMan and Table 1 gives the dimensions of the synthesized architecture.

Figure 5 shows the evolution of the objective function of Eq. (7) and workspace volume during the design process that takes less than 100 iterations to converge to an optimum design; and Figs. 6 and 7 give the evolution of design parameters. The numerical process has converged to the optimum solution through step by step

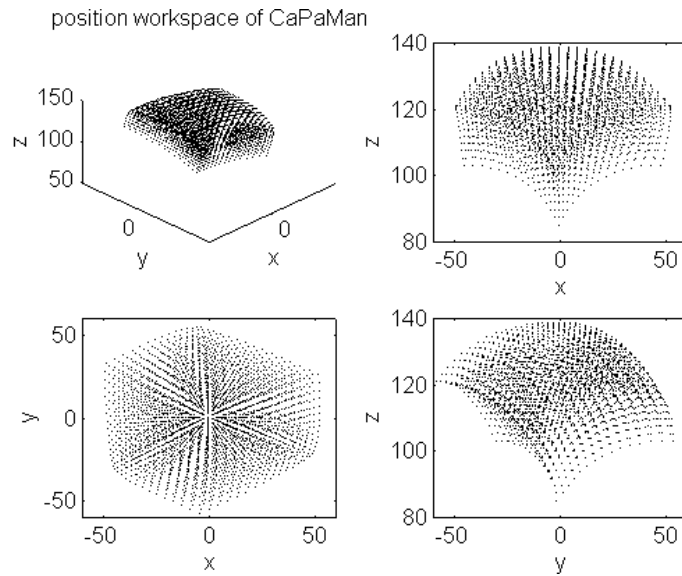

Fig. 4 The position workspace of the optimum designed CaPaMan architecture.

Table 1 Sizes of design parameters of the optimum design for CaPaMan, Fig 5.

$a_k = c_k$ (mm)	$b_k = d_k$ (mm)	h_k (mm)	$r_p = r_f$ (mm)	α_k (deg)	s_k (mm)
100.74	87.78	50.73	79.76	87 ; 162	50.00

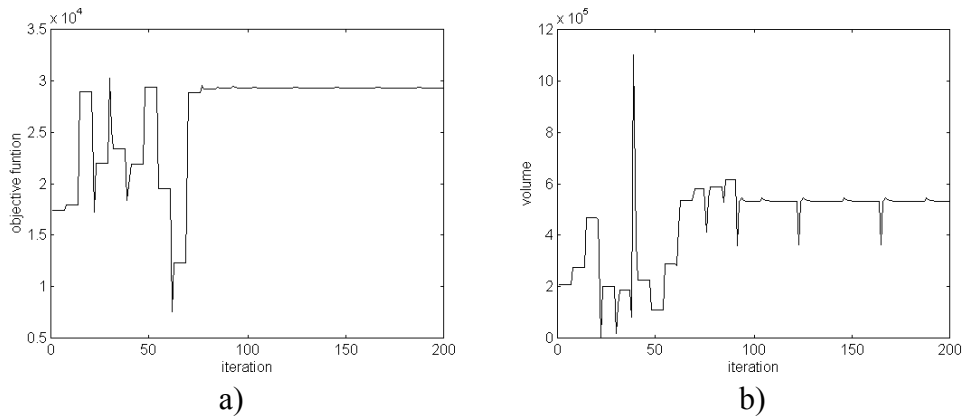

Fig. 5 Evolution versus number of iterations of a) the objective function; b) workspace volume.

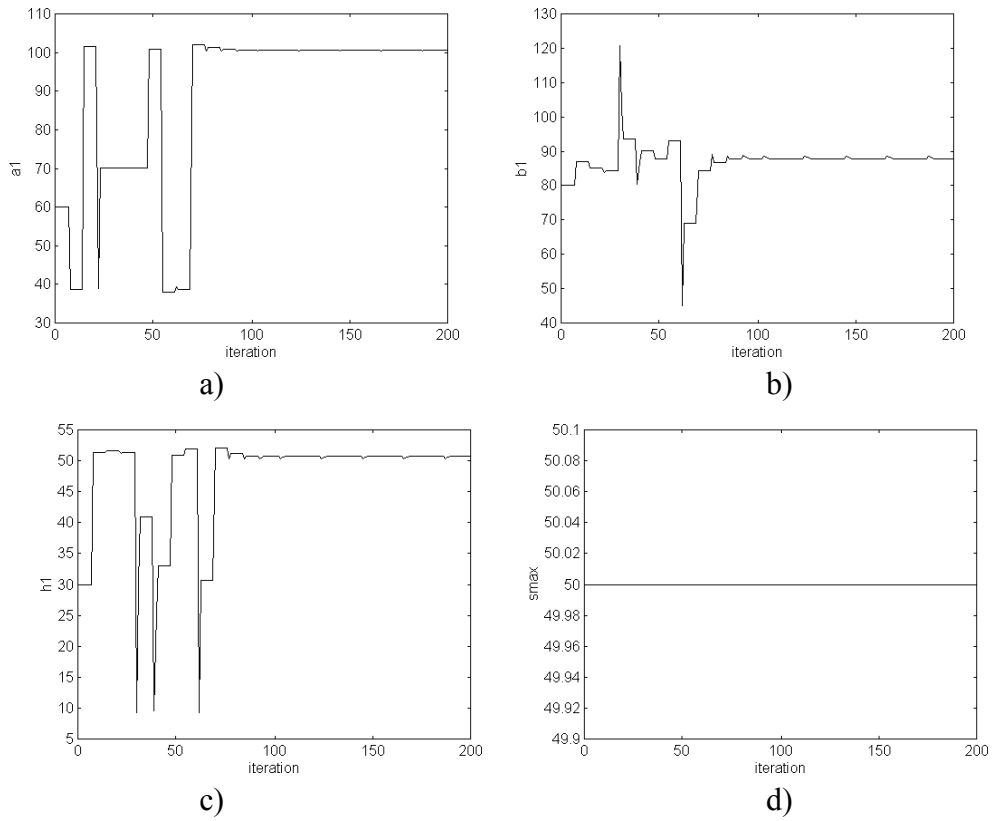

Fig. 6 Evolution of design parameters for the case of Fig.5: a) link length a_1 ; b) link length b_1 ; c) link length h_1 ; d) stroke s_{max} . (lengths are expressed in mm)

improvements that are due to the numerical procedure which updates the variables all together after a cycle of attempting optimization for one variable at each iteration.

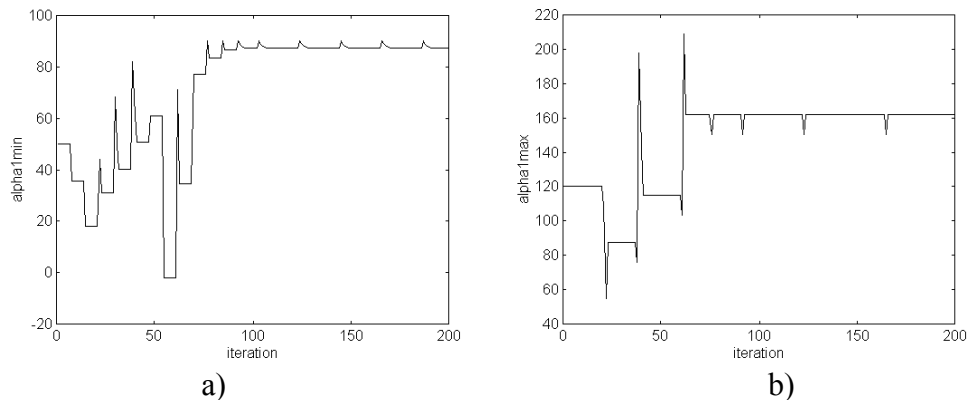

Fig. 7 Evolution of design parameters for the case of Fig.5: a) input angle α_{1min} ; b) input angle α_{1max} . (angles are expressed in deg)

5. Conclusions

In this paper we have proposed a formulation for optimum design of parallel manipulators, specifying the procedure for CaPaMan architecture. The design procedure is based on position workspace characteristics. The complexity of workspace evaluation has been simplified by using an approximate parallelepiped that contains the thin umbrella shaped workspace volume.

Using a numerical procedure based on a commercial software package has successfully solved the formulated optimization problem by taking advantage of the efficient computation of position workspace through a suitable formulation. A numerical example has been reported to show the soundness and engineering feasibility of the proposed procedure for optimum designing of CaPaMan architecture.

References

- [1] Stewart, D. 1965. A Platform with Six Degrees of Freedom. Proceedings of the Institute of Mechanical Engineering. London. Vol.180. pp.371-386.
- [2] Waldron, K. J., Raghavan, M., Roth, B. 1989. Kinematics of a Hybrid Series-Parallel Manipulation System. Journal of Dynamic Systems, Measurement, and Control. Vol.111. pp. 211-221.
- [3] Tsai, L.-W., Stamper, R. 1996. A Parallel Manipulator with Only Translational Degrees of Freedom. Proceedings of the ASME Design Engineering Technical Conference and Computers and Information in Engineering Conference. Irvine. Paper DETC2000/MECH-1152.
- [4] Tsai, K., Y., Huang, K., D. 2000. The Design Considerations of Manipulators. Proceedings of the ASME Design Engineering Technical Conference and Computers and Information in Engineering Conference. Baltimore. Paper

DETC2000/MECH-14089.

- [5] Gosselin C. M., Guillot M., 1991. The Synthesis of Manipulators with Prescribed Workspace. *Journal of Mechanical Design*. Vol.113. pp.451-455.
- [6] Boudreau, R., Gosselin, C. M. 1998. The Synthesis of Planar Parallel Manipulators with a Genetic Algorithm. *Proceedings of the ASME Design Engineering Technical Conference and Computers and Information in Engineering Conference*. Atlanta. Paper DETC2000/MECH-5957.
- [7] Gosselin, C., Angeles, J. 1988. The Optimum Kinematic Design of a Planar Three-Degree-of-Freedom Parallel Manipulator. *Journal of Mechanisms, Transmissions, and Automation in Design*. Vol.110. pp.35-41.
- [8] Gosselin, C., Angeles, J. 1991. A Global Performance Index for the Kinematic Optimization of Robotic Manipulators. *Journal of Mechanical Design*. Vol.113. pp.220-226.
- [9] Stoughton, R. S., Arai, T. 1993. A Modified Stewart Platform Manipulator with Improved Dexterity. *IEEE Transaction on Robotics and Automation*. Vol.9. No.2. pp.166-173.
- [10] Ma, O., Angeles, J. 1993. Optimum Design of Manipulators Under Dynamic Isotropy Conditions. *Proceedings of the IEEE International Conference on Robotics and Automation*. Atlanta. Vol.1. pp.470-475.
- [11] Stamper, R. E., Tsai, L.-W., Walsh, G. C. 1997. Optimization of a Three DOF Translational Platform for Well-Conditioned Workspace. *Technical Research Report*.
http://www.isr.umd.edu:80/TechReports/ISR/1997/TR_97-71/TR_97-71.phtml.
- [12] Gosselin, C., M., 1990. Determination of the Workspace of 6-DOF Parallel Manipulators. *ASME Journal of Mechanical Design*. Vol.112. September. pp.167-176.
- [13] Merlet, J.-P. 1994. Designing a Parallel Manipulator for a Specific Workspace. *The International Journal of Robotics Research*. Vol.16. No.4. pp.545-556.
- [14] Ceccarelli, M. 1997. A New 3 dof Spatial Parallel Mechanism. *Mechanism and Machine Theory*. Vol. 32. No.8. pp. 895-902.
- [15] Ceccarelli, M., Figliolini, G. 1997. Mechanical Characteristics of CaPaMan (Cassino Parallel Manipulator). *Proceedings of 3rd Asian Conference on Robotics and its Application*. Tokyo. pp.301-308.
- [16] Ceccarelli, M. Ottaviano, E. 2000. An Analytical Design for CaPaMan with Prescribed Position and Orientation. *Proceedings of the ASME Design Engineering Technical Conference and Computers and Information in Engineering Conference*. Baltimore. Paper DETC2000/MECH-14099.
- [17] The Math Works. 1995. *Matlab Optimization Toolbox*.