



Optimal Placement and Size of Distributed Generators Based on Autoadd and PSO to Improve Voltage Profile and Minimize Power Losses

Mustafa R. Nasser ^{a*}, Inaam I. Ali ^b, Mohammed H. Alkhafaji ^c

^a Electrical Engineering Department, University of Technology, Baghdad, Iraq.
316210@student.uotechnology.edu.iq

^b Electrical Engineering Department, University of Technology, Baghdad, Iraq.
Inaam.i.ali@uotechnology.edu.iq

^c Electrical Engineering Department, University of Technology, Baghdad, Iraq. 30072@uotechnology.edu.iq

*Corresponding author.

Submitted: 31/07/2020

Accepted: 22/10/2020

Published: 25/03/2021

KEY WORDS

Loss minimization,
optimal placement,
Autoadd, PSO, DG
integration

ABSTRACT

This work aims to improve the voltage profile and reduce electrical network losses through optimal planning of distributed generators. A new search algorithm (Autoadd) along with the (PSO) are introduced to choose the best location and size for distributed generators. Two systems are implemented; a 33-bus test network and a 30-bus of a local community in the city of Al- Diwanayah. At the power flow, a solution is implemented using a fixed-point iteration method within an OpenDSS environment to check the performance of both networks. Moreover, the optimal location and size of the distributed generators are determined using Autoadd and PSO methods. The Autoadd method is implemented within the OpenDSS environment, while the (PSO) method is implemented within the MATLAB-OpenDSS environment through the com-interface. The validity and effectiveness of the proposed methods are validated by comparison with the published researches. The results have proven that the fixed-point method has achieved high efficiency and accuracy in terms of analyzing the power flow, whereas the (Autoadd) algorithm has achieved a better effect in terms of improving the voltage profile and minimizing losses.

How to cite this article: M. R. Nasser, I. I. Ali and M. H. Alkhafaji, "Optimal Placement and Size of Distributed Generators Based on Autoadd and PSO to Improve Voltage Profile and Minimize Power Losses," Engineering and Technology Journal, Vol. 39, Part A, No. 03, pp. 453-464, 2021.

DOI: <https://doi.org/10.30684/etj.v39i3A.1781>

1. INTRODUCTION

The distribution systems suffer from high voltage drops, high power loss, and low voltage stability, in addition to the constantly increasing demand [1, 2]. At present, these issues have led to increasing interest in the distributed generators in the generation and transportation sectors [3]. Distributed Generators (DGs) are gaining importance in the energy market because of their high reliability and efficiency and as a promising way to reduce stress on transmission and distribution lines [4]. Integrating distributed generators within traditional networks makes the power flow bi-directionally within the network. Therefore, DGs have to be integrated after extensive planning to avoid adverse impacts in the networks [5]. The common and most used way to reduce losses and to improve voltage profile is to determine the optimal location and size of DGs over the network [6].

Some literature concerns the optimal layout of distributed generators as follows. Ullah et al. have suggested an analytical approach determine the optimum location and size of distributed generators using (PSO) and (PPSO) method to reduce losses and improve the voltage profile [7]. Montoya et al. have proposed a general algebraic modeling system (GAMS) with a BONMIN solver in which the problem was diagnosed as a mixed-integer nonlinear programming (MINLP) to define the optimal location and size of DGs [3]. Essallah et al. have presented a new method for optimal planning of DGs where researchers used the Voltage -Stability Margin- Index (VSMI) method to determine the optimum location and determine the size by MATLAB –curve- fitting –approximation [8]. Magadum and Kulkarni have proposed the fuzzy logic method to determine the optimal location and size of DGs [9]. Researches [6 and 10], have proposed the genetic algorithm for the optimal planning of DGs. Davda and Parekh studied the effect of incorporation of DGs on the distribution network. Their methodology was developed in CYMDIST to limit the optimal location and size of DGs [11].

This work focuses on analyzing the power flow based on a fixed-point iteration method within an OpenDSS environment and on reducing power losses. It improves the voltage profile in the distribution network based on the selection of the optimal location and size of DGs through the application of AutoAdd and PSO strategies. PSO algorithm implements through the OpenDSS program within the MATLAB environment. While the Autoadd algorithm applied directly to the standalone OpenDSS program. Figure 1 shows the structure of the presented workflow.

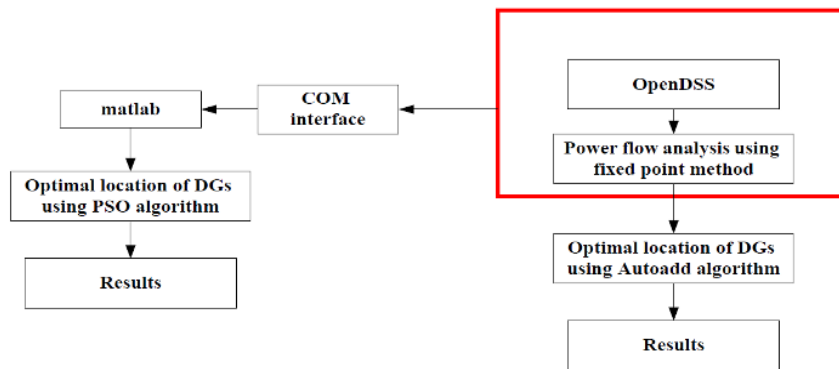

Figure 1: The structure of the presented workflow

2. PROPOSED METHODOLOGY

I. Power Flow Method

The fixed-point iteration algorithm is the standard solution method in OpenDSS software. This algorithm solves the power flow to the distribution networks iteratively by constructing a nodal admittance matrix [12]. This algorithm differs from the traditional methods used to solve the energy flow, such as Newton Raphson and Gauss Seidal because it does not use the energy data that is directly injected into the system. Where it creates (admittance matrix) for the elements of the power distribution system. Power conversion elements (generators and loads) are designed as Norton's equivalents with a constant admittance matrix (Y_{prim}) and a compensation current I_{comp} (inj) to compensate the nonlinear part, as shown in Figure 2.

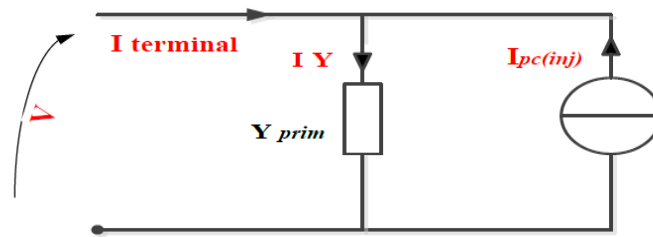

Figure 2: Power conversion element (PC) model [13]

The algorithm of energy flow analysis is described as follows [13, 14]:

- 1) Before starting the power flow algorithm, OpenDSS finds the system's nodal admittance matrix. Then remove all the power conversion (PC) elements from the network. Calculate the node voltages initial (V_0) value for iterations with the system admittance (Y_{system}) in this form, as shown in Eq. (1):

$$V_{a..n}^0 = [Y_{system}]^{-1} \times I_{source} \tag{1}$$

- 2) Add all the (PC) elements to the system. Calculate the compensation (injection) current ($I_{comp, inj}$) of each (PC) element with its (Y_{system}), node voltages, and power. From Figure 2, the compensation current (I_{comp}) is the difference between the current drawn by the nonlinear power conversion element and the linear portion of the element, if any that is embedded in the Y_{system} matrix, as shown in Eq. (2):

$$I_{comp, inj}^k = I_y^k - I_{terminal}^k \tag{2}$$

- 3) Use the ($I_{comp, inj}$) from each (PC) element to form a compensation current matrix. Node voltages can be calculated with the compensation current matrix and the (Y_{system}) matrix through matrix operations, as shown in Eq. (3):

$$\begin{bmatrix} V_a^k \\ \vdots \\ V_n^k \end{bmatrix} = [Y_{system}]^{-1} \times \begin{bmatrix} I_{source} \\ \vdots \\ I_{comp, inj}^k \end{bmatrix} \tag{3}$$

- 4) Convergence test, keep repeating until the node effort error occurs in the tolerance, as shown in Eq. (4):

$$error_{a..n}^k = \frac{V_{a..n}^k - V_{a..n}^{k-1}}{V_{source}} \tag{4}$$

Where(I_{source}): source current, (k): number of iteration, (V_{source}): source voltage, ($V_{a..n}$): node voltage, ($I_{terminal}$): terminal current (from the network), I_y^k : current drawn by the nonlinear power conversion element, $I_{pc, comp, inj}(V)$ = compensation, or injection, currents from Power Conversion (PC) elements in the circuit, which may be nonlinear elements, $n=1,2,...3$: number of iteration. Figure 3 shows a summary of the working steps of the algorithm

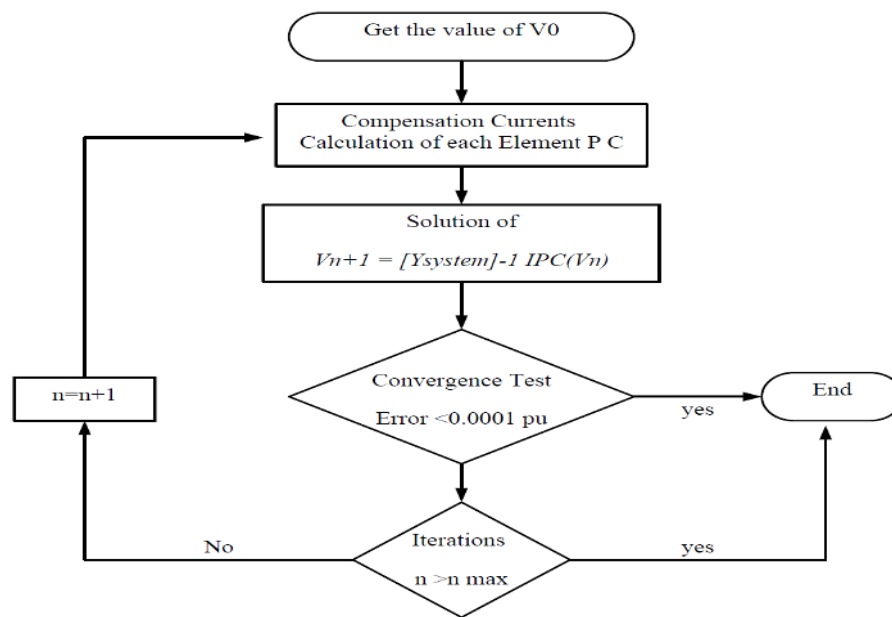

Figure 3: Flowchart of the fixed-point iterative solution algorithm

II. Autoadd optimization algorithm

In this work, a new search algorithm (Autoadd) is used for the optimal layout of distributed generators. Autoadd is an internal automatic feature of OpenDSS for optimizing the location of generators and capacitors [12]. The problem of optimization of distribution system analysis as equation (5) [15].

$$\text{Min } f(x, u) = P_L \quad (5)$$

$$\text{Subject - to } g(x, u) = 0$$

$$0.95 \leq V_i \leq 1.05$$

Where $g(x, u) = 0$ is the equation of the distribution power flow. V_i is the voltage on the bus (i th). Equation (5) specifies the amount of active and reactive injection power per node to reduce system losses base on the fixed-point method. Then, the data is automatically recorded in the Autoadd mode by the energy meter object of the OpenDSS software. This feature benefits from direct access to the injected currents (I (comp, inj)) equations (2 and 3) quickly without rebuilding (Ysystem) for each test location [13, 14]. In order to transfer the generators from one bus to another, the program searches each available bus for a location that gives the greatest per unit improvement in a combination of losses and capacity on the Eq. (6):

$$\text{Minimize } (\text{loss weight} * \text{losses} + \text{UE weight} * \text{UE}) \quad (6)$$

Where loss weight: Weighting factor for Losses in AutoAdd functions, UE weight: weighting factor for Unserved Energy (UE)/ Energy Exceeding Normal (EEN)

UE refers to load energy considered unserved because the power (actually the current) exceeds Emergency, or maximum, ratings. EEN refers to load energy considered unserved because the current or voltage exceeds normal ratings.

Also, in this algorithm, the convergence velocity of the solution increases (6 seconds) because the admittance matrix of the system does not change. Usually, the solution to find the location of each generator takes (2-4) iterations (in each solution) and the results are shown as a percentage factor per bus. The percentage improvement factor shows the next best location to supply powers [15].

Figure 4 shows the Autoadd optimization algorithm to reduce losses.

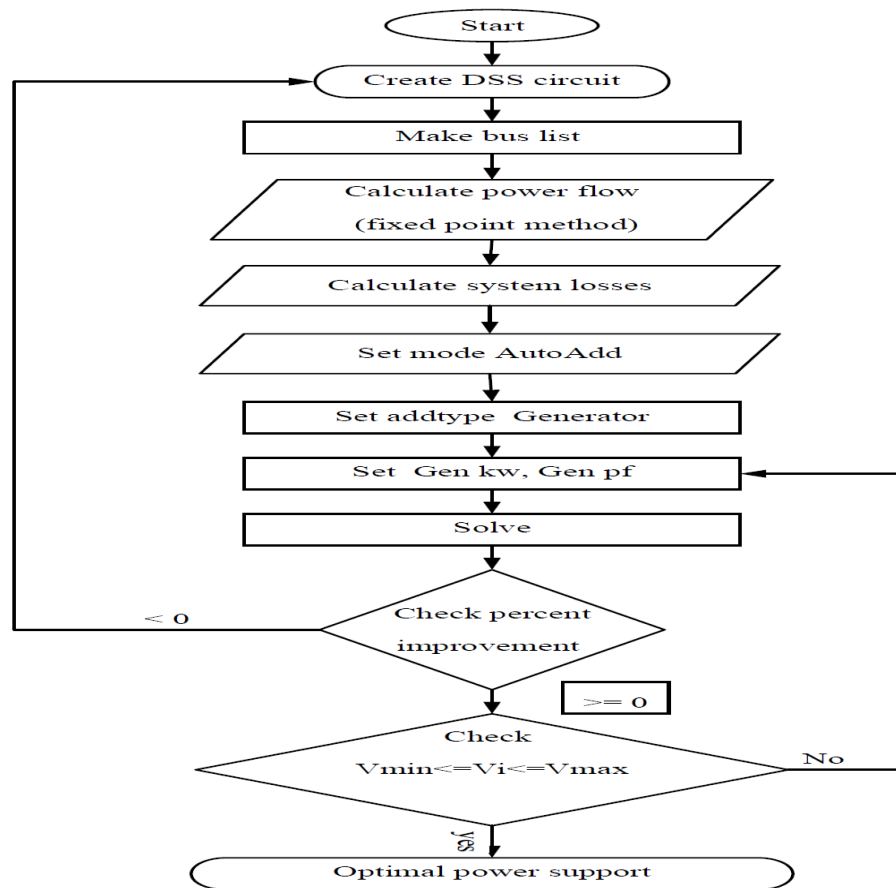

Figure 4: Optimization Using AutoAdd

III. Particle swarm optimization algorithm

PSO technology is used to determine the best solution to the multi-objective problem of the location and size of distributed generators. PSO is an evolutionary mathematical technology. This technology was developed by simulating simplified social models.

(The idea of the algorithm is based on the kinetic and social behavior of swarms (birds and fish) through the idea of searching for food. The flock of birds searches for food from one place to another. Information is transmitted between them during the search for the best place for food. In addition, when you explore the flock of birds about a good place for the quality of food, it uses this place to get the best food. Thus, the algorithm works in two processes, the search process and the Repetition process, based on the best solutions within the specified search space [17].

This algorithm consists of particles (swarm population) that move within the specified search area. The algorithm is configured randomly from the number of particles. These particles depend on the speed and position of the particle, as it is updated based on the previous cases of the best position of the particle and its symbol ($Pbest$) and on the best position of the particles in the entire swarm and symbolizes it ($Gbest$) as shown in Figure 5. Particle position and velocity are expressed by: $X_i = (xi1, xi2, \dots, Xid)^T$, $V_i = (vi1, vi2, \dots, Vid)^T$, respectively where $i = 1, 2, \dots, n$, and d is the size of the population. According to the dimensions of the problem, the position and velocity of the particles are adjusted until the termination conditions are met. This modification can be explained by the concept of velocity, where the velocity of each particle is modified by the following Eq. (7) and Eq. (8) [18-20]:

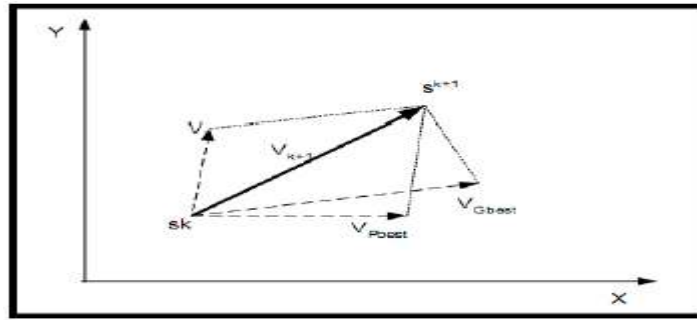

Figure 5: The concept of the search process in PSO

$$V_{i,d}^{k+1} = w V_{i,d}^k + c1 \cdot rand_1^k \cdot (pbest_{i,d}^k - X_{i,d}^k) + c2 \cdot rand_2^k \cdot (gbest_{i,d}^k - X_{i,d}^k) \quad (7)$$

$$X_{i,d}^{k+1} = X_{i,d}^k + V_{i,d}^{k+1} \quad (8)$$

$$i = 1, 2, 3, \dots n, \quad d = 1, 2, \dots m.$$

Where, $V_{i,d}^k$ and $V_{i,d}^{k+1}$ are current particle velocity and modified search points. $X_{i,d}^k$ and $X_{i,d}^{k+1}$ are Current particle position and adjusted search points. $c1$ and $c2$ are constant acceleration coefficients. $rand_1^k$ and $rand_2^k$ are random numbers, which are distributed according to the regular distribution within a period (0,1), $VPbest$ and $VGbest$ are velocity based on $Pbest$ $Gbest$ respectively, (n) and (m) are a number of the particles in a group and members in a particle respectively. To improve the performance and efficiency of the algorithm, the weight of inertia is added to the particle velocity update Eq. (7) and denoted by w , as shown in Eq. (9).

$$W_i = W_{max} - \left(\frac{W_{max} - W_{min}}{k_{max}} \right) \times k \quad (9)$$

Where W is the weight of inertia, k_{max} and k are the maximum and current iteration, W_{max} and W_{min} are the maximum and minimum weights, respectively. The flowchart of the particle swarm optimization is shown in Figure 6.

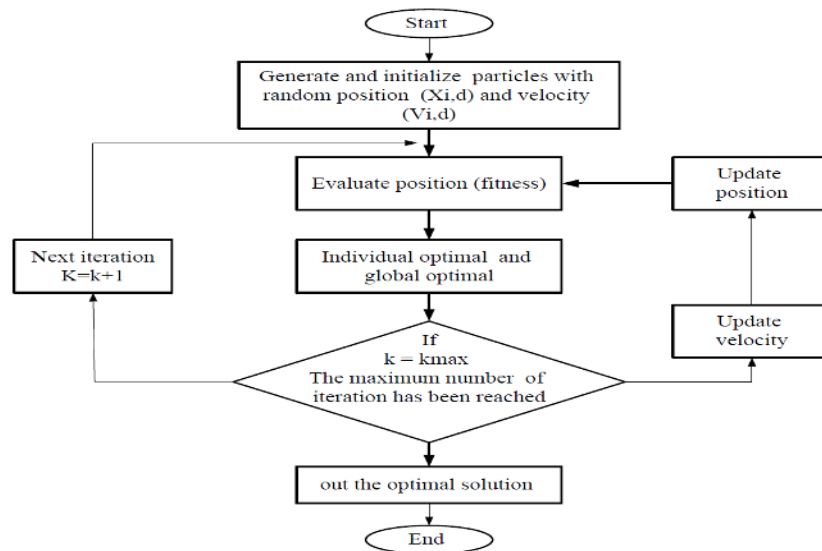

Figure 6: Flowchart of PSO

3. ANALYSIS AND RESULTS

I. Test system

The single-line IEEE 33-bus radial distribution system illustrated in Figure 7 is chosen. System configuration is dependent on an operating voltage of 100 MVA, 12.66 kVA (L-L), and 60 Hz. Load and impedance data is provided at [9]. The total real and interactive power loads on the system are 3715 kW and 2300 kV.

Voltage levels and load currents were calculated using the fixed-point repeat method. A summary of the energy flow obtained is given in Figure 8 and Table I. The results were identical to the results obtained by the proposed methods [21-23].

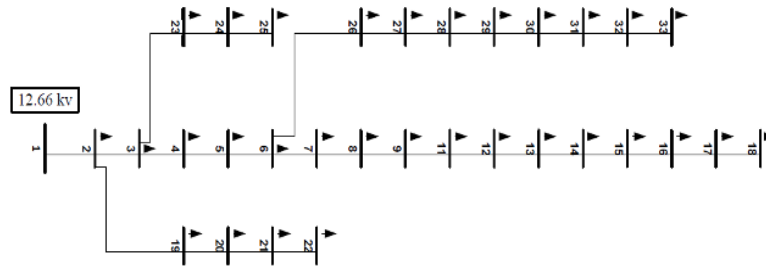

Figure 7: IEEE 33bus test distribution system

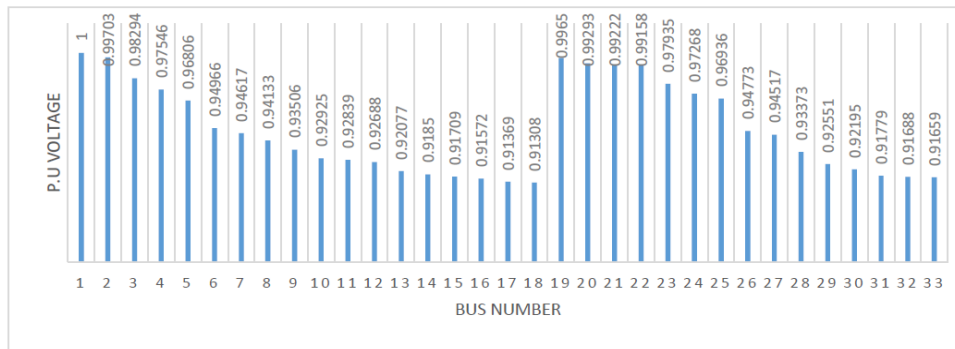

Figure 8: P.U bus voltage of IEEE 33-test system

TABLE I: Summary report of energy flow for the IEEE 33 bus test system using a fixed-point algorithm compared with other algorithms

Algorithms	Total load		Power losses kW	Minimum voltage on the feeder (p.u.)	Location of minimum voltage
	kW	kV Ar			
33-bus	3715	230	202.66	0.91308	Bus 18
Proposed algorithm		0			
33-bus Artificial Bee Colony Algorithm [21]	3715	230	202.71	0.9131	Bus 18
33-bus PGSA [22]	3715	230	202.71	0.9131	Bus 18
33-bus backward/forward sweep (CYMDIST) [23]	3715	230	202.71	0.913	Bus 18

Table II indicates a list of solutions presented by researchers in [3, 24-26] to choose three distributed generators in terms of the best location, size, and ratio to improve losses on the 33-bus system.

The results presented in Table II demonstrate the efficiency and effectiveness of the proposed algorithms and their superiority over the published methods.

TABLE II: Comparing the power flow analysis after adding 3 DGs using (Autoadd) and (PSO) method, and comparing it with other methods

Method	P loss, DG (kW)	Min voltage	DG location	DG size (MW)	Power factor (PF)
GA [24]	106.3	0.9809	11, 29, 30	1.5, 0.4228, 1.0714	1
PSO [24]	105.35	0.9806	13, 32, 8	0.9816, 0.8297, 1.1768	1
REPSO[25]	76.91	0.9694	6, 14, 31	1.2274, 0.6068, 0.6870	1
GAMS[3]	72.79	0.968	14, 24, 30	0.7709, 1.0969, 1.0658	1
Proposed AutoAdd	71.4	0.9693	14, 24, 30	0.7305, 1.0852, 1.1009	1
BSA [26]	21.3178	0.9918	30, 24, 13	1.2, 1, 0.782	0.85
Proposed AutoAdd	16.7	0.9924	30, 11, 24	1.190, 0.990, 0.802	0.85
Proposed PSO	19.2	0.9799	9, 30, 24	1.071, 0.9095, 0.9605	0.85

Figure 9 and Table III show the results of the network analysis after adding 3DGs with pf=0.85. The voltage profile was significantly improved for all bus bars, and losses are minimized in both methods. Through the results, it could be noted that the method (Autoadd) outperformed over (PSO) in terms of improving the voltage profile and loss reduction; the reason is that the improved voltage and the reduction of losses depend on the location and the optimum size of the distributed generators.

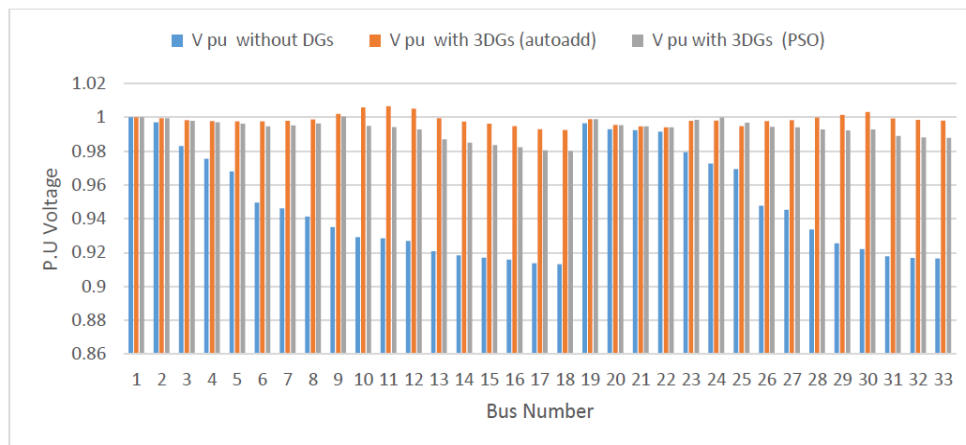
**Figure 9: P.U bus voltage before and after adding 3DGs by PSO and Autoadd****TABLE III: P.U bus voltage and losses before and after adding 3DGs by Autoadd and PSO**

Without DGs		With 3DGs			
		Autoadd		PSO	
Losses kW	Min voltage (bus)	Losses kW	Min voltage (bus)	Losses kW	Min voltage (bus)
202.66	0.91308 (18)	16.7	0.9924 (18)	19.2	(18)

II. Case study: Practical network

One feeder is selected from the Al-jamiaa distribution network in AL-Diwaniya city, 11 kV 6.63 MW, which consists of 31 buses Figure 10 shows the one-line diagram of the distribution system under consideration. The system data are given in Appendix A. The voltage limits are defined as $V_{min} = 0.95$ p.u and $V_{max} = 1.05$ p.u. Three different loads are considered in this study 100, 80, and 60%.

The energy flow of the real network is analyzed by the proposed method and the results of the analysis appeared as shown in Table IV.

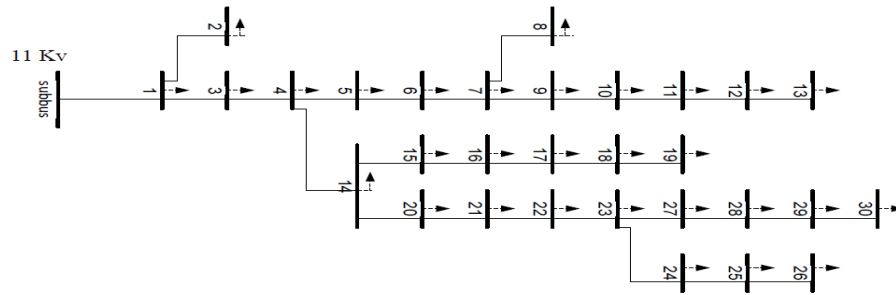

Figure 10: Feeder of Al-jamiaia distribution network

TABLE IV: Result of power flow of the Al-jamiaia distribution network for three loads.

% load	Total load (kW)	kW loss	Min voltage (bus)
100 % load	6630	306.2	0.9392 (30)
80 % load	5304	191.1	0.95201 (30)
60 % load	3978	105	0.96445 (30)

After analyzing the energy flow, it was proposed to add three distributed generators to improve the voltage profile and reduce losses. The optimum location and size of the distributed generators were determined by the proposed methods (Autoadd) and (PSO) as shown in Table V.

TABLE V: The optimal location and size of 3DGs extracted by the proposed methods

DG	AutoAdd			PSO		
	DG size (MW)	Location of DG	PF	DG size (MW)	Location of DG	PF
Diesel engine 1	1.2	28	0.85	1.2	20	0.85
Diesel engine 2	1	11	0.85	1	28	0.85
Diesel engine 3	0.8	18	0.85	0.8	6	0.85
Total generation	3 MW			3 MW		

After adding the distributed generators, the voltage profile for all bus bars of the Al-jamiaia distribution network has been improved for three variable loads, as shown in Figures 11-13. In addition, system losses decreased significantly due to the presence of distributed generators at ideal locations near the load. Therefore, the stress on the lines was reduced, and consequently, the losses were reduced in both methods. The results showed the superiority of the (Autoadd) method in terms of improving the voltage shape and reducing losses in all cases, as shown in Table VI.

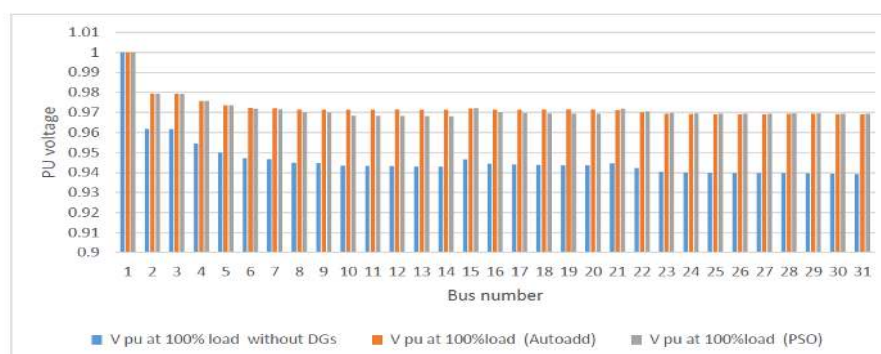

Figure 11: Voltage profile for all buses at 100 % load

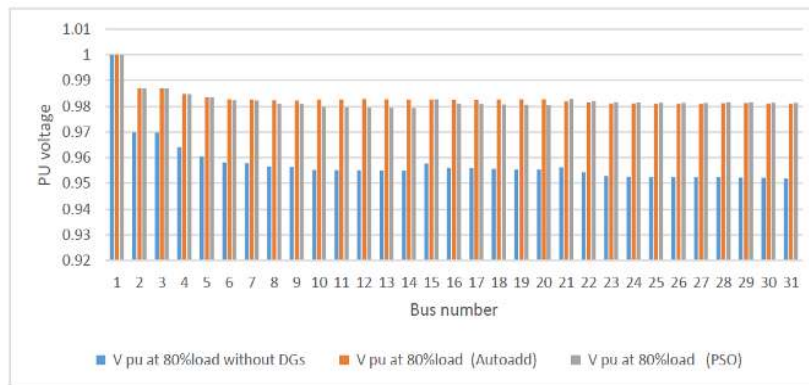

Figure 12: Voltage profile for all buses at 80 % load

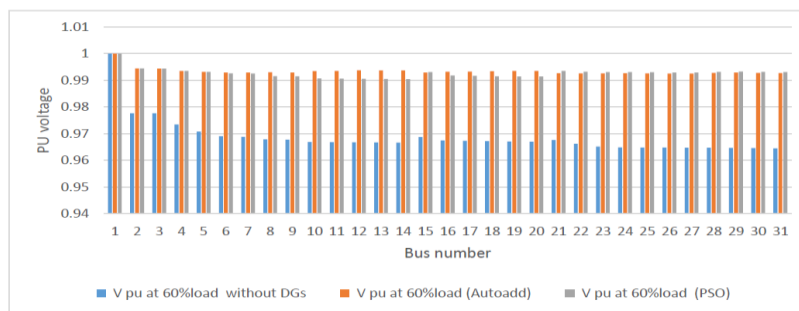

Figure 13: Voltage profile for all buses at 60 % load

TABLE VI: Results of losses and minimum voltage of the proposed method (Autoadd) and (PSO) of the Al-jamiaa distribution network for three loads

% load	Without DGs		Autoadd		PSO	
	<i>kW loss</i>	<i>Min voltage (bus)</i>	<i>kW loss with DGs</i>	<i>Min voltage (bus)</i>	<i>kW loss with DGs</i>	<i>Min voltage (bus)</i>
100 %	306.2	0.93921 (30)	82.1	0.96895 (26)	87.3	0.96805 (13)
80 %	191.1	0.95201 (30)	31.9	0.98088 (26)	35.3	0.97938 (13)
60 %	105	0.96445 (30)	5.9	0.99252 (26)	7.8	0.99045 (13)

4. CONCLUSIONS

The aim of this work is to reduce losses and to improve voltage profile in the distribution networks. The fixed-point iteration method is used to analyze the power flow within OpenDSS because of its efficiency, accuracy, and speed. OpenDSS is considered an important program because it supports the analysis of integrated distributed generators; it specializes in the fields of microgrids and it supports many features of models of microgrids. A new search algorithm (Autoadd) was introduced along with the (PSO). The proposed methods determine the optimum location for distributed generators and their size with minimal losses. These algorithms have been applied to (IEEE 33-bus test system) and realistic network (for three variable loads) and validating their validity and effectiveness by comparing their results with each other as well as with published results.

The proposed AutoAdd method proved its superiority and speed in determining the optimal location for (DGs) with minimal losses. This method is one of the easiest methods and is highly efficient compared to other algorithms. This method is a feature of OpenDSS for locating generators as well as capacitors and it is able to handle all sizes of distribution systems. Consequently, losses were reduced to a minimum due to the presence of distributed generators in the best location, size, and near loads.

Appendix A

TABLE A-I: The line and load data for the Al_Jamia distribution network

section No.	From Bus	To Bus	Load (kW)	load (KVAr)	R (Ω)	X (Ω)
1	Sub bus	1	212.5	131.7	0.3681	0.4493
2	1	2	212.5	131.7	0.02375	0.02899
3	1	3	340	210.7	0.07481	0.09131
4	3	4	212.5	131.7	0.04987	0.060879
5	4	5	212.5	131.7	0.09618	0.1174
6	5	6	212.5	131.7	0.0178	0.0217
7	6	7	212.5	131.7	0.0712	0.0869
8	7	8	212.5	131.7	0.0356	0.0434
9	7	9	212.5	131.7	0.0973	0.1188
10	9	10	340	210.7	0.00855	0.0104
11	10	11	212.5	131.7	0.0174	0.0211
12	11	12	212.5	131.7	0.024	0.029
13	12	13	85	52.67	0.0308	0.0376
14	4	14	212.5	131.7	0.0594	0.0724
15	14	15	212.5	131.7	0.1306	0.159
16	15	16	212.5	131.7	0.0183	0.0223
17	16	17	212.5	131.7	0.0235	0.0287
18	17	18	212.5	131.7	0.0214	0.0261
19	18	19	212.5	131.7	0.01544	0.0188
20	14	20	340	210.7	0.0475	0.05798
21	20	21	212.5	131.7	0.0736	0.089
22	21	22	212.5	131.7	0.0594	0.0724
23	22	23	212.5	131.7	0.0178	0.0217
24	23	24	212.5	131.7	0.0214	0.0261
25	24	25	212.5	131.7	0.01116	0.0136
26	25	26	85	52.67	0.0157	0.0191
27	23	27	212.5	131.7	0.0174	0.0211
28	27	28	212.5	131.7	0.00878	0.0107
29	28	29	212.5	131.7	0.022	0.027
30	29	30	340	210.7	0.0285	0.0347

References

- [1] P. K. Kaushal and M. Tomar, "Real and reactive power loss minimization of IEEE-33 bus by optimal DG placement using LSO in RDS," in 2017 International Conference on Energy, Communication, Data Analytics and Soft Computing (ICECDS), 2017.
- [2] P. Prakash and D. K. Khatod, "Optimal sizing and siting techniques for distributed generation in distribution systems: A review," *Renew. Sustain. energy Rev.*, vol. 57, pp. 111–130, 2016.
- [3] O. D. Montoya, W. Gil-González, and L. F. Grisales-Noreña, "An exact MINLP model for optimal location and sizing of DGs in distribution networks: A general algebraic modeling system approach," *Ain Shams Eng. J.*, vol. 11, no. 2, pp. 409–418, 2020.
- [4] H. R. Galiveeti, A. K. Goswami, and N. B. D. Choudhury, "Impact of plug-in electric vehicles and distributed generation on reliability of distribution systems," *Eng. Sci. Technol. an Int. J.*, vol. 21, no. 1, pp. 50–59, 2018.
- [5] L. F. Grisales and B. J. Restrepo Cuestas, "Location and sizing of distributed generation: A review," *Cienc. e Ing. Neogranadina*, vol. 27, no. 2, pp. 157–176, 2017.
- [6] F. U. Din, A. Ahmad, H. Ullah, A. Khan, T. Umer, and S. Wan, "Efficient sizing and placement of distributed generators in cyber-Physical power systems," *J. Syst. Archit.*, vol. 97, pp. 197–207, 2019.

- [7] Z. Ullah, S. Wang, and J. Radosavljević, "A novel method based on PPSO for optimal placement and sizing of distributed generation," *IEEJ Trans. Electr. Electron. Eng.*, vol. 14, no. 12, pp. 1754–1763, 2019.
- [8] S. Essallah, A. Khedher, and A. Bouallegue, "Integration of distributed generation in electrical grid: Optimal placement and sizing under different load conditions," *Comput. Electr. Eng.*, vol. 79, p. 106461, 2019.
- [9] R. B. Magadum and D. B. Kulkarni, "Optimal Placement and Sizing of Multiple Distributed Generators using Fuzzy Logic," *5th Int. Conf. Electr. Energy Syst. ICEES 2019*, no. February, pp. 1–6, 2019.
- [10] S. Das, D. Das, and A. Patra, "Operation of distribution network with optimal placement and sizing of dispatchable DGs and shunt capacitors," *Renew. Sustain. Energy Rev.*, vol. 113, no. September 2017, p. 109219, 2019.
- [11] A. T. Davda and B. R. Parekh, "System impact analysis of renewable distributed generation on an existing radial distribution network," in *2012 IEEE Electrical Power and Energy Conference*, 2012.
- [12] R. C. Dugan and T. E. McDermott, "An open source platform for collaborating on smart grid research," *IEEE Power Energy Soc. Gen. Meet.*, no. Ivvc, pp. 1–7, 2011.
- [13] R. C. Dugan, "Institute, EPR OpenDSS Manual," <https://sourceforge.net/projects/electricdss>. Train. Mater., pp. 1–184, 2019.
- [14] C. Wang et al., "Analysis on the impact of DG on distribution network reconfiguration," *Tianjin Daxue Xuebao (Ziran Kexue yu Gongcheng Jishu Ban)/Journal Tianjin Univ. Sci. Technol.*, vol. 47, no. 3, pp. 189–194, 2014.
- [15] S. Singh, D. Shukla, and S. P. Singh, "Peak demand reduction in distribution network with smart grid-enabled CVR," in *2016 IEEE Innovative Smart Grid Technologies-Asia (ISGT-Asia)*, 2016.
- [16] R. C. Dugan and D. Montenegro, "The open distribution system simulator (OpenDSS): Reference guide," *Electr. Power Res. Inst.*, 2019.
- [17] D. P. Rini, S. M. Shamsuddin, and S. S. Yuhani, "Particle swarm optimization: technique, system and challenges," *Int. J. Comput. Appl.*, vol. 14, no. 1, pp. 19–26, 2011.
- [18] R. H. Al-Rubayi and M. B. Eese, "Optimal Location and Parameter Setting of STATCOM Device Based PSO for Iraqi Grid Voltage Profile Enhancement and Power Losses Minimizing," *Eng. Technol. J.*, vol. 37, no. January, pp. 60–69, 2019.
- [19] V. V. S. N. Murty and A. Kumar, "Impact of D-STATCOM in distribution systems with load growth on stability margin enhancement and energy savings using PSO and GAMS," *Int. Trans. Electr. Energy Syst.*, vol. 28, no. 11, pp. 1–24, 2018.
- [20] H. Wu, X. Liu, and M. Ding, "Dynamic economic dispatch of a microgrid: Mathematical models and solution algorithm," *Int. J. Electr. Power Energy Syst.*, vol. 63, pp. 336–346, 2014.
- [21] R. S. Rao, S. V. L. Narasimham, and M. Ramalingaraju, "Optimization of distribution network configuration for loss reduction using artificial bee colony algorithm," *Int. J. Electr. Power Energy Syst. Eng.*, vol. 1, no. 2, pp. 116–122, 2008.
- [22] A. K. Sarma and K. M. Rafi, "Optimal selection of capacitors for radial distribution systems using plant growth simulation algorithm," *Int. J. Adv. Sci. Technol.*, vol. 30, no. 5, pp. 43–54, 2011.
- [23] T. M. Abdul-Wahhab and O. A. Abdullah, "Simulation and Contingency Analysis of a Distributed Network in Iraq," *M. Sc. Thesis, University of Technology*, September, 2015.
- [24] A. Mohamed and M. Kowsalya, "Optimal size and siting of multiple distributed generators in distribution system using bacterial foraging optimization," *Swarm Evol. Comput.*, vol. 15, pp. 58–65, 2014.
- [25] J. J. Jamian, M. W. Mustafa, and H. Mokhlis, "Optimal multiple distributed generation output through rank evolutionary particle swarm optimization," *Neurocomputing*, vol. 152, pp. 190–198, 2015.
- [26] D. S. K. Kanth, N. S. R. Reddy, and R. S. G. Reddy, "Optimal placement & sizing of DG's using backtracking search algorithm in IEEE 33-bus distribution system," in *2017 International Conference On Computing Methodologies And Communication (ICCMC)*, 2017.