



GLOBAL JOURNAL OF RESEARCHES IN ENGINEERING: A  
MECHANICAL AND MECHANICS ENGINEERING  
Volume 16 Issue 3 Version 1.0 Year 2016  
Type: Double Blind Peer Reviewed International Research Journal  
Publisher: Global Journals Inc. (USA)  
Online ISSN: 2249-4596 Print ISSN: 0975-5861

# Optimization of Diesel Engine Parameters for Performance, Combustion and Emission Parameters using Taguchi and Grey Relational Analysis

By M, Shailaja & A V Sitarama Raju  
*Jawaharlal Nehru Technological University Hyderabad*

**Abstract-** Design and operating parameters of diesel engine were optimized in the present work with respect to performance, combustion and emission parameters. The goal is to reduce brake specific fuel consumption (BSFC), exhaust gas temperature (EGT), ignition delay (ID), emissions (CO, NO<sub>x</sub>, HC) and to increase peak pressure (PP), brake thermal efficiency (BTHE), heat release (HR) simultaneously with least number of experimental runs. The objective was accomplished through experimental investigations, design of experiments, Taguchi method and Grey Relational Analysis. Four parameters viz. injection timing (IJT), injection pressure (IP), compression ratio (CR) and load were varied at four levels and the (nine) responses were recorded. Taguchi approach was applied to individual response and observed that optimal factor settings for various responses are different.

**Keywords:** diesel engine, performance parameters, combustion parameters, emission parameters, taguchi approach, signal to noise ratio, grey relational approach.

**GJRE-A Classification :** FOR Code: 290501p



*Strictly as per the compliance and regulations of:*



© 2016. M, Shailaja & A V Sitarama Raju. This is a research/review paper, distributed under the terms of the Creative Commons Attribution-Noncommercial 3.0 Unported License (<http://creativecommons.org/licenses/by-nc/3.0/>), permitting all non commercial use, distribution, and reproduction in any medium, provided the original work is properly cited.

# Optimization of Diesel Engine Parameters for Performance, Combustion and Emission Parameters using Taguchi and Grey Relational Analysis

M, Shailaja <sup>α</sup> & A V Sitarama Raju <sup>σ</sup>

**Abstract-** Design and operating parameters of diesel engine were optimized in the present work with respect to performance, combustion and emission parameters. The goal is to reduce brake specific fuel consumption (BSFC), exhaust gas temperature (EGT), ignition delay (ID), emissions (CO, NO<sub>x</sub>, HC) and to increase peak pressure (PP), brake thermal efficiency (BTHE), heat release (HR) simultaneously with least number of experimental runs. The objective was accomplished through experimental investigations, design of experiments, Taguchi method and Grey Relational Analysis. Four parameters viz. injection timing (IJT), injection pressure (IP), compression ratio (CR) and load were varied at four levels and the (nine) responses were recorded. Taguchi approach was applied to individual response and observed that optimal factor settings for various responses are different. Grey relational approach (by assigning weighting factor for each response) was applied to solve multi objective optimization problem. The optimal combination of factors was obtained as injection timing 28° bTDC, injection pressure 180 bar, compression ratio 19 and load 80% full load and load was observed to be most influential factor among the four with a contribution of 70.37%. The model developed was validated by confirmation test and found good agreement between predicted and experimental values of responses.

**Keywords:** diesel engine, performance parameters, combustion parameters, emission parameters, taguchi approach, signal to noise ratio, grey relational approach.

## I. INTRODUCTION

There is a huge demand for diesel engines in industrial, agricultural and automotive sector. The advantages of diesel engines over gasoline engines are fuel economy, high thermal efficiency, low CO<sub>2</sub> emissions, ruggedness, flexibility to operate at higher compression ratio and so on. However, faster depletion of fossil fuels and environment pollution demand the engine designers to take control over fuel economy and emissions. Much research has been carried out to tackle these problems. Various investigators attempted to optimize engine design and/or operating parameters with respect to

*Author α:* Department of Mechanical Engineering, JNTUH College of Engineering Jagtial, JNT University Hyderabad, Telangana State, India. e-mail: shailajavijay@jntuh.ac.in

*Author σ:* Department of Mechanical Engineering, JNTUH College of Engineering Hyderabad, JNT University Hyderabad, Telangana State, India. e-mail: avsr\_rajuraju2005@jntuh.ac.in

performance, combustion and emission parameters to control fuel economy or emissions. Diverse numerical and statistical techniques are available for optimization; however, some offer single objective optimization and some other multi objective. The benefit of multi objective or multivariate optimization over single objective optimization is that influence of factors on multiple responses can be assessed and studied.

### a) Design of experiments

Most processes depend on some controllable factors. Similarly, performance, combustion process and emissions of a diesel engine, depends on design parameters like injection timing, injection pressure, compression ratio, engine size, type of combustion chamber and operating parameters such as load, intake temperature and pressure of air, speed, air-fuel ratio etc. To realize the effect of control factors on responses like; performance, combustion and emission parameters, a series of experiments are to be run. Experiments are to be well designed for generating more significant information within fewer runs to evaluate the important effects, rather than employing unplanned experiments. Design of Experiments (DOE) offer systematic investigation of the control factors that influence the responses. Common methods in DOE are hit and miss, one factor at a time, full factorial, fractional factorial etc. Fractional factorial method has advantage of less number of experiments without loss of much information and adopted in the present work. The four phases involved in DOE are planning, screening or process characterization, optimization and verification. Planning includes defining the problem and objective, followed by development of experimental plan which provides all significant information. Screening or process characterization comprises of selection of factors which are really important, or the vital few. Various methods are available for screening but most widely used is fractional factorial method. In fractional factorial method, only a selected subset or fraction of runs in the full factorial design is performed. Optimization is the phase where best or optimal values of control factors are determined by various techniques available. Verification is the phase in which optimal factor values after

prediction are tested for confirmation of results. In planning phase, factors, levels and responses are chosen and orthogonal arrays are formed, which were originally developed by Sir R.A. Fisher and later added by Taguchi. Experiments are conducted based on orthogonal arrays and analysed based on Signal to Noise Ratio (SNR). Signal to Noise Ratio (SNR) measures the variation of response relative to nominal or target value. Two types of SNR used in the present work; smaller the better and larger the better.

When the response is to be minimized, 'smaller the better' SNR is appropriate and is computed using the Eq. 1 while 'larger the Better' SNR is apt for the maximizing response applying the Eq. 2.

$$SNR_S = -10 \log \frac{1}{n} \left\{ \sum_{i=1}^n y_i^2 \right\} \quad (1)$$

$$SNR_L = -10 \log \frac{1}{n} \left\{ \sum_{i=1}^n \left( \frac{1}{y_i^2} \right) \right\} \quad (2)$$

Where  $y_i$  is the response from  $i^{\text{th}}$  experiment and  $i=1, 2 \dots n$ . After SNRs are evaluated, main effect plot for SNRs are drawn to find optimal values of the factors. ANOVA is performed to explore and model relationship between responses and factors and relative percentage contribution of factors on response.

Numerous studies have been carried out to study the effect of IJT, IP, CR and load of the engine on performance, combustion and emission parameters [1-5]. For better performance, the engine should be operated at a set of optimal design and operating parameters. Optimization with the help of orthogonal arrays was proposed by Taguchi [6] in which optimum set of factors is determined for each response with the help of (Signal to Noise Ratio) SNR. Taguchi method has been applied successfully for numerous problems in various fields of science and technology. Diesel engine parameters are not an exception for it. A brief review of research carried is following.

T. Ganapathy et al.[7] used Taguchi method to optimize ten operating and design variables of diesel engine for maximum brake thermal efficiency, peak pressure, temperature, IMEP, BMEP and reported improvement in above said parameters at optimal condition obtained by Taguchi approach. Horng-Wen Wu et al. [8] reported that Taguchi method is good to find optimal operating parameters for high brake thermal efficiency and low BSFC,  $\text{NO}_x$  and smoke. Kaliamoorthy.S et al.[9] employed Taguchi method to optimize power, static injection timing, fuel fraction and compression ratio for best values of brake power, fuel economy and emissions and reported that confirmation tests showed good agreement with predicted values of parameters. Karthikeyan. R et al. [10] from their work

concluded that Taguchi method of optimization efficiently predicted optimum level of parameters and found satisfactory results at optimum setting. The inference from the work of Vincent H. Wilson et al.[ 11] confirmed that Taguchi method is efficient in predicting range of optimum settings of valve opening pressure, piston to head clearance volume, static injection timing, area of the spray nozzle hole and load for best values of  $\text{NO}_x$  emissions and brake specific fuel consumption.

Even though Taguchi method proved as one of the best methods for optimization, its major limitation is inability to tackle multi objective optimization. This drawback is trounced by application of grey relation analysis and Taguchi method collectively. Grey relational analysis, proposed by Deng in 1982, which is commonly used for assessing the degree of correlation between sequences by grey relational grade. In this analysis, responses are normalized (between zeros to one) which is known as grey relational generation. Grey relational coefficient is calculated using normalized data of responses. Grey relational coefficients of all the responses is averaged to get overall grey relational grade. The calculation of grey relational grade converts multi variant optimization problem into single response optimization, overall grey relational grade being objective function. By maximizing the overall grey relational grade the optimal parametric combination is evaluated. Some research work is also reported regarding use of grey relational analysis in conjunction with Taguchi method.

The results of research done by Ashish Karnwal et al.[12] emphasized that Taguchi method coupled with grey relational analysis can be used successfully for exploration of multiple-performance variables of diesel engine. In their work, biodiesel blend, compression ratio, opening pressure of nozzle and injection timing are optimized for best values of brake thermal efficiency, brake specific energy consumption and exhaust gas temperature of diesel engine. In a study carried out by Sumit Roy et al. [13] optimization of CNG energy share and fuel injection pressure for lowest values of BSFC,  $\text{NO}_x$  and HC done successfully.

Goutam Pohit et al.[14] reported effective optimization of biodiesel blend, compression ratio and load for better values of performance and emission parameters by grey relational analysis and supported by confirmatory experiments. Optimization of speed of the engine, load and type of fuel for better values of performance and emissions was prolifically done by M. I. Masood et al. [15] by means of grey Taguchi method and confirmatory test by artificial neural networks showed best validation. Taguchi method along with grey relational analysis and ANOVA was able to identify the order of significance/ contribution of each of the parameters (injector opening pressure, fuel injection timing and compression ratio) on BTHE, BSFC and emissions, further they reported that confirmation test

results were in good agreement with predicted values [16]. Similar results were also reported by some other investigators [17, 18,].

*b) Motivation and Objectives*

As per available literature, most of the research work pertaining to diesel engine parameters was concentrated on either of performance or emission parameters or both. However, so far no work was reported on optimization for parameters of combustion like peak pressure, ignition delay, and heat release together with performance and emission parameters. Hence, objective of present work is to spot out optimal values of design and operating parameters of diesel engine, which would maximize brake thermal efficiency, peak pressure, and heat release and to minimize BSFC, exhaust gas temperature, ignition delay and emissions simultaneously.

In the present work Taguchi method and grey relational analysis are used for optimization. Taguchi analysis results shows order of factors influencing particular response in the form of ranks. Hence, ANOVA (Analysis of variance) is used to find the percentage contributions of IJT, IP, CR and load on response parameters.

**II. MATERIALS AND METHODS**

*a) Experimental setup*

Experiments were carried out on a 4-s single-cylinder, water cooled direct injection, variable compression ratio diesel engine. The specifications of the engine are presented in Table1.and layout of engine in Fig. 1.

*Table 1 :* Specifications of Engine.

Engine Type	Kirloskar
Number of cylinders	Single(01)
Combustion	Direct injection
Bore	80 mm
Stroke	110 mm
Compression Ratio	Variable (15-20)
Rated Speed	1500 rpm
Power	5 hp
Type of cooling	Water cooling
Fuel injector opening pressure	200 bar
Fuel injection timing	22° before TDC
Type of loading	Electrical loading

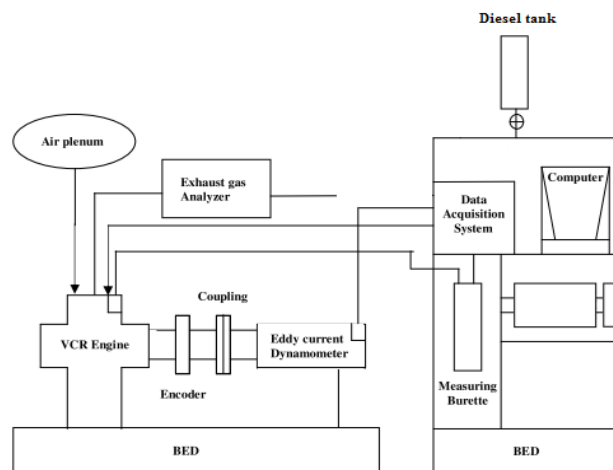

*Fig. 1 :* Engine setup

The engine is attached to an eddy current dynamometer with speed sensing unit incorporated. PCB (USA) make piezo - electric transducer is flush mounted in the cylinder head and used to measure cylinder pressure. An optical encoder is employed to capture the rpm of the crank shaft. Data acquisition system with high speed is used for acquisition and analysis of pressure crank angle data is done by software. To eliminate effect of cycle to cycle variation,

pressure crank angle data for 100 consecutive cycles is recorded and averaged. Parameters are calculated using averaged data. Software calculates and displays performance and combustion parameters from the recorded observations. Each experiment was conducted four times and values are averaged to avoid errors. Emissions are measured by a gas analyzer; specifications are presented in Table 2.

Table 2 : Specifications of 5-gas analyzer Indus make.

Exhaust gas	Measurement Range	Resolution	Accuracy	Measuring Method
CO	0-15.0% vol	0.01% vol	+ 0.06% vol	NDIR
HC	0-30000 ppm (Propane) 0-15000 ppm (Hexane)	1 ppm vol	+ 12ppm	NDIR
NO <sub>x</sub>	0-5000 ppm	1 ppm vol	+ 50% vol	Electrochemical

### III. METHODOLOGY

The factors considered in the present work are injection timing, injection pressure, compression ratio

and load. Each factor is varied at 4-levels as presented in Table 3.

Table 3 : Factors and their levels

Factors	Level 1	Level 2	Level 3	Level 4
Injection Timing (°bTDC)	20	22	24	26
Injection Pressure (bar)	180	200	220	240
Compression Ratio	15	16.5	18	19
% of Full Load	22	40	60	80

The Taguchi method employs orthogonal arrays from theory of DOE to learn the effect of huge number of controllable factors on responses inside a small experimental matrix. Use of orthogonal arrays notably reduce the number of experiments in view of the fact that it provides the shortest possible matrix in which all

factors are varied over working range. Furthermore, the conclusions from this shortest number of experiments are valid over entire range. L<sub>16</sub> orthogonal array is prepared from Taguchi's design with four factors and four levels as presented in Table 4.

Table 4 : Orthogonal array for experimental data

S.No	Injection Timing(°bTDC)	Injection Pressure (bar)	Compression Ratio	% Full Load
1.	22	180	15	20
2.	22	200	16.5	40
3.	22	220	18	60
4.	22	240	19	80
5.	24	180	16.5	60
6.	24	200	15	80
7.	24	220	19	20
8.	24	240	18	40
9.	26	180	18	80
10.	26	200	19	60
11.	26	220	15	40
12.	26	240	16.5	20
13.	28	180	19	40
14.	28	200	18	20
15.	28	220	16.5	80
16.	28	240	15	60

Interaction among the factors was neglected because all are independent. Motivation for selection of response variables is, to make the present work

significant to the existing studies of focussing all-pervading performance, combustion and emission

parameters that confront the contemporary diesel engine design.

Experiments were conducted as per  $L_{16}$  orthogonal array presented in Table 4. Compression ratio was varied with the help of a lever attached to the cylinder head. Number of shims was adjusted under the seat of the mounting flange of fuel pump to alter static injection timing. It was noted that, addition of shims retards fuel injection timing and vice versa. Injection pressure was measured and adjusted using an injector opening pressure test rig. It comprises of a pipe to connect to the injector and a fuel reservoir. Spring tension of the nozzle is varied by adjusting screw on the injector to vary the pressure.

Various performance parameters considered in the present work are brake specific fuel consumption (BSFC), brake thermal efficiency (BTHE) and exhaust gas temperature (EGT). Low values of BSFC and EGT are preferable whereas high value of BTHE is preferable. BSFC and BTHE were calculated and EGT was recorded from display.

Combustion parameters studied in the present work are ignition delay (ID), peak pressure (PP) and Heat release (HR). The time interval between start of injection (CAD at which fuel injection starts) and start of combustion (CAD at which combustion starts) in diesel engines is called ignition delay period [19]. It may be expressed in terms of CAD (crank angle degrees) or milliseconds. From  $p-\theta$  data, CAD is noted, where positive values of heat release (start of combustion) is observed and ignition delay was calculated as difference between CAD of start of combustion and start of injection.

Peak pressure is the maximum cylinder pressure attained during combustion process very near to and after TDC and is taken from  $p-\theta$  data. Heat release is the amount of heat released during combustion process. According to Heywood [19], combustion continues well into the expansion stroke up to  $31^\circ$ . HR is taken as the sum total of HR per CAD from start of combustion to significant positive values of HR per CAD.

$NO_x$ , CO and HC are the emissions considered in this work for analysis and are measured using exhaust gas analyser (details are presented in Table.2)

a) *Taguchi Method*

Taguchi approach employs the parameter SNR (Signal to Noise Ratio) for optimization. Largest value SNR is preferred as it indicates minimized effects of noise factors. SNRs are calculated by formulae mentioned in section 1.2 based on criteria smaller the better or larger the better. Larger the better criteria is used for brake thermal efficiency, peak pressure, and heat release whereas smaller the better criteria is used for BSFC, exhaust gas temperature, ignition delay, CO,  $NO_x$  and HC. In the present work Minitab software is

used for Taguchi design, SNR calculations, main effects plots and performing ANOVA. After computation of SNRs, main effect plots for SN Ratios are plotted by taking data means. The SNRs for different responses were calculated at each factor level. The average effects were calculated by taking sum total of each factor level and then dividing by number of data points.

In view of the fact that Taguchi approach results in different optimal conditions for various responses, overall optimal condition cannot be figured out. Hence in the present work grey relational analysis is also carried out for multi objective optimization.

b) *Grey Relational Analysis*

The degree of approximation among the sequences is measured using a parameter called grey relational grade in grey relational analysis. In grey relational analysis, the responses are normalized between zero and 1. This process is known as grey relational generation. Normalized data for lower the better criteria can be calculated by Eq.3 and for higher the better by Eq. 4.

$$x_i(k) = \frac{\max y_i(k) - y_i(k)}{\max y_i(k) - \min y_i(k)} \quad (3)$$

$$x_i(k) = \frac{y_i(k) - \max y_i(k)}{\max y_i(k) - \min y_i(k)} \quad (4)$$

Where  $y_i(k)$  is the original sequence (response from experiments),  $x_i(k)$  is the sequence

for comparison (normalized value of response) and  $i=1,2,\dots,m$  and  $k= 1,2,\dots,n$ ;  $m$  is total number of experiments and  $n$  is total number of responses.  $\min y_i(k)$  and  $\max y_i(k)$  are lowest and highest values of  $y_i(k)$  respectively.

Next, deviational sequences  $\Delta_{oi}$  for responses are calculated from Eq.5.

$$\Delta_{oi} = |x_0(k) - x_i(k)| \quad (5)$$

where  $x_0(k)$  was an ideal sequence.

GRC (Grey relational coefficient)  $\xi_i(k)$  for each response is calculated to represent the correlation between the desired responses and actual experimental data using Eq. 6 .

$$\xi_i(k) = \frac{\Delta_{\min} + \psi \Delta_{\max}}{\Delta_{oi}(k) + \psi \Delta_{\max}} \quad (6)$$

$\Delta_{\min}$  and  $\Delta_{\max}$  are the minimum and maximum values of the absolute differences of all comparing sequences.  $\psi$  is the distinguishing coefficient and it lies in the range  $0 \leq \psi \leq 1$ . Value of distinguishing coefficient is taken as 0.5 for all responses [20, 21].

Subsequent to calculation of grey relational coefficients grey relational grade  $\gamma_k$  is calculated for each response by assigning appropriate weighting factor  $\beta_i$ . Weighting factor is assigned to a particular response, based on their relative significance, and the sum of weighting factors must be equal to unity [22]. In the present work weighting factor 0.2 is assigned for brake thermal efficiency and 0.1 for all other responses.

A grey relational grade is a weighted sum of the grey relational coefficients, and is calculated using Eq. 7.

$$\gamma_k = \sum_{i=1}^n \xi_i(k) \beta_i \quad (7)$$

For  $k^{th}$  response variable, where  $\gamma_k$  is grey relational grade,  $\xi_i(k)$  is distinguishing coefficient,  $\beta_i$  is weighting factor. Closeness of particular response with optimal value is given by higher value of grey relational grade.

This study uses  $L_{16}$  orthogonal array of Taguchi method mentioned in Table 4 to find out best Injection timing, injection pressure, compression ratio and load setting for diesel engine. At four levels of each factor, the responses viz. BSFC, brake thermal efficiency, peak pressure, and heat release, exhaust gas temperature, ignition delay, CO, NO<sub>x</sub> and HC are determined.

#### IV. TAGUCHI RESULTS ANALYSIS AND CONFIRMATION EXPERIMENTS

SNR curves are graphical representations of variation in responses with variation in factor levels. From these curves two observations are noted. First one is most influential parameters and second is their optimum levels. After taking average of SNRs at four levels of particular factor, plots are drawn for means of SNRs Vs factor level. Fig. 2 (a) to 2(i) show such plots for all 9 response variables. Level with highest value of mean SNR is considered as optimal value.

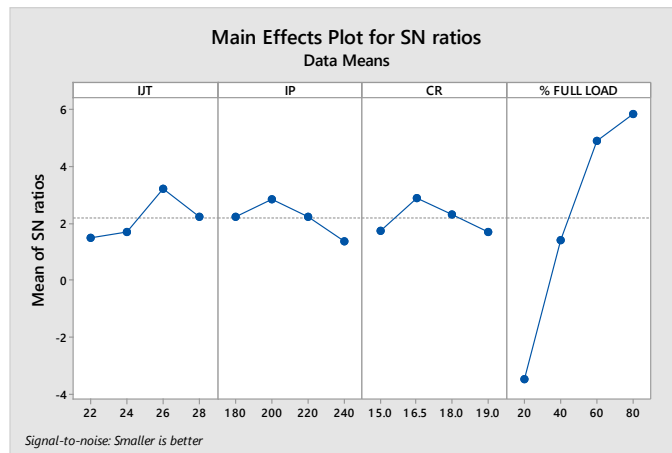

Fig. 2 (a) : Main effects plot for SNR of BSFC

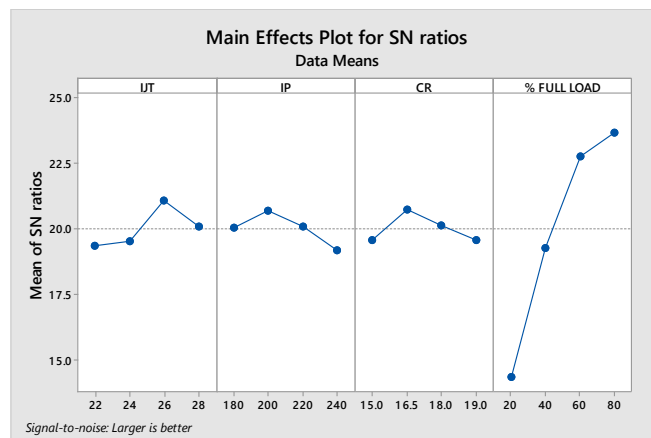

Fig. 2 (b) : Main effects plot for SNR of BTHE.

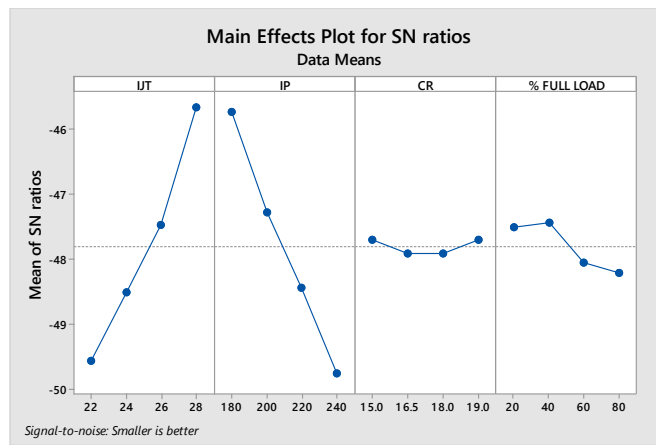

Fig. 2 (c) : Main effects plot for SNR of EGT

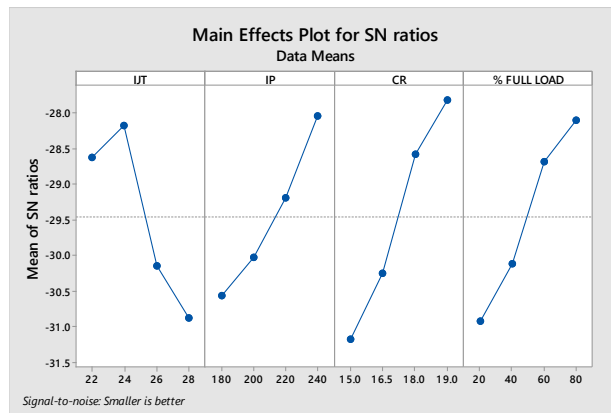

Fig. 2(d) : Main effects plot for SNR of Ignition Delay

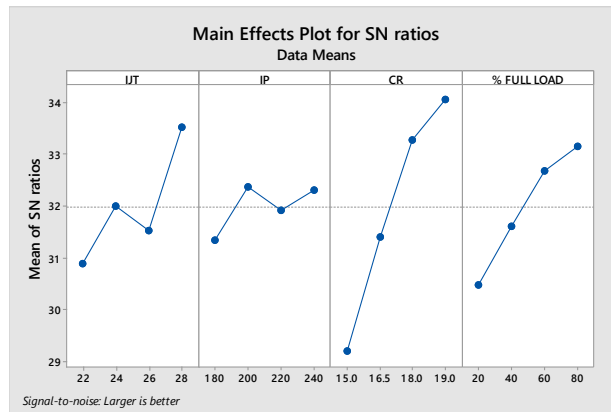

Fig. 2(e) : Main effects plot for SNR of Peak Pressure



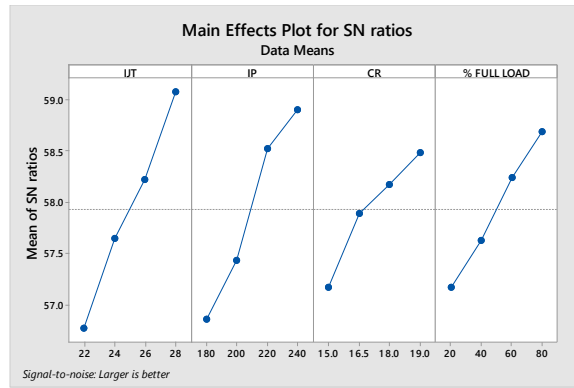

Fig. 2 (f) : Main effects plot for SNR of Heat Release

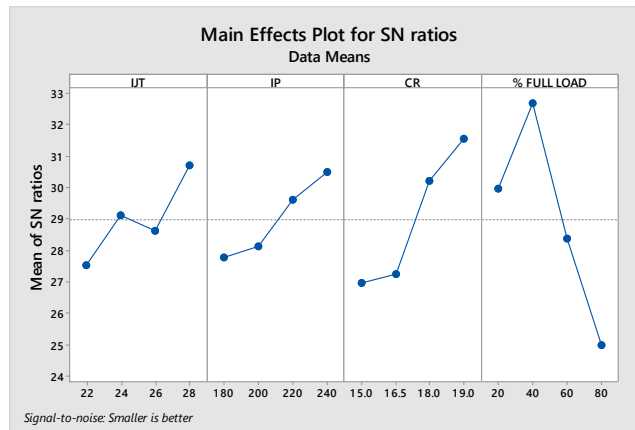

Fig. 2 (g) : Main effects plot for SNR of CO

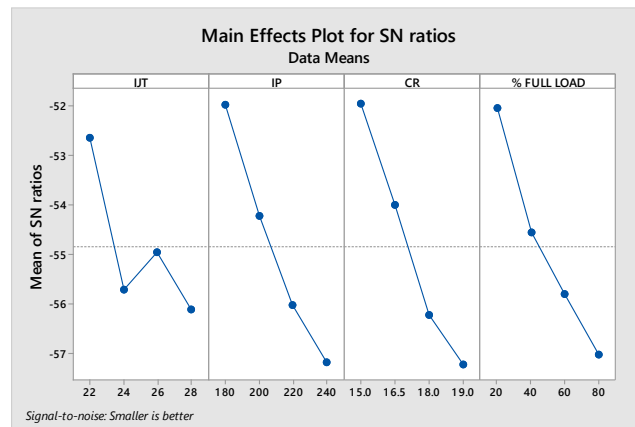

Fig. 2 (h) : Main effects plot for SNR of NOx

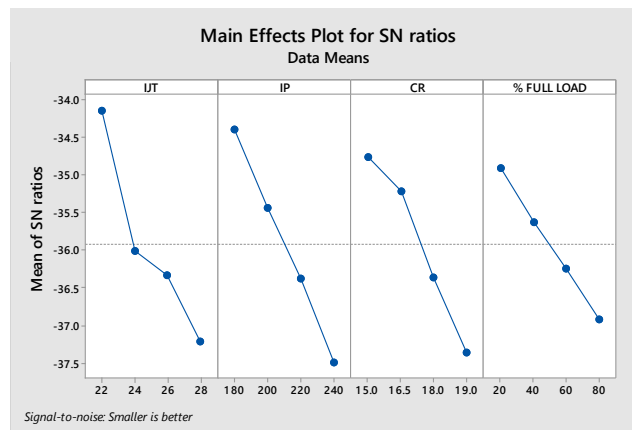

Fig. 2 (i) : Main effects plot for SNR of HC

Table 5 presents optimal settings of factors for different set of factor values lead to optimal values of various responses. It is evident from Table 5 that different responses.

Table 5 : Optimum factor settings from SNR analysis

Controlled Factors	BSFC (kg/kW-hr)	BTHE (%)	EGT (°C)	PP (bar)	ID (CAD)	HR (J)	CO (% by vol)	NOx (ppm)	HC (ppm)
IJT (degrees BTDC)	26	26	28	28	24	28	28	22	22
IP (bar)	200	200	180	240	240	240	240	180	180
CR	16.5	16.5	19	19	19	19	19	15	15
% of Full Load	80	80	40	80	80	80	40	20	20

Experiments were conducted at optimal set of conditions as mentioned in Table 4 and corresponding responses were recorded. The values of responses at

optimal settings from Taguchi analysis are compared with that of baseline engine and presented in Table 6.

Table 6 : Comparison of base line engine experiments with optimized engine experiments

	BSFC (kg/kW-hr)	BTHE (%)	EGT (°C)	PP (bar)	ID (CAD)	HR (J)	CO (% by vol)	NOx (ppm)	HC (ppm)
Baseline Engine	0.41	18.95	253	40.9	20	817.74	0.0632	651	62
Optimized Engine	0.37	21.63	139	69.4	14	1185.68	0.0101	153	32

It is observed from Table 6 that the parameters BSFC, EGT, ID, CO, NOx and HC shown significant decrease for optimized engine compared to baseline engine and is represented in Fig. 3(a), whereas the

parameters BTHE, PP and HR shown significant increase for optimized engine compared to baseline engine and is represented in Fig. 3(b).

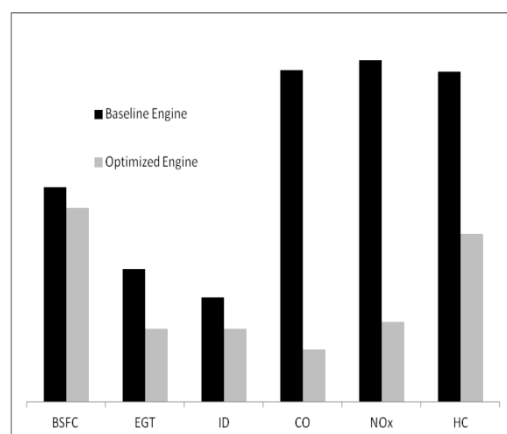

Fig. 3(a) : Comparison of parameters (to be minimized) between baseline engine and optimized engine

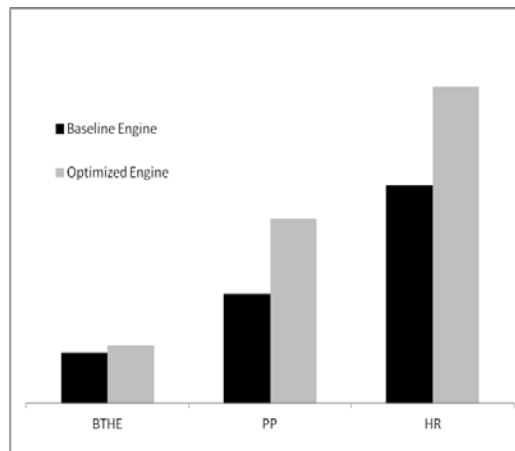

Fig. 3 (b) : Comparison of parameters (to be maximized) between baseline engine and optimized engine

To validate Taguchi model, SNR and response value for a set of factors can be predicted and experiments are conducted at the same factor settings to get response value and compared. Confirmation tests are conducted at different sets of factor settings for

each response variable and values are recorded. A comparison between predicted values and experimental values of responses is presented in Table 7 and good agreement between Taguchi prediction and confirmation tests is observed.

Table 7 : Comparison between Taguchi prediction and confirmation test values.

S.No	Response Variable	Taguchi Prediction value	Confirmation test value	% Difference between prediction and confirmation test
1	BSFC (kg/kW-hr)	0.455688	0.42	-8.49714
2	BTHE (%)	15.26	16.2	5.802469
3	EGT (° C)	229.75	228	0.7617
4	PP (bar)	45.5812	44.4	-2.66036
5	ID (CAD)	23.43	22.3	-5.06726
6	HR (J)	606.519	623.6	2.739096
7	CO (% by vol)	0.05948	0.0622	4.37299
8	NO <sub>x</sub> (ppm)	653.875	596	-9.71057
9	HC(ppm)	58.875	55	-7.04545

a) Grey Relational Analysis Results

Taguchi approach, even though resulted in optimal values of responses, factors are optimized one at a time (single objective optimization) and for various responses different factor settings were obtained. To overcome this problem with Taguchi approach, grey relational analysis with Taguchi approach was carried out for multi objective optimization.

Initially responses were normalized based on higher the better or smaller the better criteria and deviation sequences were calculated. Grey relational coefficients are calculated using Eq. 6 and grey relational grades for responses were calculated using Eq. 7 by assigning appropriate weights and are presented in Table 8.

Table 8 : Grey relational coefficients and grey relational grades

Weights	0.1	0.2	0.1	0.1	0.1	0.1	0.1	0.1	0.1	0.1
S.No	BSFC	BTHE	EGT	PP	ID	HR	CO	NOX	HC	GRG
1	0.3349	0.3335	0.5812	0.3333	0.3333	0.33333	0.3862	1	1	0.496937
2	0.6266	0.4428	0.4583	0.4667	0.4366	0.39108	0.5544	0.6316	0.6986	0.514963
3	0.9098	0.7494	0.3952	0.5965	0.6889	0.49505	0.6005	0.4142	0.4857	0.608461
4	0.8868	0.7146	0.3333	0.905	1	0.63613	0.4766	0.3333	0.3333	0.633373
5	0.986	0.9701	0.616	0.5022	0.5636	0.43081	0.3951	0.5825	0.5604	0.657692
6	1	1	0.52	0.4555	0.5254	0.44138	0.3333	0.4816	0.4857	0.624302
7	0.3333	0.3333	0.4617	0.6387	0.6078	0.52241	0.7994	0.4029	0.4016	0.483446
8	0.5402	0.4008	0.3965	0.6765	0.6889	0.57478	0.8957	0.3389	0.3778	0.529082
9	0.9591	0.8628	0.6552	0.7708	0.5254	0.53367	0.3868	0.4307	0.4359	0.642322
10	0.9098	0.7559	0.5812	1	0.5636	0.57663	0.5753	0.3863	0.3835	0.6488
11	0.7622	0.5481	0.5576	0.3773	0.4026	0.49044	0.6336	0.5825	0.4766	0.537909
12	0.4879	0.3803	0.4634	0.4148	0.4247	0.53775	0.6322	0.5119	0.4359	0.466896
13	0.6812	0.479	1	0.8956	0.4247	0.52378	1	0.4448	0.4016	0.632967
14	0.4983	0.3841	0.7792	0.7377	0.4133	0.51787	0.6927	0.5342	0.4286	0.536988
15	0.945	0.8381	0.601	0.8147	0.4627	1	0.398	0.3549	0.3669	0.661939
16	0.7231	0.5095	0.52	0.5651	0.4493	0.75654	0.6005	0.3998	0.3517	0.538499

The average of grey relational grade for each level of factor is calculated and tabulated in Table 9.

Table 9 : Average values of GRG

LEVELS	IJT	IP	CR	% FULL LOAD
1	0.563433	<b>0.607479</b>	0.549412	0.496066
2	0.57363	0.581263	0.575372	0.55373
3	0.573982	0.572939	0.579213	0.613363
4	<b>0.592598</b>	0.541962	<b>0.599646</b>	<b>0.640484</b>
Delta	0.029165	0.065517	0.050235	0.144418
Rank	4	2	3	1

The grey relational grade signifies the correlation between the reference sequence and comparability sequence, higher value of grey relational coefficient indicates stronger correlation. From Table 9, it is concluded that optimal factor setting is 4<sup>th</sup> level of IJT i.e. 28° bTDC, 1<sup>st</sup> level of IP (180 bar), 4<sup>th</sup> level of both CR and % full load i.e. 19 and 80% full load respectively.

To validate the model developed for optimize factor settings for maximum value of GRG prediction was carried at IJT 24° bTDC, IP 200 bar, CR 16.5 and at 40% full load. GRG for prediction was 0.556263 where as confirmation test by experimentation at the above factor settings was 0.551443. Further, from Table 9, it is reported that most influencing factor is % full load whereas least one is injection timing. However, relative importance of factors on responses quantitatively must be known for accurate determination of optimal factor setting, which can be accomplished by ANOVA.

b) Analysis of Variance

The objective of Analysis of Variance (ANOVA) is to explore most influential parameter (factor) that effect response, quantitatively. ANOVA is carried out using MINITAB software and results are presented in Table 10.

Table 10 : ANOVA results grey relational grade

Factor	Degrees of Freedom	Adjusted Sum Square	Mean sum Square	F-Value	P-Value	Contribution
IJT	3	0.001772	0.000591	0.33	0.805	2.51%
IP	3	0.008746	0.002915	1.64	0.347	12.37%
CR	3	0.005107	0.001702	0.96	0.513	7.22%
% FULL LOAD	3	0.049758	0.016586	9.34	0.050	70.37%
Error	3	0.005325	0.0017775			7.53%
Total	15					100.00%

From ANOVA results it is reported that load is the most influential parameter (70.37%) where as injection pressure, compression ratio and injection timing influence in the order is 12.37%, 7.22% and 2.51%.

## V. CONCLUSIONS

In this paper, optimal engine design and operating parameters viz. injection timing, injection pressure, compression ratio and % full load were determined for (nine) multiple response parameters (brake thermal efficiency, brake specific fuel consumption, exhaust gas temperature, peak pressure, ignition delay, heat release, CO, NOx and HC ) by using Taguchi and grey relational analysis. 16 experiments were conducted as per  $L_{16}$  orthogonal array.

As Taguchi approach can handle single objective optimization problem optimal factor settings for each of nine parameters was explored separately, however it was observed that for various response parameters optimal factor settings were different. Hence authors attempted multi objective/variant optimization by using grey relational approach coupled with Taguchi approach. The grey relational analysis by assigning weighting factors, converts optimization of multi response problem into optimization of single objective i.e. grey relational grade. By using grey relational analysis coupled with Taguchi approach optimal factor settings reported were  $28^{\circ}$  bTDC injection timing, 180 bar injection pressure, 19 compression ratio and 80% of the full load and load was observed to be most influential parameter. To validate the model developed for multi objective optimization confirmation test were conducted and compared with prediction and the results were satisfactory. Further ANOVA was carried out to explore relative influence of factors on responses and relative contribution of load was reported as 70.37%. Thus the relationship between the diesel engine design and operating parameters with performance, combustion and emission parameters could be better understood using Taguchi and grey relational method.

## REFERENCES RÉFÉRENCES REFERENCIAS

1. Joonsik Hwang, Donghui Qi, Yongjin Jung, Choongsik Bae, Effect of injection parameters on the combustion and emission characteristics in a common-rail direct injection diesel engine fueled with waste cooking oil biodiesel, Renewable Energy (Elsevier), Volume 63, March 2014, Pages 9-17, ISSN 0960-1481
2. Sharma, A. and Sivalingam, M., "Impact of Fuel Injection Pressure on Performance and Emission Characteristics of a Diesel Engine Fueled With Jatropha Methyl Ester Tyre Pyrolysis Blend," SAE Technical Paper 2014-01-2650, 2014
3. Joonsik Hwang, Donghui Qi, Yongjin Jung, Choongsik Bae, Effect of injection parameters on the combustion and emission characteristics in a common-rail direct injection diesel engine fueled with waste cooking oil biodiesel, Renewable Energy (Elsevier), Volume 63, March 2014, Pages 9-17, ISSN 0960-1481
4. Avinash Kumar Agarwal , Atul Dhar , Jai Gopal Gupta , Woong Kim , Kibong Choi , Chang Sik Lee , Sungwook Park, Effect of fuel injection pressure and injection timing of Karanja biodiesel blends on fuel spray, engine performance, emissions and combustion characteristics, Energy Conversion and Management, Elsevier, 91 (2015) 302–314 .
5. R.S.Hosmath ,N.R.Banapurmath ,S.V.Khandal ,V.N.Gaitonde ,Y.H.Basavarajappa , V.S. Yaliwal, Effect of compression ratio, CNG flow rate and injection timing on the performance of dual fuel engine operated on honge oil methyl ester (HOME) and compressed natural gas (CNG), Renewable Energy, Elsevier, 93 (2016) 579-590
6. Total Quality Management, NVS RAJU, Cengage Learning, ISBN-13: 978-81-315-2562-3, ISBN-10: 81-315-2562-7, 2014
7. T. Ganapathy, K. Murugesan , R.P. Gakkhar, Performance optimization of Jatropha biodiesel engine model using Taguchi approach, Applied Energy, Elsevier, 86 (2009) 2476–2486,
8. Horng-Wen Wu, Zhan-Yi Wu, Using Taguchi method on combustion performance of a diesel engine with diesel/biodiesel blend and port-inducting  $H_2$ , Applied Energy, Elsevier, 104 (2013) 362–370
9. Kaliamoorthy, S., Paramasivam, R, Investigation on performance and emissions of a biodiesel engine through optimization techniques, THERMAL SCIENCE: Year 2013, Vol. 17, No. 1, pp. 179-193 DOI: 10.2298/TSCI120105151K

10. Karthikeyan.R, Nallusamy.N, Alagumoorthi.N, Ilangovan.V, Optimization of Engine Operating Parameters for Turpentine Mixed Diesel Fueled DI Diesel Engine Using Taguchi Method, *Modern Applied Science*, Vol. 4, No. 12; December 2010, 182
11. Vincent H. Wilson, Udaya kumar, Optimization of Diesel Engine Parameters Using Taguchi Method and Design of Evolution, *J. of the Braz. Soc. of Mech. Sci. & Eng.* October-December 2012, Vol. XXXIV, No. 4, 423-428
12. Ashish Karnwal, M. M. Hasan, Naveen Kumar, Arshad Noor Siddiquee & Zahid A. Khan, Multi Response Optimization of Diesel Engine Performance Parameters Using Thumba Biodiesel-Diesel Blend by Applying Taguchi Method and Grey Relational Analysis, *International Journal Of Automotive Technology* - August 2011
13. Sumit Roy, Ajoy Kumar Das, Rahul Banerjee, Application of Grey-Taguchi based multi-objective optimization strategy to calibrate the PM-NHC-BSFC trade-off characteristics of a CRDI assisted CNG dual-fuel engine, *Journal of Natural Gas Science and Engineering*, Elsevier, 21 (2014) 524-53
14. Goutam Pohit and Dipten Misra, Optimization of Performance and Emission Characteristics of Diesel Engine with Biodiesel Using Grey-Taguchi Method, *Journal of Engineering*, Hindawi Publishing Corporation, Volume 2013, Article ID 915357, 8 pages, <http://dx.doi.org/10.1155/2013/915357>
15. Combustion and Emission Based Optimization of Turbocharged Diesel Engine Run on Biodiesel using Grey-Taguchi Method, M. I. Masood, A. N. Shah, A. Aslam, M. Gul, A. Naveed, M. Usman, *Technical Journal, University of Engineering and Technology (JET) Taxila, Pakistan* Vol. 20 No. III-2015
16. Nandkishore D.Rao, Dr. B. Sudheer Prem Kumar, Dr. C. Srinath, Chandrashekar Patil, Optimization Of Engine Operating Parameters, *International Journal of Mechanical Engineering and Technology (IJMET)*, Volume 5, Issue 9, September (2014), pp. 01-07
17. Hussain M, Peethambaran K M, Ushakumari E R, Performance Optimization of Diesel Engine with Chicken Waste Bio-diesel Blend Using Grey Rrelational Aanalysis, *International Journal of Engineering Research and Development*, Volume 10, Issue 11 (November 2014), PP.09-15
18. K.Prasada Rao , R.UmaMaheswara Rao, S.Ravi Babu and Dr.V.Rambabu, Optimization of Performance Parameters of a Diesel Engine fuelled with Biofuels, *International Journal of Thermal Technologies*, Vol.3, No3. ( Sept. 2013)pp 85-91
19. *Internal Combustion Engine Fundamentals*: John B. Heywood McGraw Hill Book Company (1998)
20. Mustabshirha Gul, Asad Naeem Shah, Younis Jamal, Imran Masood, Multi-variable optimization of diesel engine fuelled with biodiesel using grey-Taguchi method, *Journal of the Brazilian Society of Mechanical Sciences and Engineering*, February 2016, Volume 38, Issue 2, pp 621-632
21. Chin-Ping Fung, Manufacturing process optimization for wear property of fiber-reinforced polybutylene terephthalate composites with grey relational analysis, *Wear* , Elsevier, 254 (2003) 298–306
22. Yiyo Kuo, Taho Yang , Guan-Wei Huang, The use of grey relational analysis in solving multiple attribute decision-making problems, *Computers & Industrial Engineering*, 55 (2008) 80–93

This page is intentionally left blank