

Orbit Fluctuation of Electron Beam due to Vibration of Vacuum Chamber in Quadrupole Magnets

**Sakuo MATSUI, Masaya OISHI, Hitoshi TANAKA, Tetsuhiko YORITA, Koji TSUMAKI,
Noritaka KUMAGAI, Toshiharu NAKAZATO
Japan Synchrotron Radiation Research Institute (JASRI)**

“Reduction of Vibration of SPring-8 Storage Ring Vacuum Chambers”

In recent study, we found the correlation between the fluctuation of beam and the vibration of vacuum chambers shaken by the water flow.

The mechanism was shown in previous talk in detail, and in this talk I will show about the source of the vibration and how to reduce them.

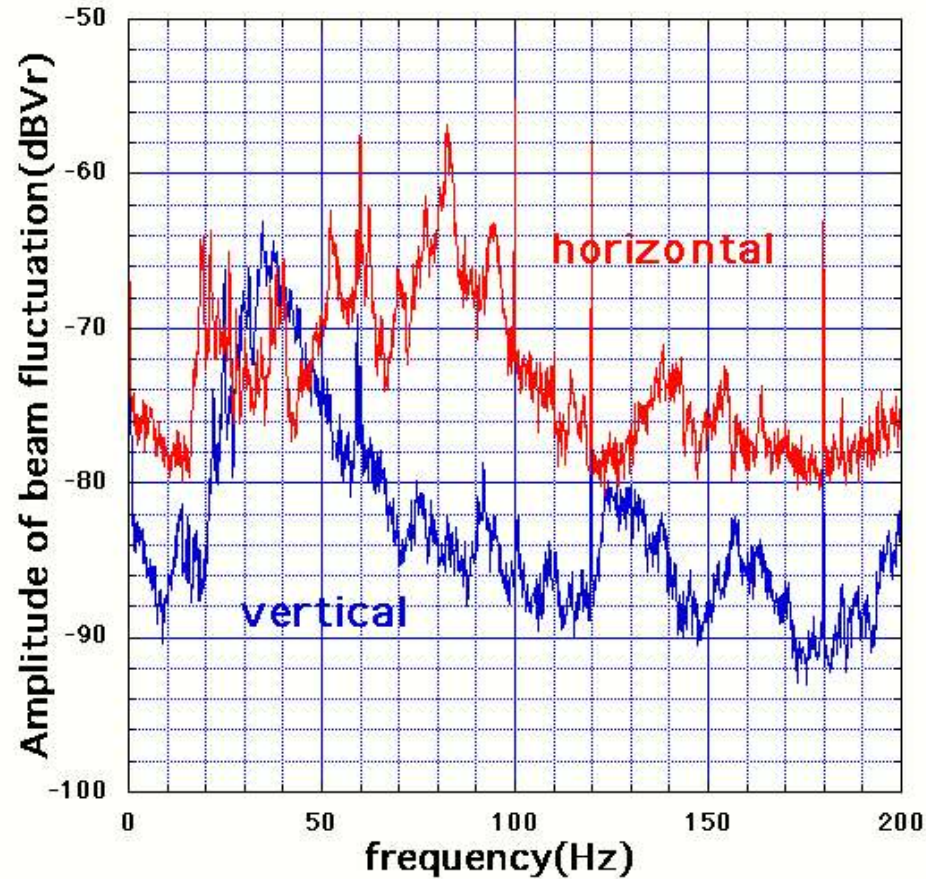

Orbit fluctuation of beam

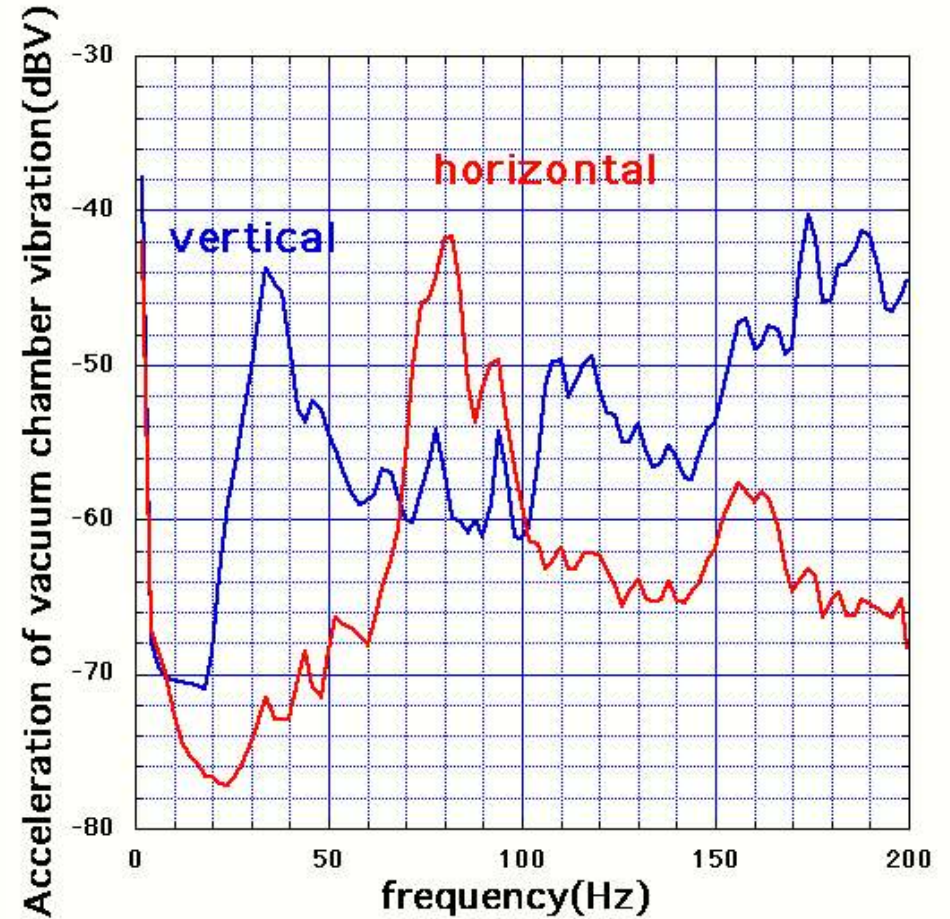

Vibration of vacuum chambers at AB2

Spectra of vibration of vacuum chambers are similar to the ones of electron beam fluctuation, and there is correlation as shown in previous talk.

In order to reduce the beam fluctuation we investigated how to reduce the vibration of vacuum chambers and improved it.

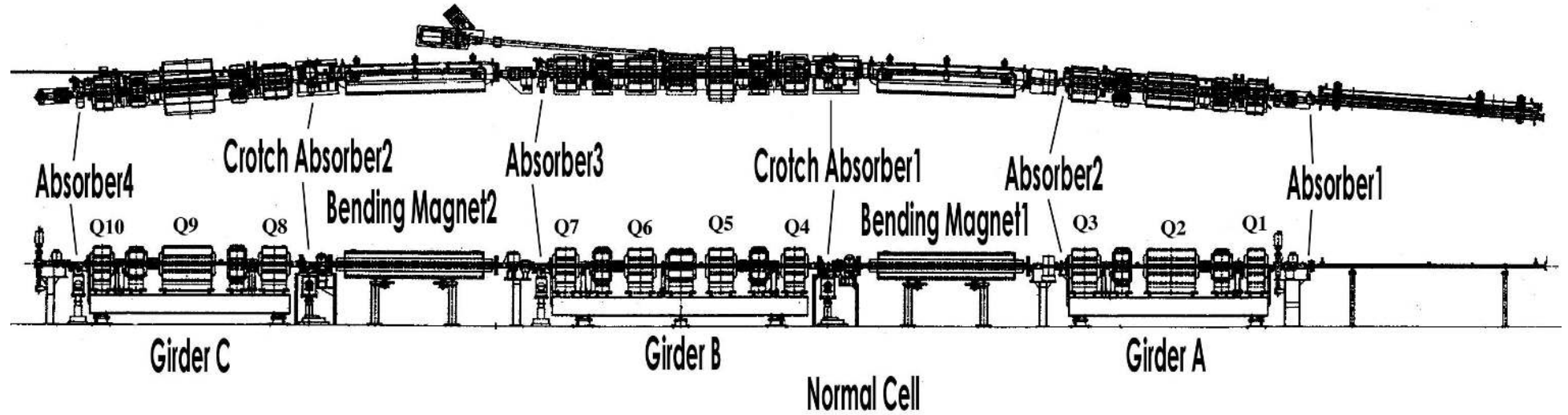
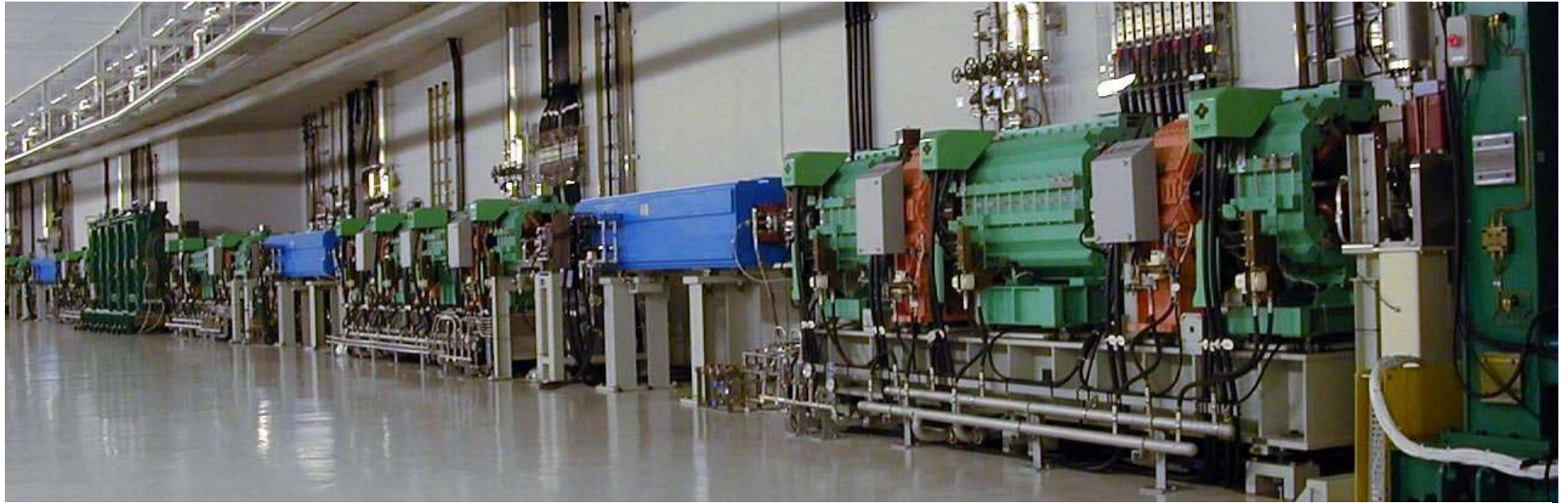

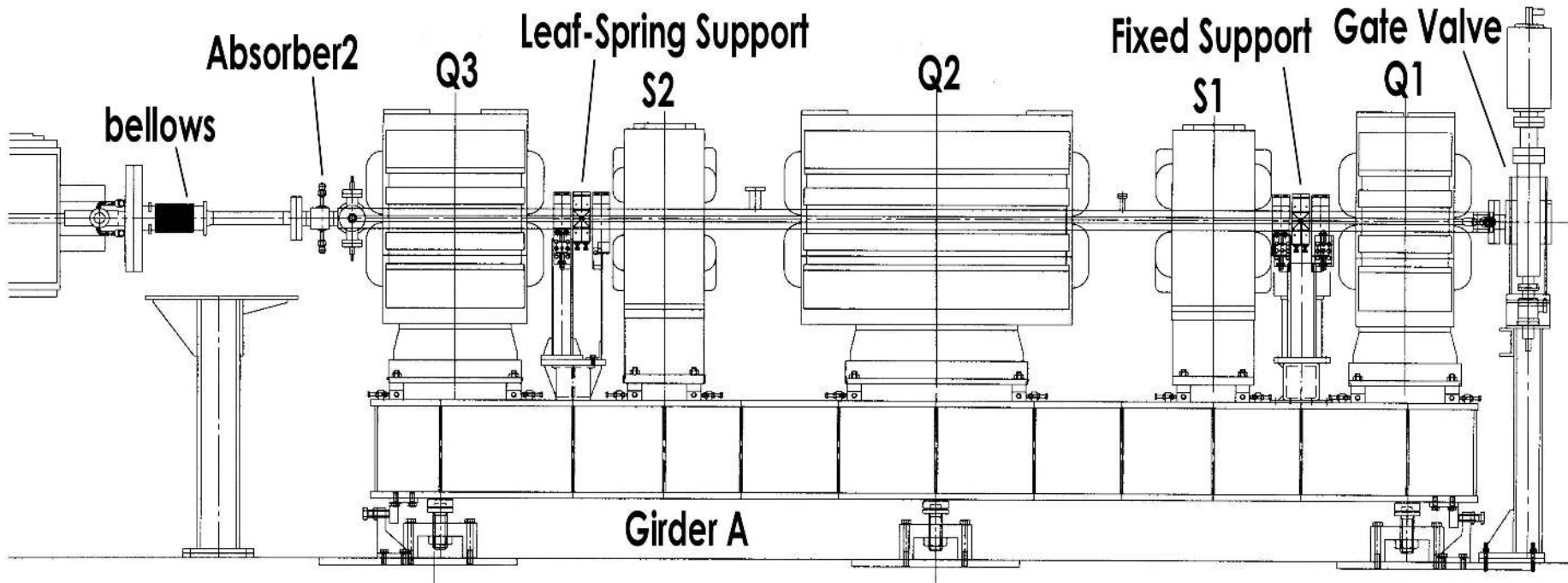
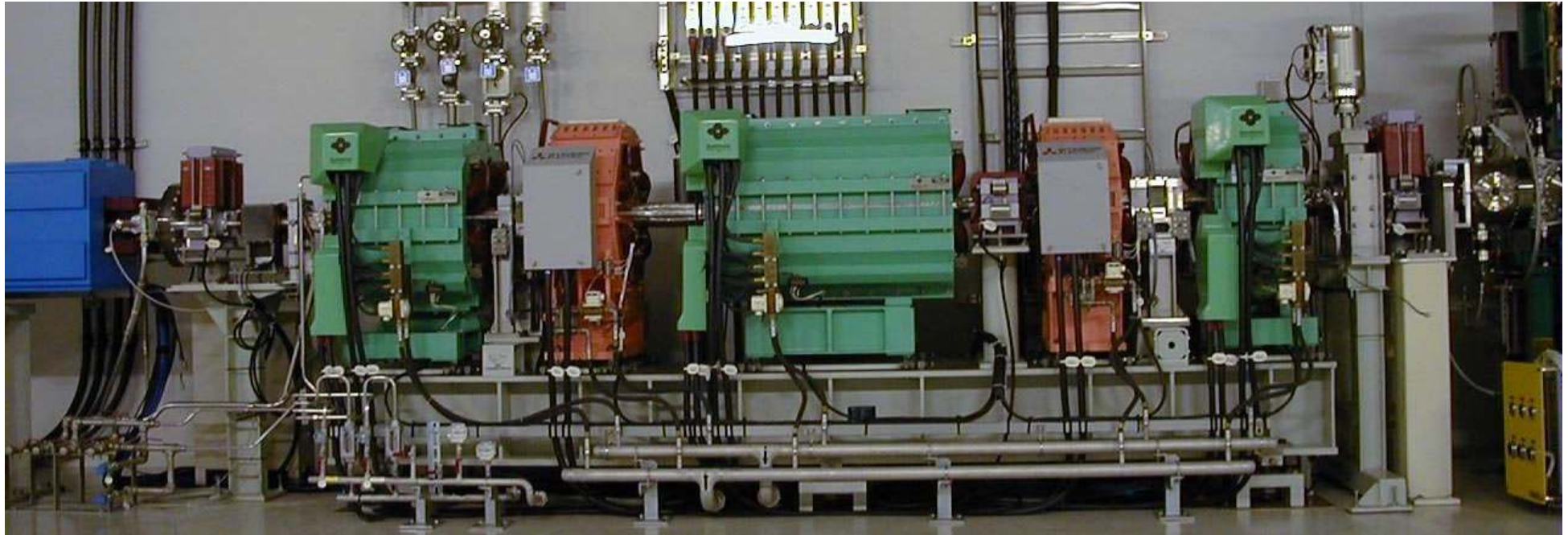

Fluctuation measurement

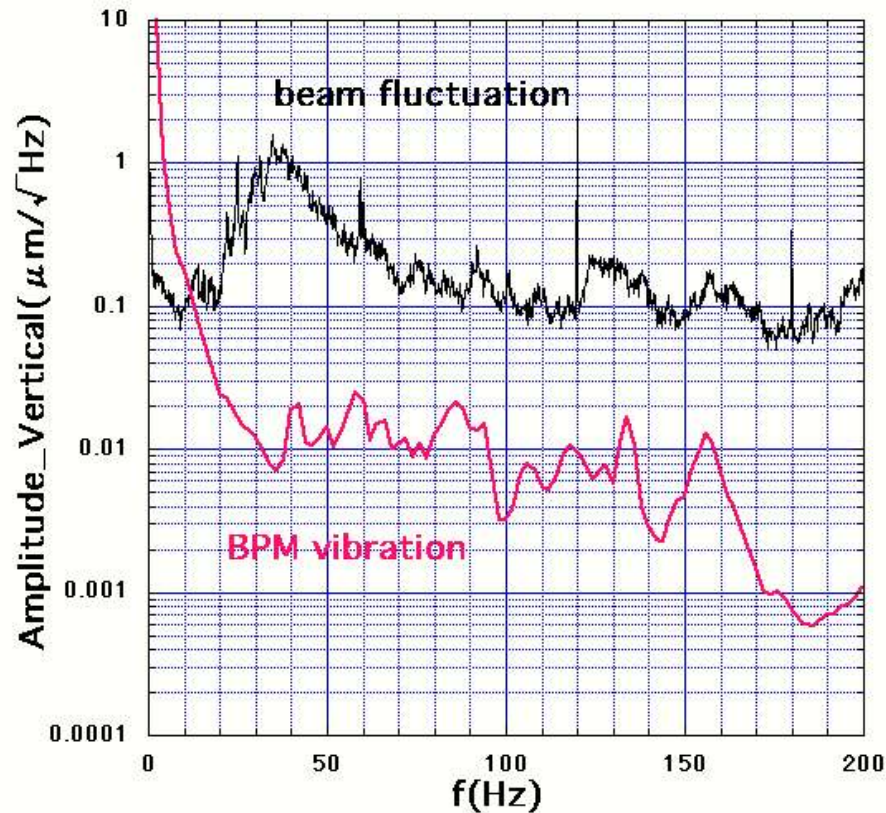

vertical

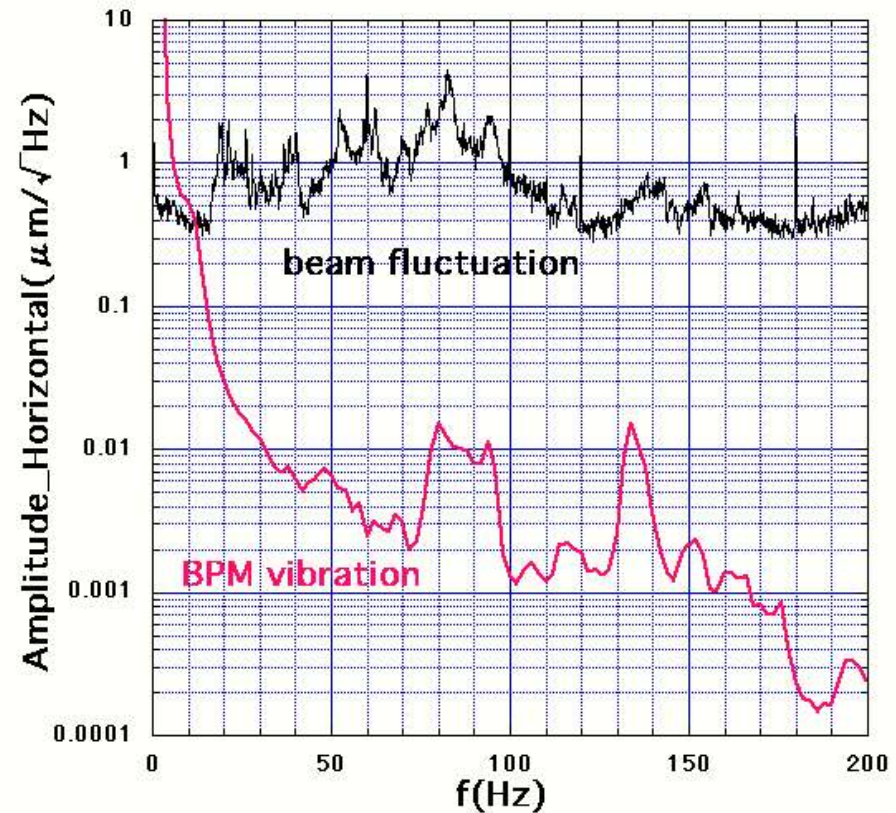

horizontal

Comparison between beam fluctuation and RF-BPM vibration

BPM vibrations are low for beam fluctuation enough.

Accordingly vibrations of BPM don't influence the measurement of beam fluctuation.

Vibration measurement



Accelerometer

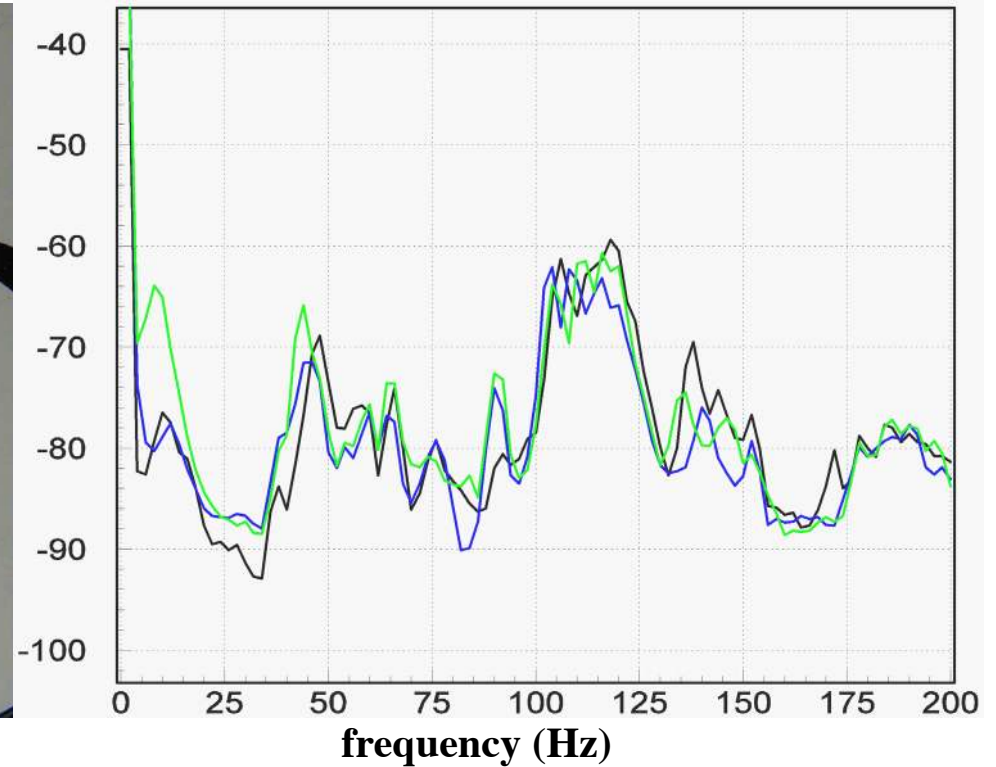

**Measurement result of three times
with the same conditions**

We touched the surface of the vacuum chamber with this by hand and measured the vibration. Measurement result of three times with the same conditions, and error caused by this style is small over 20Hz.

Results of investigation

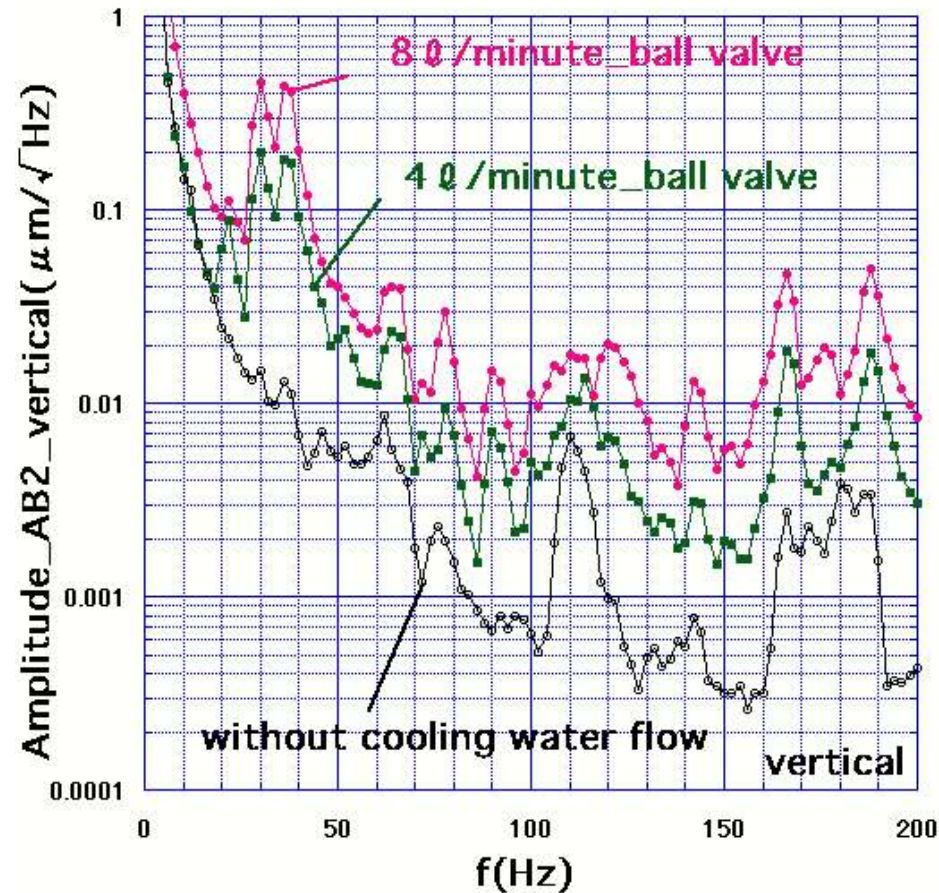

**Influence of cooling water
flow rate of AB2**

**The cause of vibration of vacuum chambers
is cooling water flow of AB2 obviously.**

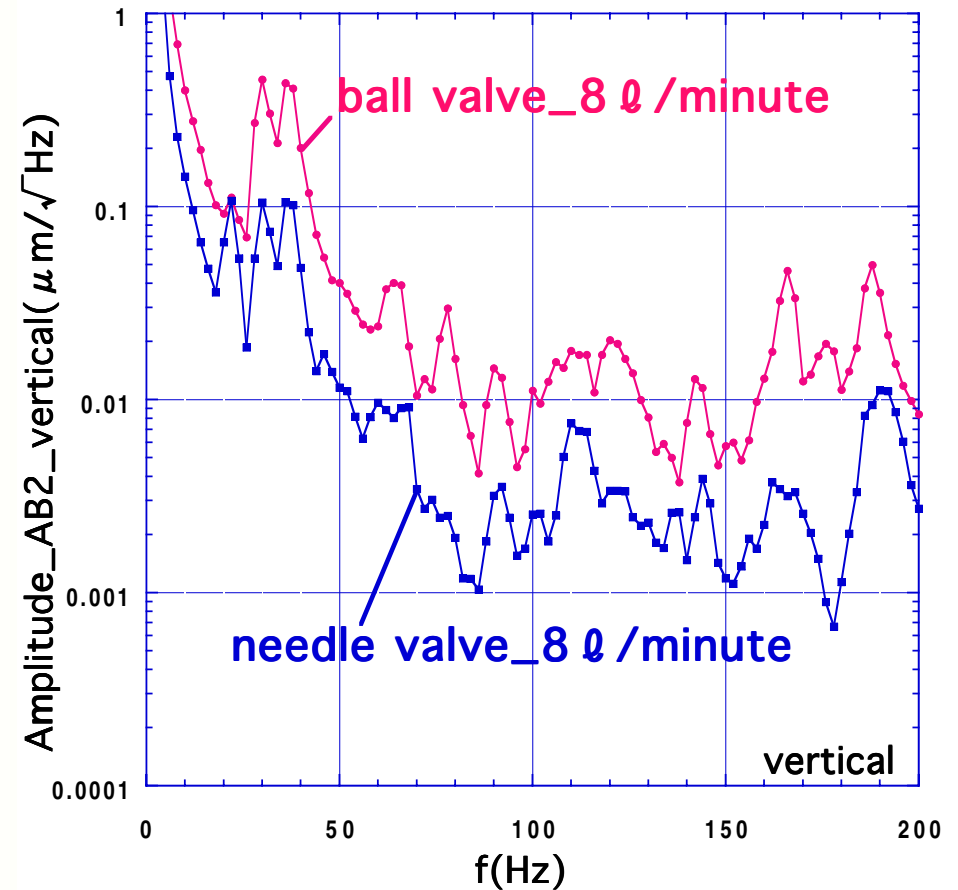

**Influence of kind of
flow control valve**

Needle valves are better for vibration

Machine study

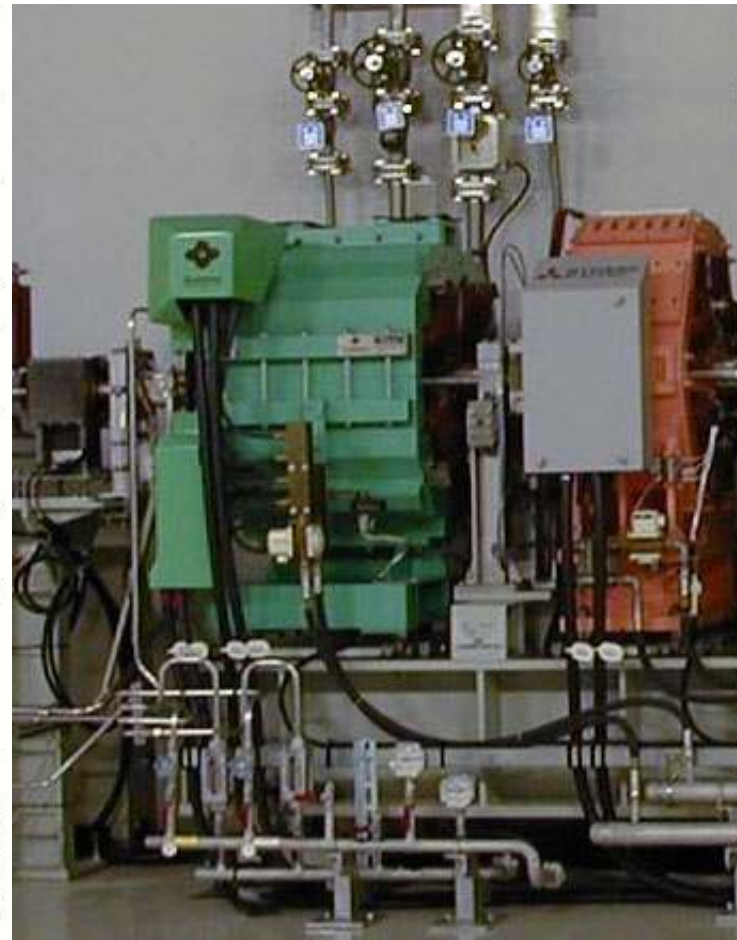
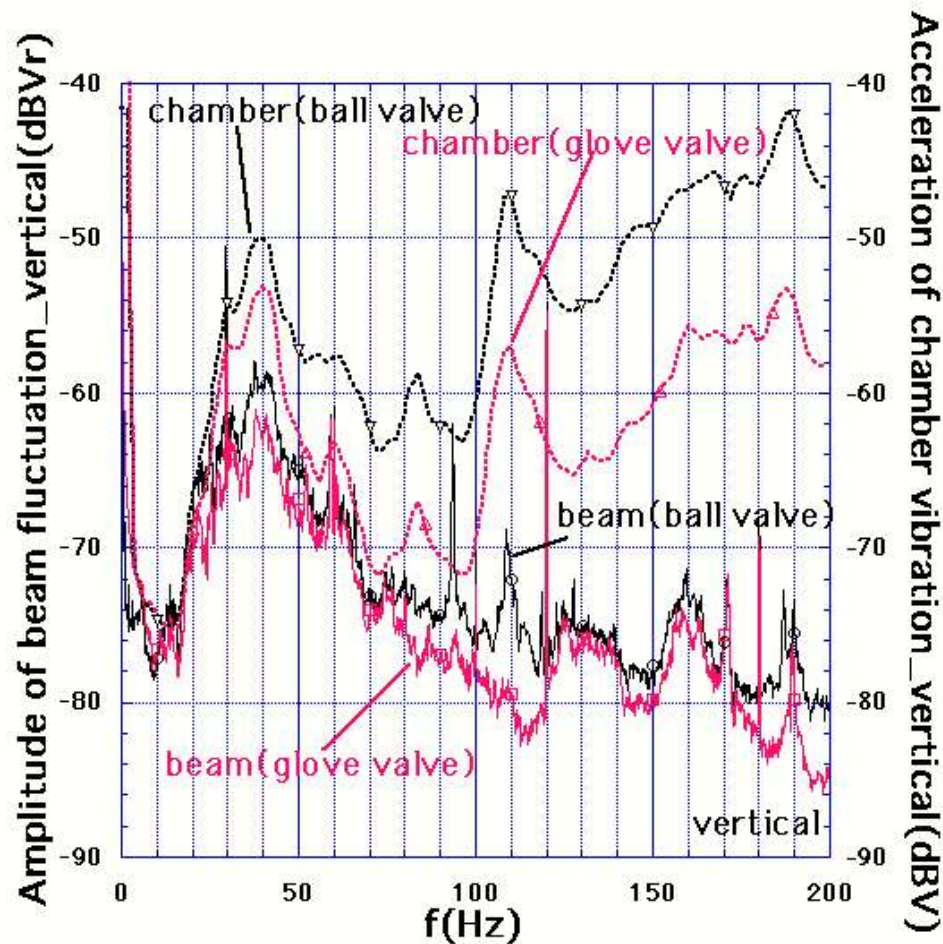

Beam fluctuation and chamber vibration

Before improvement, we confirmed experimentally that vibration of vacuum chambers was the cause of beam fluctuation.

Results of investigation

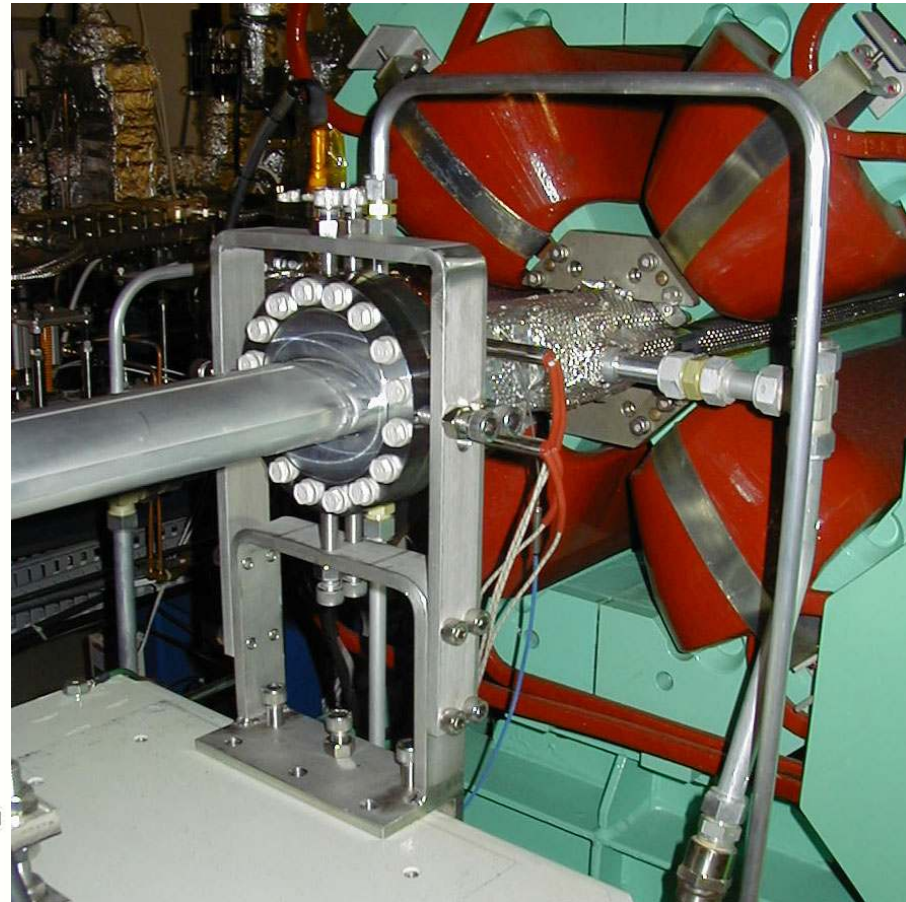
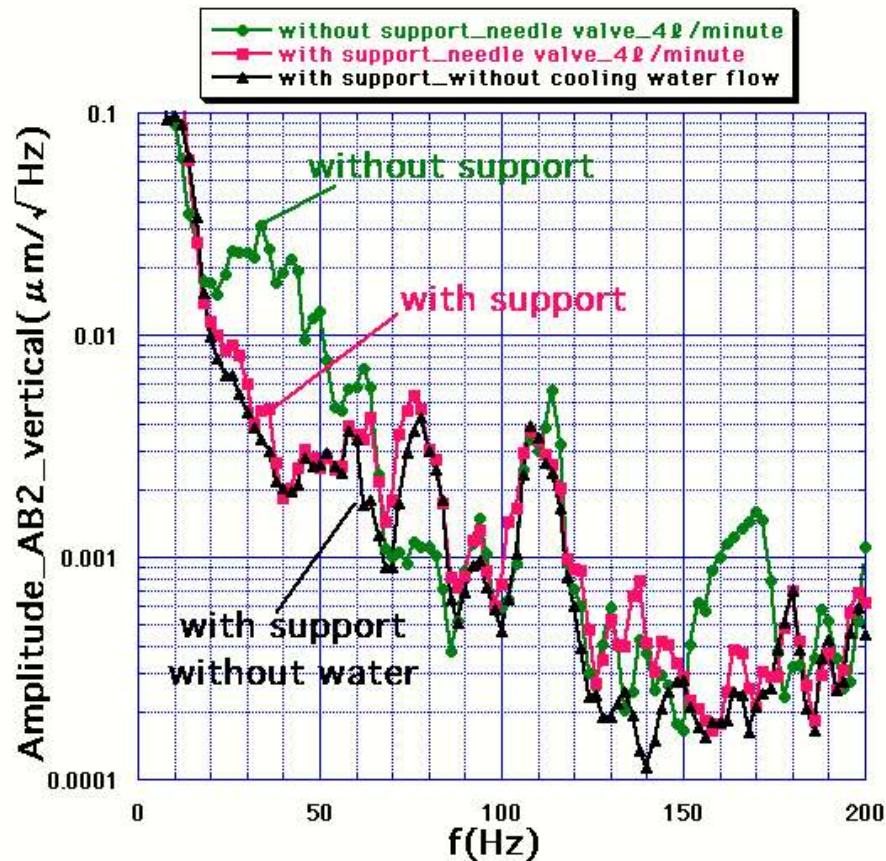

Effect of additional support

Additional support at AB2

We tried to add support device to the vacuum chamber at AB2. By addition of support, the vibration from 30Hz to 50Hz decreased. However, the vibration from 70Hz to 80Hz increased. This may be caused by change of eigen frequency.

Improvement

Reduction of cooling water flow rate, from 8 to 4 liter/minute

Flow rate of AB2 needed only 4 liter/minute, and AB1 needed 8 liter/minute.

We divided cooling water system of AB1 and AB2, and reduced flow rate of AB2 in half.

Changes from ball valve to needle valve.

Addition of support.

Results of improvement (Vertical)

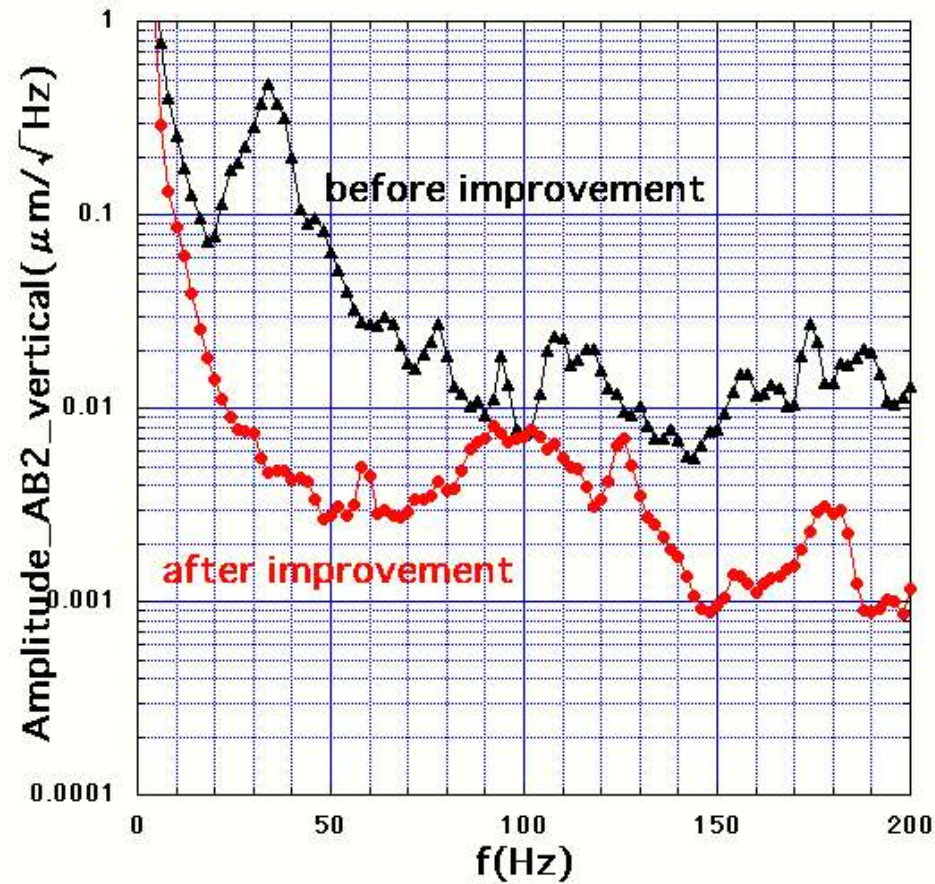

Vibration of vacuum chamber

Vertical

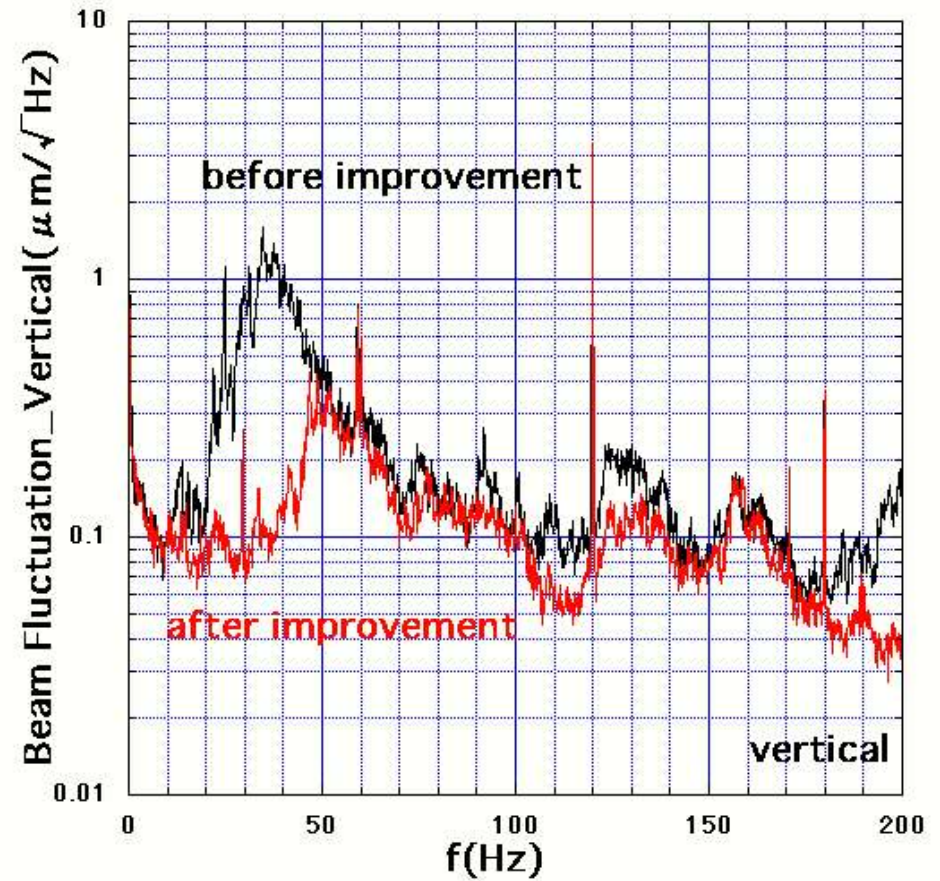

Fluctuation of electron beam

With both of them, the peak of around 40Hz disappeared

Results of improvement (Horizontal)

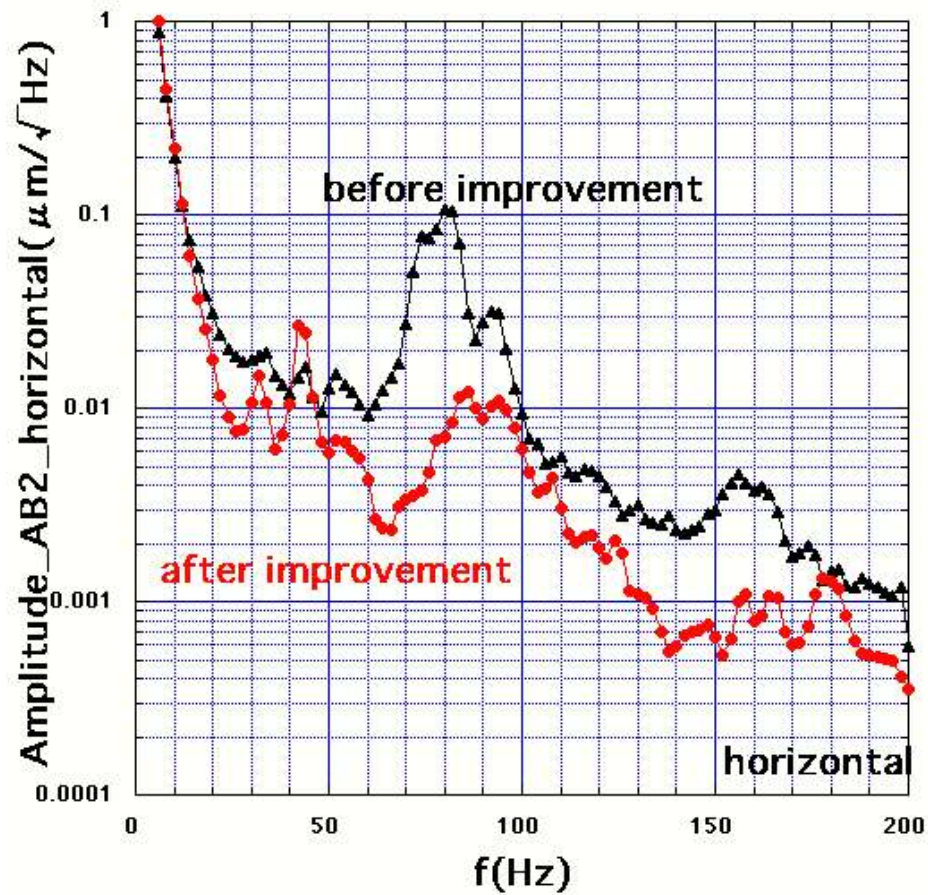

Vibration of vacuum chamber

Horizontal

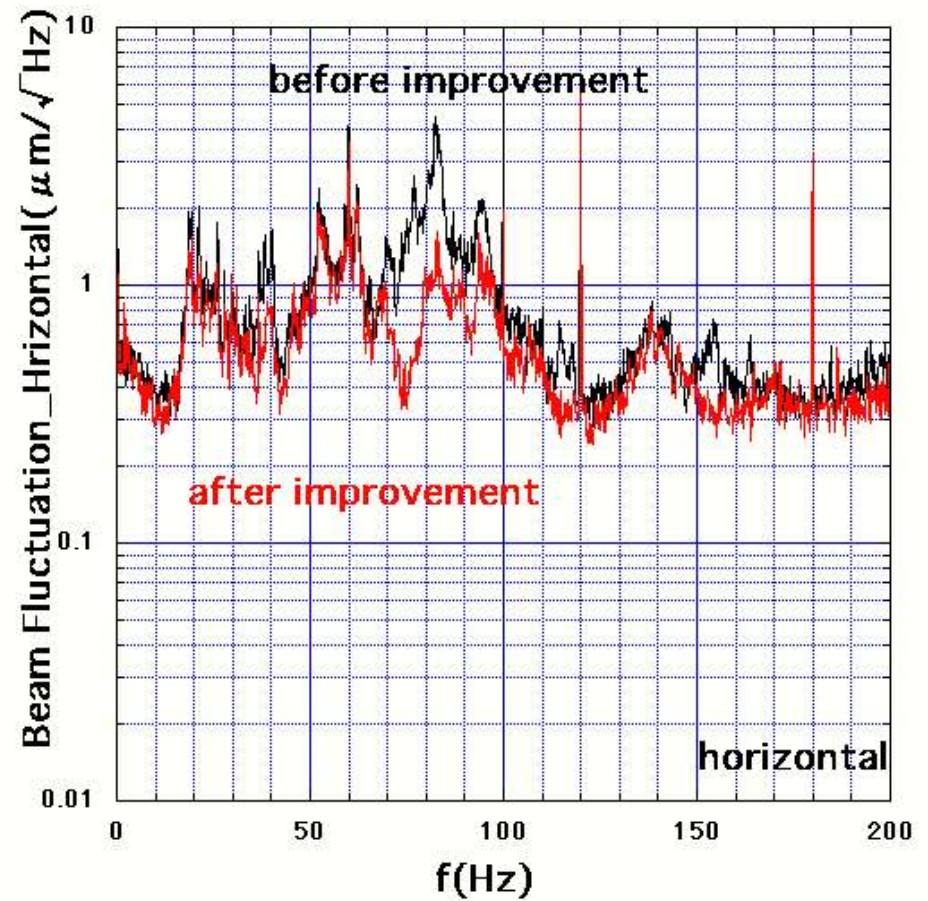

Fluctuation of electron beam

Vibration and Fluctuation from 70Hz to 100Hz decreased

Summary

We investigated the correlation between vibration of chamber and flow rate or valve shape.

And confirmed experimentally that vibration of vacuum chambers shaken by water flow was the cause of beam fluctuation.

We improved vibration of vacuum chamber,

Reduction of cooling water flow rate, from 8 to 4 liter/minute

Change flow control valves from ball valve to needle valve.

Addition of support.

and reduced orbit fluctuation of electron beam.

20~50Hz vertical direction : -20dBVr

70~100Hz horizontal direction : -10dBVr