

# *ortho*-Chelating Arenethiolatocopper(I) Complexes as Versatile Catalysts in the Regioselective Cross-Coupling of Allylic Derivatives with *n*BuMgI—An Example of Reversed Reactivity of Leaving Groups

Eva S. M. Persson, Mayra van Klaveren, David M. Grove, Jan E. Bäckvall,\* and Gerard van Koten\*

**Abstract:** The regioselectivity in the arenethiolatocopper(I)-catalyzed cross-coupling reaction of allylic substrates was studied. It was found that allylic acetates gave highly  $\gamma$ -selective reactions in Et<sub>2</sub>O at 0 °C with slow addition of the Grignard reagent, whereas  $\alpha$ -selective reactions were obtained in THF at –30 °C with fast addition of the Grignard reagent. It is proposed that the formation of an inter-

mediate in Et<sub>2</sub>O, in which the allylic acetate coordinates in a bidentate fashion to the arenethiolatocopper(I) catalyst, dra-

matically increases the reactivity of the leaving group and results in excellent  $\gamma$ -selectivity. The remarkable observation that an allylic acetate can be made more reactive than an allylic chloride by using the arenethiolatocopper(I) catalyst **1a** supports the theory of a bidentate coordination of the substrate to the catalyst through its double bond and acetate oxygen.

## Keywords

allylic substrates · carbon–carbon coupling · catalysis · copper compounds

## Introduction

Organocopper reagents generated in situ by transmetalation of an organometallic reagent with a copper salt<sup>[1]</sup> are of great importance in organic synthesis.<sup>[2]</sup> Often the copper salt can be employed in catalytic amounts, and the result is a copper(I)-catalyzed reaction between the substrate and the organometallic reagent. One such reaction, which has attracted considerable interest, is the cross-coupling between an allylic substrate and a Grignard reagent.<sup>[3–6]</sup> An important aspect of the latter reaction is the regioselectivity of carbon–carbon bond formation, that is, whether the organometallic reagent attacks  $\alpha$  (S<sub>N</sub>2) or  $\gamma$  (S<sub>N</sub>2') to the leaving group [Eq. (1)].

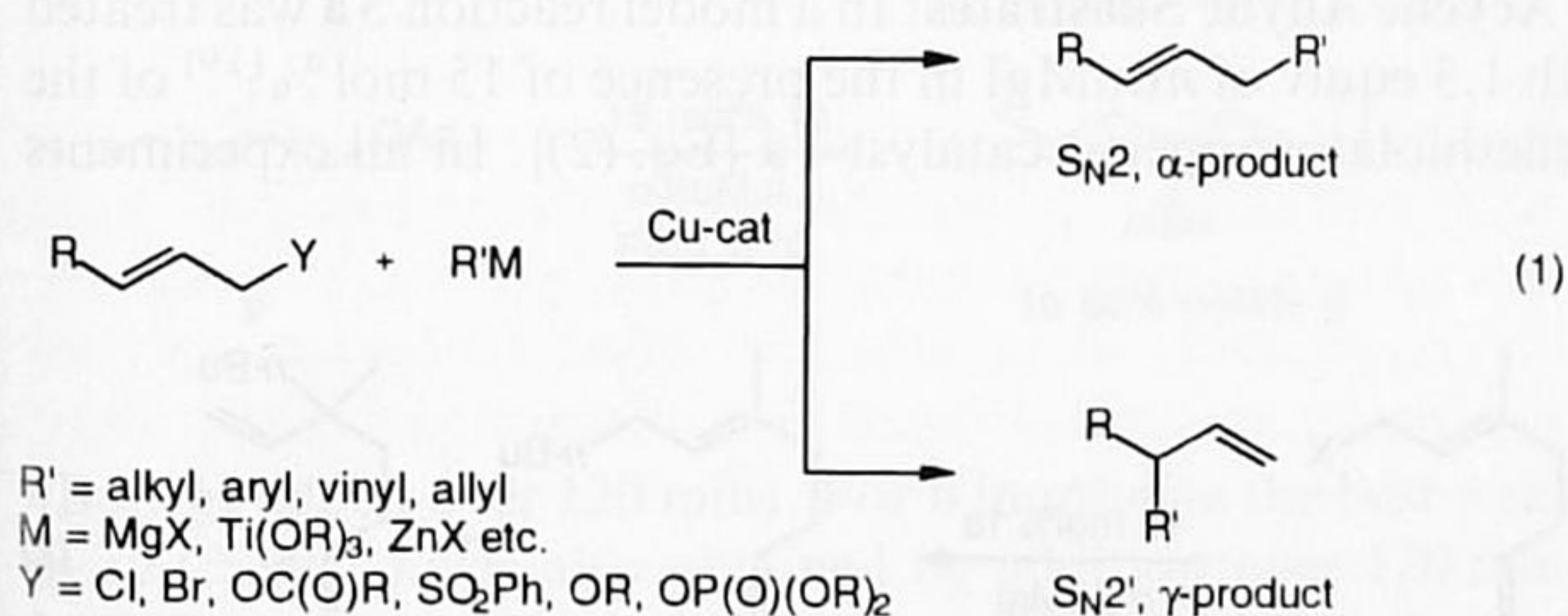

The mechanism for these copper-catalyzed cross-coupling reactions has been discussed in a number of reports.<sup>[4, 5, 7–10]</sup> A ( $\pi$ -allyl)copper intermediate has been proposed in the reaction of cyclohexenyl acetate with stoichiometric amounts of LiCuMe<sub>2</sub>.<sup>[7]</sup> This reaction is highly stereoselective and proceeds with >98% *anti* attack by the nucleophile on the allylic system, with respect to the leaving group.<sup>[8b]</sup> The commonly accepted mechanism for the cross-coupling of allylic substrates involves formation of an allylcopper(III) species. Furthermore, a qualitative molecular orbital interpretation points to an *anti* S<sub>N</sub>2' oxidative addition.<sup>[9]</sup>

The stereo- and regiochemistry of the product is established at different points in the reaction process (Scheme 1).<sup>[8]</sup> Coordination of the double bond to the cuprate followed by *anti* elimination of the leaving group Y<sup>–</sup> results in an *anti* S<sub>N</sub>2' oxidative addition to form a ( $\sigma$ -allyl)copper(III) complex **A**.<sup>[5a, 8b, 9]</sup> The  $\sigma$ -allyl complex **A** formed can then undergo reductive elimination to the  $\gamma$ -product or isomerize to the ( $\sigma$ -allyl)copper(III) species **C**. This isomerization proceeds via a transient ( $\pi$ -allyl)copper(III) intermediate **B**. Thus, the regioselectivity is thought to depend on the relative rates of reductive elimination from the ( $\sigma$ -allyl)copper(III) complex **A** and isomerization to  $\sigma$ -allyl complex **C** with subsequent reductive elimination. The nature of ligand X<sup>–</sup> has a profound influence on the regiochemical outcome of the reaction. When X<sup>–</sup> is electron withdrawing (e.g., CN<sup>–</sup> or Cl<sup>–</sup>) reductive elimination is fast relative to isomerization and hence regioselective  $\gamma$ -substitution is observed.<sup>[5a, 8, 11]</sup> However, if X<sup>–</sup> is an alkyl group,<sup>[12]</sup> isomerization predominates over reductive elimination, and the isomerization between **A** and **C** must therefore be rapid. The product obtained in this case depends on the substitution of the allyl group. For allyl compounds that are substituted at only one

[1] Prof. J. E. Bäckvall, E. S. M. Persson  
Department of Organic Chemistry, University of Uppsala  
Box 531, S-751 21 Uppsala (Sweden)  
Telefax: Int. code + (18) 508-542  
Prof. G. van Koten, M. van Klaveren, Dr. D. M. Grove  
Debye Institute, Utrecht University  
Padualaan 8, 3584 CH Utrecht (The Netherlands)  
Telefax: Int. code (30) 523-615

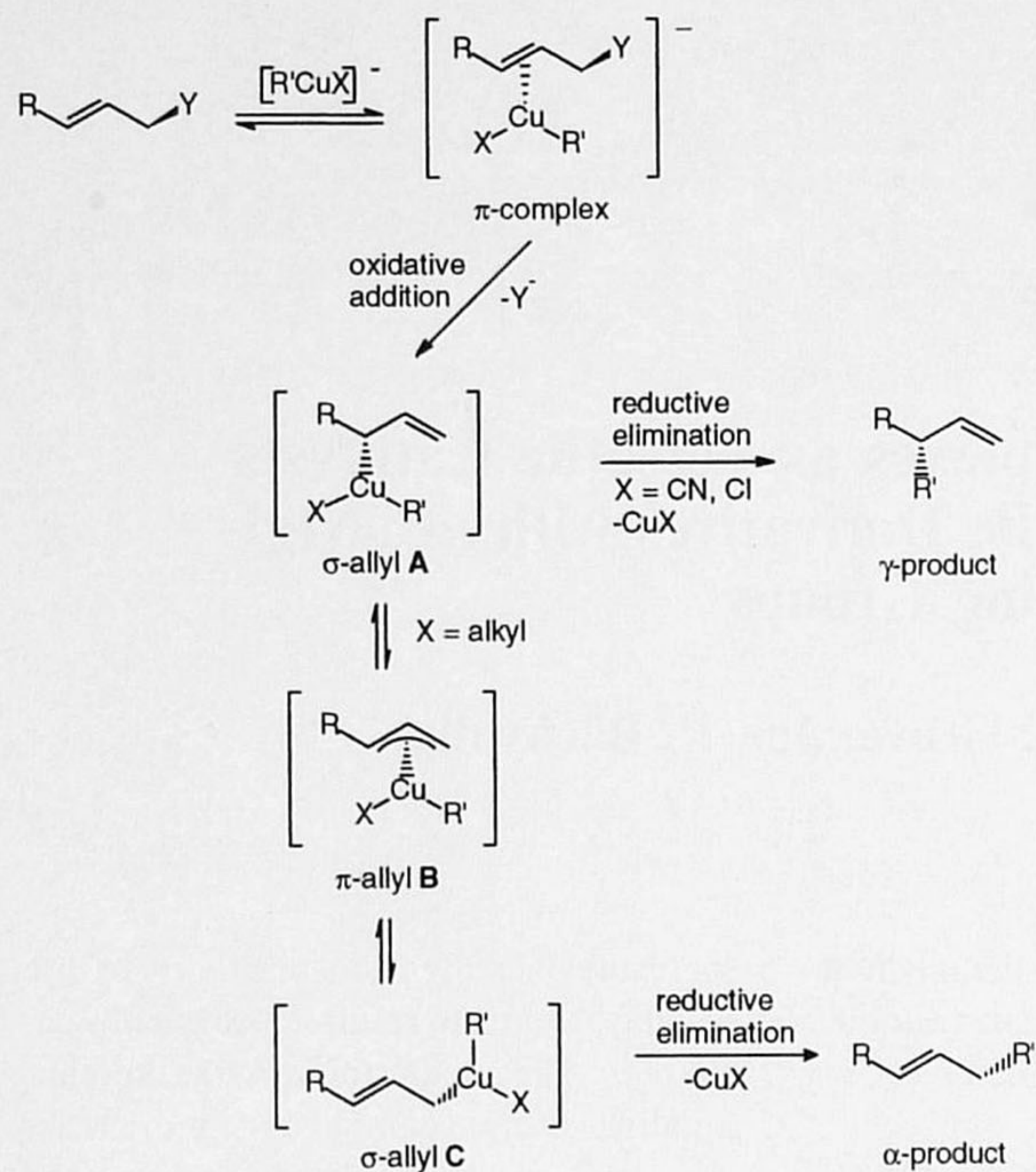

Scheme 1.

terminus, the  $\alpha$ -product arising from preferential coupling at the primary allyl carbon is obtained exclusively (Scheme 1). When both termini are substituted, a mixture of products is formed arising from nonpreferential coupling at both termini. As indicated in Scheme 1, reductive elimination from the  $\sigma$ -allyl intermediate is stereospecific and occurs with retention of configuration.<sup>[13]</sup>

In previous studies, methods for controlling the regioselectivity in copper-catalyzed cross-couplings between allylic substrates and Grignard reagents have been developed.<sup>[5]</sup> In a preliminary report,<sup>[14]</sup> we have explored the use of the arenethiolatocopper(I) catalyst **1a** and related catalysts **1b–d**

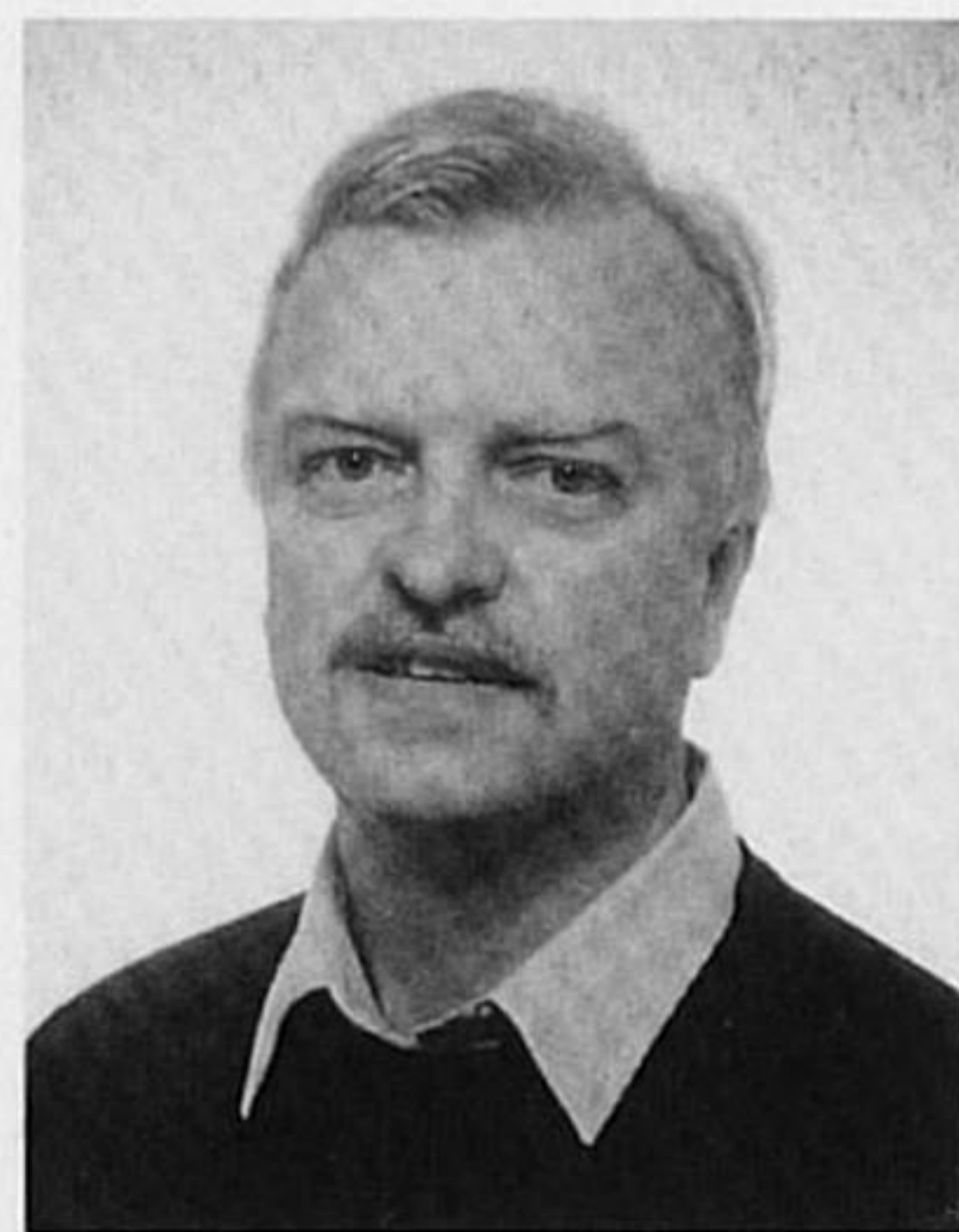

**Editorial Board Member:**<sup>[\*]</sup> Jan-Erling Bäckvall was born in Malung, Sweden, in 1947. He received his Ph.D from the Royal Institute of Technology, Stockholm, in 1975 under the guidance of Prof. B. Åkermark. After postdoctoral work (1975–76) with Prof. K. B. Sharpless at Massachusetts Institute of Technology he joined the faculty at the Royal Institute of Technology. He was appointed full professor of organic chemistry at

Uppsala University in 1986. His current research interests include mechanistic studies of organometallic reactions, the use of transition metals as catalysts in organic synthesis and development of new synthetic methods.

[\*] Members of the Editorial Board will be introduced to the readers with their first manuscript.

(Fig. 1)<sup>[15,16]</sup> for the regio- and stereoselective alkylation of acyclic allylic acetates with *n*BuMgI. Each of these arenethiolatocopper(I) catalysts differ in the flexibility of the hydrocarbon skeleton connecting the S- and N-donor atoms and in the donor ability of the S- and N-binding sites. In this paper we give a full account of the arenethiolatocopper(I)-catalyzed cross-coupling

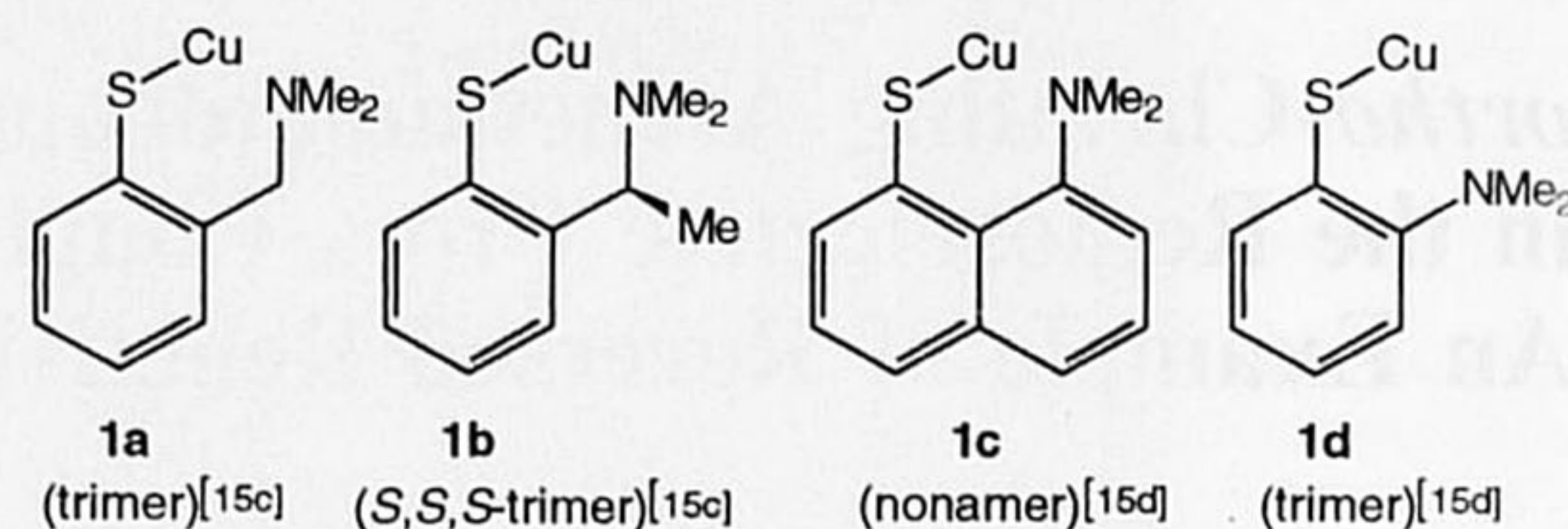
Fig. 1. The arenethiolatocopper(I) catalysts **1a–d**.

reaction, report additional results for a cyclic allylic substrate, and discuss the mechanism involved in these reactions. A remarkable observation is that the allylic acetoxy group can be made more reactive than the allylic chloro group in *cis*-1-acetoxy-4-chloro-2-cyclohexene (**2**) by using the arenethiolatocopper(I) catalyst **1a**. A reversed selectivity of this type is unprecedented in metal-catalyzed allylic substitution.

The arenethiolatocopper(I) catalyst **1b** has been used in the enantioselective Michael addition of MeMgI to acyclic<sup>[16]</sup> and cyclic enones,<sup>[16,17]</sup> and in 1,6-addition reactions of organolithium reagents to enynes.<sup>[18]</sup> It should be noted that the choice of organometallic reagent (magnesium or lithium reagents) in these reactions is crucial; this illustrates the different influences of the cation combinations (e.g., Cu/Li and Cu/MgX).<sup>[16,18]</sup>

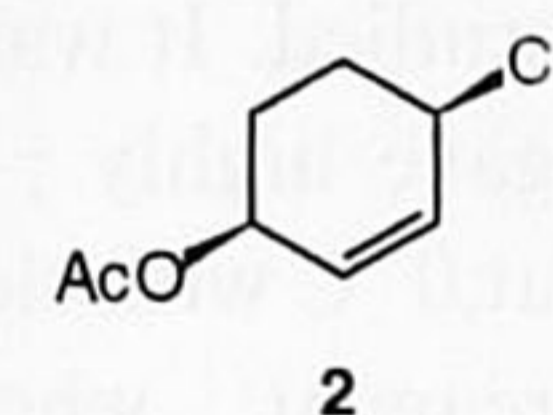

## Results and Discussion

The acyclic substrates chosen for the present study were geranyl acetate (**3a**), geranyl chloride (**3b**), (*E*)-1-acetoxy-4-phenoxy-2-butene (**6**), and (*E*)-2-hexene-1-yl-acetate (**9**) (Sections 1 and 2). In order to investigate the chemoselectivity (chloride vs. acetate as leaving group) a cyclic substrate, *cis*-1-acetoxy-4-chloro-2-cyclohexene (**2**), was chosen (Sections 3 and 4). The arenethiolatocopper(I) catalysts **1a–d** were synthesized as previously described.<sup>[15c,d]</sup>

**1. Acyclic Allylic Substrates:** In a model reaction **3a** was treated with 1.3 equiv of *n*BuMgI in the presence of 15 mol%<sup>[19]</sup> of the arenethiolatocopper(I) catalyst **1a** [Eq. (2)]. In all experiments

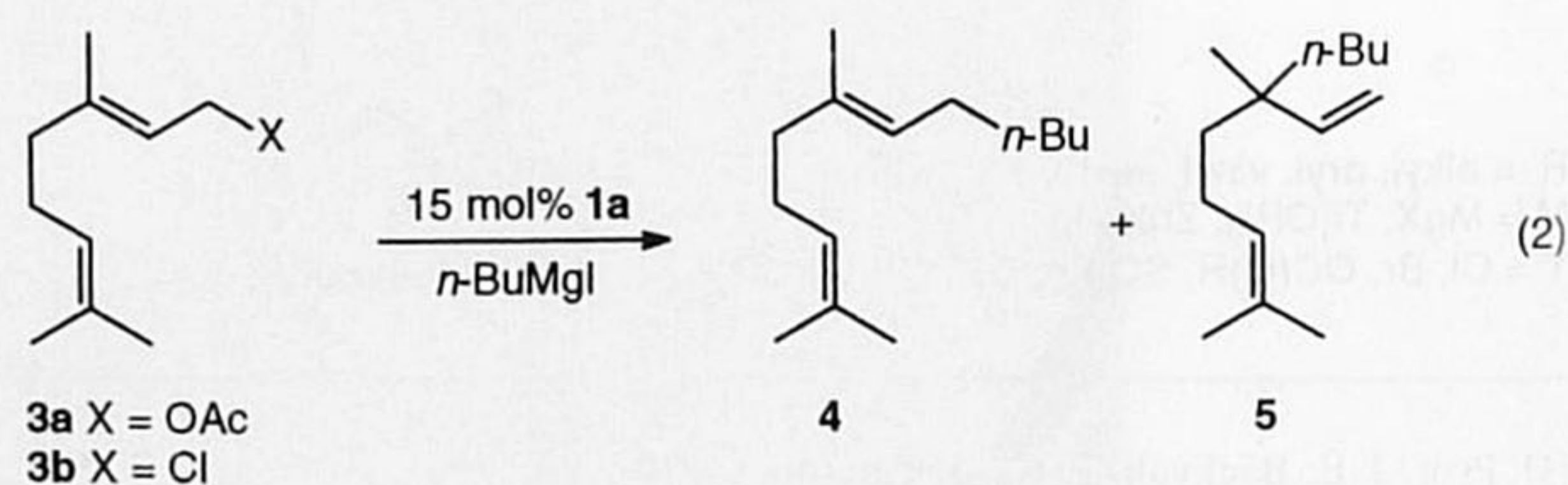

the same concentrations of substrate and Grignard reagents were used. The isolated yields of **4** and **5** were in the range of 65 to 85%, and an internal standard, *n*-dodecane, was used to determine the GC yields, which in most cases were close to

100%. The influence of the temperature and addition rate of the Grignard reagent, the solvent, the leaving group, the type of copper(I) catalyst, and the amount of arenethiolatocopper(I) catalyst on the course of the cross-coupling reaction was investigated (Sections 1.1–1.5, respectively).

**1.1. Effect of Temperature and of Addition Rate of the Grignard Reagent** (see Table 1): The acetate **3a** was treated with *n*BuMgI in the presence of 15 mol%<sup>[19]</sup> of the arenethiolatocopper(I) catalyst **1a**. When the Grignard reagent was added over 5 min

Table 1. Effect of temperature and addition rate of the Grignard reagent in Et<sub>2</sub>O, toluene, and THF [a].

Entry	Substrate	Solvent	T/°C	t/min [b]	Product distribution [b]	
					α	γ
1	<b>3a</b>	Et <sub>2</sub> O	−30	5	11	89 [c]
2	<b>3a</b>	Et <sub>2</sub> O	0	5	8	92 [c]
3	<b>3a</b>	Et <sub>2</sub> O	0	120	<1	>99 [c]
4	<b>6</b>	Et <sub>2</sub> O	0	120	<1	>99 [d]
5	<b>9</b>	Et <sub>2</sub> O	0	120	<1	>99 [c]
6	<b>6</b>	toluene	0	120	<1	>99 [d]
7	<b>6</b>	toluene	0	5	4	96 [d]
8	<b>6</b>	toluene	−30	5	5	95 [d]
9	<b>6</b>	THF	0	5	67	33 [d]
10	<b>6</b>	THF	−30	5	94	6 [d]
11	<b>3a</b>	THF	0	120	86	14 [c]
12	<b>3a</b>	THF	−30	5	>99	<1 [c]

[a] The reaction was performed by adding the Grignard reagent to a homogeneous solution of the substrate and the catalyst **1a** (15 mol%) [19]. Isolated yields: 65–85%; GC yields: 100%. [b] Determined by <sup>1</sup>H NMR and capillary GC. [c] **4**:**5**. [d] **7**:**8**. [e] Only  $\gamma$ -substituted product **10** was observed.

to the reaction mixture in Et<sub>2</sub>O at −30 °C, the  $\alpha$ - and  $\gamma$ -substituted products **4** and **5** were formed in a ratio of 11:89 (Table 1, Entry 1). At 0 °C an  $\alpha$ : $\gamma$  ratio of 8:92 was obtained (Entry 2). When the addition time was also increased (120 min), the  $\gamma$ -substituted product **4** was formed exclusively (Entry 3). Excellent  $\gamma$ -selectivity was also obtained for acetates **6** (Entry 4) [Eq. (3)] and **9** (Entry 5) [Eq. (4)] under these conditions (Et<sub>2</sub>O, 0 °C,

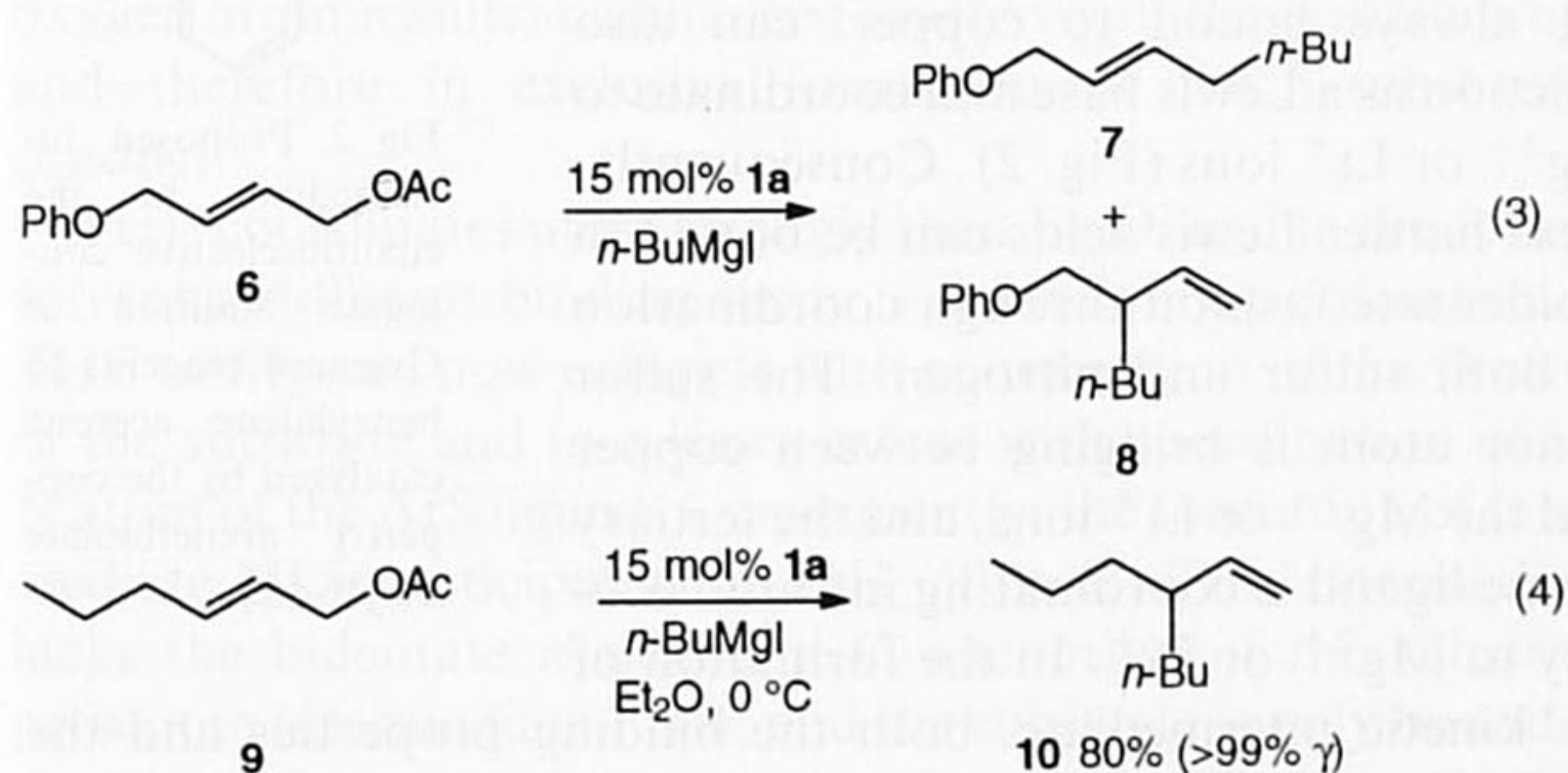

*n*BuMgI added over 120 min). For **6** in toluene the best  $\gamma$ -selectivity (>99%) was also obtained by addition over 120 min at 0 °C (Entry 6). A short addition time (5 min) slightly decreased the  $\gamma$ -selectivity (Entry 7); lowering the temperature at an addition time of 5 min did not affect the  $\alpha$ : $\gamma$  ratio any further (Entry 8).

In THF preferential  $\alpha$ -substitution was observed (vide infra) and the regioselectivity was more sensitive to variations in temperature. Exclusive  $\alpha$ -selectivity (>99%) was obtained with acetate **3a** at −30 °C with rapid addition of the Grignard reagent (Entry 12), and a slightly lower  $\alpha$ -selectivity was obtained with

**6** under the same reaction conditions (Entry 9).<sup>[20]</sup> At a higher temperature (0 °C) the regioselectivity for acetate **6** decreased, and a mixture of regioisomers **7**:**8** in a 67:33 ratio was obtained (Entry 9). A similar result was observed with acetate **3a** at a higher temperature and with a longer addition time (Entry 11). This is consistent with previous results, obtained by Bäckvall et al., that longer addition times for the Grignard reagent and higher reaction temperatures favor  $\gamma$ -substitution for reactions performed in THF.<sup>[5a]</sup>

**1.2. Solvent Effects** (see Table 2): The regioselectivity in the arenethiolatocopper(I)-catalyzed cross-coupling reaction of acetate **3a** with *n*BuMgI in the presence of 15 mol%<sup>[19]</sup> of **1a** was dramatically affected by the solvent. Reactions performed in Et<sub>2</sub>O at −30 °C with an addition time of the Grignard reagent

Table 2. Solvent effect on the arenethiolatocopper(I)-catalyzed cross-coupling reaction of **3a** with *n*BuMgI [a].

Entry	Solvent	T/°C	t/min [b]	Product distribution/% [c]	
				<b>4</b>	<b>5</b>
1	Et <sub>2</sub> O	0	120	<1	>99
2	Et <sub>2</sub> O	−30	5	11	89
3	Et <sub>2</sub> O/THF (9:1) [d]	−30	5	>99	<1
4	THF	−30	5	>99	<1

[a] The reaction was performed by adding the Grignard reagent to a homogeneous solution of **3a** and the catalyst **1a** (15 mol%) [19]. Isolated yields: 65–85%; GC yields: 100%. [b] Addition time of the Grignard reagent. [c] Determined by capillary GC. [d] The ratio of THF:**1a** = 1000:1.

of 5 min gave selectively the  $\gamma$ -substituted product **5** in a ratio of 11:89 (Table 2, Entry 2). In THF (Entry 4) a dramatic change in regioselectivity took place and only  $\alpha$ -substitution was observed. The same excellent  $\alpha$ -selectivity was obtained in a mixture of Et<sub>2</sub>O and THF (Et<sub>2</sub>O:THF = 9:1, THF:**1a** = 1000:1) (Entry 3). Addition of only one equivalent of THF relative to the amount of catalyst did not lead to any significant change in the regioselectivity compared to that observed in pure Et<sub>2</sub>O. Exclusive formation of the  $\gamma$ -product was obtained in Et<sub>2</sub>O at 0 °C with a longer addition time of the Grignard reagent (Entry 1). The same solvent effect was observed for acetate **6** [Eq. (3)]: Reactions performed in weakly coordinating solvents such as Et<sub>2</sub>O or toluene gave the  $\gamma$ -substituted product **8** exclusively (Table 1, Entries 4 and 6), whereas reactions performed in THF yielded the  $\alpha$ -product **7** regioselectively (Entry 10).

A coordinating solvent, such as THF, therefore affords mainly  $\alpha$ -substituted products **4** or **7**, whereas a less coordinating solvent, such as Et<sub>2</sub>O or toluene, gives the  $\gamma$ -substituted products **5** or **8**. This solvent effect has been reported previously by Bäckvall et al.<sup>[5a]</sup> who observed that the CuCN-catalyzed (10 mol%) reaction of geranyl acetate **3a** with *n*BuMgBr gave 94%  $\alpha$ -substituted product **4** in THF at 0 °C and 97%  $\gamma$ -substituted product **5** in Et<sub>2</sub>O at 20 °C. Calò et al. observed a similar solvent effect in the stoichiometric CuI-promoted reaction of primary allylic benzothiazole-2-thiol with *n*BuMgBr at −30 °C, which gave 95%  $\alpha$ -substitution in THF:Et<sub>2</sub>O (2:1) but 95–97%  $\gamma$ -substitution in Et<sub>2</sub>O.<sup>[3c]</sup>

**1.3. Effect of Different Leaving Groups** (see Table 3): The leaving group also has an influence on the regioselectivity of the arenethiolatocopper(I)-catalyzed cross-coupling reaction. Reaction conditions favoring formation of the  $\gamma$ -substituted product from the allylic acetate **3a** (Table 3, Entry 1) also gave regioselective  $\gamma$ -substitution with the allylic chloride **3b** (Entry 2).

Table 3. Effect of leaving group in the arenethiolatocopper(I)-catalyzed cross-coupling reaction of **3** with *n*BuMgI [a].

Entry	Substrate (LG) [b]	Solvent	<i>t</i> /min [c]	<i>T</i> /°C	Product distribution/% [d]	
					<b>4</b>	<b>5</b>
1	<b>3a</b> (OAc)	Et <sub>2</sub> O	120	0	<1	>99
2	<b>3b</b> (Cl)	Et <sub>2</sub> O	120	0	5	95
3	<b>3b</b> (Cl)	THF	120	0	25	75
4	<b>3a</b> (OAc)	THF	5	-30	>99	<1
5	<b>3b</b> (Cl)	THF	5	-30	38	62

[a] The reaction was performed by adding the Grignard reagent to a homogeneous solution of **3** and the catalyst **1a** (15 mol%) [19]. Isolated yields: 65–85%. [b] LG = leaving group. [c] Addition time of the Grignard reagent. [d] Determined by capillary GC.

When the solvent was changed to THF,  $\gamma$ -selectivity was still observed for **3b**, although not as high (Entry 3). Under conditions favoring formation of the  $\alpha$ -substituted product with acetate **3a** in THF, the difference in product distribution between **3a** and **3b** was more pronounced (Entries 4 and 5). The allylic acetate **3a** yielded the  $\alpha$ -substituted product regioselectively, while the allylic chloride **3b** gave an  $\alpha$ : $\gamma$  ratio of 38:62. The effect of temperature on regioselectivity for **3b** in THF is consistent with previous results (Entries 3 and 5).<sup>[5a]</sup>

**1.4. Effect of Different Copper(I) Catalysts** (see Table 4): The copper-catalyzed reaction of **3a** with *n*BuMgI was carried out in the presence of a number of other copper catalysts under conditions favoring  $\gamma$ -substitution (i.e., Et<sub>2</sub>O, 0 °C, *n*BuMgI added

Table 4. The effect of the copper(I) catalyst on the regioselectivity in cross-coupling of **3a** with *n*BuMgI [a].

Entry	Catalyst [b]	Product distribution/% [c]		GC yield/% [d]
		<b>4</b>	<b>5</b>	
1	<b>1a</b>	<1	>99	100
2	<b>1b</b>	<1	>99	100
3	<b>1c</b>	2	98	100
4	<b>1d</b>	28	72	75 [e]
5	PhSCu	21	79	96
6	PhSCu·LiI	20	80	98
7	Li <sub>2</sub> CuCl <sub>4</sub> [f]	>99	<1	86

[a] The reaction was performed by adding the Grignard reagent over a period of 120 min to a homogeneous solution of **3a** and the catalyst in Et<sub>2</sub>O at 0 °C. [b] 15 mol% unless otherwise noted [19]. [c] Determined by capillary GC. [d] GC yield of the  $\alpha$ - and  $\gamma$ -products determined with *n*-dodecane as internal standard; the remaining material is unreacted **3a** unless otherwise stated. [e] The remaining material is geraniol. [f] 6 mol%.

over a period of 120 min). Copper(I) arenethiolates **1a–c**<sup>[21]</sup> afforded the  $\gamma$ -substituted product in high regioselectivity (98–>99%  $\gamma$ -substitution, Entries 1–3). However, with the copper(I) arenethiolate catalyst **1d** an  $\alpha$ : $\gamma$  ratio of only 28:72 was obtained (Table 4, Entry 4) and formation of geraniol was observed (25%), formed by attack of the Grignard reagent at the carbonyl group of the allylic acetate [Eq. (5)].

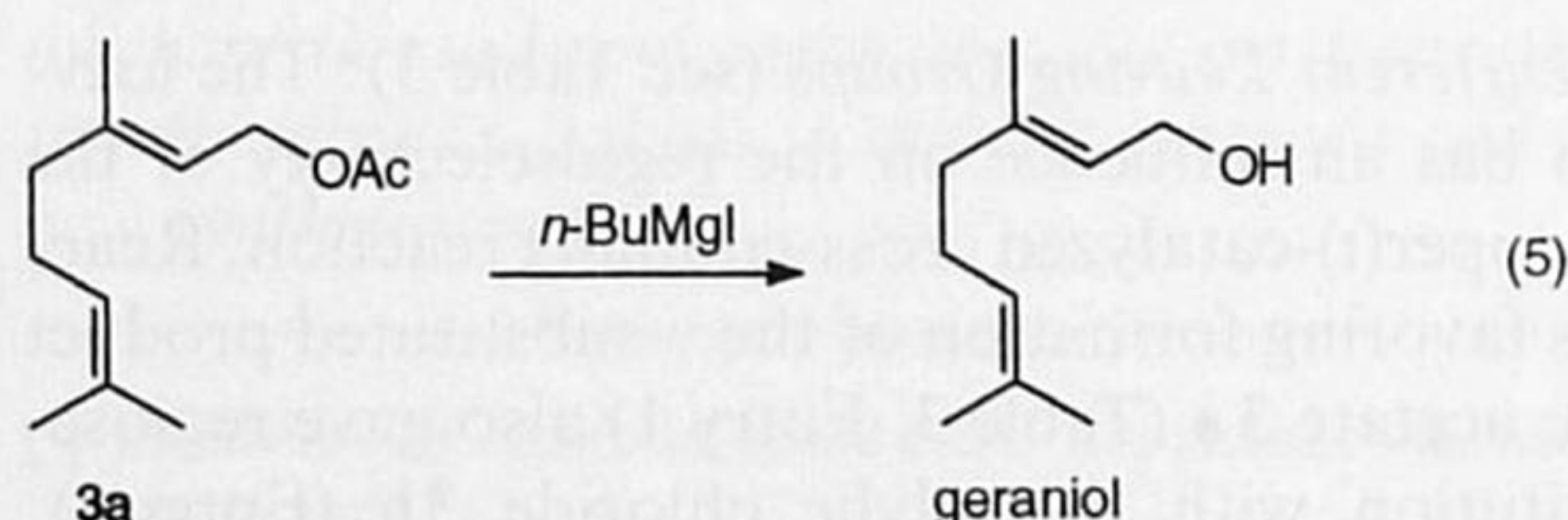

Thiophenolacopper(I) (CuSPh) was used to investigate the influence of the *ortho*-nitrogen substituent in the catalysts **1a–d** on the regioselectivity in the cross-coupling reaction. Both PhSCu and PhSCu·LiI (prepared in situ) gave similar  $\alpha$ : $\gamma$  ratios (21:79 (Entry 5) and 20:80 (Entry 6), respectively). The results shown in Entries 4–6 nicely demonstrate that at least two requirements have to be fulfilled for the  $\gamma$ -selectivity of this reaction to be high: 1) an intramolecular nitrogen ligand has to be present and 2) S,N-chelation as well as the chelate ring size play a crucial role. Finally, the ratios obtained with amine-free catalysts PhSCu and PhSCu·LiI are in agreement with the  $\alpha$ : $\gamma$  ratio of 25:75 reported by Rudler et al. for the stoichiometric reaction of geranyl acetate and MeCu(SPh)Li in Et<sub>2</sub>O at -10 °C.<sup>[4c]</sup> Dilithium tetrachlorocuprate (Li<sub>2</sub>CuCl<sub>4</sub>)<sup>[22]</sup> in Et<sub>2</sub>O yielded exclusively the  $\alpha$ -substituted product **4** (Entry 7), in contrast to the highly selective formation of the  $\gamma$ -product with arenethiolatocopper(I) catalysts **1a–c**.

**1.5. Amount of Catalyst:** The reaction of **3a** with *n*BuMgI in Et<sub>2</sub>O catalyzed by 15 mol%<sup>[19]</sup> of **1a** gave highly regioselective  $\gamma$ -substitution (>99%) under the reaction conditions used (0 °C, *n*BuMgI added over 120 min). The amount of **1a** can be reduced to 4.5 mol%<sup>[19]</sup> without affecting the  $\gamma$ -regioselectivity. A control experiment performed without catalyst gave only 17% of substitution products **4** and **5** ( $\alpha$ : $\gamma$  = 71:29) together with 17% geraniol [Eq. (5)]. The remaining 66% was recovered starting material **3a**; this shows that the presence of the arenethiolatocopper(I) is necessary for efficient cross-coupling.

## 2. Mechanistic Aspects of the Cross-Coupling with Acyclic Allylic Substrates:

Recently, van Koten et al. proposed a mechanism for the enantioselective conjugate addition of Grignard reagents to benzylidene acetone catalyzed by the chiral copper(I) arenethiolate catalyst **1b** used in the present study.<sup>[16d,e]</sup> Although the kinetic intermediates in the reaction have not been detected so far, the following conclusions have been drawn: Firstly, the *ortho*-substituted tertiary amino arenethiolate anion (ArS<sup>-</sup>) has excellent properties as a nontransferable group in cuprate chemistry. Secondly, the sulfur donor atom, being always bound to copper, can also function as a Lewis base and coordinate to Mg<sup>2+</sup> or Li<sup>+</sup> ions (Fig. 2). Consequently, these harder Lewis acids can be bound in a bidentate fashion through coordination to both sulfur and nitrogen. The sulfur donor atom is bridging between copper and the Mg<sup>2+</sup> or Li<sup>+</sup> ions, and the tertiary amine ligand is coordinating intramolecularly to Mg<sup>2+</sup> or Li<sup>+</sup>. In the formation of the kinetic intermediate, both the binding properties and the steric requirements of the substrate play a crucial role. In both benzylidene acetone and the allylic carboxylates of the present study, the substrate contains an alkene functionality that can form a  $\pi$ -bond to Cu(I) as well as an oxygen donor site that will bind preferentially to Mg<sup>2+</sup> (or Li<sup>+</sup>).<sup>[23]</sup> In solution the CuMg-(SAr)BuI system consists of aggregated species similar to [Cu(mesityl)]<sub>4</sub>[Mg(SAr)<sub>2</sub>]<sub>2</sub> shown schematically in Fig. 3.<sup>[16c]</sup> The substrate causes these aggregated species to reassemble by acting as a ligand that donates two

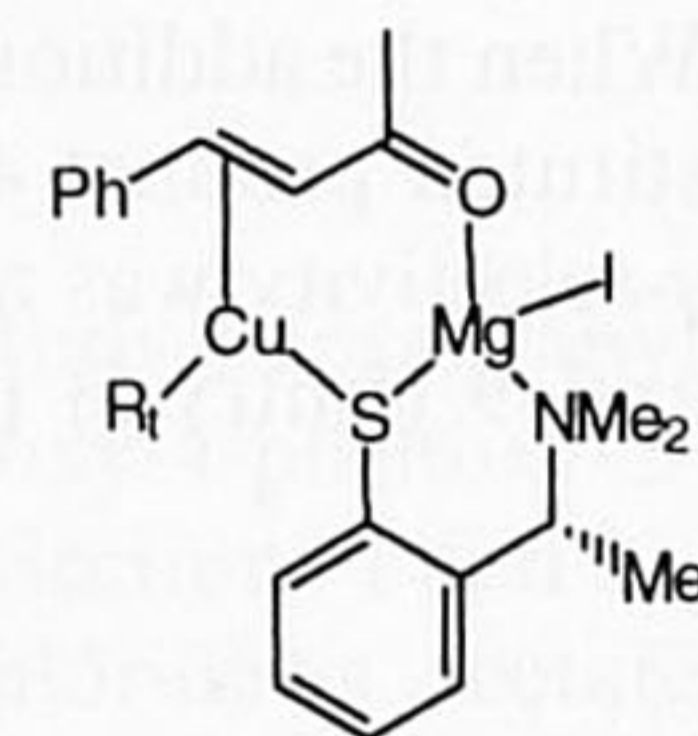

Fig. 2. Proposed intermediate in the enantioselective conjugate addition of Grignard reagents to benzylidene acetone catalyzed by the copper(I) arenethiolate **1b** [16d,e].

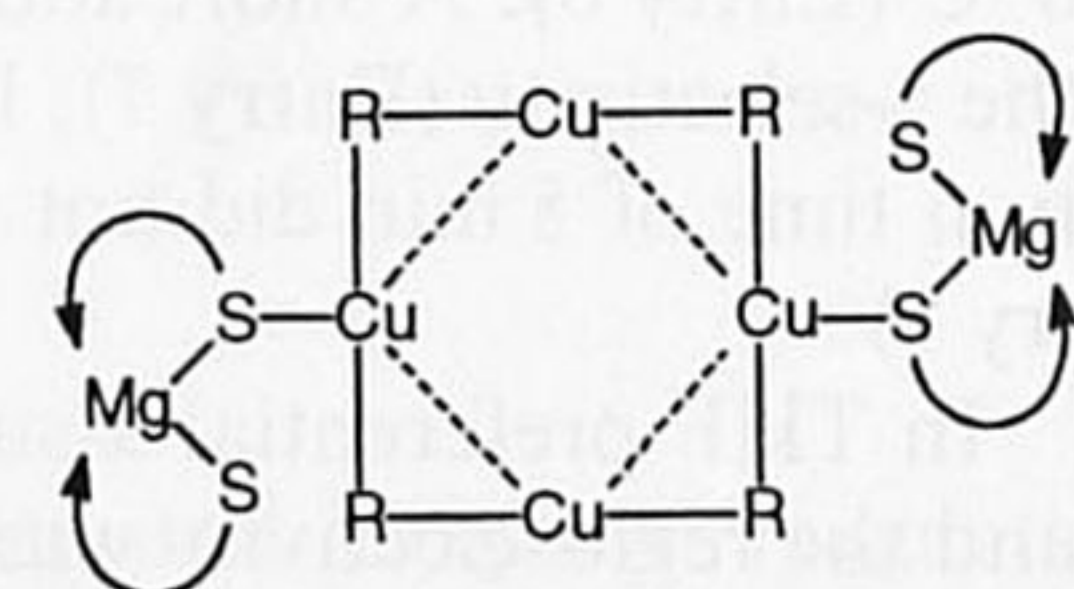

Fig. 3. A schematic representation of [CuMesityl]<sub>4</sub>[Mg(SAr)<sub>2</sub>]<sub>2</sub> (see ref. [16c] for the X-ray data).

(through the alkene) or four (through the alkene and carbonyl oxygen) electrons.

In our proposed mechanism for the arenethiolatocopper(I)-catalyzed cross-coupling reaction, we assume that essentially the same ( $\pi$ -alkene)cuprate and ( $\sigma$ -allyl)copper(III) intermediates are present as suggested previously (see Scheme 1; in our study, X = ArS ligand).<sup>[4, 5, 8, 9]</sup> However, the role of the magnesium ion in determining the regioselectivity of the cross-coupling reaction can now be further explored, an aspect that has not been considered in earlier discussions.

In a weakly coordinating solvent, like Et<sub>2</sub>O or toluene, the high  $\gamma$ -regioselectivity can be explained by initial formation of key intermediates **I** or **II** (Fig. 4). The reacting allylic acetate

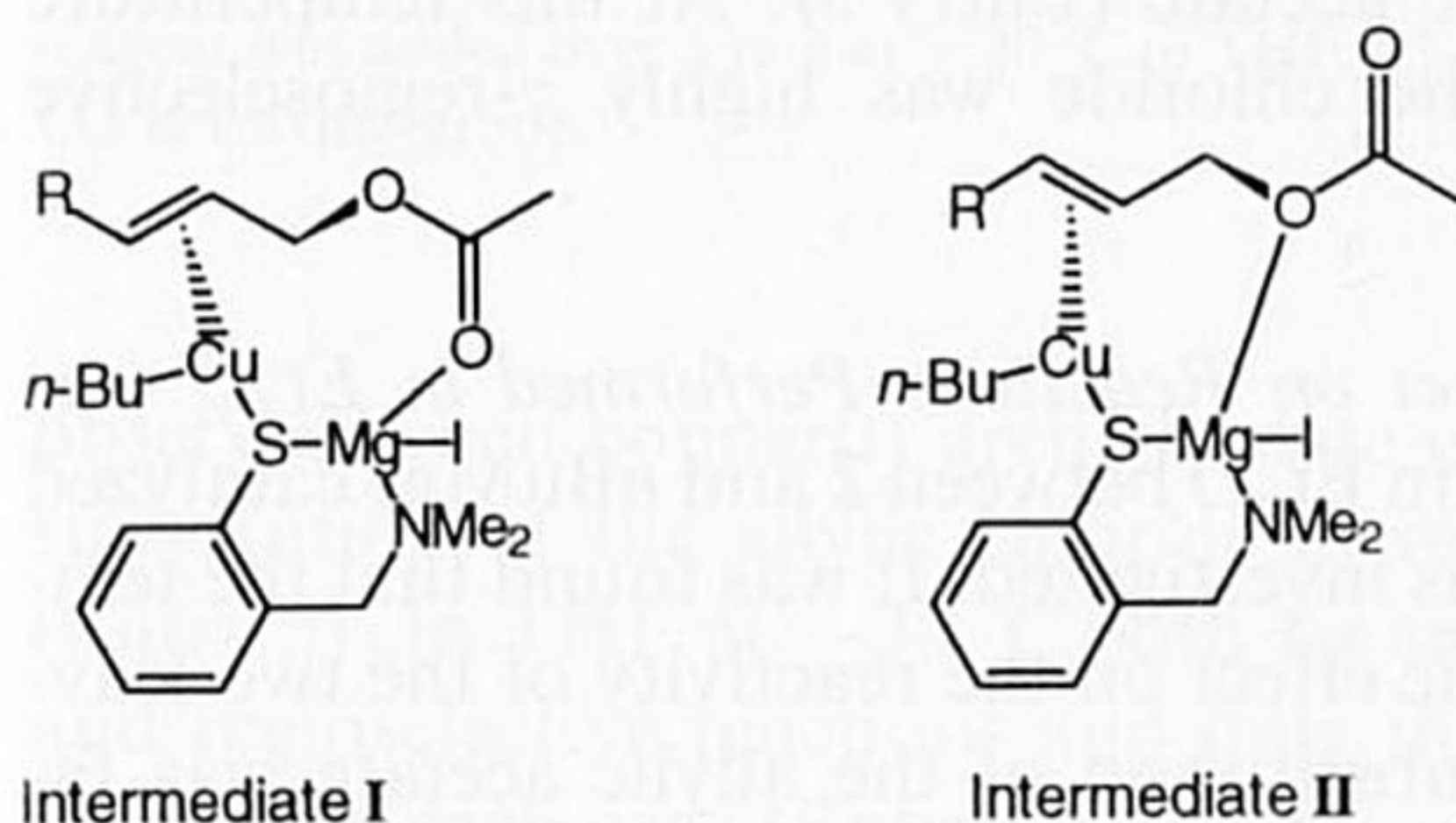

Fig. 4. Proposed intermediates in Et<sub>2</sub>O: either the carbonyl (**I**) or (less likely) the ester oxygen (**II**) coordinates to Mg.

coordinates in a bidentate fashion to the Cu-(Ar)S-Mg moiety by  $\pi$ -complexation<sup>[24]</sup> of the alkene to Cu and coordination of either the ester oxygen atom (**II**) or, more likely, the carbonyl oxygen atom (**I**) to Mg. The third coordination site on Cu<sup>I</sup> is occupied by a butyl ligand. The three remaining sites in the tetrahedral coordination sphere of the Mg ion are occupied by an iodido ligand and the S and N donor atoms of the ArS anion. It should be noted that the bimetallic array shown in Figure 4 can be a single species or the catalytically active part of a larger aggregate. The initial intermediate **I** (or **II**) can undergo a  $\gamma$ -selective oxidative addition to give a ( $\sigma$ -allyl)copper(III) complex followed by fast reductive elimination to produce the  $\gamma$ -substituted product (Scheme 1). In Et<sub>2</sub>O, the bidentate anchoring of the substrate to the catalyst through the alkene group and the oxygen atom results in enhanced reactivity of the acetate group and therefore in exclusive formation of the  $\gamma$ -substituted product.

THF coordinates more strongly than Et<sub>2</sub>O, and in the former solvent a different binding mode is operative. Coordination of THF to Mg can now compete with coordination of the O atom of the substrate and to a lesser extent with coordination of the N atom of the ArS ligand. Consequently, the formation of intermediate **III** is anticipated in THF (Fig. 5). This intermediate lacks the bidentate  $\pi$ -alkene/ $\eta^1$ -O anchoring of the substrate present in intermediate **I** (**II**), and the substrate is only bound to the Mg-S-Cu moiety by  $\pi$ -coordination of the alkene to Cu (i.e., rotation around the alkene-Cu bond is possible). The leaving

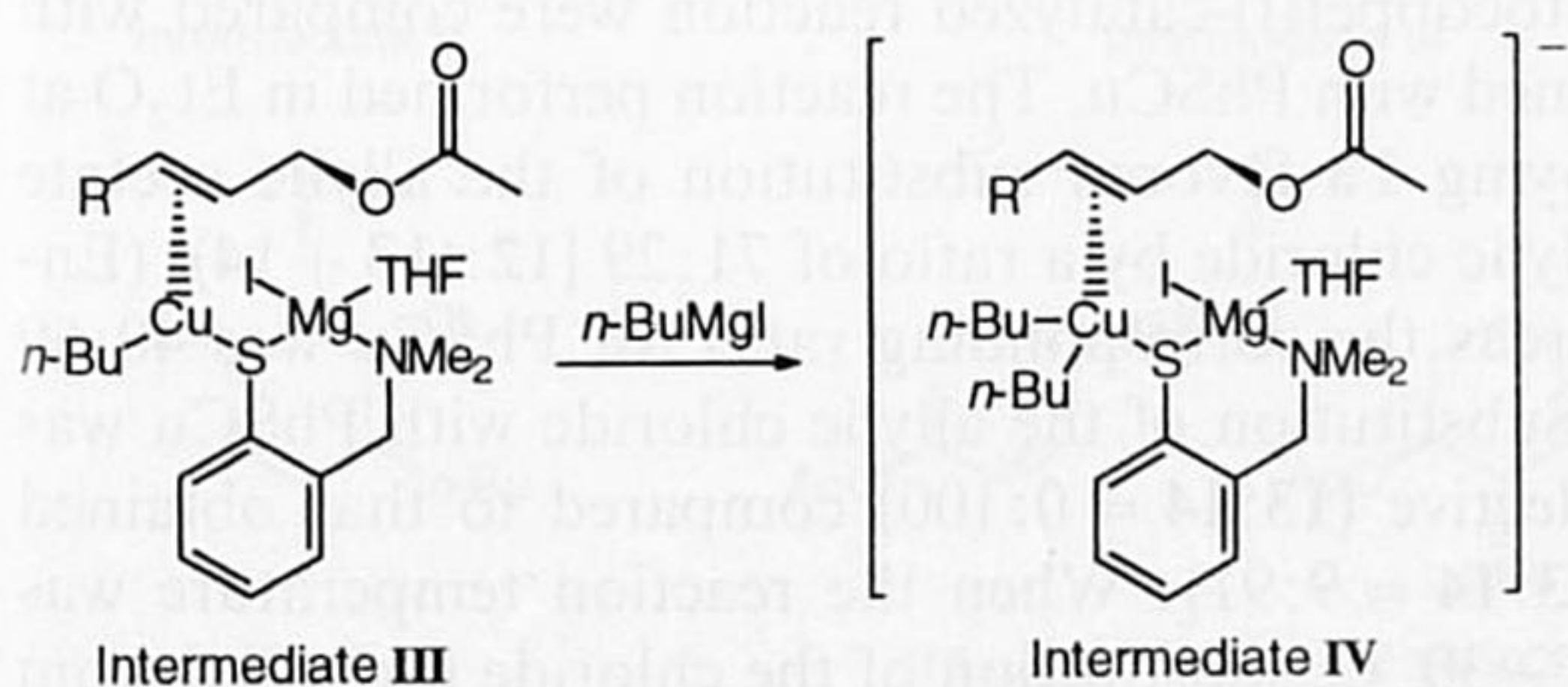

Fig. 5. Proposed intermediates in THF.

group is not activated in THF, and oxidative addition is thus slower. The monoalkylcopper species **III** will then have time to react with another molecule of the Grignard reagent to give some dialkylcopper complex **IV**.<sup>[25]</sup> By analogy with previous work<sup>[5a]</sup> this dialkylcopper intermediate is expected to be less  $\gamma$ -selective (cf. Scheme 1).

The different results obtained for the various copper(I) catalysts indicate that the S,N-bidentate bonding of the arenethiolate ligand is an important factor in determining the regioselectivity. The lower selectivity for  $\gamma$ -substituted product with catalyst **1d** can be attributed to the fact that S,N-chelation of this arenethiolate anion in the cuprate is not as effective as for catalysts **1a–c**. The chelate ring formed by the arenethiolate in **1d** is smaller, and the arene bridge connecting the S and N donor atom much more rigid than in catalysts **1a–c**.<sup>[26]</sup> Formation of an intermediate similar to **I** (or **II**) is obviously less favorable for **1d**, and the Me<sub>2</sub>NC<sub>6</sub>H<sub>4</sub>S<sup>-</sup> ion in **1d** is consequently less efficient at forming a template for the allylic acetate (see Fig. 6); this results in a lower  $\gamma$ -selectivity than for the parent thiophenolate PhS<sup>-</sup> (cf. Entries 4–6 in Table 4).

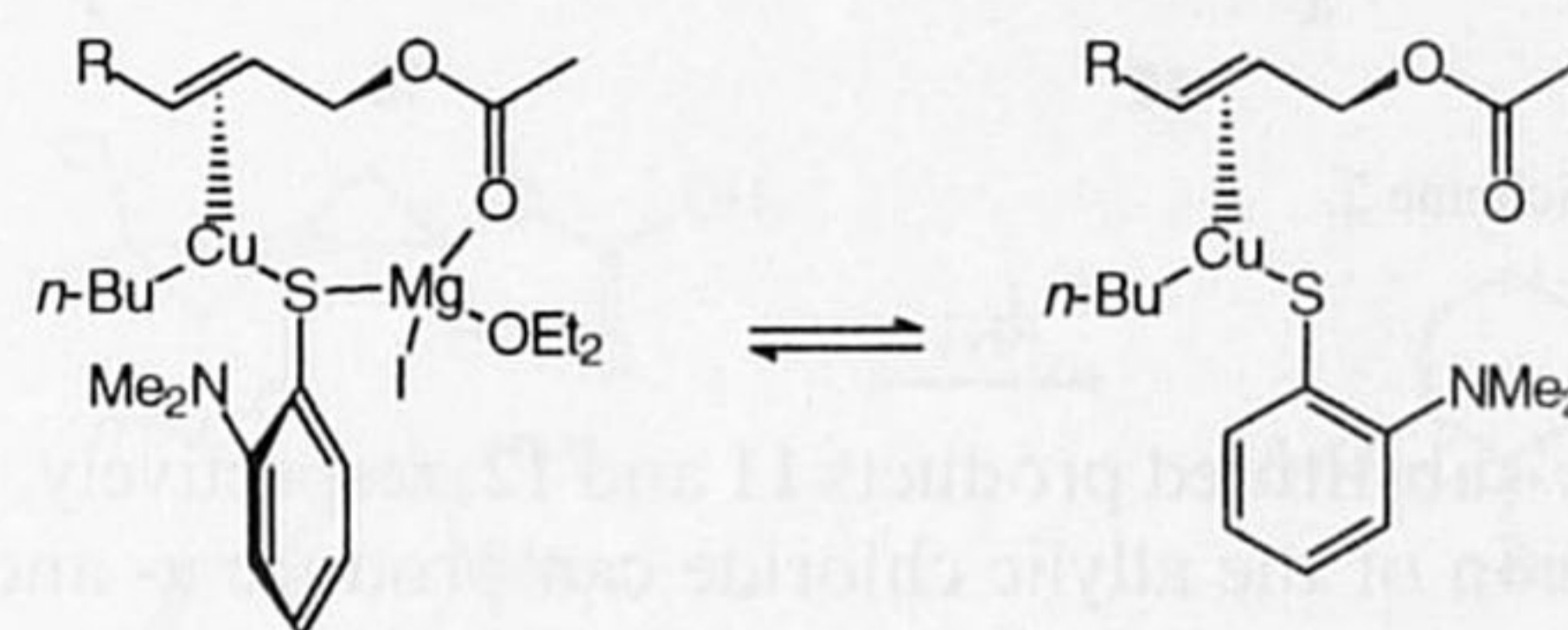
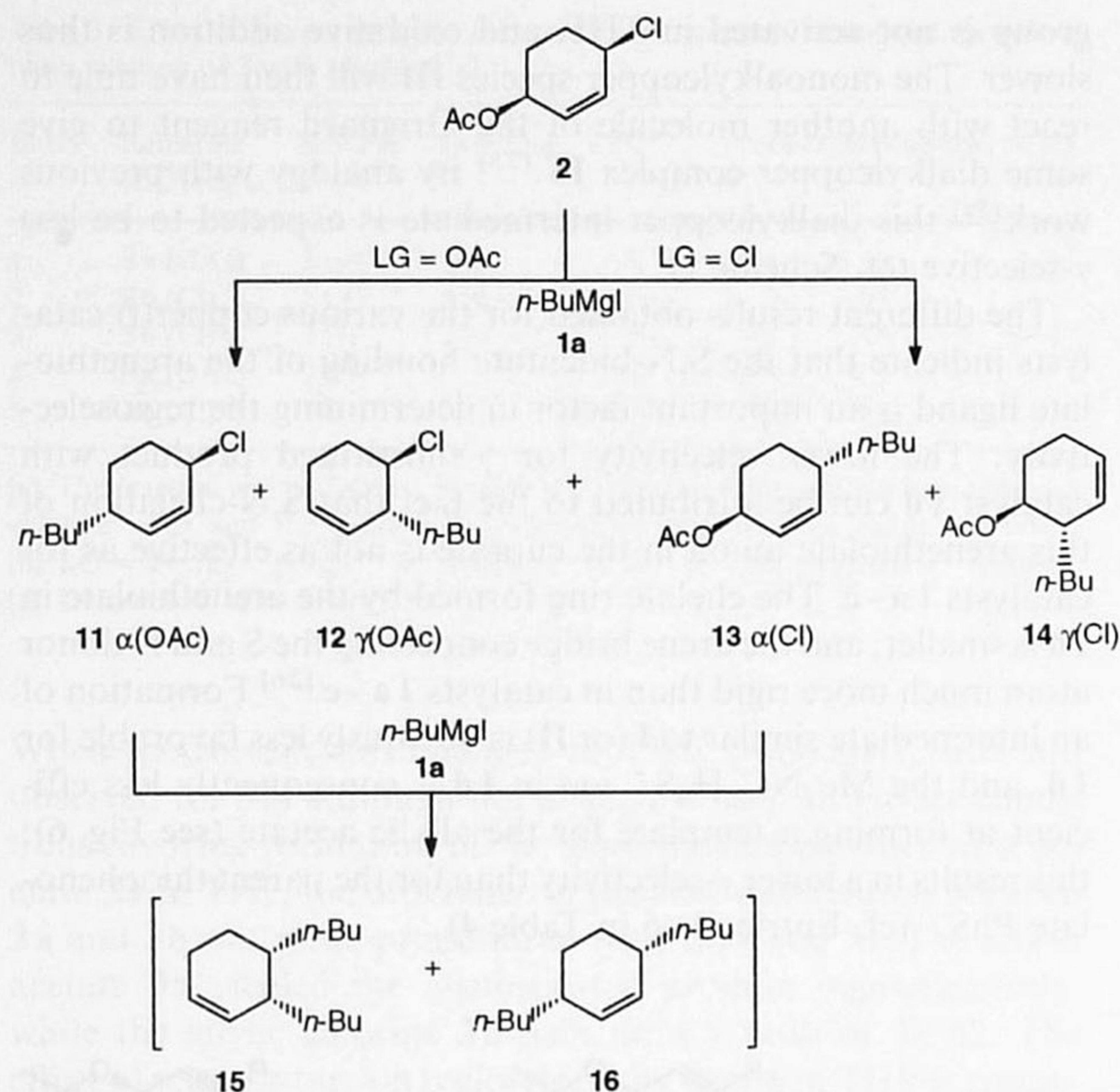

Fig. 6. Proposed intermediates in the reaction catalyzed by the arenethiolatocopper(I) catalyst **1d**.

The copper-catalyzed cross-coupling reaction of the allylic chloride **3b** did not give the spectacular change of regioselectivity with solvent observed for the corresponding reaction of the allylic acetate **3a** (Table 3, Entry 1 vs. 4). In the reactions of geranyl chloride (**3b**), a change of solvent from Et<sub>2</sub>O<sup>[27]</sup> to THF only resulted in a change in the  $\alpha$ : $\gamma$  ratio from 5:95 to 38:62 (Entry 2 vs. 5). Thus, the allylic chloride **3b**, which is more reactive than **3a** in THF, undergoes preferential  $\gamma$ -substitution in this solvent. This indicates that the monoalkylcopper species (responsible for the  $\gamma$ -substitution) reacts faster with the allylic chloride than with another molecule of the Grignard reagent; the latter reaction would give the dialkylcopper species responsible for  $\alpha$ -substitution.<sup>[5a]</sup>

The observation that the regioselectivity in the reaction of allylic acetates in weakly coordinating solvents (e.g., Et<sub>2</sub>O and toluene) is less affected by variations in reaction conditions again underlines the role of the bidentate binding of the acetate in intermediate **I** (or **II**). The reactivity of the allylic acetate is thus enhanced, and the  $\gamma$ -selectivity can be rationalized in the same way as for the allylic chloride (vide supra). On the other hand, reactions performed in donor solvents like THF are more affected by the reaction conditions; this is consistent with monodentate binding of the substrate by  $\pi$ -coordination of the alkene to copper.

**3. Disubstituted Cyclohexene with Two Different Allylic Leaving Groups:** Cyclohexene **2** was treated with *n*BuMgI in the presence of 6 mol%<sup>[19]</sup> of the arenethiolatocopper(I) catalyst **1a** (Scheme 2). In this system, we not only studied the regioselectivity of the reaction, but also the chemoselectivity since the chloroacetate **2** contains two different allylic leaving groups. Substitution of the allylic acetate can give rise to  $\alpha$ - and/or



Scheme 2.

$\gamma$ -substituted products **11** and **12**, respectively, whereas substitution of the allylic chloride can produce  $\alpha$ - and/or  $\gamma$ -substituted products **13** and **14**, respectively. The products **11** and **13** arising from initial  $\alpha$ -substitution still contain an allylic leaving group, which can react further with  $n\text{BuMgI}$  to form the disubstituted products **15** and **16** (Scheme 2).

**3.1. Solvent Effects** (see Table 5): In THF the arenethiolatocopper(I)-catalyzed cross-coupling of **2**, at  $-30$  and  $0^\circ\text{C}$  with  $n\text{BuMgI}$  added over a period of 5 min, was highly chemo- and regioselective, giving rise to 100%  $\gamma$ -substitution of the allylic chloride to form **14** (Table 5, Entries 1 and 2). These results are consistent with the  $\alpha$ : $\gamma$  ratio of 5:95 (**13**:**14**) obtained by Bäckvall et al. in the reaction of **2** with  $n\text{BuMgBr}$  in THF at  $-20^\circ\text{C}$  with  $\text{Li}_2\text{CuCl}_4$  (10 mol%) as catalyst.<sup>[5a]</sup> Surprisingly, when  $n\text{BuMgI}$  was added slowly (over 120 min) to the reaction mixture in  $\text{Et}_2\text{O}$  at  $0^\circ\text{C}$ , substitution of the acetate predominated over substitution of the chloride (Entries 3 and 4). A reversed selectivity of this type is unprecedented in copper(I)-catalyzed allylic cross-couplings, and to the best of our knowledge in any analogous metal-catalyzed allylic substitution.<sup>[28]</sup> When 1.3 equiv of  $n\text{BuMgI}$  was used compounds **12** and **14** were formed in a ratio of 74:17 (81:19 relative ratio) in addition to

Table 5. Solvent effect on the arenethiolatocopper(I)-catalyzed cross-coupling of **2** with  $n\text{BuMgI}$  [a].

Entry	Solvent	Equiv $n\text{BuMgI}$	$T/^\circ\text{C}$	Product distribution/% [b]		
				LG = OAc 11 + 12 (11:12)	LG = Cl 13 + 14 (13:14)	Dibutylated 15 + 16
1	THF [c]	1.3	$-30$	0	100 (0:100)	0
2	THF [c]	1.3	0	0	100 (0:100)	0
3	$\text{Et}_2\text{O}$	1.3	0	74 (0:100)	17 (0:100)	9
4	$\text{Et}_2\text{O}$	1.0	0	71 (0:100)	29 (9:91)	0
5	$\text{Et}_2\text{O}$	1.0	$-30$	23 (0:100)	77 (1:99)	0

[a] The Grignard reagent was added over a period of 120 min to a homogeneous solution of **2** and the catalyst **1a** (6 mol%) [19]. Isolated yields: 65–85%. [b] Determined by capillary GC; LG = leaving group. [c] The Grignard reagent was added over a period of 5 min.

minor amounts of what appears to be dibutylated products **15** and **16** (Entry 3).<sup>[29]</sup> No  $\alpha$ -substituted products **11** or **13** could be detected, probably because the initially formed  $\alpha$ -products reacted with a second equivalent of  $n\text{BuMgI}$  to form the disubstituted products **15** and **16**. To avoid the second substitution an experiment with only 1.0 equiv of  $n\text{BuMgI}$  was performed. In this case, 71% of the  $\gamma$ -substituted product **12**, derived from substitution of the acetate, and 29% of products **13** and **14** (**13**:**14** = 9:91), arising from substitution of the chloride, were formed (Entry 4). Substitution of the allylic acetate was highly regioselective and resulted in exclusive formation of the  $\gamma$ -substituted product **12**. With the allylic chloride an  $\alpha$ : $\gamma$  ratio of 9:91 was observed. The same reaction performed at lower temperature ( $-30^\circ\text{C}$ ) resulted in faster substitution of the allylic chloride than of the allylic acetate (Entry 5). At this temperature the substitution of the chloride was highly  $\gamma$ -regioselective (**13**:**14** = 1:99).

**3.2. Temperature Effect on Reactions Performed in  $\text{Et}_2\text{O}$**  (see Table 6): The reaction in  $\text{Et}_2\text{O}$  between **2** and  $n\text{BuMgI}$  catalyzed by **1a** (6 mol%)<sup>[19]</sup> was investigated. It was found that the temperature has a dramatic effect on the reactivity of the two leaving groups. At  $0^\circ\text{C}$  substitution of the allylic acetate was favored (Table 6, Entry 1), while at lower temperatures ( $-30^\circ\text{C}$  and  $-60^\circ\text{C}$ ) the amount of substitution of the allylic chloride

Table 6. Temperature effect on the arenethiolatocopper(I)-catalyzed cross-coupling of **2** with  $n\text{BuMgI}$  in  $\text{Et}_2\text{O}$  [a].

Entry	$T/^\circ\text{C}$	Product distribution/% [b]			
		LG = OAc		LG = Cl	
		11	12	13	14
1	0	0	71	3	26
2	$-30$	0	23	1	76
3	60	0	6	0	94

[a] The reaction was performed in  $\text{Et}_2\text{O}$  at  $0^\circ\text{C}$ , and 1.0 equiv of the Grignard reagent was added over a period of 120 min to a homogeneous solution of **2** and the catalyst **1a** (6 mol%) [19]. Isolated yields: 75–85%. [b] Determined by capillary GC; LG = leaving group.

increased (Entries 2 and 3). The  $\gamma$ -selectivity for substitution of the allylic chloride increased at lower temperature ( $-60^\circ\text{C}$ ) compared to that at  $0^\circ\text{C}$ . The allylic acetate, on the other hand, underwent completely  $\gamma$ -selective substitution over the whole temperature range. The same reaction performed at room temperature was not selective, and a mixture of products **11**, **12**, **13**, **14**, **15**, and **16** as well as starting material was obtained.

**3.3. Comparison with  $\text{PhSCu}$**  (see Table 7): The tertiary *ortho*-amine in the copper(I) arenethiolate catalyst **1a**, which is ideally positioned for intramolecular complexation, seems to effect both chemo- and regioselectivity in the cross-coupling reaction of **2** with  $n\text{BuMgI}$  in  $\text{Et}_2\text{O}$ . In order to study the role of the *ortho*-amine substituent in catalyst **1a**, the results from the arenethiolatocopper(I)-catalyzed reaction were compared with those obtained with  $\text{PhSCu}$ . The reaction performed in  $\text{Et}_2\text{O}$  at  $0^\circ\text{C}$  employing **1a** favored substitution of the allylic acetate over the allylic chloride by a ratio of 71:29 [**12**:(**13** + **14**)] (Entry 1), whereas the corresponding ratio for  $\text{PhSCu}$  was 40:60 (Entry 2). Substitution of the allylic chloride with  $\text{PhSCu}$  was highly  $\gamma$ -selective (**13**:**14** = 0:100) compared to that obtained with **1a** (**13**:**14** = 9:91). When the reaction temperature was lowered to  $-30^\circ\text{C}$ , substitution of the chloride increased from 60 (Entry 2) to 76% using  $\text{PhSCu}$  (Entry 4). The same trend was

Table 7. Comparison of the copper(I) arenethiolate **1a** with PhSCu as catalyst in the cross-coupling of **2** with *n*BuMgI [a].

Entry	Catalyst	Method [b] (solvent)	Product distribution/% [c]		
			LG = OAc <b>12</b>	LG = Cl <b>13 + 14</b>	( <b>13</b> : <b>14</b> )
1	<b>1a</b>	A (Et <sub>2</sub> O)	71	29	(9:91)
2	PhSCu	A (Et <sub>2</sub> O)	40	60	(0:100)
3	<b>1a</b>	B (Et <sub>2</sub> O)	23	77	(1:99)
4	PhSCu	B (Et <sub>2</sub> O)	24	76	(0:100)
5	<b>1a</b>	C (THF)	0	100	(0:100)
6	PhSCu	C (THF)	0	100	(0:100)

[a] 1.0 equiv of the Grignard reagent was added to a homogeneous solution of **2** and the catalyst **1a** (6 mol%) [19]. Isolated yields: 75–85%. [b] Method A: The Grignard reagent was added over 120 min at 0 °C in Et<sub>2</sub>O. Method B: The Grignard reagent was added over 120 min at –30 °C in Et<sub>2</sub>O. Method C: The Grignard reagent was added over 5 min at –30 °C in THF. [c] Determined by capillary GC; LG is leaving group.

observed when copper(I) arenethiolate catalyst **1a** was used—substitution of the allylic chloride increased from 29 to 77% (Entry 3). In THF at –30 °C both **1a** and PhSCu gave chemo- and regioselective reactions and only the  $\gamma$ -substituted **14** was formed in each case (Entries 5 and 6).

**4. Mechanistic Aspects of the Cross-Coupling with 2:** In Et<sub>2</sub>O with **1a** as the catalyst, both the allylic acetate and chloride in **2** are substituted by *n*BuMgI. The chemoselectivity is highly dependent on the reaction temperature. The product distribution can be rationalized by the formation of two intermediates **V** and **VI** (Scheme 3), the distribution of which varies with the temperature. At 0 °C, the allylic acetate reacts preferentially in the cross-coupling reaction, and intermediate **V** is thought to predominate. In this intermediate the allylic acetate coordinates in a bidentate fashion by  $\pi$ -complexation of the alkene to Cu and coordination of the carbonyl oxygen to Mg (Scheme 3, Intermediate **V**; cf. Intermediate **I**, Fig. 4). The bidentate coordination of the allylic acetate increases its reactivity relative to the chloride. Thus, coordination of the acetate to Mg increases the leaving group ability of the acetate, which in turn increases the selectivity for the  $\gamma$ -product (vide supra).<sup>[5a]</sup> The slight loss of regioselectivity obtained for the chloride may be due to direct

noncatalyzed substitution. The increased substitution of the allylic chloride in **2** at low temperature (Table 6, Entry 3) is explained by predominant formation of intermediate **VI** (Scheme 3), in which there is no activation of the allylic acetate group. The lower selectivity for acetate substitution with PhSCu as catalyst is probably due to a lower ability of the thiophenolate ligand to coordinate to the acetate. Without the nitrogen to anchor the Mg in close proximity to the acetate, effective coordination of the acetate is not achieved, and the reaction rate decreases. In this case the substitution of the chloride will increase.

In THF the copper-catalyzed reaction is chemo-, regio-, and stereoselective; the only product obtained is  $\gamma$ -alkylated **14**. Coordination of THF to Mg in the Cu-ArS-Mg moiety competes with coordination of O (acetate) and N (ArS) atoms; activation of the acetate will therefore not occur and the chloride will be the better leaving group (Fig. 7 intermediate **VII**; cf. Intermediate **III**, Fig. 5). Because of the high reactivity of the allylic chloro group, the monoalkylcopper species **VII** reacts rapidly (and  $\gamma$ -selectively) before it reacts with another molecule of *n*BuMgI.

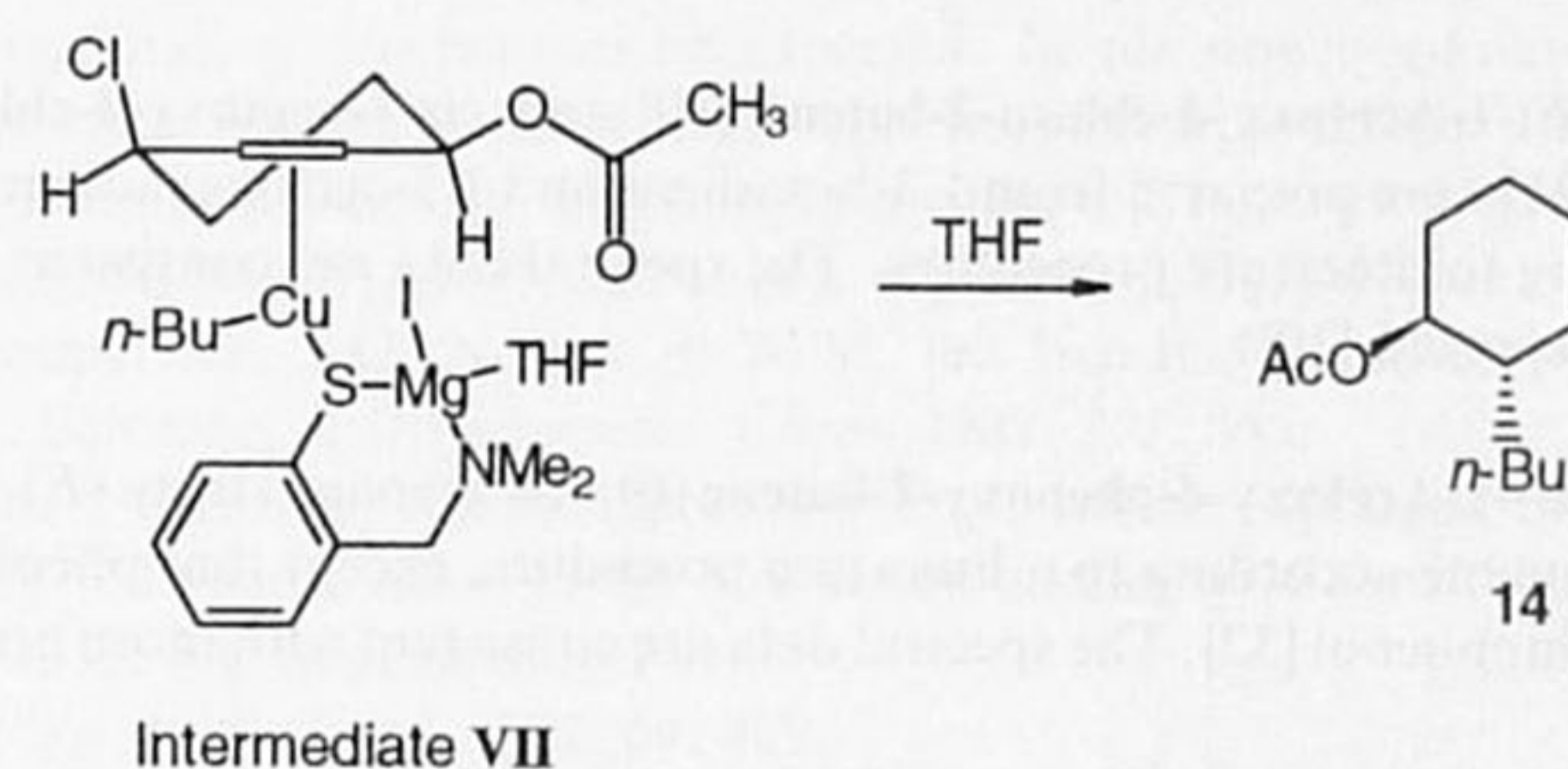
Fig. 7. Intermediate **VII** in THF, for the reaction of **2** with catalyst **1a**.

In the case of the cyclic allylic substrate only 1.0 equiv of the Grignard reagent is required for full conversion, while 1.3 equiv is required for the acyclic substrate. Obviously the cyclic substrate has a favorable conformation for a fast reaction with the cuprate. This is probably the reason for the high  $\gamma$ -selective substitution of the allylic chloride in the cyclic substrate compared to the allylic chlorides in the acyclic substrates.

## Conclusions

The regioselectivity in the arenethiolatocopper(I)-catalyzed cross-coupling reaction of allylic substrates with *n*BuMgI depends on a number of parameters: 1) the leaving group, 2) the solvent, 3) the temperature, and 4) the addition time of the Grignard reagent. The  $\alpha$ -substituted product is favored in THF at low temperature (–30 °C) with fast addition of the Grignard reagent (5 min), whereas the  $\gamma$ -product is favored in Et<sub>2</sub>O at a higher temperature (0 °C) with slower addition of the Grignard reagent (120 min).

The excellent  $\gamma$ -selectivity obtained in Et<sub>2</sub>O with the copper(I) arenethiolate catalysts is explained by coordination of the allylic acetate in a bidentate fashion to the cuprate (Fig. 4). An important observation in this work is that the acetate in chloroacetate **2** can act as a better leaving group than the chloride in the cross-coupling reactions performed in Et<sub>2</sub>O. Coordination of the allylic acetate to the copper(I) arenethiolate catalyst in a bidentate fashion is thought to be responsible for the enhanced reactivity of the acetate. The general trend is observed that high  $\gamma$ -selectivity is associated with high reactivity of the leaving group. By analogy with the previously suggested mechanism,<sup>[5]</sup>

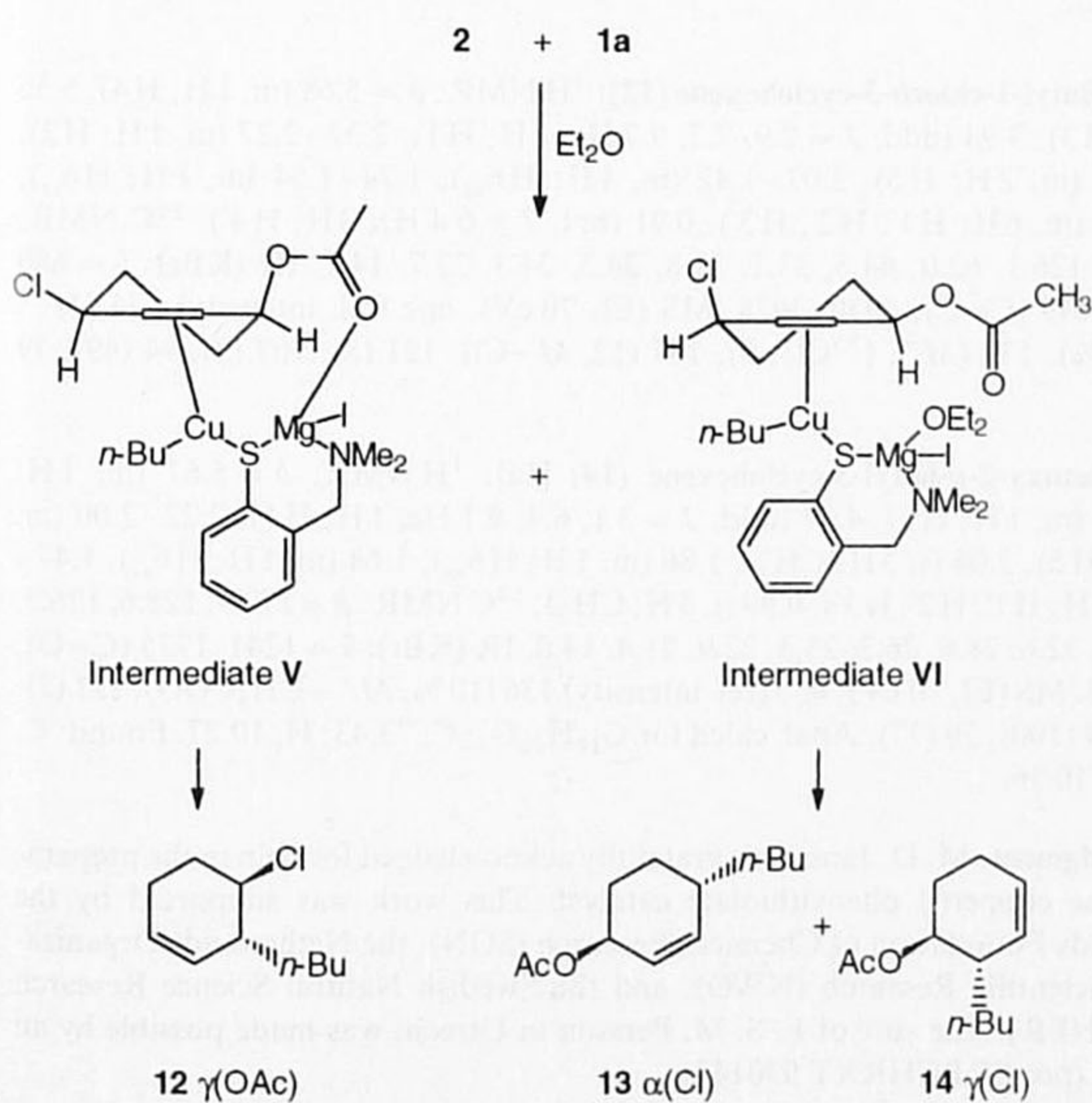

Scheme 3.

an explanation for this trend might be that the monoalkylcopper species (responsible for  $\gamma$ -substitution) is consumed faster by a reactive substrate than by another molecule of Grignard reagent (this would give the dialkylcopper species, which is responsible for  $\alpha$ -substitution).

## Experimental Procedure

**General:**  $^1\text{H}$  and  $^{13}\text{C}$  NMR spectra were recorded on a Bruker AC-200P spectrometer at 200 and 50.3 MHz, respectively, with  $\text{CDCl}_3$  as solvent. Chemical shifts are reported relatively to TMS. IR spectra were recorded with a Mattson Galaxy series FT-IR 5000 spectrometer. Analytical GLC was performed on a Philips PU 4600 gas chromatograph with a 30 m DB17 (liquid phase) capillary column. GC/MS analyses were recorded with a Unicam Automass instrument using electron impact (EI, 70 eV). Elemental analyses were carried out by the Mikroanalytische Laboratorium Dornis and Kolbe, Mülheim, a. d. Ruhr (Germany). Merck Silica gel (230–400 mesh) was used for flash chromatography. The copper catalysts were synthesized and handled by standard Schlenk techniques under an atmosphere of dry, oxygen-free nitrogen. THF,  $\text{Et}_2\text{O}$ , and toluene were distilled from deep blue sodium/benzophenone solutions. All arenethiolatocopper(I)-catalyzed reactions were run with 1 mmol of allylic substrate in 130 mL of solvent. Geranyl chloride (95%), geranyl acetate (98%), 1,3-cyclohexadiene (97%), and  $\text{Li}_2\text{CuCl}_4$  (0.1 M in THF) were purchased from Aldrich. (*E*)-2-hexene-1-ol (96%) was purchased from Janssen Chimica, and 1,3-butadiene (>99%) from Fluka. They were used without further purification.

(*E*)-1-Acetoxy-4-chloro-2-butene [30] and *cis*-1-acetoxy-4-chloro-2-cyclohexene (2) [31] were prepared from 1,3-butadiene and 1,3-cyclohexadiene, respectively, according to literature procedures. The spectral data are consistent with those previously reported [30].

(*E*)-1-Acetoxy-4-phenoxy-2-butene (6) was prepared from (*E*)-1-acetoxy-4-chloro-2-butene according to a literature procedure, except that phenol was used instead of thiophenol [32]. The spectral data are consistent with those previously reported [5a].

(*E*)-2-Hexene-1-yl acetate (9) was prepared from (*E*)-2-hexene-1-ol under standard conditions (DMAP,  $\text{Et}_3\text{N}$ , acetic anhydride) [33].

[2-((Dimethylamino)methyl)thiophenolato]copper(I) (1a) and [2-(*S*)-1-(dimethylamino)ethyl]thiophenolato]copper(I) (1b) were prepared according to literature procedure [15c]. The spectral data are consistent with those previously reported [15b].

[2-(Dimethylamino)phenylthiolato]copper(I) (1c) and [8-(dimethylamino)naphthyl-1-thiolato]copper(I) (1d) were prepared according to the method developed by van Koten et al [15d].

**Thiophenolatocopper(I) (CuSPH):** Freshly distilled thiophenol (0.43 g, 3.90 mmol) was dissolved in  $\text{C}_6\text{H}_6$  (10 mL) and added dropwise to a solution of copper(I) *tert*-butoxide [34] (0.53 g, 3.90 mmol) in  $\text{C}_6\text{H}_6$  (10 mL). The reaction mixture was stirred for 0.5 h, and the solvent evaporated in vacuo. The solid material was washed with pentane ( $3 \times 20$  mL), benzene ( $2 \times 20$  mL), and dried in vacuo to give 0.5 g (75%) of thiophenolatocopper(I) as yellow crystals. Anal. calcd for  $\text{CuC}_6\text{H}_5\text{S}$ : C, 41.73; H, 2.92. Found: C, 41.56; H, 2.81.

**General Procedure for the Arenethiolatocopper(I)-Catalyzed Grignard Reactions of Allylic Substrates in  $\text{Et}_2\text{O}$ :** The required amount of 1a–d (6 or 15 mol%) [19] was dissolved in toluene (15 mL), and a solution of the allylic substrate (1.0 mmol) in  $\text{Et}_2\text{O}$  (15 mL) was added at the temperature indicated in the Tables. The Grignard reagent (1.3 mmol, 1.30 M) dissolved in  $\text{Et}_2\text{O}$  (100 mL, final concentration 0.013 M) was added dropwise over the time indicated in the Tables. After complete addition the reaction mixture was stirred for 30–60 min at 0 °C or if the Grignard reagent was added at lower temperature, the temperature was allowed to rise to RT. The reaction mixture was then quenched with 2 M HCl(aq) (10 mL). The organic layer was collected and the general workup procedure was employed (vide infra).

**General Procedure for Arenethiolatocopper(I)-Catalyzed Grignard Reactions of Allylic Substrates in THF:** The required amount of 1a (6 or 15 mol%) [19] was dissolved in THF (15 mL), and a solution of the allylic substrate (1.0 mmol) in THF (15 mL) was added at the temperature indicated in the Tables. The Grignard reagent (1.3 mmol, 1.30 M) dissolved in THF (100 mL, final concentration 0.013 M) was added dropwise over the time indicated in the Tables. After complete addition the temperature was allowed to slowly rise to RT, and the reaction mixture was then quenched with 2 M HCl(aq) (10 mL). THF was evaporated in vacuo and the general workup procedure was employed (vide infra).

**Procedure for the Reaction with Geranyl Acetate (3a) Catalyzed by Thiophenolatocopper(I) Prepared in Situ [35]:** To a solution of freshly distilled thiophenol (79.6 mg, 0.72 mmol) in  $\text{Et}_2\text{O}$  (10 mL) at  $-60$  °C was slowly added *n*BuLi (0.48 mL, 1.5 M in

hexane, 0.72 mmol). After complete addition the reaction mixture was allowed to warm to room temperature. A sample of lithium thiophenolate (2.2 mL, 0.15 mmol) was added to a slurry of CuI (28.5 mg, 0.15 mmol) in  $\text{Et}_2\text{O}$  (10 mL), which was then stirred for 30 min. The general procedure (vide supra) for arenethiolatocopper(I)-catalyzed Grignard reactions of allylic substrates in  $\text{Et}_2\text{O}$  was used.

**General Workup Procedure:** The aqueous layer was extracted with pentane/ $\text{Et}_2\text{O}$  ( $4 \times 15$  mL, 1:1). The combined organic layers were washed with brine, dried ( $\text{MgSO}_4$ ), and concentrated in vacuo. Flash chromatography (pentane/ $\text{Et}_2\text{O}$ ) gave the substituted product as a colorless oil with yields varying from 65 to 85% and  $\alpha$ : $\gamma$  ratios depending on reaction conditions. Results are given in Tables. Spectral data are given below.

**Characterization of Products:** Unless stated otherwise, the spectral data were recorded for one pure isomer.

(*E*)-2,6-Dimethyl-2,6-dodecadiene (4) [5a]:  $^1\text{H}$  NMR:  $\delta$  = 5.17–5.06 (m, 2H; H3, H7), 2.10–1.92 (m, 6H; H4, H5, H8), 1.70 (s, 3H;  $\text{CH}_3$ ), 1.61 (s, 6H;  $\text{CH}_3$ ), 1.40–1.25 (m, 6H; H9, H10, H11), 0.90 (brt,  $J$  = 6.8 Hz, 3H; H12).  $^{13}\text{C}$  NMR:  $\delta$  = 134.7, 131.2, 124.9, 124.4, 39.8, 31.6, 29.6, 27.9, 26.7, 25.7, 22.7, 17.7, 15.9, 14.1. IR (KBr):  $\tilde{\nu}$  = 1744, 1669, 1452, 1377, 1106, 827  $\text{cm}^{-1}$ . MS (EI, 70 eV):  $m/z$  (rel. intensity) 194 ( $M^+$ , 10%), 179 (7), 151 (19), 123 (36), 109 (8), 95 (13), 83 (17), 69 (100), 55 (32). Anal. calcd for  $\text{C}_{14}\text{H}_{26}$ : C, 86.52; H, 13.48. Found: C, 86.38; H, 13.26.

2,6-Dimethyl-6-vinyl-2-decene (5) [5a]:  $^1\text{H}$  NMR:  $\delta$  = 5.71 (dd,  $J$  = 11.0, 17.4 Hz, 1H; H1'), 5.11 (m, 1H; H3), 4.99 (dd,  $J$  = 1.4, 11.0 Hz, 1H; H2'<sub>cis</sub>), 4.90 (dd,  $J$  = 11.0, 17.4 Hz, 1H; H2'<sub>trans</sub>), 1.94–1.81 (m, 2H; H4), 1.69 (s, 3H;  $\text{CH}_3$  vinylic), 1.60 (s, 3H;  $\text{CH}_3$  vinylic), 1.54–1.17 (m, 8H; H5, H7, H8, H9), 0.97 (s, 3H;  $\text{CH}_3$  allylic), 0.90 (brt,  $J$  = 6.8 Hz, 3H; H10).  $^{13}\text{C}$  NMR:  $\delta$  = 147.5, 130.7, 125.2, 111.3, 40.8, 40.6, 39.4, 26.3, 25.7, 23.6, 22.6, 22.5, 17.5, 14.1. MS (EI, 70 eV):  $m/z$  (rel. intensity) 194 ( $M^+$ , 4%), 151 (15), 123 (3), 109 (55), 95 (48), 68 (67), 55 (100). Anal. calcd for  $\text{C}_{14}\text{H}_{26}$ : C, 86.52; H, 13.48. Found: C, 86.42; H, 13.38.

(*E*)-1-(Phenyloxy)-2-octene (7) [5a]:  $^1\text{H}$  NMR:  $\delta$  = 7.30–7.25 (m, 2H; Ph), 6.96–6.91 (m, 3H; Ph), 5.85 (dt,  $J$  = 15.5, 6.5 Hz, 1H; H3), 5.70 (dt,  $J$  = 15.5, 6.0 Hz, 1H; H2), 4.48 (d,  $J$  = 6.0 Hz, 2H; H1), 2.13–2.03 (m, 2H; H4), 1.47–1.36 (m, 2H; H5), 1.36–1.20 (m, 4H; H6, H7), 0.89 (brt, 3H; H8).  $^{13}\text{C}$  NMR:  $\delta$  = 158.8, 135.7, 129.4, 124.8, 120.6, 114.8, 68.7, 32.3, 31.4, 28.7, 22.5, 14.0. IR (KBr):  $\tilde{\nu}$  = 650, 752, 971, 1240. MS (EI, 70 eV):  $m/z$  (rel. intensity) 204 ( $M^+$ , 4%), 133 (4), 110 (18), 94 (100).

3-(Phenyloxy)methyl-1-heptene (8) [5a]:  $^1\text{H}$  NMR:  $\delta$  = 7.34–7.25 (m, 2H; Ph), 6.98–6.91 (m, 3H; Ph), 5.77 (ddd,  $J$  = 8.3, 10.7, 17.0 Hz, 1H; H2), 5.16 (dd,  $J$  = 1.6, 17.0 Hz, 1H; H1<sub>trans</sub>), 5.14 (dd,  $J$  = 1.6, 10.7 Hz, 1H; H1<sub>cis</sub>), 3.90 (d,  $J$  = 6.3 Hz, 2H;  $\text{PhOCH}_2$ ), 2.55–2.49 (m, 1H; H3), 1.77–1.45 (m, 1H; diastereotopic H4), 1.45–1.21 (m, 5H; H5, H6, diastereotopic H4), 0.94 (brt,  $J$  = 6.4 Hz, 3H; H7).  $^{13}\text{C}$  NMR:  $\delta$  = 159.2, 139.7, 129.4, 120.6, 116.0, 114.7, 71.2, 43.7, 31.0, 29.2, 22.8, 14.1. IR (KBr):  $\tilde{\nu}$  = 915, 1037, 1243, 2925, 3029. MS (EI, 70 eV):  $m/z$  (rel. intensity) 204 ( $M^+$ , 3%), 94 (100). Anal. calcd for  $\text{C}_{14}\text{H}_{20}\text{O}$ : C, 82.30; H, 9.86. Found: C, 82.24; H, 9.98.

3-Propyl-1-heptene (10) [5a]:  $^1\text{H}$  NMR:  $\delta$  = 5.51 (ddd,  $J$  = 17, 11, 9 Hz, 1H; H2), 4.93 (dd,  $J$  = 10, 2 Hz, 1H; H1<sub>cis</sub>), 4.91 (dd,  $J$  = 17, 2 Hz, 1H; H1<sub>trans</sub>), 1.94 (m, 1H; H3), 1.43–1.09 (m, 10H; H4, H5, H6, H1', H2'), 0.95 (brt,  $J$  = 6.4 Hz, 6H; H7, H3').

*trans*-2-*n*-Butyl-1-chloro-3-cyclohexene (12):  $^1\text{H}$  NMR:  $\delta$  = 5.68 (m, 1H; H4), 5.55 (m, 1H; H3), 3.94 (ddd,  $J$  = 2.9, 7.3, 9.7 Hz, 1H; H1), 2.37–2.27 (m, 1H; H2), 2.27–2.03 (m, 2H; H5), 2.03–1.82 (m, 1H; H6<sub>eq</sub>), 1.74–1.54 (m, 1H; H6<sub>ax</sub>), 1.46–1.20 (m, 6H; H1', H2', H3'), 0.91 (brt,  $J$  = 6.4 Hz, 3H; H4').  $^{13}\text{C}$  NMR:  $\delta$  = 126.7, 126.1, 62.0, 44.5, 33.1, 31.3, 28.3, 24.3, 22.7, 14.1. IR (KBr):  $\tilde{\nu}$  = 680 (C–Cl), 1649 (C=C), 2930, 3028. MS (EI, 70 eV):  $m/z$  (rel. intensity) 174 ( $M^+$ ,  $^{37}\text{Cl}$ , 3%), 172 ( $M^+$ ,  $^{35}\text{Cl}$ , 9), 137 (12,  $M$ -Cl), 121 (8), 107 (9), 94 (49), 79 (100).

*trans*-1-Acetoxy-2-*n*-butyl-3-cyclohexene (14) [5a]:  $^1\text{H}$  NMR:  $\delta$  = 5.67 (m, 1H; H4), 5.53 (m, 1H; H3), 4.77 (ddd,  $J$  = 3.1, 6.4, 9.1 Hz, 1H; H1), 2.22–2.00 (m, 3H; H2, H5), 2.04 (s, 3H;  $\text{CH}_3$ ), 1.86 (m, 1H; H6<sub>eq</sub>), 1.64 (m, 1H; H6<sub>ax</sub>), 1.47–1.20 (m, 6H; H1', H2', H3'), 0.89 (t, 3H;  $\text{CH}_3$ ).  $^{13}\text{C}$  NMR:  $\delta$  = 170.9, 128.6, 126.3, 73.7, 40.2, 32.6, 28.6, 26.2, 23.3, 22.9, 21.4, 14.0. IR (KBr):  $\tilde{\nu}$  = 1241, 1735 (C=O), 2930, 3023. MS (EI, 70 eV):  $m/z$  (rel. intensity) 136 (10%,  $M^+$  –  $\text{CH}_3\text{COO}$ ), 121 (2), 107 (5), 94 (100), 79 (77). Anal. calcd for  $\text{C}_{12}\text{H}_{20}\text{O}_2$ : C, 73.43; H, 10.27. Found: C, 73.28; H, 10.16.

**Acknowledgment:** M. D. Janssen is gratefully acknowledged for help in the preparation of the copper(I) phenylthiolate catalyst. This work was supported by the Netherlands Foundation of Chemical Research (SON), the Netherlands Organization for Scientific Research (NWO), and the Swedish Natural Science Research Council (NFR). The stay of E. S. M. Persson in Utrecht was made possible by an EU grant (no. ERBCHRXT 930149).

Received: January 23, 1995 [F 66]



- [1] P. Wipf, *Synthesis* **1993**, 537.
- [2] a) G. H. Posner, *Org. React.* **1975**, *22*, 253. b) B. H. Lipshutz, *Synthesis* **1987**, 325. c) B. H. Lipshutz, *Synlett* **1990**, 119. d) B. H. Lipshutz, S. Sengupta, *Org. React.* **1992**, *41*, 135.
- [3] a) G. Fouquet, M. Schlosser, *Angew. Chem. Int. Ed. Engl.* **1974**, *13*, 82. b) A. Commercon, M. Bourgain, M. Delaumeny, J. F. Normant, J. Villieras, *Tetrahedron Lett.* **1975**, 3837. c) P. Barsanti, V. Calò, L. Lopez, G. Marchese, F. Naso, G. Pesce, *J. Chem. Soc. Chem. Commun.* **1978**, 1085. d) M. Julia, A. Righini-Tapie, J. N. Verpeaux, *Tetrahedron* **1983**, *39*, 3283. e) V. Calò, L. Lopez, W. F. Carlucci, *J. Chem. Soc. Perkin Trans. 1* **1983**, 2953. f) D. P. Curran, M. H. Chen, D. Leszczewski, R. L. Elliott, D. M. Rakiewicz, *J. Org. Chem.* **1986**, *51*, 1612. g) J. A. Marshall, *Chem. Rev.* **1989**, *89*, 1503. h) A. Yanagisawa, Y. Noritake, N. Nomura, H. Yamamoto, *Synlett* **1991**, 251. i) A. Yanagisawa, N. Nomura, H. Yamamoto, *Synlett* **1993**, 251.
- [4] a) H. L. Goering, T. L. Underiner, *J. Org. Chem.* **1991**, *56*, 2563 and earlier references therein. b) R. M. Magid, *Tetrahedron* **1980**, *36*, 1901. c) J. Levisalles, M. Rudler-Chauvin, H. Rudler, *J. Organomet. Chem.* **1977**, *136*, 103.
- [5] a) J. E. Bäckvall, M. Sellén, B. Grant, *J. Am. Chem. Soc.* **1990**, *112*, 6615. b) J. E. Bäckvall, E. S. M. Persson, A. Bombrun, *J. Org. Chem.* **1994**, *59*, 4126.
- [6] Recently, a number of copper-catalyzed cross-coupling reactions with other organometallic reagents have been reported. For examples with organozinc reagents, see a) M. Arai, T. Kawasuji, E. Nakamura, *J. Org. Chem.* **1993**, *58*, 5121. b) E. Nakamura, K. Sekiya, M. Arni, S. Aoki, *J. Am. Chem. Soc.* **1989**, *111*, 3091. c) K. Sekiya, E. Nakamura, *Tetrahedron Lett.* **1988**, *29*, 5155. For examples with organotitanium reagents see, d) M. Arai, B. H. Lipshutz, E. Nakamura, *Tetrahedron* **1992**, *48*, 5709.
- [7] H. L. Goering, V. D. Singleton Jr., *J. Am. Chem. Soc.* **1976**, *101*, 7854.
- [8] a) H. L. Goering, V. D. Singleton Jr., *J. Org. Chem.* **1983**, *48*, 1531. b) H. L. Goering, S. S. Kantner, *J. Org. Chem.* **1984**, *49*, 422.
- [9] E. J. Corey, N. W. Boaz, *Tetrahedron Lett.* **1984**, *25*, 3063.
- [10] E. Keinan, E. Bosch, *J. Org. Chem.* **1986**, *51*, 4006.
- [11] It is known that electron-withdrawing ligands accelerate reductive elimination: a) T. Yamamoto, A. Yamamoto, S. Ikeda, *J. Am. Chem. Soc.* **1971**, *93*, 3350, 3360. b) H. Kurosawa, M. Emoto, H. Ohnishi, K. Miki, K. Tatsumi, A. Nakamura, *J. Am. Chem. Soc.* **1987**, *109*, 6333. c) See also: J. P. Collman, L. S. Hegeudus, J. R. Norton, R. G. Finke, *Principles and Applications of Organotransition Metal Chemistry*; University Science Books: Mill Valley, CA, **1987**.
- [12] The copper-catalyzed cross-coupling reaction with aryl or vinyl Grignard reagents shows poor regioselectivity but the mechanism is probably the same: see ref. [5b].
- [13] a) G. M. Whitesides, W. F. Fischer Jr., J. San Filippo, R. W. Bashe, H. D. House, *J. Am. Chem. Soc.* **1969**, *91*, 4871. b) C. R. Johnson, G. A. Dutra, *J. Am. Chem. Soc.* **1973**, *95*, 7783.
- [14] A preliminary account on parts of these results has appeared: M. van Klaveren, E. S. M. Persson, D. M. Grove, J. E. Bäckvall, G. van Koten, *Tetrahedron Lett.* **1994**, *35*, 5931.
- [15] a) D. M. Knotter, G. van Koten, H. M. van Maanen, D. M. Grove, A. L. Spek, *Angew. Chem. Int. Ed. Engl.* **1989**, *101*, 341. b) D. M. Knotter, H. M. van Maanen, D. M. Grove, A. L. Spek, G. van Koten, *Inorg. Chem.* **1991**, *30*, 3309. c) D. M. Knotter, M. D. Janssen, D. M. Grove, W. J. J. Smeets, E. Horn, A. L. Spek, G. van Koten, *Inorg. Chem.* **1991**, *30*, 4361. d) M. D. Janssen, J. G. Donkervoort, A. L. Spek, D. M. Grove, G. van Koten, unpublished results.
- [16] a) G. van Koten, *J. Organomet. Chem.* **1990**, *400*, 283. b) F. Lambert, D. M. Knotter, M. D. Janssen, M. van Klaveren, J. Boersma, G. van Koten, *Tetrahedron: Asymmetry* **1991**, *2*, 1097. c) D. M. Knotter, D. M. Grove, W. J. J. Smeets, A. L. Spek, G. van Koten, *J. Am. Chem. Soc.* **1992**, *114*, 3400. d) M. van Klaveren, F. Lambert, D. J. F. M. Eijkelkamp, D. M. Grove, G. van Koten, *Tetrahedron Lett.* **1994**, *35*, 6135. e) G. van Koten, *Pure Appl. Chem.* **1994**, *66*, 1455.
- [17] A copper(I) thiolate complex derived from chiral *ortho*-mercaptophenylloxazolines has been studied as an enantioselective catalyst for the 1,4-addition of Grignard reagents to cyclic  $\alpha,\beta$ -unsaturated ketones. a) Q. Zhou, A. Pfaltz, *Tetrahedron Lett.* **1993**, *34*, 7725. b) Q. Zhou, A. Pfaltz, *Tetrahedron* **1994**, *50*, 4467.
- [18] A. Haubrich, M. van Klaveren, G. van Koten, G. Handke, N. Krause, *J. Org. Chem.* **1993**, *58*, 5849.
- [19] Based on monomeric copper units.
- [20] A study of the arenethiolatocopper(I)-catalyzed cross-coupling reaction performed in THF shows that the best conditions for selective formation of the  $\alpha$ -substituted product is low temperature and Grignard reagent addition over 5 min; see ref. [5a].
- [21] The enantioselective arenethiolatocopper(I)-catalyzed cross-coupling reaction with **1b** is currently being studied.
- [22] a) J. K. Kochi, *Organometallic Mechanisms and Catalysis*; Academic Press: New York, 1978; p. 381. b) M. Tamura, J. K. Kochi, *Synthesis* **1971**, 303.
- [23] An EXAFS study of this system is currently under way.
- [24] a) C. Ullenius, B. Christenson, *Pure Appl. Chem.* **1988**, *60*, 57. b) N. Krause, R. Wagner, A. Gerold, *J. Am. Chem. Soc.* **1994**, *116*, 318.
- [25] In the suggested structure of intermediate **IV**, the sulfur is coordinated, but a lower order cuprate with noncoordinated sulfur is also possible.
- [26] Moreover, as the N atom is now directly connected to the phenyl ring, a lower basicity (i.e., coordination power) can be expected. In the noncoordinated arrangement shown in Figure 6 the N atom can become trigonal ( $sp^2$  hybridized) through conjugation with the phenyl  $\pi$ -system (cf. the crystal structure of  $[Cu_4Vi_2(2-Me_2NC_6H_4)_2]$  which contain a planar  $C_6H_4NMe_2$  anion; Vi = alkenyl group). See, J. G. Noltes, R. W. M. ten Hoedt, G. van Koten, A. L. Spek, J. C. Schoone, *J. Organometal. Chem.* **1982**, *225*, 365.
- [27] The slightly lower  $\gamma$ -selectivity for the chloride in  $Et_2O$  can be explained by a much weaker Mg–Cl coordination in the bidentate  $\pi$ -alkene,  $\eta^1$ -Cl anchoring of the allylic chloride (cf. Intermediate **I/II**).
- [28] J. E. Bäckvall, *Pure Appl. Chem.* **1992**, *64*, 429.
- [29] A mixture of products **15** and **16** were isolated by flash chromatography in low yield. Compounds **15** and **16** have tentatively been assigned to the structures given in Scheme 3. Both MS and  $^1H$  NMR spectra are in agreement with these structures.
- [30] J. E. Bäckvall, J. E. Nyström, R. E. Nordberg, *J. Am. Chem. Soc.* **1988**, *107*, 3676.
- [31] J. E. Bäckvall, K. L. Granberg, R. B. Hopkins, *Acta Chem. Scand.* **1990**, *44*, 492.
- [32] J. E. Bäckvall, M. Sellén, J. E. Nyström, *Acta Chem. Scand. B* **1988**, *42*, 397.
- [33] A. Hassner, L. R. Krepski, V. Alexanian, *Tetrahedron* **1978**, *34*, 2069.
- [34] T. H. Lemmen, G. V. Goeden, J. C. Huffman, R. L. Geerts, K. G. Caulton, *Inorg. Chem.* **1990**, *29*, 3680.
- [35] G. H. Posner, C. E. Whitten, J. J. Sterling, *J. Am. Chem. Soc.* **1973**, *95*, 7788.