

---

# **OUT-OF-STEP PROTECTION FUNDAMENTALS AND ADVANCEMENTS**

**DEMETRIOS A. TZIOUVARAS**

**SCHWEITZER ENGINEERING LABORATORIES, INC.  
VACAVILLE, CALIFORNIA USA**

**DAQING HOU**

**SCHWEITZER ENGINEERING LABORATORIES, INC.  
BOISE, IDAHO USA**

**Presented before the**

**30th ANNUAL  
WESTERN PROTECTIVE RELAY CONFERENCE  
SPOKANE, WASHINGTON  
OCTOBER 21-23, 2003**

# OUT-OF-STEP PROTECTION FUNDAMENTALS AND ADVANCEMENTS

---

Demetrios A. Tziouvaras  
Schweitzer Engineering Laboratories, Inc.  
Vacaville, CA USA

Daqing Hou  
Schweitzer Engineering Laboratories, Inc.  
Boise, ID USA

## ABSTRACT

Power systems are subjected to a wide range of small or larger disturbances during operating conditions. Small changes in loading conditions occur continually. The power system must adjust to these changing conditions and continue to operate satisfactorily and within the desired bounds of voltage and frequency. The power system should be designed to survive larger types of disturbances, such as faults, loss of a large generator, or line switching. Certain system disturbances may cause loss of synchronism between a generator and the rest of the utility system, or between interconnected power systems of neighboring utilities. If such a loss of synchronism occurs, it is imperative that the generator or system areas operating asynchronously are separated immediately to avoid widespread outages and equipment damage. In this paper we describe the philosophy and application fundamentals of out-of-step protection in transmission systems. We also discuss recent enhancements in the design of out-of-step tripping and blocking protection functions that improve the security and reliability of the power system. In addition, we demonstrate the out-of-step phenomena and distance relay element behavior using EMTP and Matlab simulations.

## INTRODUCTION

Power systems in the US have experienced a number of large disturbances in the last ten years including the largest blackout, which occurred on August 14, 2003 in the Midwest and Northeast US and impacted many millions of customers. The July 2, 1996 and August 10, 1996 major system disturbances also impacted several million customers in the Western US. All of these disturbances caused considerable loss of generation and loads and had a tremendous impact on customers and the economy in general. Typically, these disturbances happen when the power systems are heavily loaded and a number of multiple outages occur within a short period of time, causing power oscillations between neighboring utility systems, low network voltages, and consequent voltage instability or angular instability.

It is very expensive to design a power system to completely prevent very rare multiple outages and withstand their consequences. To mitigate the effect of these disturbances, it is common practice to provide controls called special protection systems or remedial action schemes. These special protection systems are designed to avoid voltage or angular instability and minimize the effects of a disturbance. Special protection systems include underfrequency and undervoltage load-shedding schemes, direct load and generation tripping and many other schemes [1].

Power system stability is the ability of an electric power system to regain a state of operating equilibrium after being subjected to disturbances such as faults, load rejection, line switching, and loss of excitation. Power system integrity is preserved when practically the entire system remains intact with no tripping of generators or loads, except for those disconnected by the isolation of the faulted elements, or by the intentional tripping of some elements to preserve the continuity of operation of the remaining part of the power system.

Certain power system disturbances may cause loss of synchronism between a generator and the rest of the utility system, or between neighboring utility interconnected power systems. If such a loss of synchronism occurs, it is imperative that the generator or system areas operating asynchronously are separated immediately to avoid widespread outages and equipment damage. An effective mitigating way to contain such a disturbance is through controlled islanding of the power system using out-of-step protection systems. Controlled system separation is achieved with an out-of-step tripping (OST) protection system at preselected network locations. OST systems must be complemented with out-of-step blocking (OSB) of distance relay elements, or other relay elements prone to operate during unstable power swings. OSB prevents system separation from occurring at any locations other than the preselected ones.

This paper illustrates the philosophy and application of OST and OSB schemes. In addition, in the paper we discuss the performance requirements of distance relays when faults occur during an out-of-step (OOS) condition. Among many challenges presented to distance relay elements in correctly detecting faults after issuing an OSB, we selectively present two of them: security against external unbalanced faults, and correct faulted phase selection of internal line faults to trip only the faulted phase instead of all three phases.

## **POWER SYSTEM STABILITY**

Power systems under steady-state conditions operate very near their nominal frequency. Under steady-state conditions, there is an equilibrium between the input mechanical torque and the output electrical torque of each generator. All synchronous machines connected to the power system operate at the same constant speed. The generator speed governors maintain the machine speed close to its nominal value. If the system is perturbed, this equilibrium is upset, resulting in acceleration or deceleration of the rotors of the synchronous machines according to the laws of motion of a rotating body. If one generator runs faster than another, the angular position of its rotor relative to that of the slower machine will advance. The resulting angular difference transfers part of the load from the slow machine to the faster machine, depending on the power-angle relationship. This tends to reduce the speed difference and hence the angular separation. Beyond a certain limit, an increase in angular separation is accompanied by a decrease in power transfer. This results into a further angular separation that leads to instability caused by sustained torque imbalance.

Typically there is a balance between generated and consumed active power under steady-state power system operating conditions. Changes in load and system configuration take place constantly and cause small perturbations to the power system. The ability of the power system to maintain stability under these small slow changes of system loading is what we refer to as steady-state stability or small disturbance rotor-angle stability. Small disturbance rotor-angle stability is typically associated with insufficient damping of oscillations. The time frame of interest in small disturbance stability studies is on the order of 10 to 20 seconds.

Power system faults, line switching, generator disconnection, and the loss and application of large blocks of load result in sudden changes of the electrical power, whereas the mechanical power input to generators remains relatively constant. These major system disturbances cause severe oscillations in machine rotor angles and severe swings in power flows. Transient stability, or large disturbance rotor-angle stability, is concerned with the ability of the power system to maintain synchronism when subjected to large transient disturbances, such as power system faults. The time frame of interest in transient stability is in the order of 3–5 seconds following a disturbance. Loss of synchronism can occur between one generator and the rest of the system, or between groups of generators. Synchronism could be maintained within each group of generators,

assuming a timely separation occurs, and at such points in the power system where a good balance of generation and load exists.

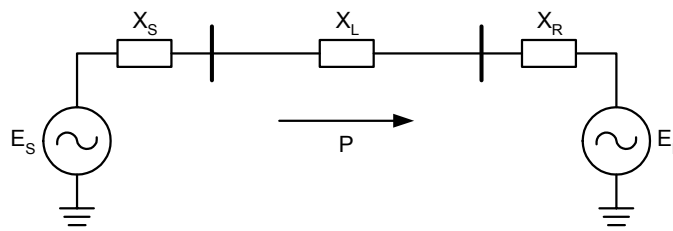
### **Power Transfer Between Two Equivalent Sources**

For a simple lossless transmission line connecting two equivalent generators as shown in Figure 1, it is well known that the active power,  $P$ , transferred between two generators can be expressed as,

$$P = \frac{E_S \cdot E_R}{X} \cdot \sin \delta \quad (1)$$

Where  $E_S$  is the sending-end source voltage magnitude,  $E_R$  is the receiving-end source voltage magnitude,  $\delta$  is the angle difference between two sources, and  $X$  is the total reactance of the transmission line and the two sources given by Equation 2.

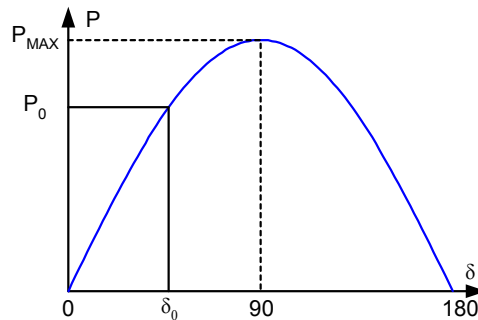
$$X = X_S + X_L + X_R \quad (2)$$



**Figure 1** A Two-Source System

### **The Power Angle Curve**

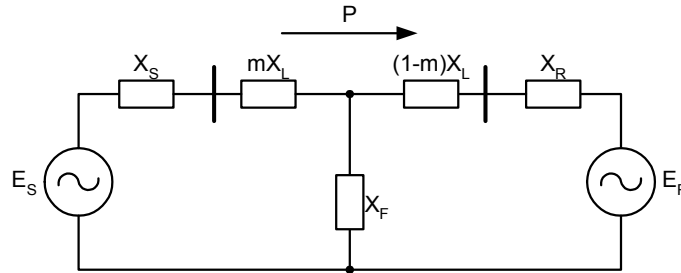
With fixed  $E_S$ ,  $E_R$  and  $X$  values, the relationship between  $P$  and  $\delta$  can be described in a Power Angle Curve as shown in Figure 2. Starting from  $\delta = 0$ , the power transferred increases as  $\delta$  increases. The power transferred between two sources reaches the maximum value  $P_{MAX}$  when  $\delta$  is 90 degrees. After that point, further increase in  $\delta$  will result in a decrease of power transfer. During normal operations of a generation system without losses, the mechanical power  $P_0$  from a prime mover is converted into the same amount of electrical power and transferred over the transmission line. The angle difference under this balanced normal operation is  $\delta_0$ .



**Figure 2** The Power Angle Curve

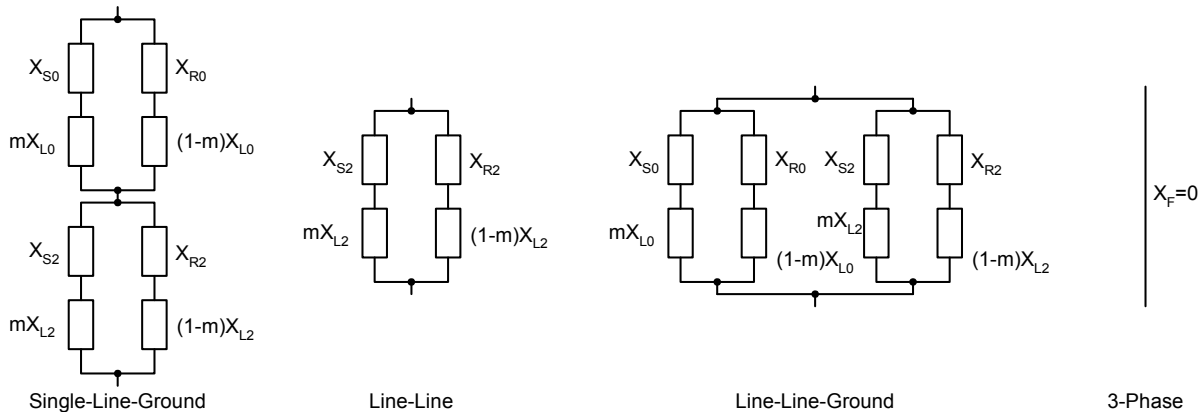
## TRANSMISSION Impedance During a Fault

When a fault occurs on the transmission line at  $m$  per-unit distance from the sending-end source  $S$ , the effective transmission reactance between the two sources will increase according to the type of faults in the system. In general, the fault is modeled as a shunt reactance  $X_F$  between the faulted point and the ground, as shown in Figure 3.

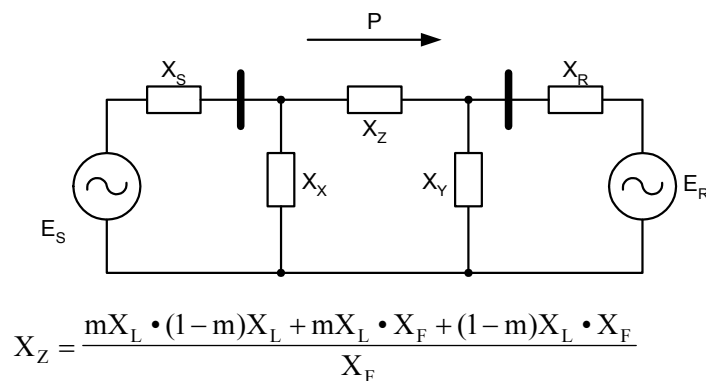


**Figure 3** Two-source System With a Fault at Location  $m$

For single-line-to-ground (SLG), line-to-line, double-line-to-ground and three-phase faults, the reactance  $X_F$  can be found from the interconnection of the sequence networks for each type of fault as shown in Figure 4, assuming no fault resistance is involved. In Figure 4, the subscripts 0, 1, and 2 are used to represent the zero-, positive-, and negative-sequence impedance of the transmission line and sources.



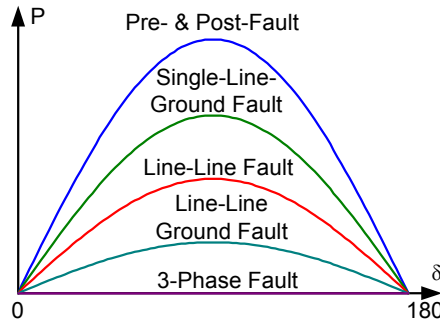
**Figure 4**  $X_F$  for Different Types of Faults



**Figure 5** Delta-Wye Equivalent of the Faulted System

The system in Figure 3 can be transformed to single out the effective transmission reactance using the delta-wye equivalent as shown in Figure 5. Note that SLG faults in general have the minimum impact on the equivalent transmission reactance among all types of faults, while a three-phase fault blocks all power transmission between the two sources in the simple two-source system considered above.

Assume that the fault is a transient fault, so the transmission line goes back into the service after a trip and reclose sequence of a protective relay. The effect of the equivalent transmission reactance on the power angle curve for the pre-fault, fault, and post-fault states are shown in Figure 6 for different types of faults.

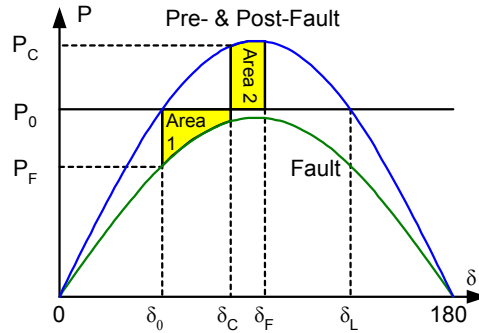


**Figure 6** Power Transmission Capability of the Normal System and With Different Types of Faults

### **Transiently Stable and Unstable Systems**

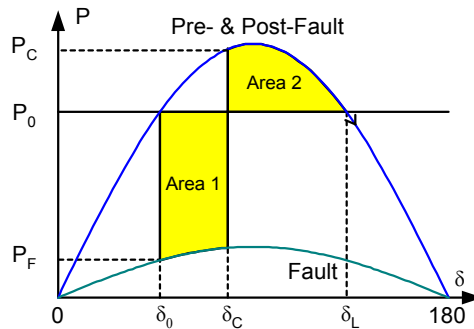
During normal operations of a generator, the output of electric power from the generator produces an electric torque that balances the mechanical torque applied to the generator rotor shaft. The generator rotor therefore runs at a constant speed with this balance of electric and mechanical torques. When a fault reduces the amount of power transmission, the electric torque that counters the mechanical torque is also decreased. If the mechanical power is not reduced during the period of the fault, the generator rotor will accelerate with a net surplus of torque input.

Assume that the two-source power system in Figure 1 initially operates at a balance point of  $\delta_0$ , transferring electric power  $P_0$ . After a fault, the power output is reduced to  $P_F$ , the generator rotor therefore starts to accelerate, and  $\delta$  starts to increase. At the time that the fault is cleared when the angle difference reaches  $\delta_C$ , there is decelerating torque acting on the rotor because the electric power output  $P_C$  at the angle  $\delta_C$  is larger than the mechanical power input  $P_0$ . However, because of the inertia of the rotor system, the angle does not start to go back to  $\delta_0$  immediately. Rather, the angle continues to increase to  $\delta_F$  when the energy lost during deceleration in area 2 is equal to the energy gained during acceleration in area 1. This is the so-called equal-area criterion.



**Figure 7** A Transiently Stable System

If  $\delta_F$  is smaller than  $\delta_L$ , then the system is transiently stable as shown in Figure 7. With sufficient damping, the angle difference of the two sources eventually goes back to the original balance point  $\delta_0$ . However, if area 2 is smaller than area 1 at the time the angle reaches  $\delta_L$ , then further increase in angle  $\delta$  will result in an electric power output that is smaller than the mechanical power input. Therefore, the rotor will accelerate again and  $\delta$  will increase beyond recovery. This is a transiently unstable scenario, as shown in Figure 8. When an unstable condition exists in the power system, one equivalent generator rotates at a speed that is different from the other equivalent generator of the system. We refer to such an event as a loss of synchronism or an out-of-step condition of the power system.



**Figure 8** A Transiently Unstable System

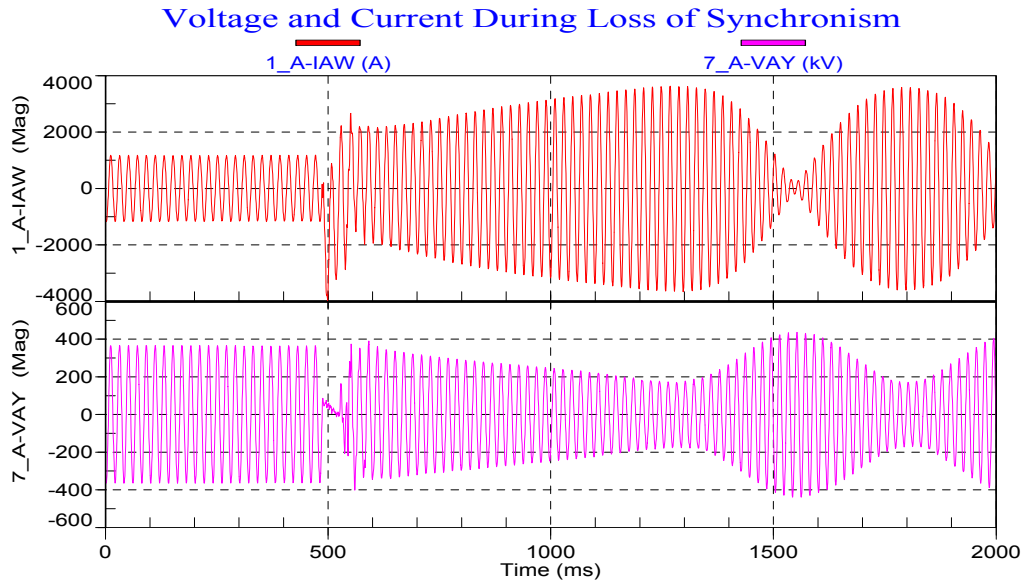
## LOSS OF SYNCHRONISM CHARACTERISTIC

Before we discuss the OOS philosophy, OOS detection methods, and the effect of loss of synchronism on transmission line relays, it is appropriate to review first the characteristic of an OOS or loss of synchronism condition.

The response of the power system to a disturbance depends on both the initial operating state of the system and the severity of the disturbance. A fault on a critical element of the power system followed by its isolation by protective relays will cause variations in power flows, network bus voltages, and machine rotor speeds. Voltage variations will actuate generator voltage regulators, and generator speed variations will actuate prime mover governors.

Depending on the severity of the disturbance and the actions of protective relays and other power system controls, the system may remain stable and return to a new equilibrium state experiencing what is referred to as a stable power swing. On the other hand, if the system is transiently

unstable it will cause large separation of generator rotor angles, large swings of power flows, large fluctuations of voltages and currents, and eventually lead to a loss of synchronism between groups of generators or between neighboring utility systems. When two areas of an interconnected power system lose synchronism, there is a large variation of voltages and currents throughout the power system. When the two areas are in phase the voltages are maximum and the currents are at a minimum. Conversely, when the two areas are 180 degrees out-of-phase the voltages are minimum and the currents are at a maximum. The large variation of voltages and currents is shown in Figure 9.



**Figure 9** Voltage and Current During Loss of Synchronism

### **Impedance Measured by Distance Relays During OOS**

During a system OOS event, a distance relay may detect the OOS as a phase fault if the OOS trajectory enters the operating characteristic of the relay. To demonstrate this, let us look at the impedance that a distance relay measures during an OOS condition for the simple two-source system.

Using the receiving-end source R as a reference, we can express the sending-end source as  $E_S \angle \delta$ . The current flowing on the line is,

$$I = \frac{E_S \angle \delta - E_R}{X} \quad (3)$$

The voltage measured at the sending-end bus can be found as,

$$V = E_S \angle \delta - X_S \cdot I \quad (4)$$

The measured impedance can then be expressed as,

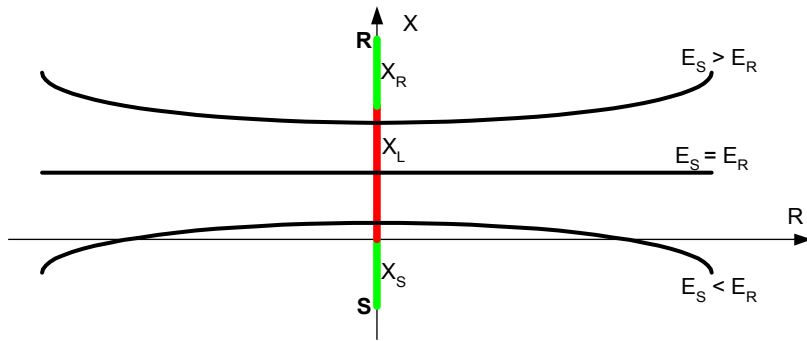
$$Zl = \frac{V}{I} = -X_S + X \frac{E_S \angle \delta}{E_S \angle \delta - E_R} \quad (5)$$



Assume  $E_S = E_R$  for a special case, then,

$$\begin{aligned}
 Z1 &= -X_S + X \frac{1}{1 - \angle -\delta} \\
 &= -X_S + X \frac{1 + \angle \delta}{(1 - \angle -\delta)(1 + \angle \delta)} \\
 &= -X_S + X \frac{1 + \cos \delta + j \sin \delta}{2j \sin \delta} \\
 &= -X_S + X \left[ \frac{1}{2} - j \left( \frac{1 + \cos \delta}{2 \sin \delta} \right) \right] \\
 &= \left( \frac{X}{2} - X_S \right) - j \left( \frac{X}{2} \cot \frac{\delta}{2} \right)
 \end{aligned} \tag{6}$$

This result shows that when  $\delta$  changes from  $0^\circ$  to  $360^\circ$  during an OOS, the impedance trajectory of  $Z1$  follows a straight line that offsets from the origin by  $(X/2 - X_S)$  and is perpendicular to the total reactance  $X$ . This  $Z1$  trajectory is shown in Figure 10 for a pure reactance system. When  $E_S \neq E_R$ , the  $Z1$  trajectory follows a group of circles as shown in the same figure.



**Figure 10**  $Z1$  Trajectory of OOS for Different  $E_S$  and  $E_R$  Ratios

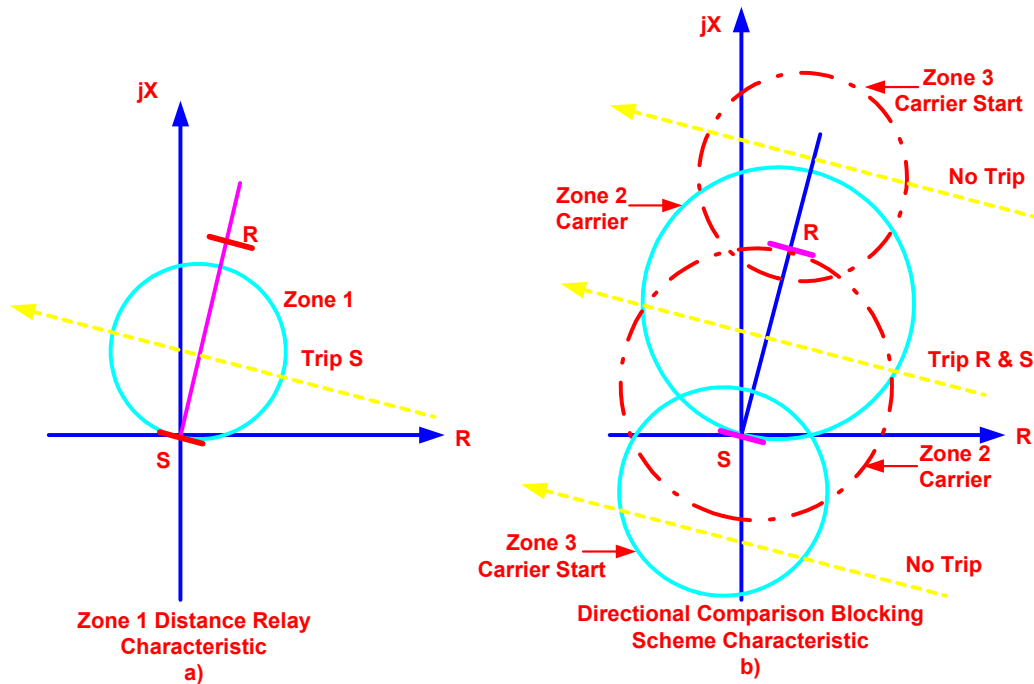
### **Effect of OOS Condition on Transmission Line Relays and Relay Systems**

The loss of synchronism between power systems or a generator and the power system affects transmission line relays and systems in various ways. Some relay systems such as segregated-line differential relay systems will not respond to an OOS condition and other relays such as overcurrent, directional overcurrent and distance relays may respond to the variations of voltage and currents and their phase angle relationship. In fact, some of the above relays may even operate for stable power swings for which the system should recover and remain stable.

Instantaneous phase overcurrent relays will operate during OOS conditions if the line current during the swing exceeds the minimum pickup setting of the relay. Likewise, directional instantaneous overcurrent relays may operate if the swing current exceeds the minimum pickup setting of the relay and the polarizing and operating signals have the proper phase relationship during the swing. Time-overcurrent relays probably will not operate, however, it most likely will depend on the swing current magnitude and the time delay settings of the relay.

Phase distance relays measure the positive-sequence impedance for three-phase and two-phase faults. It has been shown earlier that the positive-sequence impedance measured at a line terminal

during an OOS condition varies as a function of the phase angle separation  $\delta$  between the two equivalent system source voltages. Distance relay elements will operate during a power swing, stable or unstable, if the swing locus enters the distance relay operating characteristic. Keep in mind that the Zone 1 distance relay elements, with no intentional time delay, will be the distance relay elements most prone to operate during a power swing. Also very prone to operate during swings are Zone 2 distance relay elements used in pilot relaying systems, for example blocking or permissive type relay systems. Backup zone step distance relay elements will not typically operate during a swing, depending on their time-delay setting and the time it takes for the swing impedance locus to traverse through the relay characteristic. Figure 11a shows the operation of a Zone 1 distance relay when the swing locus goes through its operating characteristic and Figure 11b shows a directional comparison blocking scheme characteristic and how it may be impacted by the swing locus.



**Figure 11** Zone 1 and Directional Comparison Blocking Scheme Characteristics

It is important to recognize that the relationship between the distance relay polarizing memory and the measured voltages and currents plays the most critical role in whether a distance relay will operate during a power swing. Another important factor in modern microprocessor-type distance relays is whether the distance relay has a frequency tracking algorithm to track system frequency. Relays without frequency tracking will experience voltage polarization memory rotation with respect to the measured voltages and currents. Furthermore, the relative magnitude of the protected line and the equivalent system source impedances is another important factor in the performance of distance relays during power swings. If the line positive-sequence impedance is large when compared with the system impedances, the distance relay elements may not only operate during unstable swings but may also operate during swings from which the power system may recover and remain stable.

## OUT-OF-STEP PROTECTION PHILOSOPHY

The performance of protective relays that monitor power flows, voltages, and currents may respond to variations in system voltages and currents and cause tripping of additional equipment, thereby weakening the system and possibly leading to cascading outages and the shutdown of major portions of the power system. Protective relays prone to respond to stable or unstable power swings and cause unwanted tripping of transmission lines or other power system elements include: overcurrent, directional overcurrent, undervoltage, distance, and directional comparison systems.

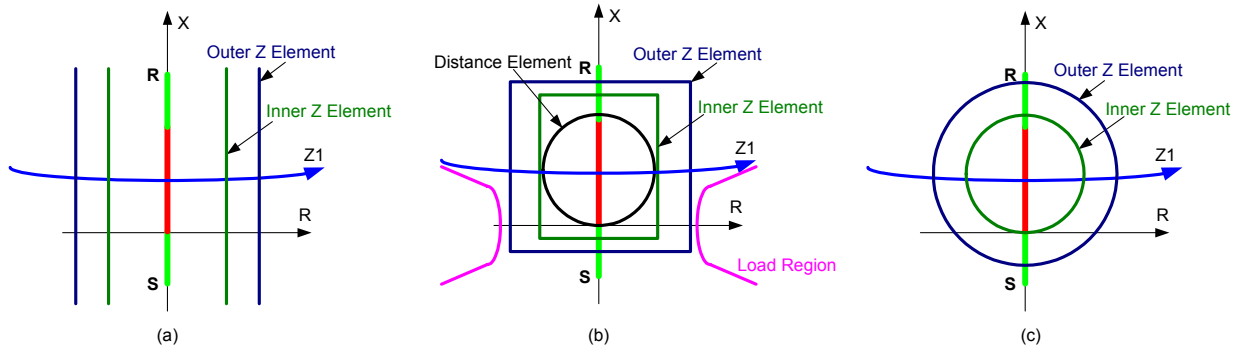
The philosophy of out-of-step relaying is simple and straightforward: avoid tripping of any power system element during stable swings. Protect the power system during unstable or out-of-step conditions. When two areas of a power system, or two interconnected systems, lose synchronism, the areas must be separated from each other quickly and automatically in order to avoid equipment damage and shutdown of major portions of the power system. Uncontrolled tripping of circuit breakers during an OOS condition could cause equipment damage and pose a safety concern for utility personnel. Therefore, a controlled tripping of certain power system elements is necessary in order to prevent equipment damage, and widespread power outages, and minimize the effects of the disturbance.

### **Out-of-Step Detection Methods and Types of Schemes**

Out-of-step protection functions detect stable power swings and out-of-step conditions by using the fact that the voltage/current variation during a power swing is gradual while it is virtually a step change during a fault. Both faults and power swings may cause the measured apparent positive-sequence impedance to enter into the operating characteristic of a distance relay element. A short circuit is an electromagnetic transient process with a short time constant. The apparent impedance moves from the prefault value to a fault value in a very short time, a few milliseconds. On the other hand, a power swing is an electromechanical transient process with a time constant much longer than that of a fault. The rate of change of the positive-sequence impedance is much slower during a power swing or OOS condition than during a fault and it depends on the slip frequency of the OOS. For example, if the frequency of the electromechanical oscillation is about 1 Hz and the impedance excursion required to penetrate the relay characteristic takes about half a period (a change in  $\delta$  of  $180^\circ$ ), the impedance change occurs in about 0.5 seconds. When  $\delta$  approaches  $180^\circ$  during an OOS, the measured impedance falls into the operating characteristic of a distance relay for a particular transmission line. The impedance measurement by itself cannot be used to distinguish an OOS condition from a phase fault. The fundamental method for discriminating between faults and power swings is to track the rate of change of measured apparent impedance.

The difference in the rate of change of the impedance has been traditionally used to detect an OOS condition and then block the operation of distance protection elements before the impedance enters the protective relay operating characteristics. Actual implementation of measuring the impedance rate of change is normally performed through the use of two impedance measurement elements together with a timing device. If the measured impedance stays between the two impedance measurement elements for a predetermined time, then an OOS is declared and an out-of-step blocking signal is issued to block the distance relay element operation. Impedance measurement elements with different shapes have been used over the time. These shapes include double blinders, concentric polygons, and concentric circles as shown in Figure 12.

To guarantee that there is enough time to carry out blocking of the distance elements after an OOS is detected, the inner impedance measurement element of the OOS detection logic must be placed outside the largest distance protection region that is to be blocked. The outer impedance measurement element for the OOS detection has to be placed away from the load region to prevent inadvertent OSB logic operation caused by heavy loads. These relationships among the impedance measurement elements are shown in Figure 12(b), using concentric polygons as OOS detection elements.



**Figure 12** Different Double Blender OSB Characteristics

### **Out-of-Step Protection Functions**

One of the traditional methods of minimizing the spread of a cascading outage caused by loss of synchronism is the application of out-of-step protection relay systems that detect OOS conditions and take appropriate actions to separate affected system areas, minimize the loss of load, and maintain maximum service continuity.

There are basically two functions related to out-of-step detection. One is the out-of-step tripping protection function that discriminates between stable and unstable power swings and initiates network sectionalizing or islanding during loss of synchronism. The other function, called out-of-step blocking protection function, discriminates between faults and stable or unstable power swings. The OSB function must block relay elements prone to operate during stable and/or unstable power swings. In addition, the OSB function must allow relay elements to operate during faults or faults that evolve during an out-of-step condition.

### **Out-of-Step Tripping and Blocking Functions**

Out-of-step tripping schemes are designed to protect the power system during unstable conditions, isolating unstable generators or larger power system areas from each other with the formation of system islands, in order to maintain stability within each island by balancing the generation resources with the area load.

To accomplish this, OOS tripping systems must be applied at preselected network locations, typically near the network electrical center, and network separation must take place at such points to preserve a close balance between load and generation. However, as discussed earlier, many relay systems are prone to operate at different locations in the power system during an OOS condition and cause undesired tripping. Therefore, OST systems must be complemented with out-of-step blocking functions to prevent undesired relay system operations, prevent equipment damage and shutdown of major portions of the power system, and achieve a controlled system separation.

In addition, OOS blocking must be used at other locations in the network to prevent system separation in an indiscriminate manner. Where a load-generation balance cannot be achieved, some means of shedding nonessential load or generation will have to take place to avoid a complete shutdown of the area.

Typically, the location of OST relay systems determines the location where system islanding takes place during loss of synchronism. However, in some systems it may be necessary to separate the network at a location other than the one where OST is installed. This is accomplished with the application of a transfer tripping type of scheme. Another important aspect of OOS tripping is to avoid tripping a line when the angle between systems is near 180 degrees. Tripping during this condition imposes high stresses on the breaker and can cause restrikes and breaker damage.

### **Application of OST and OSB Functions**

While the out-of-step relaying philosophy is simple, it is often difficult to implement it in a large power system because of the complexity of the system and the different operating conditions that must be studied. The selection of network locations for placement of OST systems can best be obtained through transient stability studies covering many possible operating conditions. The maximum rate of slip is typically estimated from angular change versus time plots from stability studies. With the above information at hand, reasonable settings can be calculated for well designed out-of-step tripping relaying schemes.

The recommended approach for out-of-step relaying application is summarized below:

1. Perform system transient stability studies to identify system stability constraints based on many operating conditions and stressed system operating scenarios. The stability studies will help identify the parts of the power system that impose limits to angular stability, generators that are prone to go out-of-step during system disturbances and those that remain stable, and groups of generators that tend to behave similarly during a disturbance. The results of stability studies are also used to identify the optimal location of OST and OSB protection relay systems because the apparent impedance measured by OOS relays is a function of the MW and MVar flows in the transmission lines.
2. Determine the locations of the swing loci during various system conditions and identify the optimal locations to implement the out-of-step tripping protection function. The optimal location for the detection of the OOS condition is near the electrical center of the power system. However, we must determine that the behavior of the impedance locus near the electrical center would facilitate the successful detection of OOS. There are a number of methods to determine the system electrical center, or whether the swing locus would go through a particular transmission line. Some of the methods are discussed in the Appendix.
3. Determine the optimal location for system separation during an out-of-step condition. This will typically depend on the impedance between islands, the potential to attain a good load/generation balance, and the ability to establish stable operating areas after separation. To limit the amount of generation and load shed in a particular island, it is essential that each island have reasonable generation capacity to balance the load demand. High impedance paths between system areas typically represent appropriate locations for network separation.
4. Establish the maximum rate of slip between systems for OOS timer setting requirements as well as the minimum forward and reverse reach settings required for successful detection of out-of-step conditions. The swing frequency of a particular power system area or group of

generators relative to another power system area or group of generators does not remain constant. The dynamic response of generator control systems, such as automatic voltage regulators, and the dynamic behavior of loads or other power system devices, such as SVCs and FACTS, can influence the rate of change of the impedance measured by OOS protection devices.

5. For out-of-step blocking schemes the OOS logic uses two concentric polygons, an outer zone and an inner zone. Two factors affect the OOS outer and inner zones impedance settings: the outermost overreaching zone of phase distance element you want to block and the load impedance the relay measures during the maximum anticipated load. The inner zone must be set to encompass the outermost overreaching zone of phase distance element you have selected for OSB. Set the outermost zone such that the minimum anticipated load impedance locus is outside the outermost zone. The OOS block time delay is set based on the settings of the inner and outer resistance blinders and the fastest stable swing frequency.
6. For out-of-step tripping schemes set the OST inner zone at a point along the OOS swing trajectory where the power system cannot regain stability. Set the OST outer zone such that the minimum anticipated load impedance locus is outside the outermost zone. The OST time delay is set based on the settings of the inner and outer zone resistance blinders and the fastest OOS swing frequency expected or determined from transient stability studies. When the swing impedance locus enters the outermost OOS zone, two timers are started one that detects OOS blocking conditions (OSBD) and the other that detects OOS tripping conditions (OSTD). The logic detects an OST condition if the OSTD timer expires and the positive-sequence swing impedance locus enters the OOS inner zone before OSBD timer expires. The OST logic allows you to trip on-the-way-in (TOWI) or trip-on-the-way-out (TOWO). TOWI is selected if one desires to trip when OSTD timer expires and the swing positive-sequence impedance enters the OST inner zone. TOWO is selected when one desires to trip when OSTD timer expires and the swing positive-sequence impedance enters and then exits the OST inner zone. TOWO is the most common way to apply out-of-step tripping since the breakers will be given a tripping command when the two equivalent voltage sources will be close to an in-phase condition. In rare occasions, system stability requirements are such that a TOWI is desired. Care should be exercised in such cases since the tripping command to circuit breakers will be issued when the two equivalent voltage sources will be close to an out-of-phase condition. Therefore, the user needs to verify with the circuit breaker manufacturer that the circuit breakers are capable of tripping for such a system condition to avoid breaker damage and ensure personnel safety.
7. Include mathematical models of the out-of-step blocking and tripping relay detection and operation behavior in transient stability studies to verify correct application of the out-of-step protection schemes.

## **DISTANCE PROTECTION FOR FAULTS DURING SYSTEM OUT-OF-STEP**

When the power system is in an OOS situation, its bus voltages and line currents vary in great magnitudes. Power system equipment is stressed to its limits under the overvoltage and overcurrent conditions during system OOS. Equipment failures like circuit breaker and transmission line flashovers are more likely to occur and will further promote an entire system collapse if they are not cleared reliably by the protection equipment. Although faults during system OOS are events with very small probability, proper operations against these faults are nevertheless extremely important to ensure controlled power system separation and continuous operation of remaining part of the power system.

Ideally, the performance requirements of protective relays under system OOS condition should be identical to those under normal system operations in terms of speed, selectivity, reliability, and sensitivity. However, due to the nature of the distance relay elements under system OOS, it is almost impossible to demand the same performance of the distance elements as those under normal system fault conditions.

### **Distance Protection Requirements During System OOS**

Because of the complexity and the rare occurrence of power system OOS, many utilities do not have clear performance requirements for distance relays during system OOS. The performances of distance elements are routinely exempt from being scrutinized in detail under system OOS conditions. In some other parts of the world, where the power system grids are weakly interconnected, utilities more often need to consider multiple contingencies like short circuit faults during power system OOS. They normally have more definite performance requirements for distance elements during system OOS. In the following sections we examine distance relay performance requirements from an Asian utility. We hope these discussions will promote the awareness of distance relay element response during system OOS and how to use modern microprocessor relays to satisfy some of the requirements.

#### **Speed: Distance Elements May Trip With a Time Delay During System OOS**

When a distance relay detects a swing or OOS condition, it sets an OSB relay word bit that may be used to block the distance element operations. These distance elements are operative again in case of unbalanced faults, only if negative-sequence overcurrent elements asserted during these faults reset the OSB. Traditionally, negative-sequence currents with some time delay reset the OSB condition. This time delay is necessary to coordinate with other protective devices in the event that the fault is external to the protected line section. In the following section, we show that a simple time delay does not guarantee the coordination when the OOS center does not stay in one location on the system. A simple time delay is also not applicable on parallel-line systems to restrain the distance relay from tripping for external faults. In the proposed tripping scheme during system OOS, we see that a coordinating time delay is not necessary.

#### **Selectivity: Distance Elements May Trip Three Poles For Internal SLG Faults During System OOS**

We show later that when negative-sequence current elements reset the OSB bit because of an unbalanced fault, all distance fault measurement loops will overreach protection zones simultaneously when the OOS center falls on the protected line and when the fault occurs at a large machine  $\delta$  angle. Therefore, it is not always possible for a distance relay to perform single-pole tripping for SLG faults during system OOS.

#### **Dependability: Distance Elements Must Trip All Internal Faults During System OOS**

This requirement tests relay sensitivity on detecting the negative-sequence current during unbalanced faults and OOS. Sometimes it may be difficult to pick up the negative-sequence overcurrent element to reset the OSB when the fault occurs at the voltage peak and a current minimum in an OOS cycle. For three-phase faults that do not produce any negative-sequence currents, it is also required that the distance relay have an impedance rate of change element to detect possible evolving three-phase faults during system OOS.

## Security:

- Distance elements must be secure to external faults during system OOS except external three-phase faults
- Distance elements may trip on any external faults if an OOS condition develops during a single-pole open condition

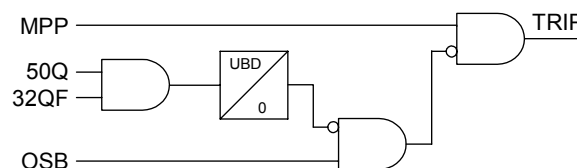
Security against external faults is traditionally gained by using a coordinating delay pickup timer of the negative-sequence overcurrent element that is used to reset OSB. This timer is set such that the fault would have been cleared by other responsible relays if it were an external fault. As we shall see below, using such a timer to gain the security is not always possible when the OOS center moves on the system. It is also impossible to use the coordinating timer on a parallel-line transmission system.

In single-pole tripping applications, the power system may become unstable after a protection device successfully clears an SLG fault and during a system pole-open period. In fact, the lack of security requirements for faults under such situations dictates that the distance relay reliably detect the OOS condition during the pole-open operating state, being able to discern a fault occurrence, and then reset the OSB bit dependably to allow the remaining distance elements to operate.

## Protection Challenge During OOS—Security Against External Faults

Figure 13 shows a logic diagram with a traditional OSB reset delay timer of a directional negative-sequence overcurrent element. MPP is a phase distance element. The OSB relay bit comes from a power swing detection logic. The OSB indicates that the distance relay already detected a swing condition under user-specified conditions and blocked the distance elements.

A negative-sequence forward directional element, 32QF, supervises the 50Q negative-sequence overcurrent element before it goes to the coordinating delay pickup timer. 32QF supervision ensures that the relay only resets the OSB bit when the fault it detects is in the forward direction.

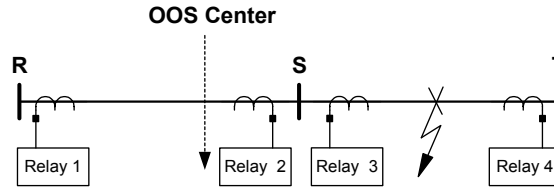


**Figure 13** Distance Elements With OOS Block and Time Delayed 50Q Reset

Figure 14 demonstrates the concept of using the UBD timer in resetting the OSB to coordinate with external faults during an OOS condition. When the system OOS center falls within the line section between stations R and S, the distance elements of Relay 1 at station R may overreach for an external fault that occurs on the line section S to T during an OOS condition. Since the fault is in the forward direction to Relay 1, the negative-sequence overcurrent element from the fault will reset its OSB bit. If the fault occurs during an OOS cycle when the machine angle  $\delta$  is large, the Zone 1 distance element of Relay 1 may pickup and trip the line instantaneously without UBD. To properly coordinate under such a fault scenario, we would set the UBD time such that Relay 3 and Relay 4 have a chance to clear the fault first before Relay 1 resets its OSB bit and allows its distance element to operate. That is, we would set the UBD time on the relays that see the OOS center in their Zone 1 region longer than the external fault clearance time.

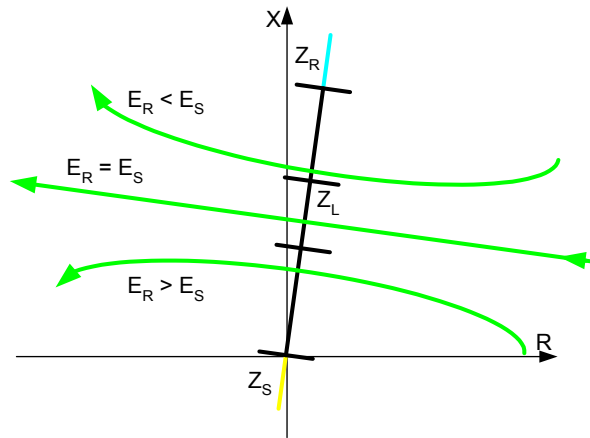


For the relays that do not see the OOS center in their Zone 1 protection region, the UBD setting value is not critical and may be set to a short time to speed up operations for in-section faults.



**Figure 14** Use UBD to Coordinate With External Faults During OOS

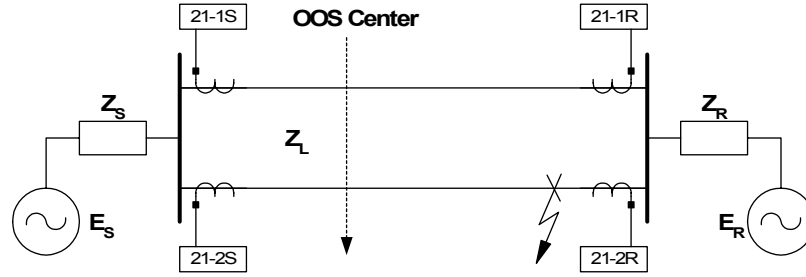
Unfortunately, the location of the OOS center on a power system is determined by both system impedance and the voltage magnitudes of two equivalent sources. Figure 15 shows that with fixed system impedance, the OOS center moves and cuts through the transmission line sections at different locations as the source voltage magnitudes change. This change of OOS center location may defeat the purpose of the UBD timer in coordinating with external faults. For example, in Figure 14, the UBD time for Relay 1 and 2 may be set to five cycles so that Relay 3 and Relay 4 have a chance to clear their in-section faults before Relay 1 and 2 reset their OSB blocking bit. UBD time for Relay 3 and 4 may be set to one cycle only to suppress filtering transients of negative-sequence quantities.



**Figure 15** The Location of OOS Center Is a Function of Source Voltage Magnitudes

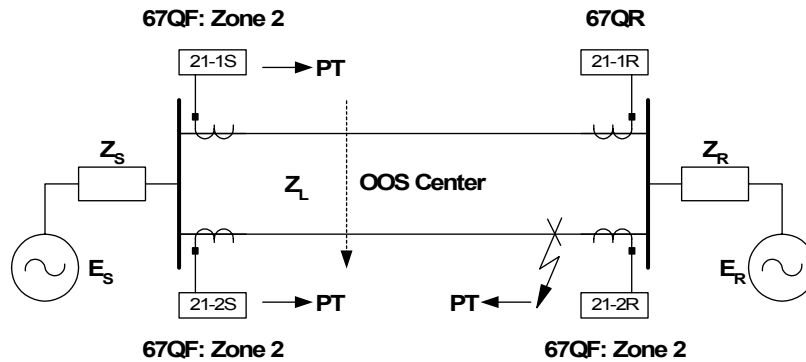
However, if source voltage magnitude fluctuations cause the OOS center to move to the line section between stations S and T, then the setting scheme depicted above will fail in its purpose. If a fault occurs on the line section of R to S during this time, then Relay 4 will reset its OSB within one cycle and will operate on this external fault before Relay 1 and 2 have a chance to reset their OSB bit and clear the fault.

On parallel-line systems shown in Figure 16, it is impossible to use the UBD time to coordinate with external faults. On parallel-line systems, a fault is internal to the pair of relays on one line, but external to the pair of relays on the other line. In the example of Figure 16, the OOS center cuts through the parallel lines and an unbalanced fault occurs on Line 2. Ideally, under this scenario, we would hope that the relays on Line 1 have a UBD time that is longer than the UBD time of the relays on Line 2 plus the fault clearance time. Nevertheless, the unbalanced fault may just have the same possibility of occurring on Line 1, so the UBD setting scheme we would hope will not work anymore.



**Figure 16** Parallel-Line Systems

To achieve the security for external faults during system OOS, we have to do something else. One possible solution is not to reset the OSB of Zone 1 distance elements due to the instantaneous overreach danger of these elements. Instead, we rely on the Zone 2 elements, together with a Permissive Overreaching Transfer Trip (POTT) scheme, to gain the security.



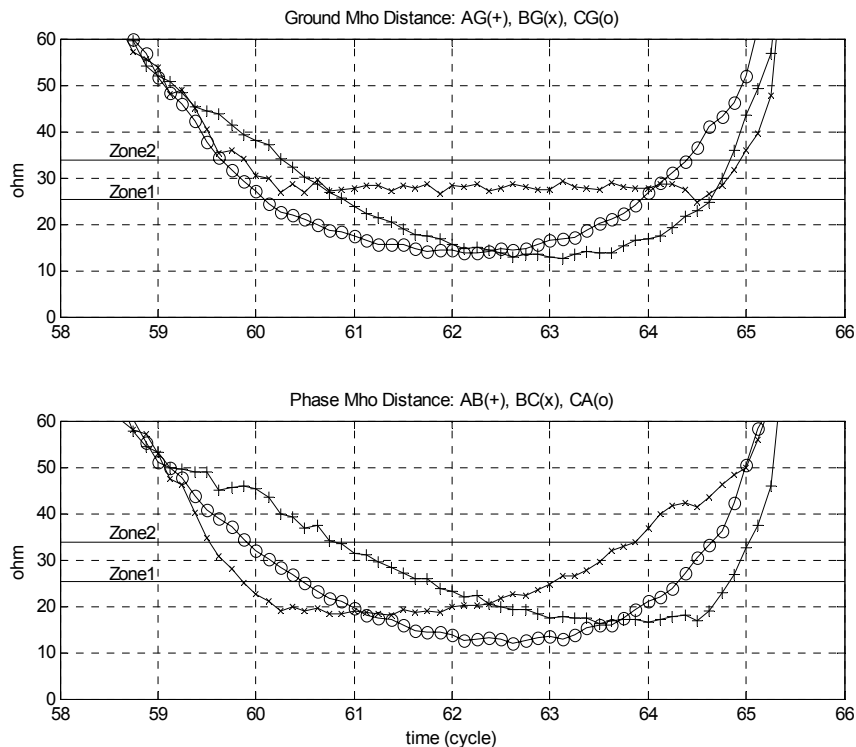
**Figure 17** Use POTT Scheme to Gain Protection Security During System OOS

Figure 17 shows how such a scheme works for the given fault during a system OOS situation. For relays on Line 2 on which the fault occurs, both relays detect the fault within their Zone 2 reach after the forward negative-sequence overcurrent element reset the OSB. In the POTT scheme, Zone 2 elements send out permissive transfer trip to the other end, and at the same time issue a trip locally if a permissive signal is received. Therefore, the relays on Line 2 will correctly operate and isolate the fault that is internal to them. For the relays on Line 1, the relay at Terminal S sees the fault within its forward Zone 2 region and therefore keys the permissive signal to the relay at Terminal R. The relay at Terminal R, however, detects the fault in its reverse direction, does not send a permissive signal, and disregards the received permissive signal from the relay at Terminal S. Therefore, the relays on Line 1 are secure to this external fault on Line 2.

Implementing such a POTT scheme during system OOS requires that the distance relay have two directional negative-sequence overcurrent elements to reset OSB for Zone 1 and Zone 2 distance elements separately. The directional negative-sequence overcurrent element that is used to reset OSB for the Zone 1 element must have torque control capability to allow users to disable resetting the OSB bit for the Zone 1 elements as their application requires.

## Protection Challenge During OOS—Faulted Phase Selection

Single-pole tripping is an important method to minimize the impacts to the power system after it is disturbed by SLG faults. To ensure that the power system can be separated in a controlled manner and balanced regional operations can be achieved during system OOS, it is especially important that the distance relays retain the single-pole tripping capability during system OOS. However, as we shall see below, it is quite difficult for the distance elements to discern the faulted phase during system OOS.

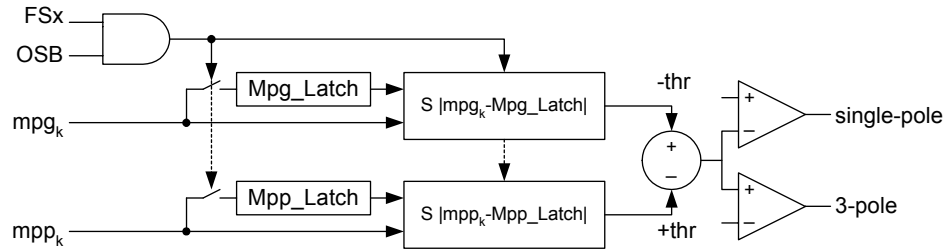


**Figure 18** Distance Calculations for a BG Fault During System OOS

For a B-phase ground fault at the end of a line, the upper plot of Figure 18 shows the distance calculations for A-phase, B-phase and C-phase elements. The faulted B-phase distance calculation provides the correct fault impedance. The distance calculations of unfaulted phases move into protection Zone 2 and Zone 1 regions as the machine  $\delta$  approaches  $180^\circ$ . The lower plot of Figure 18 shows the distance calculations of phase elements. All phase distance calculations move into protection regions as the machine  $\delta$  approaches  $180^\circ$  during system OOS.

One microprocessor-based relay uses the angle difference of negative- and zero-sequence currents in its faulted-phase selection. The phase-angle plane is divided into three regions: from  $-60^\circ$  to  $60^\circ$  for the A-phase region,  $60^\circ$  to  $180^\circ$  for the B-phase region, and  $-60^\circ$  to  $-180^\circ$  for the C-phase region. For example, when the phase-angle difference of negative- and zero-sequence currents falls into the  $-60^\circ$  to  $60^\circ$  region, the fault-type selection logic asserts FSA, indicating a selection of A-phase. However, when FSA asserts, it could mean either an A-phase ground fault or a BC double-phase ground fault. The microprocessor-based distance relay therefore calculates both A-phase ground distance and BC-phase distance elements. For a normal fault without a system OOS situation involved, only one of the distance elements will give an output and allow

the relay to trip correctly. However, as we saw from the previous B-phase ground fault example during system OOS, even if the relay correctly picks up FSB, it will assert both B-phase ground and CA-phase distance elements and issue three-pole permissive and local trips for the SLG fault.



**Figure 19** Fault Phase Selection Logic during System OOS

Figure 19 shows a patent-pending logic that will correctly select the faulted phase under the difficult situation of faults during system OOS. At the time that the relay asserts a phase selection output during the OSB, the relay latches in corresponding ground and phase distance calculations. The relay then starts to integrate the differences between following distance calculations and its latched value for both ground and phase distance elements. If the ground distance difference integration is less than the difference integration of the phase distance with a margin, the relay will declare the fault type as an SLG fault and allow the ground distance element to generate a single-pole trip output. Otherwise, the relay will declare a multiphase fault type and initiate three-pole permissive and local trips.

## FUTURE DEVELOPMENTS

The majority of out-of-step tripping systems installed throughout the world today use local measurements, in other words, transmission line voltages and currents at one end of a transmission line. One disadvantage of such a scheme is its inability to have knowledge of what takes place at other parts of a complex power system network. Therefore, even if the out-of-step tripping system is well designed and appropriately set, it still has a number of disadvantages in minimizing the effects of the disturbance.

More recent technological advancements in microprocessor relays, combined with GPS receivers for synchronization and accurate time stamping, is providing users advanced relay systems with synchronized measurements, called synchrophasor measurements [2][3]. Synchrophasor measurements together with advancements in digital communications, provides users with the power system state at a rate of twenty times per second. Synchrophasor measurements from different network locations, when combined and processed in a central computer system, will provide users with the absolute phase angle difference between distant network buses with an accuracy of tenths of an electrical degree. These types of central computer systems, equipped with wide-area protection and control algorithms, will be able to better address future system out-of-step conditions and other system problems because they will have a better knowledge of what happens throughout the power system. In addition, knowledge of online generation and load demand provided from synchrophasor measurement systems will aid in balancing better the generation and load during islanding, as well as minimizing load and generation shedding in order to preserve stability during major system disturbances.

A couple of pilot systems based on phasor measurements have been installed in North America and France to detect out-of-step conditions [4][5]. Further improvements of these techniques and

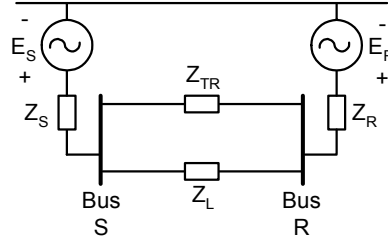
their application in wide-area protection and control systems will improve the reliability and security of interconnected power systems.

## CONCLUSIONS

- Power systems must be designed to maintain system stability during large disturbances and utilities must take every action economically justifiable to prevent system instability, by using remedial actions or special protection systems.
- Out-of-step relaying systems should be applied to preserve system stability and minimize the consequences of major disturbances. Out-of-step relaying should be depended upon as the last resort before a complete system shutdown.
- Out-of-step relaying systems prevent uncontrolled tripping of transmission lines, minimize the extent of the disturbance, and protect equipment from being damaged, thus ensuring personnel safety and faster service restoration.
- Out-of-step tripping systems should be applied at proper network locations to detect OOS conditions and separate the network at pre-selected locations only in order to create system islands with balanced generation and load demand that will remain in synchronism.
- Out-of-step tripping systems must be supplemented with out-of-step blocking systems to block relay elements prone to operate during stable or unstable power swings.
- To preserve the protection security against external faults during system OOS, it is necessary to block distance Zone 1 elements for those relays that the OOS center falls into their Zone 1 protection region. Use a negative-sequence overcurrent element only to reset OSB to Zone 2 distance elements and rely on POTT tripping scheme to guarantee that distance relays do not overreach for external faults.
- The patent-pending faulted phase selection logic ensures that distance relays correctly identify if a fault is a single-phase or a multi-phase fault, and therefore keep their much desired single-pole tripping capability during system OOS.

## APPENDIX

To determine whether the swing locus would traverse a particular transmission line during loss of synchronism we need to reduce the complex power system, excluding the line of interest, to a two-source equivalent system shown in Figure A1. This can be achieved with reasonable accuracy using a number of methods.



**Figure A1** Two-Source System Equivalent

### First Method:

The easiest method for developing this equivalent is to use the output of a commercially available short circuit program. First, we need to delete from the network the transmission line of interest, and request the short circuit program to calculate an equivalent two-port network as seen from the two ends of the line of interest. The short circuit program will compute  $Z_S$ ,  $Z_R$ , and  $Z_{TR}$  impedances. Reintroduce the line impedance  $Z_L$  in parallel with the equivalent transfer impedance  $Z_{TR}$ , and calculate the total impedance  $Z_T$  given by equation A1.

$$Z_T = Z_S + \left[ \frac{(Z_{TR} Z_L)}{(Z_{TR} + Z_L)} \right] + Z_R \quad (A1)$$

The swing locus will bisect  $Z_T$ , given equal source voltage magnitudes as a reasonable initial assumption.

### Second Method:

The second method, developing a two-source equivalent, is based on the knowledge of the total three-phase fault currents at the end of the transmission line of interest and the line current flow for each respective fault.

Given the following data:

$I_{3Ph-S}$  = Total fault current for a three-phase fault at Bus S in p.u.

$I_{3Ph-R}$  = Total fault current for a three-phase fault at Bus R in p.u.

$I_{3Ph-RS}$  = Fault current contribution over the line for a three-phase fault at Bus S in p.u.

$I_{3Ph-SR}$  = Fault current contribution over the line for a three-phase fault at Bus R in p.u.

$Z_L$  = Transmission line positive-sequence impedance

First calculate the following distribution factors:

$$K_S = \frac{I_{3Ph-RS}}{I_{3Ph-S}} \quad (A2)$$

$$K_R = \frac{I_{3Ph-SR}}{I_{3Ph-R}} \quad (A3)$$

A wye-system equivalent shown in Figure A2, excluding the transmission line of interest, can be developed using the following formulas:

$$X_1 = \frac{K_S Z_L}{1 - (K_S + K_R)} \quad (A4)$$

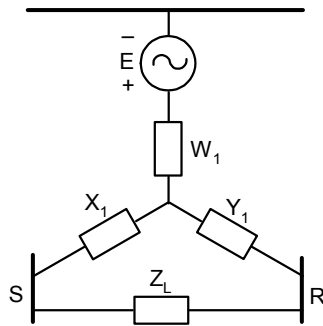
$$Y_1 = \frac{K_R Z_L}{1 - (K_S + K_R)} \quad (A5)$$

$$W_1 = Z_{Th-S} - X_1(1 - K_S) \quad (A6)$$

Where  $Z_{Th-S}$  is the positive-sequence driving point impedance for a fault at Bus S given by:

$$Z_{Th-S} = \frac{1.0}{I_{3Ph-S}} \quad (A7)$$

This wye-system equivalent shown in Figure A2 can be converted to a delta equivalent shown in Figure A1 using the well-known wye-delta conversion formulas.

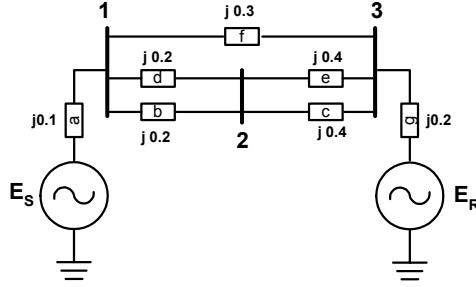


**Figure A2** Wye-System Equivalent With Line Reintroduced Between Buses S and R

### Example:

The following example demonstrates the above procedure for determining a two-port equivalent.

Given the system shown in Figure A3, obtain the equivalent as viewed looking into buses 2 and 3, and determine whether the swing locus passes through transmission line c.



**Figure A3** Example Network for Swing Locus Study

First form the bus nodal admittance matrix  $Y_{BUS}$  and invert it to calculate the bus impedance matrix  $Z_{BUS}$ . For the above network the  $Z_{BUS}$  matrix is given by:

$$Z = \begin{pmatrix} 0.07777781j & 0.06666667j & 0.04444437j \\ 0.06666667j & 0.13333333j & 0.06666667j \\ 0.04444437j & 0.06666667j & 0.11111126j \end{pmatrix}$$

Using the driving-point impedances for buses 2 and 3 we can calculate the total three-phase fault currents in p.u. for faults at these two buses. For a fault at Bus 2 the voltage at Bus 3 is 0.5 p.u. Therefore, the fault current flowing through line “c” is  $-j1.25$  p.u. For a fault at Bus 3 the voltage at Bus 2 is 0.4 p.u., and the fault current flowing through line “c” is  $-j1.0$  p.u.

The fault currents are:

$$\begin{aligned} I_{3Ph-2} &= -j7.5 \text{ p.u. total three-phase fault current for a three-phase fault at Bus 2.} \\ I_{3Ph-3} &= -j9.0 \text{ p.u. total three-phase fault current for a three-phase fault at Bus 3.} \\ I_{3Ph-32} &= -j1.25 \text{ p.u. fault current over line “c” for a three-phase fault at Bus 2.} \\ I_{3Ph-23} &= -j1.0 \text{ p.u. fault current over line “c” for a three-phase fault at Bus 3.} \\ Z_L &= j0.4 \text{ p.u. transmission line positive-sequence impedance.} \end{aligned}$$

Therefore, substituting the above currents in the equations given above, we calculate the following impedances for the star equivalent:

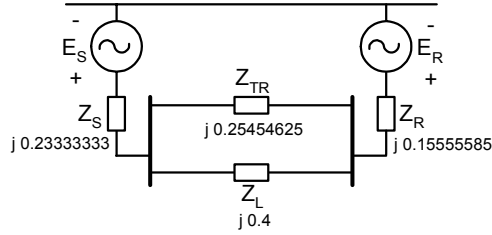
$$\begin{aligned} K_S &= 0.166667, & K_R &= 0.111111 \\ X_1 &= j 0.09230791, & Y_1 &= j 0.06153842, & W_1 &= j 0.05640977 \end{aligned}$$

Using the wye-delta conversion formulas we calculate the following impedances for the two-source equivalent:

$$Z_R = j 0.233333, \quad Z_S = j 0.155555, \quad Z_{TR} = j 0.254547$$

The two-source equivalent is shown in Figure A4.





**Figure A4** Equivalent Network Between Buses 2 & 3

The total impedance between the two sources is  $Z_T = j 0.544455$  p.u. and  $0.5Z_T = j 0.2722275$  p.u. By inspection of the equivalent network of Figure A4 we determine that the swing locus will pass through line “c.” In a similar manner we can verify that the swing locus does not pass through line “b.”

### **Third Method:**

This method is based on forming a 2x2 matrix having elements of the driving-point and transfer impedances of the original network for the retained line-end buses with respect to the reference bus, with the line of interest removed from the original network.

First remove line “c” from the original network, example above, and calculate the  $Z_{BUS}$  matrix for the modified network. The  $Z_{BUS}$  matrix with line “c” removed from the network is given bellow:

$$Z = \begin{pmatrix} 0.07948723j & 0.07179489j & 0.04102554j \\ 0.07179489j & 0.14871796j & 0.05641022j \\ 0.04102554j & 0.05641022j & 0.11794892j \end{pmatrix}$$

From the above matrix we extract a small matrix,  $Z_{eq}$ , corresponding only to the buses to be retained, in our example buses 2 and 3. This small 2x2 matrix gives the driving-point and transfer impedances of the original network for the retained buses with respect to the reference bus. The result is shown bellow:

$$Z_{eq} = \begin{pmatrix} 0.14871796j & 0.05641022j \\ 0.05641022j & 0.11794892j \end{pmatrix}$$

The  $Z_{eq}$  matrix can also be obtained by knowledge of the three-phase fault current at Bus 2 and Bus 3 in p.u., and the corresponding voltage at Bus 3 in p.u. for a three-phase fault at Bus 2. For this example the three-phase current for a fault at Bus 2 is  $-6.72413757j$  p.u., and the corresponding voltage at Bus 3 is  $0.62068994$  p.u. Furthermore, the three-phase fault current for a fault at Bus 3 is  $-8.4782467j$  p.u. To find the off-diagonal elements of  $Z_{eq}$  we divide the change in positive-sequence voltage at Bus 3 during a three-phase fault at Bus 2 by the total three-phase fault current at Bus 2. The change in positive-sequence voltage at Bus 3 is  $(1.0 - 0.62068994$  p.u.). The diagonal elements of  $Z_{eq}$  are found by the reciprocal of the total three-phase fault currents in p.u. for each retained bus.

Inverting  $Z_{eq}$  produces the equivalent nodal admittance matrix  $Y_{eq}$  of the equivalent mesh network between the retained buses, which is equal to:

$$Y_{eq} = \begin{pmatrix} -8.21427959j & 3.92855918j \\ 3.92855918j & -10.35711837j \end{pmatrix}$$

The diagonal element  $y_{ii}$  of the nodal admittance matrix is the sum of the admittances connected to a particular bus. The off-diagonal element  $y_{ij}$  is the negative of the admittance between buses  $i$  and  $j$ . Furthermore, the admittances that are connected to the reference bus are included in the diagonal element summations. Now, define a new  $Y_n$  matrix in which the diagonal elements of  $Y_{eq}$  are replaced by the sum of the elements of a particular row and the off-diagonal elements by their negative value. For the above example we have:

$$Y_n = \begin{pmatrix} -4.28572041j & -3.92855918j \\ -3.92855918j & -6.42855918j \end{pmatrix}$$

Calculate a new  $Z_n$  matrix by taking the reciprocals term by term of each of the elements in the  $Y_n$  matrix. The new  $Z_n$  matrix is given by:

$$Z_n = \begin{pmatrix} 0.233333j & 0.25454625j \\ 0.25454625j & 0.15555585j \end{pmatrix}$$

The equivalent network is shown in Figure A4 with the diagonal elements of the  $Z_n$  matrix representing the source impedances for the sending and receiving end and the off-diagonal element representing the transfer impedance between the two reduced network equivalent sources.

## REFERENCES

- [1] "Wide Area Protection and Emergency Controls," IEEE Power System Relaying Committee, 2002 Report, available at <http://www.pes-psrc.org/>.
- [2] A. G. Phadke et al., "Synchronized Sampling and Phasor Measurements for Relaying and Control," IEEE Transactions on Power Delivery, Vol. 9, No. 1, January 1994.
- [3] Edmund O. Schweitzer III, Gabriel Benmouyal, Armando Guzman, "Synchronized Phasor Measurement in Protective Relays for Protection, Control, and Analysis of Electrical Power Systems," Proceedings of the 29th Annual Western Protective Relay Conference, Spokane, WA, October 22–24, 2002.
- [4] V. Centeno, J. De La Ree, A. G. Phadke, G. Mitchell, J. Murphy, R. Burnett, "Adaptive Out-of-Step Relaying Using Phasor Measurement Techniques," IEEE Computer Applications in Power, Vol 6, Issue 4, October 1993.
- [5] O. Faucon, and Laurent Dousset, "Coordinated Defense Plan Protects Against Transient Instabilities," IEEE Computer Applications in Power, Vol 10, Issue 3, July 1997.
- [6] SEL Application Guide AG97-13, "SEL-321-5 Relay Out-Of-Step Logic," Daqing Hou, Shaojun Chen, and Steve Turner.
- [7] Daqing Hou, Armando Guzman, and Jeff Roberts, "Innovative Solutions Improve Transmission Line Protection," Proceedings of the 24th Western Protective Relay Conference, Spokane, WA, October 1997.
- [8] Edward Wilson Kimbark, Sc.D, Power System Stability, John Wiley and Sons, Inc., New York, 1950, Vol II.

## BIOGRAPHIES

**Demetrios A. Tziouvaras** has a B.S. and M.S. in Electrical Engineering from University of New Mexico and Santa Clara University respectively. He is an IEEE Senior member and a member of the Power Engineering Society, the Power System Relaying Committee, and CIGRE. He joined Schweitzer Engineering Laboratories Inc. in 1998 and currently he holds the position of Senior Research Engineer. He was with Pacific Gas and Electric since 1980 where he held various protection engineering positions including Principal Protection Engineer responsible for protection design standards, new technologies, and substation automation. He holds three patents associated with power system protection using microprocessor technology and is the author or co-author of more than 20 IEEE and Protective Relay Conference papers. Currently he is the convenor of CIGRE WG B5-15 on “Modern Distance Protection Functions and Applications” and a member of several IEEE PSRC and CIGRE working groups.

**Daqing Hou** received BS and MS degrees in Electrical Engineering at the Northeast University, China, in 1981 and 1984, respectively. He received his Ph.D. in Electrical and Computer Engineering at Washington State University in 1991. Since 1990, he has been with Schweitzer Engineering Laboratories, Inc., Pullman, Washington, USA, where he has held numerous positions including development engineer, application engineer, and R&D manager. He is currently a principal research engineer. His work includes system modeling, simulation and signal processing for power systems and digital protective relays. His research interests include multivariable linear systems, system identification, and signal processing. He holds multiple patents and has authored or co-authored over 20 technical papers. He is a senior member of IEEE.