



**QUEEN'S
UNIVERSITY
BELFAST**

Outdated Access Point Selection for Mobile Edge Computing with Cochannel Interference

Lai, X., Xia, J., Fan, L., Duong, T. Q., & Nallanathan, A. (2022). Outdated Access Point Selection for Mobile Edge Computing with Cochannel Interference. *IEEE Transactions on Vehicular Technology*.
<https://doi.org/10.1109/TVT.2022.3167405>

Published in:
IEEE Transactions on Vehicular Technology

Document Version:
Peer reviewed version

Queen's University Belfast - Research Portal:
[Link to publication record in Queen's University Belfast Research Portal](#)

Publisher rights
Copyright 2022, IEEE
This work is made available online in accordance with the publisher's policies. Please refer to any applicable terms of use of the publisher.

General rights
Copyright for the publications made accessible via the Queen's University Belfast Research Portal is retained by the author(s) and / or other copyright owners and it is a condition of accessing these publications that users recognise and abide by the legal requirements associated with these rights.

Take down policy
The Research Portal is Queen's institutional repository that provides access to Queen's research output. Every effort has been made to ensure that content in the Research Portal does not infringe any person's rights, or applicable UK laws. If you discover content in the Research Portal that you believe breaches copyright or violates any law, please contact openaccess@qub.ac.uk.

Open Access
This research has been made openly available by Queen's academics and its Open Research team. We would love to hear how access to this research benefits you. – Share your feedback with us: <http://go.qub.ac.uk/oa-feedback>

Outdated Access Point Selection for Mobile Edge Computing with Cochannel Interference

Xiazhi Lai, Junjuan Xia, Lisheng Fan, Trung Q. Duong, and Arumugam Nallanathan, *Fellow, IEEE*

Abstract—In this paper, we investigate a mobile edge computing (MEC) network, where the user has some computational tasks to be assisted by multiple computational access points (CAPs) through offloading. We consider practical communication scenarios with limited spectrum resources, and the cochannel interference arising from the aggressive reuse of frequency severely degrades the system offloading performance. To enhance the system performance, we provide three CAP selection criteria to choose one best CAP among multiple ones. Specifically, *criterion I* maximizes the computational capability at the CAP, *criterion II* minimizes the interfering power, while *criterion III* maximizes the instantaneous channel gain of data link. In time-varying channel environments, the CAP selection may be outdated, which deteriorates the system performance. For the three criteria, we evaluate the system outage probability in the outdated channel state information (CSI) by taking into account the latency, energy consumption and data rate, and provide the analytical and asymptotic expressions of outage probability, from which we obtain some critical insights on the system design. Simulation results are finally demonstrated to verify the proposed studies. In particular, criterion III under the perfect CSI can achieve the system whole diversity order coming from multiple CAPs.

Index Terms—Mobile edge computing, cochannel interference, outage probability, task offloading.

I. INTRODUCTION

A. Literature Review

In recent years, there has been a great progress in the development of wireless communication and data science [1]–[4]. To cope with the challenge from the ever-increasing data and nodes in wireless networks such as Internet of Things (IoT), some new network architectures should be developed. For instance, cloud-based computing provided vast computational capability, yet the latency of transmission may not meet the requirements of some IoT applications, e.g. autonomous driving and augmented reality. To reduce the overhead for communications, mobile edge computing (MEC) network was proposed to evolve from cloud-based computing network, and it has attracted a lot of attention from both academy and

industry [5], [6]. MEC can support users in the network to compute some computation-heavy tasks, through offloading the tasks to the computational access points (CAPs) [7]–[10]. In this way, the system performance such as the latency and energy consumption can be guaranteed.

A key design in the MEC networks is the offloading strategy, which determines how many parts of the tasks should be computed by the CAPs. In essence, offloading is to utilize the computational resources from the CAPs at the cost of wireless transmission [11], [12]. A lot of researches have been done to achieve a fine trade-off between the communication and computation. In this direction, the authors in [13] studied the opportunistic CAP selection for the MEC network with two CAPs, and devised an offloading strategy to improve the system outage performance in terms of latency and energy consumption. For multiuser cache-enabled MEC networks, the authors in [14] provided a pricing scheme to fulfill the data-caching and task-offloading decisions. In further, a multi-access edge computing system was analyzed in [15], where the fronthaul and backhaul constraints have been taken into account. For green communications, the wireless-powered MEC networks were analyzed in [16]–[21], where the offloading strategy and computing frequency were jointly optimized to enhance the computation efficiency. In particular, the authors in [16] proposed an energy-harvesting rule to maximize the data processing rate across fading blocks. In [18], the authors determined the time intervals for energy harvesting and task offloading for each user. Later, the computation rate of unmanned aerial vehicle (UAV)-enabled network was maximized by adjusting the offloading mode and computing frequency at the users [20]. Moreover, a joint power allocation, subcarrier assignment and task offloading scheme was proposed for fog computing networks [21].

Due to limited frequency resources, cochannel interference has become inevitable in the wireless networks. Cochannel interference has limited the system performance severely, and become the bottleneck of the wireless networks. The impact of interference on the system performance of wireless networks has been extensively studied in the literature [22]–[25]. In [23], the authors studied the dual-hop relaying networks in the presence of cochannel interference in a wide range of signal-to-interference-plus-noise ratio (SINR), and provided analytical expressions of system outage probability. In addition, the authors in [24] analyzed the secure performance of amplify-and-forward relay networks with cochannel interference. For the secure relay networks in cochannel interference environments, the system performance could be studied by deriving the analytical and asymptotic secrecy outage probability expressions,

X. Lai, J. Xia, and L. Fan are all with the School of Computer Science and Cyber Engineering, Guangzhou University, China (e-mail: {xiajunjuan,lshfan}@gzhu.edu.cn).

T. Q. Duong is with the School of Electronics, Electrical Engineering and Computer Science, Queens University Belfast, BT7 1NN, U.K. (e-mail: trung.q.duong@qub.ac.uk).

A. Nallanathan is with the School of Electronic Engineering and Computer Science, Queen Mary University of London, London, U.K (e-mail: a.nallanathan@qmul.ac.uk).

This work was supported in part by the NSFC (No. 61871139/62101145), by the Natural Science Foundation of Guangdong Province (No. 2021A1515011392), and by the research program of Guangzhou University (No. YJ2021003).

The corresponding author of this paper is Lisheng Fan.

through which the effect of interfering power distribution on the system performance could be revealed. To alleviate the degradation of cochannel interference, the authors in [26]–[28] designed a joint power and channel allocation scheme, which maximized the throughput of secondary users under the constraint of worst-case outage probability at primary receivers. In further, the authors in [27] exploited the benefit of interference in non-orthogonal multiple access (NOMA) systems to confuse the eavesdroppers, and therefore improved the network security. So far, to the best of our knowledge, there has been little work on the MEC networks in cochannel interference environments, which motivates the work in this paper.

B. Contribution

In this paper, we investigate a MEC network in the outdated CAP selection and cochannel interference environments, where the user has some computational tasks to be assisted by multiple CAPs through offloading. To enhance the system performance, we provide three CAP selection criteria to choose one best CAP among multiple ones. Specifically, *criterion I* maximizes the computational capability at the CAP, *criterion II* minimizes the interfering power, while *criterion III* maximizes the instantaneous channel gain of data link. For the three criteria, we evaluate the system outage probability in the outdated channel state information (CSI) by taking into account the latency, energy consumption and data rate, and provide the analytical and asymptotic expressions of outage probability, from which we obtain some critical insights on the system design. Simulation results are finally demonstrated to verify the proposed studies. In particular, criterion III under the perfect CSI can achieve the system whole diversity order coming from multiple CAPs. The main contributions of this work are summarized as follows,

- We study a MEC network in the presence of cochannel interference and outdated CAP selection, where the user can accomplish the computational tasks with the help of multiple CAPs.
- We present three CAP selection criteria to improve the system performance measured by the data rate, latency and energy consumption, through maximizing the computational capability, minimizing the interfering power and maximizing the desired signal power, respectively.
- For the three criteria, we provide the analytical expressions for the system outage probability, which can help evaluate the system performance in the whole range of SINR.
- We also provide the asymptotic expressions of system outage probability in the high regime of SINR, from which we obtain some key insights into the impact of cochannel interference and outdated CAP selection on the MEC networks.

C. Organization

The organization of this paper is given as follows. After the introduction in Sec. I, we describe the system model of MEC networks with cochannel interference in Sec. II.

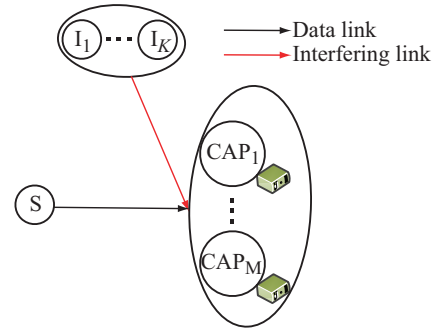

Fig. 1. A multi-CAP MEC network in cochannel interference environments.

Then, we present three CAP selection criteria to enhance the system performance in Sec. III. After that, we provide the system performance analysis by deriving the analytical and asymptotic expressions of outage probability in Sec. IV. Sec. V demonstrates the simulation and analytical results, and we finally conclude the work of this paper in Sec. VI.

II. SYSTEM MODEL

Fig. 1 shows a MEC network in the presence of multiple cochannel interferers, where the user S in the network has some computational tasks which can be accomplished with the help of M computational access points (CAPs). Let L denote the task length of the user S , and we use b_m to denote the computational capability at the m -th CAP. Moreover, we use b_0 to denote the local computational capability at the user, which can be varying in practice, due to many factors such as dynamic tasks and processes in the user terminal. In contrast, the computational capability at the edge servers is often fixed, as the computational resource allocated to the users in the MEC networks is often based on the user's demand, and accordingly the computational capability allocated to the users can be set to a fixed value. Hence, we focus on the randomness of computational capability at the user side only. Without loss of generality, we assume that b_0 follows the uniform distribution with interval $[b_{min}, b_{max}]$ ¹. Due to the requirement from the latency and energy consumption, the local user S cannot compute its task completely by itself. In other words, some part of task should be offloaded to the multiple CAPs through wireless transmission affected by K cochannel interferers. The channels in the network are subject to Rayleigh flat fading, and each terminal is equipped with a single antenna due to the size limitation.

Suppose that the m -th CAP is chosen to help compute the computational task, and the offloading ratio is $d \in [0, 1]$, indicating that $(1-d)L$ bits are computed at local, while the residual dL bits are computed by the CAP. The local latency $\phi_{0,t}$ and energy consumption $\phi_{0,E}$ are,

$$\phi_{0,t} = \frac{(1-d)L\kappa}{b_0}, \quad (1)$$

¹Note that the uniform distribution is often used to model the local computational capability in the MEC networks [6], [8], [29], [30]. When some other kinds of distribution are used, such as normal distribution or exponential distribution, the results in this work will be changed accordingly, whereas the analysis method in this work can be easily extended.

$$\phi_{0,E} = \frac{(1-d)LP_0\kappa}{b_0}, \quad (2)$$

where κ is the required CPU cycles to compute one bit, and P_0 is the computational power at the user. When the offloading occurs with $d > 0$, the transmission data rate of the link from the user S to the m -th CAP is,

$$R_m = B \log_2 \left(1 + \frac{P_u |g_m|^2}{\sigma^2 + P_I |g_m^I|^2} \right), \quad (3)$$

with

$$|g_m^I|^2 = \sum_{k=1}^K |g_{m,k}^I|^2, \quad (4)$$

where B is the wireless bandwidth, P_u is the transmit power of the user S , and P_I is the transmit power of the interferers. Notations $g_m \sim \mathcal{CN}(0, \varepsilon)$ and $g_{m,k}^I \sim \mathcal{CN}(0, \varepsilon_I)$ denote the channel parameters of the data and interfering links, respectively. From (3), we can see that the existence of cochannel interference degrades the transmission data rate severely. In further, we can write the transmission latency $\phi_{1,t}$ and energy consumption $\phi_{1,E}$ as,

$$\phi_{1,t} = \frac{dL}{R_m}, \quad (5)$$

$$\phi_{1,E} = \frac{dLP_u}{R_m}. \quad (6)$$

The computational latency $\phi_{2,t}$ and energy consumption $\phi_{2,E}$ at the CAP are given by

$$\phi_{2,t} = \frac{dL\kappa}{b_m}, \quad (7)$$

$$\phi_{2,E} = \frac{dLP_m\kappa}{b_m}, \quad (8)$$

where P_m is the computational power of the m -th CAP. From (1)–(8), we can write the system overall latency ϕ_t and energy consumption ϕ_E as,

$$\phi_t = \max(\phi_{0,t}, \phi_{1,t} + \phi_{2,t}), \quad (9)$$

$$= \max \left(\frac{(1-d)L\kappa}{b_0}, \frac{dL}{R_m} + \frac{dL\kappa}{b_m} \right), \quad (10)$$

$$\phi_E = \phi_{0,E} + \phi_{1,E} + \phi_{2,E}, \quad (11)$$

$$= \frac{(1-d)LP_0\kappa}{b_0} + \frac{dLP_u}{R_m} + \frac{dLP_m\kappa}{b_m}. \quad (12)$$

In practice, the computing services in the MEC networks have brought out diverse demands on the system performance, among which the data rate, latency and energy consumption are the three major performance metrics. Following the definition of outage event in [13], we can write the system outage probability when the m -th CAP is used as,

$$P_{out,m} = \text{Prob}[(\phi_t > \beta_T) | (\phi_E > \beta_E) | (R_m < R_{th})], \quad (13)$$

where the joint impact from the data rate, latency and energy consumption is taken into account, and β_T , β_E and R_{th} denote the thresholds of the latency, energy consumption and data rate, respectively. In addition, the operation ‘ $||$ ’ denotes the

logical OR operation. We can find that the system is in outage if the latency is larger than the tolerated latency threshold β_T , or the energy consumption is larger than the tolerated threshold β_E , or the data rate is below the given threshold R_{th} . Note that this outage probability definition is a generalized definition, and it includes the conventional data rate based outage probability through setting the thresholds of latency and energy consumption to a large value. Moreover, this outage probability definition can be readily extended, when some other performance metrics such as profit become important for the computing services in the MEC networks.

III. CAP SELECTION CRITERIA

From the description in the previous section, we can find that using different CAPs can affect the communication and computational cost. Hence, we should select one CAP among M ones to enhance the system performance. In this part, we will present three CAP selection criteria to select the CAP. Specifically, criterion I is to maximize the computational capability at the CAP, given by,

$$m^* = \arg \max_{1 \leq m \leq M} |b_m|^2, \quad (14)$$

which can maximize the CPU frequency cycle at the CAP. This criterion can be implemented in a distributed way, by setting a timer whose initial value is inversely proportional to the computational capability. When the timer of the CAP is firstly becoming zero, this CAP will be selected by broadcasting the selection result to other CAPs through some dedicated links.

Beside criterion I, criterion II is to minimize the instantaneous channel gain of the cochannel interference, given by

$$m^* = \arg \min_{1 \leq m \leq M} |g_m^I|^2, \quad (15)$$

which can help suppress the cochannel interference and accordingly enhance the transmission quality of the data link. Criterion II requires to know the full CSI of all interfering links. When the instantaneous CSI from only a part of interfering links is known, criterion II will become into $m^* = \arg \min_{m \in \mathcal{S}_I} |g_m^I|^2$, where \mathcal{S}_I denotes the sub-set of interfering links whose instantaneous channel information is known.

To implement criterion II in (15), the user can collect the interfering channel parameters from the interferers, after the interferers estimate the channel parameters by using some pilot signals. Then, the user can perform the CAP selection and broadcast the result to the nodes in the network. This selection process may take some time to complete. In a time-varying channel environment where the user is moving, this delay may cause outdated CAP selection to some extent. In other words, the CAP selection is performed based on the outdated CSI.

In addition to criterion I and II, criterion III is to maximize the instantaneous channel gain of the data link, given by

$$m^* = \arg \max_{1 \leq m \leq M} |g_m|^2, \quad (16)$$

which can help maximize the data rate of the data link. Criterion III requires to know the full CSI of all data links. When the instantaneous CSI from only a part of data links is known, criterion III will become into $m^* = \arg \max_{m \in \mathcal{S}_M} |g_m|^2$, where

S_M denotes a sub-set of the data links whose instantaneous channel information is known.

Similar to the implementation of criterion II, we can implement criterion III in (16) as follows. The CAPs can estimate the parameters of the link with the user, through some pilot signals from the user. Then, a distributed CAP selection can be performed, similar to the process in criterion I. This process may cause outdated CAP selection, in the time-varying channel environments.

Note that the above three CAP selection criteria are easy to be implemented in practice, which provide flexible choices for various application scenarios. For example, when the applications are sensitive to the computational capability, criterion I tends to be used for the edge server selection. In contrast, when the applications are sensitive to the communication quality, criterion II or III should be employed instead, whereas the instantaneous channel parameters of the interfering or data links are known, respectively. Besides these three criteria, some other criteria can be employed for the edge server selection. For instance, the edge server can be selected through maximizing the received SINR at the CAPs, based on the outdated CSI of both data and interfering links. We can also select an edge server by using an exhaustive search algorithm with the lowest outage probability, based on the information of outdated CSI and computational capacity. However, these two criteria involve a much higher implementation complexity, and hence we employ the three low-complexity criteria in (14)–(16) for the edge server selection in this paper.

IV. PERFORMANCE OPTIMIZATION AND ANALYSIS

In this section, we first optimize the offloading ratio to achieve the minimal outage probability for the considered MEC network. After that, we apply the optimal offloading ratio and analyze the outage probability for the proposed three criteria. Both analytical and asymptotic forms of outage probability are provided, from which we draw some insights on the outage performance.

A. Offloading Ratio Optimization

Given CPU-cycle frequencies b_0 and b_m , we can write the outage probability of the m -th CAP as

$$P_{out,m} = \text{Prob}[(\phi_t > \beta_T) | (\phi_E > \beta_E) | (R_m < R_{th})]. \quad (17)$$

Using the inclusion-exclusion principle and the setting of $R_{th} = \frac{L}{\phi_t}$, we can rewrite (17) into

$$P_{out,m} = 1 - \text{Prob}[\phi_t \leq \beta_T, \phi_E \leq \beta_E, R_m \geq R_{th}], \quad (18)$$

$$= 1 - \text{Prob}\left(R_m \geq \frac{L}{U_m(b_0)}\right), \quad (19)$$

where

$$U_m(b_0) = \min(u_1, u_2), \quad (20)$$

with

$$u_1 = \frac{\beta_T}{d} - \phi_{2,t}, \quad u_2 = \frac{\phi_{0,E} - \phi_{2,E}}{P_u} - \frac{\phi_{0,E} - \beta_E}{P_u d}. \quad (21)$$

Also, since $\phi_t > \beta_T$ indicates $d > d_1$ with $d_1 = 1 - \beta_T/\phi_{0,t}$, d subjects to the constraint of $d \in [d_1, 1]$.

From the outage provability expression of the m -th CAP in (19), we see that the system outage performance can be optimized with the maximal value of $U_m(b_0)$. In this part, we will present the maximal value of $U_m(b_0)$ in the following.

We first determine the maximal value of $U_m(b_0)$ for d without any constraint. It is trivial to see that the value of u_1 is inversely proportional to d , yet the value of u_2 is proportional to d . Therefore, we can achieve the maximal value of $U_m(b_0)$ in (20) via solving the equation $u_1 = u_2$ with respect to d , and the solution is

$$d = d_2 = \frac{\phi_{1,E} - \phi_E + P_u \beta_T}{\phi_{1,E} - \phi_{2,E} + P_u \phi_{2,t}}. \quad (22)$$

However, since the condition $\phi_t > \beta_T$ indicates $d \in [d_1, 1]$, the maximal $U_m(b_0)$ depends on the relationship between d_1 and d_2 . Comparing the values of d_1 , d_2 and 1, we detail the following three cases to obtain the optimal value of offloading ratio d .

Case 1: When $d_1 \leq d_2 \leq 1$, we can obtain the maximal $U_m(b_0)$ by setting $d = d_2$, since $u_1 = u_2$ holds with $d = d_2$.

Case 2: When $d_2 < d_1$, which suggests that u_1 is smaller than u_2 with $d \in [d_1, 1]$, we have $U_m(b_0) = u_1$. As u_1 decreases with the increasing value of d , we can obtain the maximal value of $U_m(b_0)$ by setting $d = d_1$ with $d_2 < d_1$.

Case 3: When $d_2 > 1$, which suggests that u_1 is greater than u_2 with $d \in [d_1, 1]$, we have $U_m(b_0) = u_2$. Since u_2 increases with the increasing value of d , by setting $d = 1$, we can obtain the maximal value of $U_m(b_0)$ with $d_2 > 1$.

By applying the optimal d given in the above three cases, we optimize the outage probability of the m -th CAP. In further, substituting the optimal value of d and after some mathematical manipulations, we can write the maximal value of $U_m(b_0)$ as

$$U_m^*(b_0) = \begin{cases} \chi_{1,m}, & \text{If } P_u > Q_{1,m} \\ \chi_{2,m}, & \text{If } P_m \leq P_u \leq Q_{1,m} \\ \chi_{3,m}, & \text{If } P_u < \min(P_m, Q_{1,m}), b_0 \geq Q_{2,m} \\ \chi_{2,m}, & \text{If } P_u < \min(P_m, Q_{1,m}), b_0 < Q_{2,m} \end{cases}, \quad (23)$$

where

$$\chi_{1,m} = \frac{\beta_E b_m - P_m L \kappa}{P_u b_m}, \quad (24)$$

$$\chi_{2,m} = \frac{\beta_T P_0 L \kappa b_m - \beta_T L \kappa (P_m - P_u) b_0}{P_0 L \kappa b_m - (\beta_E - P_u \beta_T) b_m b_0} - \frac{L \kappa}{b_m}, \quad (25)$$

$$\chi_{3,m} = \frac{\beta_T L \kappa}{L \kappa - \beta_T b_0} - \frac{L \kappa}{b_m}, \quad (26)$$

$$Q_{1,m} = \frac{\beta_E b_m - P_m L \kappa}{\beta_T b_m - L \kappa}, \quad (27)$$

$$Q_{2,m} = \frac{g_n (P_m L \kappa + \beta_T P_0 b_m + P_u \beta_T b_m - L \kappa P_u - \beta_E b_m)}{\beta_T (P_0 - P_u)}. \quad (28)$$

By applying (23) into (19), we can achieve the minimal outage probability of the m -th CAP.

B. Outage Analysis for Criterion I

When criterion I is employed, the CAP with the maximal computational capacity is selected, thus the data-transmission link is fixed as well. By substituting the maximal value of $U_m^*(b_0)$ of (23) into (19), the outage probability for criterion I can be written as²

$$P_{out}^I = P_{out,m^*} = \int_0^\infty F_{R_{m^*}}^I \left(\frac{L}{U_{m^*}^*(s)} \right) p_{b_0}(s) ds, \quad (29)$$

where $F_{R_{m^*}}^I(x)$ is the cumulative density function (CDF) of data rate R_{m^*} from S to the m^* -th CAP link, and $p_{b_0}(s)$ is the probability density function (PDF) of the CPU-cycle frequency at the user, which is given by³

$$p_{b_0}(s) = \begin{cases} \frac{1}{b_{max} - b_{min}}, & \text{If } s \in [b_{min}, b_{max}] \\ 0, & \text{Else} \end{cases}. \quad (30)$$

The CDF of the data rate R_{m^*} with criterion I can be written as

$$F_{R_{m^*}}^I(x) = \text{Prob} \left(B \log_2 \left(1 + \frac{P_u |g_m|^2}{\sigma^2 + P_I |g_m^I|^2} \right) < x \right), \quad (31)$$

$$= \int_0^\infty \int_0^{\frac{(2^{x/B} - 1) P_I z + \sigma^2}{P_u}} p_{|g_m|^2}(y) p_{|g_m^I|^2}(z) dy dz, \quad (32)$$

where $p_{|g_m|^2}(y)$ and $p_{|g_m^I|^2}(z)$ are the PDFs of the channel gain of data link $|g_m|^2$ and interfering link $|g_m^I|^2$, respectively. As Rayleigh fading environments are considered, the PDFs of $|g_m|^2$ and $|g_m^I|^2$ are

$$p_{|g_m|^2}(y) = \frac{1}{\varepsilon} e^{-\frac{y}{\varepsilon}}, \quad (33)$$

$$p_{|g_m^I|^2}(z) = \frac{1}{\varepsilon_I} e^{-\frac{z}{\varepsilon_I}}. \quad (34)$$

From (34) and the order theory [31], we can further obtain the PDF of $|g_m^I|^2 = \sum_{k=1}^K |g_{m,k}^I|^2$ as

$$p_{|g_m^I|^2}(z) = \frac{z^{M-1}}{\varepsilon_I^M \Gamma(M)} e^{-\frac{z}{\varepsilon_I}}. \quad (35)$$

By concluding the results in (33) and (35), we can write the CDF of data rate R_{m^*} regarding criterion I as

$$F_{R_{m^*}}^I(x) = 1 - \left(1 + \frac{P_I \varepsilon_I (2^{\frac{x}{B}} - 1)}{\varepsilon P_u} \right)^{-K} e^{-\frac{x}{\varepsilon P_u}}. \quad (36)$$

²In this work, we assume the fixed computational capability at the edge servers. If the computational capability at the edge servers varies randomly, we can accordingly write the outage probability of criterion I as

$$P_{out}^I = \int_0^\infty \int_0^\infty F_{R_{m^*}}^I \left(\frac{L}{U_{m^*}^*(s)} \right) |_{b_{m^*}=y} p_{b_0}(s) p_{b_{m^*}}(y) ds dy,$$

where $p_{b_{m^*}}(y)$ is the PDF of CPU-cycle frequency b_{m^*} at the m^* -th CAP, and we can similarly solve this integral to obtain the analytical expression of outage probability.

³If some other kinds of distribution, such as normal distribution or exponential distribution, are used to model the local computational capability, we can readily apply the updated PDF of b_0 into (29) to obtain the analytical outage probability of criterion I, in a similar way.

By substituting (23), (30) and (36) into (29), the exact one-dimensional integral expression of outage probability of criterion I can be obtained. However, the exact one-dimensional integral expression of P_{out}^I is difficult to compute, and hence we propose a closed-form expression of P_{out}^I based on the Gaussian-Chebyshev approximation [31] as

$$P_{out}^I \approx 1 - \sum_{j=1}^J \frac{(1 - \theta_j)^{\frac{1}{2}} e^{-\frac{2 \frac{L}{U_{m^*}^*(v_j)^B} - 1}{\varepsilon P_u}}}{(b_{max} - b_{min}) \left(1 + \frac{P_I \varepsilon_I (2^{\frac{L}{U_{m^*}^*(v_j)^B} - 1})}{\varepsilon P_u} \right)^K} \quad (37)$$

where J is a complexity-vs-accuracy tradeoff parameter, and the convergence of the approximation in (37) can be guaranteed by setting J to a large value [31], and

$$\theta_j = \cos \left(\frac{(2j-1)\pi}{2J} \right), \quad v_j = \frac{b_{max}(1 + \theta_j) + b_{min}(1 - \theta_j)}{2}. \quad (38)$$

To further illustrate the effect of network parameters on the system performance, we provide the asymptotic expression of P_{out}^I in the high SINR region. Applying the approximations $e^{-1/x} \simeq 1 - 1/x$ and $(1 + 1/x)^{-1} \simeq 1 - 1/x$ into (37), and omitting the smaller terms with a large value of $|x|$, the asymptotic expression of P_{out}^I can be computed as

$$P_{out}^I \simeq \frac{(V_{1,m^*} - 1)(K \varepsilon_I + \frac{\sigma^2}{P_I})}{\xi \varepsilon}, \quad (39)$$

where $\xi = \frac{P_u}{P_I}$ is the transmit signal-to-interference ratio (SIR) and $V_{p,m}$ is defined in (40), in which

$$\omega_1 = \frac{\ln 2pP_0b_m}{B(\beta_E - \beta_T P_m)} \left(L + \frac{(\beta_T b_m - L\kappa)(\beta_E - \kappa_T P_u)}{\kappa(\beta_E - \beta_T P_m)} \right), \quad (41)$$

$$\omega_2 = \frac{P_0(\beta_T b_m - L\kappa)}{(\beta_E - \beta_T P_m)}, \quad \omega_3 = \frac{b_m(\beta_E - \kappa_T P_u)}{\kappa B(\beta_E - \beta_T P_m)}, \quad (42)$$

$$\omega_4 = \frac{\ln 2pLb_m}{\beta_T B} (L + \beta_T b_m \kappa - L\kappa^2), \quad (43)$$

$$\omega_5 = \frac{\beta_T b_m - L\kappa}{\beta_T}, \quad \omega_6 = \frac{b_m}{B}, \quad (44)$$

$$\Upsilon(\alpha_1, \alpha_2) = \mathbf{Ei}(\alpha_1) - \mathbf{Ei}(\alpha_2) - \frac{e^{\alpha_1}}{\alpha_1} + \frac{e^{\alpha_2}}{\alpha_2}, \quad (45)$$

and $\mathbf{Ei}(x) = \int_\infty^x \frac{e^t}{t} dt$ is the exponential integral.

To better illustrate the impact of criterion I, we have the following insights on the system.

Remark 1: As the number of cochannel interferers K rises, the outage performance of criterion I becomes worse. This is due to the fact that the augmenting cochannel interferers brings extra aggregate cochannel interference power, which degrades the transmission quality.

Remark 2: As the task length L increases, the system has to cope with extra burden of communication and computation, which results in a worse outage probability.

Remark 3: The diversity order of criterion I remains unity regardless of the correlation coefficient η . This is because that the system only utilizes the information of CPU-cycle frequency at the CAPs, and therefore channel diversity from multiple CAPs cannot be exploited.

$$V_{p,m} \simeq \begin{cases} 2^{\frac{L}{x_{1,m}B}}, & \text{If } P_u > \beta_P \\ \frac{\omega_1(\omega_2 + g_{min})}{(g_{max} - g_{min})2^{\omega_3}} \Upsilon\left(\frac{\omega_1}{\omega_2 + g_{min}}, \frac{\omega_1}{\omega_2 + g_{max}}\right), & \text{If } P_m \leq P_u \leq \beta_P \\ \frac{\omega_1(\omega_2 + g_{min})}{(g_{max} - g_{min})2^{\omega_3}} \Upsilon\left(\frac{\omega_1}{\omega_2 + g_{min}}, \frac{\omega_1}{\omega_2 + \beta_b}\right) + \frac{\omega_4(\omega_5 + g_{min})}{(g_{max} - g_{min})2^{\omega_5}} \Upsilon\left(\frac{\omega_4}{\omega_5 + \beta_b}, \frac{\omega_4}{\omega_5 + g_{max}}\right), & \text{If } P_u < \min(P_m, \beta_P) \end{cases} \quad (40)$$

C. Outage Analysis for Criterion II

When criterion II is employed, the CAP with the minimal interfering gain is selected. The probability that the m -th CAP is selected equals to $\frac{1}{M}$. In addition, applying the optimal $U_{m^*}^*(b_0)$ of (23) into (19), the outage probability of criterion II can be written as

$$P_{out}^{II} = \frac{1}{M} \sum_{m^*=1}^M \int_0^\infty F_{R_{m^*}}^{II} \left(\frac{L}{U_{m^*}^*(s)} \right) p_{b_0}(s) ds. \quad (46)$$

To proceed, we write the CDF of the data rate R_{m^*} of criterion II as

$$\begin{aligned} F_{R_{m^*}}^{II}(x) &= \text{Prob} \left(B \log_2 \left(1 + \frac{P_u |g_m|^2}{\sigma^2 + P_I |g_{m^*}^I|^2} \right) < x \right), \quad (47) \\ &= \int_0^\infty \int_0^{\frac{(2^{x/B} - 1)(P_I z + \sigma^2)}{P_u}} p_{|g_m|^2}(y) p_{|g_{m^*}^I|^2}(z) dy dz, \quad (48) \end{aligned}$$

where $p_{|g_m|^2}(y)$ and $p_{|g_{m^*}^I|^2}(z)$ are the PDFs of actual channel gain of data link $|g_m|^2$ and interfering channel gain $|g_{m^*}^I|^2$, respectively. As Rayleigh fading channels are considered, the PDF of the outdated interfering channel gain for the selected m^* -th CAP, i.e., $|\hat{g}_{m^*}^I|^2 = \min_{1 \leq m \leq M} |\hat{g}_m^I|^2$, is

$$p_{|\hat{g}_{m^*}^I|^2}(\hat{z}) = M \Gamma(K, \frac{\hat{z}}{\varepsilon_I})^{M-1} \frac{\hat{z}^{K-1} e^{-\frac{\hat{z}}{\varepsilon_I}}}{\varepsilon_I^K \Gamma(K)}. \quad (49)$$

Also, the conditional PDF of actual interfering channel gain $|g_{m^*}^I|^2$ with respect to outdated interfering channel gain $|\hat{g}_{m^*}^I|^2$ is given by [32]

$$p_{|g_{m^*}^I|^2 | \hat{g}_{m^*}^I|^2}(z | \hat{z}) = \sum_{n=0}^{N_T} \frac{\eta^n z^{K+n-1} \hat{z}^{K-1} e^{-\frac{z+\eta\hat{z}}{(1-\eta)\varepsilon_I}}}{n!(1-\eta)^{K+2n} \Gamma(K+n) \varepsilon_I^{K+2n}}, \quad (50)$$

where N_T is a large number and η is the correlation coefficient between $|g_{m^*}^I|^2$ and $|\hat{g}_{m^*}^I|^2$. Thus, the PDF of actual interfering channel gain at the selected m^* -th CAP is

$$\begin{aligned} p_{|g_{m^*}^I|^2}(z) &= \int_0^\infty p_{|g_{m^*}^I|^2 | \hat{g}_{m^*}^I|^2}(z, \hat{z}) p_{|\hat{g}_{m^*}^I|^2}(\hat{z}) d\hat{z}, \quad (51) \\ &= \sum_{n=0}^{N_T} \frac{M \eta^n z^{K+n-1} e^{-\frac{z}{(1-\eta)\varepsilon_I}} \Theta_n}{n!(1-\eta)^{K+2n} \Gamma(K+n) \Gamma(K) \varepsilon_I^{2K+2n}}, \quad (52) \end{aligned}$$

where Θ_n is

$$\Theta_n = \sum_{r_1+r_2+\dots+r_K=M-1} \prod_{i=1}^K \frac{\varepsilon_I^{K+n} \Gamma(K+n+r_i(i-1)-1)}{(N + \frac{\eta}{1-\eta})^{K+n+r_i(i-1)} r_i! \Gamma(i)^{r_i}}. \quad (53)$$

Utilizing the results in (23), (33) and (52), we can rewrite the CDF of the data rate R_{m^*} of criterion II in (48) as

$$F_{R_{m^*}}^{II}(x) = 1 - \sum_{n=0}^{N_T} \frac{M \eta^n \Theta_n (P_I \varepsilon_I)^{-2K-2n} e^{-\frac{\sigma^2(2^{\frac{x}{B}}-1)}{P_u \varepsilon}}}{n!(1-\eta)^{K+2n} \Gamma(K) \left(\frac{1}{P_I \varepsilon_I (1-\eta)} + \frac{2^{\frac{x}{B}}-1}{P_S \varepsilon} \right)^{K+n}}. \quad (54)$$

By summarizing (23), (30) and (54), we can achieve the analytical expression of outage probability of criterion II, as shown in (55), where the Gaussian-Chebyshev approximation is utilized.

Moreover, applying the approximations $e^{-1/x} \simeq 1 - 1/x$ and $(1 + 1/x)^{-1} \simeq 1 - 1/x$, and neglecting the tinier terms with a large value of $|x|$, we can further achieve the asymptotic expression of P_{out}^{II} as

$$P_{out}^{II} \simeq \frac{(\delta_1 \varepsilon_I + \frac{\sigma^2}{P_I}) \delta_2}{\xi \varepsilon}, \quad (56)$$

where

$$\delta_1 = \sum_{n=0}^{N_T} \frac{M \Theta_n \eta^n K^{n-1} (K+n)}{n!(1-\eta)^{n-1} (P_I \varepsilon_I)^{n-1}}, \quad \delta_2 = \sum_{m^*=1}^M \frac{V_{1,m^*}}{M} - 1. \quad (57)$$

Form the results of P_{out}^{II} in (55) and (56), some insights upon the system are given as follows.

Remark 4: The system with criterion II suffers performance degradation with a large number of cochannel interferers K , as the existence of more cochannel interferers weakens the transmission quality.

Remark 5: The outage performance of criterion II degrades with a large task length L , as additional burden of transmission and computation on the system increases the probability of the outage event.

Remark 6: The outage performance of criterion II improves with an increased value of correlation coefficient η , due to the fact that a more accurate cochannel CSI helps the system avoid poorer transmission condition. However, the diversity order of criterion II is unity and remains unchanged with different η of the interfering links.

D. Outage Analysis for Criterion III

When criterion III is employed, the CAP with the largest channel gain of data link is selected. Similar to criterion II, using (23) with the optimal $U_m^*(b_0)$, the outage probability of criterion III can be written as

$$P_{out}^{III} = \frac{1}{M} \sum_{m^*=1}^M \int_0^\infty F_{R_{m^*}}^{III} \left(\frac{L}{U_{m^*}^*(s)} \right) p_{b_0}(s) ds. \quad (58)$$

$$P_{out}^{II} \approx 1 - \sum_{m^*=1}^M \sum_{j=1}^J \sum_{n=0}^{N_T} \frac{\sqrt{1 - \theta_j^2} \eta^n (P_I \varepsilon_I)^{-2K-2n} \Theta_n}{(b_{max} - b_{min}) n! (1 - \eta)^{K+2n} \Gamma(K) \left(\frac{1}{P_I \varepsilon_I (1 - \eta)} + \frac{(2^{\frac{L}{P_u \varepsilon}} \bar{U}_{m^*}^{*(v_j)^B} - 1)}{P_u \varepsilon} \right)^{K+n}} e^{-\frac{\sigma^2 (2^{\frac{L}{P_u \varepsilon}} \bar{U}_{m^*}^{*(v_j)^B} - 1)}{P_u \varepsilon}}. \quad (55)$$

To further analyze the outage performance, we first write the CDF of the data rate R_{m^*} from S to the m^* -th CAP regarding criterion III as

$$F_{R_{m^*}}^{III}(x) = \text{Prob} \left(B \log_2 \left(1 + \frac{P_u |g_{m^*}|^2}{\sigma^2 + P_I |g_m^I|^2} \right) < x \right), \quad (59)$$

$$= \int_0^\infty \int_0^{\frac{(2^{x/B} - 1)(P_I z + \sigma^2)}{P_u}} p_{|g_{m^*}|^2}(y) p_{|g_m^I|^2}(z) dy dz. \quad (60)$$

The channel gain of the outdated data link for the selected m^* -th CAP is $\hat{g}_{m^*} = \max_{1 \leq m \leq M} \hat{g}_m$, whose PDF can be obtained by using the order theory, as

$$p_{|\hat{g}_{m^*}|^2}(\hat{y}) = \sum_{m=1}^M \frac{(-1)^{m-1} \binom{M}{m} m}{\varepsilon} e^{-\frac{m\hat{y}}{\varepsilon}}. \quad (61)$$

Also, the conditional PDF of actual channel gain $|g_{m^*}|^2$ with respect to the outdated channel gain $|\hat{g}_{m^*}|^2$ is given by [33]

$$p_{|g_{m^*}|^2 | \hat{g}_{m^*}|^2}(y | \hat{y}) = \frac{e^{-\frac{\eta \hat{y} + y}{\varepsilon}}}{(1 - \eta) \varepsilon} I_0 \left(\frac{2\sqrt{\eta \hat{y} y}}{(1 - \eta) \varepsilon} \right), \quad (62)$$

where $I_0(x)$ is the zero-order modified Bessel function of the first kind [31]. By using (61) and (62), we can achieve the PDF of the actual channel gain $|g_{m^*}|^2$ for the m^* -th CAP as

$$p_{|g_{m^*}|^2}(y) = \int_0^\infty p_{|g_{m^*}|^2 | \hat{g}_{m^*}|^2}(y | \hat{y}) p_{|\hat{g}_{m^*}|^2}(\hat{y}) d\hat{y}, \quad (63)$$

$$= \sum_{m=1}^M \frac{(-1)^{m-1} \binom{M}{m}}{\varepsilon_m} e^{-\frac{y}{\varepsilon_m}}, \quad (64)$$

where

$$\varepsilon_m = \varepsilon \frac{m(1 - \eta) + \eta}{m}. \quad (65)$$

By combining (35) and (64) into (60), we achieve the PDF of the actual channel gain of the data link for the m^* -th CAP as

$$F_{R_{m^*}}^{III}(x) = 1 - \sum_{m=1}^M \frac{(-1)^{m-1} \binom{M}{m}}{\left(1 + \frac{P_I \varepsilon_I (2^{\frac{x}{B}} - 1)}{P_u \varepsilon_m}\right)^K} e^{-\frac{(2^{\frac{x}{B}} - 1) \sigma^2}{\varepsilon_m P_u}}. \quad (66)$$

Applying (23), (30) and (66) into (58), the analytical expression of outage probability for criterion III is obtained, as shown in (67), where the Gaussian-Chebyshev approximation is employed.

Using Taylor's expansions $e^{-1/x} = \sum_{n=0}^{\infty} \frac{(-1/x)^n}{n!}$ and $(1 + 1/x)^{-1} = \sum_{n=0}^{\infty} (-1/x)^n$, and omitting smaller terms with a large value of $|x|$, we can further achieve the asymptotic expression of P_{out}^{III} as

$$P_{out}^{III} \simeq \begin{cases} \delta_3 \delta_5 \left(\frac{\varepsilon_I}{\xi \varepsilon} \right)^M & \text{If } \eta = 1 \\ \frac{(K \varepsilon_I + \frac{\sigma^2}{P_I}) \delta_2 \delta_4}{\xi \varepsilon}, & \text{If } 0 \leq \eta < 1 \end{cases}, \quad (68)$$

where

$$\delta_3 = \sum_{m=0}^M \binom{M}{m} (-1)^{m+M} \sum_{q+l=M} \frac{\left(\frac{\sigma^2}{P_I \varepsilon_I} \right)^l \binom{K+l-1}{l}}{q!}, \quad (69)$$

$$\delta_4 = \sum_{m=0}^M \binom{M}{m} \frac{(-1)^{m-1}}{\varepsilon_m}, \quad (70)$$

$$\delta_5 = (-1)^M + \sum_{n=1}^M \sum_{m^*=1}^M \binom{M}{n} \frac{(-1)^{M-n} V_{n,m^*}}{M}. \quad (71)$$

Based upon P_{out}^{III} in (67) and (68), we can draw the following remarks.

Remark 7: The outage probability of criterion III becomes worse with an increased number of cochannel interferers K , as the channel condition deteriorates with the existence of more cochannel interferers.

Remark 8: The outage probability of criterion III deteriorates with an increased value of L , since a larger task imposes additional burden of communication and computation on the system, which results in a higher outage probability.

Remark 9: The outage performance of criterion III degrades with the decreased value of correlation coefficient η , due to the inefficient use of the channel CSI.

Remark 10: The diversity order of criterion III can reach M , under the condition that system is fully aware of the data channel CSI with $\eta = 1$. When η is smaller than 1, the diversity order of the system degenerates into unity.

E. Some Discussions on the System Design and Analysis

In this part, we discuss the extension of the current work to the scenario where multiple edge servers are selected for the task offloading. For the considered MEC network, we can select more than one edge server for the task offloading, which can bring more benefits in improving the system performance. In this case, the system implementation will be much more complicated, as it involves more channel parameters and computational capability information. However, the optimization and analysis in this paper are still useful, as they can serve as an important reference and can be extended to the scenario with multiple edge servers selected.

V. NUMERICAL AND SIMULATION RESULTS

This section provides both numerical and simulation results to illustrate the impact of network parameters on the system performance. Without loss of generality, we normalize the average channel gains of the data and interfering links to unity, i.e., $\varepsilon = \varepsilon_I = 1$, and set $P_u = 3W$, $P_0 = 1W$, $P_m = 0.2W$ and $B = 100\text{MHz}$. If not specified, we set the number of CAPs to three, whereas the associated CPU-cycle frequencies are $\{8, 9, 10\}$ GHz. In addition, the local CPU-cycle frequency

$$P_{out}^{III} \approx 1 - \sum_{m^*=1}^M \sum_{n=1}^M \sum_{j=1}^J \frac{\sqrt{1 - \theta_j^2} (-1)^{n+1} \binom{M}{n}}{M(b_{max} - b_{min}) \left(1 + \frac{P_{I \in I} (2^{\frac{L}{U_{m^*}^* (v_j)^B} - 1)}}{\varepsilon_n P_u}\right)^K} e^{-\frac{(2^{\frac{L}{U_{m^*}^* (v_j)^B} - 1})}{\varepsilon_n P_u / \sigma^2}}. \quad (67)$$

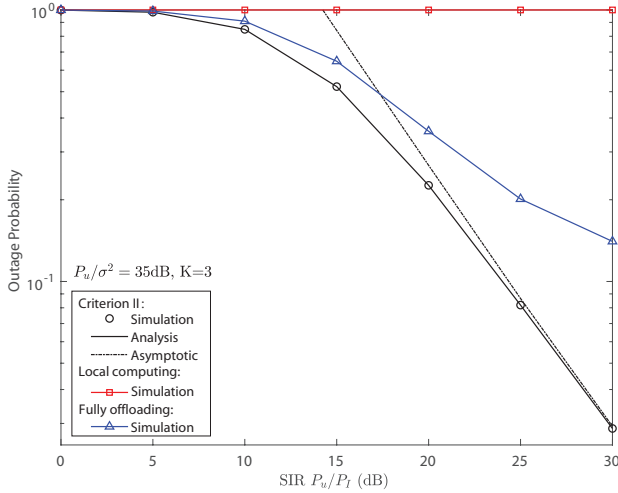

Fig. 2. Outage probability versus SIR: Criterion I.

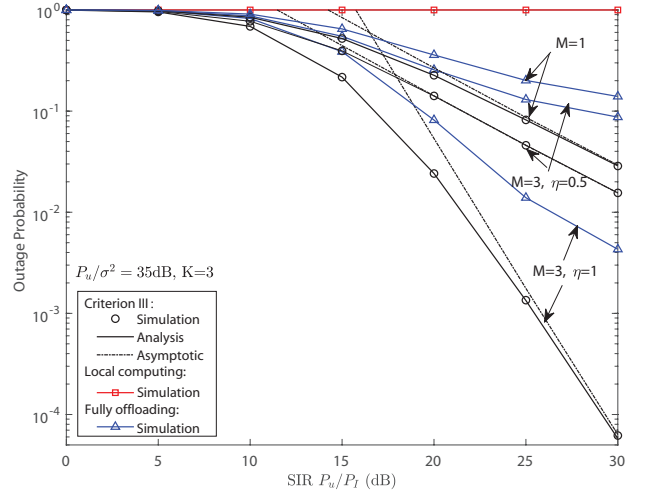

Fig. 4. Outage probability versus SIR: Criterion III.

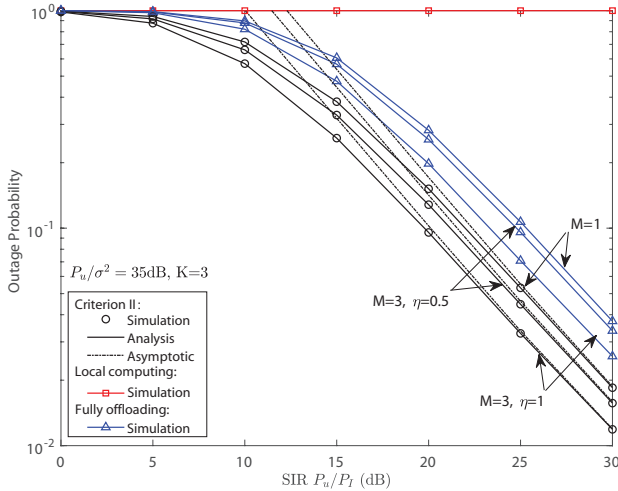

Fig. 3. Outage probability versus SIR: Criterion II.

varies in the interval of $[0.1, 1]$ GHz, and the required CPU cycles to compute each bit κ are 10. Moreover, the latency and energy consumption thresholds of outage, i.e., β_T and β_E , are 0.3s and 0.8J, respectively⁴.

Figs. 2-4 demonstrate the analytical and simulated outage probabilities of the three criteria versus the transmit SIR P_u/P_I , where signal-to-noise ratio (SNR) P_u/σ^2 is set to 35dB, task length L is 80 Mbits, and the number of interferers K is 3. The outdated channel coefficient η is set to 0.5 or 1, corresponding to the outdated CAP selection and perfect selection, respectively. For comparison, we also plot the results

⁴The network parameters given in this paper are similar to those in the existing works such as [6], [13], [29], where the local computational capability varies randomly subject to the uniform distribution, and the CAPs provide a much more powerful computational capability than the user.

of the local computing with $d = 0$ and full offloading with $d = 1$. Specifically, Fig. 2, Fig. 3 and Fig. 4 are associated with criterion I, II and III, respectively. As observed from Figs. 2-4, we can find that for each criterion, the analytical result fits well with the simulated one for various values of SIR, and the asymptotic result becomes convergent to the exact one in the high SIR region, which validates the effectiveness of the derived analytical and asymptotic expressions of outage probability for all criteria. Moreover, the system outage performances of all criteria improve with a larger value of SIR, as the increased data rate can help reduce the transmission latency and energy consumption very effectively. In further, the proposed criteria outperform both the local computing and fully offloading schemes, as the proposed schemes can exploit the computational resources of both the local user and CAPs. Furthermore, we can see that for criterion II and III, the results with $\eta = 0.5$ are much poorer than those with $\eta = 1$, indicating that the outdated CAP selection has a negative impact on the system performance. In particular, the system diversity orders of criterion I and II are both unity, while that of criterion III with perfect CAP selection is equal to M . However, under outdated CAP selection, the system diversity order of criterion III degenerates into unity, as there exists a wrong CAP selection, which captures the system whole performance. In addition, the outage event of local computing always occurs in Figs. 2-4, due to the fact that the user cannot accomplish the computational tasks solely with a limited computational capability in practice. Accordingly, we set $\beta_T \leq \phi_{0,t}$ and $\beta_E \leq \phi_{0,E}$ to indicate that the local computing cannot meet the system requirement on the latency and energy consumption.

Fig. 5 depicts the outage probabilities of the three criteria

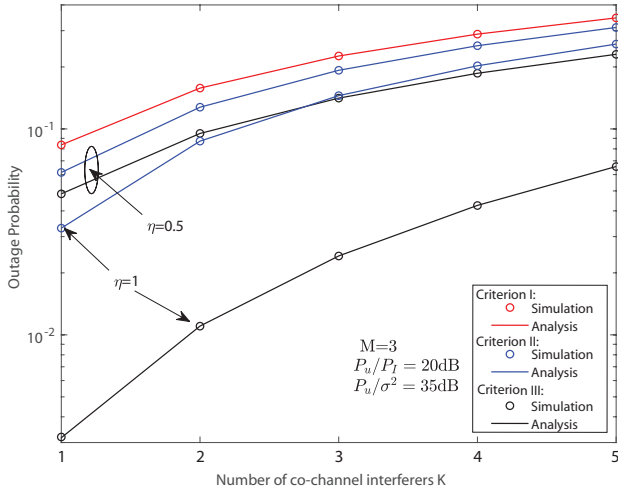

Fig. 5. Outage probability versus the number of cochannel interferers K .

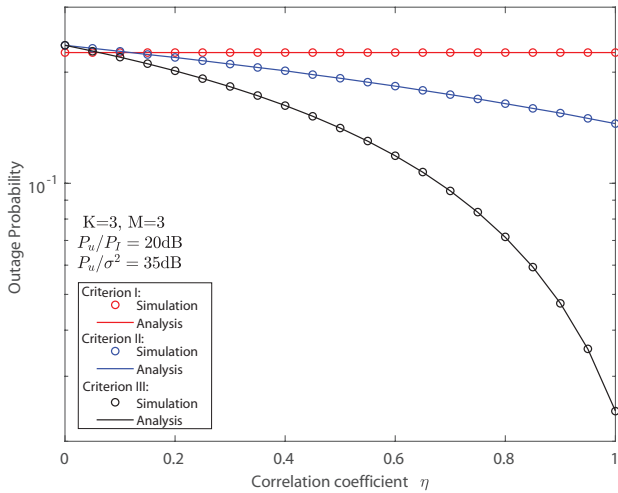

Fig. 6. Outage probability versus the correlation coefficient η .

versus the number of cochannel interferers, where SIR P_u/P_l is 20dB, SNR is 35dB, $L = 80$ Mbits, the outdated coefficient $\eta \in \{0.5, 1\}$, $M = 3$ and K varies from 1 to 5. We can see from Fig. 5 that for each criterion, the analytical outage probability matches well with the simulated one for different values of K , which further validates the effectiveness of the derived analytical expressions of outage probability. Moreover, the system performance becomes worse with an increasing K , as more interferers weaken the transmission quality of data links, which increases the transmission latency and energy consumption significantly. In further, we can also find that for criterion II and III, the results with $\eta = 0.5$ are much worse than those with $\eta = 1$, which further indicates that the outdated CAP selection weakens the transmission quality of data links.

Fig. 6 shows the effect of correlation coefficient η on the three criteria, where SIR is 20dB, SNR is 35dB, $L = 80$ Mbits, $M = 3$, $K = 3$, $L = 80$ Mbits and η varies from 0 to 1. In particular, $\eta = 0$ corresponds to the completely outdated CAP selection, while $\eta = 1$ corresponds to the perfect CAP selection. As observed from Fig. 6, we can

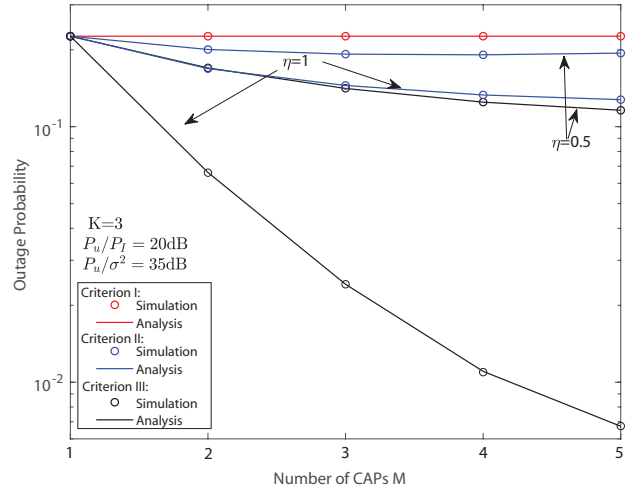

Fig. 7. Outage probability versus the number of CAPs M .

find that for each criterion, the analytical result is almost the same with the simulated one for different values of η , which validates the effectiveness of the derived analytical outage probability expressions of the three criteria further. Moreover, the outage probabilities of criterion II and III drop swiftly with the increase of η , since a higher accuracy of utilized CSI can help criterion II and criterion III select a better CAP to fulfill the task offloading based on the channel condition. In contrast, the CAP selection in criterion I is based on the CPU-frequencies of CAPs, which is irrelative to the channel condition, causing that the outage probability of criterion I remains unchanged with different values of η .

Fig. 7 demonstrates the outage probabilities of the three criteria versus the number of CAPs, where SIR is 20dB, SNR is 35dB, $K = 3$, $L = 80$ Mbits and M varies from 1 to 5. Without loss of generality, we set the CPU-cycle frequencies of M CAPs to $(11 - m)$ GHz, for $m \in [1, M]$. For example, for $M = 1$, the single CAP has the CPU-cycle frequency of 10GHz, while for $M = 2$, the two CAPs have the CPU-cycle frequencies of 10GHz and 9GHz. We can observe from Fig. 7 that for various values of M , the simulation results are almost equal to the analytical ones for each criterion, which validates the effectiveness of the derived analytical expressions of outage probability furthermore. Moreover, the outage probability of criterion I remains unchanged with the number of CAPs, yet criterion II and criterion III can significantly improve the system performance with a larger M . In particular, the performance gap between criterion III and the other two criteria enlarges with a larger M , indicating that criterion III can effectively exploit the diversity gain from M branches of data links.

VI. CONCLUSIONS

In this paper, we investigated a MEC network in the cochannel interference and time-varying environments, where the user had some computational tasks to be assisted by multiple CAPs through offloading. To enhance the system performance, we provided three CAP selection criteria to choose one best CAP among multiple ones, to maximize the computational

capability at the CAP, to minimize the interfering power, and to maximize the channel gain of data link, respectively. For the three criteria, we evaluated the system outage probability in the outdated CSI by taking into account the latency, energy consumption and data rate, and provided the analytical and asymptotic expressions of outage probability, from which we could obtain some critical insights on the system design. Simulation results were finally demonstrated to verify the proposed studies. In particular, criterion III under the perfect CSI can achieve the system whole diversity order from multiple CAPs. In future works, we will investigate how to select multiple edge servers for the considered MEC network, and study the system analysis and optimization.

REFERENCES

- [1] X. Hu, C. Zhong, Y. Zhu, X. Chen, and Z. Zhang, "Programmable metasurface-based multicast systems: Design and analysis," *IEEE J. Sel. Areas Commun.*, vol. 38, no. 8, pp. 1763–1776, 2020.
- [2] M. Amadeo, G. Ruggeri, C. Campolo, and A. Molinaro, "IoT services allocation at the edge via named data networking: From optimal bounds to practical design," *IEEE Trans. Netw. Serv. Manag.*, vol. 16, no. 2, pp. 661–674, 2019.
- [3] B. Wang, F. Gao, S. Jin, H. Lin, and G. Y. Li, "Spatial- and frequency-wideband effects in millimeter-wave massive MIMO systems," *IEEE Trans. Signal Processing*, vol. 66, no. 13, pp. 3393–3406, 2018.
- [4] X. Hu, C. Zhong, Y. Zhang, X. Chen, and Z. Zhang, "Location information aided multiple intelligent reflecting surface systems," *IEEE Trans. Commun.*, vol. 68, no. 12, pp. 7948–7962, 2020.
- [5] G. Piro, M. Amadeo, G. Boggia, C. Campolo, L. A. Grieco, A. Molinaro, and G. Ruggeri, "Gazing into the crystal ball: When the future internet meets the mobile clouds," *IEEE Trans. Cloud Comput.*, vol. 7, no. 1, pp. 210–223, 2019.
- [6] J. Zhao, Q. Li, Y. Gong, and K. Zhang, "Computation offloading and resource allocation for cloud assisted mobile edge computing in vehicular networks," *IEEE Trans. Veh. Tech.*, vol. 68, no. 8, pp. 7944–7956, 2019.
- [7] S. Bi, L. Huang, and Y. A. Zhang, "Joint optimization of service caching placement and computation offloading in mobile edge computing systems," *IEEE Trans. Wirel. Commun.*, vol. 19, no. 7, pp. 4947–4963, 2020.
- [8] X. Lai, L. Fan, X. Lei, Y. Deng, G. K. Karagiannidis, and A. Nallanathan, "Secure mobile edge computing networks in the presence of multiple eavesdroppers," *IEEE Trans. Commun.*, vol. 70, no. 1, pp. 500–513, 2022.
- [9] F. Wang, H. Xing, and J. Xu, "Real-time resource allocation for wireless powered multiuser mobile edge computing with energy and task causality," *IEEE Trans. Commun.*, vol. 68, no. 11, pp. 7140–7155, 2020.
- [10] Y. Zhang, X. Lan, Y. Li, L. Cai, and J. Pan, "Efficient computation resource management in mobile edge-cloud computing," *IEEE Internet of Things Journal*, vol. 6, no. 2, pp. 3455–3466, 2019.
- [11] S. Tang and L. Chen, "Computational intelligence and deep learning for next-generation edge-enabled industrial IoT," *IEEE Trans. Netw. Sci. Eng.*, vol. 9, no. 3, pp. 105–117, 2022.
- [12] L. Chen, "Physical-layer security on mobile edge computing for emerging cyber physical systems," *Computer Commun.*, vol. 2022, no. 1, pp. 115–127, 2022.
- [13] J. Xia, L. Fan, N. Yang, Y. Deng, T. Q. Duong, G. K. Karagiannidis, and A. Nallanathan, "Opportunistic access point selection for mobile edge computing networks," *IEEE Trans. Wirel. Commun.*, vol. 20, no. 1, pp. 695–709, 2021.
- [14] J. Yan, S. Bi, L. Duan, and Y.-J. A. Zhang, "Pricing-driven service caching and task offloading in mobile edge computing," *IEEE Trans. Wirel. Commun.*, vol. 20, no. 7, pp. 4495–4512, 2021.
- [15] J. Chen, Z. Chang, X. Guo, R. Li, Z. Han, and T. Hämäläinen, "Resource allocation and computation offloading for multi-access edge computing with fronthaul and backhaul constraints," *IEEE Trans. Veh. Tech.*, vol. 70, no. 8, pp. 8037–8049, 2021.
- [16] Q. Gu, Y. Jian, G. Wang, R. Fan, H. Jiang, and Z. Zhong, "Mobile edge computing via wireless power transfer over multiple fading blocks: An optimal stopping approach," *IEEE Trans. Veh. Tech.*, vol. 69, no. 9, pp. 10 348–10 361, 2020.
- [17] F. Wang, J. Xu, X. Wang, and S. Cui, "Joint offloading and computing optimization in wireless powered mobile-edge computing systems," *IEEE Trans. Wirel. Commun.*, vol. 17, no. 3, pp. 1784–1797, 2018.
- [18] F. Zhou and R. Q. Hu, "Computation efficiency maximization in wireless-powered mobile edge computing networks," *IEEE Trans. Wirel. Commun.*, vol. 19, no. 5, pp. 3170–3184, 2020.
- [19] J. Zhao, X. Sun, Q. Li, and X. Ma, "Edge caching and computation management for real-time internet of vehicles: An online and distributed approach," *IEEE Trans. Intell. Transp. Syst.*, vol. 22, no. 4, pp. 2183–2197, 2021.
- [20] F. Zhou, Y. Wu, R. Q. Hu, and Y. Qian, "Computation rate maximization in UAV-enabled wireless-powered mobile-edge computing systems," *IEEE J. Sel. Areas Commun.*, vol. 36, no. 9, pp. 1927–1941, 2018.
- [21] Z. Chang, L. Liu, X. Guo, and Q. Sheng, "Dynamic resource allocation and computation offloading for IoT fog computing system," *IEEE Trans. Ind. Informatics*, vol. 17, no. 5, pp. 3348–3357, 2021.
- [22] D. Cai, Y. Xu, F. Fang, Z. Ding, and P. Fan, "On the impact of time-correlated fading for downlink NOMA," *IEEE Trans. Commun.*, vol. 67, no. 6, pp. 4491–4504, 2019.
- [23] C. Zhong, S. Jin, and K. Wong, "Dual-hop systems with noisy relay and interference-limited destination," *IEEE Trans. Commun.*, vol. 58, no. 3, pp. 764–768, 2010.
- [24] L. Fan, X. Lei, N. Yang, T. Q. Duong, and G. K. Karagiannidis, "Secure multiple amplify-and-forward relaying with cochannel interference," *IEEE J. Sel. Topics Sig. Proc.*, vol. 10, no. 8, pp. 1494–1505, 2016.
- [25] D. Cai, Z. Ding, P. Fan, and Z. Yang, "On the performance of NOMA with hybrid ARQ," *IEEE Trans. Veh. Tech.*, vol. 67, no. 10, pp. 10033–10038, 2018.
- [26] R. Fan, J. Cui, W. Chen, J. An, and G. Wang, "Resource allocation in cognitive underlay system with uncertain interference channel's statistics," *IEEE Commun. Lett.*, vol. 22, no. 5, pp. 1022–1025, 2018.
- [27] X. Chen, Z. Zhang, C. Zhong, D. W. K. Ng, and R. Jia, "Exploiting inter-user interference for secure massive non-orthogonal multiple access," *IEEE J. Sel. Areas Commun.*, vol. 36, no. 4, pp. 788–801, 2018.
- [28] R. Fan, W. Chen, J. An, F. Gao, and G. Wang, "Robust power and bandwidth allocation in cognitive radio system with uncertain distributional interference channels," *IEEE Trans. Wirel. Commun.*, vol. 15, no. 10, pp. 7160–7173, 2016.
- [29] C. Li, J. Xia, F. Liu, D. Li, L. Fan, G. K. Karagiannidis, and A. Nallanathan, "Dynamic offloading for multiuser Multi-CAP MEC networks: A deep reinforcement learning approach," *IEEE Trans. Veh. Tech.*, vol. 70, no. 3, pp. 2922–2927, 2021.
- [30] Z. Zhao, J. Xia, L. Fan, X. Lei, G. K. Karagiannidis, and A. Nallanathan, "System optimization of federated learning networks with a constrained latency," *IEEE Trans. Veh. Tech.*, vol. 71, no. 1, pp. 1095–1100, 2022.
- [31] A. P. Prudnikov, Y. A. Brychkov, and O. I. Marichev, *Integrals and Series: More special functions*, 1st ed. CRC, 1990.
- [32] Y. Li, Q. Yin, L. Sun, H. Chen, and H. M. Wang, "A channel quality metric in opportunistic selection with outdated CSI over Nakagami-m fading channels," *IEEE Trans. Veh. Tech.*, vol. 61, no. 3, pp. 1427–1432, 2012.
- [33] L. Fan, X. Lei, N. Yang, T. Q. Duong, and G. K. Karagiannidis, "Secrecy cooperative networks with outdated relay selection over correlated fading channels," *IEEE Trans. Veh. Tech.*, vol. 66, no. 8, pp. 7599–7603, 2017.



Xiazhi Lai Xiazhi Lai received the B.Eng. and M.S. degrees from Shantou University, Shantou, China, in 2015 and 2018, respectively. He is currently pursuing the Ph.D. degree with the School of Electronics and Information Technology, Sun Yat-sen University, Guangzhou, China. He is also with the School of Computer Science, Guangzhou University, under the supervision of Prof. L. Fan. His research interests include short-packet communications, cooperative communications, physical-layer security, and non-orthogonal multiple access.



Junjuan Xia received the bachelor degree from the department of computer science from Tianjin University in 2003, and obtained the master degree from the department of electronic engineering from Shantou University in 2015. Now she works for the School of Computer Science and Cyber Engineering, Guangzhou University. Her current research interests include wireless caching, physical-layer security, cooperative relaying and interference modeling.



Lisheng Fan Lisheng Fan received the bachelor and master degrees from Fudan University and Tsinghua University, China, in 2002 and 2005, respectively, both from the Department of Electronic Engineering. He received the Ph.D degree from the Department of Communications and Integrated Systems of Tokyo Institute of Technology, Japan, in 2008. He is now a Professor with the School of Computer Science, GuangZhou University. His research interests span in the areas of wireless cooperative communications, physical-layer secure communications, intelligent communications, and system performance evaluation. Lisheng Fan has published many papers in international journals such as IEEE Transactions on Wireless Communications, IEEE Transactions on Communications, IEEE Transactions on Information Theory, as well as papers in conferences such as IEEE ICC, IEEE Globecom, and IEEE WCNC. He is an editor of China Communications, and has served as a guest editor for many journals such as Physical Communication, EURASIP Journal on Wireless Communications and Networking, Wireless Communications and Mobile Computing, and so on. He has been awarded as Exemplary Reviewer by IEEE Transactions on Communications and IEEE Communications Letters.



Trung Q. Duong (fellow) is a Chair Professor of Telecommunications at Queen's University Belfast (UK), where he was a Lecturer (Assistant Professor) (2013-2017), a Reader (Associate Professor) (2018-2020), and Full Professor from August 2020. He also holds a prestigious Research Chair of Royal Academy of Engineering. His current research interests include wireless communications, signal processing, machine learning, realtime optimisation, and data analytic.

Dr. Duong currently serves as an Editor for the IEEE TRANSACTIONS ON WIRELESS COMMUNICATIONS, IEEE TRANSACTIONS ON VEHICULAR TECHNOLOGY, IEEE WIRELESS COMMUNICATIONS LETTERS, and an Executive Editor for IEEE COMMUNICATIONS LETTERS. He has served as an Editor/Guest Editor for IEEE TRANSACTIONS ON COMMUNICATIONS, IEEE WIRELESS COMMUNICATIONS, IEEE COMMUNICATIONS MAGAZINES, IEEE COMMUNICATIONS LETTERS, and IEEE JOURNAL ON SELECTED AREAS IN COMMUNICATIONS. He was awarded the Best Paper Award at the IEEE Vehicular Technology Conference (VTC-Spring) in 2013, IEEE International Conference on Communications (ICC) 2014, IEEE Global Communications Conference (GLOBECOM) 2016 and 2019, IEEE Digital Signal Processing Conference (DSP) 2017, and International Wireless Communications & Mobile Computing Conference (IWCMC) 2019. He is the recipient of prestigious Royal Academy of Engineering Research Fellowship (2015-2020) and has won a prestigious Newton Prize 2017. He is a Fellow of IEEE.



Arumugam Nallanathan (S'97-M'00-SM'05-F'17) is Professor of Wireless Communications and Head of the Communication Systems Research (CSR) group in the School of Electronic Engineering and Computer Science at Queen Mary University of London since September 2017. He was with the Department of Informatics at Kings College London from December 2007 to August 2017, where he was Professor of Wireless Communications from April 2013 to August 2017 and a Visiting Professor from September 2017. He was an Assistant Professor in the Department of Electrical and Computer Engineering, National University of Singapore from August 2000 to December 2007. His research interests include Artificial Intelligence for Wireless Systems, Beyond 5G Wireless Networks, Internet of Things (IoT) and Molecular Communications. He published nearly 500 technical papers in scientific journals and international conferences. He is a co-recipient of the Best Paper Awards presented at the IEEE International Conference on Communications 2016 (ICC'2016), IEEE Global Communications Conference 2017 (GLOBECOM'2017) and IEEE Vehicular Technology Conference 2018 (VTC'2018). He is an IEEE Distinguished Lecturer. He has been selected as a Web of Science Highly Cited Researcher in 2016 and AI 2000 Internet of Things Most Influential Scholar in 2020.

He is an Editor-at-Large for IEEE Transactions on Communications and Senior Editor for IEEE Wireless Communications Letters. He was an Editor for IEEE Transactions on Wireless Communications (2006-2011), IEEE Transactions on Vehicular Technology (2006-2017) and IEEE Signal Processing Letters. He served as the Chair for the Signal Processing and Communication Electronics Technical Committee of IEEE Communications Society and Technical Program Chair and member of Technical Program Committees in numerous IEEE conferences. He received the IEEE Communications Society SPCE outstanding service award 2012 and IEEE Communications Society RCC outstanding service award 2014.