

Overexpression of G_{sα} Protein in the Hearts of Transgenic Mice

Christophe Gaudin,* Yoshihiro Ishikawa,** David C. Wight,[§] Vijak Mahdavi,^{||} Bernardo Nadal-Ginard,^{||} Thomas E. Wagner,[§] Dorothy E. Vatner,¹ and Charles J. Homcy^{2,3,4}

*Department of Pharmacology and ²Department of Medicine, College of Physicians and Surgeons of Columbia University, New York 10032; [§]Edison Animal Biotechnology Center, Ohio University, Athens, Ohio, 45701; ^{||}Departments of Cardiology, Howard Hughes Medical Institute, Children's Hospital, and Harvard Medical School, Boston, Massachusetts 02115; ¹New England Regional Primate Research Center, Southborough, Massachusetts 01772; and **Medical Research Division, American Cyanamid Company, Pearl River, New York 10965

Abstract

Alterations in β -adrenergic receptor-G_s-adenylyl cyclase coupling underlie the reduced catecholamine responsiveness that is a hallmark of human and animal models of heart failure. To study the effect of altered expression of G_{sα}, we overexpressed the short isoform of G_{sα} in the hearts of transgenic mice, using a rat α -myosin heavy chain promoter. G_{sα} mRNA levels were increased selectively in the hearts of transgenic mice, with a level 38 times the control. Despite this marked increase in mRNA, Western blotting identified only a 2.8-fold increase in the content of the G_{sα} short isoform, whereas G_s activity was increased by 88%. The discrepancy between G_{sα} mRNA and G_{sα} protein levels suggests that the membrane content of G_{sα} is posttranscriptionally regulated. The steady-state adenylyl cyclase catalytic activity was not altered under either basal or stimulated conditions (GTP + isoproterenol, GTP γ S, NaF, or forskolin). However, progress curve studies did show a significant decrease in the lag period necessary for GppNHp to stimulate adenylyl cyclase activity. Furthermore, the relative number of β -adrenergic receptors binding agonist with high affinity was significantly increased. Our data demonstrate that a relatively small increase in the amount of the coupling protein G_{sα} can modify the rate of catalyst activation and the formation of agonist high affinity receptors. (*J. Clin. Invest.* 1995. 95:1676–1683.) Key words: G_{sα} protein • overexpression • α -myosin heavy chain (α -MHC) promoter • cardiac expression • transgenic mice • stoichiometry

Introduction

The GTP-binding heterotrimeric regulatory protein (G_s)¹ couples a variety of cell surface receptors, including the β -adrener-

gic receptor to activation of adenylyl cyclase. It is composed of α , β , and γ subunits and is a member of a large multigene family whose protein products play pivotal roles in mediating signal transduction across the cell membrane (1). Alterations in β -adrenergic receptor-G_s-adenylyl cyclase coupling underlie the reduced catecholamine responsiveness that is a hallmark of human and animal models of heart failure (2). Studies conducted in a variety of animal models of cardiac hypertrophy (3, 4), heart failure (5, 6), and ischemia (7) and in a model of in vivo desensitization (8) indicate that primary alterations in the β -adrenergic receptor-G_s-adenylyl cyclase pathway do occur distal to the receptor. In all of these models, there is a global reduction in adenylyl cyclase activation in cardiac sarcolemma, which can be associated with a reduction in G_{sα} activity, as assessed by the S49 cyc⁻ reconstitution assay. Changes in the amount of G_{sα} in these reports, however, are relatively small (~40%) considering the abundance of G_{sα} in cardiac membranes. Thus, whether alterations in the expression of G_{sα} in pathophysiological states could contribute in an important way to the altered cAMP production in the failing hearts remains to be elucidated. A recent study in S49 lymphoma cells suggested that the availability of adenylyl cyclase, rather than the amount of G_{sα} protein, is the limiting factor for agonist stimulation of adenylyl cyclase (9). The role of stoichiometry in the regulation of β -adrenergic receptor-G_s-adenylyl cyclase interactions remains unknown in cardiocytes, particularly in the intact functioning heart. Thus, we wished to examine whether alteration in the amount of G_{sα} in the heart affects cAMP production. For these reasons, we overexpressed the short isoform of G_{sα} in the hearts of mice into which a G_{sα} minigene construct under the control of a rat α -myosin heavy chain (α -MHC) promoter (10) had been introduced as a transgene. In this study, we assess the efficacy of the promoter construct and the effects of G_{sα} overexpression on adenylyl cyclase activity in sarcolemmal membranes prepared from the hearts of transgenic mice.

Methods

Construction of the transgene. A 0.9-kb EcoRI-XbaI (blunted) fragment of the rat α -MHC gene, containing a 0.6-kb promoter portion, the first exon, the first intron, and the first 43 bp of the second exon proximal to the initiation ATG, was fused to a 1.1-kb XhoI (blunted)-MluI fragment of the dog G_{sα} cDNA containing exons 1–12, followed by a 1.3-kb MluI-BamHI fragment of the human G_{sα} gene containing intron 12, exon 13, and the polyadenylation signal (Fig. 1). We used this human gene fragment because we could not obtain the canine equivalent even after repeated library screening. The amino acid sequence within this domain is identical in the human and canine G_{sα}, and thus the putative chimeric G_{sα} protein should possess the same amino acid sequence as the wild type. Furthermore, it has been previously reported that the addition of introns increases transcriptional efficiency in

C. Gaudin's present address is Institut de Recherche Jouveinal, Fresnes, France. Address correspondence to Dr. Charles J. Homcy, Medical Research Division, Lederle Laboratories, American Cyanamid Company, Pearl River, NY 10965. Phone: 914-732-4570; FAX: 914-732-5539.

Received for publication 11 May 1994 and in revised form 1 December 1994.

1. Abbreviations used in this paper: G_s, heterotrimeric guanine nucleotide-binding stimulatory protein; GppNHp, guanyl-5'-yl imidodiphosphate; GTP γ S, guanosine 5'-O-(3-thio)triphosphate; MHC, myosin heavy chain.

J. Clin. Invest.

© The American Society for Clinical Investigation, Inc.

0021-9738/95/04/1676/08 \$2.00

Volume 95, April 1995, 1676–1683

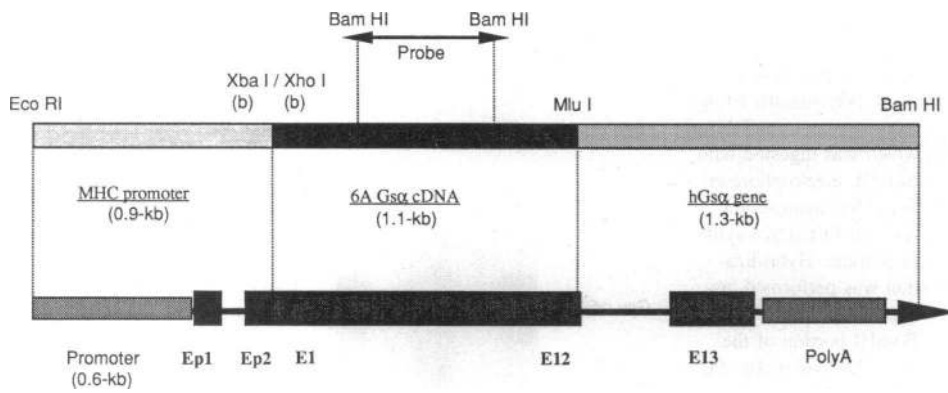

Figure 1. Description of the α -MHC- $G_{s\alpha}$ transgene. Above are shown the restriction sites used for subcloning. (b) indicates blunted sites. Below are shown the different components of the transgene. Exons are shown as boxes, and introns are depicted by solid lines. MHC promoter contains 0.6 kb of 5' flanking sequence, the first exon (*Ep1*), the first intron, and a portion of the second exon (*Ep2*) from the rat α -MHC gene; 6A $G_{s\alpha}$ cDNA is a canine cDNA coding for the short isoform of the $G_{s\alpha}$ protein from exon 1 (*E1*) to exon 12 (*E12*);

$hG_{s\alpha}$ is a portion of the human gene containing intron 12, exon 13 (*E13*), and the polyadenylation signal (*PolyA*). The probe used for Southern and Northern blot analyses is indicated at the top of the figure.

transgenic mice (11). The fusion construct was amplified in a pGEM-7Z plasmid (Promega, Madison, WI). The EcoRI–BamHI 3.3-kb transgene was then purified using a Elutip-D column (Schleicher & Schuell, Keene, NH) and prepared for microinjection, as previously described (12).

Production of transgenic mice. C57BL/6J mice (purchased from Jackson Laboratory, Bar Harbor, ME) were used as embryo donors. Founder transgenic mice were created by microinjection of ~1,000 copies of the transgene into the male pronucleus of the fertilized mouse eggs, as previously described (12). Microinjected eggs were implanted into the oviduct of 1-d pseudopregnant female mice and carried to term. Positive founders were bred to adult normal C57BL/6 \times C3H (B6C3) F_1 hybrid females to establish independent germ lines.

Screening of transgenic mice by genomic southern blotting. 3 wk after the birth of animals resulting from the microinjected eggs, total genomic DNA was extracted from the tail as described elsewhere (13). Genomic Southern blots were performed with 10 μ g of this DNA cut with BamHI. Hybridization was performed using a 0.5-kb BamHI–BamHI fragment of the $G_{s\alpha}$ cDNA as probe at 42°C in a 50% formamide solution containing 5 \times SSC, 5 \times Denhardt's solution, 25 mM sodium phosphate (pH 6.5), 0.25 mg/ml salmon sperm DNA, and 0.1% SDS. The probe was radiolabeled with [32 P]dCTP, using the Multiprime DNA Labeling System (Amersham Corp., Arlington Heights, IL). The blot was hybridized for 48 h and then washed in a solution containing 0.2% SDS and 0.2 \times SSC at 60°C for 30 min, followed by autoradiography. Adult mice of both sexes (8–12 wk old) were used in further experiments.

RNA isolation and northern blot analysis. Total RNA was isolated from heart and other tissues. Prehybridization and hybridization were performed at 42°C in the 50% formamide solution previously described, using the same BamHI–BamHI 0.5-kb cDNA fragment as probe. After 24 h of hybridization, the blot was washed in a solution containing 0.2 \times SSC and 0.2% SDS at 60°C for 30 min, followed by autoradiography. Blots were then erased and rehybridized with a 28S rRNA oligonucleotide probe. The amount of $G_{s\alpha}$ mRNA expression was standardized using the 28S rRNA content as a control.

Membrane preparation and western blot analysis. One control mouse from the same founder line was sacrificed at the same time as each transgenic mouse. Hearts were dissected from the mice and homogenized in 10 mM Tris-HCl, pH 8.0, using a Polytron (Brinkmann Instruments, Westbury, NY). The homogenate was centrifuged twice at 48,000 g for 10 min and filtered through gauze. The pellet was then resuspended in a 100 mM Tris-HCl pH 7.2, 1 mM EGTA, 5 mM MgCl₂ solution and rehomogenized. Protein concentration was measured by the method of Bradford (14) using BSA as the standard. Membranes were then aliquoted to be used for the adenylyl cyclase and G_s reconstitution assays and Western blotting. 20 μ g of each membrane preparation was electrophoresed on a 4–20% gradient SDS–polyacrylamide gel. Proteins were transferred to a polyvinylidene difluoride membrane (Im-

mobilon, Millipore, Bedford MA) for Western blot immunodetection. Detection was performed with a 1:2,000 dilution of anti- $G_{s\alpha}$ antiserum (New England Nuclear, Boston, MA), followed by a 1:300 dilution of anti-rabbit Ig peroxidase-linked species-specific whole antibody using the ECL detection system (Amersham Corp.). This antibody detected both murine and canine $G_{s\alpha}$ proteins. After checking the linear relation between staining and the amount of protein analyzed, $G_{s\alpha}$ protein was quantitated by densitometry, using a computing densitometer (model 300 Δ , Molecular Dynamics, Sunnyvale, CA).

Reconstitution of G_s into S49 *cyc*[−] membranes (quantification of functional G_s). Using the stable reconstitution protocol devised by Sternweis and Gilman (15), cardiac membranes were first solubilized in 2% cholate in a buffer of 16 mM Tris, pH 8.0, 0.8 mM EDTA, 0.8 mM DTT. The cholate extract was centrifuged at 20,000 g for 30 min, the endogenous adenylyl cyclase was inactivated by incubation at 30°C for 10 min, and the supernatant was diluted into a Lubrol buffer (6) in preparation for reconstitution into 60 μ g of S49 *cyc*[−] membranes, which were prepared according to the method of Ross et al. (16). AIF-responsive adenylyl cyclase activity was assessed over a range of solubilized cardiac membrane (1.5–4.5 μ g for the crude membrane preparation) at 30°C for 15 min; under these conditions, it is known to produce a linear response. The slope of this line (pmoles of cAMP per minute versus added solubilized membrane preparation) was used as a measure of G_s functional activity (6). Measurements were performed with a control from the same founder line for each transgenic sample.

Na^+ , K^+ -ATPase activity. As an index of the consistency of the membrane preparation, Na^+ , K^+ -ATPase enzymatic activity was measured according to the method of Jones et al. (17).

Adenylyl cyclase assay. 15 μ g per tube crude cardiac membrane preparations was used for the adenylyl cyclase assay. Adenylyl cyclase activity was measured by a modification of the method of Salomon (18). Briefly, the fixed time assays were performed in a final volume of 100 μ l of a solution containing 20 mM Hepes, pH 8.0, 5 mM MgCl₂, 0.1 mM cAMP, 0.1 mM ATP and [32 P]ATP (4 μ Ci per assay tube), 1 mM creatine phosphate, 8 μ g/ml creatine phosphokinase, and 0.5 mM 3-isobutyl-1-methyl-xanthine as an inhibitor of cAMP phosphodiesterase. The reaction mixture was incubated at 30°C for 15 min, and the reaction was stopped by the addition of 100 μ l of 2% SDS. cAMP was separated from ATP by passing through Dowex (BioRad Laboratories, Richmond, CA) and alumina columns, successively. To monitor recovery throughout the assay, 3 H-labeled cAMP was included in the incubation mixture. The radioactivity was measured by liquid scintillation counting. Stimulated adenylyl cyclase activities were measured with addition of 100 μ M GTP \pm 100 μ M isoproterenol (GTP+iso), 100 μ M guanosine 5'-O-(3-thio)triphosphate (GTP γ S), 10 mM NaF, or 100 μ M forskolin. All measurements were performed in quadruplicate, with a nontransgenic control from the same founder line for each transgenic sample. cAMP production in the presence of GTP+iso was linear over 20 min in these preparations.

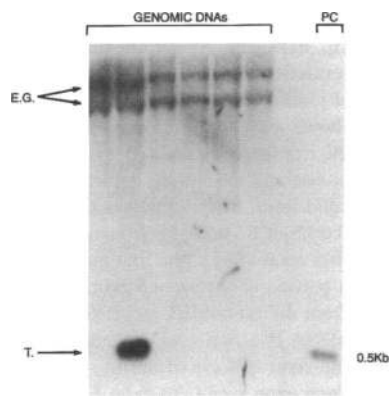

Figure 2. Screening of transgenic mice by Southern blot analysis. Each lane contains 10 μ g of mouse genomic DNA, which was digested with BamHI, electrophoresed in a 0.8% agarose gel, and transferred to a nylon membrane. Hybridization was performed, using a 0.5-kb BamHI–BamHI portion of the $G_{s\alpha}$ cDNA as probe. PC indicates 10 pg of the pGEM-7Z plasmid containing the transgene digested with BamHI, which was run as a control to assess the sensitivity of the detection assay. E.G. indicates the endogenous gene. T. is the transgene, indicating that the mouse corresponding to this genomic DNA (second lane) is a positive founder.

containing the transgene digested with BamHI, which was run as a control to assess the sensitivity of the detection assay. E.G. indicates the endogenous gene. T. is the transgene, indicating that the mouse corresponding to this genomic DNA (second lane) is a positive founder.

Progress curves with different concentrations of guanyl-5'-imidodiphosphate (GppNHP; from 0.017 to 333 μ M) were obtained by increasing the final incubation volume to 1.0 ml, withdrawing 100 μ l aliquots from these incubations at the indicated times (every 3 min), and stopping the reactions by adding the withdrawn aliquots to 100 μ l of 2% SDS (19). Results of the progress curves were standardized by expressing them as a percentage of the maximal production of cAMP achieved at 30 min with 333 μ M GppNHP. Steady-state slopes of cardiac adenylyl cyclase activity were calculated from 12 to 21 min, over which activity was constantly linear. Initial slopes were estimated by calculation of the regression line forced to pass through the origin between 0 and 9 min. The significance of this regression line was always checked.

β -Adrenergic receptor agonist binding studies. Competitive inhibition agonist binding curves were constructed as previously described (20), using 85 μ l of the crude sarcolemma, 25 μ l of 125 I-cyanopindolol (0.07 nM), 25 μ l of isoproterenol (10^{-9} to 5×10^{-4} M) with 22 concentrations of isoproterenol, and 15 μ l of Tris buffer. Assays were performed in duplicate, incubated at 37°C for 40 min, terminated by rapid filtration on GF/C filters, and counted in a gamma counter for 1 min. The binding data were analyzed by the LIGAND program (21). In the computer analysis, the *F* test was used to compare the best fit for the ligand binding competition data. The best fit, two-site versus one-site, was determined by the *p* value for the *F* test. When the data were best fitted to a single low affinity site, the number of receptors in the high affinity state was set to 0.

Statistical analysis. Comparisons between transgenic and control animal values were made using a paired *t* test. *P* < 0.05 was taken as a minimal level of significance.

Results

Production of transgenic mice. We screened 116 mice (57 male and 59 female) resulting from injection of fertilized eggs. Of these mice, 10 (2 male and 8 female mice) were positive, as shown by genomic Southern blotting with a 0.5-kb portion of the $G_{s\alpha}$ cDNA as probe (Fig. 2). Breeding of these 10 founder animals with normal mice gave five independent germlines. Three of the initial founders remained infertile. Two other founders produced no positive litters, suggesting that these two mice were probably chimeric.

$G_{s\alpha}$ expression in transgenic mice. By Northern blot analysis of total cardiac RNA from the five independent germlines and from normal mice, we found that three of these lines were

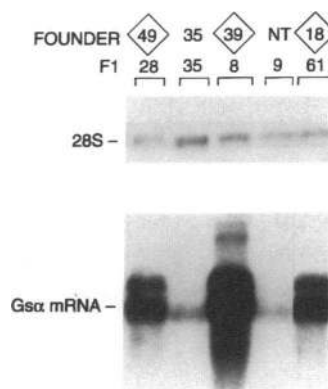

Figure 3. $G_{s\alpha}$ mRNA expression in the hearts of transgenic and nontransgenic mice. Each lane contains 30 μ g of total RNA, which was isolated from mouse cardiac tissues. Samples were electrophoresed in a 1.0% agarose–formaldehyde gel. The 32 P-labeled probe used for hybridization was either a 0.5-kb BamHI–BamHI portion of the $G_{s\alpha}$ cDNA (top panel) or an oligonucleotide corresponding to the 28S ribosomal RNA sequence (bottom panel). At the top of the figure are indicated the numbers of the transgenic lines (founders) and of the F₁ mice that were used in this assay. NT is a nontransgenic mouse. Lines 49 and 18 are both overexpressing $G_{s\alpha}$ mRNA eight times the control level. Line 39 is overexpressing $G_{s\alpha}$ mRNA 38 times the control level. Line 35 is not overexpressing $G_{s\alpha}$ mRNA.

overexpressing $G_{s\alpha}$ mRNA eight times the control level. Line 39 is overexpressing $G_{s\alpha}$ mRNA 38 times the control level. Line 35 is not overexpressing $G_{s\alpha}$ mRNA.

overexpressing $G_{s\alpha}$ mRNA in the heart (Fig. 3). Two $G_{s\alpha}$ mRNA species of different sizes were detected in transgenic mice. The size of the smaller, more abundant $G_{s\alpha}$ mRNA species (the “major” band) was as expected if the $G_{s\alpha}$ transgene RNA were correctly spliced and is the same size as the endogenous $G_{s\alpha}$ message. We also detected a larger, but much less abundant message (the “minor” band). We do not know the exact nature of this message; however, it could be an incompletely spliced species containing additional gene sequences (see Fig. 1). Thus we quantified the major $G_{s\alpha}$ mRNA species as representing the expression of transgenic $G_{s\alpha}$ mRNA. Two lines (18 and 49) both showed an eightfold overexpression of $G_{s\alpha}$ mRNA. One line (39) showed a 38-fold overexpression. The two other transgenic lines did not show any overexpression. Line 39, which showed the highest expression of $G_{s\alpha}$ mRNA, was further analyzed in the following experiments.

To assess the specificity of expression produced with the α -MHC promoter, Northern blot analysis was performed, using total RNA extracted from lung, liver, kidney, muscle, and brain. For this purpose, mice from line 39 were compared with control

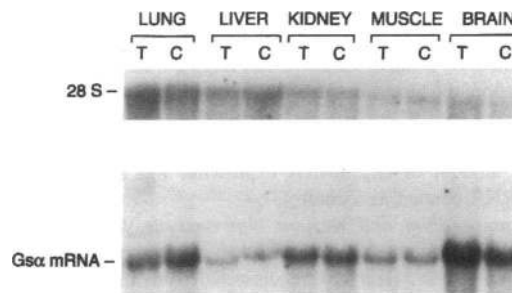

Figure 4. $G_{s\alpha}$ mRNA expression in various tissues of transgenic mice. Each lane contains 30 μ g of total RNA, which was isolated from different mouse tissues. Samples were electrophoresed in a 1.0% agarose formaldehyde gel. The 32 P-labeled probe used for hybridization was either a 0.5-kb BamHI–BamHI portion of the $G_{s\alpha}$ cDNA (top panel) or an oligonucleotide corresponding to the 28S ribosomal RNA sequence (bottom panel). At the top of the figure are indicated the different tissues tested. T indicates a transgenic animal from line 39; C indicates a nontransgenic control from the same line.

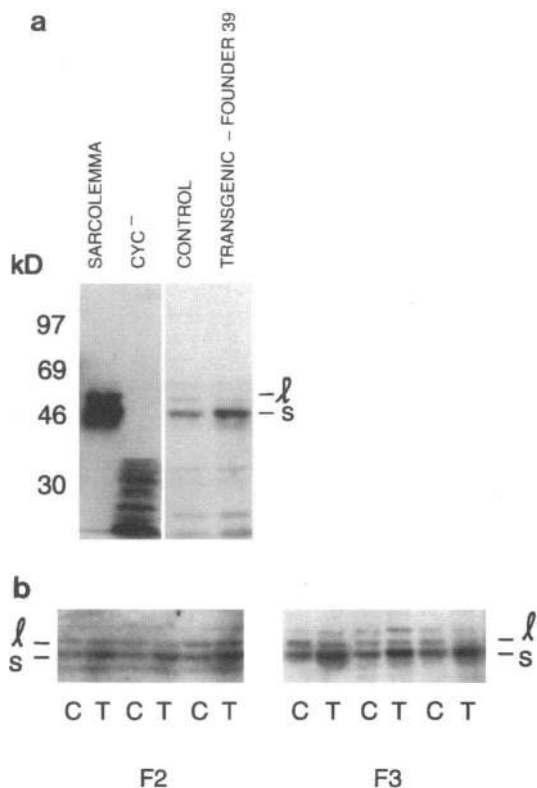

Figure 5. $G_{s\alpha}$ protein expression in the hearts of transgenic and control mice. Membrane proteins were electrophoresed in a 4–20% gradient SDS–polyacrylamide gel and then transferred to a polyvinylidene difluoride membrane. $G_{s\alpha}$ was detected with a 1:2,000 dilution of anti- $G_{s\alpha}$ antibody, followed by a 1:300 dilution of anti-rabbit Ig, peroxidase-linked species-specific whole antibody using the ECL detection system. (a) The two first lanes were loaded enriched sarcolemma and S49 cyc^- membrane preparations, respectively, as a positive and a negative control. The other lanes were loaded 20 μg of membrane proteins prepared from control or transgenic mouse hearts (line 39). On the left side are indicated approximate molecular weights; l indicates the band corresponding to the long $G_{s\alpha}$ isoform, which was used as a control for the loading; s indicates the band corresponding to the short $G_{s\alpha}$ isoform, which was overexpressed. (b) Offspring from different generations were compared. The increase in membrane $G_{s\alpha}$ protein in the transgenic mice was 2.8-fold.

mice from the same line (Fig. 4). We used hybridization with a ^{32}P -labeled oligonucleotide corresponding to the 28S ribosomal RNA sequence as an internal control for total RNA loading and transfer efficiency. This analysis showed a difference in $G_{s\alpha}$ mRNA expression only in brain. This difference between transgenic and control animals, however, did not reach a level comparable to that observed in the heart (2-fold overexpression in the brain versus 38-fold in the heart). Similar cardiac-specific expression was also seen in other lines, including line 18 (data not shown).

Western blotting of cardiac $G_{s\alpha}$ protein was performed on membranes from transgenic mice overexpressing $G_{s\alpha}$ mRNA, using a commercially available antiserum specific for $G_{s\alpha}$ (Fig. 5). Densitometry, using the long $G_{s\alpha}$ isoform as an internal control of loading and transfer, gave a semiquantitative assessment of $G_{s\alpha}$ protein overexpression. Line 39, which showed a 38-fold overexpression of $G_{s\alpha}$ mRNA, demonstrated a 2.8-fold overexpression of the protein. The degree of $G_{s\alpha}$ overexpression

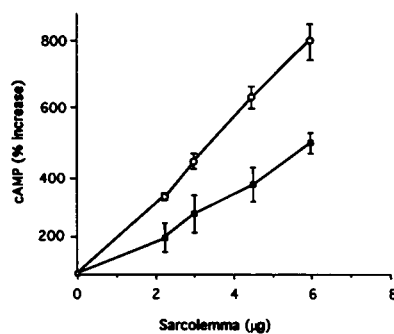

Figure 6. Cardiac G_s functional activity in transgenic mice. Solubilized cardiac membranes that were prepared from transgenic (line 39) (circles) or control (squares) mice were reconstituted into S49 cyc^- membranes to measure G_s functional activity. Values are expressed as the percent increase over the adenylyl cyclase activity of cyc^- membranes alone. Results are expressed as the mean \pm SEM ($n = 4$, $p < 0.01$).

was consistent among offspring and generations within the same line (Fig. 5 b). In contrast, using an antiserum specific for $G_{i\alpha 2}$ (22), we did not find any difference between transgenic and control mice.

Functional G_s activity. To assess whether the overexpressed $G_{s\alpha}$ protein was functional, we measured G_s activity by a reconstitution assay in sarcolemma prepared from transgenic mice, as compared with control mice from the same line (Fig. 6). This assay demonstrated increased functional G_s activity in the hearts of transgenic mice. This activity was higher in line 39 ($188 \pm 10\%$, mean \pm SEM) compared with control animals from the same line. Thus, increased functional activity accompanied the increase in $G_{s\alpha}$ protein and mRNA levels. However, the absolute increment over control levels was not maintained; there were a 38-fold increase in mRNA (38 ± 3 , $n = 4$), a 2.8-fold increase in protein (2.8 ± 0.2 , $n = 8$), and a 1.9-fold increase in $G_{s\alpha}$ functional activity (1.9 ± 0.1 , $n = 4$). A similar pattern was observed in line 18: there was an 8-fold increase in mRNA (8.1 ± 0.7 , $n = 4$), a 1.4-fold increase in protein (1.4 ± 0.2 , $n = 6$), and a 1.2-fold (1.2 ± 0.05 , $n = 5$) increase in $G_{s\alpha}$ functional activity.

Effect of $G_{s\alpha}$ protein overexpression on basal and stimulated steady-state cardiac adenylyl cyclase activity. To assess whether $G_{s\alpha}$ protein overexpression in the heart resulted in increased adenylyl cyclase activity, we first compared the steady-state adenylyl cyclase activity between transgenic and control animals by measuring the production of cAMP in sarcolemmal membranes after 15 min of incubation, under basal or stimulated conditions. However, we were unable to identify any significant increase in steady-state adenylyl cyclase activity, under basal or stimulated conditions (GTP + iso, GTP γ S, NaF, and forskolin) (Fig. 7).

Effect of $G_{s\alpha}$ protein overexpression on the time course of activation of cardiac adenylyl cyclase by GppNHp. To assess further whether $G_{s\alpha}$ protein overexpression in the heart resulted in a more rapid stimulation of adenylyl cyclase, we constructed a progress curve of cAMP production under GppNHp stimulation following the approach and protocol described by Birnbaumer et al. (19). With a concentration of 111 μM GppNHp in the reaction mixture, the steady-state slopes of cardiac adenylyl cyclase activity were similar between three transgenic and three control mice (Fig. 8 a). The early time points, however, showed a significantly higher production of cAMP in transgenic as compared with control mice at 3, 6, and 9 min (Fig. 8 b). This was reflected as a decrease in the lag period for GppNHp to exert its effect in stimulating adenylyl cyclase in transgenic mice

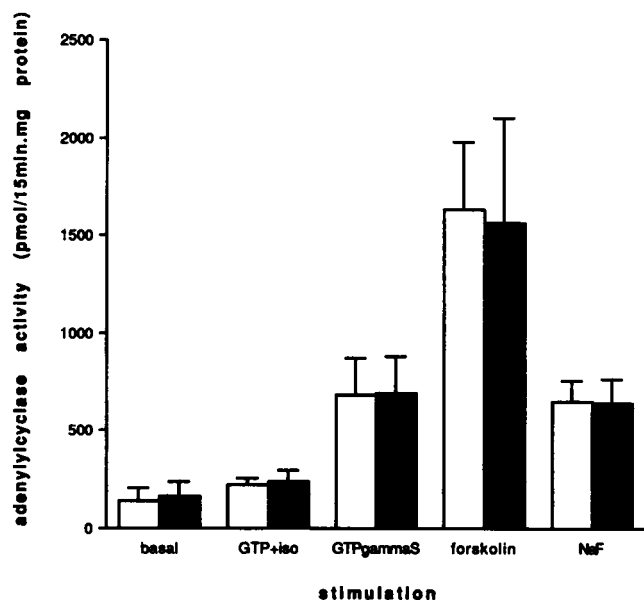

Figure 7. Basal and stimulated cardiac adenylyl cyclase activity in transgenic mice. The adenylyl cyclase activity in 15 μ g of crude cardiac membrane was assayed for 15 min at 30°C, under basal conditions or stimulated by the following agents: GTP + iso, GTP γ S, NaF, or forskolin. Control values are represented as open bars; values for transgenic mice (line 39) are represented as solid bars. All measurements were performed in quadruplicate. Results are expressed as the mean \pm SEM ($n = 8$, $p = NS$).

as compared with control mice. Varying the concentration of GppNHp exerted the same effect on the steady-state production of cAMP in transgenic and control mice (Fig. 9 a). The initial slopes, however, significantly differed between transgenic and control mice, independently of the concentration of GppNHp that was used (Fig. 9 b). The initial slope was significantly lower than the steady-state slope in control animals (Fig. 9 c), reflecting the existence of a lag period in the progress curve. In contrast, in transgenic animals, the initial slope was similar to the steady-state slope (Fig. 9 d), reflecting a disappearance or decrease in the lag period, independently of the concentration of GppNHp that was used.

Effect of G_{sa} protein overexpression on cardiac β -adrenergic receptor agonist binding. Isoproterenol competition curves for the control and transgenic animals were fitted to a two-site model, i.e., a high affinity site (K_H) and a low affinity site (K_L). The average percentages of β -adrenergic receptors binding agonist with high affinity and low affinity are shown in Table I. The relative number of high affinity sites was significantly greater in transgenic than in control mice. 80% of the total binding was specific.

Discussion

For over 40 yr, data have accumulated to indicate that sympathetic activation of the heart becomes impaired in states of cardiac stress and that this process could contribute to eventual cardiac decompensation and heart failure (2). Decreases in total β -adrenergic receptor density, the high affinity fraction, G_s activity, and adenylyl cyclase catalytic content have all been suggested as contributing to the process. We have also identified

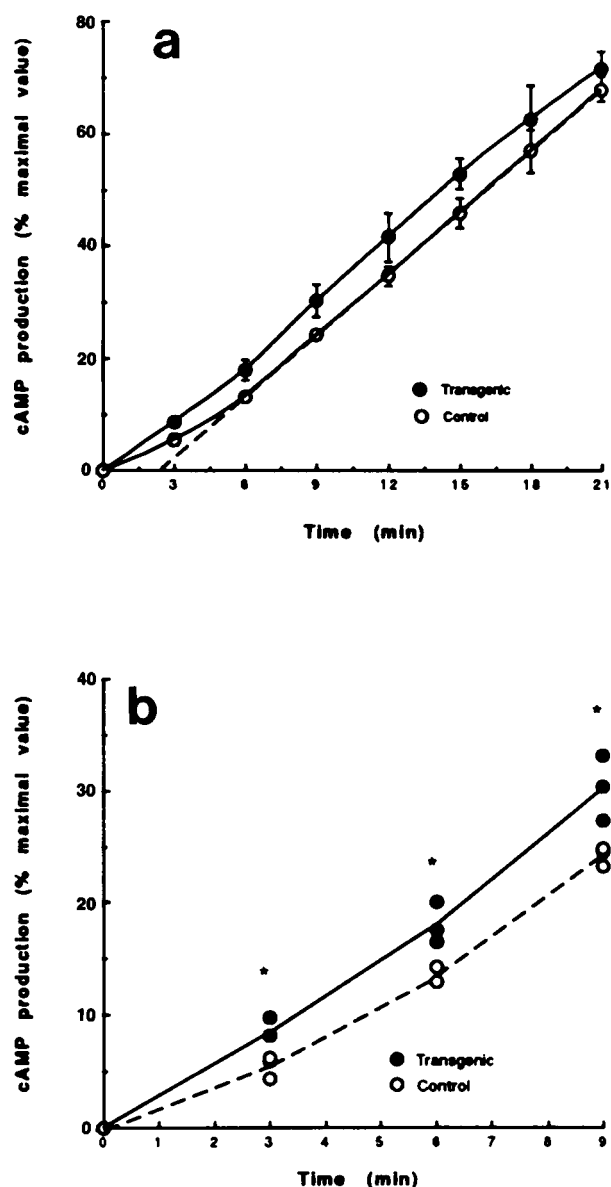

Figure 8. Time courses of activation of cardiac adenylyl cyclase by 111 μ M GppNHp in transgenic and control mice. Progress curves of adenylyl cyclase activity were constructed according to the protocol described in Methods in three control and three transgenic mice (line 39), in the presence of 111 μ M GppNHp. Results were standardized by expressing them as a percentage of the maximal production of cAMP achieved at 30 min with 333 μ M GppNHp. *a* shows the lag period necessary for GppNHp to exert its stimulatory effect in cardiac membranes from control mice (open circles); this lag period is decreased in cardiac membranes from transgenic mice (closed circles). Results are mean \pm SD of three control and three transgenic animals. *b* shows individual results between 0 and 9 min, with a statistically significant difference (*) between transgenic and control mice.

a loss in G_s functional activity accompanied by a decrease in G_{sa} mRNA content as a relative early occurrence during the development of cardiac hypertrophy associated with chronic pressure overload produced by aortic banding (4). However, the decrement in G_{sa} content or activity reported in these studies, including ours, was relatively small ($\sim 40\%$). Since G_{sa} protein

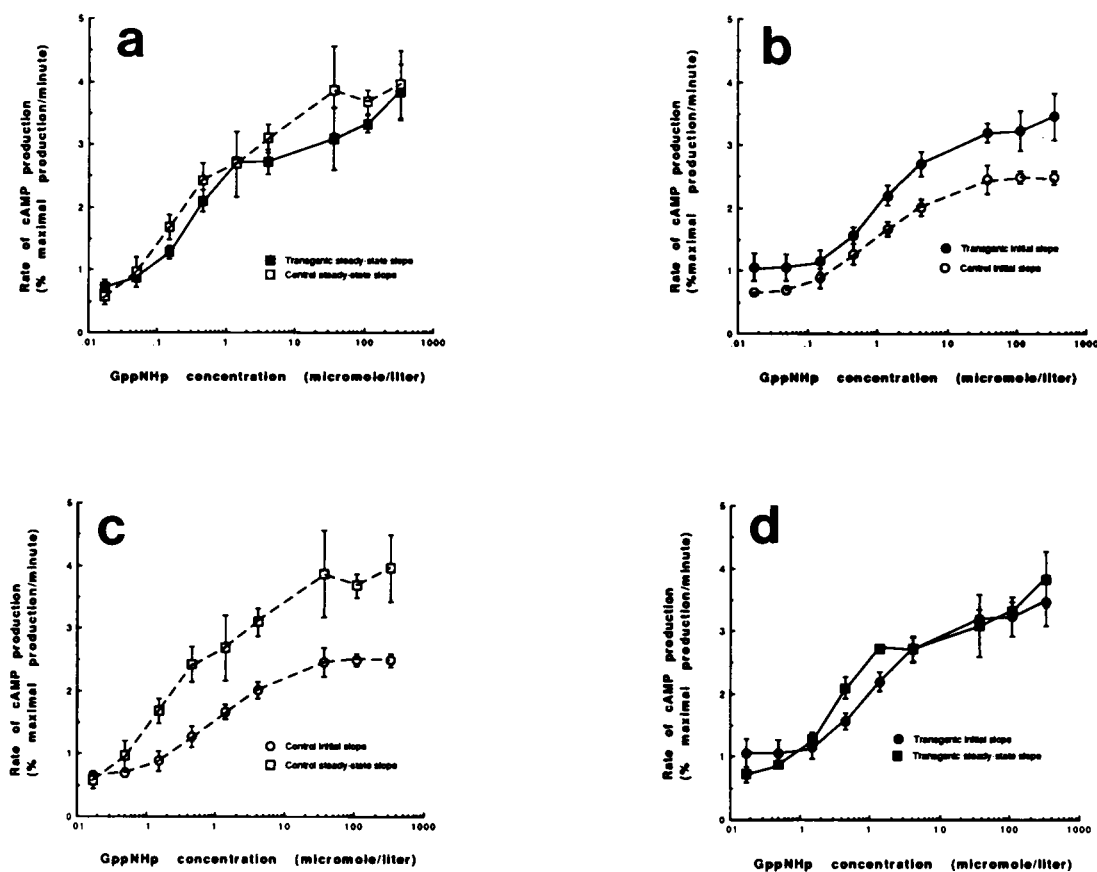

Figure 9. Comparisons of initial and steady-state slopes of cardiac adenylyl cyclase activity in transgenic and control mice, using different concentrations of GppNHp. Progress curves of adenylyl cyclase activity were constructed according to the protocol described in Methods in three control and three transgenic mice (line 39), using different concentrations (from 0.017 to 333 μ M) of GppNHp. Results of the progress curves were standardized by expressing the rate of cAMP production as a function of GppNHp concentration. The rate of cAMP production (percent maximal production/minute) was calculated by dividing either the steady-state or initial slope of cAMP production by the amount of maximal cAMP production achieved with 333 μ M GppNHp for 30 min. Steady-state (12–21 min) and initial (0–9 min) slopes were calculated for control (open circles or squares) and transgenic (closed circles or squares) mice and plotted as a function of GppNHp concentration. Results are expressed as mean \pm SD. *a* compares steady-state slopes between transgenic and control mice. *b* compares initial slopes between transgenic and control mice. *c* compares initial and steady-state slopes in control mice. *d* compares initial and steady-state slopes in transgenic mice.

exists in abundance relative to proteins such as receptors and adenylyl cyclase in cardiac membranes, it remains unknown whether a small change in the content of $G_{s\alpha}$ generates any functionally significant alteration.

To assess these proposals critically, therefore, it is first important to examine the effect of changing the content of any one of these components in the normal heart, free of the confounding

factors associated with the syndrome of heart failure. The availability of transgenic methods to alter the content of a particular gene product in the intact animal allows the assessment in the heart itself of altering the ratio of $G_{s\alpha}$ relative to receptor and the catalyst adenylyl cyclase. Because it would be both informative and simpler than attempting to decrease $G_{s\alpha}$ content, we first chose to enhance $G_{s\alpha}$ expression in a cardiac-specific manner in transgenic mice, although a decrement of $G_{s\alpha}$ expression is commonly observed in animal models of heart failure. Three results of these initial studies are important to consider.

Cardiac-specific expression with the α -MHC promoter. To induce cardiac-specific overexpression of $G_{s\alpha}$, we used a portion of the rat α -MHC gene containing 0.6 kb of the α -MHC promoter (10). In vitro, this portion of the α -MHC gene can direct reporter gene expression specifically in cardiac myocytes. The upstream portion of the mouse α -MHC gene has been previously used to generate transgenic mice (23, 24). In these experiments, a chloramphenicol acetyltransferase gene was used to quantify the ability of different constructs to drive gene expression in transgenic mice. This previous study found that 3.0 kb upstream of the mouse α -MHC gene (corresponding to a

Table I. Agonist Binding Studies

	Control (n = 10)	Transgenic (n = 9)
Isoproterenol binding affinity (nM)		
K_H	6.3 \pm 2.0	20.0 \pm 8.8
K_L	376 \pm 158	956 \pm 672
High affinity receptor sites (%)	55 \pm 4	73 \pm 7*
Low affinity receptor sites (%)	45 \pm 4	27 \pm 7*

* $P < 0.05$.

region where the sequence is preferentially conserved between mouse and rat) is competent to direct expression of the reporter gene in a cardiac-specific way. However, linkage of the chloramphenicol acetyltransferase gene to a short portion of the α -MHC gene with only 138 bp upstream of the transcriptional start site did not direct expression in either muscle or nonmuscle cells (23). The results of our study clearly demonstrate that, using the rat promoter, only 0.6 kb 5' of the transcriptional start site is sufficient to direct cardiac-specific expression of a transgene. The level of expression of $G_{s\alpha}$ mRNA, however, differed among our positive lines of transgenic animals. These differences in the expression level of the transgene may be related to differences in copy number or in the chromosomal position of integration of the foreign DNA (25). In another study in which SV40 large T antigen was overexpressed in the heart using a similar α -MHC promoter, the amount of large T antigen overexpression differed among individuals and different generations even within the same line (26). This contrasts with our results, in which $G_{s\alpha}$ overexpression was consistently maintained across different generations and $G_{s\alpha}$ mRNA content was directly related to $G_{s\alpha}$ protein content across different transgenic lines. These differences may result from the different nature of the transgene products (a viral oncoprotein versus a housekeeping gene product) or from the inclusion of intronic sequences in our construct.

Since no overexpression was observed in skeletal muscle, in particular, or in a variety of other tissues (except brain), this analysis underscores the high degree of specificity of the 0.6-kb rat α -MHC promoter for cardiac muscle in our study. In contrast with a previous report in which the mouse α -MHC upstream region was used (24), we did not observe any expression of our transgene in lung.

Relationship of $G_{s\alpha}$ protein levels to mRNA content. An obvious discrepancy exists between the steady-state mRNA levels induced by the transgene and the resulting increase in $G_{s\alpha}$ protein content. One of several mechanisms might explain this finding. The size of the major $G_{s\alpha}$ mRNA species detected in the transgenic mice is similar to that of endogenous $G_{s\alpha}$ mRNA, as we expected would be the case if the RNA precursor were correctly spliced. This finding makes it unlikely that incorrect processing of the precursor RNA contributed to the noted discrepancy. We have also detected another minor $G_{s\alpha}$ mRNA species in transgenic mice; the size of this mRNA species is similar to that of the transgene itself ($G_{s\alpha}$ cDNA plus intron 12; see Fig. 3). When the transgene was constructed, we ensured that the Kozak consensus sequence (27) present in the endogenous $G_{s\alpha}$ mRNA would be recapitulated. The total 5' flanking sequence, based on the size of the principal mRNA species detected, is similar to that of the endogenous mRNA. Nevertheless, we cannot exclude the possibility that the chimeric $G_{s\alpha}$ mRNA is less efficiently translated than the wild-type message. It is also possible that the explanation for the discrepancy between mRNA and protein content has a post-translational basis in which the nascent protein is rapidly catabolized. $G_{s\alpha}$ exists as a heterotrimeric complex in association with $\beta\gamma$ subunits. Rapid turnover of individual components of a multisubunit protein has previously been shown when only one of the subunits is overexpressed in transfected cell lines (28). It is possible that $\beta\gamma$ availability is rate limiting and that "free" $G_{s\alpha}$ subunit is rapidly degraded within the cardiocyte. Recently, it has been shown that $G_{s\alpha}$ is palmitoylated, which is likely a requirement for its efficient association with the plasma mem-

brane (29, 30). We cannot readily assess whether incomplete posttranslational processing of $G_{s\alpha}$ in the transgenic cardiocytes might contribute to lower than expected steady-state levels. Since $G_{s\alpha}$ has been found in soluble fractions (31), we compared the amount of $G_{s\alpha}$ in soluble fractions between transgenic and control mice, but found no difference (data not shown).

To confirm that the overexpressed $G_{s\alpha}$ protein was functional, the G_s activity of sarcolemma preparations from transgenic mice was measured by reconstitution into S49 cyc⁻ membranes and compared with that from control mice from the same line. $G_{s\alpha}$ functional activity was increased by 88% in the hearts of transgenic mice in comparison with control animals. This increase in cardiac $G_{s\alpha}$ functional activity does not account for all the overexpressed $G_{s\alpha}$ protein, since a semiquantitative assessment by densitometry after Western blotting detected a 180% increase in membrane $G_{s\alpha}$ protein. Whether this discrepancy relates to incomplete processing of a portion of the $G_{s\alpha}$ protein (e.g., palmitoylation) has not been determined.

Effect of increased $G_{s\alpha}$ on cardiac adenylyl cyclase activity and β -adrenergic receptor agonist binding. To test the hypothesis that overexpression of $G_{s\alpha}$ protein in the heart increases adenylyl cyclase activity, measurements of adenylyl cyclase activity under basal and simulated conditions were compared between transgenic and control animals from the same line. Our data indicate that, under steady-state conditions, $G_{s\alpha}$ overexpression in the heart does not alter the maximal number of $G_{s\alpha}$ -adenylyl cyclase complexes formed in myocytes. There are a variety of studies suggesting that the concentration of G_s is severalfold greater than that of both the β -adrenergic receptor and the catalyst adenylyl cyclase in cell membranes (9, 32). However, it is not clear that the availability of the G protein is functionally limiting in the process of signal transduction in cardiocytes, which are replete in multiple G_s -coupled receptors and effectors, including ion channels. Our measurements of adenylyl cyclase activity after catecholamine stimulation suggest that this latter possibility is not operative at least under steady-state conditions.

Next we wished to examine whether an increased level of $G_{s\alpha}$ in the membrane affects the rate of stimulation of adenylyl cyclase activity. Steady-state activities, when plotted as a function of GppNHp concentration, were similar between transgenic and control mice, with an apparent K_a value of 0.15 μ M in both cases. This K_a value is within the 0.05–0.25 μ M range previously described in rat liver under the same conditions (19). This lack of difference between transgenic and control mice suggests that under steady-state conditions, the number of GppNHp-bound $G_{s\alpha}$ -adenylyl cyclase complexes in the heart is limited by the availability of the adenylyl cyclase, irrespective of the amount of GppNHp-bound $G_{s\alpha}$. However, the progress curves of adenylyl cyclase activation did show a difference at the early time points; we observed an accelerated activation of adenylyl cyclase in transgenic mice as compared with control mice, i.e., cAMP production at 3, 6, and 9 min was significantly higher in transgenic mice. This observation was independent of the concentration of GppNHp that was used for the progress curves and led in the transgenic mice to an apparent disappearance or a decrease of the lag period necessary for GppNHp to exert its stimulating effect on adenylyl cyclase activity. This finding, i.e., enhanced rate of adenylyl cyclase activation, can be understood in the following context. A variety of data have previously shown that the rate of exchange of GDP for GTP at the G protein is rate limiting in the activation of adenylyl cy-

clase, as shown in the equation $G_{s\alpha}\text{-GDP} + \text{GTP} \rightarrow G_{s\alpha}\text{-GTP} + \text{GDP}$. Overexpression of $G_{s\alpha}$, therefore, would generate more $G_{s\alpha}\text{-GDP}$, and thus $G_{s\alpha}\text{-GTP}$ by a simple mass action effect as exemplified in the above equation, leading to an enhancement in the rate of catalytic activation. Similarly, the increased amount of $G_{s\alpha}\text{-GDP}$ in the transgenic mice is reflected in the increase in the relative number of β -adrenergic receptors binding agonist with high affinity, i.e., increased ternary complex formation in the transgenic mice. The above data indicate that a relatively small change in the content of $G_{s\alpha}$ can impact on receptor-G_s coupling and the rate of adenylyl cyclase activation in the heart. Under steady-state conditions, maximal adenylyl cyclase activation remains unchanged in transgenic mice as compared with controls (Figs. 7 and 9), suggesting that maximal catalytic activity is indeed limited by the availability of the enzyme adenylyl cyclase.

The availability of the transgenic lines reported in this study will allow one to examine receptor activation *in vivo* or in isolated cardiomyocytes, as assessed by the ability of catecholamines to increase heart rate, contractility, and cAMP accumulation. The capacity to measure an increase in heart rate and contractility instantaneously following catecholamine stimulation might allow additional insight as to whether a subtle alteration in the efficiency of signal transduction exists in the hearts of animals overexpressing $G_{s\alpha}$.

Acknowledgments

This work was supported by National Institutes of Health grants HL-38070, HL-37404, and HL-45332 and by a grant from the Medical Research Division, American Cyanamid Company-Lederle Laboratories. C. Gaudin was supported by Institut National de la Santé et de la Recherche Médicale, George Lurcy Foundation, and Fondation pour la Recherche Médicale.

References

- Gilman, A. G. 1987. G proteins: transducers of receptor-generated signals. *Annu. Rev. Biochem.* 56:615-649.
- Homcy, C. J., D. E. Vatner, and S. F. Vatner. 1991. Beta-adrenergic receptor regulation in the heart in pathophysiologic states: abnormal adrenergic responsiveness in cardiac disease. *Annu. Rev. Physiol.* 53:137-159.
- Vatner, D. E., C. J. Homcy, S. P. Sit, W. T. Manders, and S. F. Vatner. 1984. Effects of pressure overload, left ventricular hypertrophy on β -adrenergic receptors, and responsiveness to catecholamines. *J. Clin. Invest.* 73:1473-1482.
- Chen, L., D. E. Vatner, S. F. Vatner, L. Hittinger, and C. J. Homcy. 1991. Decreased G_s mRNA levels accompany the fall in G_s and adenylyl cyclase activities in compensated left ventricular hypertrophy. *J. Clin. Invest.* 87:293-298.
- Vatner, D. E., S. F. Vatner, A. M. Fuji, and C. J. Homcy. 1985. Loss of high affinity cardiac beta adrenergic receptors in dogs with heart failure. *J. Clin. Invest.* 76:2259-2264.
- Longabaugh, J. P., D. E. Vatner, S. F. Vatner, and C. J. Homcy. 1988. Decreased stimulatory guanosine triphosphate binding protein in dogs with pressure-overload left ventricular failure. *J. Clin. Invest.* 81:420-424.
- Susanni, E. E., W. T. Manders, D. R. Knight, D. E. Vatner, S. F. Vatner, and C. J. Homcy. 1989. One hour of myocardial ischemia decreases the activity of the stimulatory guanine-nucleotide regulatory protein. *Circ. Res.* 65:1145-1150.
- Vatner, D. E., S. F. Vatner, J. Nejima, N. Uemura, E. E. Susanni, T. H. Hintze, and C. J. Homcy. 1989. Chronic norepinephrine elicits desensitization by uncoupling the beta-receptor. *J. Clin. Invest.* 84:1741-1748.
- Alousi, A. A., J. J. Jasper, P. A. Insel, and H. J. Motulsky. 1991. Stoichiometry of receptor-Gs-adenylyl cyclase interactions. *FASEB (Fed. Am. Soc. Exp. Biol.) J.* 5:2300-2303.
- Rottman, J., W. R. Thompson, B. Nadal-Ginard, and V. Mahdavi. 1990. Myosin heavy chain gene expression: interplay of cis and trans factors determines hormonal and tissue specificity. In *The Dynamic State of Muscle Fibers*. D. Pett, editor. Walter de Gruyter, New York. 3-16.
- Brinster, R. L., J. M. Allen, R. R. Behringer, R. E. Gelinas, and R. D. Palmiter. 1988. Introns increase transcriptional efficiency in transgenic mice. *Proc. Natl. Acad. Sci. USA.* 85:836-840.
- Wagner, T. E., P. C. Hoppe, J. D. Jollick, D. R. Scholl, R. L. Hodinka, and J. B. Gault. 1981. Microinjection of a rabbit beta-globin gene into zygotes and its subsequent expression in adult mice and their offspring. *Proc. Natl. Acad. Sci. USA.* 78:6376-6380.
- Hogan, B., F. Constantinou, and E. Lacy. 1986. *Manipulating the Mouse Embryo: A Laboratory Manual*. Cold Spring Harbor Laboratory, Cold Spring Harbor, NY. 174-176.
- Bradford, M. M. 1976. A rapid and sensitive method for the quantitation of microgram quantities of protein utilizing the principle of protein-dye binding. *Anal. Biochem.* 72:248-254.
- Sternweis, P. C., and A. G. Gilman. 1979. Reconstitution of catecholamine-sensitive adenylyl cyclase. Reconstitution of the uncoupled variant of the S40 lymphoma cells. *J. Biol. Chem.* 254:3333-3340.
- Ross, E. M., M. E. Maguire, T. W. Sturgill, R. L. Biltonen, and A. G. Gilman. 1977. Relationship between the beta-adrenergic receptor and adenylyl cyclase. *J. Biol. Chem.* 252:5761-5775.
- Jones, L. R., S. W. Maddock, and H. R. J. Besch. 1980. Unmasking effect of alamethicin on the (Na^+ , K^+)-ATPase, beta-adrenergic receptor-coupled adenylyl cyclase, and cAMP-dependent protein kinase activities of cardiac sarcolemmal vesicles. *J. Biol. Chem.* 255:9971-9980.
- Salomon, Y. 1979. Adenylyl cyclase assay. *Adv. Cyclic Nucleotide Res.* 10:35-55.
- Birbaumer, L., T. L. Swartz, J. Abramowitz, P. W. Mintz, and R. Iyengar. 1980. Transient and steady state kinetics of the interaction of guanyl nucleotides with the adenylyl cyclase system from rat liver plasma membranes. Interpretation in terms of a simple two-state model. *J. Biol. Chem.* 255:3542-3551.
- Kiuchi, K., R. P. Shannon, K. Komamura, D. J. Cohen, C. Bianchi, C. J. Homcy, S. F. Vatner, and D. Vatner. 1993. Myocardial beta-adrenergic receptor function during the development of pacing-induced heart failure. *J. Clin. Invest.* 91:907-914.
- Munson, P. J., and D. Rodbard. 1980. Ligand: a versatile computerized approach for characterization of ligand-binding systems. *Anal. Biochem.* 107:220-239.
- Liao, J. K., and C. J. Homcy. 1992. Specific receptor-guanine nucleotide binding protein interaction mediates the release of endothelium-derived releasing factor. *Circ. Res.* 70:1018-1026.
- Gulick, J., A. Subramaniam, J. Neumann, and J. Robbins. 1991. Isolation and characterization of the mouse cardiac myosin heavy chain genes. *J. Biol. Chem.* 266:9180-9185.
- Subramaniam, A., W. K. Jones, S. Wert, J. Neumann, and J. Robbins. 1991. Tissue-specific regulation of the alpha-myosin heavy chain gene promoter in transgenic mice. *J. Biol. Chem.* 266:24613-24620.
- Al-Shawi, R., J. Kinnaird, J. Burke, and J. O. Bishop. 1990. Expression of a foreign gene in a line of transgenic mice is modulated by a chromosomal position effect. *Mol. Cell Biol.* 10:1192-1198.
- Katz, E. B., Steinhilber, M. E., J. B. Delcarpio, A. I. Daud, W. C. Claycomb, and L. J. Field. 1992. Cardiomyocyte proliferation in mice expressing alpha-cardiac myosin heavy chain-SV40 T-antigen transgenes. *Am. J. Physiol.* 262:H1867-H1876.
- Kozak, M. 1986. Point mutations define a sequence flanking the AUG initiator codon that modulates translation by eukaryotic ribosomes. *Cell.* 44:283-292.
- Kurosaki, T., I. Gander, and J. V. Ravetch. 1991. A subunit common to an IgG Fc receptor and the T-cell receptor mediates assembly through different interactions. *Proc. Natl. Acad. Sci. USA.* 88:3837-3841.
- Linder, M. E., P. Middleton, J. R. Hepler, R. Taussig, A. G. Gilman, and S. M. Mumby. 1993. Lipid modifications of G proteins: alpha subunits are palmitoylated. *Proc. Natl. Acad. Sci. USA.* 90:3675-3679.
- Taussig, R., J. A. Iniguez-Lluhi, and A. G. Gilman. 1993. Inhibition of adenylyl cyclase by Gi alpha. *Science (Wash. DC).* 261:218-221.
- Levis, M. J., and H. R. Bourne. 1992. Activation of the alpha subunit of G_s in intact cells alters its abundance, rate of degradation, and membrane avidity. *J. Cell Biol.* 119:1297-1307.
- Woon, C. W., S. Soparkar, L. Heasley, and G. L. Johnson. 1989. Expression of a G alpha s/G alpha i chimera that constitutively activates cyclic AMP synthesis. *J. Biol. Chem.* 264:5687-5693.