

**Parasite-host interactions between
the *Varroa* mite and the honey bee**

A contribution to sustainable *Varroa* control

Johan N.M. Calis

Promotoren:

Professor Dr. J.C. van Lenteren
Hoogleraar in de Entomologie, Wageningen Universiteit

Professor Dr. M.W. Sabelis
Hoogleraar in de Populatiebiologie, Universiteit van Amsterdam

Stellingen behorend bij het proefschrift *Parasite-host interactions between the Varroa mite and the honey bee, a contribution to sustainable control* van Johan N.M. Calis.

1. Imkeren met gezonde bijenvolken is mogelijk zonder het gebruik van synthetische acariciden.

Imdorf, A, Charrière, JD & Fiuri, P (1999) Alternative strategies for the control of acaricide resistant *Varroa* mites. *Proceedings of the 36th Apimondia congress*, Vancouver, Canada. pp 143; Dit proefschrift.

2. Zolang imkers de varroamijt bestrijden, zal van natuurlijke selectie voor minder gevoelige honingbijen geen sprake zijn.

3. Wanneer de ontwikkelingsduur van werksters van Europese honingbijen (*Apis mellifera* subsp.), net als bij de Kaapse honingbij (*Apis mellifera capensis*), gekoppeld is aan kenmerken die bij de kaste-differentiatie een rol spelen, is dit kenmerk niet geschikt voor selectie op honingbijen die minder gevoelig zijn voor de varroamijt.

Beekman, M, Calis, JNM, Boot, WJ (2000) Parasitic Cape honeybees get royal treatment. *Nature* 404: 723; Dit proefschrift.

4. Het voortplantingssucces van de varroamijt in het broed van de westerse honingbij, *Apis mellifera*, is veel lager dan in het darrenbroed van de oosterse honingbij, *Apis cerana*. Wanneer de varroamijt zich ook bij de westerse honingbij specialiseert op broed van één type, kan verwacht worden dat het voortplantingssucces van de varroamijt hoger wordt.

5. De thelytoke voortplanting van werksters van de Kaapse honingbij is niet de oorzaak van hun parasitisme in volken van de Afrikaanse honingbij, het draagt echter wel bij aan de teloorgang van deze volken.

Beekman, M, Calis, JNM, Boot, WJ (2000) Parasitic Cape honeybees get royal treatment. *Nature* 404: 723.

6. Bij het vaststellen of inbouwen van verdedigingsmechanismen tegen plaaginsecten bij gewassen wenselijk is, dient de toxiciteit voor de op het gewas fouragerende bijenvolken in ogenschouw genomen te worden.

7. De toegenomen participatie van vrouwen op de arbeidsmarkt heeft ervoor gezorgd dat de voortplantingsstrategie van de mens niet alleen vaak lijkt op die van de kip, maar ook steeds vaker op die van de cassuariër.

8. Het aanleggen van de Betuwelijn geeft uiting aan een Haagse vorm van rivierblindheid.

1103201, 2010

**Parasite-host interactions between
the *Varroa* mite and the honey bee**

A contribution to sustainable *Varroa* control

Johan N.M. Calis

Proefschrift
ter verkrijging van de graad van doctor
op gezag van de rector magnificus
van Wageningen Universiteit,
Prof. Dr. Ir. L. Speelman,
in het openbaar te verdedigen
op dinsdag 26 juni 2001
des ochtends te elf uur in de Aula

1613 581



Calis, Johannes Nicolaas Maria (2001)

Parasite-host interactions between the *Varroa* mite and the honey bee
A contribution to sustainable *Varroa* control

Thesis Wageningen Universiteit. –With ref. –With summary in Dutch

ISBN no. 99-5808-446-9

Ter nagedachtenis aan Joop Beetsma

Table of contents

	page
General introduction, objectives and summary	9
Chapter 1: Invasion behaviour of <i>Varroa jacobsoni</i> Oud.: from bees into brood cells. J. Beetsma, W.J. Boot & J.N.M. Calis, 1999. <i>Apidologie</i> 30: 125-140.	17
Chapter 2: Control of <i>Varroa</i> by combining trapping in honey bee worker brood with formic acid treatment of the capped brood outside the colony: putting knowledge on brood cell invasion into practice. J.N.M. Calis, W.J. Boot, J. Beetsma, J.H.P.M. van den Eijnde, A. de Ruijter & J.J.M. van der Steen, 1998. <i>Journal of Apicultural Research</i> 37: 205-215.	33
Chapter 3: Effective biotechnical control of <i>Varroa</i> : applying knowledge on brood cell invasion to trap honey bee parasites in drone brood. J.N.M. Calis, W.J. Boot, J. Beetsma, J.H.P.M. van den Eijnde, A. de Ruijter & J.J.M. van der Steen, 1999. <i>Journal of Apicultural Research</i> 38: 49-61.	47
Chapter 4: Model evaluation of methods for <i>Varroa jacobsoni</i> mite control based on trapping mites in honey bee brood. J.N.M. Calis, W.J. Boot & J. Beetsma, 1999. <i>Apidologie</i> 30: 197-207.	63
Chapter 5: Population modelling of <i>Varroa jacobsoni</i> Oud. J.N.M. Calis, I. Fries & S.C. Ryrie, 1999. <i>Apidologie</i> 30: 111-124.	75
Chapter 6: Natural selection of <i>Varroa jacobsoni</i> explains the different reproductive strategies in colonies of <i>Apis cerana</i> and <i>Apis mellifera</i> . W.J. Boot, J.N.M. Calis, J. Beetsma, D.M. Hai, N.K. Lan, T.V. Toan, L.Q. Trung & N.H. Minh, 1999. <i>Experimental and Applied Acarology</i> 23: 133-144.	97
Chapter 7: Reproductive success of <i>Varroa</i> mites in honey bee brood with differential development times. J.N.M. Calis, W.J. Boot & J. Beetsma. submitted.	109
Chapter 8: Attractiveness of brood cells to <i>Varroa</i> mites in different honey bee races (<i>Apis mellifera</i>). J.N.M. Calis, W.J. Boot & J. Beetsma. submitted.	123
Inleiding, onderzoeksdoelen en samenvatting	129
List of publications	137
Nawoord	141
Curriculum Vitae	143

General introduction, objectives and summary

Introduction

Varroa mites as parasites of honey bees

Varroa destructor (Anderson & Trueman, 2000), is the most important pest of European races of the Western honey bee, *Apis mellifera* L., weakening bees and vectoring bee diseases (Matheson, 1993). Over the past decades it has spread all over the world and control measures are required to maintain healthy honey bee colonies.

Originally, this mite only occurred in colonies of the Eastern honey bee, *Apis cerana* Fabr., in Asia. *Varroa destructor* was formerly known as *V. jacobsoni* Oud. (Anderson & Trueman, 2000). The *Varroa* mite was described in 1904 by Oudemans as a parasite of Eastern honey bees in Indonesia. Although the actual damage inflicted by the mite to the Eastern honey bee has never been determined, the *Varroa* mite is not considered to be a problem in colonies of its original host. However, *Varroa* turned into a serious pest of Western honey bees when beekeepers moved the Western honey bee into the area of distribution of the Eastern honey bee. The mite appeared to be a harmful parasite on its new host, but before this was realised it had already spread over the world through shipments of colonies and queens (De Jong et al., 1982; Matheson, 1993).

Varroa mites may ruin Western honey bee colonies because parasitised bees suffer from malformations and a shortened life span (Beetsma et al., 1989). The *Varroa* mite feeds on both adult bees and brood, but reproduction is restricted to brood cells, which mites invade during the final larval developmental stage of the honey bee. Offspring is produced during the period that the immature bee develops in the capped brood cell and the mother and her progeny emerge together with the young bee. In addition to direct damage to bees through feeding, mites act as vectors of honey bee pathogens and increase the incidence of honey bee diseases (Ball, 1994). This threat of *Varroa* mites to beekeeping resulted in the development of acaricides and nowadays several effective acaricides are available which are applied world-wide (Koeniger & Fuchs, 1988; Ritter, 1990). However, the use of acaricides has important disadvantages. Acaricides contaminate bee products like honey and wax (De Greef, 1994) and thus the use of these acaricides is in conflict with the status of honey and wax as natural products. Another disadvantage is that mites have become resistant to these acaricides and this resistance is spreading world-wide, which implies the need for alternative ways of control.

Towards sustainable Varroa control

In this thesis, I present studies on biotechnical methods of *Varroa* control and studies on how variation in the honey bee's susceptibility to *Varroa* affects the mite population growth. In theory, biotechnical control methods in which mites are trapped in brood cells and removed from the colony, so-called trap-comb methods, are simple. In practice, however, these methods may become complicated because timing of application needs to be integrated in other activities of the beekeeper, such as swarm prevention. In addition, application of these methods is usually labour intensive. Effective trap-comb methods are available, but reduction of labour intensity is still needed. Much research is therefore directed to breed honey bees that are less susceptible to *Varroa* mites (Woyke, 1989; Büchler, 1994; Moritz, 1994). In this field, I investigated whether

reduced developmental time of bee brood and attractiveness of bee brood to mites are suitable traits for selection aiming at reduced susceptibility of honey bees to *Varroa* mites. If less susceptible honey bees are available, the high effectiveness of control methods needed for successful control may be relaxed. This in turn may allow simplification of biotechnical control methods. The aim of my thesis is to develop acaricide-free beekeeping by using alternative methods for effective control of *Varroa*.

Objectives and research questions

Applying knowledge on invasion behaviour in the development of biotechnical control methods and population modelling

The parasite-host interactions between the mite and the honey bee have been intensively studied, because such knowledge may lead to new ways of control. In earlier work, I collaborated with Beetsma and Boot (1995) to study invasion behaviour of mites into brood cells. *Varroa* mites survive on adult bees, but reproduction is restricted to the capped brood cell (Ifantidis & Rosenkranz, 1988). The rate of brood cell invasion defines the distribution of mites over bees and brood and, therefore, the population dynamics of the mite. The rate of invasion appeared to depend mainly on the ratio of brood cells that are being capped per bee in the colony, as reviewed in Chapter 1. In this thesis I applied this knowledge to design control methods that are based on trapping mites in bee brood. I investigated if it is possible to predict the effectiveness of trap-comb methods using a model based on the calculated invasion rate of the mites in brood cells from the ratio of capped brood cells per bee (Chapters 2&3). Using this model, concepts of trap-comb-methods were evaluated (Chapter 4). I also applied knowledge on invasion behaviour to gain more insight in the mite's population dynamics in general (Chapter 5).

Towards less susceptible honey bees

Differential reproduction of mites in both host-species, *A. cerana* and *A. mellifera*, seems to be a key factor in susceptibility of honey bees to *Varroa* (Büchler, 1994; Rosenkranz & Engels, 1994). In European *A. mellifera* colonies mites reproduce in both worker and drone brood and mite numbers increase rapidly. In colonies of its original host, *A. cerana*, mites invade both types of brood cells but refrain from reproducing in worker cells (Boot et al., 1997). Thus, in *A. cerana* mite numbers can only increase when drones are being reared. In African and africanised *A. mellifera* races a high percentage of mites that invade worker brood also refrain from reproducing (Camazine, 1986; Ritter, 1993). Therefore, like *A. cerana*, African and africanised honey bees are less susceptible to *Varroa*. I studied whether refraining from reproduction in worker brood is due to a trait of the honey bee or due to a trait of the mite (Chapter 6). By transferring *Varroa* mites originating from *A. mellifera* colonies to *A. cerana* worker brood and vice versa there appeared to be two distinct mite populations with a different reproductive strategy. Mites originating from *A. mellifera* reproduced in worker brood in both species of honey bee, whereas mites originating from *A. cerana* reproduced in drone brood only. Later, genetic studies of *Varroa* mites (Anderson & Trueman, 2000) made clear that the two populations in fact belong to different species. The mites that parasitise Western honey bees originate from Korea and Japan and were erroneously called *V. jacobsoni* and have been recently named *V. destructor* (Anderson & Trueman, 2000).

Selection for honey bee traits that reduce reproductive success in worker brood is reminiscent of the situation we in the original host-parasite relationship where mites reproduce exclusively in drone brood. I studied honey bee traits that may play a role in

the reproductive success of *Varroa* mites in worker brood: the duration of the capped brood stage and attractiveness of the brood cells. A short duration of the capped brood stage will limit the development of nymphs (Chapter 7). Reduced attractiveness will decrease the rate of invasion and hence the rate of reproduction (Chapter 8).

Summary

Structure of the thesis

The chapters in this thesis are articles in which a separate part of the work is introduced and results are presented and discussed. The first six chapters have been published in periodicals and the final two chapters are submitted for publication.

Invasion behaviour of Varroa mites: from bees into brood cells (Chapter 1)

Varroa mites may invade worker or drone brood cells when worker bees bring them into close contact with these cells. The attractive period of drone brood cells is two to three times longer than that of worker brood cells. The attractiveness of brood cells is related to the distance between the larva and the cell rim and the age of the larva. The moment of invasion of the mite into a brood cell is not related to the duration of its stay on adult bees. The fraction of the phoretic mites that invade brood cells is determined by the ratio of the number of suitable brood cells and the size of the colony. The distribution of mites over drone and worker brood in a colony is determined by the specific rates of invasion and the number of both brood types. Knowledge of mite invasion behaviour has led to effective biotechnical control methods and increased insight in the mite's population dynamics.

Control of Varroa mites by combining trapping mites in honey bee worker brood with formic acid treatment of the capped brood outside the colony: Putting knowledge on brood cell invasion into practice (Chapter 2)

Biotechnical *Varroa* control methods are based on the principle that mites inside brood cells are trapped and then removed from the bee colony. Initially, methods were studied in which worker brood was used for trapping. Trapped mites were killed with a formic acid treatment that left the worker brood unharmed. The observed percentage of mites trapped and killed by formic acid treatment was 87% and 89% in two experiments which matched predictions based on knowledge on brood cell invasion. Hence, knowledge on the mites' behaviour with respect to brood cell invasion proved to be a useful tool for designing and improving trap-comb methods for *Varroa* control.

Effective biotechnical control of Varroa mites: Applying knowledge on brood cell invasion to trap mites in drone brood (Chapter 3)

Trapping mites in brood cells is most efficient when drone brood is used while the colonies are otherwise broodless. In theory, one trap-comb using drone brood is enough to achieve effective control. I designed and tested two methods using trap-combs with drone brood. To reduce labour intensity, application of trap-combs was integrated in swarm prevention techniques. In the first method, effectiveness of the control method varied considerably, from 67% to 96%. Effectiveness depended on the number of drone cells that had been available for mite trapping. The observed effectiveness in each separate colony could be predicted from the numbers of bees and brood cells, thereby showing the validity

of our approach. In the second method, we adjusted the method to improve production of drone brood on the trap-combs, because this appeared to be crucial for trapping efficiency. The observed effectiveness of 93.4 % demonstrates that trap-combs with drone brood can effectively trap mites, thereby offering a non-chemical method of *Varroa* control.

Model evaluation of methods for Varroa mite control based on trapping in honey bee brood (Chapter 4)

The trap-comb model that was used to predict mite-trapping effectiveness in our experiments was used to estimate and compare effectiveness of different trap-comb methods described by several authors. Predictions of the model showed that for effective control by trapping with worker brood is labour intensive because a large amount of brood is needed to trap a sufficient number of mites. An extra input of labour is the demand for treatment of the capped worker brood to selectively kill the mites, because beekeepers want to save the brood. The model predicted that trapping with drone brood demands much less brood cells for effective mite control. Labour intensity is less compared to trap-combs with worker brood. This is because drone brood with trapped mites is usually destroyed instead of saved and preparation of trap-combs with drone brood can be integrated into swarm-prevention-techniques.

Population modelling of Varroa mites (Chapter 5)

To understand population dynamics of the mite, Fries et al. (1994) incorporated knowledge on *Varroa* mite-honey bee interactions into a mite population model. I updated and extended this model by incorporating more recent data, in particular on mite invasion from bees into brood cells. This allowed predictions of invasion into and emergence from brood cells, and hence the distribution of mites over bees and brood. As mite control treatments usually only affect mites either in brood cells or on adult bees, the model can be used to evaluate their effectiveness and timing. Mite population growth proved to be especially sensitive to the length of the brood period, the number of drone cells and reproductive success in the brood cells.

Natural selection of Varroa explains the different reproductive strategies in colonies of Apis cerana and Apis mellifera (Chapter 6)

In colonies of European *A. mellifera*, *Varroa* reproduces both in drone and in worker brood. In colonies of its original Asian host, *A. cerana*, the mites invade both drone and worker brood cells, but reproduce only in drone cells. Absence of reproduction in worker cells is probably crucial for the tolerance of *A. cerana* towards *Varroa* because it means that the mite population can only grow during periods of drone rearing. To test whether the absence of mite reproduction in worker brood of *A. cerana* is due to a trait of the mites or of the honey bee species, mites from bees in *A. mellifera* colonies were introduced into *A. cerana* worker brood cells and vice versa. Approximately 80% of the mites originating from *A. mellifera* reproduced in worker cells of both *A. mellifera* and *A. cerana*. Conversely, only 10% of the mites originating from *A. cerana* colonies reproduced in worker cells of *A. cerana* and *A. mellifera*. Hence, absence of reproduction in worker cells is due to a trait of the mites. Additional experiments showed that *A. cerana* removed 84% of the worker brood that was artificially infested with mites from *A. mellifera* colonies. Brood removal started 2 days after artificial infestation, which suggests that the bees responded to behaviour of the mites. Because removal behaviour of the bees will have a large impact on the mite's

fitness, it probably plays an important role in selection for differential reproductive strategies. These findings have large implications for selection programmes to breed less-susceptible bee strains. If differences in mites (i.e. whether they reproduce in worker brood or not) are mite-specific, we should not only look for mites not reproducing as such, but for colonies in which mites are selected for not reproducing in worker cells. Hence, in selection programmes reproductive success of mites that reproduce in both drone and worker cells should be compared to the reproductive success of mites that reproduce exclusively in drone cells.

Reproductive success of Varroa mites in honey bee brood with differential development times (Chapter 7)

Reproduction of *Varroa mites* has been extensively studied and many aspects of its life history such as number of eggs laid, timing of egg laying, and mortality of immature mites, are well known. However, estimates of the actual reproductive success after one brood cycle, i.e. how many mites can be found alive on the bees after emergence of an infested cell, are still fairly theoretical. Because this parameter is crucial for understanding population growth of the mites, several methods were used to measure the actual reproductive success. To evaluate how development time of the capped brood stage may affect population growth of the mites, measurements were done in bee strains with different development times of worker brood. In brood with a relatively short developmental time, reproductive success of mites was lower. Increased developmental time resulted in higher egg production and lower mortality of offspring before or shortly after emergence of the mites from the brood cell. The results show that the number of mites emerging alive from worker cells with relatively short development times, may become lower than the initial number that invaded the cells. This results in a decline of the mite population if only worker cells are available. In addition, the low reproductive success in worker brood with a short development time, explains that the phenomenon of mites not reproducing in worker cells, as found in *A. cerana* and in several *A. mellifera* races, evolves if these mites survive to reproduce in drone brood the next brood cycle.

Attractiveness of brood cells of different honey bee races to Varroa mites (Chapter 8)

Reproduction of the *Varroa* mite only occurs inside capped brood cells of honey bees. Therefore, invasion into brood cells is crucial for the mite's reproduction and the rate of invasion will affect the growth of the mite population. I investigated the invasion response of the mites to drone or worker larvae of different honey bee races, because selection for less attractive brood may help *Varroa* control. The observed differences in invasion response of *Varroa* mites to worker brood of the tested colonies were not statistically significant. The results suggest that not the racial origin of the worker brood, but the distance between the larva and the cell rim affects the invasion response of the *Varroa* mites to worker brood cells. Because measuring the distance between the larva and the cell rim in drone brood cells is inaccurate due to curved cell caps of neighbouring cells, the results for drone brood cells are difficult to interpret. Possibilities to obtain less attractive brood via selection or comb manipulation are discussed.

Epilogue

Towards a future in which beekeeping does not depend on the use of acaricides for effective control of Varroa

Considering the conflict between the use of synthetic acaricides and the status of honey bee products as natural products and the spreading resistance of *Varroa* to these acaricides, there is a clear need for alternative ways of *Varroa* control. Our research on biotechnical control methods and susceptibility of honey bees to *Varroa* contributes to sustainable *Varroa* control. Knowledge on invasion behaviour of mites into brood cells proved to be useful to understand the possibilities and limitations for improvement of biotechnical control methods. Using drone brood on trap-combs, an effective biotechnical control method has become available providing a non-chemical way of controlling the mite population. Integration of knowledge on invasion behaviour into a population model of the *Varroa* mite allows us to gain more insight in the mite's population dynamics and evaluate traits of honey bees that via selection may decrease susceptibility of honey bee colonies. Selection for honey bee traits that reduce reproductive success in worker brood in *A. mellifera* may lead to selection of mites towards the situation we know from the original host-parasite relationship where mites only reproduce in drone brood. The duration of the capped brood stage seems a good candidate because selection for a short development time will reduce reproductive success of the mites. Attractiveness of brood cells is a less suitable trait because differences in attractiveness of brood of different race were not detected. Although less susceptible honey bees are not available yet, selectable traits have been identified that may reduce the effect of *Varroa* infestation on honey bee colonies. Nowadays, beekeeping is not dependent on the use of synthetic acaricides to control the *Varroa* mite. Next to trap-comb methods, much research has been successfully directed towards *Varroa* control using organic acids and essential oils (Imdorf, 1999). Reducing susceptibility of honey bees together with effective control by means of biotechnical and other 'organic' control methods provides a perspective for beekeeping that does not rely on synthetic acaricides to kill *Varroa* mites.

Acknowledgements I thank M. Beekman, WJ Boot, JC van Lenteren and M.W. Sabelis for their valuable comments on the manuscript.

References

- Anderson, DL & Trueman, JWH (2000) *Varroa jacobsoni* (Acari: Varroidea) is more than one species. *Experimental and Applied Acarology* 24: 165-189.
- Ball, BV (1994) Host-Parasite-Pathogen interactions. In Matheson, A (editor) *New perspectives on Varroa*. IBRA, Cardiff, UK, pp 5-11.
- Beetsma, J, de Vries, R, Emami Yeganeh, B, Emami Tabrizi, M & Bandpay, V (1989) Effects of *Varroa jacobsoni* Oud. on colony development, workerbee weight and longevity and brood mortality. In Cavalloro, R (editor) *Present status of Varroa infestation in Europe and progress in the Varroa mite control: proceedings of a meeting of the EC expert's group*, Udine, Italy, 28-30 November 1988, Commission of the European Communities, Luxembourg, pp 163-170.
- Boot, WJ (1995) Invasion of *Varroa* mites into honey bee brood cells. Thesis Wageningen University.
- Boot, WJ, Tan, NQ, Dien, PC, Huan, LV, Dung, NV, Long, LT, & Beetsma, J (1997). Reproductive success of *Varroa jacobsoni* in brood of its original host, *Apis cerana*, in comparison to

- that of its new host, *A. mellifera* (Hymenoptera: Apidae). *Bulletin of Entomological Research* 87: 119-126.
- Büchler, R (1994) *Varroa* tolerance in honey bees -occurrence, characters and breeding. *Bee World* 75: 54-70.
- Camazine, S (1986) Differential reproduction of the mite, *Varroa jacobsoni* (Mesostigmata: Varroidae), on Africanized and European honey bees (Hymenoptera: Apidae). *Annals of the Entomological Society of America* 79: 801-803.
- De Greef, M, Wael, L de & Laere, O van (1994) The determination of the fluvalinate residues in the Belgian honey and beeswax. *Apiacta* 29: 83-87.
- De Jong, D, Morse, RA & Eickwort, GC (1982) Mite pests of honey bees, *Annual Review of Entomology* 27: 229-252.
- Fries, I, Camazine, S & Sneyd, J (1994) Population dynamics of *Varroa jacobsoni*: a model and a review. *Bee World* 75: 5-28.
- Ifantidis, MD & Rosenkranz, P (1988) Reproduktion der Bienemilbe *Varroa jacobsoni* (Acarina: Varroidae). *Entomologia Generalis* 14:111-112.
- Imdorf, A, Charrière, JD & Fluri, P (1999) Alternative strategies for the control of acaricide resistant *Varroa* mites. *Proceedings of the 36th Apimondia congress*, Vancouver, Canada. pp 143.
- Koeniger, N & Fuchs, S (1988) Control of *Varroa jacobsoni*: current status and developments. In Needham, G R, et al. (editors) *Africanized honeybees and bee mites*. Ellis Horwood Limited, Chichester, pp 360-369.
- Matheson, A (1993) World bee health report. *Bee World* 74: 176-212.
- Moritz, R (1994) Selection for Varroa resistance in honeybees. *Parasitology Today* 10: 236-238.
- Oudemans, AC (1904) On a new genus and species of parasitic acari. *Notes from the Leyden Museum* 24: 216-222.
- Ritter, W (1990) Drug therapy development of *Varroa jacobsoni* in the federal republic of Germany. *Apiacta* 25: 102-106.
- Ritter, W (1993) New results of the development of tolerance to *Varroa jacobsoni* in bee colonies in Tunisia. In Connor, LJ et al. (editors), *Asian Apiculture*. Wicwas Press, Cheshire, CT, USA, pp. 457-459.
- Rosenkranz, P & Engels, W (1994) Infertility of *Varroa jacobsoni* females after invasion into *Apis mellifera* worker brood as a tolerance factor against varroaosis. *Apidologie* 25:402-411.
- Woyke, J (1989) Breeding of honey bees resistant to *Varroa jacobsoni*. *American Bee Journal* 129: 21-23.

Invasion behaviour of *Varroa jacobsoni* Oud.: from bees into brood cells

Abstract

Varroa jacobsoni mites may invade worker or drone brood cells when worker bees bring them in close contact with these cells. The attractive period of drone brood cells is two to three times longer than that of worker brood cells. The attractiveness of brood cells is related to the distance between the larva and the cell rim and the age of the larva. The moment of invasion of the mite into a brood cell is not related to the duration of its stay on adult bees. The fraction of the phonetic mites that invade brood cells is determined by the ratio of the number of suitable brood cells and the size of the colony. The distribution of mites over worker and drone brood in a colony is determined by the specific rates of invasion and the numbers of both brood cell types. Knowledge of mite invasion behaviour has led to effective biotechnical control methods.

Introduction

The parasitic mite *Varroa jacobsoni* Oudemans (Acari: Varroidae) is a harmful pest of the European honeybee races. Up to now most beekeepers apply acaricides to control this mite in their colonies. However, the use of acaricides has two major disadvantages: (1) contamination of honeybee products (Wallner, 1999) and (2) the occurrence of mite resistance (Elzen et al., 1998; Jacobs et al., 1997; Troullier & Faucon, 1997). Therefore, biotechnical control methods should be preferred. Adult female *V. jacobsoni* feed on the haemolymph of both adult bees and brood. While staying on adult bees, they can survive up to several months; for example, during the broodless period in colonies in a temperate climate. This ability allows the mites to wait for an opportunity to invade a brood cell. Invasion into a worker or drone brood cell before cell capping is essential for the mite reproduction (Ifantidis & Rosenkranz, 1988; Ritter, 1981). Studying the process of invasion into brood cells is important for two reasons. First, invasion is directly related to reproduction and therefore defines population growth. Second, the results of these studies have led to the improvement of biotechnical control methods in which trapping combs are used. In this paper, current knowledge on the process of invasion behaviour is reviewed.

Invasion behaviour of individual mites

Boot et al. (1994) studied invasion behaviour of individual mites in small, heavily infested colonies. Experiments were carried out in a specially designed observation hive using a 'half-comb' frame (Beetsma et al., 1993). Generally, two frames, both containing a 'half-comb', one on top of the other, were used to maintain a brood nest large enough for observations. The 'half-comb' consisted of one layer of cells of which the cell bottoms had been replaced by a transparent sheet. Two movable video cameras were used to monitor the opening and the bottom of a group of cells simultaneously. The side of the cell openings was illuminated with infra-red light which penetrated the whole cell including the larva. When mites invaded brood cells, they crawled between the cell wall and the larva until they reached the bottom of the cell, where they were trapped in the larval food (Boot et al., 1992; De Jong et al., 1982; Ifantidis, 1988). The observations suggested that the movement of a mite from the cell opening to the bottom took about 1 minute. When studying the recordings of the position of the bees at the cell opening

during 3 minutes before the mite reached the cell bottom, Boot et al. (1994) concluded that it was not necessary for the bee to place its head and thorax into the brood cell for mite invasion. Apparently, mites left bees when brought in close proximity to a brood cell. Because mites were never observed to walk across the comb surface, Boot et al. (1994) suggested that mites went directly from the ventral side of the bee into the brood cell.

When using the 'half-comb' frames, the bees blocked the view on the cell opening. Therefore a frame of cells with transparent side walls was constructed. Mites could be observed through opposite transparent perspex cell walls of vertical rows of cells (Beetsma et al., 1993) into which larvae had been grafted. When the larvae were large enough to attract mites, two video cameras were placed at opposite sides of a few cells to record invasion of mites. After many attempts, the complete movement and several times parts of the movement from the bee to the brood cell bottom could be recorded. The mite walked over the side of the abdomen of the bee, left the bee and moved onto a cell capping and entered the adjacent cell, walked on the surface of the larva and crawled between the larva and the cell wall to the bottom of the cell. Boot et al. (1994) concluded that mites only invade brood cells when the distance between the mite on the bee and the cell opening is small. Ten minutes after the recorded invasion, eight other mites were seen on bees passing the recently invaded cell, but they did not invade this cell. Since infested brood cells seem to be just as attractive to mites as non-infested ones (Fuchs, 1985), the distance between these mites and the cell may have been too long for invasion. In addition, mites positioned between the abdominal sternites (Kraus et al., 1986; Rath, 1993) may not respond to stimuli from the brood cell. The mites were never seen walking on the comb, or entering and leaving the brood cells to select a cell for invasion. In cells with attractive larvae, the mites have to cover a distance of 4-7 mm from cell opening to the larva (Boot et al., 1995b; Goetz & Koeniger, 1993) therefore, the signal to decide whether to stay on the bee or to enter the brood cell is perceived at a distance of at least 4 mm from the larva and not after direct contact with the larva.

Attractiveness of brood cells

Preference of mites to drone larvae was found first in tests outside the colony (Le Conte et al., 1989; Otten & Fuchs, 1988; Rosenkranz et al., 1984), but whether mites could discriminate between drone and worker brood cells in a natural environment had not yet been shown. Therefore, Boot et al. (1992) compared the invasion of mites into worker brood cells with that into drone brood cells in small highly infested colonies kept in an observation hive, using half-combs (Beetsma et al., 1993). For each cell, records were made of the time that a mite appeared at the transparent cell bottom and the time at which the cell had been capped. Invasion into worker and drone brood cells was studied in separate experiments. Invasion into worker brood cells could be recorded from 15-20 h before cell capping, and in drone brood cell from 40-50 hrs before cell capping. Because the ratio between the number of phoretic mites and available brood cells changed gradually within each experiment, the rate of invasion of mites into brood cells must have been affected (Boot et al., 1994b). Therefore, this experiment gave information only about the duration of the attractive period of each cell, and not on the rate of invasion within the attractive period. When comparing brood cells containing at least five mites, Boot et al. (1992) concluded that brood cells can be invaded during the whole invasion period. The number of mites invading worker brood cells per hour remained more or less constant until cell capping, but decreased before capping of drone brood cells. Boot et al. (1992) attributed the decreasing rate of invasion into drone brood cells to a limited number of mites in relation to the number of drone brood cells in

the small experimental colony. The attractive period of drone brood cells was two to three times longer than that of worker brood cells. (Figure 1). This was in agreement with the results of a similar study by Wieting and Ferenz (1991) and earlier results based on indirect criterions (Fuchs & Müller, 1988; Ifantidis, 1988).

Comparison of the rates of invasion of worker and drone brood cells simultaneously in one colony is not practical because of the differential time of capping of both cell types and because of the longer period of attractiveness of drone brood cells. If worker and drone larvae are of the same age at the start of the experiment, after all worker brood cells have been capped, invasion into drone brood cells continues while the density of mites on the bees has decreased.

A different distribution of mites has been found in different types of cells containing the same type of larva. De Jong and Morse (1988) found more mites in worker cells protruding above the comb surface than in neighbouring worker cells. De Ruijter and Calis (1988) found more mites in worker brood cells with artificially raised bottoms. Calis et al. (1993) and Ramon et al. (1993) found more mites in smaller cells, when brood attractivity to mites was tested in cells differing in diameter. Calis et al. (1993) and Goetz and Koeniger [37] found also more mites in shortened worker brood cells.

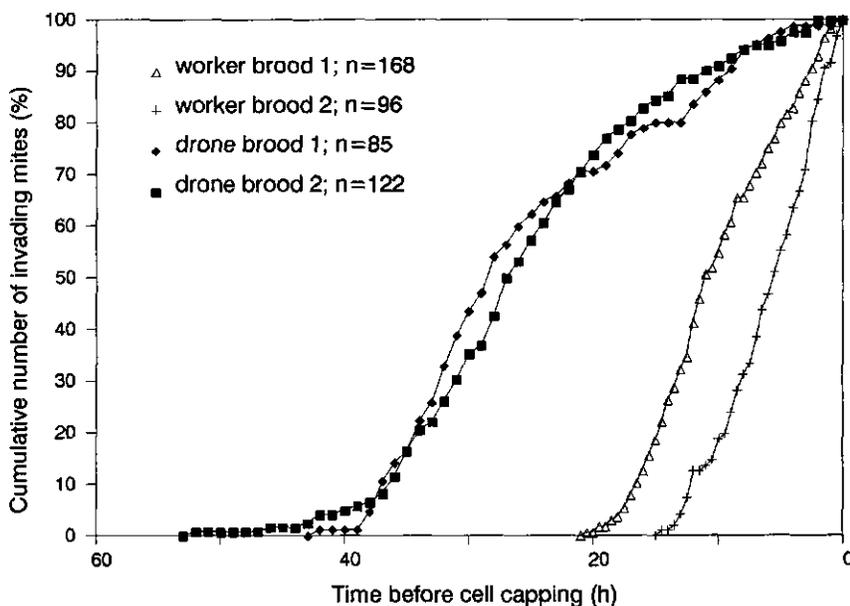

Figure 1. Cumulative relative number of mites invading worker and drone brood cells preceding cell capping. Invasion into worker and drone brood cells was studied in separate small colonies in an observation hive. n = the number of mites invaded (Boot et al., 1992).

Boot et al. (1995b) measured the period that brood cells are attractive to mites, the distribution of mites over different cell types, and the distance between larva and cell rim of different cell types, in relation to the time preceding cell capping. The attractive period of brood cells was again measured in half-combs (Beetsma et al, 1993; Boot et al., 1992. Two half-combs, clamped together with adjacent transparent sheets, were introduced into a heavily infested colony. The times of mite invasion and cell capping were recorded on transparent sheets. Invasion was recorded in normal worker and drone brood cells, shortened worker and drone brood cells, elongated worker brood cells, drone cells provided with a worker larva, and worker cells provided with a drone larva. The distance between larva and cell rim was measured with a probe, as used by Goetz and Koeniger (1993). To compare the attractiveness for mites between untreated, shortened or elongated cells or worker cells with a drone larva and vice versa, Boot et al (1995b) used cells with the same width containing larvae of the same age in one test colony. Therefore, the relationship between the estimated distances between the cell rim and the nearest surface of the coiled larva producing an attractant gave the same result as estimating the volumes of the unoccupied part in the cells.

Shortening of both worker and drone brood cells always resulted in a longer attractive period than control brood cells. Elongated worker brood cells were attractive to the mites for a shorter period than control worker brood cells. Drone cells containing a worker larva seemed to be attractive to mites during a shorter period than control worker brood cells, and drone larvae in worker cells seemed to be attractive during a longer period than control drone brood cells.

The cell type strongly affected the number of mites that invaded. In shortened worker brood cells, 2 to 3 times as many mites were found per cell compared to the control cells. In elongated worker brood cells and in drone cells containing a worker larva 1/6 and 1/2 of the number of mites in control cells were found, respectively. In shortened drone brood cells, one and a half to two times as many mites were found as in control drone brood cells. No significant difference was found in the number of mites per cell between worker cells containing a drone larva and control drone brood cells.

The distance between the larva and the cell rim decreased linearly in cells containing a worker larva during the 30 hrs preceding cell capping. Control worker brood cells were capped when this distance was about 5.5 mm. In elongated worker brood cells the same relationship between time before capping and distance from larva to cell rim was found, but this distance was about 3 mm more than that of control cells at the same time before cell capping, corresponding to the distance by which the cells had been elongated. In drone cells with a worker larva, the distance from larva to cell rim was also much longer (about 2-3 mm) than in control worker brood cells. In artificial conical worker brood cells (ANP-comb) with a wider cell bottom (Wieting & Ferenz, 1991) this distance was 0.5 to 1 mm more than in control worker cells. In drone brood cells, the distance between the larva and the cell rim remained the same, on average 7 mm, during the 35 hrs preceding cell capping. Before that period, a decrease of this distance was found.

In general, the distance between larva and cell rim decreased with time. Hence, the critical distance at which mites begin to invade brood cells may be estimated by taking the distance found at the beginning of the attractive period. Similar values were found for the following critical distances: between 6.9 and 7.9 mm for control worker brood cells, between 7.2 and 7.8 mm for control drone brood cells and 6.9 mm for artificial (ANP) worker cells. However, the critical distances for invasion into elongated worker brood cells and for invasion into drone brood cells containing a worker larva were estimated to be longer (from 8.2 to 9.0 mm).

The mites probably use a signal coming from the larva, such as heat production or the production of volatile substances, and the distance between larva and cell rim may affect the strength of the signal as it reaches a mite on a bee. To perceive this signal, the distance between the mite staying on the bee and the larva may have to be within a critical distance. In elongated worker brood cells and drone cells containing a worker larva, the critical distance at which invasion starts was estimated to be greater than in control worker brood cells. Since the attractive period was shorter in these cases, the larva was older when invasion of mites began. Possibly, the critical distance for invasion is greater when the larva is older, because the strength of a signal coming from the larva may increase with age (Calis et al., 1997, Chapter 8)

Le Conte et al. (1989) claimed that odours of a few aliphatic esters, especially methyl palmitate (MP), are the signals a mite uses to invade brood cells. Each of these esters, which had been extracted from the larval cuticle, attracted mites in an olfactometer. The experiment indicated that these esters can at least be perceived by the mites. Trouiller et al. (1991) extracted a maximum of 17 ng and 320 ng of MP from the cuticle of a worker and a drone larva respectively. In drone larvae the aliphatic esters were secreted during a longer period preceding cell capping than in worker larvae (Trouiller et al., 1992).

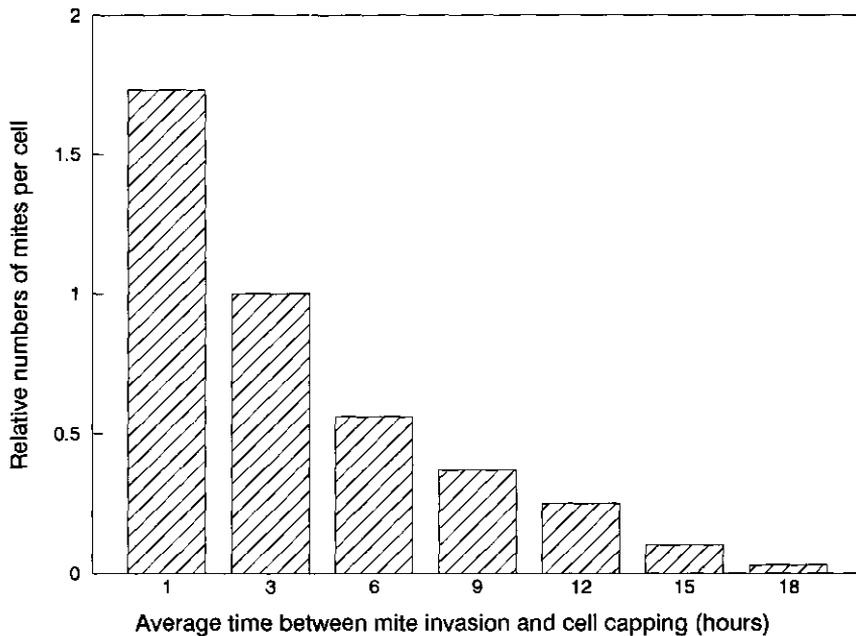

Figure 2. The relative attractiveness of *A. m. carnica* worker brood cells increases during 3-hr intervals before cell capping. Brood of different ages was exposed simultaneously to mite invasion in a heavily infested colony for 3 h (Calis et al., 1997).

Although these data correlate with the differential invasion of worker and drone brood cells, Boot et al. (1994a) did not find an increased attractivity of mites to worker brood cells after application of 2 μ l of acetone containing 172, 17.2 or 1.72 ng of MP per larva. Application of 17.2 and 1.72 ng of MP, or only acetone, did not affect the attractive period of the cells and the number of mites per cell. Only in one experiment in which 1.72 ng of MP was applied, the number of invaded mites was higher than in control cells, however the length of the attractive period was similar. All larvae died after application of 172 ng of MP. Treatment with 17.2 ng caused some mortality, and treatment with 1.72 ng or acetone alone did not cause mortality.

Calis et al. (1997, Chapter 8) measured the attractiveness of worker larvae of different honey bee races and of different ages. Brood combs with eggs 0-1 day of age (Boot & Calis, 1991) were produced in colonies of different honeybee races and introduced into strong colonies for nursing the brood. When the larvae were 6-7 days of age the combs were placed into a strong mite-free colony to prevent infestation of these cells. After the first cells had been capped, the combs were introduced into the middle of the brood nest of a heavily infested colony. In contrast to the previous experiment (Boot et al., 1992), brood of different ages was simultaneously exposed to mite invasion during 3 hrs in a highly infested colony. It was assumed that the density of the mites on the bees did not change within such a short period. After 3 hours, the combs were removed from the infested colony, the capped cells were marked on transparent sheets, and the combs were returned to the mite-free colony. Newly capped brood cells were marked in 3-h intervals. After six to seven intervals the combs were taken from the colony and the number of capped cells per interval and the number of invaded mites were recorded. After the data of three experiments were weighted to the number of brood cells and the number of mites it appeared that the relative numbers of mites per cell increased with the age of the larva (Figure 2).

Few differences were found between races (Calis et al., 1997, Chapter 8). On the other hand after Büchler (1989) introduced one frame with nine subunits containing dated (1-2 days) worker brood of different races or a Buckfast strain in a highly infested colony, he found differences in the rate of infestation between races. The average infestation per brood cell of pieces of brood of the same size was lowest in *A. m. mellifera* brood when compared to that of *A. m. carnica* or Buckfast brood.

Queen cells are usually not infested by mites. However, when rearing queens (1500) under different conditions, Harizanis (1991) found differential rates of infestation. In queen rearing colonies with open and sealed brood, an average of 2 % of the queen cells were infested. When only sealed brood or no brood was present the percentages of infested queen cells increased to 4% and 9%, respectively. In colonies without brood, only five mites were found with offspring in queen cells. The oldest offspring was a mobile protonymph. Because the capped stage of queen cells is relatively short (8 days) (Rehm & Ritter, 1989), this offspring never could become adult. The low attractiveness of queen cells for mites could be due to a weaker attractive signal. Trouiller et al. (1994) explain this weak attractivity of queen cells as follows: Queen larvae produce only half the amount of methyl palmitate, methyl linolenate and ethyl palmitate, which are attractants for *V. jacobsoni* (Le Conte et al., 1989), as worker larvae. In addition queen larvae produce much more methyl oleate, a substance repellent to mites, than worker larvae.

Does invasion and reproduction depend on the history of the mites?

The composition of the *V. jacobsoni* population on adult bees varies constantly. Phoretic mites differ in age and in the duration of their stay on adult bees. These mites

may be callow or have reproduced once or several times (De Ruijter, 1987). In addition these mites may have a different origin, due to transfer by drifting of drones or inexperienced forager bees (Greatti et al., 1992; Sakofski & Koeniger, 1988), or by robber bees (Sakofski, 1989). Some of the mites may have escaped from brood cells when the bees removed infested brood (Boecking, 1992; Boecking & Drescher, 1990; Boecking & Drescher, 1991). When invading a brood cell for the second time, oviposition of these mites probably had already been initiated before during the first 2 days (Beetsma & Zonneveld, 1992) or the first day (Steiner et al., 1994) of their interrupted stay in a capped brood cell which will affect the start and the rate of egg-laying of the mites (De Ruijter, 1985).

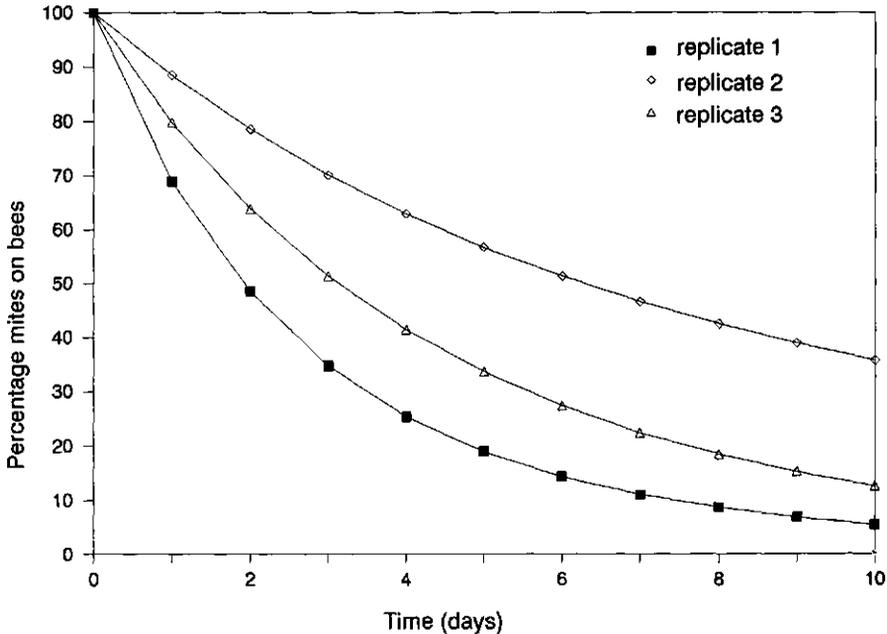

Figure 3. Calculated percentage of mites residing on adult bees. Mite-free broodless colonies were infested by introducing emerging infested brood for 1 day. Five hundred dated worker larvae were introduced daily. After capping the combs were removed to count the number of invaded mites (Boot et al., 1993).

Several authors have assumed that young mites have to mature and old mites have to prepare for reproduction in a brood cell while staying on adult bees (Beetsma & Zonneveld, 1992; Fuchs, 1985; Schulz, 1984). In that case, one would expect that the stay on adult bees would affect the moment of invasion into a brood cell, the start of oviposition, or the reproductive success of the mite. De Ruijter and Pappas (1983) collected young and old mites from brood cells 10 days after cell capping. Both categories of mites were introduced into recently sealed brood cells, either immediately, or after a stay of 1 week on adult bees. Ten days later, the offspring of both categories of mites had attained a more advanced stage of development when their mothers had been in contact with adult bees; oviposition of these mites began earlier than in mites without a previous contact with adult bees. On the other hand, it appeared that contacts with adult bees by the mites are not necessary for the initiation of oviposition (De Ruijter, 1987; De Ruijter & Pappas, 1983). In colonies of hybrids between *Apis mellifera intermissa* and introduced European races, Beetsma and Zonneveld (1992) collected swollen mites (in which the dorsal and ventral shields were clearly separated) and non-swollen mites from adult bees, and introduced them into recently capped worker brood cells. The average number of offspring of swollen mites was similar to that of naturally invaded mites, but the non-swollen mites produced significantly fewer offspring. Swollen mites might have escaped from capped brood cells which had been opened by bees and therefore demonstrate an increased rate of egg laying. De Ruijter (1985) demonstrated this effect when transferring mites 24 or 48 hrs after cell capping into another series of recently capped worker brood cells. In addition, mites transferred after a stay of 48 hrs in a capped brood cell did not produce male offspring. When Beetsma and Zonneveld (1992) collected non-swollen mites from brood cells, and introduced them into Eppendorf test tubes provided with a stretched larva (one in the process of spinning a cocoon) every 12 days, these mites did not reproduce during 35 days. However, when the swollen mites were introduced into recently sealed brood cells, the number of offspring produced was similar to that of naturally invading mites. Therefore, Beetsma and Zonneveld (1992) suggested that oviposition could be stimulated both by a preceding stay on adult bees or in a brood cell in which the mites did not reproduce.

Boot et al. (1993) placed a broodless and mite-free colony in an isolated place to prevent reinfestation by mites. They introduced heavily infested emerging brood during 1 day to provide the colony with a large number of young and older mites that started their phoretic phase at the same day. Boot et al. (1993) measured invasion of these mites into brood cells during a maximum of 20 days. A comb containing 500 worker larvae 3-4 days of age was introduced daily and removed after 3 days. Each day all capped cells were marked on transparent sheets to register the invasion time of mites. Finally all mites remaining on adult bees were killed and counted. With these data the number of phoretic mites and the number of mites that invaded brood cells could be calculated for each day. In three replicates with colonies of different sizes, it appeared that mites began to invade brood cells at the first day of their phoretic stage and continued to invade brood cells at a constant rate, although this rate and the number of bees differed between the replicates (Figure 3).

Previously assumed differences in invasion time between, for example, young and old mites could not be demonstrated. Boot et al. (1995a) also demonstrated that the time spent on adult bees did not affect the fraction of mites without offspring, the number of offspring, the number of viable daughters, and the fraction of mites with only male offspring. On the other hand Schmidt-Bailey and Fuchs (1997) found that the time spent on adult bees increased the trapping efficiency of drone brood cells. When groups of 50 drone brood cells were introduced, 1, 2, 3 and weeks after formation of separate infested broodless nuclei in Kirchhain mating boxes, their trapping efficiency increased.

Effect of the brood/bee ratio on invasion

Explanations for the differences in the rate of invasion between the replicates of the experiments of Boot et al. (1993) became clear from the results of a similar experiment in which the size of the colony or the number of brood cells suitable for invasion was changed. Boot et al. (1994b) demonstrated that the rate of invasion increased with the number of suitable brood cells and decreased with the number of bees. When the surface area of suitable brood cells increases, more bees will come close to a brood cell and the phoretic mites have more opportunities to leave the bee and enter a brood cell. Conversely, with a mite population of the same size, the density of mites on bees will decrease with increasing colony size and therefore their opportunities to come close to a brood cell will decrease. The rate of invasion also decreased when young brood, not yet attractive to mites, was introduced. The addition of brood probably forced the bees to spread over more combs and therefore fewer mites were present in the direct vicinity of the attractive brood cells (Boot et al., 1994b).

After the experiments on invasion into worker brood cells (Boot et al., 1993), Boot et al. (1995c) studied the invasion into drone brood cells in relation to the size of the colony using a similar design. In these experiments, a comb containing 50 drone larvae 3-4 days of age was introduced each day. In six replicates it appeared that the rate of invasion of mites into drone brood cells was correlated with the number of drone brood cells per kg of bees, but not with the duration of their stay on adult bees, similar to the situation in worker brood cells (1994b). However, drone brood cells were invaded 11.6 times more frequently than worker brood cells. Note, in these experiments the invasion into worker or drone brood cells was tested in separate colonies (cf. the experiments by Fuchs (1990)).

Part of this higher frequency of invasion may be due to the longer attractive period of drone cells (Boot et al., 1992; Ifantidis, 1988). When invasion into a brood cell depends on the frequency that a bee brings a mite close enough to a brood cell to invade, the number of mites that invade per cell is expected to be two to three times higher in drone brood cells, provided that the number of mites on the bees remains the same. In addition, when the frequency in which a bee brings a mite close enough to a brood cell for invasion is proportional to the surface of a brood cell, 1.7 times more mites are expected per drone brood cell, due to their 1.7 times larger surface. Combining these two factors would result in drone brood cells being invaded 3.4-5.1 times more frequently than worker brood cells. However, it was found that drone brood cells were invaded 11.6 times more frequently. Thus, the rate of invasion per cell is increased an additional two to four times by the presence of a drone larva instead of a worker larva. Martin (1998) added a third factor to explain the higher number of mites in drone brood cells when compared to worker brood cells. The weights of drone and worker larvae are 346 and 140 mg respectively, yielding a proportion of 2.47. Including this factor would lead to a range of 8.4-12.6 times more frequent invasions in drone brood cells than in worker brood cells. However, this factor is probably not related to a higher number of bee visits to drone brood cells as suggested by Martin (1998), because Boot et al. (1994a) demonstrated that mite invasion was not related to feeding or cell capping. It is more likely that the weight of the larva is related to the strength of the signal causing mite invasion (Le Conte et al., 1989).

Distribution of mites over worker and drone brood cells

Schulz (1984) and Fuchs (1990) found more mites in drone brood cells than in worker brood cells. De Jong (1984), Rosenkranz et al. (1984) and Otten and Fuchs

(1988) suggested that mites prefer drone brood to worker brood and Schulz (1984), Ifantidis (1984) and Fuchs and Langenbach (1989) suggested that this preference is due to the higher reproductive success of mites in drone brood cells. The larger number of mites generally found in drone brood cells is thought by these authors to be the result of selection of 'drone brood mites'. This preference, however, could not be found in individual mites. When Radtke (1997) collected adult mites from worker and drone brood cells, marked each group of mites distinctly, and introduced them into a colony, he found no indication of a selection of 'worker brood mites' or 'drone brood mites'. In fact, he recovered about the same numbers of mites in both categories of marked mites in worker and drone brood cells that had been capped in the same period.

The differential distribution of mites over different ratios of drone and worker brood cells within one colony can be calculated according to Boot et al. (1995c) using only the relative rates of invasion per drone and worker brood cell per day and the numbers of both brood cell types without making further assumptions. The relative rates of invasion per brood cell per day are 0.56 and 6.49 for worker and drone brood respectively. These values are the result of all possible factors that affect brood cell invasion.

Fuchs (1990) studied the invasion of worker and drone brood cells simultaneously in the same colony. He carried out this experiment in 68 colonies containing only one comb with worker brood and one comb with drone brood. The numbers of worker and drone brood cells varied between the colonies from mainly worker brood to mainly drone brood. After all brood cells had been capped, Fuchs (1990) counted the number of that invaded the two types of brood cells. The relationship between the percentage of the mites in drone brood cells and the percentage of drone brood cells in the experiments of Fuchs (1990) is presented in Figure 4. The average number of mites per drone brood cell was 8.3 times higher than that per worker brood cell. This distribution (drone brood cell preference, cf. Fuchs (1990) was not affected by the rate of infestation of the colony nor by the total number of available brood cells. However, the distribution was affected by the percentage of drone brood cells. The average percentage of mites per drone brood cell was 12.1 times higher than that per worker brood cell when the percentage of drone brood cells varied between 5 and 15 (situation found in untreated colonies).

On the basis of the data provided by Dr. Fuchs, nearly the same relationship between the percentage of mites in drone brood cells to the percentage of drone brood cells could be predicted using only the relative rates of invasion into worker and drone brood (Boot et al., 1995c), and the numbers of worker and drone brood cells provided by Dr. Fuchs (Figure 4). The observed distributions were congruent with the theory on invasion (Boot et al., 1995c) which assumed that invasions of worker and drone brood cells are independent events. Or, the decision of the mites to invade a brood cell is determined by the signal they receive from the brood cell in their direct vicinity.

Conclusion

Although many aspects of invasion behaviour have been revealed, it is still unclear which substances the mites are attracted to when invading a brood cell. These attractive substances could differ in quantity or even in quality between worker and drone larvae. In addition mites of populations of different origin (East Russia or Japan) could respond differently to these substances. Invasion behaviour of mites in *A. mellifera* and in *A. cerana* colonies can not yet be compared because little data are available on the behaviour of the Asian mite in colonies of its original host. The results so far obtained provide possibilities for further studies. The estimation of the relative rates of invasion

per day per worker and drone brood cell has made it possible to answer the question why it is advantageous for the mite to invade both worker and drone brood cells while reproductive success in drone brood cells is higher (Boot et al., 1995a).

The population growth of *V. jacobsoni* depends entirely on that of the honeybee colony. Since it is known that the rate of invasion of the mite depends on the size of the colony and the number of worker and drone brood cells suitable for mite invasion, simulation models of the mite population could be improved (Calis et al, 1999b (Chapter 5), Martin, 1998).

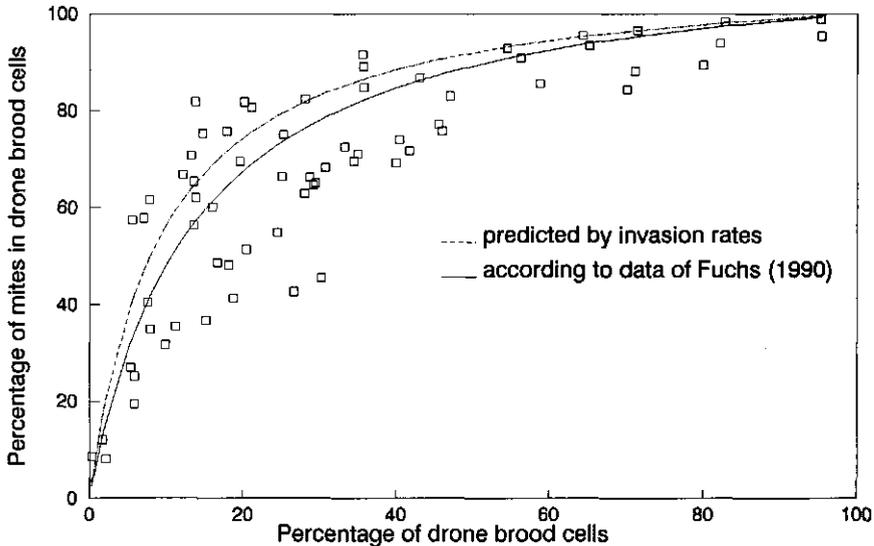

Figure 4. The relation between the percentages of *Varroa jacobsoni* in drone brood cells and the percentages of drone brood cells as observed and calculated by Fuchs (1990) and as predicted by using the relative rates of invasion per day per worker or drone brood cell (Boot et al., 1995c) and the numbers of worker and drone brood cells provided by Dr Fuchs.

Varroa jacobsoni can effectively be trapped when using large numbers of worker brood cells. The finding that mites invade drone brood cells in larger numbers than worker brood cells (Boot et al., 1995c; Fuchs, 1990; Schulz, 1984) inspired several authors (Calis et al., 1997; Rosenkranz & Engels, 1985; Schulz et al., 1983) to develop biotechnical control methods in which mites are trapped in drone brood combs that are subsequently removed from the colony. From the experiments on the process of invasion, it follows that in a colony of given size the number of phoretic mites that can be trapped depends mainly on the number of cells used for trapping. The methods developed by Calis et al. (1997) are already effective with relatively small amounts of drone brood cells. Boot et al. (1995c) calculated that in a broodless colony of 1 kg of bees only 462 drone brood cells are needed to trap 95% of the mites. To obtain the same result, however, 5357 worker brood cells would be needed. The principle of trapping mites in broodless colonies with drone brood has led to the development of several biotechnical control methods (Calis et al., 1996; Smidt-Bailey et al., 1996). Without tests in the field, the effectiveness of biotechnical control methods can now be predicted using the simulation model developed by Calis et al. (1999a, (Chapter4)).

Acknowledgments We thank Dr. S. Fuchs for kindly providing the data he collected in 1987.

References

- Beetsma, J, Boot, WJ, Calis, JNM (1993) Special techniques to make detailed observations of *Varroa* mites staying on bees and invading honeybee brood cells. In Connor LJ et al. (editors), *Asian Apiculture*, Wicwas Press, Cheshire CT, USA, pp. 510-520.
- Beetsma, J, Zonneveld, K (1992) Observations on the initiation and stimulation of oviposition of the *Varroa* mite. *Experimental & Applied Acarology* 16: 303-312.
- Boecking, O (1992) Removal behavior of *Apis mellifera* towards sealed brood cells infested with *Varroa jacobsoni*: techniques, extent and efficacy. *Apidologie* 23: 371-373.
- Boecking, O & Drescher, W (1990) The reaction of worker bees in different *Apis mellifera* colonies to *Varroa* infested brood cells. In *Proceedings of the International Symposium on Recent Research on Bee Pathology*, Gent, Belgium, pp. 41-42.
- Boecking, O & Drescher, W (1991) Response of *Apis mellifera* colonies to brood cells infested with *Varroa jacobsoni* Oud.. *Apidologie* 22: 237-241.
- Boot, WJ (1994) Methyl palmitate does not elicit invasion of honeybee brood cells by *Varroa* mites. *Experimental and Applied Acarology* 18: 587-592.
- Boot, WJ & Calis, JNM (1991) A method to obtain dated brood in honeybee colonies. *Bee World* 72: 19-21.
- Boot, WJ, Beetsma, J & Calis, JNM (1994a) Behaviour of *Varroa* mites invading honey bee brood cells, *Experimental & Applied Acarology* 18: 371-379.
- Boot, WJ, Calis, JNM & Beetsma, J (1992) Differential periods of *Varroa* mite invasion into worker and drone cells of honey bees. *Experimental & Applied Acarology* 16: 295-301.
- Boot, WJ, Calis, JNM & Beetsma, J (1993) Invasion of *Varroa jacobsoni* into honey bee brood cells: a matter of chance or choice? *Journal of Apicultural Research* 32: 167-174.
- Boot, WJ, Calis, JNM & Beetsma, J (1995a) Does the time spent on adult bees affect reproductive success of *Varroa* mites? *Entomologia Experimentalis et Applicata* 75: 1-7.
- Boot, WJ, Driessen, RG, Calis, JNM & Beetsma, J (1995b) Further observations on the correlation between attractiveness of honey bee brood cells to *Varroa jacobsoni* and the distance from larva to cell rim. *Entomologia Experimentalis et Applicata* 76: 223-232.
- Boot, WJ, Schoenmaker, J, Calis, JNM & Beetsma J (1995c) Invasion of *Varroa jacobsoni* into drone brood cells of the honey bee, *Apis mellifera*. *Apidologie* 26: 109-118.

- Boot, WJ, Sisselaar, DJA, Calis, JNM & Beetsma, J (1994b) Factors affecting invasion of *Varroa jacobsoni* (Acari: Varroidea) into honeybee, *Apis mellifera* (Hymenoptera: Apidae), brood cells. *Bulletin of Entomological Research* 84: 3-10.
- Boot, WJ, Van Baalen, M & Sabelis, MW (1995d) Why do *Varroa* mites invade worker brood cells of the honey bee despite lower reproductive success? *Behavioral Ecology and Sociobiology* 36: 283-289.
- Büchler, R (1989) Attractivity and reproductive suitability for the *Varroa*-mite of bee brood from different origin. In Cavalloro R. (editor) *Present status of Varroosis in Europe and progress in the Varroa mite control*. Office for Official Publications of the European Communities, Luxembourg, pp. 139-145.
- Calis, JNM, Boot, WJ & Beetsma, J (1993) Behavior of *Varroa* mites invading honey bee brood cells of different sizes. In Connor LJ et al. (editors), *Asian Apiculture*, Wicwas Press, Cheshire CT, USA, pp. 499-509.
- Calis, JNM, Boot, WJ & Beetsma, J (1997) Attractiveness of brood cells to *Varroa mites* in different honeybee races. *Apidologie* 28: 182.
- Calis, JNM, Boot WJ & Beetsma, J (1999) Model evaluation of methods for *Varroa jacobsoni* mite control based on trapping mites in honey bee brood. (Chapter 4) *Apidologie* 30: 197-207.
- Calis, JNM, Boot WJ & Beetsma, J (2001) Attractiveness of brood cells from different honeybee races (*Apis mellifera*) to *Varroa* mites (Chapter 8) *This thesis*
- Calis, JNM, Boot, WJ, Beetsma, J, Van den Eijnde, JHPM, De Ruijter, A & Van der Steen, JJM (1996) Trapping *Varroa jacobsoni* in drone brood combs of *Apis mellifera* in broodless colonies. *Apidologie* 27: 295.
- Calis, JNM, Fries, I & Ryrle, SC (1999) Population modelling of *Varroa jacobsoni* Oud.. (Chapter 5) *Apidologie* 30: 111-124.
- Calis, JNM, Schmidt-Bailey, J, Beetsma, J, Boot, WJ, Eijnde, JHPM van den, Fuchs, S, Ruijter, A de, Steen, JJM van der (1997) Successful trapping of *Varroa jacobsoni* with drone brood in broodless *Apis mellifera* colonies. *Apiacta* 32: 65-71.
- De Jong, D (1984) Current knowledge and open questions concerning reproduction in the honey bee mite *Varroa jacobsoni*. In Engels, W et al. (editors) *Advances in invertebrate reproduction* 3, Amsterdam, Elsevier Science Publishers, pp. 547-552.
- De Jong, D & Morse, RA, (1988) Utilisation of raised brood cells of the honey bee, *Apis mellifera* (Hymenoptera: Apidae), by the mite, *Varroa jacobsoni* (Acarina: Varroidea). *Entomologia Generalis* 14: 103-106.
- De Jong, D, Morse, RA & Eickwort, GC (1982) Mite pests of honey bees, *Annual Review Entomology* 27: 229-252.
- De Ruijter, A (1985) Preference of *Varroa jacobsoni* Oudemans for different cell types and some factors affecting reproduction. In *Proceedings XXXth International Apicultural Congress*, Nagoya, Japan, pp. 165-167.
- De Ruijter, A (1987) Reproduction of *Varroa jacobsoni* during successive brood cycles of the honeybee. *Apidologie* 18: 321-326.
- De Ruijter, A & Calis, JNM (1988) Distribution of *Varroa jacobsoni* female mites in honey bee worker brood cells of normal and manipulated depth (Acarina: Varroidea). *Entomologia Generalis* 14: 107-109.
- De Ruijter, A & Pappas, N (1983) Karyotype and sex determination of *Varroa jacobsoni* Oud.. In Cavalloro R (editor) *Varroa jacobsoni* Oud. affecting honey bees Present status and Needs. A.A. Balkema, Rotterdam, pp. 41-44.
- Elzen, PJ, Eischen, FA, Baxter, JB, Pettis, J, Elzen, GW & Wilson, WT (1998) Fluvalinate resistance in *Varroa jacobsoni* from several geographic locations. *American Bee Journal* 138: 674-676.
- Fuchs, S (1985) Untersuchungen zur Quantitativen Abschätzung des Befalls von Bienenvölkern mit *Varroa jacobsoni* Oudemans und zur Verteilung des Parasiten im Bienenvolk. *Apidologie* 16: 343-368.

- Fuchs, S (1990) Preference for drone brood cells by *Varroa jacobsoni* Oud. in colonies of *Apis mellifera carnica*. *Apidologie* 21: 193-199.
- Fuchs, S & Langenbach, K (1989) Multiple infestation of *Apis mellifera* L. brood cells and reproduction in *Varroa jacobsoni* Oud.. *Apidologie* 20: 257-266.
- Fuchs, S & Müller, K (1988) Invasion by honeybee brood cells by *Varroa jacobsoni* in relation to the age of the larva. In Cavalloro R. (editor), *European Research on Varroa Control*. A.A. Balkema, Rotterdam, pp. 77-79.
- Goetz, B & Koeniger, N (1993) The distance between larva and cell opening triggers broodcell invasion by *Varroa jacobsoni*. *Apidologie* 24: 67-72.
- Greatti, M, Milani, N & Nazzi, F (1992) Reinfestation of an acaricide-treated apiary by *Varroa jacobsoni* Oud.. *Experimental & Applied Acarology* 16: 279-286.
- Harizanis, PC (1991) Infestation of queen cells by the mite *Varroa jacobsoni*. *Apidologie* 22: 533-538.
- Ifantidis, MD (1984) Parameters of the population dynamics of the *Varroa* mite on honeybees. *Journal of Apicultural Research* 22: 200-206.
- Ifantidis, MD (1988) Some aspects of the process of *Varroa jacobsoni* mite entrance into honey bee (*Apis mellifera*) brood cells. *Apidologie* 19: 387-396.
- Ifantidis, MD & Rosenkranz, P (1988) Reproduktion der Bienenmilbe *Varroa jacobsoni* (Acarina: Varroidae). *Entomologia Generalis* 14 (1988) 111-122.
- Jacobs, F, Bruneau, E & Trouiller J (1997) Resultaten van de campagne voor de opsporing van resistente van *Varroa jacobsoni* t.o.v. pyrethrioiden in België, *Maandblad Vlaamse Imker Bond* 83: 369-372.
- Kraus, B, Koeniger, N & Fuchs, S (1986) Unterscheidung zwischen Bienen verschiedenen Alters durch *Varroa jacobsoni* Oud. und Bevorzugung von Ammenbienen im Sommerbienenvolk. *Apidologie* 17: 257-266.
- Le Conte, Y, Arnold, G, Trouiller, J, Masson, C, Chappe, B & Ourisson, G (1989) Attraction of the parasitic mite *Varroa* to the drone larvae of honey bees by simple aliphatic esters. *Science* 245: 638-639.
- Martin, S (1998) A population model for the ectoparasite *Varroa jacobsoni* in honey bee (*Apis mellifera*) colonies. *Ecological Modelling* 109: 267-281.
- Otten, C & Fuchs, S (1988) Individual differences in *Varroa jacobsoni* of preference for drone larvae to worker bee larvae. In Cavalloro R. (editor) *European Research on Varroa Control*. A.A. Balkema, Rotterdam, pp. 69-71.
- Ramon, H, Van Laere, O & Ifantidis, M (1993) Size of comb cell and reproduction of *Varroa jacobsoni*. In Connor LJ et al. (editors) *Asian Apiculture*, Wicwas Press, Cheshire CT, USA, pp. 521-529.
- Radtke, J (1997) Zur Frage individueller Bevorzugung von Drohnen- bzw. Arbeiterbrut durch *Varroa jacobsoni* Oud.. *Apidologie* 28: 188-190.
- Rath, W (1993) Aspects of preadaptation in *V. jacobsoni* while shifting from its original host *A. cerana* to *A. mellifera*. In Connor LJ et al. (editors) *Asian Apiculture*, Wicwas Press, Cheshire CT, USA, pp. 417-426.
- Rehm, S.M. & Ritter, W (1989) Sequence of the sexes in the offspring of *Varroa jacobsoni* and the resulting consequences for the calculation of the development period. *Apidologie* 20: 339-343.
- Ritter, W (1981) *Varroa* disease of the honeybee *Apis mellifera*. *Bee World* 62: 41-153.
- Rosenkranz, P & Engels, W (1985) Konsequente Drohnenbrutentnahme, eine wirksame biotechnische Massnahme zur Minderung van Varroatose-Schäden an Bienenvölkern, *Allgemeine Deutsche Imkerzeitung* 19: 265-271.
- Rosenkranz, P, Tewarson, NC & Engels, W (1984) Optimal host selection by reproductive female *Varroa jacobsoni*. In Engels, W et al. (editors) *Advances in invertebrate reproduction* 3, Amsterdam, Elsevier Science Publishers, pp. 628.
- Sakofsky, F (1989) Transfer of *Varroa jacobsoni* by robbing. In Cavalloro R. (editor) *Present status of Varroa Control in Europe and progress in the Varroa mite control*. Office for Official Publications of the European Communities, Luxembourg, pp.177-181.

- Sakofsky, F & Koeniger, N (1988) Natural transfer of *Varroa jacobsoni* among honeybee colonies in autumn. In Cavalloro R. (editor.) *European research on varroaosis control*, A.A. Balkema, Rotterdam, Brookfield, pp. 81-83.
- Schmidt-Bailey, J & Fuchs, S (1997) Versuche zur Fangeffizienz von *Varroa jacobsoni* mit Drohnenbrut-Fangwaben. *Apidologie* 28: 184-186.
- Schmidt-Bailey, J, Fuchs, S & Büchler, R (1996) Effectiveness of drone brood trapping combs in broodless honeybee colonies. *Apidologie* 27: 294.
- Schulz, AE (1984) Reproduktion und Populationsentwicklung der parasitischen Milbe *Varroa jacobsoni* Oud. in Abhängigkeit vom Brutzyklus ihres Wirtes, *Apis mellifera* L.. *Apidologie* 15: 401-420.
- Schulz, AE, Koeniger, N & Ruttner F (1983) Drohnenbrut als Varroafalle, *Allgemeine Deutsche Imkerzeitung* 17: 52-54.
- Steiner, J, Dittmann, F, Rosenkranz, P & Engels W (1994) The first gonocycle of the parasitic mite (*Varroa jacobsoni*) in relation to preimaginal development of its host, the honey bee (*Apis mellifera carnica*). *Invertebrate reproduction and development* 25: 175-183.
- Trouiller, J & Faucon, JP (1997) Résultats 1997 des analyses de laboratoire sur la résistance de *Varroa* au fluvalinate. Translation in *Maandblad Vlaamse Imker Bond* 83: 294-295.
- Trouiller, J, Arnold, G, Le Conte, Y & Masson, C (1991) Temporal pheromonal and kairomonal secretion in the brood of honeybees. *Naturwissenschaften* 78: 368-370.
- Trouiller, J, Arnold, G, Chappe, B, Le Conte, Y & Masson, C (1992) Semiochemical basis of infestation of honey bee brood by *Varroa jacobsoni*. *Journal of Chemical Ecology* 18: 2041-2053.
- Trouiller, J, Arnold, G, Chappe, B, Le Conte, Y, Billion, A & Masson, C (1994) The kairomonal esters attractive to the *Varroa jacobsoni* mite in the queen brood. *Apidologie* 25: 314-321.
- Wallner, K (1999) Varroacides and their residues in bee products. *Apidologie* 30: 235-248.
- Wieting, J & Ferenz, HJ (1991) Behavioral study on the invasion of honeybee brood by the mite *Varroa jacobsoni* on wax combs and ANP combs. *American Bee Journal* 131: 117-118.

Control of *Varroa* mites by combining trapping in honey bee worker brood with formic acid treatment of the capped brood outside the colony: Putting knowledge on brood cell invasion into practice

Abstract

Biotechnical *Varroa* mite control methods are based on the principle that mites inside brood cells are trapped and then removed from the bee colony. In our experiments trapped mites were killed with formic acid. Worker brood used for trapping was retained and returned to the colonies. The observed percentage of mites trapped and killed by formic acid treatment was 87% and 89% in two experiments. The effectiveness could be predicted using prior knowledge on brood cell invasion behaviour, which thus proved to be valid for design and improvement of trap-comb methods for ecological *Varroa* control.

Introduction

The *Varroa* mite, *Varroa jacobsoni* Oud., is a pest of the Western honey bee, *A. mellifera* L.. Female mites feed on both adult and immature bees, but reproduce only inside capped brood cells (Ifantidis, 1983; Steiner et al., 1994; Martin, 1994 & 1995). Mites invade brood cells before capping (Ifantidis, 1988; Boot et al., 1992) and when the young bees emerge from the brood cells, mites and their offspring also leave the cells.

Varroa mites have several deleterious effects on their host. Parasitised bees lose weight, may have malformations and a shortened life span (Jong et al., 1982; Schneider & Drescher, 1987; Kovac & Crailsheim, 1988; Beetsma et al., 1989). Additionally, mites increase the incidence of honey bee diseases because they act as vectors of honey bee pathogens (Wieggers, 1988; Ball, 1994). Consequently, without mite control bee colonies usually perish within a few years after infestation with *Varroa* mites (Ritter, 1981).

Yearly treatments of colonies with an acaricide may effectively reduce the size of mite populations (Koeniger & Fuchs, 1988), but this has the disadvantages of contaminating bee products (Hansen & Petersen, 1988; Buren et al., 1992; Lodesani et al., 1992; De Greef et al., 1994) and selection for acaricide resistance (Milani, 1994; Lodesani et al., 1995).

Environmentally safe chemicals, e.g. formic and lactic acid, can be successfully applied to control *Varroa* mites (Ritter & Ruttner, 1980; Kraus & Berg, 1994). However, application of these chemicals also has disadvantages. Formic acid occurs naturally in honey (Crane, 1975), but application for mite control may increase its concentration (Hansen and Guldborg, 1988). In addition, formic acid treatment of colonies may damage uncapped brood and young bees and may cause the loss of queens (Liebig et al., 1984; Fries, 1989; Bolli et al., 1993).

Mites trapped inside brood cells can easily be removed from a colony. This principle is used in biotechnical mite-control methods. Mites are trapped in a few brood combs, which are destroyed subsequently (Maul et al., 1988; Fries & Hansen, 1993). The effectiveness of these methods depends on the relative number of mites that invade the trap-combs. The rate of invasion of mites into brood cells is related to the ratio between number of capped brood cells and colony size. This can be explained as follows. Observations on invasion behaviour of individual mites, showed that a honey bee carries a mite close to the opening of a brood cell before the mite invades. Brood cells suitable for mite invasion comprise only a small percentage of the bee-inhabited

comb surface. Bees move over the comb surface and spend on average the same percentage of their time near these brood cells. This time spent near suitable brood cells may determine the rate of brood cell invasion. If this is true, then the rate of invasion will be higher when more brood cells are suitable for invasion, because the time spent by bees near suitable brood cells will also be higher. Similarly, the rate of invasion will be higher in a smaller colony, but with the same amount of brood cells (Boot et al., 1993, 1994a, 1994b, 1995b). This knowledge on invasion behaviour can be used as a tool to calculate the number of brood cells needed to trap enough mites for successful control.

Originally, biotechnical trap-comb techniques use as little brood as possible to trap the mites, because the trap-combs are destroyed. Brood production by the queen is restricted by confining the queen in a worker bee accessible cage containing only one comb (Maul et al., 1988; Fries & Hansen, 1993). However, brood with trapped mites should not necessarily be destroyed, because mites in brood can be selectively killed. Fries (1991) showed that formic acid treatment of capped brood can kill the trapped mites, whereas more than 90% of the brood survives. Mites trapped in capped brood can also be selectively killed with a high temperature treatment (Rosenkranz, 1987; Engels, 1994). Because the trap-combs can be safely returned to the colonies after killing the mites and more mites are trapped with more brood, biotechnical trap-comb techniques will be improved when brood production is not restricted.

In this study our aims were twofold. Firstly, to design and test control methods that are of practical value because the brood used for trapping can be retained, whereas the mites are killed by formic acid treatment of trap-combs only. Secondly, to test whether observations on brood cell invasion behaviour (Boot et al, 1993, 1994a, 1994b, 1995b) predicts the effectiveness of trap-comb methods. We measured numbers of brood cells on the trapping combs and the colony sizes to predict the relative number of trapped mites and compared this prediction with the observed effectiveness of the control method. To make trap-comb methods equally effective as an acaricide treatment it should reduce the mite population by 95%. Preliminary results (Calis et al., 1993) suggested that more than 95% of the mites can be trapped if the brood produced by the queen in a 27 day period is used for trapping. In this study, we tested two different ways to obtain batches of capped brood for formic acid treatment at different times of the season.

Material and Methods

Outline of the experiments

We applied trap-comb techniques in two groups of colonies. Dated brood was obtained by arresting queens on empty combs for 3 subsequent 9-day periods. Brood produced during these arrestment periods trapped mites until all brood cells were capped. When the brood on the trap-combs was capped and was between 9 and 18 days old, the trapped mites were killed by formic acid treatment. The effectiveness of the control method was determined by counting the numbers of trapped and subsequently killed mites as well as the numbers of mites remaining in the colony. To predict the effectiveness, we measured the colony size and counted the numbers of treated cells as parameters determining the mite's rate of brood cell invasion.

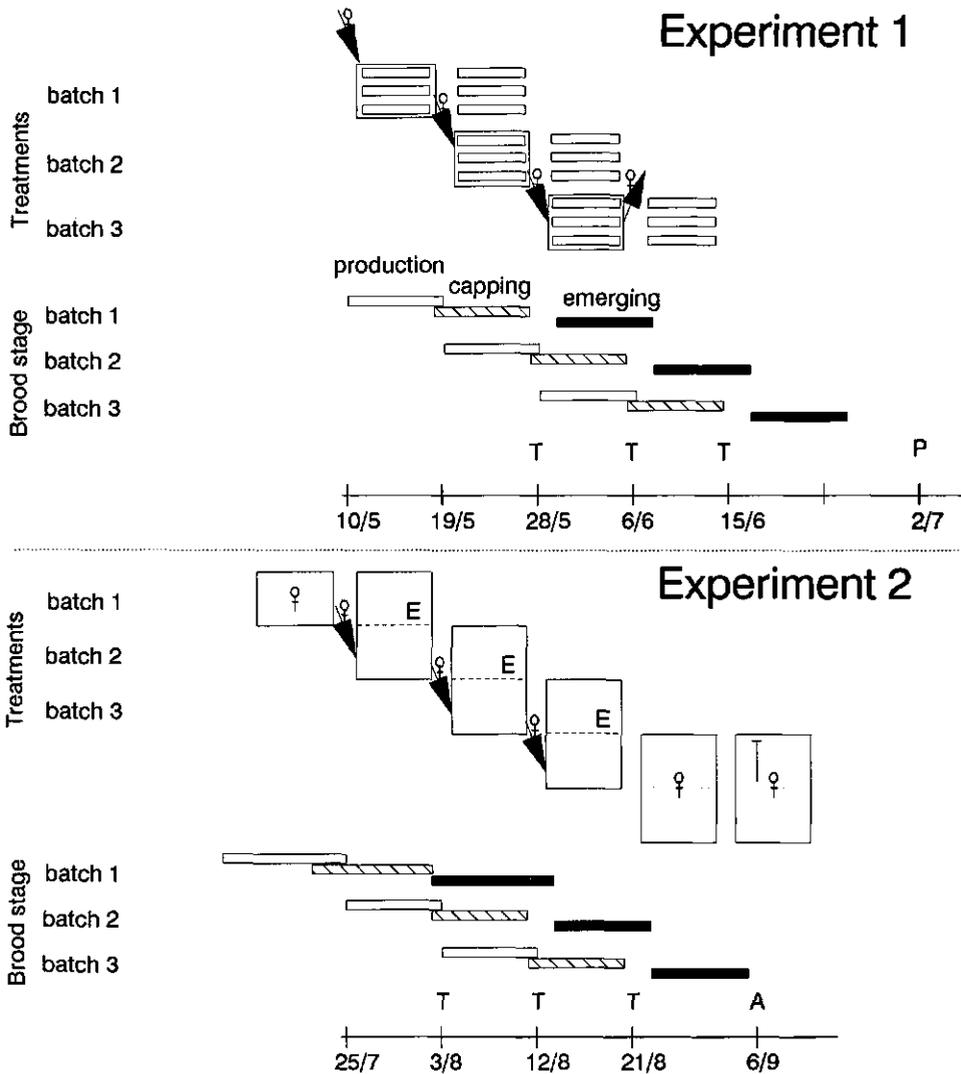

Figure 1. Schematic representation of the *Varroa* control methods using trap-combs treated with formic acid outside the colony. The dates during experiment 1 and 2 are on the X-axis, starting from the first queen arrestment period. The transfer of the queen is indicated. For all batches of brood; production, capping, treatment with formic acid (T) and emerging are shown. The start of the acaricide treatments Perizin (P) in experiment 1 and Apistan (A) in experiment 2 is also indicated.

Honey bees and mites

The commonly found honey bees in the Netherlands, a hybridised population as many races have been imported, were used in our experiments. Colonies were kept in 10-frame hives in two stories and were infested with *Varroa* mites by introduction of bees and brood from other infested colonies.

Obtaining worker brood on trap-combs for mite trapping

Experiment 1: In each colony ($n=7$), the queen was confined on three combs in a cage made of queen excluder screen. The cage was placed into the middle of the original brood nest of the colony. After a first interval of nine days the three trap-combs were placed outside the cage and replaced with empty combs. After the second interval of 9-days the first batch of brood was completely capped and was treated with formic acid to kill the trapped mites. In total three subsequently produced batches of brood were treated this way. After production of the third batch of brood the queen and the cage were removed from the colony. This experiment was performed during the swarming period in spring (Figure 1).

Experiment 2: In each colony ($n=10$), the queen was confined to one story with broodless combs using queen excluders. After a first interval of 9-days, the original brood nest was capped completely and treated with formic acid to kill the trapped mites. The queen was placed in the story with the returned treated combs. After the second interval of 9-days, the brood produced by the queen in the new story was capped and treated with formic acid to kill the trapped mites. The queen was transferred to the story with the treated combs. The newly produced brood in the original brood story was similarly treated after the third interval of 9-days. This experiment was performed after the swarming period in summer (Figure 1).

Killing trapped mites with formic acid

Formic acid was applied in 10-frame boxes made of extruded polystyrene foam parts fixed to each other with polyurethane glue. Three *Illertisser Milben Platten* (further *IMP*), cartons soaked with 60% formic acid solution, were placed into the box: one at the bottom and two covering the trap-combs. Subsequently, the box was sealed for 1 (experiment 1) or 1.5 hours (experiment 2). Experiments to measure mortality of mites after formic acid treatment of capped brood were done earlier and in the experiments described here (Table 2). In 1992, treatment of worker brood during one hour with these *IMP* resulted in a high mortality of mites. This particular duration of the formic acid treatment was chosen for experiment 1. In an experiment conducted in 1993 some mite survival occurred in combs that were next to the sides of the foam boxes, however. Therefore, in experiment 2 no more than 9 combs were treated simultaneously and the box was sealed for 1.5 hours to improve the effectiveness of the formic acid treatment. After treatment the combs were returned to their original colony. The effectiveness of the formic acid treatment was assessed by opening part of the capped cells and examining mortality of trapped mites one or two days after treatment.

Effectiveness of the trapping methods

Mites killed in treated brood fall to the bottom of the hive when the bees emerge from the brood cells. Once or twice a week killed mites were collected from the drawer underneath the gauze bottom of the colonies. When all the formic acid treated brood had

emerged, mites left in the colonies were killed by acaricide treatment and also collected from the drawer, to determine the effectiveness of the trapping methods. The colonies were treated with *Perizin* (application of suspension; experiment 1) if no other brood was present or with *Apistan* (carrier remaining in the colony; experiment 2) when brood was present.

Mite invasion into the experimental colonies from other colonies was monitored from the start of the *Apistan* treatment of the colonies of experiment 2. Two mite-free colonies, already treated with *Apistan* for one month were placed between the experimental colonies. Mites killed during the *Apistan* treatment were counted.

Colony weight and the number of brood cells

The total weight of the bees in the colonies, as a measure of colony size, was determined by weighing the hives with bees and without bees. This weighing of the colonies was performed at one moment during capping of the trap-combs. Hive entrances were closed during darkness and the hives were weighed in the morning. After the bees had been removed the hives were weighed again. Subsequently, the bees were returned to their hives.

When the trap-combs were taken from the colonies for formic acid treatment, the number of worker brood cells on these trap-combs was estimated for each colony using a grid divided into areas corresponding to 100 cells. The drone cells, being much lower in numbers, were counted individually.

Experiments to determine the number of capped brood cells produced in 9-day arrestment periods and the weight of the colonies were carried out in 1991, 1992 & 1993. Data were obtained during the swarming period, brood oviposited between May 10 and June 24, and after the swarming period, brood produced by the queen between July 29 and August 19.

Prediction of trapped and killed mites using prior knowledge on brood cell invasion

The rate of invasion of mites into brood cells is related to the ratio between the number of capped brood cells and colony size (Boot et al., 1993, 1994b). Therefore, the relative number of mites invading trap-combs in the course of the experiment, can be predicted when the colony size and the relative number of capped brood cells is known. How can we compare this prediction with observations? Trapped and subsequently killed mites fall from treated brood cells to the drawer of the hive in a sequence parallel to invasion of the mites into the brood cells, delayed with the duration of the capped honey bee brood stage. Therefore, the prediction of the relative number of trapped mites can be used to predict the relative number of killed mites that are collected from the drawer.

The percentage of mites falling to the drawer in the course of the experiments was predicted using the following assumptions:

1. Mites emerge at a constant rate from the original brood present at the start of mite trapping.
2. Mites on bees invade worker brood cells (w) before they are capped at a relative invasion rate, r_w (day^{-1}), which is proportional to the ratio of the number of brood cells that are capped during one day, B_w (day^{-1}), and the weight of the bees of the colony, C (gram; Boot et al., 1995b).

$$r_w = 0.56 \cdot B_w / C \quad (1)$$

3. The worker brood in the trap-combs is invaded with M_t mites per day. This depends on the number of mites on the bees, M , and the relative rate of worker brood cell invasion; r_w (day^{-1}).

$$M_t = M(1 - e^{-r_w}) \quad (2)$$

4. Mites invade and emerge from the brood cells in a parallel sequence. When the mites are killed, the maximum age of the brood is 18 days. At that age no female offspring is yet adult. Therefore, the same amount of adult mites that invades on one day, M_t , falls dead 12 days later to the drawer, M_d , since the capped worker brood stage lasts 12 days.

$$M_t = M_{d,t+12} \quad (3)$$

5. Mites left on the bees after the formic acid treatments, will invade new brood cells, if present, until the start of the acaricide treatment. On average two mites are expected to emerge from worker brood per invaded mite (Boot et al., 1995a). Mites on the bees are killed instantaneously by the acaricide treatments.

The distribution of mites on bees and brood at the start of mite trapping was unknown. The relative number of dead mites collected from the drawer of the hives in the course of the experiment was predicted for two extreme situations, either when all mites were on the bees or when all mites were in the capped brood cells.

Table 1. The average and standard deviation per experiment per colony of: the weight of the colonies, the total number of mites found on the drawer, the number of capped brood cells, the percentage of mites on the drawer after the formic acid treatments and the acaricide treatment.

		Experiment 1 (n=7)	Experiment 2 (n=10)
Colony weight (g)		3318 ± 623	2866 ± 329
Mites per colony		1023 ± 502	1536 ± 773
Treated brood cells:			
First arrestment period	worker	6746 ± 625	6610 ± 1518
	drone	-	228 ± 192
Second arrestment period	worker	8214 ± 2051	5840 ± 2600
	drone	179 ± 151	84 ± 143
Third arrestment period	worker	7871 ± 2388	5350 ± 839
	drone	220 ± 288	13 ± 28
Mites on drawer (%)			
Formic acid treatment		87 ± 5	89 ± 4
Acaricide treatment		13 ± 5	11 ± 4

- = no data

Results

Brood obtained for mite trapping and the effectiveness of the methods

Three batches of brood were used to trap mites and these were subsequently treated with formic acid in both experiments. On average, 6881 and 6211 worker brood

cells per kg of bees were treated in experiment 1 and 2, respectively. The percentage of drone cells capped is 2.4% and 1.8% of the total number of capped cells in experiment 1 and 2, respectively. The percentages of mites trapped and killed by the formic acid treatments were on average 87% and 89% for experiment 1 and 2, respectively (Table 1).

Reinvasion of the experimental colonies of mites from other colonies

During the *Apistan* treatment of the colonies of experiment 2, we found on average 167 mites in the experimental colonies. In the two mite-free control colonies we found 37 and 88 mites during the same period.

Mite mortality after a formic acid treatment of capped brood

Experiment 1: In brood cells opened to determine the effectiveness of the formic acid treatment only three dead mites were found (1 mite in 600 worker cells and 2 mites in 97 drone cells).

Experiment 2: The observed percentages of mite mortality were 97% (n=152) and 85% (n=372) in worker brood cells and drone brood cells respectively.

Prediction of the relative number of trapped mites in three batches of brood

The weight of colonies during the swarming period appeared to be higher than after the swarming period (Mann-Whitney U-test, $P < 0.001$), probably because of colony management. The colonies used during the swarming period were undivided, whereas the colonies used after the swarming period were in fact one of the two parts of an original colony. Also, the average number of drone brood cells capped per 9 day arrestment period was significantly higher during the swarming period (average: 365; range: 0-882; n=32) compared to after the swarming period (average: 49; range: 0-450; n=20) (Mann-Whitney U-test, $P < 0.001$). The amount of worker brood cells capped in the swarming period was not related to colony size, while after the swarming period the regression coefficient of the number of capped worker brood cells and the colony size was significant ($t_{[68]} = 5.06$; $P < 0.001$) (Figure 2A). Consequently, the relation between potentially trapped mites and colony size was different between the two periods. The regression lines of the worker brood cells on the colony size were used to predict the percentage of trapped mites for the case where 3 subsequently capped batches of brood were used for trapping (Figure 2B). The upper and lower lines represent the predictions for the situation that all mites are either on the bees or still in the original brood nest at the start of mite trapping. Predictions for more realistic, intermediate distributions are proportionally between those for these extreme distributions. Since the ratio number of capped brood cells/colony size becomes smaller when the colonies are larger, the predicted percentage of trapped mites decreased with increasing colony sizes.

Observed and predicted cumulative percentage of dead mites on the drawer during Experiments 1 and 2

Figure 3 shows the observed cumulative percentage of dead mites found on the drawer of the colonies during the emergence of formic acid treated brood and the acaricide treatment. The lines represent predictions of the model. The upper and lower lines represent the situations with, respectively, all mites on bees and all mites in the

brood, at the start of mite trapping. A higher effectiveness was predicted for experiment 1 (93-98 %) than for experiment 2 (87-94 %; Figure 3).

Discussion

Trapping mites with worker brood

To make trap-comb methods as effective as an acaricide treatment, it should reduce the mite population by 95%. To reach this effectiveness, a relative worker brood cell invasion rate of $-\ln(0.05) = 3.00$ per time unit is needed (time unit reflects the period during which mites are trapped; Equation 2). Using Equation 1 we can calculate that $-\ln(0.05)/0.00056 = 5350$ worker brood cells are needed to trap 95% of the mites in a colony of 1 kg of bees ($C = 1000$ grammes). The amount of worker brood cells that colonies produce during 9 day periods was measured (Figure 2A). At the intercept of the two regression lines from figure 2A, an imaginary colony of 4.3 kg of bees produces 8184 capped worker brood cells, or 1911 cells per kg of bees. If the production of capped brood is similar in subsequent periods, three batches of brood will be needed to reach the required number of capped brood cells, resulting in 5733 capped worker brood cells per kg of bees. The model predicts that 96% of the mites are trapped, when all mites are on the bees at the start of mite trapping. Mites in the original brood nest can only be trapped after emergence of the bees. In the case that all mites are in the original brood nest at the start of mite trapping, the model predicts that 90% of the mites are trapped (Figure 2B). Since the initial distribution of mites over bees and brood cells will be intermediate (Fuchs, 1985), the expected effectiveness will also be intermediate, and near 95%.

Predicting the cumulative percentages of mites collected from the drawer of the colonies

The observed cumulative numbers of mites collected from the drawers are in agreement with the predictions. In experiment 1 the observed number of trapped and killed mites is slightly lower than the predicted number, while for experiment 2 the observed cumulative number of mites collected from the drawer is within the predicted range (Figure 3). In experiment 1 the queens were removed from the colonies after the production of the third batch of brood, while in experiment 2 the queens remained in the colonies. Thus in experiment 2, mites left in the colonies after trapping can be predicted to increase in numbers by invasion and reproduction in brood cells that were capped after the third batch of brood until the acaricide treatment. This caused slightly lower predicted percentages of trapped and killed mites in experiment 2 compared to experiment 1.

The effectiveness of the trapping method was 87% and 89% on average for experiment 1 and 2, respectively. How accurate are these figures? Firstly, mites may escape our observations because they get lost in the field. There is, however, no reason to assume that the percentage of mites escaping our observations is different when treated with formic acid or treated with another acaricide. Secondly, mites may reinvade the colonies used for our experiments (Sakofski et al., 1990). These colony-invading mites have a smaller chance to become trapped, because they enter the colonies after the start of mite trapping. Thus, they reduce the effectiveness of the method. This is not hypothetical. If *Apistan* treatment kills mites on the bees effectively, it prevents exchange of mites between the colonies used for our experiments. However, during the *Apistan* treatment of experiment 2 we found an average of 62.5 mites in the continuously *Apistan*

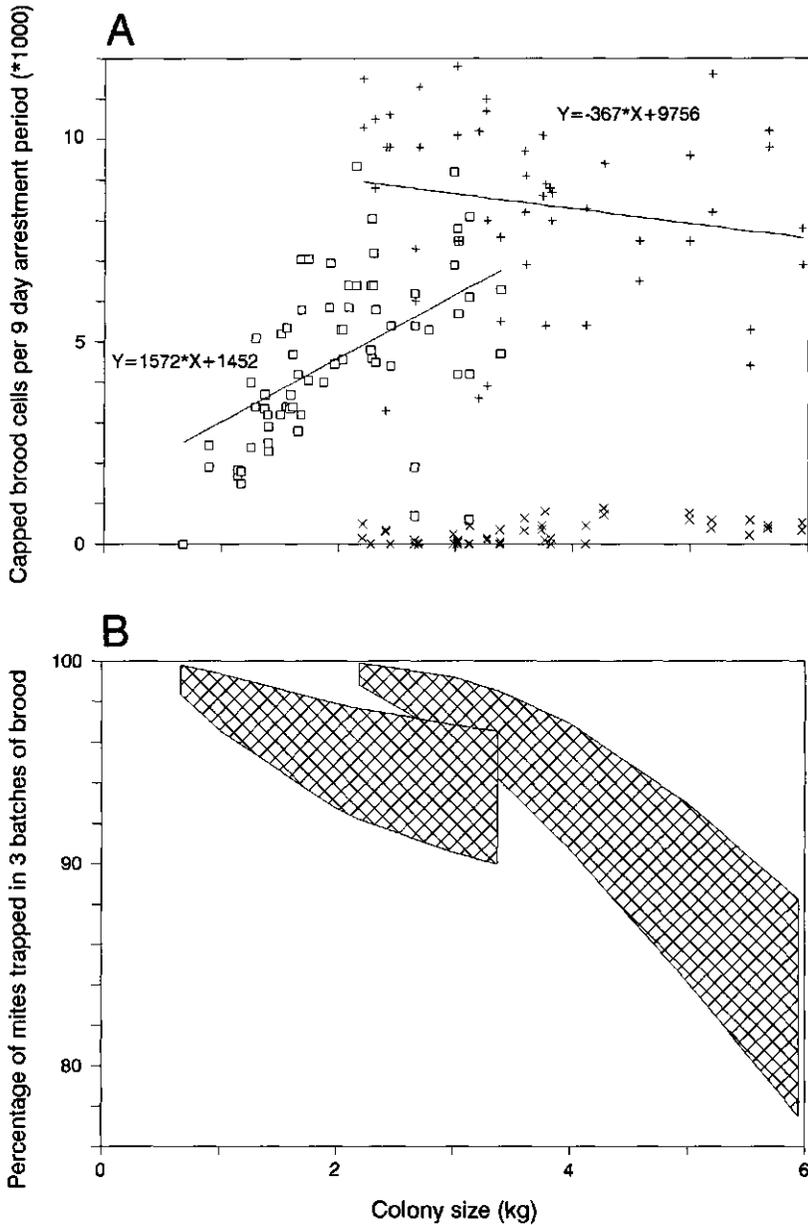

Figure 2. A: Numbers of capped brood cells per 9 day arrestment period (Y-axis) versus colony size (X-axis). Plus marks stand for data obtained during the swarming period and black square marks stand for data obtained after the swarming period. Regression lines are shown. Cross marks stand for numbers of drone cells. B: Predicted percentage of mites trapped in three batches of brood (Y-axis) versus colony size (X-axis). The upper and lower lines represent the prediction of the fraction of trapped mites, with all on the bees or in the capped brood at the start of mite trapping. For the predictions the regression lines of capped brood on colony size were used.

treated mite-free colonies. Consequently, a considerable part (27 %) of the mites left in the colonies after trapping, may have reinvaded the experimental colonies from other colonies in the neighbourhood. These colony-invaded mites comprise 4 % of the total number of mites recovered from the colonies. If they are excluded from calculation the effectiveness of experiment 2 would increase to 93%.

The effectiveness of the method

The effectiveness of the method not only depends on the relative number of trapped mites, but also on the mortality rate of mites in the combs treated with formic acid. Mites surviving the formic acid treatment will reduce the effectiveness of the method. In the experiments performed in 1991 (Calis et al., 1993) 30 ml of 85% formic acid was applied. Application of formic acid in experiments performed later was altered, because only *IMP* were allowed in the Netherlands for formic acid treatment of honey bee colonies. Unfortunately, a few mites may survive this formic acid treatment (Table 2). The effectiveness of the formic acid treatment will be affected by the partial vapour pressure of formic acid. This vapour pressure, can be calculated from the saturation vapour pressure of formic acid, $P^{\circ}(\text{CH}_2\text{O}_2) = 58 \text{ mmHg}$ (30°C), multiplied with the mole fraction of CH_2O_2 in the formic acid solution. The weight of one mole of $\text{CH}_2\text{O}_2 = 46 \text{ g}$ and one mole of water = 18 g. The mole fraction for 85% and 60% formic acid solutions are therefore 0.69 and 0.37, respectively. Therefore, the partial vapour pressure of formic acid is expected to be 1.86 times lower when applying *IMP* compared to treatment with a 85% formic acid solution. For a successful treatment of capped brood outside the colony, formic acid treatment with a concentrated formic acid solution is to be recommended (Fries, 1991; Krämer, 1986).

Table 2. Mortality rates of mites in drone and worker brood after formic acid treatment using a 30 ml, 85% formic acid solution or 3 Illertisser Milben Platten for 1 and 1.5 hour.

year	dose	duration (hours)	mortality of mites in worker cells % (number)	mortality of mites in drone cells % (number)
1991	30 ml, 85%	1	97 (152)	-
1992	3 IMP	1	100 (5)	-
1992	3 IMP	1	98 (53)	-
1993 (Exp.1)	3 IMP	1	100 (1)	100 (2)
1993	3 IMP	1.5	94 (72)	93 (270)
1993 (Exp.2)	3 IMP	1.5	97 (152)	85 (220)

The presence of drone brood cells also affects the results of the experiments. At first sight the presence of drone cells is expected to increase the effectiveness of the trap-comb method since drone cells are invaded about 12 times more frequently than worker brood cells (Boot et al., 1995b). However, the opposite is probably true for two reasons. Firstly, in experiment 2 some mites survived the formic acid treatment, because the mortality of mites in drone brood cells was 85% (Table 2). Secondly, mites may have escaped formic acid treatment by drone cell invasion. Treatment of the batches of brood 9-days after egg laying ensures that worker brood is capped since the development from egg to cell capping takes eight days. However, drone brood needs ten days for the development from egg to capped cell. Therefore, some of the drone brood cells can be invaded by mites until one day after formic acid treatment. These mites will escape from formic acid treatment. Since the number of capped drone cells is larger during the

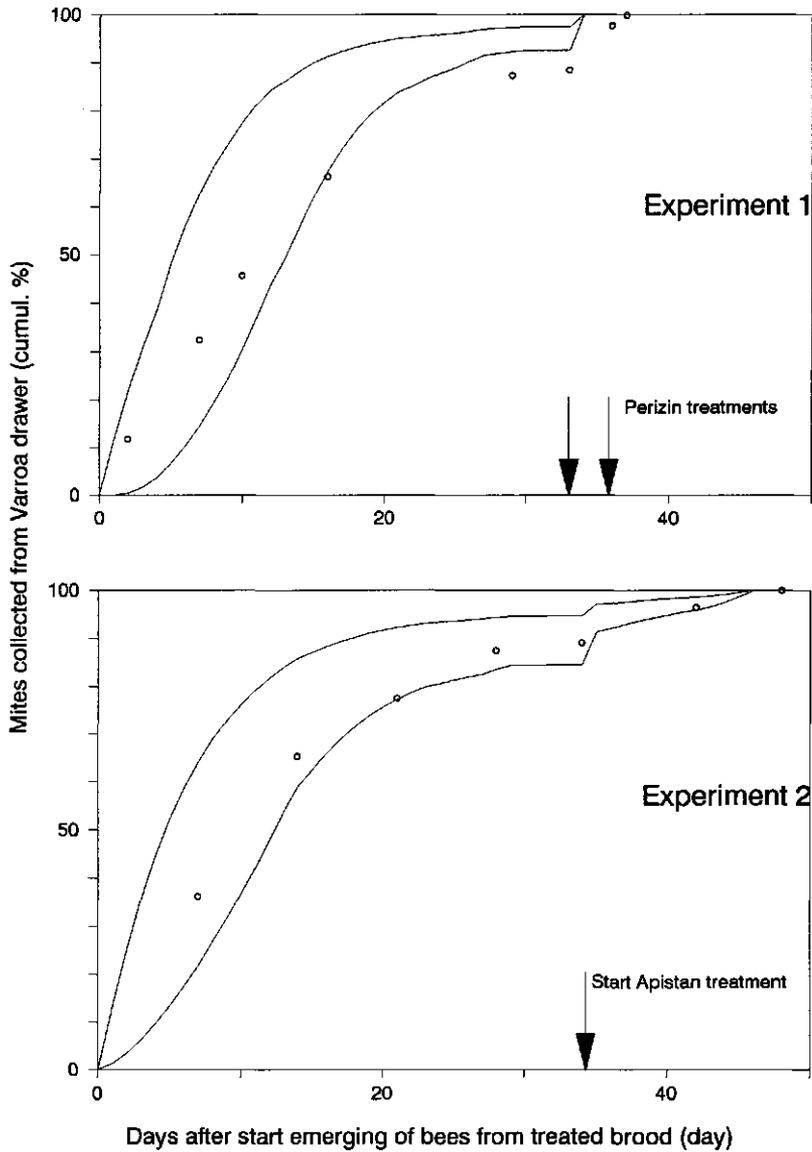

Figure 3. Cumulative relative number of dead mites fallen to the drawer from the start of emerging of bees from formic acid treated brood cells (Y-axis) versus time (X-axis). The upper and lower lines represent the expected number of trapped and killed mites in the course of the experiments, with all mites on the bees or in the capped brood at the start of mite trapping. The markers indicate the observed values. Also indicated are the acaricide treatments. Top: Experiment 1; Bottom: Experiment 2.

swarming period, it can be expected that the relative number of mites surviving and escaping treatment is higher in experiment 1, and indeed we found a lower effectiveness in this experiment. Problems with drone cells can be avoided by removing them from the combs.

Killing mites in capped brood improves *Varroa* control with trap-combs of worker brood, since the treated brood can be safely returned to the colonies. Moreover, we showed that knowledge on brood cell invasion of mites can be applied to design control methods using these trap-combs. However, if worker brood is used trap-comb methods remain labour intensive because at least 3 subsequently capped batches of brood produced in 9-day periods should be used. This disadvantage of the trap-comb method may be largely solved if mites are trapped in drone brood. Since drone brood cells are invaded 12 times more frequent than worker brood cells (Boot et al., 1995b), a control method using trap-combs with drone brood will already be effective when small quantities of brood with trapped mites are removed from the colonies (Calis et al., 1997).

Acknowledgements We thank M Beekman, GHM Calis, JC van Lenteren, MW Sabelis, the members of our PhD-study group and two anonymous referees for their valuable comments on various drafts of the manuscript. This study was supported by the Technology Foundation (STW), grant number: WGB88.1512.

References

- Ball, BV (1994) Host-Parasite-Pathogen interactions. In Matheson, A (editor) *New perspectives on Varroa*. IBRA, Cardiff, UK, pp 5-11.
- Beetsma, J, de Vries, R, Emami Yeganeh, B, Emami Tabrizi, M & Bandpay, V (1989) Effects of *Varroa jacobsoni* Oud. on colony development, workerbee weight and longevity and brood mortality. In Cavalloro, R (editor) *Present status of Varroa in Europe and progress in the Varroa mite control: proceedings of a meeting of the EC expert's group, Udine, Italy, 28-30 November 1988, Commission of the European Communities, Luxembourg*, pp 163-170.
- Bolli, HK, Bogdanov, S, Imdorf, A. & Fluri, P (1993) Zur Wirkungsweise von Ameisensäure bei *Varroa jacobsoni* Oud. und der Honigbiene (*Apis mellifera* L.). *Apidologie* 24: 51-57.
- Boot, WJ, Calis, JNM & Beetsma, J (1992) Differential periods of *Varroa* mite invasion into worker and drone cells of honey bees. *Experimental & Applied Acarology* 16: 295-301.
- Boot, WJ, Calis, JNM & Beetsma, J (1993) Invasion of *Varroa jacobsoni* into honey bee brood cells: a matter of chance or choice? *Journal of Apicultural Research* 32: 167-174.
- Boot, WJ, Beetsma, J & Calis, JNM (1994a) Behaviour of *Varroa* mites invading honey bee brood cells. *Experimental & Applied Acarology* 18: 371-379.
- Boot, WJ, Sisselaar, DJA, Calis, JNM & Beetsma, J (1994b) Factors affecting invasion of *Varroa* mites into honey bee brood cells. *Bulletin of Entomological Research* 84: 3-10.
- Boot, WJ, Calis, JNM & Beetsma, J (1995a) Does time spent on adult bees affect reproductive success of *Varroa* mites? *Entomologia Experimentalis et Applicata* 75: 1-7.
- Boot, WJ, Schoenmaker, J, Calis, JNM & Beetsma, J. (1995b) Invasion of *Varroa* mites into drone brood cells of the honey bee. *Apidologie* 26: 109-118.
- Buren, NWM van, Mariën, J, Velthuis, HHW & Oudejans, RCHM (1992) Residues in beeswax and honey of perizin, an acaricide to combat the mite *Varroa jacobsoni* Oudemans (Acari: Mesostigmata). *Environmental Entomology* 21: 860-865.
- Calis, JNM, Boot, WJ, Eijnde, JHPM van den & Ruijter, A de (1993) Control of the *Varroa* mite by treatment of sealed honey bee brood with formic acid. *Proceedings of the section Experimental and Applied Entomology of the Netherlands Entomological Society (NEV)*, Amsterdam, The Netherlands 4: 217-222.
- Calis, JNM, Schmidt-Baily, J, Beetsma, J, Boot, WJ, Eijnde, JHPM van den, Fuchs, S, Ruijter, A de & Steen, JMM van der (1997) Successful trapping of *Varroa jacobsoni* with drone brood in broodless *Apis mellifera* colonies. *Apiacta* 32: 65-71.
- Crane, E (1975) *Honey- a comprehensive survey*. Heinemann, London, UK

- De Greef, M, Wael, L de & Laere, O van (1994) The determination of the flouvalinate residues in the Belgian honey and beeswax. *Apiacta* 29: 83-87.
- Engels, W (1994) *Varroa* control by hyperthermia. In: Matheson, A (editor) *New perspectives on Varroa*. IBRA, Cardiff, UK: pp 115-119.
- Fries, I (1989) Short-interval treatments with formic acid for control of *Varroa jacobsoni* in honey bee (*Apis mellifera*) colonies in cold climates. *Swedish Journal Agricultural Research* 19: 213-216.
- Fries, I (1991) Treatment of sealed honeybee brood with formic acid for control of *Varroa jacobsoni*. *American Bee Journal* 131: 313-314.
- Fries, I & Hansen, H (1993) Biotechnical control of *Varroa* mites in cold climates. *American Bee Journal* 133: 435-438.
- Fuchs, S (1985) Untersuchungen zur Quantitativen Abschätzung des Befalls von Bienenvölkern mit *Varroa jacobsoni* Oudemans und zur Verteilung des Parasiten im Bienenvolk. *Apidologie* 16: 343-368.
- Hansen, H. & Guldborg, M (1988) Residues in honey and wax after treatment of bee colonies with formic acid. *Tidsskr. Planteavl.* 92: 7-10.
- Hansen, H & Petersen, JH (1988) Residues in honey and wax after treatment of bee colonies with bromopropylate. *Tidsskr. Planteavl.* 92:1-6.
- Ifantidis, M D (1983) Ontogenesis of the mite *Varroa jacobsoni* in worker and drone honeybee brood cells. *Journal of Apicultural Research* 22: 200-206.
- Ifantidis, M D (1988) Some aspects of the process of *Varroa jacobsoni* mite entrance into honey bee (*Apis mellifera*) brood cells. *Apidologie* 19: 387-396.
- Jong, D de, Jong, PH de & Goncalves, LS (1982) Weight loss and other damage to developing worker honeybees from infestation with *Varroa jacobsoni*. *Journal of Apicultural Research* 21: 165-167.
- Krämer, K (1986) Wasserfreie Ameisensäure als Bekämpfungsmittel der *Varroa*milbe im Bienenvolk im Herbst mit der Krämer-Platte. *Die Biene* 10: 467-484.
- Koeniger, N & Fuchs, S (1988) Control of *Varroa jacobsoni*: current status and developments. In Needham, G R, et al. (editors) *Africanized honeybees and bee mites*. Ellis Horwood Limited, Chichester, pp 360-369.
- Kovac, H & Crailsheim, K (1988) Lifespan of *Apis mellifera carnica* pollm. infested by *Varroa jacobsoni* Oud. in relation to season and extent of infestation. *Journal of Apicultural Research* 27: 230-238.
- Kraus, B & Berg, S (1994) Effect of a lactic acid treatment during winter in temperate climate upon *Varroa jacobsoni* Oud. and the bee (*Apis mellifera* L.) colony. *Experimental & Applied Acarology* 18: 459-468.
- Liebig, G Schlipf, U Fremuth, W & Ludwig, W (1984) Ergebnisse der Untersuchungen über die Befallsentwicklung der *Varroa*-milbe in Stuttgart-Hohenheim 1983. *Allgemeine Deutsche Imkerzeitung* 18: 185-191.
- Lodesani, M, Pellacani, A, Bergomi, S Carpana, E, Rabitti, T & Lasagni, P (1992) Residue determination for some products used against *Varroa* infestation in bees. *Apidologie* 23: 257-272.
- Lodesani, M, Colombo, M & Spreafico, M (1995) Ineffectiveness of Apistan treatment against the mite *Varroa jacobsoni* Oud. in several districts of Lombardy (Italy). *Apidologie* 26: 67-72
- Martin, S J (1994) Ontogenesis of the mite *Varroa jacobsoni* Oud. in worker brood of the honeybee *Apis mellifera* L. under natural conditions. *Experimental & Applied Acarology* 18: 87-100.
- Martin, S J (1995) Ontogenesis of the mite *Varroa jacobsoni* Oud. in drone brood of the honeybee *Apis mellifera* L. under natural conditions. *Experimental & Applied Acarology* 19: 199-210.
- Maul, V, Klepschi, A & Assmann-Werthmüller, U (1988) Das Bannwabenverfahren als Element Imkerlicher Betriebweise bei starkem Befall mit *Varroa jacobsoni* Oud. *Apidologie* 19: 139-154.
- Milani, N (1994) Possible presence of flouvalinate-resistant strains of *Varroa jacobsoni* in northern Italy. In: Matheson, A (editor) *New perspectives on Varroa*. IBRA, Cardiff, UK: pp 87.

- Ritter, W & Ruttner, F (1980) Neue Weg in der Behandlung der Varroatose. *Allgemeine Deutsche Imkerzeitung* 14: 151-157.
- Ritter, W (1981) Varroa disease of the honeybee *Apis mellifera*. *Bee World* 62: 141-153.
- Rosenkranz, P (1987) Thermobehandlung verdeckelter Arbeiterinnenbrutwaben als Möglichkeit der Varroatose-Kontrolle. *Apidologie* 18: 385-388.
- Sakoski, F, Koeniger N & Fuchs, S (1990) Seasonality of honey bee colony invasion by *Varroa jacobsoni* Oud. *Apidologie* 21: 547-550.
- Schneider, P & Drescher, W (1987) Einfluss der Parasitierung durch die Milbe *Varroa jacobsoni* Oud. auf das Schlupfgewicht, die Gewichtsentwicklung, die Entwicklung der Hypopharynxdrüsen und die Lebensdauer von *Apis mellifera* L. *Apidologie* 18: 101-110.
- Steiner, J, Dittmann, F, Rosenkranz, P & Engels, W (1994) The first gonocycle of the parasitic mite (*Varroa jacobsoni*) in relation to pre-imaginal development of its host, the honey bee (*Apis mellifera carnica*). *Invertebrate Reproduction and Development* 25: 175-183.
- Wiegiers, F P (1988) Transmission of honey bee viruses by *Varroa jacobsoni* Oud. In Cavalorro, R (editor) *European research on varroatosis control. Proceedings of a meeting of the EC experts' group, Bad Homburg, 15-17 October 1986. A.A. Balkema for the Commission of the European Communities* Rotterdam, The Netherlands, pp 99-104.

Effective biotechnical control of *Varroa* mites: Applying knowledge on brood cell invasion to trap honey bee parasites in drone brood

Abstract

Biotechnical methods of *Varroa* mite control are based on the idea that mites inside brood cells are trapped and can then easily be removed from a honey bee colony. Trapping is most efficient using drone brood in otherwise broodless colonies. In theory, one trap-comb with drone brood is enough to achieve control. We designed and tested two methods using trap-combs with drone brood. In the first experiment, effectiveness of the control method varied considerably, from 67% to 96%. However, the observed effectiveness in each separate colony was similar to the prediction based on knowledge of behaviour of mites invading into brood cells. Effectiveness depended on the number of drone cells that had been available for mite trapping. In the second experiment, we adjusted the method to improve production of trap-combs with drone brood, since this appeared to be crucial for trapping efficiency. The observed effectiveness of 93.4 % demonstrates that trap-combs with drone brood can effectively trap mites, thereby offering a non-chemical method of *Varroa* mite control. The use of knowledge on invasion behaviour of mites for evaluating of trap-comb methods and modelling of *Varroa* population dynamics is discussed.

Introduction

The *Varroa* mite, *Varroa jacobsoni* Oud., is a parasite of the Western honey bee, *A. mellifera* L.. Both adult bees and brood are parasitised. Reproduction, however, occurs only inside capped brood cells (Ifantidis, 1983; Steiner et al., 1994; Martin, 1994 & 1995). Hence, female mites have to leave adult bees and invade brood cells. Brood cells are attractive to the mites starting two days before capping by the bees (Ifantidis, 1988; Boot et al., 1992). Mites and their offspring leave brood cells jointly with the emerging young bees.

Varroa mites have several harmful effects on honey bees. Parasitised bees have a lower birth weight, a shortened life span and may have malformations (De Jong et al., 1982; Schneider & Drescher, 1987; Kovac & Crailsheim, 1988; Beetsma et al., 1989). In addition, mites act as vectors of honey bee pathogens and increase the incidence of honey bee diseases (Wieggers, 1988; Ball, 1994). Consequently, without mite control bee colonies usually perish within a few years after infestation (Ritter, 1981).

Yearly acaricide treatments of colonies effectively reduce mite populations (Koeniger & Fuchs, 1988), but have the disadvantages of contaminating bee products (Hansen & Petersen, 1988; Buren et al., 1992; Lodesani et al., 1992; De Greef et al., 1994) and selecting for acaricide resistance (Milani, 1994; Lodesani et al., 1995). Organic acids like formic, lactic and oxalic acid can also be successfully applied to control *Varroa* mites (Ritter & Ruttner, 1980; Fries, 1989; Bolli et al., 1993; Kraus & Berg, 1994; Imdorf et al., 1997). These acaricides are safer for the environment than synthetic acaricides that are most often applied, because residues quickly degrade. Moreover, these organic acids are natural constituents of honey bee products (Crane, 1975). However, contamination may still occur (Hansen & Guldborg, 1988), and, due to their corrosive nature, handling is not without risk.

Control of mite populations without application of chemicals is the most environmentally safe option and is feasible because mites can be trapped inside brood cells and removed from a colony. This principle is used in biotechnical mite control methods, where mites are trapped in a few brood combs which are subsequently destroyed

(Maul et al., 1988; Fries & Hansen, 1993). The effectiveness of these methods depends on the fraction of mites that invade brood on trap-combs. The rate of invasion of mites into brood cells is proportional to the ratio between the number of attractive brood cells and the number of bees in a colony (Boot et al., 1993, 1994a, 1994b, 1995b). Therefore, the effectiveness of trap-comb techniques is related to the number of brood cells used for mite trapping.

Originally, trap-comb methods used as little brood as possible to trap the mites, because the trap-combs were destroyed and beekeepers wanted to limit brood destruction. However, brood used for trapping can be retained, because trapped mites can be selectively killed by both high temperature treatment (Rosenkranz, 1987; Engels, 1994) and formic acid treatment (Fries, 1991). Selectively killing mites inside brood cells opened ways to improve trap-comb methods because an unrestricted amount of brood can be used to trap mites. If worker brood is used for trapping, however, these methods are labour intensive because large numbers of brood cells have to be used for sufficient *Varroa* control (Calis et al., 1993; Calis et al., 1999). This disadvantage of the trap-comb method may be largely circumvented if drone brood is used for trapping, because generally many more mites are found per drone cell than per worker cell (Sulimanovic et al., 1982; Schulz, 1984; Fuchs, 1990). The invasion rate of mites into drone brood cells is almost twelve times higher compared to worker brood cells (Boot et al., 1995b).

Usually, trap-combs with drone brood are used in colonies with a brood nest (Schulz et al., 1983; Engels et al., 1984). The presence of brood other than on the trap-combs will decrease their trapping efficiency for two reasons. Firstly, the majority of the mites will be inside brood cells (Fuchs, 1985), and they cannot be trapped until their hosts emerge. Secondly, brood of the original brood nest is also attractive to the mites and will compete with trap-combs. Therefore, trap-combs will be much more effective if they are used in broodless colonies. This principle is used by some beekeepers (Jenter, 1986; Dung et al., 1997), who inspired us to study trap-combs with drone brood more closely. Broodless conditions typically occur during periods when beekeepers employ swarm-prevention or colony-multiplication methods. These broodless conditions provide opportunities for effective mite trapping. Theoretically, only about 500 drone cells per kg of bees are needed to trap more than 95% of the mites in a broodless colony (Boot et al., 1995b), and this makes trapping of mites with drone brood potentially an effective non-chemical method for *Varroa* mite control.

In this study our aims were twofold. Firstly, to design and test control methods using trap-combs with drone brood that are of practical value for non-chemical *Varroa* control. Secondly, to test whether observations on brood cell invasion behaviour (Boot et al., 1995b) can be used to predict the effectiveness of trap-comb methods using drone brood. The effectiveness of trap-comb methods using worker brood could be predicted with a model based on the rate of invasion, and its relation to the number of brood cells that are being capped per bee (Calis et al., 1999). In this study we extended the model with the presence of drone brood.

We performed two experiments. In the first experiment, we counted numbers of brood cells on both trap-combs and normal combs, and measured colony sizes to predict the relative number of mites trapped. This prediction was compared with the observed effectiveness of the trap-comb method applied. In the second experiment, the method was adjusted by improving drone brood production, since control of drone brood production appeared to be crucial for successful trapping.

Material and Methods

Honey bees, mites and trap-combs

The commonly found honey bee in the Netherlands, a hybrid from various races imported over the years, was used in our experiments. Colonies were kept in 10-frame hives in two storeys. To obtain a substantial mite infestation, colonies were either untreated against *Varroa* mites for at least one year (experiment 1) or infested with *Varroa* mites by the introduction of bees and brood from other infested colonies (experiment 2). Trap-combs were built by the bees from drone-comb-foundation sheets. The trap-combs were removed from the colony after capping and reused after sampling and cleaning. Combs were cleaned by uncapping the drone brood with a knife and shaking the pupae out of the cells. Subsequently, the remaining parts of pupae were washed out of the comb with a jet of water and the drone combs were stored dry until reuse, to prevent growth of fungi.

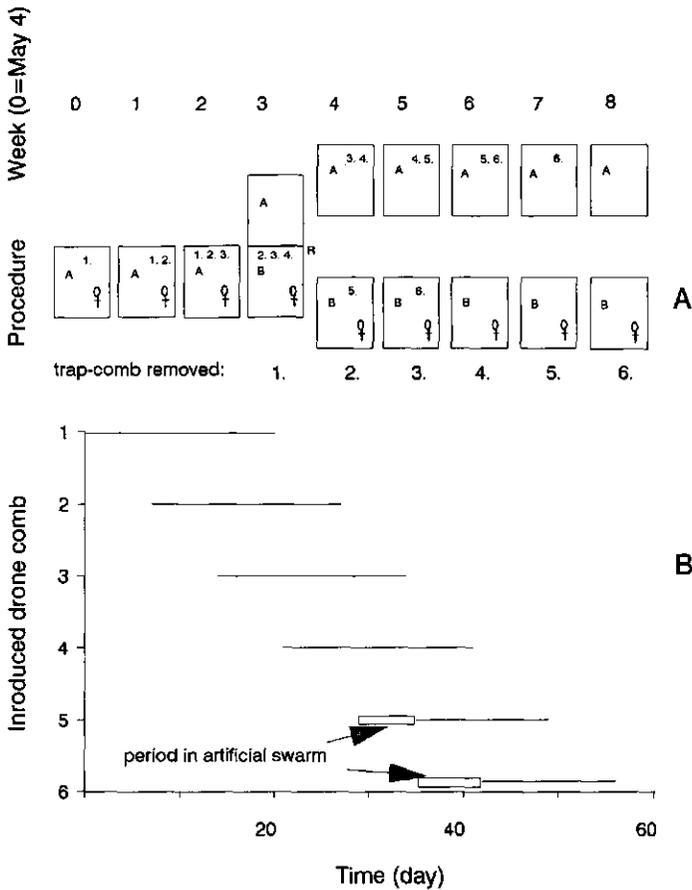

Figure 1. Design of experiment 1. A: Schedule of the *Varroa* control procedure using trap-combs with drone brood. The squares represent (parts of) hives. Indicated are the queen, the subsequently introduced trap-combs (numbers 1 to 6) and the moment of removal; B: Presence of the trap-combs in the colonies during the experiment.

Experiment 1

Outline

We trapped mites with drone combs in ten colonies. In total, six empty trap-combs were introduced per colony at weekly intervals (Figure 1). Before splitting the colonies, trap-combs had been introduced four times. One week before splitting the colonies (Figure 1, week 3), the queens were placed below a queen excluder in a brood chamber with empty combs. After one week, the colonies were split in a queenless part with old brood and an artificial swarm with the queen and young brood. The queenless parts, where new queens were reared, became broodless due to the development of the brood. The fifth and sixth drone comb were introduced into the artificial swarms to prepare trap-combs. These final two trap-combs were transferred from the artificial swarms to the queenless part after one week, and trapped mites under broodless conditions. The trap-combs were removed 20 days after introduction, when the majority of the drone brood cells were capped. The effectiveness of the control method was determined and compared with model predictions of the effectiveness.

Effectiveness of the trapping method

To estimate the number of mites trapped in the trap-combs, every fifth brood cell on the rows of drone cells was opened and the number of mites trapped inside was counted. At the end of the experiment, mites left behind in the colonies were killed by two *Perizin* treatments and collected from a drawer underneath the gauze bottom of the hive. The effectiveness of the trapping method was calculated as the percentage of trapped mites from the total number of mites trapped and collected after acaricide treatment.

Colony weight and the number of brood cells

The total weight of the bees in the colonies, was determined by weighing the hives with bees and without bees. Hive entrances were closed during darkness and the hives were weighed in the morning. After the bees had been removed, the hives were weighed again. Subsequently, the bees were returned to their hives.

The number of drone brood cells that were capped on each trap-comb was counted after removal from the colony. The number of brood cells capped on other combs was assessed weekly. A grid divided into areas corresponding with 100 cells was used for quick estimation of the number of capped worker brood cells. This to ensure a short handling time of the combs outside the colonies. The drone cells, being much lower in number, were counted individually.

Prediction of mites trapped and left in the colonies

Boot et al. (1995b) derived empirical relationships between the invasion rate of mites into brood cells (r_w and r_d for worker and drone brood respectively) and the ratio of the number of available cells (number of cells capped per day) to the number of adult bees. These relationships have the following form:

$$r_w = 0.56C_w/W$$

and

$$r_d = 6.49C_d/W$$

where C_w and C_d are the number of available worker and drone brood cells respectively and W is the weight in grams of adult bees in the colony. The numbers of brood cells available for mite invasion (i.e. the numbers of brood cells capped per day) were derived from the counts of brood cells in both the combs of the brood nest and the trap-combs. Depending on the weight of the colony, a specific number of brood cells that are being capped during one day are invaded by:

$$M_i = M_0(1 - \exp(-(r_w + r_d)))$$

where M_0 is the number of phoretic mites and M_i is the number of mites entering brood cells on that day. Invading mites are divided over worker and drone brood in proportion to the quantities $r_w/(r_w+r_d)$ and $r_d/(r_w+r_d)$ respectively (Boot et al., 1995b). In the trap-comb model mites invade drone brood cells on trap-combs or brood cells of the brood nest (Figure 2, arrows 1,3 & 5). In the first case, the mites are trapped and removed from the colony (Figure 2, arrow 6). In the latter case, the mites emerge from the brood cells after the postcapping stage of the brood cell (Figure 2, arrows 2 & 4). Simplifying the mite's reproductive success in brood cells, we assume that 2 and 3 times the number of invaded mites emerge from worker- and drone brood cells, respectively. Using colony size and numbers of brood cells in brood nest combs and trap-combs only, the flows of mites into and from brood cells and the relative number of mites trapped was predicted.

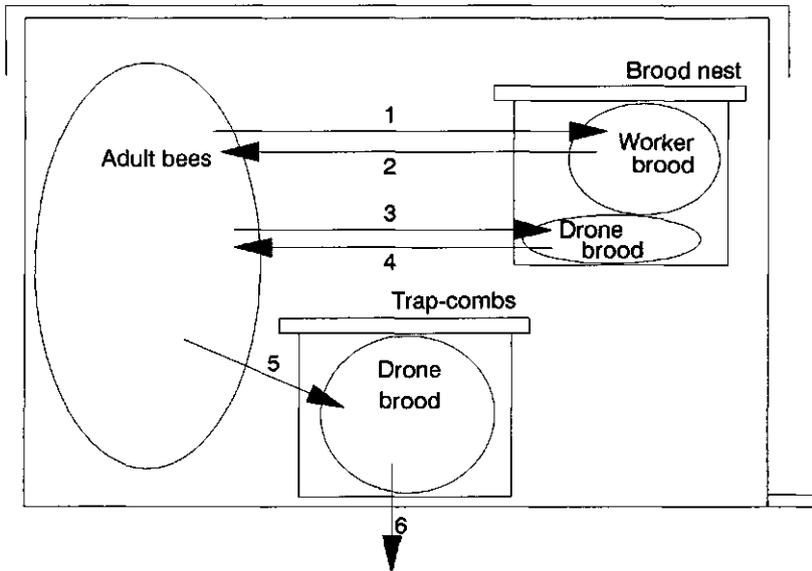

Figure 2. Mite transfer between brood and bees. Arrows 1,3,5: invasion of mites into brood cells; Arrows 2,4: emergence of mites from brood cells; Arrow 6: removal of trapped mites.

The distribution of mites over bees, worker and drone brood at the start of mite trapping was unknown. If numbers of worker brood cells, drone brood cells and adults bees are constant, the equations for brood cell invasion can be used to calculate the distribution of mites. Here, we used an imaginary bee colony having a brood cell/bee ratio of 1, whereas 8% of its brood cells contains drone brood and the calculated distribution of mites over worker brood, drone brood and adult bees was: 33:43:24 (%), respectively (Boot et al., 1995c). Mites were assumed to emerge at a constant rate from the capped brood that was present at the start of trapping of the mites.

Sensitivity analysis of the model

The sensitivity of the model to changes in parameters was examined by comparing the predicted number of mites trapped in trap-combs containing various numbers of capped drone cells per trap-comb in imaginary colonies (see: Figure 6). As the total weight of the bees we used 5 kg (approximately 40.000 bees) and for the brood cell/bee ratio we used 1, whereas 8 % of the brood cells were assumed to contain drone brood. The predicted number of mites trapped was calculated for this setting, and when one of the following parameters was changed:

- Increased reproductive success by increasing the number of emerging mites per mite that invaded before to 5 for both cell types.
- Increased invasion into cells of the brood nest by doubling the number of brood cells.
- Reduced invasion into trap-combs by assuming that only the final trap-comb was used instead of the 6 trap-combs in total.

Experiment 2

Outline

In the second experiment, mite trapping with drone combs was performed in pairs of colonies (Figure 3). In total five pairs were used. Colonies were inspected and manipulated at intervals of one week. Initially, colonies of each pair were managed similarly. As in experiment 1, drone combs (here on average two) were introduced and removed when other brood was present. Subsequently, another drone comb was placed in the middle of the brood nest (Figure 3, week 0). From this moment on, the colonies of a pair were managed differently. After one week, one colony of a pair (colony 1) was made broodless by transferring all the combs with brood, but without bees, to the other colony (colony 2; Figure 3, week 1). Only the trap-comb introduced one week earlier and now containing open drone brood, was left in colony 1 to trap the mites from the bees. Colony 2 now contained a double brood nest. In addition, the queen in colony 2 was placed above a queen excluder in a brood chamber with empty combs. After another week, mites that had remained on the bees in colony 1 after brood removal, had invaded the newly capped trap-comb which could than be removed from the colony (Figure 3, week 2). A new trap-comb, prepared in colony 1, was used to trap mites from the bees in the broodless but queen right artificial swarm that was obtained by splitting from colony 2. The newly produced brood of colony 2 was still too young to be invaded by mites and was safely transferred without bees and mites to colony 1. A new queen was reared in colony 2. This colony 2 became broodless within two more weeks. During this broodless condition, mites were trapped with trap-combs with drone brood that had been produced in colonies 1.

Increased experience with drone brood trap-combs led to the development of simplified methods (Calis et al., 1997).

Control trial

Five other colony pairs were managed similarly, except that no trap-combs with drone brood were introduced and removed.

Colony 1

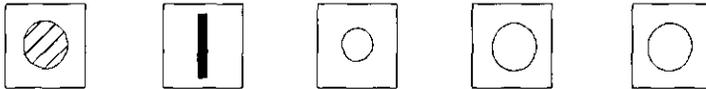

Colony 2

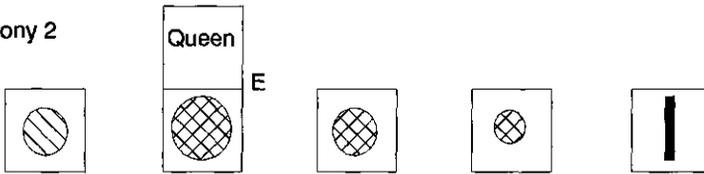

Artificial swarm of colony 2

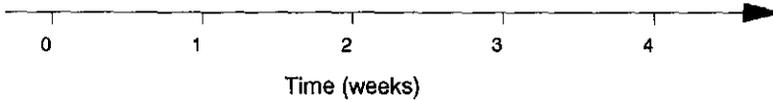
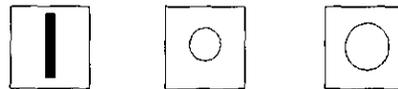

-  Brood of colony 1
-  Brood of colony 2
-  Brood of colony 1&2
-  New brood
-  Queen excluder
-  Trap-combs with drone brood

Figure 3. Design of experiment 2: Schedule of the *Varroa* control procedure using trap-combs with drone brood. The squares represent hives. Indicated are the position of the queen, the brood and the trap-combs.

Effectiveness of the trapping method

The number of trapped mites was estimated in the same way as in experiment 1, except that every tenth, instead of fifth, brood cell was opened. When the final trap-combs were removed from the colonies, mites left behind in the colonies and the artificial swarms were killed by *Apistan* treatment and collected. The effectiveness of the trapping method was calculated similar to experiment 1.

Mite invasion into the trap-comb colonies from other colonies

Mite invasion into the colonies was investigated from the start of the *Apistan* treatment. Four mite-free colonies, continuously treated with *Apistan*, were placed between the trap-comb colonies, to monitor mites that invade the colonies. Killed mites were counted.

Results

Experiment 1

Observed and predicted effectiveness of the control method

The observed numbers of mites trapped or left behind in the colonies (Table 1) was well predicted by the model, although the numbers trapped varied largely between colonies. To illustrate this for two colonies with respectively the highest and the lowest relative number of mites trapped in the drone cells, we show the observed and predicted number of mites present in the colonies and trap-combs in the course of the experiment (Figure 4). Since the model allows mites to reproduce inside the brood cells of the brood nest, the initial number of mites present in the colony is predicted to be about 30% of the number of mites finally recovered from the colonies. During the experiment the observations of the distribution of mites over trap-combs and bees are similar to the predictions, which are based on numbers of brood cells and colony sizes (Figure 4 A & B). The number of capped brood cells decreases in the queenless part of the colonies as a consequence of the removal of the queen with the artificial swarms (figure 4 C & D). In colony no. 1 (3381 gram bees) all six trap-combs contain drone brood (figure 4 D). In total 6116 drone brood cells trapped 10663 mites (96.2 %), whereas 374 (3.4 %) remained in the artificial swarm (838 gram bees) of the colony and 43 (0.4 %) remained in the colony. In colony no. 10 (2080 gram of bees) only the first 4 trap-combs contained drone brood (Figure 4 C). In total 1703 drone brood cells trapped 2013 mites (66.5 %, on average the first four trap combs contained 72 % of the mites), whereas 109 (3.6 %) remained on the bees in the artificial swarm (466 gram bees) and 905 mites (29.9 %) remained in the colony.

Also for the other colonies, the observed final distribution of mites over drone cells on the trap-combs, over the bees in the artificial swarm and over the bees in the colony are quite similar to the predicted distributions (Figure 5). When all 6 trap-combs contained drone brood less than 2.5% of the mites were left in the colonies. This occurred only in 3 of the 10 colonies, however. Production of drone brood in the last two trap-combs introduced into the artificial swarms was unsuccessful in the other 7 colonies, resulting in a higher percentage of mites that stayed in the colonies.

Table 1. Summary of data from experiment 1.

Colony characteristics	Average (n=10)	Range (min-max)
Colony weight (gram)	3293	2077-4861
Initial number of capped worker cells	11370	7800-14100
Initial number of capped drone cells	356	86-671
Artificial swarm weight (gram)	718	463-959
Capped drone cells on trap-combs	2830	1080-6116
Mites trapped in drone brood	4437	1439-10663
Mites left in colony (Perizin)	594	43-1218
Mites left in swarm (Perizin)	366	109-687

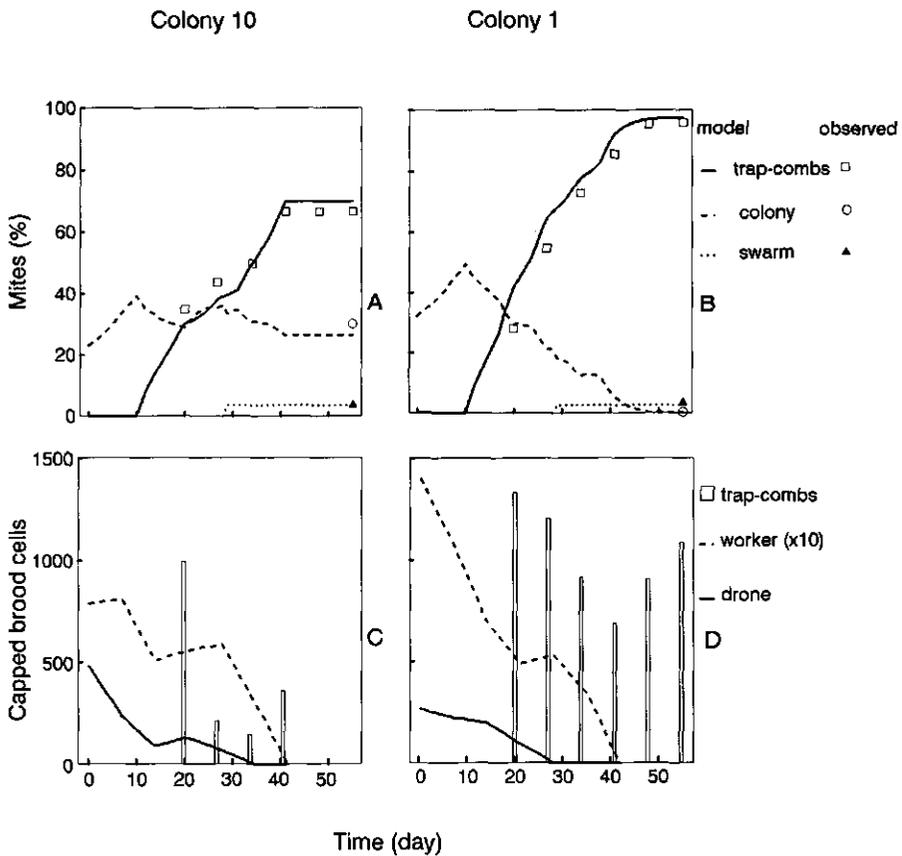

Figure 4. Experiment 1. For the two colonies in which the lowest (colony 10) and highest (colony 1) relative number of trapped mites was observed, the following variables are indicated: (A & B) The observed and predicted percentages of mites left in the colonies, and in the artificial swarms and cumulative percentage of mites trapped in the drone brood on the trap-combs; (C & D) The numbers of capped worker and drone brood cells in the brood nest (lines) and the number of capped drone brood cells on the removed trap-combs (bars).

Sensitivity analysis of the model

Predictions on trapping efficiency hardly changed when the numbers of mites emerging per mite that invaded before was increased to 5 and when the numbers of brood cells in the colony were doubled, although population growth may be importantly affected. When only the final trap-comb is applied, the predicted number of trapped mites was clearly lower, because this implies that a six times lower number of drone cells is used for trapping. However, the effectiveness of this comb that traps under broodless conditions is relatively high (Figure 6).

Experiment 2

Trap-comb method

In each pair of colonies, artificial swarms included, on average 14010 drone brood cells were capped in the trap-combs.

In these combs 93.4 % of all the mites were trapped, whereas 6.6 % remained on the bees. In colonies 1, colonies 2 and in the artificial swarms, respectively 30.4 %, 60.7 % and 2.2 % of all the mites were trapped. In colonies 1 and 2 and the artificial swarms, 41 (2.5 %), 50 (3.1 %) and 17 (1.0 %) mites stayed behind, respectively (Table 2; Figure 7).

Table 2. Summary of data from experiment 2.

Colony characteristics	Colony 1 (n=5) Average and (Range)	Colony 2 (n=5)	Swarm (n=5)
Capped drone cells on trap-combs	5521 (2963-8811)	7031 (5878-10228)	1458 (457-2395)
Mites trapped in drone brood	495 (200-655)	988 (429-1706)	37 (20-60)
Mites left in colonies (<i>Apistan</i>)	41 (2-74)	50 (8-128)	17 (4-31)

Control experiment

In each pair of control colonies, including artificial swarms, we collected on average 959 mites from the drawers after *Apistan* treatment. In colonies 1 of each pair we found on average 70 (7.3 %) mites. In colonies 2 we found on average 587 (61.2 %) mites and in the artificial swarms we found on average 302 (31.5 %) mites (Figure 7).

Mite invasion into the experimental colonies from other colonies

During the *Apistan* treatment of the colonies in experiment 2, on average 5 mites were collected from the drawers of four mite-free control colonies.

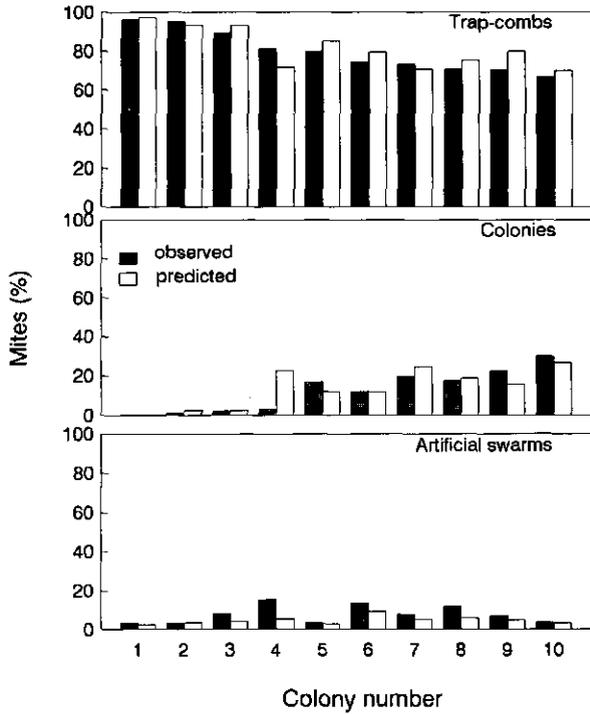

Figure 5. Experiment 1. Observed versus predicted final distribution of mites over colonies, artificial swarms and trap-combs with drone brood.

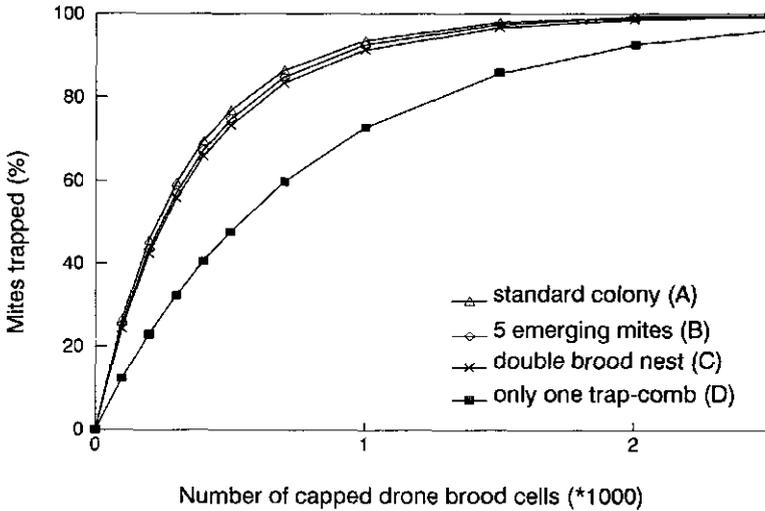

Figure 6. Sensitivity analysis of the model. A: Standard colony (see text); B: for a colony where 5 mites emerge per invaded mite; C: for a colony which brood nest contains twice the amount of brood cells. D: for a colony where only one final trap-comb with drone brood has been capped.

Discussion

Trapping mites with drone brood

To reach an effectiveness equal to e.g. a Perizin treatment (i.e. about 95%), a relative drone brood cell invasion rate (r_d) of $-\ln(0.05) = 3.0$ per time unit is needed (time unit reflects the period during which mites are trapped). This requires $3.0/0.00649 = 462$ drone brood cells for mite trapping in a colony of 1 kg of bees, provided no other brood is present. Since this number of drone brood cells is low, drone brood trap methods seem practically feasible. Mite trapping during broodless conditions is most efficient. Broodless conditions occur as a consequence of swarm-prevention-techniques. Therefore, we integrated mite trapping in drone brood with splitting colonies as swarm-prevention-technique.

In experiment 1, we expected that trap-combs applied before splitting of the colonies ensured a low density of mites on bee. Since the percentage of mites present in the artificial swarms varied greatly (Figure 5) and was 6.8 % of all mites (Table 1), however, additional treatment of the artificial swarms seems necessary. The artificial swarms often failed to produce trap-combs with drone brood, probably because the swarms were too small. Consequently, 11.0 % of all mites remained on the bees in the broodless colonies. Using large colonies, Schmidt-Bailey et al. (1996) showed that splitting colonies and producing drone brood in the artificial swarms may well be a successful trap-comb method.

Experiment 1 and our model showed that effectiveness of trap-combs strongly depends on the number of drone brood cells that are capped (Figure 6). Based on experiences in experiment 1, we carried out a next experiment partly modified to improve drone brood production and trapping effectiveness. Firstly, we maintained early application of trap-combs (i.e. before colony splitting), since experiment 1 and our model (Figure 4) showed that these combs reduce the mite population considerably. This is in agreement with work performed by Fries & Hansen (1993). They removed drone brood combs prior to a trap-comb method with worker brood, which drastically improved mite control. Unless mite-density is known to be low, we recommend to maintain one drone brood trap-comb per colony from the first colony inspection in spring until colony splitting. Secondly, we combined trapping of mites in pairs of colonies to secure a large colony size. By transferring brood of one colony to another colony, a large broodless colony and a colony with more brood was obtained. Indeed, the bees produced large numbers of drone brood cells in the trap-combs that successfully trapped mites (Table 2).

Transferring brood from one colony to another has two effects on mite control. Firstly, removal of brood is in itself a mite control method, since most mites reside in brood cells. This is shown by the relatively low percentages of all recovered mites that were found in colonies 1 in both the trap-comb and control trial. Secondly, mites were concentrated in colonies 2, because all the mites present in the brood of colonies 1 were added. This is illustrated by the relatively high percentages of mites that were found in colonies 2 in both the trap-comb and control trial.

Mite trapping in the artificial swarms was less crucial than seemed in experiment 1. Due to the large number of drone brood cells in the trap-combs, density of mites on bees was apparently low. In experiment 2, we found only 3.1% of the mites in the artificial swarms of the trap-comb trial.

Beekeepers often object against trap-comb methods because of extra time needed for colony management. However, by integrating drone brood trap-combs with swarm-prevention-techniques the extra time needed is limited. In experiment 2, management of the trap-comb colonies took, a similar amount of time compared to the management of the control colonies. The extra work consisted of management of the drone combs.

The effectiveness of the method

The effectiveness of the trap-comb methods was 83.4% and 93.4% on average for experiment 1 and 2, respectively. How accurate are these figures? If we assume that the number of mites on the drawer after acaricide treatment is an accurate estimate of the number of mites that was left in the colony, the effectiveness may be underestimated for three reasons. Firstly, mites may have re-infested the trap-comb colonies (Sakofski et al., 1990). Secondly in experiment 2, mites that stayed behind after mite trapping reproduced until the *Apistan* treatment. Finally, trapping occurred during a period of several weeks. Mites that have been trapped early, clearly missed the opportunity to reproduce. Considering an undisturbed mite population, the calculated effectiveness will underestimate the reduction of the population size. The average effectiveness observed of 93.4% is slightly lower than our arbitrarily chosen aim of 95%, but probably high enough for successful *Varroa* control. At the apiary of the Wageningen Agricultural University, *Varroa* control in all non-experimental colonies (approximately 70 colonies) was performed with drone brood trap-combs for 5 successive years, and appeared an effective non-chemical control method.

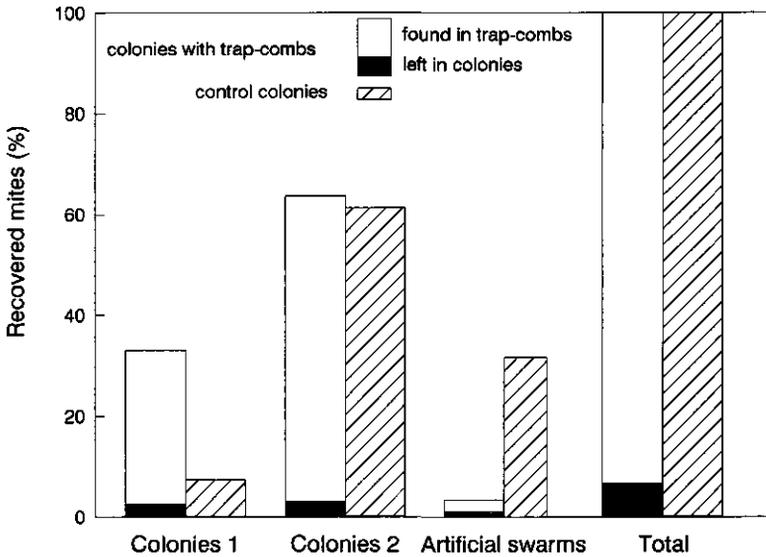

Figure 7. Experiment 2. Final distribution of mites over trap-combs and the bees.

Using knowledge on invasion of mites into brood cells

Knowledge on invasion behaviour of mites was successfully used to predict the effectiveness of the control method. Therefore, our model can be used to evaluate control scenarios embedded in a diversity of bee-management-systems.

Since brood cell invasion is crucial for mite reproduction, knowledge on brood cell invasion also helps modelling *Varroa* population dynamics in a broader sense. Boot et al. (1995c), used knowledge on brood cell invasion to calculate population growth as a fitness measure to study under which circumstances reproductive specialisation on drone brood would be a better reproductive strategy. The model by Fries et al. (1994) predicting *Varroa* population dynamics over a number of years, however, uses a constant rate of brood cell invasion independent of amount and type of brood, and colony size. Knowledge on brood cell invasion, used similar to our trap-comb model, may allow more realistic modelling of *Varroa* populations.

Acknowledgements We thank M Beekman, JC van Lenteren, MW Sabelis, the members of our PhD-study group and two anonymous referees for their valuable comments on various drafts of the manuscript. This study was partly supported by the Technology Foundation (STW), grant number: WGB88.1512.

References

- Ball, B V (1994) Host-Parasite-Pathogen interactions. In Matheson, A (editor) *New perspectives on Varroa*. IBRA, Cardiff, UK: pp 5-11.
- Beetsma, J, De Vries, R, Emami Yeganeh, B, Emami Tabrizi, M & Bandpay, V (1989) Effects of *Varroa jacobsoni* Oud. on colony development, workerbee weight and longevity and brood mortality. In Cavalloro, R (editor) *Present status of Varroa infestation in Europe and progress in the Varroa mite control: proceedings of a meeting of the EC expert's group, Udine, Italy, 28-30 November 1988, Commission of the European Communities, Luxembourg*, pp 163-170.
- Bollí, H K, Bogdanov, S, Imdorf, A & Fluri, P (1993) Zur Wirkungsweise von Ameisensäure bei *Varroa jacobsoni* Oud. und der Honigbiene (*Apis mellifera* L.). *Apidologie* 24: 51-57.
- Boot, W J, Calis, J N M & Beetsma, J (1992) Differential periods of *Varroa* mite invasion into worker and drone cells of honey bees. *Experimental & Applied Acarology* 16: 295-301.
- Boot, W J, Calis, J N M & Beetsma, J (1993) Invasion of *Varroa jacobsoni* into honey bee brood cells: a matter of chance or choice? *Journal of Apicultural Research* 32: 167-174.
- Boot, W J, Beetsma, J & Calis, J N M (1994a) Behaviour of *Varroa* mites invading honey bee brood cells. *Experimental & Applied Acarology* 18: 371-379.
- Boot, W J, Sisselaar D J A, Calis, J N M & Beetsma, J (1994b) Factors affecting invasion of *Varroa* mites into honey bee brood cells. *Bulletin of Entomological Research* 84: 3-10.
- Boot, W J, Calis, J N M & Beetsma, J (1995a) Does time spent on adult bees affect reproductive success of *Varroa* mites? *Entomologia Experimentalis et Applicata* 75: 1-7.
- Boot, W J, Schoenmaker, J, Calis, J N M & Beetsman, J (1995b) Invasion of *Varroa* mites into drone brood cells of the honey bee. *Apidologie* 26: 109-118.
- Boot, W J, Baalen, M Van & Sabelis, M W (1995c) Why do *Varroa* mites invade worker brood cells of the honey bee despite lower reproductive success? *Behavioral Ecology and Sociobiology* 36: 283-289.
- Buren, NWM van, Mariën, J, Velthuis, HHW & Oudejans, RCHM (1992) Residues in beeswax and honey of perizin, an acaricide to combat the mite *Varroa jacobsoni* Oudemans (Acari: Mesostigmata). *Environmental Entomology* 21: 860-865.
- Calis, JNM, Boot, WJ, Eijnde, JHPM van den & Ruijter, A de (1993) Control of the *Varroa* mite by treatment of sealed honeybee brood with formic acid. *Proceedings of the section Experimental and Applied Entomology of the Netherlands Entomological Society (NEV), Amsterdam, The Netherlands* 4: 217-222.

- Calis, JNM, Schmidt-Baily, J, Beetsma, J, Boot, WJ, Eijnde, JHPM van den, Fuchs, S, Ruijter, A de & Steen, JJM van der (1997) Successful trapping of *Varroa jacobsoni* with drone brood in broodless *Apis mellifera* colonies. *Apiacta* 32: 65-71.
- Calis, J N M, Beetsma, J, Boot, W J, Eijnde, J H P M Van Den, Ruijter, A de & Steen, J J M van der (1999) Control of *Varroa* mites by combining trapping in honey bee worker brood with formic acid treatment of the capped brood outside the colony: Putting knowledge on brood cell invasion into practice. (Chapter 2), *Journal of Apicultural Research* 37: 205-215.
- Crane, E (1975) Honey- a comprehensive survey. Heinemann, London, UK
- De Greef, M, Wael, L de & Laere, O van (1994) The determination of the fluvalinate residues in the Belgian honey and beeswax. *Apiacta* 29: 83-87.
- De Jong, D, De Jong, P H & Goncalves, L S (1982) Weight loss and other damage to developing worker honeybees from infestation with *Varroa jacobsoni*. *Journal of Apicultural Research* 21: 165-167.
- Dung, N.V, Tan, N Q, Huan, L V & Boot, W J (1997). Control of honey bee mites in Vietnam without the use of chemicals. *Bee World* 78: 78-83.
- Engels, W, Rosenkranz, P, Herlt, F & Staemmler, G (1984) Biologische *Varroa*-Kontrolle durch Drohnenbrutentnahme. *Apidologie* 15: 246-248.
- Engels, W (1994) *Varroa* control by hyperthermia. In: Matheson, A (editor) *New perspectives on Varroa*. IBRA, Cardiff, UK, pp 115-119.
- Fries, I (1989) Short-interval treatments with formic acid for control of *Varroa jacobsoni* in honey bee (*Apis mellifera*) colonies in cold climates. *Swedish Journal Agricultural Research* 19: 213-216.
- Fries, I (1991) Treatment of sealed honeybee brood with formic acid for control of *Varroa jacobsoni*. *American Bee Journal* 131: 313-314.
- Fries, I & Hansen, H (1993) Biotechnical control of *Varroa* mites in cold climates. *American Bee Journal* 133: 435-438.
- Fries, I, Camazine, S & Sneyd, J (1994) Population dynamics of *Varroa jacobsoni*: a model and a review. *Bee World* 75: 5-28.
- Fuchs, S (1985) Untersuchungen zur Quantitativen Abschätzung des Befalls von Bienenvölkern mit *Varroa jacobsoni* Oudemans und zur Verteilung des Parasiten im Bienenvolk. *Apidologie* 16: 343-368.
- Fuchs, S (1990) Preference for drone brood cells by *Varroa jacobsoni* Oud. in colonies of *Apis mellifera carnica*. *Apidologie* 21: 193-199.
- Hansen, H & Guldborg, M (1988) Residues in honey and wax after treatment of bee colonies with formic acid. *Tidsskr. Planteavl.* 92: 7-10.
- Hansen, H & Petersen, J H (1988) Residues in honey and wax after treatment of bee colonies with bromopropylate. *Tidsskr. Planteavl.* 92:1-6.
- Ifantidis, M D (1983) Ontogenesis of the mite *Varroa jacobsoni* in worker and drone honeybee brood cells. *Journal of Apicultural Research* 22: 200-206.
- Ifantidis, M D (1988) Some aspects of the process of *Varroa jacobsoni* mite entrance into honey bee (*Apis mellifera*) brood cells. *Apidologie* 19: 387-396.
- Imdorf, A, Charriere, J D & Bachofen, B (1997) Efficiency checking of the *Varroa jacobsoni* control methods by means of oxalic acid. *Apiacta* 32: 89-91.
- Jenter, K (1986) Mit gezielter biologischer Frühjahrs-Sommer-Behandlung gegen die *Varroa*. *Allgemeine Deutsche Imkerzeitung* 20: 111-114.
- Koeniger, N & Fuchs, S (1988) Control of *Varroa jacobsoni*: current status and developments. In: Needham, G R, et al. (editors) *Africanized honeybees and bee mites*. Ellis Horwood Limited, Chichester, pp 360-369.
- Kovac, H & Crailsheim, K (1988) Lifespan of *Apis mellifera carnica* pollm. infested by *Varroa jacobsoni* Oud. in relation to season and extent of infestation. *Journal of Apicultural Research* 27: 230-238.
- Kraus, B & Berg, S (1994) Effect of a lactic acid treatment during winter in temperate climate upon *Varroa jacobsoni* Oud. and the bee (*Apis mellifera* L.) colony. *Experimental & Applied Acarology* 18: 459-468.

- Lodesani, M, Pellacani, A, Bergomi, S, Carpana, E, Rabitti, T & Lasagni, P (1992) Residue determination for some products used against *Varroa* infestation in bees. *Apidologie* 23: 257-272.
- Lodesani, M, Colombo, M & Spreafico, M (1995) Ineffectiveness of Apistan treatment against the mite *Varroa jacobsoni* Oud. in several districts of Lombardy (Italy). *Apidologie* 26: 67-72
- Martin, S J (1994) Ontogenesis of the mite *Varroa jacobsoni* Oud. in worker brood of the honeybee *Apis mellifera* L. under natural conditions. *Experimental & Applied Acarology* 18: 87-100.
- Martin, S J (1995) Ontogenesis of the mite *Varroa jacobsoni* Oud. in drone brood of the honeybee *Apis mellifera* L. under natural conditions. *Experimental & Applied Acarology* 19: 199-210.
- Maul, V, Klepsch, A & Assmann-Werthmüller, U (1988) Das Bannwabenverfahren als Element Imkerlicher Betriebsweise bei starkem Befall mit *Varroa jacobsoni* Oud. *Apidologie* 19: 139-154.
- Milani, N (1994) Possible presence of fluvalinate-resistant strains of *Varroa jacobsoni* in northern Italy. In: Matheson, A (editor) *New perspectives on Varroa*. IBRA, Cardiff, UK, pp 87.
- Ritter, W & Ruttner, F (1980) Neue Weg in der Behandlung der Varroatose. *Allgemeine Deutsche Imkerzeitung* 14: 151-157.
- Ritter, W (1981) *Varroa* disease of the honeybee *Apis mellifera*. *Bee World* 62: 141-153.
- Rosenkranz, P (1987) Thermobehandlung verdeckelter Arbeiterinnenbrutwaben als Möglichkeit der Varroatose-Kontrolle. *Apidologie* 18: 385-388.
- Sakofski, F, Koeniger, N & Fuchs, S (1990) Seasonality of honey bee colony invasion by *Varroa jacobsoni* Oud. *Apidologie* 21: 547-550.
- Schmidt-Bailey, J, Fuchs, S & BÜchler, R (1996) Effectiveness of drone brood trapping combs in broodless honeybee colonies. *Apidologie* 27: 294.
- Schneider, P & Drescher, W (1987) Einfluss der Parasitierung durch die Milbe *Varroa jacobsoni* Oud. auf das Schlupfgewicht, die Gewichtsentwicklung, die Entwicklung der Hypopharynxdrüsen und die Lebensdauer von *Apis mellifera* L. *Apidologie* 18: 101-110.
- Schulz, A, Koeniger, N & Ruttner, F (1983) Drohnenbrut als Varroefalle. *Allgemeine Deutsche Imkerzeitung* 17: 52-54.
- Schultz, A E (1984) Reproduktion und Populationsentwicklung der parasitischen Milbe *Varroa jacobsoni* Oud. in abhängigkeit vom Brutzyklus ihres Wirtes *Apis mellifera* L. *Apidologie* 15: 401-420.
- Steiner, J, Dittmann, F, Rosenkranz, P & Engels W (1994) The first gonocycle of the parasitic mite (*Varroa jacobsoni*) in relation to pre-imaginal development of its host, the honey bee (*Apis mellifera carnica*). *Invertebrate Reproduction and Development* 25: 175-183.
- Sulimanovic, D, Ruttner, F & Pechacker H (1982) Studies on the biology of reproduction in *Varroa jacobsoni* (in Japanese). *Honeybee Science* 3: 109-112.
- Wieggers, F P (1988) Transmission of honey bee viruses by *Varroa jacobsoni* Oud. In Cavalorro, R (editors) *European research on varroatosis control. Proceedings of a meeting of the EC experts' group, Bad Homburg, 15-17 October 1986*. A.A. Balkema for the Commission of the European Communities Rotterdam, The Netherlands, pp 99-104.

Model evaluation of methods for *Varroa jacobsoni* mite control based on trapping in honey bee brood

Abstract

Biotechnical *Varroa* mite control methods are based on the principle that mites inside brood cells are trapped and can then easily be removed from a honey bee colony. Here, a validated trap-comb model based on work on invasion rate of mites into brood cells is used to estimate and compare effectiveness of different trap-comb methods. Trapping with worker brood is labour intensive because a large amount of brood is needed to trap a sufficient number of mites for effective control. In addition, trapping with worker brood requires subsequent treatment of the capped brood to selectively kill the mites, because beekeepers want to save the brood. Trapping with drone brood demands fewer brood cells for effective mite control, and destruction of drone brood with trapped mites is common practice. Moreover, preparation of trap-combs with drone brood can be integrated into swarm-prevention-techniques and will take little extra time.

Introduction

If the parasitic mite, *Varroa jacobsoni* Oud. (Acari: Varroidae), infests colonies of European honey bees (*Apis mellifera* L.), control measures are required to maintain healthy colonies. Acaricide treatment of colonies, as is practised world-wide, effectively diminishes mite populations (Koeniger et al., 1988), but may contaminate bee products (Buren et al., 1992; De Greef et al., 1994; Hansen & Petersen, 1988; Lodesani et al., 1992) and select for acaricide resistance (Lodesani et al., 1995; Milani, 1994). Environmentally safer acaricides like formic, lactic and oxalic acid can also be successfully applied to control *Varroa* mites (Bolli et al., 1993; Fries, 1989; Imdorf et al., 1997; Kraus & Berg, 1994; Ritter & Ruttner, 1980). However, contamination may still occur (Hansen & Guldborg, 1988), and due to their corrosive nature, handling is not without risk.

Control of mite populations without application of chemicals is the most environmentally safe option and is feasible because mites can be trapped inside brood cells and removed from a colony. This principle is used in biotechnical mite control methods.

Originally, trap-comb methods used as little worker brood as possible to trap the mites, because the trap-combs were destroyed and beekeepers wanted to limit brood destruction. Maul (1983) developed a system by which the queen is trapped in a cage that contains only one empty worker comb. The comb is replaced three or four times after 9 or 7 days, respectively. The combs along with the trapped mites are removed from the colony after capping. However, tests of this control system over several years showed that the level of mite populations continued to increase (Fries & Hansen, 1993; Maul et al., 1988).

Worker brood used for trapping can be saved, because mites trapped can be selectively killed by both high temperature treatment (Rosenkranz, 1987), and formic acid treatment of the brood combs outside the colony (Fries, 1991). Selectively killing mites inside brood cells has opened ways to improve trap-comb methods using worker brood, because an unrestricted amount of brood could be used to trap mites (Calis et al., 1998; Engels, 1994).

Trap-combs with drone brood can also be used for *V. jacobsoni* control. Generally, many more mites are found per drone cell than per worker cell (Fuchs, 1990; Schulz, 1984; Sulimanovic, 1982) and Boot et al. (1995) found that the invasion rate of mites into drone brood cells is about twelve times higher than the invasion rate into worker brood cells.

Trap-combs with drone brood have been used in colonies actively rearing brood (Engels et al., 1984; Schulz et al., 1983). Although population growth decreased in these colonies, effective control was not achieved probably due to the presence of other brood. Trap-comb efficiency is low in colonies rearing brood for two reasons. First, the majority of the mites will be inside brood cells (Fuchs, 1985), and they cannot be trapped until their hosts emerge. Second, the brood being reared by the colony in the non-trap-combs is also attractive to the mites and will compete with trap-combs. This insight promoted the use of trap-combs with drone brood in broodless colonies, which appeared to be much more effective (Büchler, 1997; Calis et al., 1997; Calis et al., 1999a, chapter 3; Dung et al., 1997; Jenter, 1986; Schmidt-Bailey et al., 1996).

The effectiveness of trap-comb methods depends on the fraction of mites that invade brood on trap-combs. Boot et al. (1994, 1995) found that the rate of invasion of mites into brood cells is proportional to the ratio between the number of attractive brood cells and the number of bees in a colony. Calis et al. (1998, chapter 2, 1999a, chapter 3) integrated these observations into a model that could accurately predict the effectiveness of trap-comb methods using worker and drone brood. In this paper we use this model to estimate and compare the effectiveness of different biotechnical control methods.

Material and Methods

The trap-comb model

General

Calis et al. (1999a, chapter 3) validated a trap-comb model based on work of Boot et al. (1995) on invasion rates of mites into brood cells. The observed effectiveness of trap-comb methods using worker or drone brood could be predicted using determined colony sizes and number of brood cells numbers in the trap- and non-trap-combs brood nest and in the trap-combs. Here, this model is used to estimate and compare effectiveness of different trap-comb methods. Based on an initial number of 100 mites distributed over adult bees, worker and drone brood, the model calculates: 1) the number of mites that invade worker and drone brood cells in both the trap-combs and non-trap-combs; and 2) the number of mites that emerge from brood cells of a standard colony on each day during a portion of the brood-rearing season. To best compare the evaluated biotechnical control measures, these calculations fall within a 70-day period. However, mite trapping with worker brood can be performed throughout the breeding season (Calis et al., 1998, chapter 2), whereas mite trapping with drone brood should be synchronised with the swarming season to ensure drone brood production (Calis et al., 1999a, chapter 3).

Invasion rate of mites into brood cells

Boot et al. (1995) derived empirical relationships between the invasion rate of mites into brood cells (r_w and r_d for worker and drone brood, respectively) and the ratio of the number of available cells (number of cells capped per day) to the number of adult bees. These relationships may be expressed as:

$$r_w = 0.56C_w/W$$

and

$$r_d = 6.49C_d/W$$

where C_w and C_d are the number of available worker and drone brood cells, respectively, and W is the weight in grams of adult bees in the colony. Depending on the weight of the colony, a specific number of brood cells that are being capped over one day are invaded by:

$$M_i = M_0(1 - e^{-(r_w + r_d)})$$

where M_0 is the number of phoretic mites and M_i is the number of mites entering brood cells on that day. Since mites invade brood cells of both types simultaneously, r_w and r_d are summed to obtain the invasion rate in all brood cells. Invading mites are divided over worker and drone brood in proportion to the quantities $r_w/(r_w + r_d)$ and $r_d/(r_w + r_d)$, respectively (Boot et al., 1995). An illustrative feature of the model is that with increasing numbers of drone brood cells being capped the parasitic load in worker brood decreases. Another property of the model is the negative exponential relation between the rate of invasion and the number of mites that invade brood cells, which may explain why over a wide range of drone cells, trapping efficiency is practically the same (Schmidt-Bailey et al., 1996). In our model, mites invade brood cells in trap-combs or brood cells in the non-trap-combs. In the first case, the mites are trapped and removed from the colony. In the latter case, the mites emerge from the brood cells after the postcapping stage of the brood cell. It is assumed that 1.6 and 2.5 times the number of invaded mites emerge from worker and drone brood cells, respectively, reflecting the mite's reproduction (Calis et al., 1999b, chapter 5).

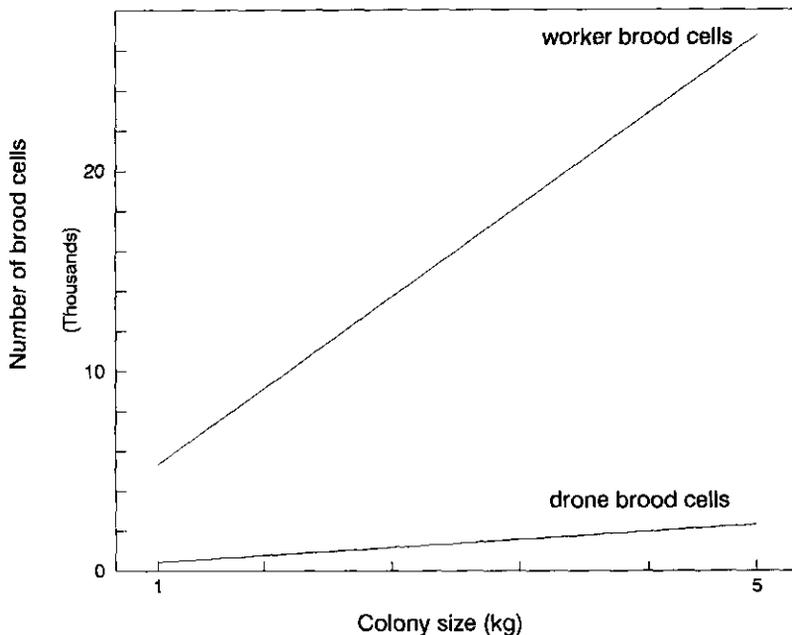

Figure 1. Numbers of worker and drone brood cells needed to trap 95% in relation to the weight of a broodless colony.

To reach an effectiveness equal to a standard treatment (e.g. 95% using Perizin), a relative brood cell invasion rate of $-\ln(0.05) = 3.00$ per time unit is needed, assuming that all mites stay phoretically on the bees. The time unit reflects the period during which mites are trapped. Using the invasion rate equations, we can calculate that $3.00/0.00056 = 5350$ worker brood cells or $3.00/0.00649 = 462$ drone brood cells are needed to trap 95% of the mites in a broodless colony of 1 kg of bees. When a colony contains more bees and, thus, has a larger weight, a proportionally larger amount of brood cells is needed for the same trapping effectiveness (Figure 1), irrespective of the time span during which they are capped (Boot et al., 1994). In theory, invasion into brood cells in an area of the colony can be limited by the spatial distribution of the mites. Depending on the rate of redistribution of the mites, a higher invasion rate is expected when the availability of brood cells is extended over a longer period. For worker brood, however, Boot et al. (1994) found no effect of different periods of brood cell availability on the invasion rate. For drone brood, Schmidt-Bailey and Fuchs (1997) found a reduced invasion rate when large numbers of brood cells were available during a shorter period. Considering the much lower number of brood cells that are capped per bee and per day in our simulations, the process of redistribution of the mites is expected to prevent an effect of the period of brood cell availability on the invasion rate.

The standard bee colony and trap-combs

The imaginary standard bee colony consists of 30000 bees (3.75 kg) and a brood nest that occupies an equal number of cells, of which 4% contains drone brood (Calis et al., 1999b, chapter 5). From these imaginary colony data we derived for the two types of brood cells the numbers of brood cells that are capped and left by the young bees each day. Using the model, we estimated the initial distribution of mites over adult bees, worker and drone brood to be 29:48:23, respectively. If the queen produces drone brood for trap-combs, normal brood production continues. Trap-combs are assumed to contain 5000 worker brood cells or 1500 drone brood cells.

Evaluation of trap-comb methods

The model is used to calculate the number of trapped mites and the remaining mites in the standard colony at the moment that the final trap-comb had been removed from the colony. The percentage of trapped mites is taken as a measure of effectiveness (Table 1), as is used in current research. However, applying trap-comb methods often implies indirect effects on population growth because mites trapped cannot contribute to population growth. Using the model a comparison can be made between the population of mites after the use of biotechnical control measures and the mite population when no treatment was given. When the model is run without trap-combs the mite population grows exponentially (Figure 2). A second measure of effectiveness is the reduction of the population size at the end of the simulation, due to the biotechnical control treatment.

Results and Discussion

Results of simulations of mite populations subjected to biotechnical control methods are visualised in Figure 2. The curves reflect the mite population present in the colony during the simulation, and mites are subtracted from the mite population as soon as they invade trap-combs. The effectiveness of the methods is summarised in Table 1. Each simulation is marked with a corresponding number used in the text, Table 1 and Figure 2.

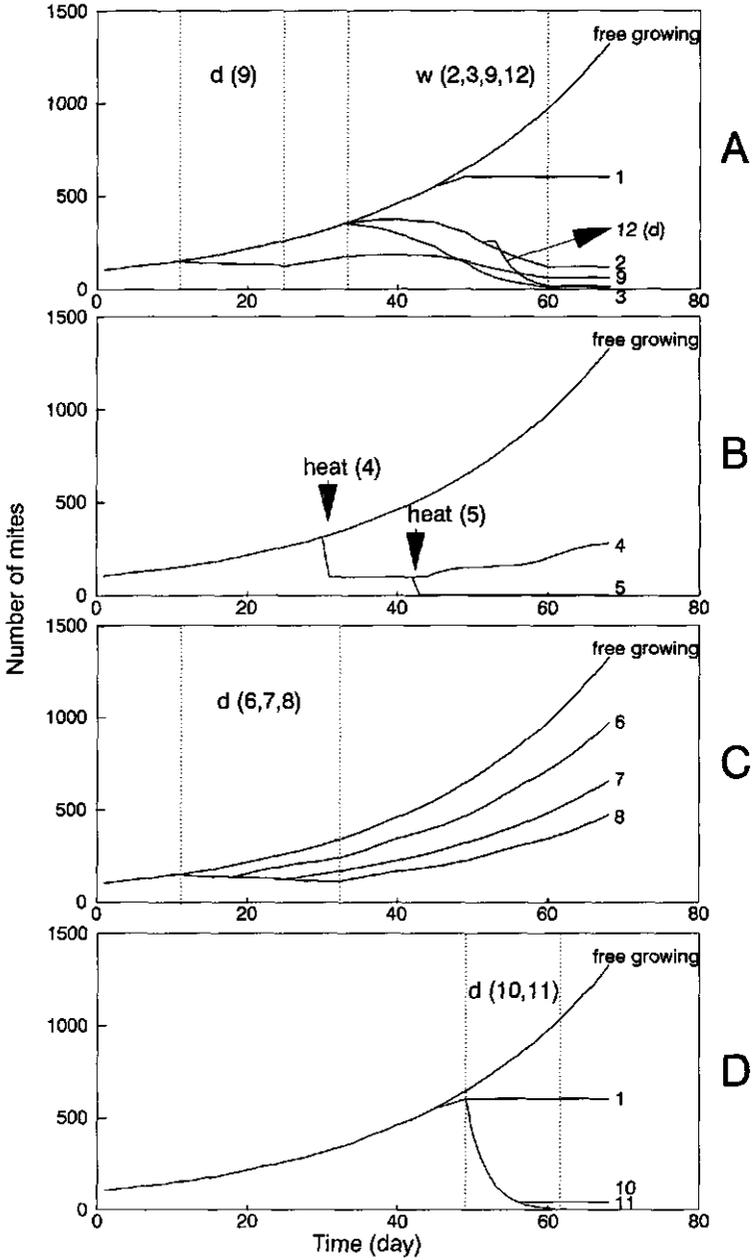

Figure 2 A-D. Simulations of mite populations during a period of 70 days with and without biotechnical control treatments. For each simulation, mites are trapped in either drone or worker brood (during the periods between the dotted lines d or w, respectively). A) In simulation 12 the third trap-comb consists of drone brood and the queen is confined to empty combs on day 25. B) Heat treatment of capped brood. C) Trapping with drone brood within the brood nest. D) Trapping with drone brood during broodless conditions.

Table 1. Summary of results of the model.

Simulation number	Trap-comb method	Predicted reduction of population size (%)	Predicted effectiveness (%)
1	Confining the queen on day 25, without mite trapping	54.5	
2	Three worker combs in a queen confinement cage produced during 9-day intervals from day 25, trapping from days 33 to 60	90.7	79.5
3	Normal brood production as trap-combs from day 25, trapping from days 33 to 60 (27 days)	98.8	97.4
4	Heat treatment of the capped brood on day 25	78.7	68.2
5	Heat treatment of the capped brood on day 25, followed by a second treatment on day 37	99.6	99.0
6	One drone comb added to brood nest from day 1, trapping from days 11 to 18	26.7	30.4
7	Two drone combs added to brood nest from day 1, trapping from days 11 to 25	50.5	50.9
8	Three drone combs added to brood nest from day 1, trapping from days 11 to 32	64.1	61.7
9	Three worker combs in a queen confinement cage produced during nine days (simulation 2) preceded by two drone combs added to brood nest (simulation 7)	95.3	85.5
10	One drone comb during broodless conditions (queenless from day 25), trapping from days 50 to 57	96.6	92.5
11	Two drone combs during broodless conditions	99.7	99.4
12	Two worker combs, and one drone comb in a queen confinement cage produced during 9-day intervals from day 25, trapping from days 33 to 60	98.5	96.8

Trapping mites with worker brood

In all simulations using trap-combs with worker brood (Table 1: simulations 2, 3, 9 and 12), the queen is confined to empty combs on day 25. In the trap-combs, brood is produced at a constant rate, and mites are trapped starting on the day the first brood in the trap-combs is trapped. When the queen is confined to one comb in a cage, the mite population will stop growing when the last mites emerge together with their hosts from the remaining brood nest (simulation 1). Confinement of the queen restricts egg-laying to one comb at a time. Three of these combs produced in subsequent 9-day intervals (simulation 2) trap 79.5% of the mites present in the standard colony. Since trapped mites cannot contribute to population growth, the population size is further reduced with 90.7% compared to the free-growing mite population. The use of more brood cells will increase the effectiveness of mite trapping with worker brood. This is feasible because the mites can be selectively killed and the worker brood saved. Fries (1991) showed that capped worker

brood between 9 and 18 days of age could be safely treated with formic acid outside the colony to kill the mites. Accordingly, Calis et al. (1998, chapter 2) prepared batches of brood with trapped mites for formic acid treatment outside the colony by confining queens for three 9-day intervals to supers containing ten combs or queen confinement cages containing three combs. Hence, brood production was not limited by the number of cells and here (simulation 3) we assume that worker brood cells used for trapping are produced at the rate calculated from the standard colony. Therefore, simulation 3 is expected to reduce the mite population with more than 95%. A test of this method (Calis et al., 1998, chapter 2) revealed a somewhat lower effectiveness. This lower effectiveness was expected because the brood to bee ratio was also lower compared to that of the standard colony chosen here (about 0.65 and 1.0 occupied brood cells per bee, respectively). When applying heat treatment (simulations 4 and 5), the manipulation needed to obtain dated brood batches can be avoided because the complete brood nest can be safely treated (Engels, 1994). One treatment (simulation 4) kills all the mites inside the brood cells and, thus, a significant portion of the mites. This treatment is visualised by subtraction of mites killed by the heat treatment from the mite population (Figure 2). When a second treatment is applied before newly capped brood cells emerge, the majority of the mites that remained on the bees after the first treatment will be killed since they will have invaded the newly capped brood cells (simulation 5).

Trapping with worker brood is labour intensive because a large amount of brood is needed to trap mites for effective control. Additionally, trapping mites with worker brood requires treatment of the capped brood to selectively kill the mites.

Trapping mites with drone brood

In all simulations using trap-combs with drone brood cells in colonies actively rearing brood (simulations 6-9), empty drone combs are introduced in weekly intervals starting from day 1 of the simulation. We assume that these drone combs obtain 1500 cells of drone brood which are produced within a 1-week period, in addition to the existing brood nest, and that mites are trapped starting from the day the first drone brood in the trap-combs is being capped. When the bees are allowed to rear drone brood in combs that are removed before the drones emerge (simulations 6-8), large numbers of mites can be trapped. Differences between the population reduction and the trapping effectiveness (Table 1) are not only influenced by trapped mites that cannot contribute to population growth anymore, but also by the model assumption that mites increase in numbers when they emerge from a brood cell. In the situation that one trap-comb with drone brood is removed, the trapping effectiveness is higher than the population reduction, because the majority of the mites that remain in the colony continue to reproduce inside brood cells. The population reduction compared to the trapping effectiveness increases again when more trap-combs with drone brood are removed (Table 1). Removal of trap-combs with drone brood temporarily stops population growth of the mites. Fries & Hansen (1993) found that removal of drone combs preceding trapping with worker brood, using the queen confinement cage over one comb, considerably improved biotechnical control, as predicted with the model (simulation 9). In this simulation two drone combs are removed before the queen is confined to the cage containing worker comb on day 25. Many mites, however, invade into the brood cells of the remaining brood nest and avoid the trap-combs with drone brood.

Broodless conditions that occur in colonies should be used to take advantage of the high invasion rate of the mites into drone brood cells. Accordingly, efforts have been directed towards integrating mite trapping in drone brood with swarm-prevention techniques (Calis et al., 1999a, chapter 3; Dung et al., 1997; Jenter, 1986; Schmidt-Bailey et al., 1996).

Simulating a situation in which the queen has been removed from the colony, it is shown that introducing one comb with drone brood to trap mites (simulation 10) after the last bees have emerged from the existing brood nest (after day 50) effectively reduces the mite population, while a second drone comb (simulation 11) practically eliminates the mite population. A broodless artificial swarm split from a colony will contain only a part of the phoretic mites present in the original colony and a trap-comb with drone brood will trap the majority of these mites. Accordingly, when the one-comb queen confinement cage is used, and during the third confinement interval the queen is confined on a drone comb, the effectiveness of this trap-comb method (simulation 2) will drastically improve (simulation 12) (Büchler, 1997; Kruse, 1995).

Compared to worker brood, trapping with drone brood demands many fewer brood cells for sufficient mite control, and removal and destruction of drone brood with trapped mites is common practice. Preparation of trap-combs with drone brood can quite easily be integrated into existing swarm-prevention techniques.

Calis et al. (1998, chapter 2, 1999a, chapter 3) successfully used knowledge on invasion behaviour of mites to predict the effectiveness of control methods based on trap-combs. Here we demonstrate that our model can be used to evaluate control scenarios encompassed by a diversity of bee-management systems.

Since brood cell invasion is crucial for mite reproduction, basic knowledge on the process of brood cell invasion also helps model *V. jacobsoni* population dynamics in a broader sense.

Integration of knowledge on brood cell invasion into the population dynamics model of Fries et al. (1994), allowed more realistic modelling of *V. jacobsoni* populations, providing a tool to simulate not only biotechnical control methods but also responses of mite populations to climatic conditions and honey bee traits (Calis et al., 1999b, chapter 5).

Acknowledgements We thank M Beekman, JC van Lenteren, MW Sabelis and two anonymous referees for their valuable comments on versions of the manuscript.

Appendix: Detailed description of the trap-comb model

The number of brood cells capped per brood type and per day in the brood nest was derived from the total number of brood cells in the standard colony. Worker brood trap-combs (5000 brood cells) used in our simulations were produced during 9-day queen confinement periods, whereas the drone brood trap-combs (1500 brood cells) were produced during 1-week periods. The initial distribution of 100 mites over bees, worker brood and drone brood was estimated to be 29:48:23. At the start of one simulation day, the derived numbers of brood cells that would be capped during that day and the colony size (3.75 kg) were used to calculate the invasion rate into brood cells, the number of phoretic mites invading brood cells, and the distribution of mites over both types of brood cells within the trap-combs or brood nest (non-trap) combs. In contrast to mites invading cells in the brood nest, mites invading trap-combs are removed from the colony. Emergence of mites and their offspring (equalling the number of invaded mites times 1.6 and 2.5 for worker and drone brood cells, respectively), follows a sequence analogous to invasion, delayed with the duration of the capped honey bee brood stage. At the end of one simulation day these emerging mites are added to the phoretic mites. Then a new simulation day starts. Calculations were performed using a spreadsheet. At the moment the final trap-comb was removed from the colony, the percentage of trapped mites was calculated. After 70 days the population size was calculated and could be compared to a free-growing population.

The following formulas were used

- 1) Invasion rate into worker brood cells:

$$r_w = 0.56 \cdot C_w / W$$

where r_w is the invasion rate into brood cells per day, C_w is the number of worker brood cells that are capped during 1 day, and W is the weight of the bees of the colony in grams.

2) Similarly, the invasion rate into drone brood cells:

$$r_d = 0.56 \cdot C_d / W$$

3) Number of invading mites:

$$M_i = M_0(1 - e^{-(r_w + r_d)})$$

where M is the number of phoretic mites, and M_i is the number of mites that invade per day.

Brood cells on the trap-combs and combs of the brood nest are invaded in proportion to the numbers of capped brood cells on either type of comb. Mites that invade trap-comb brood cells are removed from the colony, whereas mites that invade the brood nest will emerge after the postcapping period.

4) Mites invading worker brood:

$$W_i = M_i \cdot r_w / (r_w + r_d)$$

where W_i is the number of mites invading worker brood cells per day.

5) Mites emerging from worker brood:

$$W_e = 1.6 \cdot W_{i,t+12}$$

where W_e is the number of mites emerging from worker brood cells per day.

6) Similarly, mites invading drone brood:

$$D_i = M_i \cdot r_d / (r_w + r_d)$$

7) Mites emerging from drone brood:

$$D_e = 2.5 \cdot D_{i,t+14}$$

References

- Bolli, HK, Bogdanov, S, Imdorf, A & Fluri, P (1993) Zur Wirkungsweise von Ameisensäure bei *Varroa jacobsoni* Oud. und der Honigbiene (*Apis mellifera* L.). *Apidologie* 24: 51-57.
- Boot, WJ, Sisselaar, DJA, Calis, JNM & Beetsma, J (1994) Factors affecting invasion of *Varroa* mites into honey bee brood cells. *Bulletin of Entomological Research* 84: 3-10.
- Boot, WJ, Schoenmaker, J, Calis, JNM & Beetsma, J (1995) Invasion of *Varroa* mites into drone brood cells of the honey bee. *Apidologie* 26: 109-118.
- Buren, NWM van, Mariën, J, Velthuis, HHW & Oudejans, RCHM (1992) Residues in beeswax and honey of perizin, an acaricide to combat the mite *Varroa jacobsoni* Oudemans (Acari: Mesostigmata). *Environmental Entomology* 21: 860-865.
- Büchler, R (1997) Trapping combs with drone brood for the elimination of *Varroa* mites, XXXVth International Apicultural Congress, Programme and summaries of the reports: pp 83.
- Calis, JNM, Schmidt-Bailey, J, Beetsma, J, Boot, WJ, Eijnde, JHPM van den, Fuchs, S, Ruijter, A de & Steen, JJM van der (1997) Successful trapping of *Varroa jacobsoni* with drone brood in broodless *Apis mellifera* colonies. *Apiacta* 32: 65-71.

- Calis, JNM, Beetsma, J, Boot, WJ, Eijnde, JHPM van den, Ruijter, A. de & Steen, JJM van der, (1998) Control of *Varroa* by combining trapping in honey bee worker brood with formic acid treatment of the capped brood outside the colony: Putting knowledge on brood cell invasion into practice. Chapter 2, *Journal of Apicultural Research*, 37: 205-215.
- Calis, JNM, Beetsma, J, Boot, WJ, Eijnde, JHPM van den, Ruijter, A. de & Steen, JJM van der (1999a) Effective biotechnical control of *Varroa*: applying knowledge on brood cell invasion to trap honey bee parasites in drone brood. Chapter 3, *Journal of Apicultural Research*, 38: 49-61.
- Calis, JNM, Fries, I & Ryrie, SC (1999b) Population modelling of *Varroa jacobsoni* Oud. Chapter 5, *Apidologie* 30: 111-124.
- De Greef, M, De Wael, L, Van Laere, O (1994) The determination of the fluvalinate residues in the Belgian honey and beeswax. *Apiacta* 29: 83-87.
- Dung, NV, Tan, NQ, Huan, LV & Boot, WJ (1997) Control of honey bee mites in Vietnam without the use of chemicals. *Bee World* 78: 78-83.
- Engels, W, Rosenkranz, P, Hertl, F & Staemmler, G (1984) Biologische *Varroa*-Kontrolle durch Drohnenbrutentnahme. *Apidologie* 15: 246-248.
- Engels, W (1994) *Varroa* control by hyperthermia. In Matheson, A (editor) *New perspectives on Varroa*. IBRA, Cardiff, UK, pp. 115-119.
- Fries, I (1989) Short-interval treatments with formic acid for control of *Varroa jacobsoni* in honey bee (*Apis mellifera*) colonies in cold climates. *Swedish Journal Agricultural Research* 19: 213-216.
- Fries, I (1991) Treatment of sealed honeybee brood with formic acid for control of *Varroa jacobsoni*. *American Bee Journal* 131: 313-314.
- Fries, I & Hansen, H (1993) Biotechnical control of *Varroa* mites in cold climates. *American Bee Journal* 133: 435-438.
- Fries, I, Camazine, S & Sneyd, J (1994) Population dynamics of *Varroa jacobsoni*: a model and a review. *Bee World* 75: 5-28.
- Fuchs, S (1995) Untersuchungen zur Quantitativen Abschätzung des Befalls von Bienenvölkern mit *Varroa jacobsoni* Oudemans und zur Verteilung des Parasiten im Bienenvolk. *Apidologie* 16: 343-368.
- Fuchs, S (1990) Preference for drone brood cells by *Varroa jacobsoni* Oud. in colonies of *Apis mellifera carnica*. *Apidologie* 21: 193-199.
- Hansen, H & Guldborg, M (1988) Residues in honey and wax after treatment of bee colonies with formic acid. *Tidsskr. Planteavl.* 92: 7-10.
- Hansen, H & Petersen, JH (1988) Residues in honey and wax after treatment of bee colonies with bromopropylate. *Tidsskr. Planteavl.* 92: 1-6.
- Imdorf, A, Charrière, JD & Bachofen, B (1997) Efficiency checking of the *Varroa jacobsoni* control methods by means of oxalic acid. *Apiacta* 32: 89-91.
- Jenter, K (1986) Mit gezielter biologischer Frühjahrs-Sommer-Behandlung gegen die *Varroa*. *Allgemeine Deutsche Imkerzeitung* 20: 111-114.
- Koeniger, N & Fuchs, S (1988) Control of *Varroa jacobsoni*: current status and developments. In Needham, G.R. et al. (editors) *Africanized honeybees and bee mites*. Ellis Horwood Limited, Chichester, pp. 360-369.
- Kraus, B & Berg, S (1994) Effect of a lactic acid treatment during winter in temperate climate upon *Varroa jacobsoni* Oud. and the bee (*Apis mellifera* L.) colony. *Experimental & Applied Acarology* 18: 459-468.
- Kruse, G (1995) Das Banwabenverfahren. *Deutsches Bienen Journal* 3: 19-21.
- Lodesani, M, Pellacani, A, Bergomi, S, Carpana, E, Rabitti, T & Lasagni, P (1992) Residue determination for some products used against *Varroa* infestation in bees. *Apidologie* 23: 257-272.
- Lodesani, M, Colombo, M & Spreafico, M (1995) Ineffectiveness of Apistan treatment against the mite *Varroa jacobsoni* Oud. in several districts of Lombardy (Italy). *Apidologie* 26: 67-72.
- Maul, V (1983) Empfehlungen zur Methodik der *Varroa* Elimination mittels Banwaben aus Arbeiterbrut, *Allgemeine Deutsche Imkerzeitung* 18: 179-183.

- Maul, V, Klepsch, A & Assmann-Werthmüller, U (1988) Das Bannwabenverfahren als Element imkerlicher Betriebweise bei starkem Befall mit *Varroa jacobsoni* Oud. *Apidologie* 19: 139-154.
- Milani, N (1994) Possible presence of fluvalinate-resistant strains of *Varroa jacobsoni* in northern Italy. In Matheson, A (editor) *New perspectives on Varroa*. IBRA, Cardiff, UK, pp. 87.
- Ritter, W & Ruttner, F (1980) Neue Weg in der Behandlung der Varroatose. *Allgemeine Deutsche Imkerzeitung* 14: 151-157.
- Rosenkranz, P (1987) Thermobehandlung verdeckelter Arbeiterinnenbrutwaben als Möglichkeit der Varroatose-Kontrolle. *Apidologie* 18: 385-388.
- Schmidt-Bailey, J, Fuchs, S & Büchler, R (1996) Effectiveness of drone brood trapping combs in broodless honeybee colonies. *Apidologie* 27: 294.
- Schmidt-Bailey, J & Fuchs, S (1997) Experiments for the efficiency of *Varroa* control with drone brood-trapping combs. *Apidologie* 28: 184-186.
- Schulz, A, Koeniger, N & Ruttner, F (1983) Drohnenbrut als Varroafalle. *Allgemeine Deutsche Imkerzeitung* 17: 52-54.
- Schultz, A E (1984) Reproduktion und Populationsentwicklung der parasitischen Milbe *Varroa jacobsoni* Oud. in abhängigkeit vom Brutzyclus ihres Wirtes *Apis mellifera* L. *Apidologie* 15: 401-420.
- Sulimanovic, D, Ruttner, F & Pechacker H (1982) Studies on the biology of reproduction in *Varroa jacobsoni* (in Japanese). *Honeybee Science* 3: 109-112.

Population Modelling of *Varroa jacobsoni* Oud.

Abstract

To understand population dynamics of the mite, *Varroa jacobsoni*, and to enable computer simulations, Fries et al. (1994) incorporated available knowledge into a mite population model. In this paper, we update and extend this model by incorporating more recent data, in particular on mite invasion from bees into brood cells. By predicting invasion into and emergence from brood cells, the model proves to be useful to evaluate the effects of changes in model parameters on the mite population when the distribution of mites over bees and brood are important. The model predicts that a longer brood rearing period dramatically increases the mite population size and that a relatively larger number of drone brood cells leads to an increased population growth. As mite control treatments often only affect mites either in brood cells or on adult bees, the model can be used to evaluate their effectiveness and timing. The model indicates that changes in parameters that affect the reproductive success of the mites in brood cells have a large impact on the mite population.

Introduction

The parasitic mite of honey bees, *Varroa jacobsoni* (Acari: Varroidea), is a major obstacle to beekeeping throughout most temperate and some tropical regions of the world. Adult female mites feed on bees, and as honey bee brood becomes available, the mites leave the adult bees to reproduce inside the bee brood cells. Reproductive success inside the brood cells depends on various factors, (reviewed by Donzé et al., 1996). As the bee emerges from the brood cells, the mite mother and her adult female progeny return to the adult bees. If total mite mortality on the adult bees and in the brood is smaller than the production of new mites in the brood, the mite population will increase over time. The life cycle of mites in a honeybee colony is schematically represented in Figure 1.

To help understand population dynamics of *V. jacobsoni* in colonies of European honey bees, models of different aspects of mite population dynamics have been presented (Boot et al., 1994, 1995a; Camazine, 1988; Fries & Rosenkranz, 1996; Fuchs & Langenbach, 1998; Omholt & Crailsheim, 1991; Schulz, 1984). A review of factors affecting mite population dynamics was presented by Fries et al. (1994) together with differential equations modelling the mite population dynamics.

The model described here is an extended version of that by Fries et al. (1994). In the original model, the per capita number of reproductive cycles was set at 1.4. Secondly, invasion of mites into brood cells was determined by a mean length of the phoretic period. In nature, the number of times a mother mite will reproduce is determined by the invasion rate into brood cells and the mortality rate of the mites. In the new version of the model, we included the equations on cell invasion rates presented by Boot et al., (1995a) and mite mortality data connected with the emerging infested bee (Boot et al., 1995b), thereby avoiding the non-biological restrictions in the old model.

The invasion rate into brood cells can be calculated when colony size and numbers of brood cells are known. To simulate colony size and numbers of brood cells, we designed a bee colony population model. Thus, the new model is comprised of two parts, a model of the bee colony, and a model of the mite population, which describe the populations they represent over a period of several years. The colony model follows a bee colony during the year from broodless hibernating conditions, via a period of

breeding and growth in summer, and a period of decline in fall, returning to a broodless hibernating colony. Its output pattern does not change from year to year, and is unaffected by the mite model. The output pattern of the mite model does vary from year to year and is influenced by the colony model, and in particular by the number of bees and the number of brood cells present in the hive at any time.

The aim of this paper is to describe and explore the extended simulation model of the interaction between honey bees and mite populations. Such a model is used for exploring the effects of changes in various characteristics that relate to mite resistance, effects of beekeeping techniques, and to predict the effect of different control treatments.

Material and Methods

The colony model

The colony model describes the number of drone and worker brood cells in the colony on each day of the year. The basic colony model, like that of Fries et al. (1994), is based on field data from Scotland on counts of numbers of drone and worker brood cells in colonies during the brood-rearing season as reported by Allen (1965). In addition, we use sets of brood data from mid-European conditions (P. Rosenkranz, unpublished data) and from neo-tropical conditions (Echazaretta & Paxton, 1997). The use of brood data from different climatic regions provides us with an opportunity to simulate *V. jacobsoni* population dynamics in different climatic zones. For the additional two brood data sets, we have assumed that the number of drone cells is a constant proportion of the number of worker cells (4%; derived mean from the work of Allen 1965), because more precise data are lacking.

In the colony model, the amount of brood and the development time of the brood are used to calculate the number of emerging adult bees. The total number of adult bees is calculated by assigning a specified longevity of the bees during periods of brood rearing. During winter the death rate is chosen so that the colony returns to the same size as one year previously (for parameter values see Table 1). The brood data used and the number of bees simulated are illustrated in Figures 2a-2c.

The mite population model

Several processes contribute to changes in the population level of mites within the colony. Mites are either phoretic on the bees, or are in the brood cells where they reproduce. This distribution depends on the invasion rate of phoretic mites into the brood. Both phoretic mites and mites in the brood are subjected to certain levels of mortality. The mite population dynamics is determined by invasion of mites into brood cells, reproductive factors, and mortality factors.

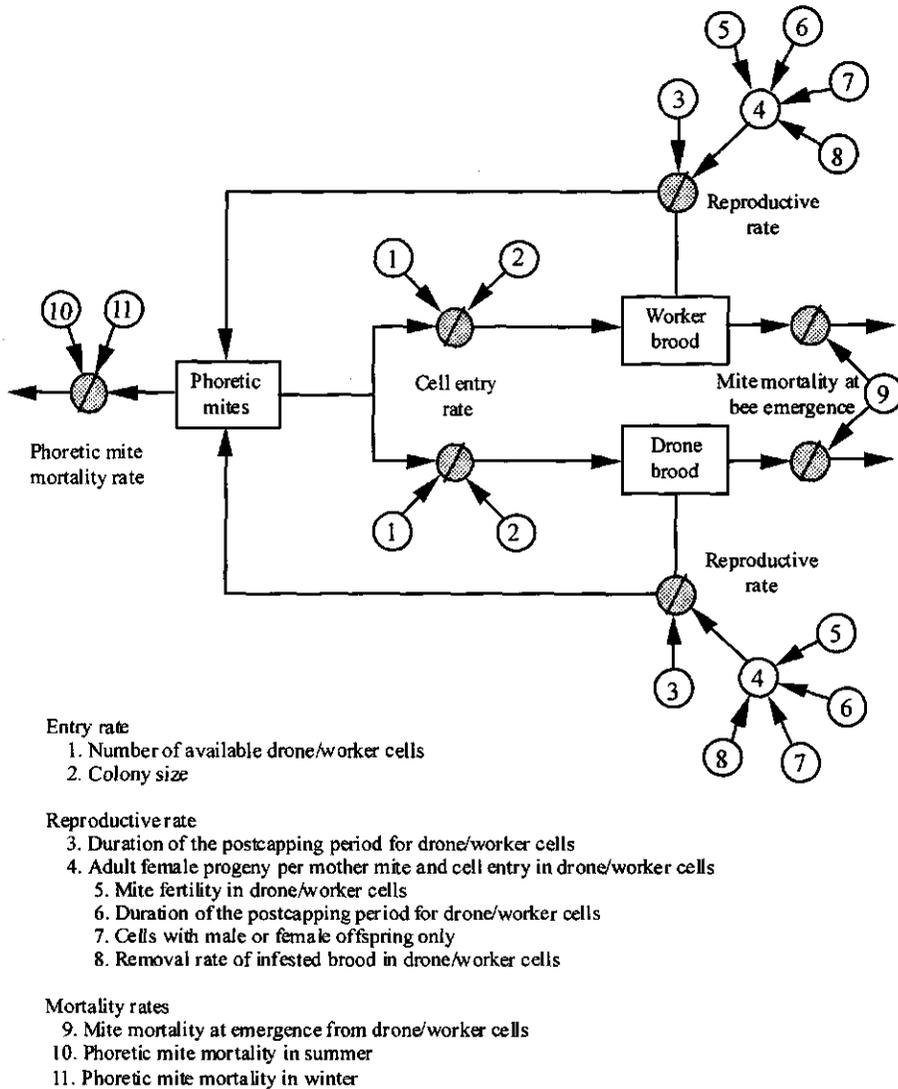

Figure 1: Diagram of *V. jacobsoni* mite population growth within a honey bee colony.

Invasion of mites into brood cells and mite emergence

Boot et al. (1995a) measured the rate of invasion of mites into worker and drone cells in the field, and derived empirical relationships between the invasion rate per day (r_D and r_W for drone and worker brood respectively) and the ratio of the number of available cells to the number of adult bees:

$$r_D = -6.49D/B$$

and

$$r_W = -0.56W/B$$

where D and W are the number of available drone and brood cells respectively and B is the weight in grams of adult bees in the colony. D and W are the number of brood cells that are capped during one day and are calculated from the total numbers of cells of both brood type and the specific development time. B , the weight of the bees, is calculated by assuming that one bee weighs 0.125 gram (J. Calis unpublished data).

Thus, depending on the weight of the colony, a specific number of brood cells that are being sealed during one day are invaded by:

$$I = P(1 - \exp(-(r_D + r_W)))$$

where P is the is number of phoretic mites and I is the number of mites invading cells on that day. Invading mites divide themselves over worker and drone brood in proportion to the quantities $r_W / (r_D + r_W)$ and $r_D / (r_D + r_W)$, respectively. We have used these formulae in our model, with values of W , D and B varying with time as determined by the colony model being used.

The rate of invasion of mites into brood cells thus arises from a dynamic relationship between the number of available brood cells and the number of bees on which the mites are distributed. The invasion rate equations have proved useful in describing the efficacy of trapping mites in worker brood (Calis et al., 1998) or in drone brood (Calis et al., 1999). Martin (1998) recently also made an attempt to integrate knowledge on brood cell invasion into a population model. However, he interpreted the work of Boot et al. (1995a) quite differently. Since Martin let the same phoretic mites invade worker and drone brood independently, mites have to be divided artificially between worker and drone brood cells in his model. In our model, the division between worker and drone brood follows directly from the invasion rate equations above.

The number of mites that emerge daily from cells is derived from the number that invaded these brood cells one postcapping period earlier (using a delay function), modified to reflect mite reproduction and mortality in the cells.

Reproduction

Once the mites have entered brood cells and the cells have been sealed, the mother mite may start reproduction. Some mites die before they are able to start reproduction, partly because they get trapped between the cell wall and the bee cocoon. Other mites may fail to start reproduction, and of those that do reproduce some may

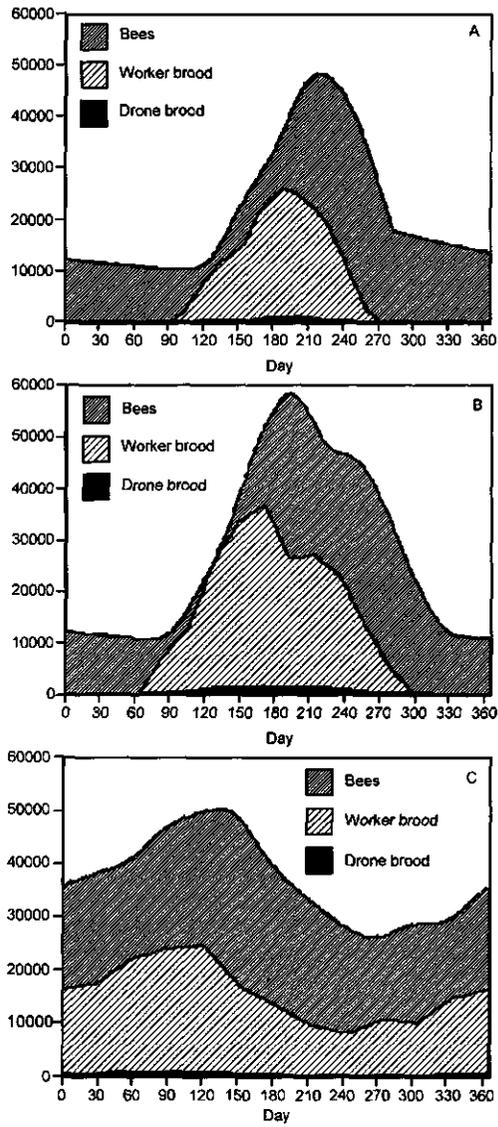

Figure 2 a: Northern European colony model.
 b: Central European colony model.
 c: Tropical colony model.

Table 1: Standard Parameter Values used for simulation of *V. jacobsoni* populations

Parameter	Value	Comments
Initial population (phoretic mites)	10	
Simulation starting day	1 January	
Brood production	northern neo-tropical central European	Allen (1965) Echazaretta & Paxton (1997) Rosenkranz (unpublished)
Drone brood development period	24 days	
Worker brood development period	21 days	
Drone brood postcapping period	14 days	
Worker brood postcapping period	12 days	
Summer bee lifespan	31 days	Taranov & Azimov (1972)
Winter bee mortality	variable	see text
Mite invasion rate	variable	Boot et al. (1995a)
Mite infertility on drone brood	5% ($=j_D$)	Fries et al. (1994)
Mite infertility on worker brood	15% ($=j_W$)	Fries et al (1994)
Mean number of female offspring in a worker cell with female offspring	1.45 ($=f_W$)	Fries et al. (1994), Martin (1994)
Mean number of female offspring in a drone cell with female offspring	2.5 ($=f_D$)	Fries et al. (1994), Martin (1994)
Emergent mite mortality	22% ($=1-s$)	Boot et al. (1995b)
Uncapping of infested cells	5% ($=u$)	Fries et al. (1994) Calis (Chapter 7)
Proportion of worker cells with only male offspring	9% ($=m_W$)	Donzé (1996)
Proportion of drone cells with only male mites	9% ($=m_D$)	Donzé (1996)
Proportion of female mites dying in worker cells before mating	2% ($=g_W$)	Kustermann (1990) Martin (1994)
Proportion of female mites dying in drone cells before mating	8% ($=g_D$)	Martin (1994)
Summer mite mortality	Variable	Boot et al. (1995b) Kraus et al (1996)
Winter mite mortality	0.004	Fries et al. (1994)
Postcapping influence factor	1.0 ($=\rho_W, \rho_D$)	see text

produce non-viable offspring. In addition to female juvenile mortality, some mites produce only male progeny. Reproduction may be interrupted as bees uncap sealed cells and remove parasitised bee pupae. The reproductive success of the mite is also influenced by the duration of the post-capping period where a prolonged period increases the average number of viable female offspring. K. Langenbach (unpublished data) found that a reduction in the postcapping period of worker brood from 12 days to 11 days resulted in a 50% reduction in the number of offspring. Büchler & Drescher (1990) found that a one-hour reduction of the postcapping period in worker brood reduced the mite population growth by 8.7%. We have linearly interpolated these findings to postcapping periods between 11 and 13 days, thus, ranging from 50% reduction to a 150% increase, respectively. For drone brood we assumed a similar reduction and increase between 12 and 16 days.

We have considered new data on male mite mortality in sealed brood cells (Donzé et al., 1996; Martin, 1994, 1995). The fact that a surprisingly large number of infested cells lack male progeny does have implications for population dynamics. Young mites that have not mated may either parthenogenetically produce only sons or may fail to produce offspring at all. In our model, we consider these mites and regard unmated mites as a part of the mite population.

Mite mortality

The natural mortality rate of phoretic mites in summer is taken to be the sum of mites lost after falling from bees in the hive, and mites lost via foragers that do not return to the colony. The rate at which mites fall from bees is taken to be 0.6%/day, following the findings of Boot et al. (1995b). Further, we assume that bees that die during the summer are foragers that fail to return to the hive and that mites on these bees are lost from the mite population. The daily number of mites lost on non-returning foragers is calculated assuming that the rate of infestation of the foragers is one third of the average infestation of bees (Kraus et al., 1986), their number being calculated by the colony model and with the lifespan of adult bees as shown in Table 1. The winter mortality rate is assumed to be 0.4% per day, as in Fries et al. (1994).

Boot et al (1995b) found that 22% of emerging mites, mothers and female offspring, fall off the host bees to the bottom of the colony in the first three days following emergence, which we have included in our model.

Summarising, mites on bees are subjected to mortality and losses in the field. When they invade brood cells, they may reproduce and increase their numbers. If we define reproductive success as the number of living female mites, including the mother, which emerge from a brood cell per invading mite, then for worker brood this is:

$$R_w = \{f_w p_w (1 - u - j_w - g_w - m_w) + 1\} s$$

where:

- R_w is reproductive success per invading mite in worker brood;
- f_w is the number of daughters per mite in worker brood;
- p_w is a factor representing influence of postcapping period on the number of offspring in worker brood;
- u is the fraction of cells uncapped by bees;
- j_w is the fraction of infertile female mites in worker cells
- g_w is the fraction of female mites in worker cells which die before reproducing;
- m_w is the fraction of female mites that produce only male offspring.

s is the fraction of emerging mites which survive emergence.

A similar set of relationships holds for drone brood.

The values of R_w and R_D derived from the parameter values in Table 1 are 1.56 and 2.21 live emerging mites per invaded mite, respectively.

Results and Discussion

Mite population growth

The model calculates the number of adult female mites present on adult bees and in brood cells. The following simulations demonstrate how the mite population will change over time using three different sets of brood data in colonies that do not swarm and are not subject to mite control.

In Figure 3, the mite population growth using brood data of northern, central European and neo-tropical origin is presented graphically. The simulations start on January 1 with an initial population of 10 phoretic mites and continue for 4 successive years. The model does not include the negative impact that high mite levels may impose on bee colonies and thus the model allows the mite population to increase beyond levels tolerated by bee colonies. This is an important limitation of the model, because interaction between the mite population and the colony is evident at high mite population levels.

The duration of the brood-rearing period has a dramatic impact on the mite population. Under neo-tropical brood rearing conditions, colonies are likely to succumb to infestation within a year if the mite population is left uncontrolled. This is in agreement with available data from southern Europe and California, where mite growth rates may cause colony death within a year after effective mite control measures (García-Fernández et al., 1995; Kraus & Page, 1995). Under northern brood rearing conditions, where mite mortality during broodless winter condition causes a decrease of the mite population, the model predicts relatively low mite population levels for the first two years of the infestation. In the third year, the mite population may reach damaging levels and by the fourth year the infestations are likely to cause colony death. This pattern of development is supported by field data from Finland (Korpela et al., 1992). Central European brood data give rise to mite population growth that is intermediate to northern and neo-tropical growth. Under these conditions, bee colonies are likely to be severely damaged by the mite infestation within two years of the initial infestation. The presented sets of brood data, besides those from Scotland (Allen, 1965), do not contain actual numbers of drone cells, since they were not known. We used as numbers of drone brood cells 4% of the number of worker brood cells; a mean of the data from Scotland. This extrapolation may be unrealistic, but the simulations still illustrate the importance of extended periods of brood rearing. To make realistic simulations for different brood rearing patterns, however, data on numbers of brood cells of both drone and worker brood cells throughout the year are needed.

Mite populations build up relatively fast during the summer months. Observations of mite population increase have been made by Calatayud & Verdu (1995) using *A. m. iberica*. They found that the mite population growth is exponential; i.e., that the population is proportional to $\exp(rt)$, where the value of the growth parameter r is approximately 0.021/day. This implies that the population would double in size in a period of 33 days. The results of our model are in accordance with this: a logarithmic plot of mite population vs. time shows that population growth during the peak of brood rearing is indeed exponential, irrespective of what brood data is being used. We find the

value of r to be 0.023/day, somewhat greater than that found by Calatayud & Verdu, and corresponding to a population doubling time of 30 days. In all further runs of our model, we have only used the northern European brood data for simplicity.

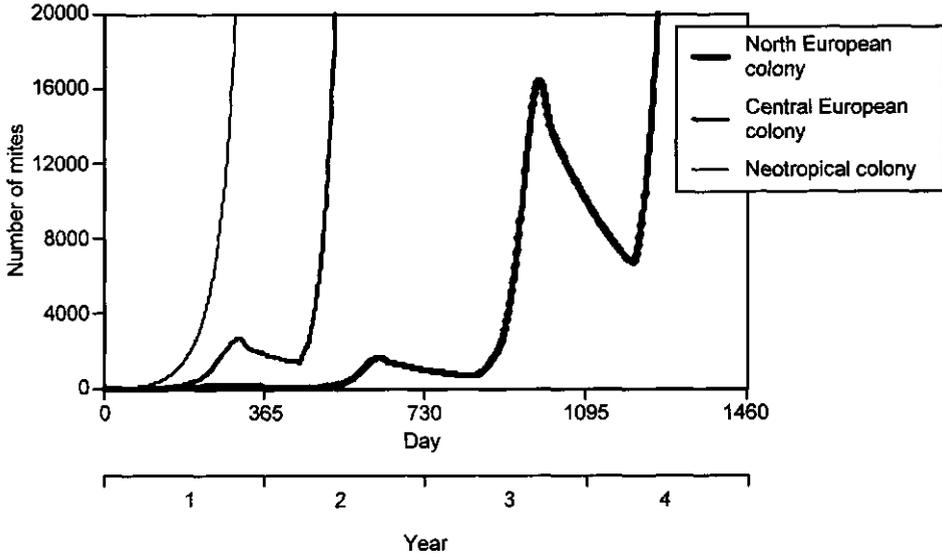

Figure 3: Mite population growth in relation to honey bee colony development.

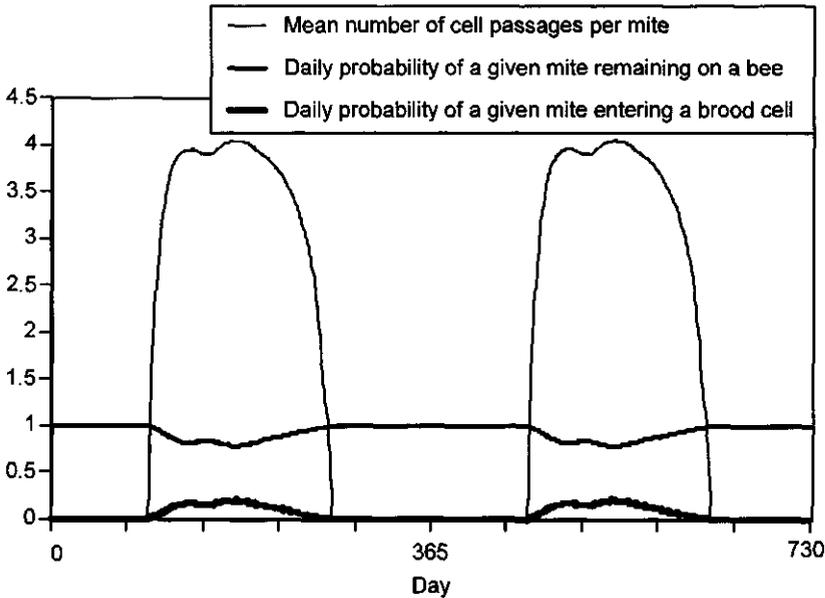

Figure 4: Number of cell passages for a single mite.

Cell passages, distribution over bees and brood, mortality rate

Another way to test model predictions is to compare the number of cell passages made by an individual mite. A probabilistic model of mite behaviour can be used to calculate the number of cell passages made by a single mite. Suppose that, on a given day, a mite may be either on a bee or in a cell, and that the daily probabilities of transition between these states are

$$b = \text{Pr}(\text{mite on bee on day } i \mid \text{mite on bee on day } i-1)$$

$$c = \text{Pr}(\text{mite in cell on day } i \mid \text{mite on bee on day } i-1)$$

$$d = \text{Pr}(\text{mite dies on day } i \mid \text{mite on bee on day } i)$$

$$e = \text{Pr}(\text{mite dies during cell passage} \mid \text{mite already in cell}),$$

then the probability distribution of N , the number of cell passages made by an individual mite, is given by:

$$\text{Pr}(N=n) = \{c(1-e)/(1-b)\}^n \{d/(1-b) + e/(1-e)\} \quad (\text{for } n > 0)$$

and

$$\text{Pr}(N=0) = d / (1-b)$$

Further analysis shows that the mean $\langle N \rangle$ of this distribution is

$$\langle N \rangle = c / (d + ce).$$

In our model we have an emergent mite mortality, e , of 22 %. The death rate during the phoretic phase, d , is 0.006/day as in our model. Values of b and of c are calculated by the model on each day of a simulation as being the proportion of mites which remain on bees and enter a cell, respectively, as shown in Figure 4. The mean number of cell passages per mite (Figure 4) is, during the brood-rearing period, fairly constant at about 4, an estimate that contrasts with the findings of Fries & Rosenkranz (1996). They made observations on the number of cell passages and suggest that this figure lies between 1.5 and 2.0 per mite. They observed an average loss of about 50% of the mites per cell passage, from which we can calculate the number of cell passages to be 1.8. However, in their experiment the loss of mites during the first cell passage was much higher than in the subsequent cell passages. If we disregard this initial loss of mites, as it may have been due to the experimental procedure of introducing the mites into the colonies, the number of cell passages may well be as high as we have now calculated.

The model also predicts the distribution of mites over adult bees and brood. As soon as brood rearing starts the mites start invading brood cells and a distribution pattern is generated as shown in Figure 5, which is in agreement with empirical determined distributions (Fuchs 1985). Figure 5 also shows the daily rate of mite mortality inside the bee colony, including mortality of phoretic mites inside the colony and mortality upon emergence. The mortality rate inside the colony is especially relevant because it is virtually the only feature of the mite's population dynamics which is easily observable. Daily mortality is, for almost the entire brood-rearing period, between 1% and 2% of the mite population.

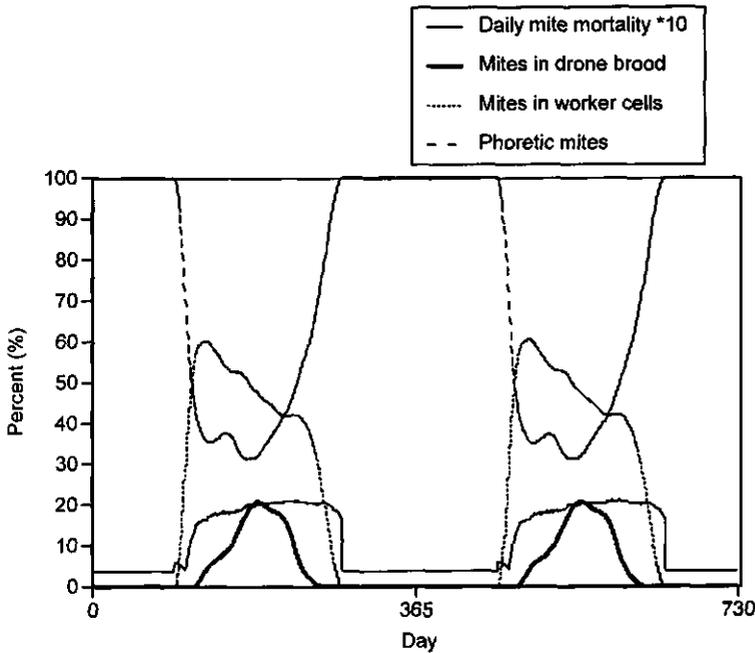

Figure 5: Distribution of mites over worker and drone brood and bees and daily mite mortality using the northern European colony model.

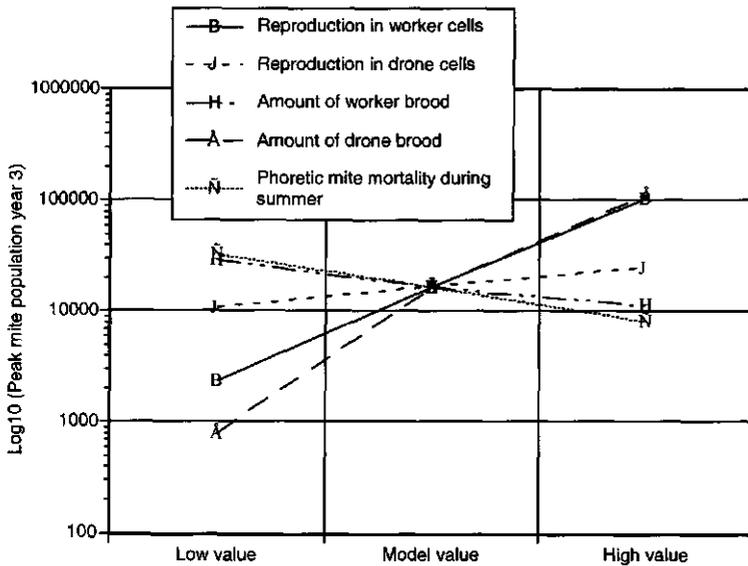

Figure 6: Sensitivity of peak mite populations in year 3 to changes in model parameters.

Sensitivity analysis

Variation of one parameter at a time will help to assess influence of that parameter on the model predictions. Parameters that have the largest impact on mite population growth are those relevant for manipulation by the beekeeper or for obtaining Mite resistant bees through selection. In Figure 6 we show the effect on the peak mite population in year 3 by altering (1) the mean number of female offspring in a cell with female offspring in worker and drone cells respectively (the effective reproductive success of the mite becomes less because of factors such as male mortality and infertility), (2) the quantity of drone and worker brood cells present in the colony and (3) phoretic mite mortality during the summer. The values used are shown in table 2.

Table 2. Values used for sensitivity analysis

	Low	Medium	High
Mean number of female offspring, worker cells	1.25	1.45	1.75
Mean number of female offspring, drone cells	2.4	2.7	3.0
Quantity of drone brood	0	100%	200%
Quantity of worker brood	50%	100%	150%
Summer mite mortality	0.003	0.006	0.009

The medium values are standard parameter values

Reproductive success has a large impact on population growth, and honey bee traits that influence the reproductive success may be relevant for selection of mite resistant bees. Also increased phoretic mortality, e.g. due to grooming behaviour of the bees has a large impact on population growth. The quantity of drone brood present in the colony, relatively easily manipulated by the beekeeper, also has a strong effect on population growth. Decreasing the amount of worker brood, which gives the same results as decreasing attractiveness of the worker brood, has the counterintuitive effect of somewhat increasing mite population levels, due to the higher proportion of mites which invade drone brood.

Responses to treatment regimes

The following three types of *V. jacobsoni* control methods are used:

1. Biotechnical methods, such as drone culling and queen trapping; these methods are generally labour-intensive, but carry no risk of contamination of stores and may be used during the summer period;
2. Methods based on (environmentally safe) organic acids, such as oxalic, lactic or formic acids, or on essential oils; again these can be time-consuming to use, but can be effective;
3. Methods based on synthetic acaricides such as Bayvarol (e.g. flumethrin) or Apistan (e.g. fluvalinate), which are often highly effective, but contaminate bee products and eventually reduce acaricide susceptibility of the mites through continued use. Synthetic acaricides should only be applied at the end of the season.

Here, we have modelled the effect of using drone culling in a systematic way, and of using an acid treatment in both summer and winter.

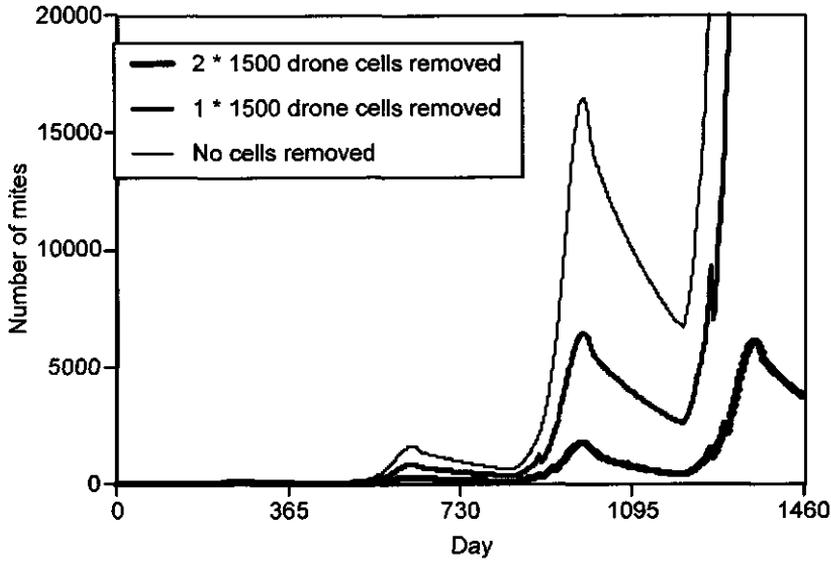

Figure 7: Effect of simulated drone brood removal.

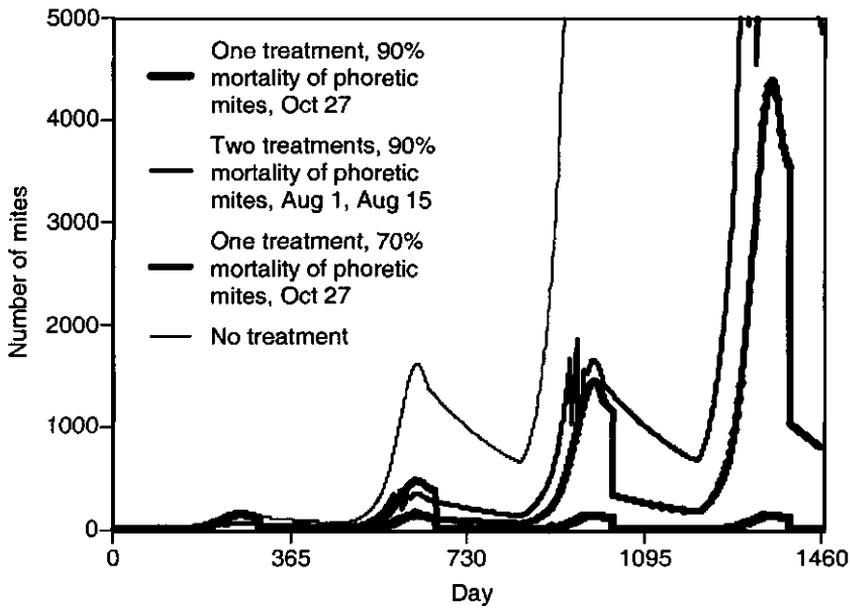

Figure 8: Effect of simulated acid treatments

Drone culling

This control method involves the introduction of drone combs and their removal after sealing during the brood-rearing season. The preference of *V. jacobsoni* for drone rather than worker brood (e.g. Boot et al. 1995a) means that a large proportion of mites inside brood cells will be in drone cells, and removal of relatively small amounts of drone brood cells therefore provides a way of destroying mites.

We have modelled drone brood removal by supposing that a drone comb is introduced into the brood nest, that the bees raise 1500 drone larvae in this comb, that the brood cells are invaded by phoretic mites as described and are capped at a constant rate over a one week period, and that the comb is removed after sealing together with the trapped mites. The model predicts a considerable effect on the mite population (Figure 7). A repeated insertion and removal of drone brood, once on 1 June and once on 1 July, reduces the peak mite population in year 3 from about 16 000 to about 1750 if there is no reinvasion. This is in agreement with field observations from removing drone brood (Rosenkranz & Engels 1985).

Acid treatments

Lactic and oxalic acids have been found to kill over 80% of mites on adults (not in cells) at the time of treatment (Imdorf, 1996; Kraus & Berg, 1994). They are most useful when applied outside the brood-rearing period, in late autumn or winter, but are also useful at other times of year as a "knock-down" treatment.

We have modelled the effect of acid treatment by assuming that a pre-determined proportion of mites present on bees are killed at the time of the application. We have compared the effects of a single treatment in autumn after the end of the brood-rearing period, with two treatments in summer. A single annual treatment on 27 October with a mortality rate of 90% results in a population level which is very low and stable provided that there is no re-invasion of mites (Figure 8). Under central European brood conditions, this is not sufficient because of the longer breeding period of the mite (data not shown). However, a mortality rate of only 70% in this late treatment results in a population level which increases over a few years to levels which are likely to be fatal to the colony. The use of two treatments in summer is not an acceptable alternative: even with a mortality rate of 90%, the mite build-up is considerable over several years (Figure 8). With brood produced outside of the relatively short brood rearing period normal for Scotland (Allen, 1965), the requirement of treatment efficacy will be even higher.

Colony reinvasion

The numbers of new mites invading the colony can be considerable (Sakofski et al., 1990). In figure 9 we show how the mite population responds to a reinvasion of 5 mites per day during autumn, from 7 October to 16 November. As would be expected, the population increases faster than would be the case with no such reinvasion.

Despite reinvasion, a treatment with a mortality rate of 90% applied on 7 October (i.e. before the start of the invasion) reduces the population to a level at which the annual increase is sustainable using Scottish brood data (Allen, 1965).

Conclusions

In conclusion, since brood cell invasion is crucial in the life cycle of *V. jacobsoni*, the integration of knowledge on brood cell invasion into the population dynamics model

of Fries et al. (1994) allows more realistic simulations of mite populations. The model can be used as a tool to evaluate control strategies, to evaluate the impact of honey bee traits that may lead to resistant bees, and to gain insight into the mite-bee relationship. It should be emphasised that for a realistic simulation of the *V. jacobsoni* population dynamics in a particular area using this model, it is vital to use brood data that is relevant for the situation for which predictions are to be made. The model is summarised in Appendix 1 and will be made available on disk for researchers and beekeepers using the "Stella"-software package that runs on a personal computers.

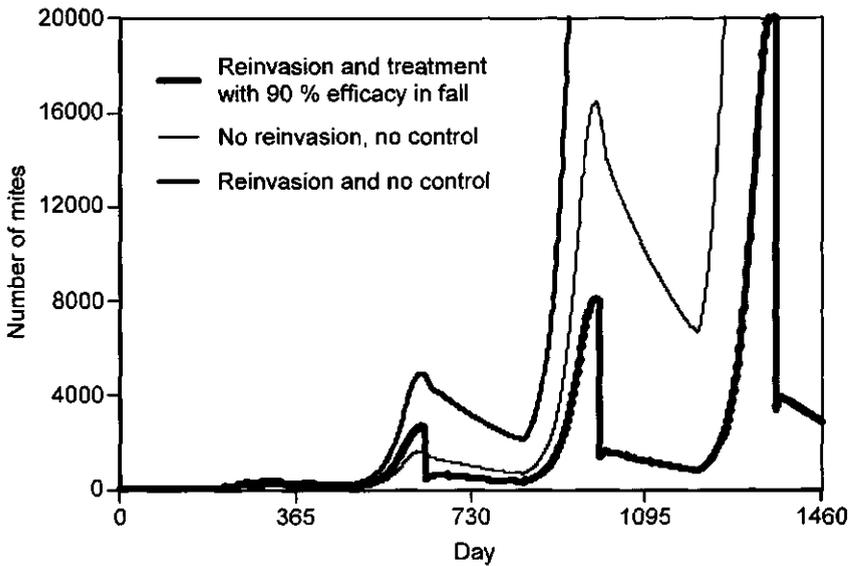

Figure 9: Effect of autumn invasion on mite populations

Acknowledgements SCR gratefully acknowledges financial assistance in the form of a travel grant from the C.B. Dennis British Beekeepers' Research Trust. We thank J. Beetsma, M. Beekman, W.J. Boot, J.C. van Lenteren and M.W. Sabelis for their valuable comments on drafts of the manuscript.

Appendix 1: Summary of *Varroa jacobsoni* model

Consider female mites only, and let:

P_n be the number of phoretic mites on day n ,

I_n be the number of phoretic mites which enter a brood cell on day n ,

E_n be the number of mites which emerge from cells with the adult bee on day n (including the original mother mite)

and

M_n be the number of phoretic mites which die on day n .

Then the equation governing the *V. jacobsoni* model is

$$P_n = P_{n-1} + E_n - I_n - M_n$$

with

$$E_n = I_{w,n-Nw} R_w r_{w,n} / (r_{w,n} + r_{d,n}) + I_{d,n-Nd} R_d r_{d,n} / (r_{w,n} + r_{d,n})$$

$$I_n = P_n \{1 - \exp(-(r_{d,n} + r_{w,n}))\}$$

$$M_n = k P_n$$

where

$I_{w,n}$, $I_{d,n}$ are the number of mites entering worker and drone brood cells respectively on day n , evaluated as:

$$I_{w,n} = I_n r_{w,n} / (r_{w,n} + r_{d,n}) \quad \text{and} \quad I_{d,n} = I_n r_{d,n} / (r_{w,n} + r_{d,n}),$$

Nw , Nd are the postcapping periods for worker and drone brood respectively,

$r_{w,n}$ is the proportion of phoretic mites entering cells on day n which enter worker cells, evaluated thus:

$$r_{w,n} = -0.56 W_n / B_n$$

$r_{d,n}$ is the proportion of phoretic mites entering cells on day n which enter drone cells, evaluated thus:

$$r_{d,n} = -6.49 D_n / B_n$$

R_w , R_d are fixed parameters representing reproductive success, namely the number of living mites, including the mother, which emerge from a worker and a drone brood cell respectively; k is the (fixed) daily mortality rate and where W_n (the number of worker cells available for entry by mites on day n), D_n (the number of drone cells available for entry by mites on day n), B_n (the mass in grams of adult bees in the colony on day n) are pre-determined functions of time which constitute the 'colony model'.

Appendix 2: Stella equations

```

Bodensee_data_D = 0.04*Bodensee_data_total
Bodensee_data_W = 0.96*Bodensee_data_total
Brood_data_switch = 0
No_Drone_cells_precull =
(IF(Brood_data_switch=1)THEN(Yucatan_data_D)ELSE(IF(Brood_data_switch=0)THEN(Allen_data_D)ELSE(IF(Brood_data_switch=2)THEN(Bodensee_data_D)ELSE(Allen_data_D))))
No_worker_cells =
(IF(Brood_data_switch=1)THEN(Yucatan_data_W)ELSE(IF(Brood_data_switch=0)THEN(Allen_data_W)ELSE(IF(Brood_data_switch=2)THEN(Bodensee_data_W)ELSE(Allen_data_W))))
Yucatan_data_D = 0.04*Yucatan_data_W
Allen_data_D = GRAPH(day_of_year)
(0.00, 0.00), (10.4, 0.00), (20.9, 0.00), (31.3, 0.00), (41.7, 0.00), (52.1, 0.00), (62.6, 0.00), (73.0, 0.00), (83.4, 0.00), (93.9, 0.00), (104, 0.00), (115, 0.00), (125, 65.0), (136, 112), (146, 174), (156, 298), (167, 589), (177, 899), (188, 992), (198, 893), (209, 868), (219, 561), (229, 164), (240, 43.0), (250, 0.00), (261, 0.00), (271, 0.00), (282, 0.00), (292, 0.00), (302, 0.00), (313, 0.00), (323, 0.00), (334, 0.00), (344, 0.00), (355, 0.00), (365, 0.00)
Allen_data_W = GRAPH(day_of_year)
(0.00, 0.00), (10.4, 0.00), (20.9, 0.00), (31.3, 0.00), (41.7, 0.00), (52.1, 0.00), (62.6, 0.00), (73.0, 0.00), (83.4, 0.00), (93.9, 0.00), (104, 2140), (115, 5700), (125, 8800), (136, 11800), (146, 13240), (156, 15620), (167, 20880), (177, 23900), (188, 25780), (198, 25220), (209, 23380), (219, 21400), (229, 17960), (240, 12600), (250, 7300), (261, 2200), (271, 0.00), (282, 0.00), (292, 0.00), (302, 0.00), (313, 0.00), (323, 0.00), (334, 0.00), (344, 0.00), (355, 0.00), (365, 0.00)
Bodensee_data_total = GRAPH(day_of_year)
(0.00, 0.00), (21.5, 0.00), (42.9, 0.00), (64.4, 0.00), (85.9, 7668), (107, 13688), (129, 26949), (150, 35123), (172, 38343), (193, 27411), (215, 28279), (236, 24120), (258, 14321), (279, 5632), (301, 116), (322, 0.00), (344, 0.00), (365, 0.00)
Yucatan_data_W = GRAPH(day_of_year)
(0.00, 16254), (30.4, 17451), (60.8, 22071), (91.2, 24024), (122, 24500), (152, 16989), (182, 13482), (213, 9702), (243, 8001), (274, 10437), (304, 9954), (335, 14553), (365, 16254)
Length_of_summer(t) = Length_of_summer(t - dt) + (Summer_days) * dt
INIT Length_of_summer = 0
Summer_days = IF(((season=1)OR(Season=2)OR(Season=3))AND(Time<365))THEN(1) ELSE(0)
No_bees_at_day_of_last_brood_W(t) = No_bees_at_day_of_last_brood_W(t - dt) + (Rate_of_no_bees_at_day_of_last_W_brood) * dt
INIT No_bees_at_day_of_last_brood_W = No_bees_at_end_of_winter
Rate_of_no_bees_at_day_of_last_W_brood = IF((Season=4)AND(delay(season,1)=3)) THEN(Number_of_bees-No_bees_at_day_of_last_brood_W) ELSE(0)
Number_of_bees(t) = Number_of_bees(t - dt) + (Birth_rate_of_bees - Death_rate_of_bees) * dt
INIT Number_of_bees = 12300
Birth_rate_of_bees = ((DELAY(Emerging_worker_cells,Postcapping_time_W)) + (DELAY(Emerging_drone_cells,Postcapping_time_D)))
Death_rate_of_bees = IF(Season=1)THEN(0)ELSE( IF((Season=2)OR(Season=3))THEN(IF(tropical_start?=1)THEN(0)ELSE(Summer_bee_mortality))ELSE( IF(Total_bees_born=0)THEN(0.002*Number_of_bees)ELSE( ((1- EXP(LOGN(No_bees_at_end_of_winter/No_bees_at_day_of_last_brood_W)/Length_of_winter))* Number_of_bees))))
Total_bees_born(t) = Total_bees_born(t - dt) + (Birth_rate_of_bees_copy) * dt
INIT Total_bees_born = 0
Birth_rate_of_bees_copy = Birth_rate_of_bees

```

```

colony_weight = Number_of_bees*0.12
development_period_D = 24
development_period_W = 21
Emerging_drone_cells = number_drone_cells/development_period_D
Emerging_worker_cells = no_worker_cells/development_period_W
Length_of_winter = 365-Length_of_summer-1
No_bees_at_end_of_winter = 10000
Postcapping_time_D = 14
Postcapping_time_W = 12
Season = IF(no_worker_cells>0)THEN
  (IF(Birth_rate_of_bees>0)THEN(2)ELSE(1))
  ELSE(IF(Birth_rate_of_bees>0)THEN(3)ELSE(4))
Summer_bee_lifespan = 31
Summer_bee_mortality = DELAY(Birth_rate_of_bees,Summer_bee_lifespan)
Tropical_start? = IF((season=2)AND(Time<32))Then(1) Else(0)
Mites_in_D_comb(t) = Mites_in_D_comb(t - dt) + (Drone_brood_invasion -
Mites_out_from_D_brood) * dt
INIT Mites_in_D_comb = 0
Drone_brood_invasion = drone_cell_entry
Mites_out_from_D_brood = DELAY(Drone_brood_invasion,Postcapping_time_D)
Days_cells_1_added = 152
Days_cells_2_added = 182
Drone_cells_added_1 = 0/Extra_D_brood_duration
Drone_cells_added_2 = 0/Extra_D_brood_duration
Extra_cells_D =
IF((day_of_year>Days_cells_1_added)AND(day_of_year<Days_cells_1_added+Extra_D_brood_
duration))THEN(Drone_cells_added_1)ELSE(IF((day_of_year>Days_cells_2_added)AND(day_of
_year<Days_cells_2_added+Extra_D_brood_duration))THEN(Drone_cells_added_2)ELSE(0))
Extra_D_brood_duration = 7
Mites_into_trap_D_comb_1 =
IF(((day_of_year>=(Days_cells_1_added)AND(day_of_year<=(Days_cells_1_added+Extra_D_br
ood_duration))))
)THEN(Number_mites_in_added_1) ELSE (0)
Mites_into_trap_D_comb_2 =
IF(((day_of_year>=(Days_cells_2_added)AND(day_of_year<=(Days_cells_2_added+Extra_D_bro
od_duration))))THEN(Number_mites_in_added_2) ELSE (0)
Mites_removed_with_D_brood = Mites_into_trap_D_comb_1+Mites_into_trap_D_comb_2
Number_mites_in_added_1 = Mites_in_D_comb*proportion_added_cells_1
Number_mites_in_added_2 = Mites_in_D_comb*proportion_added_cells_2
proportion_added_cells_1 =
IF(Drone_cells_added_1>1)THEN(Drone_cells_added_1/(No_Drone_cells_precull+Drone_cells_
added_1))ELSE(0)
proportion_added_cells_2 =
IF(Drone_cells_added_2>1)THEN(Drone_cells_added_2/(No_Drone_cells_precull+Drone_cells_
added_2))ELSE(0)
total_brood_mites = worker_cell_mites+Mites_in_D_comb
worker_cell_mites = sum(
delay(worker_cell_entry,0),delay(worker_cell_entry,1),delay(worker_cell_entry,2),delay(worker_c
ell_entry,3),delay(worker_cell_entry,4),delay(worker_cell_entry,5),delay(worker_cell_entry,6),dela
y(worker_cell_entry,7),delay(worker_cell_entry,8),delay(worker_cell_entry,9),delay(worker_cell_e
ntry,10),delay(worker_cell_entry,11))
Foragers_relative_infestation_rate = 1/3.3
Infestation_rate_of_foragers =
Phoretic_Mites/Number_of_bees*Foragers_relative_infestation_rate
Mites_falling_from_bees = Phoretic_Mites*Summer_mite_mortality_factor

```

```

Phoretic_mite_mortality =
IF(total_brood_mites=0)THEN(Winter_mite_mortality)ELSE(Summer_mite_mortality)
Summer_mite_mortality =
(Summer_bee_mortality*Infestation_rate_of_foragers)+Mites_falling_from_bees
Summer_mite_mortality_factor = 0.006
Winter_mite_mortality = 0.004*Phoretic_Mites
day_of_simulation(t) = day_of_simulation(t - dt) + (time_rate) * dt
INIT day_of_simulation = 1
time_rate = 1
Phoretic_Mites(t) = Phoretic_Mites(t - dt) + (Mites_from_drone_cells + mites_from_worker_cells +
Mites_from_outside - phoretic_death - drone_cell_entry - worker_cell_entry -
Death_by_Treatment) * dt
INIT Phoretic_Mites = 10
Mites_from_drone_cells = (DELAY(((drone_cell_entry-
Mites_removed_with_D_brood)*offspring_D),D_Postcapping_period)+DELAY((drone_cell_entry-
Mites_removed_with_D_brood),D_Postcapping_period))*Emergence_mite_mortality_factor
mites_from_worker_cells = (DELAY(worker_cell_entry*offspring_W,W_Postcapping_period)+
DELAY(worker_cell_entry,W_Postcapping_period))*Emergence_mite_mortality_factor
Mites_from_outside = Invading_mites
phoretic_death = Phoretic_mite_mortality
drone_cell_entry = (Phoretic_Mites*Invasion_rate_into_drone_brood)
worker_cell_entry = (Phoretic_Mites*Invasion_rate_into_worker_brood)
Death_by_Treatment =
IF(day_of_year=Day_of_treatment_1)THEN(Phoretic_Mites*Effectiveness_1)ELSE(if(day_of_yea
r=Day_of_treatment_2)THEN(Phoretic_Mites*Effectiveness_2)ELSE(0))
Available_drone_cells = ((number_drone_cells/development_period_D)+Extra_cells_D)
Available_worker_cells = (no_worker_cells/(development_period_W))
Daily_mite_mortality_100_times_10 =
10*(((mites_from_worker_cells+Mites_from_drone_cells)*(1-
Emergence_mite_mortality_factor))+phoretic_death)/total_live_mites)*100
Day_of_treatment_1 = 271
Day_of_treatment_2 = 228
day_of_year = MOD(day_of_simulation,365)
delayed_WCell_Entry = DELAY(worker_cell_entry,Postcapping_time_W)
derivative = DERIVN(log_total_live_mites,1)
Drone_brood:bee_ratio = Available_drone_cells/colony_weight*1000
D_Postcapping_period = 14
Effectiveness_1 = 0
Effectiveness_2 = 0
Emergence_mite_mortality_factor = .764+3*0.006
Emergence_Ratio_W = IF(delayed_WCell_Entry>0)
THEN(mites_from_worker_cells/delayed_WCell_Entry) ELSE(0)
fraction_drone_cells = if (no_worker_cells+number_drone_cells) > 0 then
number_drone_cells/(no_worker_cells+number_drone_cells) else 0
infertility_D = 0.05
infertility_W = 0.15
Invaders_per_day = 0
Invading_mites =
IF((day_of_year>=Invasion_start)AND(day_of_year<=Invasion_end))THEN(Invaders_per_day)EL
SE(0)
Invasion_end = 304
Invasion_rate_drones = 6.49*Available_drone_cells/colony_weight
Invasion_rate_into_drone_brood = IF(Invasion_rate_drones+Invasion_rate_workers=0) THEN(0)
ELSE
(Invasion_rate_drones/(Invasion_rate_drones+Invasion_rate_workers))*(1-exp(-
(Invasion_rate_drones+Invasion_rate_workers))))

```

```

Invasion_rate_into_worker_brood = IF(Invasion_rate_drones+Invasion_rate_workers=0) THEN(0)
ELSE
  (Invasion_rate_workers/(Invasion_rate_drones+Invasion_rate_workers)*(1-exp(-
  (Invasion_rate_drones+Invasion_rate_workers))))
Invasion_rate_workers = 0.56*Available_worker_cells/colony_weight
Invasion_start = 243
log_total_live_mites = LOGN(total_live_mites)
Males_only_D = 0.09
Males_only_W = 0.05
Mean_cell_trips_per_mite = prob_c/(prob_d+prob_c*prob_e)
number_drone_cells = (No_Drone_cells_precull+Extra_cells_D)
offspring_D = Postcapping_influence_D*Offspring_per_mother_D*(1-preoviposition_mortalityD-
uncapping_factor-Males_only_D-infertility_D)
Offspring_per_mother_D = 2.7
Offspring_per_mother_W = 1.45
offspring_W = Postcapping_influence_W*Offspring_per_mother_W*(1-preoviposition_mortalityW-
uncapping_factor-Males_only_W-infertility_W)
Percent_mites_in_D_cells = (Mites_in_D_comb/total_live_mites)*100
Percent_mites_in_W_cells = (worker_cell_mites/total_live_mites)*100
Percent_phoretic_mites = (Phoretic_Mites/total_live_mites)*100
preoviposition_mortalityD = 0.08
preoviposition_mortalityW = 0.02
prob_b = 1-prob_c-prob_d
prob_c = 1-EXP(-Invasion_rate_drones-Invasion_rate_workers)
prob_d = Summer_mite_mortality_factor
prob_e = 1-Emergence_mite_mortality_factor
ratio_brood_to_total = total_brood_mites/(total_brood_mites+Phoretic_Mites)
Total_brood_cells = no_worker_cells+number_drone_cells
total_live_mites = Phoretic_Mites+total_brood_mites
uncapping_factor = 0.05
W_Postcapping_period = 12
Postcapping_influence_D = GRAPH(Postcapping_time_D)
(12.0, 0.5), (12.4, 0.6), (12.8, 0.7), (13.2, 0.8), (13.6, 0.892), (14.0, 1.00), (14.4, 1.10), (14.8,
1.20), (15.2, 1.30), (15.6, 1.40), (16.0, 1.50)
Postcapping_influence_W = GRAPH(Postcapping_time_W)
(11.0, 0.5), (11.2, 0.6), (11.4, 0.7), (11.6, 0.8), (11.8, 0.9), (12.0, 1.00), (12.2, 1.10), (12.4, 1.20),
(12.6, 1.30), (12.8, 1.40), (13.0, 1.50)

```

References

- Allen, MD (1965) The effect of a plentiful supply of drone comb on colonies of honeybees. *Journal of Apicultural Research* 4: 109-119.
- Boot, WJ, Beetsma, J & Calis, JNM (1994) Behaviour of *Varroa* mites invading honey bee brood cells. *Experimental & Applied Acarology* 18: 371-379.
- Boot, WJ, Schoenmaker, J, Calis, JNM & Beetsma, J (1995a) Invasion of *Varroa* mites into drone brood cells of the honey bee. *Apidologie* 26: 109-118.
- Boot, WJ, Calis, JNM & Beetsma, J (1995b) Does time spent on adult bees affect reproductive success of *Varroa* mites? *Entomologia Experimentalis et Applicata* 75: 1-7.
- Büchler, R & Drescher, W (1990) Variance and heritability of the capped developmental stage in European *Apis mellifera* L. and its correlation with increased *Varroa jacobsoni* infestation. *Journal of Apicultural Research* 29: 172-176.
- Calatayud, F & Verdu, MJ (1995) Number of Adult Female Mites *Varroa jacobsoni* Oud. on hive debris from honeybee colonies artificially infested to monitor mite population increase. *Experimental & Applied Acarology* 19: 181-188.
- Calis, JNM, Beetsma, J, Boot, WJ, Eijnde, JHPM van den, Ruijter, A. de & Steen, JJM van der, (1998) Control of *Varroa* by combining trapping in honey bee worker brood with formic acid

- treatment of the capped brood outside the colony: Putting knowledge on brood cell invasion into practice. Chapter 2, *Journal of Apicultural Research*, 37: 205-215.
- Calis, JNM, Beetsma, J, Boot, WJ, Eijnde, JHPM van den, Ruijter, A de & Steen JJM van der (1999) Effective biotechnical control of *Varroa*: applying knowledge on brood cell invasion to trap honey bee parasites in drone brood. Chapter 3, *Journal of Apicultural Research*, 38: 49-61.
- Camazine, S (1988) Factors affecting the severity of *Varroa jacobsoni* infestations on European and Africanized honey bees. In G.R. Needham et al. (editors) *Africanized honeybees and bee mites*. Ellis Horwood limited, Chichester, pp. 444-451.
- Donzé, G, Herrmann, M, Bachofen, B & Guerin, PM (1996) Effect of mating frequency and brood cell infestation rate on the reproductive success of the honeybee parasite *Varroa jacobsoni*. *Ecological Entomology* 21: 17-26.
- Echazaretta, CM & Paxton, RJ (1997) Comparative colony development of Africanized and European honey bees (*Apis mellifera*) in lowland neotropical Yucatan, Mexico. *Journal of Apicultural Research* 36: 89-103.
- Fries, I, Camazine, S & Sneyd, J (1994) Population dynamics of *Varroa jacobsoni*: a model and a review. *Bee World* 75: 5-28.
- Fries, I & Rosenkranz, P (1996) Number of Reproductive Cycles of *Varroa jacobsoni* in honeybee (*Apis mellifera*) colonies. *Experimental & Applied Acarology* 20: 103-112.
- Fuchs, S (1995) Untersuchungen zur Quantitativen Abschätzung des Befalls von Bienenvölkern mit *Varroa jacobsoni* Oudemans und zur Verteilung des Parasiten im Bienenvolk. *Apidologie* 16: 343-368.
- Fuchs, S (1985) Untersuchungen zur Quantitativen Abschätzung des Befalls von Bienenvölkern mit *Varroa jacobsoni* Oudemans und zur Verteilung des Parasiten im Bienenvolk. *Apidologie* 16: 343-368.
- Fuchs, S & Langenbach, K (1998) Multiple infestation of *Apis mellifera* L. brood cells and reproduction in *Varroa jacobsoni* Oud. *Apidologie* 20: 257-266.
- García-Fernández, P, Benítez Rodríguez, R & Orantes-Bermejo, FJ (1995) Influence of climate on the evolution of the population dynamics of the *Varroa* mite on honeybees in the south of Spain. *Apidologie* 26: 371-380.
- Imdorf, A, Charriere, J-D, Maquelin, C, Kilchenmann, V & Bachofen, B (1996) Alternative *Varroa* Control. *American Bee Journal* 136: 189-193.
- Korpela, S, Aarhus, A, Fries, I & Hansen, H (1992) *Varroa jacobsoni* Oud. in cold climates: population growth, winter mortality and influence on the survival of honey bee. *Journal of Apicultural Research* 31: 157-164.
- Kraus, B & Berg, S (1994) Effect of a lactic acid treatment during winter in temperate climate upon *Varroa jacobsoni* Oud. and the bee (*Apis mellifera* L.) colony. *Experimental & Applied Acarology* 18: 459-468.
- Kraus, B & Page, RE Jr. (1995) Population growth of *Varroa jacobsoni* Oud. in Mediterranean climates of California. *Apidologie* 26: 149-157.
- Kraus, B, Koeniger, N & Fuchs, S (1986) Unterscheidung zwischen Bienen verschiedenen alters durch *Varroa jacobsoni* Oud. und bevorzugung von Ammenbienen im Sommervolk. *Apidologie* 17: 257-266.
- Kustermann, T (1990) Populationsstruktur der *Varroa*-milbe. *Deutsches Imker-Journal* 1: 436-437.
- Martin, SJ (1994) Ontogenesis of the mite *Varroa jacobsoni* Oud. in worker brood of the honeybee *Apis mellifera* L. under natural conditions. *Experimental & Applied Acarology* 18: 87-100.
- Martin, SJ (1995) Ontogenesis of the mite *Varroa jacobsoni* Oud. in drone brood of the honeybee *Apis mellifera* L. under natural conditions. *Experimental & Applied Acarology* 19: 199-210.
- Martin, SJ (1998) A population model for the ectoparasitic mite *Varroa jacobsoni* in honey bee (*Apis mellifera*) colonies. *Ecological Modelling* 109: 267-281.
- Moosbeckhofer, R, Fabsicz, M & Kohlich, A (1988) Untersuchungen über die Abhängigkeit der Nachkommensrate von *Varroa jacobsoni* Oud. vom Befallsgrad der Bienenvölker. *Apidologie* 19: 181-208.

-
- Omholt, SW & Crailsheim, K (1991) The possible prediction of the degree of infestation of honeybee colonies (*Apis mellifera*) by *Varroa jacobsoni* Oud. by means of its natural death-rate: a dynamic model approach. *Norwegian journal of Agricultural Sciences* 5: 393-400.
- Rosenkranz, P & Engels, W (1985) Konsequente Dronenbrutentnahme, eine wirksame biotechnische Massnahme zur Minderung von *Varroa*-Schäden an Bienenvölkern. *Allgemeine Deutsche Imkerzeitung* 21: 265-271
- Sakofski, F, Koeniger, N & Fuchs, S (1990) Seasonality of honey bee colony invasion by *Varroa jacobsoni* Oud. *Apidologie* 21: 547-550.
- Schultz, A E (1984) Reproduktion und Populationsentwicklung der parasitischen Milbe *Varroa jacobsoni* Oud. in abh angigkeit vom Brutzyklus ihres Wirtes *Apis mellifera* L. *Apidologie* 15: 401-420.
- Taranov, GF & Azimov, TN (1972) The length of life of honey bees (in Russian), *Pchelovodstvo* 92: 16-17.

Natural selection of *Varroa jacobsoni* explains the different reproductive strategies in colonies of *Apis cerana* and *Apis mellifera*.

Abstract

In colonies of European *Apis mellifera*, *Varroa jacobsoni* reproduces both in drone and in worker cells. In colonies of its original Asian host, *Apis cerana*, the mites invade both drone and worker brood cells, but reproduce only in drone cells. Absence of reproduction in worker cells is probably crucial for the tolerance of *A. cerana* to *V. jacobsoni* because it implies that the mite population can only grow during periods in which drones are reared. To test if non-reproduction of *V. jacobsoni* in worker brood cells of *A. cerana* is due to a trait of the mites or of the honey bee species, mites from bees in *A. mellifera* colonies were artificially introduced into *A. cerana* worker brood cells and vice versa. Approximately 80% of the mites from *A. mellifera* colonies reproduced in naturally infested worker cells as well as when introduced into worker cells of *A. mellifera* and *A. cerana*. Conversely, only 10% of the mites from *A. cerana* colonies reproduced, both in naturally infested worker cells of *A. cerana* and when introduced into worker cells of *A. mellifera*. Hence, absence of reproduction in worker cells is due to a trait of the mites. Additional experiments showed that *A. cerana* bees removed 84% of the worker brood that was artificially infested with mites from *A. mellifera* colonies. Brood removal started two days after artificial infestation, which suggested that the bees responded to behaviour of the mites. Since removal behaviour of the bees will have a large impact on fitness of the mites, it probably plays an important role in selection for differential reproductive strategies. Our findings have large implications for selection programmes to breed less-susceptible bee strains. If differences in non-reproduction are mite specific, we should not only look for non-reproduction as such, but for colonies in which non-reproduction in worker cells is selected. Hence, in selection programmes fitness of mites that reproduce in both drone and worker cells should be compared to fitness of mites that reproduce only in drone cells.

Introduction

Varroa jacobsoni is worldwide considered as the most important pest of the Western honey bee, *Apis mellifera* (Matheson, 1993). Originally, this mite only occurred in colonies of the Eastern honey bee, *A. cerana*, which is restricted to Asia. The first record of the *Varroa* described the mite as a parasite of *A. cerana* in Indonesia (Oudemans, 1904). In the 50 years that followed Oudemans' observations, however, almost no reports were issued on this mite (Ritter, 1981). This lack of interest illustrates that the *Varroa* mite is not considered a problem in *A. cerana* colonies, although the actual damage inflicted has never been determined. *Varroa* developed from a harmless curiosity into a universal threat to bee-keeping after bee-keepers moved *A. mellifera* into the distribution area of *A. cerana*. *Varroa* started to parasitize *A. mellifera* wherever it had access to it (Ritter, 1981). On its new host, the mite appeared to be a much more harmful parasite than on its original host, but before bee-keepers realized this the mite had spread all over the world through shipments of colonies and queens (De Jong et al., 1982; Matheson, 1993, 1995).

Not all races of *A. mellifera* are equally susceptible to the mites. Much research is therefore directed to study factors that underlie reduced susceptibility. Differential reproductive behaviour of the mites seems to be a key-factor (Büchler, 1994;

Rosenkranz & Engels, 1994). In order to reproduce, *Varroa* must invade brood cells of honey-bees. In European *A. mellifera* colonies the mites reproduce both in drone and in worker cells and the population of mites grows rapidly (Fries et al., 1994). In colonies of its original host, *A. cerana*, the mites invade both drone and worker brood cells, but they do not reproduce after invasion into a worker cell (Boot et al., 1997). Thus, the mite population can only grow during periods in which drones are reared. In African and Africanized *A. mellifera* the same phenomenon occurs, albeit less conspicuously: a high percentage of the mites do not reproduce after invading worker cells (e.g. Camazine, 1986; Ritter, 1993). Like *A. cerana*, African and Africanized *A. mellifera* appear to be much less susceptible to *Varroa*, probably due to the reduced reproduction in worker cells (Ritter & De Jong, 1984; Ruttner et al., 1984; Ritter, 1993).

The proximate factors determining whether a mite reproduces in a brood cell or refrains from reproduction are still unknown. Oocyte development in *Varroa* starts during the first day after cell capping inside the brood cell. Mites that are introduced into a brood cell later than 1 day after cell capping do not start oocyte development (Steiner et al., 1994). Hence, there seems to be a signal from the honey-bee larva initializing reproduction. Such a signal may be different in some races of *A. mellifera* and in *A. cerana*, thus preventing reproduction in worker cells. If so, absence of reproduction in worker cells is determined by a trait of the honey-bee.

Regardless of the proximate mechanism involved, ultimately the mites are expected to refrain from reproduction in worker brood only if this gives higher fitness returns. Hence, the absence of reproduction in worker brood may be a trait of the mites, whereas various mite populations apply different reproductive strategies because they are adapted to specific bee races/species (Boot et al., 1995).

In most countries, only one honey-bee race/species is present and the *Varroa* mites show only one type of reproductive behaviour. Therefore we studied the phenomenon of non-reproduction in Vietnam, because here one can find colonies of *A. cerana*, in which the mites do not reproduce in worker brood cells, as well as colonies of *A. mellifera*, in which approximately 90% of the mites reproduce in worker brood cells (Boot et al., 1997). By transferring *Varroa* from *A. mellifera* colonies to *A. cerana* worker brood cells and vice versa, we tested whether non-reproduction in worker brood cells is a trait of the honey-bee species or of the *Varroa* mite population. In addition, the removal response of worker bees to mite-infested cells was studied (Rath & Drescher, 1990; Boecking et al., 1993). Worker bees may identify mite-infested worker cells and remove either the mite alone or remove the mite together with the bee larva/pupa. Because this response clearly affects fitness of mites in worker brood cells, it may well be significant in promoting the various reproductive strategies applied by *Varroa* in honey-bee colonies.

Material and Methods

In October 1995, experiments were carried out in ten *A. cerana* and ten *A. mellifera* colonies. The colonies were kept in the area of Moc Chau in Northern Vietnam and contained three to six frames of bees. The *A. mellifera* colonies were heavily infested with *V. jacobsoni*, with hundreds to thousands of mites per colony. The *A. cerana* colonies contained only several tens of mites at most. This low number may be explained by the bee-keeping practices in Northern Vietnam. *Varroa* mites only reproduce in drone cells of *A. cerana* and, consequently, drone brood is needed to build up the population. However, in September/October drone brood is rarely found in the colonies because bee-keepers maintain relatively small colonies - that do not readily rear drones - and corners with drone brood are often cut away. In addition, drone cells

are hardly available to the queen for production of drone eggs, because bee-keepers apply wax sheets with pre-formed worker cell pattern (comb foundation) for the bees to build combs on.

Reproduction of V. jacobsoni in artificially and naturally infested worker cells

To study their reproduction, *Varroa* were artificially introduced into worker cells of *A. cerana* or *A. mellifera*. First, mites were collected from adult bees. Mites could not be collected from brood cells because in such mites reproduction may have been initiated already (Steiner et al., 1994). To catch mites from adult bees, bees were shaken with powdered sugar which causes the mites to loosen their grip on the bees (Boecking & Ritter, 1993). Bees were put into a box (10 x 10 x 10 cm), of which the lid and the bottom consisted of a sieve. Through the upper sieve powdered sugar was applied while shaking the box. The mites fell through the lower sieve and were put on moist tissue. Directly following collection of the mites, the capping of freshly capped worker cells (0-4h) was cut loose from part of the cell edge using a razor blade. The capping was lifted a little, after which a mite was introduced into the cell using a small brush (Ruijter, 1987). Subsequently, the cell was closed by pushing the capping gently back on the cell edge. The position of the cells was marked on a transparent sheet held over the comb surface during recording. To check whether or not the mites reproduced, the cells were opened after 4 days. In case of reproduction, one or two offspring were found because *Varroa* mites produce their first and second eggs after approximately 60 and 92 h, respectively (Martin, 1994). Mites from *A. mellifera* colonies were introduced into worker cells of both *A. cerana* and *A. mellifera*. Mites from *A. cerana* colonies were only introduced into worker cells of *A. mellifera*, because only a limited number of mites could be collected from the lightly infested *A. cerana* colonies.

Reproduction of the mites in artificially infested cells was compared to reproduction in naturally infested cells. In both *A. cerana* colonies and in *A. mellifera* colonies, the day on which worker cells had been capped was marked on transparent sheets. After 4 days these cells were opened and cells with one adult mite were selected and checked for offspring.

Removal response of A. cerana bees to artificially infested cells

To understand which factors may elicit the removal response of bees to mite-infested brood, we studied at what time artificially infested worker cells of *A. cerana* were removed by the bees. Using powdered sugar, *Varroa* mites were collected from *A. mellifera* adults and freshly capped worker cells of *A. cerana* were carefully opened following the procedure described above. Alternately, a cell was artificially infested or closed again without introducing a mite. The latter cells served as controls. The position of treated and control cells was marked on transparent sheets. Every 2 days the number of cells removed by the bees were recorded. After 10 days the remaining cells were opened to check if the remaining mites had reproduced.

Statistical analysis

To test whether the three groups of mites from *A. mellifera* colonies (in naturally infested cells, introduced into *A. mellifera* cells and introduced into *A. cerana* cells) differed with respect to the percentage of reproducing mites, the Chi-square test was used. The two groups of mites coming from *A. cerana* colonies (in naturally infested cells and introduced into *A. mellifera* cells) were similarly compared. In addition, each group of

mites from *A. mellifera* colonies was pairwise compared to each group of mites from *A. cerana* colonies (six combinations).

Table 1: Reproduction of *V. jacobsoni* in naturally and artificially infested worker cells.

	Total Number of cells	Brood removed	Mites lost	Without offspring	With offspring
Mites from <i>A. mellifera</i> colonies					
Naturally infested cells	77	-	-	16	61
Artificially infested cells of <i>A. mellifera</i>	104	33	21	9	41
Artificially infested cells of <i>A. cerana</i>	131	38	36	13	44
Mites from <i>A. cerana</i> colonies					
Naturally infested cells	13	-	-	12	1
Artificially infested cells of <i>A. mellifera</i>	57	14	3	38	2

Results

Reproduction of V. jacobsoni in artificially and naturally infested worker cells

Artificial infestation of worker brood cells proved to be a useful method of studying reproductive behaviour of *V. jacobsoni*. In approximately half of the cells the mite was recovered after four days, both in cells of *A. cerana* and in cells of *A. mellifera* (Table 1). Mite reproduction in artificially infested cells depended on the honey-bee species from which the mites had been collected (Table 1 and Fig. 1). About 80% of the mites from *A. mellifera* colonies reproduced when introduced into worker cells of either *A. mellifera* or *A. cerana* and this percentage was similar to reproduction in naturally infested worker cells of *A. mellifera* (differences not significant between the three groups: $\text{Chi}^2=0.38$, $\text{df}=2$ and $0.8 < p < 0.9$). Mites in the two groups from *A. cerana* colonies were clearly different from mites in the three groups from *A. mellifera* colonies ($\text{Chi}^2 > 20$, $\text{df}=1$ and $p < 0.001$ in all 6 combinations). Less than 10% of the mites from *A. cerana* colonies reproduced, both in naturally infested cells and when introduced into worker cells of *A. mellifera* (difference between the two groups not significant: $\text{Chi}^2=0.13$, $\text{df}=1$ and $0.7 < p < 0.8$).

Table 1 further shows that the brood had been removed by the bees after 4 days in approximately 30% of the artificially infested cells of both *A. cerana* and *A. mellifera*. This removal did not occur quickly after manipulation of the cells. Only in 4 of a total of 85 cells had the brood been removed within the first day following manipulation. In 5-27% of the cells the introduced mite was lost after 4 days, whereas the brood appeared to be intact.

Removal response of A. cerana bees to artificially infested cells

The brood was removed by the bees from 84% of the artificially infested worker cells, whereas only 4% of the brood in the control cells was removed (Fig. 2). Substantial removal of brood started 2 days after introduction of the mites. Most brood was removed between 2 and 6 days after introduction. Of the 20 cells that still contained a pupa 10 days after introduction, four cells contained viable offspring, unviable offspring was found

in five cells, the mite was found dead in two cells and no mite was recovered in nine cells.

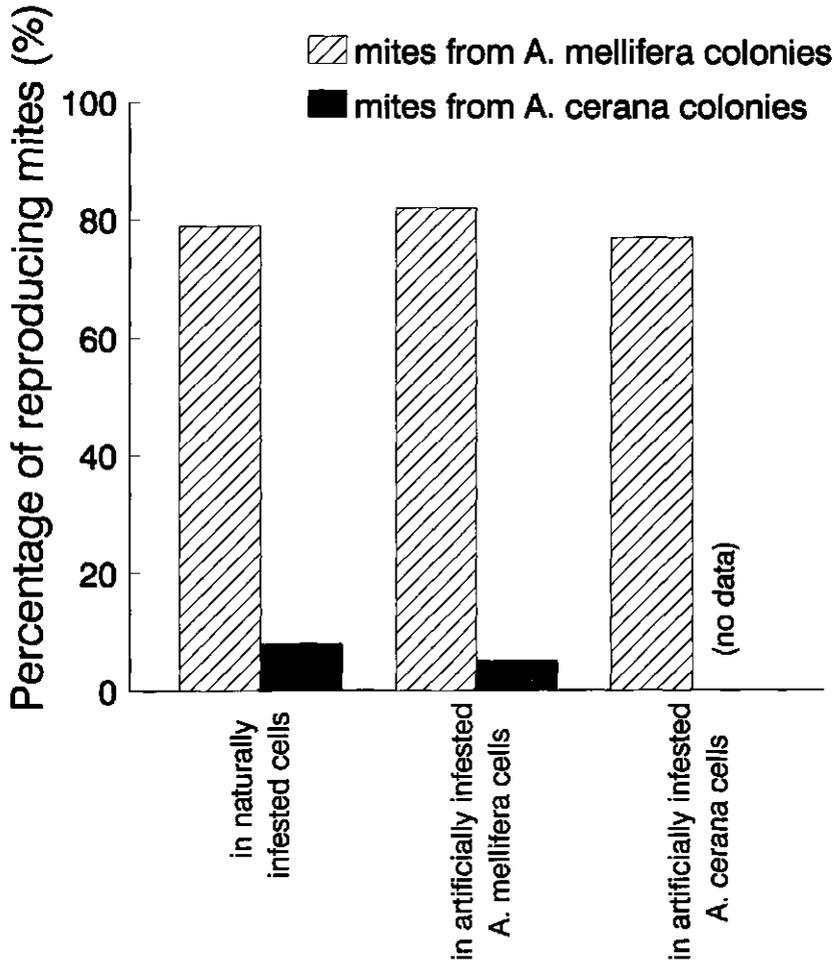

Figure 1. Percentage of reproducing *V. jacobsoni* in naturally infested worker cells, cells artificially infested with mites from *A. mellifera* colonies, and cells artificially infested with mites from *A. cerana* colonies.

Discussion

Absence of *V. jacobsoni* reproduction in worker cells of some races/species of honey-bee has mostly been studied from the perspective of the host - how does the honey-bee race/species prevent reproduction in worker cells (Hänel & Koeniger, 1986; Tewarson et al., 1992; Büchler, 1994; Rosenkranz & Engels, 1994). Our results show that we should also focus on the parasite. Non-reproduction in worker cells of *A. cerana* appeared to be a trait of *Varroa* and not of the honey-bee species.

Since the relation between *V. jacobsoni* and *A. cerana* is regarded as the outcome of a long process of co-evolution, we may assume that in *A. cerana* a strategy of non-reproduction in worker cells gives higher fitness returns than a strategy of reproduction. In colonies of its new host *A. mellifera*, however, reproduction in worker cells is a better strategy than non-reproduction (Boot et al., 1995). Therefore, it appears likely that natural selection led to mites using both worker and drone cells for reproduction within 'several decades' (according to Ritter, 1981) after the mites came in contact with *A. mellifera*. It is unknown how many generations were needed to adapt and how often this evolution occurred. In Papua New Guinea the mites started to infest *A. mellifera* colonies in 1986 (Anderson, 1990), coming from *A. cerana* colonies nearby. Since then the mites were not found to reproduce at all, in either worker or drone cells, although many mites were found in the *A. mellifera* colonies (Anderson, 1994). Our finding that non-reproduction in worker cells of *A. cerana* is a trait of the mite supports the hypothesis that the mites evolved into distinct populations that apply different reproductive strategies.

The difference between mites from colonies of *A. mellifera* and colonies of *A. cerana* is not necessarily genotypical. In theory, the mites may use a factor from adult bees on which they reside prior to invasion of a brood cell, to either start vitellogenesis (Fuchs, 1994) or to suppress it. There is circumstantial evidence against such a factor from adult bees, however. Although mites from *A. cerana* colonies do not reproduce in worker cells, they reproduce readily in drone cells (Koeniger et al., 1981; Rath, 1993; Rosenkranz et al., 1993a; Anderson, 1994; Boot et al., 1997). If a factor from adult bees inducing or preventing vitellogenesis in the mites were involved, its effect is necessarily overruled when the mites invade a drone cell. In addition, Ruijter (1987) showed by repeatedly transferring mites from cell to cell that contact with adult bees is by no means indispensable for reproduction in worker cells. This refutes the hypothesis of a factor from adult bees inducing vitellogenesis. Thus, the distinct reproductive strategies of *V. jacobsoni* in colonies of *A. cerana* and European *A. mellifera* are probably due to genotypical differences between the mites, although this should be tested in new experiments.

Since the bees may rob each others' colonies, exchange of mites probably occurs regularly. Therefore, the mites in *A. mellifera* and in *A. cerana* colonies can retain their specific reproductive behaviour only if selection against mites with atypical behaviour is strong enough. If a mite from an *A. cerana* colony invades a worker brood cell in an *A. mellifera* colony it will not reproduce. This means that its fitness will be lower than the fitness of resident mites, since it was shown that reproduction in worker cells is a better strategy for *Varroa* mites in colonies of European *A. mellifera* (Boot et al., 1995). In *A. cerana* colonies, however, the following three reasons may render non-reproduction a better strategy. Firstly, developmental time of capped worker brood is only 11 days in *A. cerana* (Kapil, 1959; Tan et al., 1993) versus 12 days in European *A. mellifera* races (Le Conte & Cornuet, 1989; Harbo, 1992). Hence, fewer daughters than in European *A. mellifera* are expected to reach maturity because their number is limited by developmental time of the capped brood (e.g. Martin, 1994). Recently, Calis et al.

(1996) showed that the number of mites emerging from the brood cells may be lower than the number of mites that originally invaded if developmental time of the capped worker brood is shorter than the 12 days of European honey-bee races. Secondly, mites that reproduce may subsequently have a higher risk of dying than mites that do not. Thirdly, fitness of mites that reproduce in worker cells of *A. cerana* may be more drastically affected by the removal response of bees to mite-infested cells. After artificial infestation of *A. cerana* worker cells with mites from *A. mellifera* colonies, 84% of the infested brood had been removed by the bees (Fig. 2). These mites were either killed by the bees, or at least their reproduction was interrupted (Boecking, 1992). In either case, however, fitness of the mites decreased. Hence, if the removal response of bees occurred because the mites came from *A. mellifera* colonies, there will be strong selection against such mites when they occasionally infest *A. cerana* colonies.

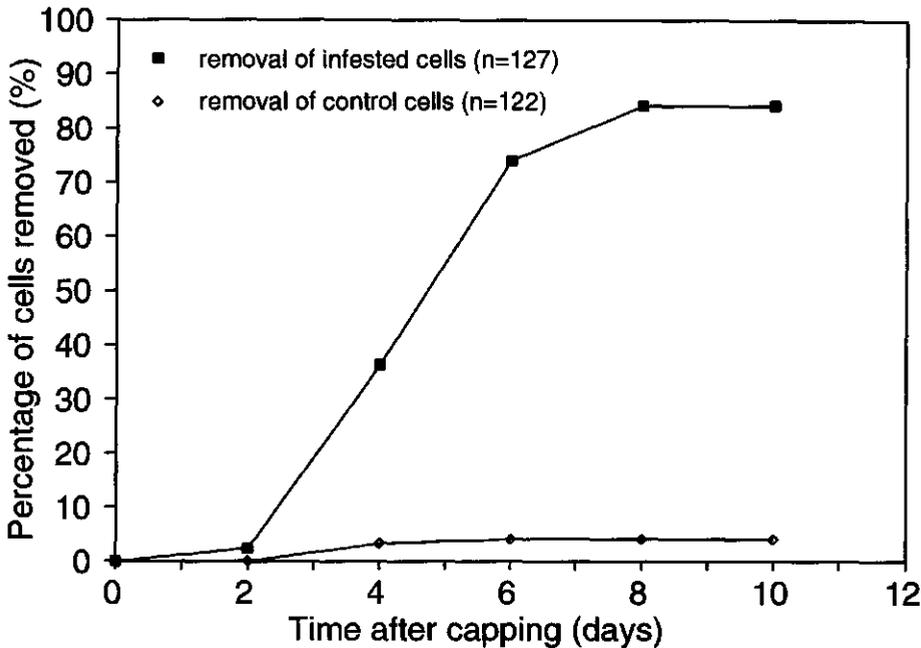

Figure 2: Percentage of cells from which the brood was removed in relation to the time after cell capping.

In contrast to the mites artificially introduced from *A. mellifera* colonies, the removal response to naturally infested worker brood of *A. cerana* seems to be low (Boot et al., 1997). If mites are artificially introduced into a cell, they may be detected by the bees because the cell is damaged, because the mites have an alien smell, or because the behaviour of the artificially introduced mites may differ from the naturally infested ones. The little removal of brood in control cells indicates that treated cells are not removed simply because they are damaged. However, in combination with the presence of a mite, damage to the cells may still have played a role. If bees remove infested brood earlier because the cell is damaged, a quick removal response is expected because after spinning of the larva, 1-2 days after cell capping (Jay, 1963), the cocoon renders the cell more solid. If bees detect mites from *A. mellifera* colonies earlier because of their alien smell (Rosenkranz et al., 1993b), a quick removal response is also expected because the alien scent will fade and the mite's scent will probably adjust to that of the current host (Nation et al., 1992). Rath & Drescher (1990) found a relatively quick response to artificially infested worker cells of *A. cerana*. During the first day already 37% had been removed and 94% had been removed after 4 days. In contrast, we found no quick removal response in our experiments (Fig. 2). Removal started after 2 days. This relatively late response suggests that in our experiments mite behaviour was the most likely factor evoking the removal response by the bees.

In naturally infested worker cells of *A. cerana*, the removal response is weak and mites refrain from reproduction. In cells that are artificially infested with mites from *A. mellifera*, the removal response is strong and the mites reproduce. Possibly, bees detect reproducing mites more easily than non-reproducing ones because more odours are produced during construction of the faecal accumulation (Donzé & Guerin, 1994) or because of the larger activity inside the cell. If so, removal of brood is expected to occur after reproduction has started. In addition, less reproduction than normal is expected in cells of which the brood is not removed. *Varroa* mites lay their first egg approximately 60 hours after capping (Martin, 1994), which correlates well with the onset of removal between 2 and 4 days after capping. However, our results from opening the remaining cells after 10 days were not clear. Nine out of 11 mites had reproduced, although only in 4 cells was viable offspring found.

In this study, non-reproduction in worker cells was found to be due to a trait of the mites. However, host-specific effects on this phenomenon exist as well. By placing brood combs from European and Africanized bees in the same infested colonies, Camazine (1986) showed that 25% of the mites refrained from reproduction in worker cells of European *A. mellifera* versus 51% in worker cells of Africanized *A. mellifera*. In other studies, it is less clear whether differences in non-reproduction are due to mite-specific or host-specific effects, because data come from different colonies (Ritter & De Jong, 1984; Rosenkranz et al., 1989; Trybom & Fries, 1991; Ritter, 1993; Rosenkranz & Engels, 1994). There is one other study showing a clear mite-specific effect. In European *A. mellifera*, Fuchs (1994) showed that non-reproduction was independent of the origin of the brood but varied between the highly infested colonies that were used for testing.

Since the phenomenon of non-reproduction in worker cells is considered a key-factor in *Varroa*-tolerant bees (Büchler, 1994; Rosenkranz & Engels, 1994), our findings have large implications for selection programmes to breed less-susceptible bee strains. The phenomenon of non-reproduction will show only after the mites have been given enough generations to adapt, despite the presence of underlying bee characters. This may have happened in Tunisia (Ritter, 1993) and South America (e.g. Ruttner et al., 1984). Here, natural selection of the bees may have led to *Varroa*-tolerant colonies, in which fitness of mites that reproduce in worker cells is lower than that of mites refraining

from reproduction in worker cells. Subsequently, natural selection of the mites may have led to high levels of non-reproduction. Thus, in selection programmes we should not look for non-reproduction in worker cells as such, but for colonies in which non-reproduction of mites is selected for. Hence, fitness of mites that reproduce in both drone and worker cells should be compared to fitness of mites that reproduce only in drone cells.

Acknowledgements We would like to thank Nguyen Thu Hang, Pham Xuan Dung, Phung Huu Chinh and Dinh Quyet Tam of the Bee Research and Development Centre, who organized the facilities of our working group in Moc Chau perfectly. Further we thank the 'Uyttenboogaart-Eliassen' foundation and the Netherlands Foundation for the Advancement of Tropical Research (WOTRO) for providing financial support to Johan Calis and Willem Boot. The Committee Science and Technology for Vietnam (KWT) is thanked for supporting Joop Beetsma, Nguyen Kim Lan, Le Quang Trung, Dong Minh Hai, Tran Van Toan and Nguyen Hung Minh. Maurice Sabelis and an unknown referee are thanked for their critical comments on the manuscript. This study was carried out as part of a European Union project: Eurobee AIR3-CT94-1064.

This manuscript was presented at the Third Symposium of the European Association of Acarologists (EURAAC) which was held on 1-5 July 1996 in Amsterdam, The Netherlands

References

- Anderson, DL (1990) *Apis cerana* and its associated mites and pathogens in Papua New Guinea. In Van Laere, O et al. (editors) *Proceedings of the International Symposium on Recent Research on Bee Pathology*, Gent, Belgium, pp 196-201.
- Anderson, DL (1994) Non-reproduction of *Varroa jacobsoni* in *Apis mellifera* colonies in Papua New Guinea and Indonesia. *Apidologie* 25: 412-421.
- Boecking, O (1992) Removal behaviour of *Apis mellifera* colonies towards sealed brood cells infested with *Varroa jacobsoni*: techniques, extent, efficacy? *Apidologie* 23: 371-373.
- Boecking, O & Ritter, W (1993) Grooming and removal behaviour of *Apis mellifera intermissa* in Tunisia against *Varroa jacobsoni*. *Journal of Apicultural Research* 32: 127-134.
- Boecking, O, Rath, W & Drescher, W (1993) Behavioral strategies of *Apis mellifera* and *Apis cerana* against *Varroa jacobsoni*. *International Journal of Acarology* 19: 173-177.
- Boot, WJ, Baalen, M van & Sabelis, MW (1995) Why do *Varroa* mites invade worker brood cells of the honey bee despite lower reproductive success? *Behavioral Ecology and Sociobiology* 36: 283-289.
- Boot, WJ, Tan, NQ, Dien, PC, Huan, LV, Dung, NV, Long, LT & Beetsma, J (1997) Reproductive success of *Varroa jacobsoni* in brood of its original host, *Apis cerana*, in comparison to that of its new host, *A. mellifera* (Hymenoptera: Apidae). *Bulletin of Entomological Research* 87: 119-126.
- Büchler, R, Drescher, W & Tornier, I (1992) Grooming behaviour of *Apis cerana*, *Apis mellifera* and *Apis dorsata* and its effect on the parasitic mite *Varroa jacobsoni* and *Tropilaelaps clareae*. *Experimental & Applied Acarology* 16: 313-319.
- Büchler, R, (1994) *Varroa* tolerance in honey bees - occurrence, characters and breeding. *Bee World* 75: 54-70.
- Calis, JNM, Boot, WJ & Beetsma, J (1996) Reproductive success of the *Varroa* mite in honeybee worker brood with differential development times. *Proceedings Experimental & Applied Entomology*, N.E.V. Amsterdam 7: 89-94.
- Camazine, S (1986) Differential reproduction of the mite, *Varroa jacobsoni* (Mesostigmata: Varroidae), on Africanized and European honey bees (Hymenoptera: Apidae). *Annals of the Entomological Society of America* 79: 801-803.
- De Jong, D, Morse, RA & Eickwort, GC (1982) Mite pests of honey bees. *Annual Review of Entomology* 27: 229-252.
- Donzé, G & Guerin, PM (1994) Behavioral attributes and parental care of *Varroa* mites parasitizing honeybee brood. *Behavioral Ecology and Sociobiology* 34: 305-319.
- Fries, I, Camazine, S & Sneyd, J (1994) Population dynamics of *Varroa jacobsoni*: a model and a review. *Bee World* 75: 5-28.

- Fuchs, S (1994) Non-reproducing *Varroa jacobsoni* Oud. in honey bee worker cells - status of mites or effect of brood cells? *Experimental & Applied Acarology* 18: 309-317.
- Hänel, H & Koeniger, N (1986) Possible regulation of the reproduction of the honey bee mite *Varroa jacobsoni* (Mesostigmata: Acari) by a host's hormone: Juvenile Hormone III. *Journal of Insect Physiology* 32: 791-798.
- Harbo, JR (1992) Breeding honey bees (Hymenoptera: Apidae) for more rapid development of larvae and pupae. *Journal of Economic Entomology* 85: 2125-2130.
- Jay, SC (1963) The development of honeybees in their cells. *Journal of Apicultural Research* 2: 117-134.
- Kapil, RP (1959) Variation in the developmental period of the Indian bee. *The Indian Bee Journal* 21: 3-6, 26.
- Koeniger, N, Koeniger, G & Wijayagunasekara, NHP (1981) Beobachtungen über die anpassung von *Varroa jacobsoni* an ihren natürlichen Wirt *Apis cerana* in Sri Lanka. *Apidologie* 12: 37-40.
- Le Conte, Y & Cornuet, JM (1989) Variability of the post-capping stage duration of the worker brood in three different races of *Apis mellifera*. In R. Cavalloro (editor) *Present status of varroaosis in Europe and progress in the Varroa mite control*. Commission of the European Communities, Luxembourg, pp 171-174.
- Martin, SJ (1994) Ontogenesis of the mite *Varroa jacobsoni* Oud. in worker brood of the honeybee *Apis mellifera* L. under natural conditions. *Experimental & Applied Acarology* 18: 87-100.
- Matheson, A (1993). World bee health report. *Bee World* 74: 176-212.
- Matheson, A (1995) First documented findings of *Varroa jacobsoni* outside its presumed natural range. *Apiacta* 30: 1-8.
- Nation, JL, Sanford, MT & Milne, K (1992) Cuticular hydrocarbons from *Varroa jacobsoni*. *Experimental & Applied Acarology* 16: 331-344.
- Oudemans, AC (1904) On a new genus and species of parasitic acari. *Notes from the Leyden Museum* 24: 216-222.
- Rath, W & Drescher, W (1990) Response of *Apis cerana* Fabr. towards brood infested with *Varroa jacobsoni* Oud. and infestation rate of colonies in Thailand. *Apidologie* 21: 311-321.
- Rath, W (1993) Aspects of preadaptation in *V. jacobsoni* while shifting from its original host *A. cerana* to *A. mellifera*. In Conner, LJ et al. (editors), *Asian Apiculture*. Wicwas Press, Cheshire CT, USA, pp 417-426.
- Ritter, W (1981) *Varroa* disease of the honeybee *Apis mellifera*. *Bee World* 62: 141-153.
- Ritter, W & De Jong, D (1984) Reproduction of *Varroa jacobsoni* O. in Europe, the Middle East and tropical South America. *Zeitschrift für angewandte Entomologie* 98: 55-57.
- Ritter, W (1993) New results of the development of tolerance to *Varroa jacobsoni* in bee colonies in Tunisia. In Conner, LJ et al. (editors), *Asian Apiculture*. Wicwas Press, Cheshire CT, USA, pp 463-467.
- Rosenkranz, P, Issa, M, Rachinsky, A, Strambi, A & Strambi, C (1989) Honeybee-*Varroa* relationships: a comparison of Africanized and Carniolan colonies. In R. Cavalloro (editor) *Present status of Varroaosis in Europe and progress in the Varroa mite control*. Commission of the European Communities, Luxembourg, pp 193-198.
- Rosenkranz, P, Tawarson, NC, Rachinsky, A, Strambi, A, Strambi, C & Engels, W (1993a) Juvenile hormone titer and reproduction of *Varroa jacobsoni* in capped brood stages of *Apis cerana indica* in comparison to *Apis mellifera ligustica*. *Apidologie* 24: 375-382.
- Rosenkranz, P, Tawarson, NC, Singh, A & Engels, W (1993b) Differential hygienic behaviour towards *Varroa jacobsoni* in capped worker brood of *Apis cerana* depends on alien scent adhering to the mites. *Journal of Apicultural Research* 32: 89-93.
- Rosenkranz, P & Engels, W (1994) Infertility of *Varroa jacobsoni* females after invasion into *Apis mellifera* worker brood as a tolerance factor against varroaosis. *Apidologie* 25: 402-411.
- Ruijter, A de (1987) Reproduction of *Varroa jacobsoni* during successive brood cycles of the honeybee. *Apidologie* 18: 321-326.
- Ruttner, F, Marx, H & Marx, G (1984) Beobachtungen über eine mögliche Anpassung von *Varroa jacobsoni* an *Apis mellifera* L. in Uruguay. *Apidologie* 15: 43-62.

-
- Steiner, J, Dittmann, F, Rosenkranz, P & Engels, W (1994) The first gonocycle of the parasitic mite (*Varroa jacobsoni*) in relation to preimaginal development of its host, the honey bee (*Apis mellifera carnica*). *Invertebrate Reproduction and Development* 25: 175-183.
- Tan, NQ, Huan, LV & Dung, NV (1993) Development time of eggs, open brood and capped brood of *Apis cerana* and *Apis mellifera* in southern Vietnam. *In* Conner, LJ et al. (editors), *Asian Apiculture*. Wicwas Press, Cheshire CT, USA, pp 243-248.
- Tewarson, NC, Singh, A & Engels, W (1992) Reproduction of *Varroa jacobsoni* in colonies of *Apis cerana indica* under natural and experimental conditions. *Apidologie* 23: 161-171.
- Thrybom, B & Fries, I (1991) Development of infestations by *Varroa jacobsoni* in hybrid colonies of *Apis mellifera monticola* and *Apis mellifera ligustica*. *Journal of Apicultural Research* 30: 151-155.

Reproductive success of *Varroa* mites in honey bee brood with differential development times

Abstract

Reproduction of *Varroa destructor* has been extensively studied with respect to the number of eggs laid, timing of egg laying, and mortality of immature mites, are well known. However, estimates of the actual reproductive success after one brood cycle, i.e. how many mites can be found alive on the bees after emergence of an infested cell, are still fairly theoretical and not based on actual measurements under realistic conditions. Because this parameter is crucial for understanding population growth of the mites, we measured the actual reproductive success. To assess how development time of the capped brood stage affects population growth of the mites, measurements were done in bee strains with different development times of worker brood. In brood with a relatively short development time, reproductive success of mites was lower compared to brood with a longer development time. This difference in reproductive success appeared to be caused by lower egg production and higher mortality of adult mites before or shortly after emergence of the brood cells with decreasing development time, and a direct effect of the restricted development time for the mite offspring. The results show that the actual number of mites emerging from worker cells with relatively short development times, may become lower than the initial number that invaded the cells. Firstly, this implies a decline of the mite population when only worker cells are available. Secondly, it helps explain why mites do not reproduce in worker cells but in drone cells, as found in *A. cerana* and in several *A. mellifera* races.

Introduction

The mite *Varroa destructor*, is world-wide an important pest in colonies of the western honey bee, *Apis mellifera*. The mites parasitise both brood and adult bees, but reproduction occurs only inside capped brood cells. *Varroa* infestations may ruin honey bee colonies, because parasitised bees suffer from malformations and a shortened life span (De Jong et al., 1982; Schneider & Drescher, 1987; Kovac & Crailsheim, 1988; Beetsma et al., 1989). Next to direct damage to bees through feeding, mites act as vectors of honey bee pathogens and increase the incidence of honey bee diseases (Wieggers, 1988; Ball, 1994). Commonly, synthetic acaricides, organic acids or biotechnical control methods are applied to prevent loss of colonies (Koeniger & Fuchs, 1988; Maul et al., 1988; Fries, 1991; Kraus & Berg, 1994; Calis et al., 1997; Imdorf et al., 1997). The eastern honey bee, *A. cerana*, and some African and africanised *A. mellifera*-races tolerate mite infestations without control measures (Moritz, 1985; Ritter, 1993; De Jong, 1999; Gonçalves, 1999). This tolerance can be explained because mites do not reproduce in worker brood of *A. cerana* (Koeniger et al., 1981; Tewarson et al., 1992; Anderson, 1994; Boot et al, 1997), and a large fraction of mites do not reproduce in worker brood of African and africanised honey bees (Ritter & De Jong 1984; Camazine 1986; Ritter 1993). It is often implicitly assumed that mites do not reproduce in worker brood due to a trait of the honey bee. However, Boot et al. (1999) demonstrated that non-reproduction in worker brood may well be a trait of the mites. Mites that originated from *A. mellifera* colonies did produce eggs after introduction into *A. cerana* worker brood, whereas mites from *A. cerana* colonies still refrained from reproduction after introduction into *A. mellifera* worker brood. Earlier, Anderson (1994) had shown that mites originating from *A. cerana* colonies may not reproduce in *A. mellifera* brood at all.

Populations of mite species with different reproduction behaviour appear to exist sympatrically, but separated in colonies of different honey bee species (Anderson & Trueman, 2000; Fuchs et al., 2000). Boot et al. (1995a, 1997) argued that non-reproduction in worker brood may indicate specialisation of the mites on drone brood, selected as a result of low reproductive success in worker brood. With respect to selecting *Varroa*-tolerant honey bees, honey bee traits that reduce reproductive success in worker brood deserve attention.

The duration of the post-capping period is an important trait affecting reproductive success of mites in worker brood (Moritz, 1985; Camazine, 1986), since development time of the capped brood limits the number of immature offspring that may reach the adult stage (Ifantidis, 1983; Martin, 1994, 1995a). This developmental period is indeed relatively short for *A. cerana* worker brood (Kapil, 1959; Jay, 1963; Tan et al., 1993), where mites refrain from reproduction. The effect of brood development time on reproductive success was shown for European honey bees where a 1 hour shorter post-capping period was correlated with a 8.7% lower population growth determined after one season (Büchler & Drescher, 1990). Heritability of brood development time is generally reported as high (e.g. Moritz, 1985; Harbo, 1992; Le Conte & Cornuet, 1989), and therefore it may be a key trait for selection of *Varroa*-tolerance in western honey bees.

To understand how development time of the brood affects population growth of *Varroa*, we need to assess the actual reproductive success of the mites. Often, lifetime reproductive success is used to calculate the rate of population growth. Because its is difficult to keep track of individual mites during their lives, it is easier to use reproductive success over one brood cycle, however. Because the rate of invasion of mites into new brood cells and the death rate of mites on adult bees are known (Boot et al., 1995b, 1995c), population growth may be calculated if reproductive success per brood cycle is known.

Reproductive success can be expressed as the average number of living female mites emerging from infested brood cells per mite that successfully invaded a cell. Direct estimates are difficult, however, because the initial number of mites in the brood should be known and because emerging mites need to be traced. Therefore, reproductive success is usually estimated indirectly by opening cells and investigating the mite's progeny. This has led to knowledge on the number of eggs laid, the timing of egg-laying, development time and mortality of immature mites (e.g. Donzé & Guerin, 1994; Fries et al., 1994; Martin, 1994, 1995a; Boot et al., 1997). For estimation of reproductive success, the value of opening cells is limited, however. This is because immature mites have to be classified as viable or non-viable based on the expected time left before the young bee emerges. In this paper, we use and discuss methods to estimate reproductive success directly, using bee strains that vary considerably in development time. Additionally, we compared the direct estimate of the reproductive success to estimates from opening brood cells, to study how reproductive success is affected by egg production, juvenile mortality and mite mortality after emergence of the bee.

Material and Methods

Honey bee colonies

Honey bee colonies from three strains were used: *A. m. capensis*, known for the short development time of its capped worker brood (Moritz, 1985), 'hybrid' colonies headed by an *A. m. capensis* queen that had mated freely with drones present near the laboratory, having a development time intermediate between worker brood of either *A. m. capensis* and European honey bees, and *A. m. carnica* representing a honey bee

with a long development time. Worker brood of these strains used for the experiments was nurtured in colonies with at least 10 occupied combs. These colonies consisted of freely-mated *A. m. carnica* queens and their offspring.

Development time of capped brood

Combs with 0-1 day old eggs (Boot & Calis, 1991) were collected from colonies of the three strains and placed into the 'nurture' colonies. During cell capping the newly capped brood cells were marked on a transparent sheet that was put temporarily on the comb surface for this purpose with two hour intervals. Shortly before emergence of the brood, the combs were placed into an incubator (34.5°C, 60%R.H.). Cells out of which bees had emerged were also recorded in two hour intervals until all previously marked cells were empty.

Measuring reproductive success directly

Method 1:

In order to measure reproductive success during a brood cycle, the number of invaded mites has to be known. To determine the number of invaded mites, we constructed 'half-combs' from which the bottom of the cells had been replaced by a transparent sheet (Beetsma et al., 1993). Mites that had entered a cell crawled to the bottom and could easily be spotted through the transparent sheet (Boot et al., 1994). Two half-combs were clipped together, after which it closely resembled a normal comb. The queens laid eggs in the cells similar to cells on unmanipulated combs. Using a half-comb, a patch of brood with larvae varying one day in age (Boot & Calis, 1991) was introduced into a heavily mite-infested colony. When enough mites had invaded, the number depending on chances of multiple infestations per cell, the cells invaded by one mite were marked. Multiple infested cells were removed, after which the comb was put into a mite-free colony to prevent other mites from invading. About one day before emergence of the bees, the comb was placed into an incubator (34.5 °C). Three days after emergence of the bees, the dead adult mites were counted and the living mites residing on the bees were estimated by washing in benzene (Ritter & Ruttner, 1980).

Method 2:

An alternative method to estimate the numbers of mites that invaded the cells using half-combs as in method 1. This time, however, only cells invaded by more than three mites were removed to obtain a larger starting population and to minimise manipulation of the comb. A negative effect of multiple infestations on reproduction per mite occurs when more than three mites infest a cell (Martin, 1995b, Donzé & Guerin, 1994), and therefore such cells were also removed. Contrary to method 1, the mite-infested combs were placed in small colonies in which the bees and mites emerged. These colonies had been made free of mites before by trapping mites in drone brood and by treating them with formic acid (20 ml, 85%). Judging from the number of mites found dead in so called monitor colonies, that were continuously treated with Apistan, mites were constantly invaded by mites from outside. Therefore, about two days before emergence of the bees, the colonies were treated again with formic acid. During treatment, the infested combs were temporarily put into another colony. After returning the infested comb, the colonies were closed to prevent new mites from coming in, and the fall of mites that died before or shortly after emergence of their host bees was

monitored by counting the number of dead mites on the drawer underneath the gauze bottom of the colonies. On the third and the fourth day after emergence, Perizin was applied through the gauze top of the colony to estimate the number of living mites that were residing on the bees. Because virgin queens headed the colonies, no brood suitable for invasion was available to the mites by the time they emerged from the infested comb. In total four trials were carried out. In each trial reproductive success in two patches of brood was estimated, which required two colonies for the different combs to emerge. For infestation of the brood, however, the same heavily infested colony was used to obtain comparable mites within the trial (Fuchs, 1994). One of the combs always contained a patch of *A. m. carnica* brood, whereas the other patch contained either *A. m. capensis* brood or brood of a hybrid colony. In addition we did one trial with two patches of *A. m. carnica* drone brood.

Removal of naturally mite-invaded brood cells

The bees may remove brood cells with mites before the young bee emerges (Boecking & Spivak, 1999). Using the 'half-combs' with the transparent bottom we counted the number of naturally infested brood cells that were removed 9 days after invasion. We used these numbers to correct the number of initially invaded mites for mite removal by the bees.

Measuring mite reproduction indirectly from opened brood cells

To estimate the number of mite offspring that may mature in worker brood, we opened worker brood cells at least 230 hours after cell capping. During this period the male and the first three daughters will have developed to at least the deuto-chrysalis stage (Ifantidis, 1983; Martin, 1994). Because mortality may occur during the last stages of mite development, we also opened cells at least 252 hours after cell capping. By that time at least the first two daughters have completed their pre-adult development (Martin, 1994). We also estimated the reproduction in *A. m. capensis* and *A. m. carnica* drone brood cells. These cells were opened between 9 and 10 days after cell capping. Additionally, we opened brood cells of *A. m. carnica* after 12 to 13 days. Development time of the drones is sufficient for all female offspring to become adult.

Comparing reproductive success between normal and 'half' combs

Because the 'half-combs' may affect reproductive success of the mites, we compared reproduction in both normal and half-combs for worker brood. This was done for all three bee-strains used by comparing the content of infested brood cells.

Statistical analysis consisted of the Mann-Whitney-U test on reproduction data from the opened brood cell and the Fisher-exact test on mortality from emerged brood cells.

Results

Development time of the capped brood

A. m. capensis worker offspring of a queen obtained from South-Africa, emerged already after an average of 252 hours after capping. *A. m. carnica* workers needed on average 32 hours more. The duration of the capped period of the worker offspring of a *A. m. capensis* queen obtained from a population maintained in Oberursel (Germany) and

the hybrid offspring of the freely-mated *A. m. capensis* queens were intermediate. Drones from *A. m. capensis* and *A. m. carnica* both needed slightly more than 14 days from capping until emerging (Figure 1).

Reproductive success measured directly from emerged brood cells

To estimate reproductive success during one brood cycle, the first method, where brood emerged isolated from colonies in an incubator, was carried out in three independent trials (Figure 2). Reproductive success appeared to be rather low. In the trials with brood of *A. m. capensis* and with brood of the hybrid colony the number of living mites recovered was even lower than the number that invaded before. In the trial with brood of *A. m. carnica* the number of recovered living mites was only 1.3 times the number that invaded before. The total number of mites recovered was about two times higher. Because mite mortality rates of 22% have been registered for brood emerging in colonies (Boot et al., 1995c), the observed mortality rates are probably increased partly as a consequence of the method selected (Calis et al., 1996).

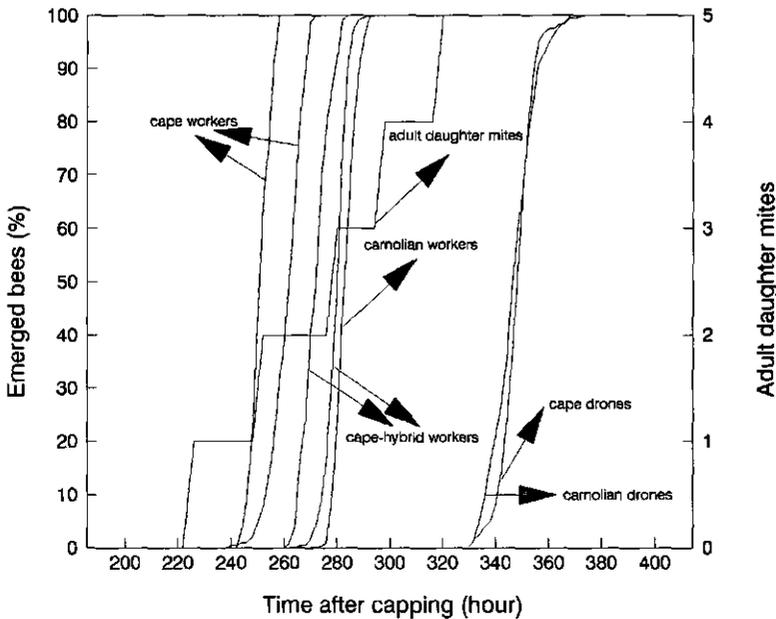

Figure 1. Emergence of bees from their brood cells at the end of the capped development stage for the three test-strains for both worker and drone brood (left Y-axis) and the number of daughter mites that reach the adult stage, the drawn staircase line represents data from Martin (1994,1995a) (right Y-axis).

The alternative, second method yielded results similar to method 1, except that the fraction of mites recovered alive was higher than in the first method (Figure 3). The estimates of reproductive success varied considerably between the replicates. In worker brood of *A. m. carnica* values ranged from 1.3 to 2.2 times the number of mites that invaded before. However, within each trial reproductive success in either *A. m. capensis* or in brood of the hybrid colony was between 34% and 20% lower than in brood of *A. m. carnica*. On average 0.89 and 0.79 times the total number of mites that emerged per invaded mite from *A. m. carnica* worker brood cells emerged from *A. m. capensis* or the hybrid brood, respectively. The number of mites that died before or just after emergence of their host bees was always lowest for *A. m. carnica* worker brood (Table 1). Therefore, the numbers of living mites that emerged from the *A. m. capensis* or the hybrid brood compared to that from *A. m. carnica* were even lower, 0.75 and 0.72 times, respectively. The second method is probably best suited to estimate reproductive success directly, because the use of an incubator may cause extra mortality. On average 23% of the adult mites that emerged in the experiments using the second method were found dead, which is similar to the 22% found when emerging combs were used to introduce mites into a colony (Boot et al., 1995c). In the trial with drone brood of *A. m. carnica*, reproductive success in both combs was 1.8 times the number that invaded before, whereas the total numbers of adult mites emerged were 2.2 and 2.3 times the number invaded (Figure 4).

Table 1. Numbers of emerged adult mites per invaded *Varroa* mite and the mortality after emergence of the host-bees from their brood cells.

	<i>carnica</i>	<i>capensis</i> -hybrid	<i>capensis</i>	Probability (Fisher exact test)
Adult mites	2.01	-	1.78	P<0.00
Mortality after emergence%	11		25	
Nr of invaded mites (n)	(196)		(200)	
Adult mites	2.17	1.72	-	P=0.07
Mortality after emergence%	25	32		
Nr of invaded mites (n)	(190)	(197)		

Reproduction estimated indirectly from opened brood cells

Results from opening brood cells may shed light on the origin of the differences in reproductive success found. Comparing mite reproduction between half-combs and normal combs, showed that reproduction was not affected by the use of the half-combs (Table 2). So, results obtained from both types of comb were pooled (Table 3).

Reproduction of mites in worker brood cells opened at least 230 hours after cell capping was higher in *A. m. carnica* worker brood on the one hand and both *A. m. capensis* and *A. m. capensis*-hybrid worker brood on the other hand (Table 3). The number of eggs produced was higher and the fraction of non-reproducing mites was lower in *A. m. carnica* worker brood.

Differences in juvenile mortality were not observed. In brood cells that contained 5 or more offspring, the number of viable female offspring was on average 2.2 in all three test-strains. The percentage of viable female offspring, expressed as % of the total offspring, was similar for the three test strains: 35% for the *A. m. capensis* and the *A. m. capensis*-hybrid strains and 38% for the *A. m. carnica* strain.

The fraction of mites that did not produce viable female offspring or failed to produce sons were similar for the three test strains. The number of adult female mites, mothers and daughters, expected to emerge per invaded mite was 1.9, 2.0 and 2.3 in *A. m. capensis*, the hybrid and *A. m. carnica* worker brood, respectively. Proportional to the number of mites expected to emerge from *A. m. carnica* worker brood, these numbers are 0.82 and 0.88 for *A. m. capensis* and the hybrid, respectively.

The number of eggs produced and the number of female mites that may complete their development in drone brood cells was similar for both *A. m. capensis* and *A. m. carnica*. After 9 to 10 days the reproductive success is potentially higher in drone brood cells compared to worker brood cells. In *A. m. carnica* drone brood opened 12 to 13 days after cell capping, however, the number of females that can be expected to emerge is only 2.4 times the number that originally invaded the brood cells and, thus, quite similar to the results found in worker brood (Table 2).

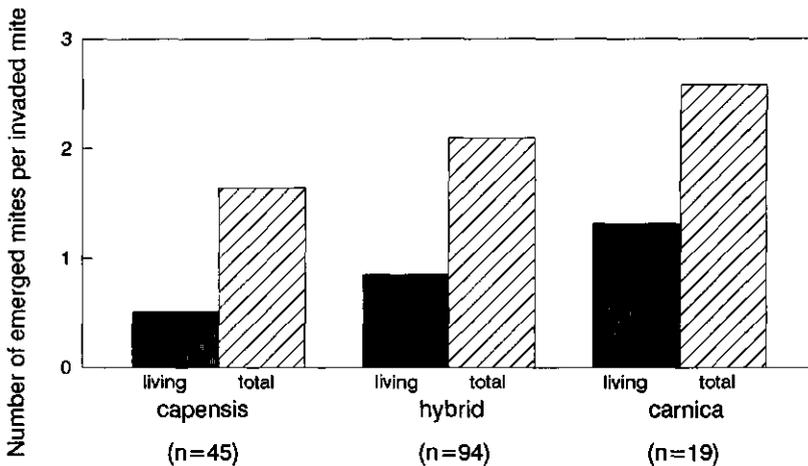

Figure 2. Average number of emerged mites per mite that invaded before in worker brood of *A. m. capensis*, a hybrid colony, and *A. m. carnica*, as estimated with method 1.

Table 2. Numbers of offspring and numbers of viable daughters per invaded *Varroa* mite examined from opened brood cells.

Honey bee strain	Offspring or Viable daughters	Worker brood		Drone brood		
		Half combs	Normal combs	Opened after 252 hours	Opened after 9-10 days	Opened after 12-13 days
<i>A. m. capensis</i>		(n=24)	(n=33)	-	(n=65)	-
	Offspring	2.42	2.58	-	4.09	-
	Viable daughters	0.80	0.91	-	2.66	-
<i>A. m. capensis</i> -hybrid		(n=53)	(n=157)	(n=32)	-	-
	Offspring	2.89	2.83	3.62	-	-
	Viable daughters	1.09	0.96	1.25	-	-
<i>A. m. carnica</i>		(n=49)	(n=133)	(n=69)	(n=49)	(n=133)
	Offspring	2.94	3.51	3.59	4.32	3.66
	Viable daughters	1.18	1.30	1.29	3.08	1.38

Table 3. A comparison of reproduction characteristics of *Varroa* mites in worker brood of the three test strains estimated from opened brood cells.

Reproduction characteristic	<i>A. m. capensis</i>	<i>A. m. capensis</i> -hybrid	<i>A. m. carnica</i>
Number of cells where 1 mite invaded	57	210	182
Offspring per invaded mite	2.51 ^a	2.85 ^a	3.35 ^b
Viable daughters per invaded mite	0.86 ^a	0.99 ^a	1.27 ^b
Offspring per mite that produced offspring	3.86 ^a	3.83 ^a	4.24 ^b
Viable daughters per mite that produced offspring	1.32 ^a	1.33 ^a	1.60 ^b
Fraction of mites without offspring	0.35 ^a	0.26 ^{ab}	0.21 ^b
Fraction of mites without viable offspring	0.12 ^a	0.08 ^a	0.08 ^a
Fraction of mites with female but without male offspring	0.09 ^a	0.14 ^a	0.15 ^a
Fraction of mites with only viable male offspring	0.05 ^a	0.14 ^a	0.08 ^a

A different letter means significantly different (Mann-Whitney-U-test, $P < 0.05$)

Removal of naturally invaded brood cells

Infested worker brood cells of *A. m. capensis* were removed most frequently. Infested drone brood cells were hardly removed, whereas hybrid and *A. m. carnica* were removed at an intermediate rate. In worker brood, the rate of removal was found higher when the number of mites per cell is higher. In our trials with drone brood the rate of removal was low and apparently does not increase with infestation level (Table 4).

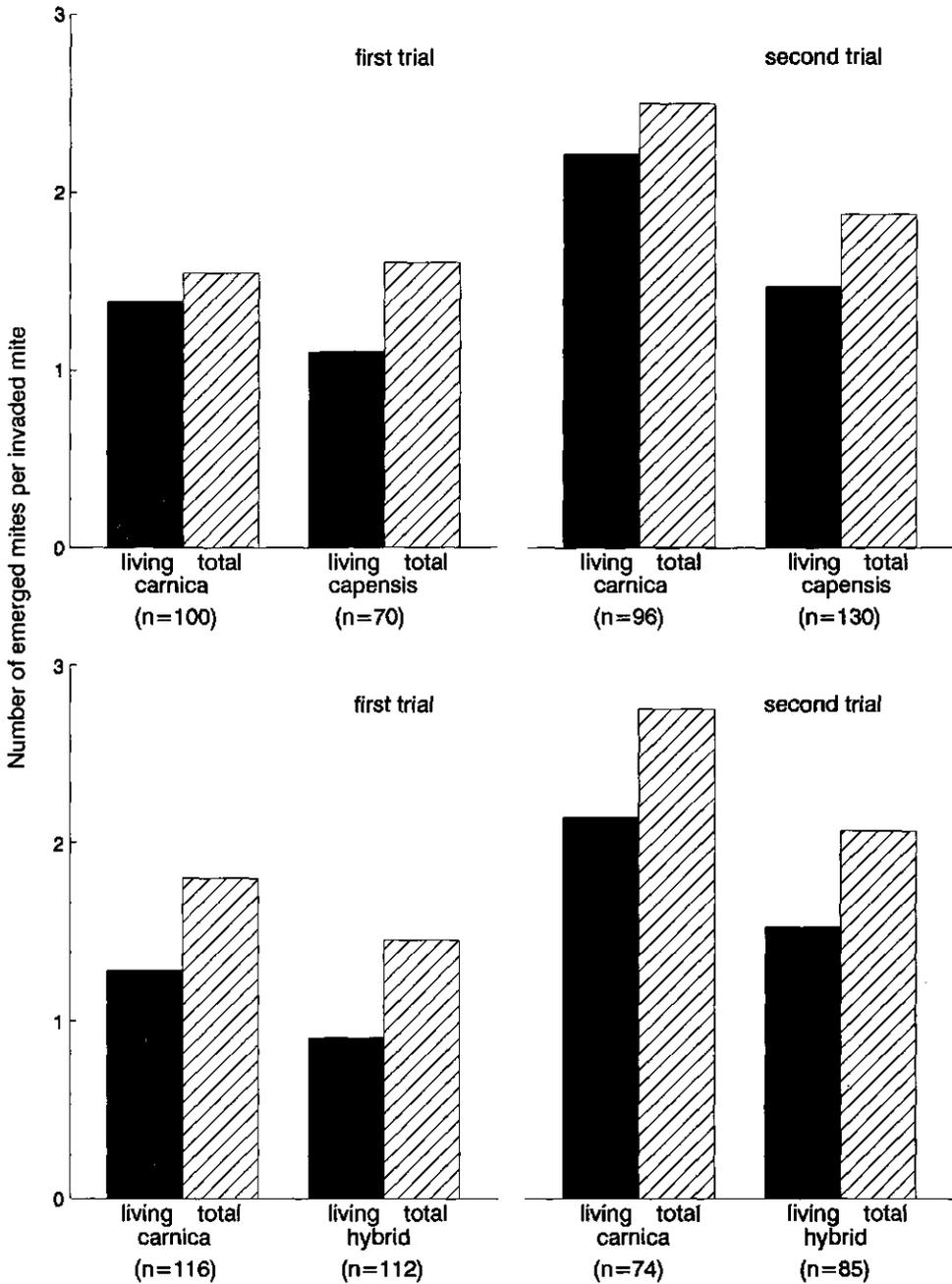

Figure 3. Average number of emerged mites per mite that invaded before in worker brood of *A. m. capensis*, a hybrid colony, and *A. m. carnica*, as estimated with method 2. In each trial, two patches of infested brood were tested, one with brood of *A. m. carnica* and the other with either brood of *A. m. capensis* or brood of a hybrid colony.

Table 4. Removal of brood cells invaded by *Varroa* mites in relation to the test strain and the number of *Varroa* mites per cell.

Strain and brood type	removed % cells (number)			removed % mites (number)
	1 mite/cell	2 mites/cell	3 mites/cell	
<i>A. m. capensis</i> worker brood	26 (n=160)	32 (n=44)	53 (n=15)	32 (n=293)
<i>A. m. capensis</i> -hybrid worker brood	5 (n=131)	33 (n=36)	25 (n=15)	18 (n=248)
<i>A. m. carnica</i> worker brood	5 (n=222)	19 (n=48)	25 (n=20)	12 (n=378)
<i>A. m. carnica</i> drone brood	10 (n=182)	4 (n=55)	0 (n=13)	7 (n=331)

Discussion

The direct estimate of the reproductive success of the mites varied considerably between the separate trials. However, reproductive success in brood of *A. m. capensis* and in the hybrid brood was always lower than that of *A. m. carnica*. This observed difference may be due to several factors. Firstly, individual mites appear to be variable in the number of eggs they produce, since the number of produced eggs increases with development time in worker brood of *A. m. capensis*, *A. m. capensis*-hybrid, *A. m. carnica* and drone brood. This suggests that development time has an effect on egg production. Because the difference in reproduction estimated from opened worker brood cells is smaller than the estimate derived from the number of mites emerged alive, reduced production of eggs can only partly explain the reduced reproductive success. Secondly, juvenile mortality up to 258 hours after cell capping did not contribute to the difference in reproductive success, as it was similar in the tested strains. Thirdly, we may expect a direct effect of the restricted development time on the mite offspring, because worker brood that starts emerging before all daughters have completed their development will lead to the death of the immature mites. In *A. m. carnica* worker brood development time seems to be long enough for the third daughter to reach the adult stage. This is in agreement with work of Martin (1994), who found that 3 daughters could be produced in brood cells with similar development time. However, if development time is only a bit shorter, the third daughter cannot reach the adult stage. The development time of capped worker brood of the *A. m. capensis*-hybrid is probably critical, and in the worker brood of *A. m. capensis* not even the second daughter may reach the adult stage in time (Figure 1). Finally, the mortality of adult mites before or shortly after emergence of the bees is always higher for the worker brood of both *A. m. capensis* and the hybrid compared to *A. m. carnica* (Table 1, Figure 3).

In conclusion, both direct effects (a restricted number of daughters that can reach the adult stage in time) and indirect effects (reduced egg production and a higher mortality of emerging mites) of a reduction in the development time of the honey bee brood, reduces the reproductive success of *Varroa* mites. However, we cannot exclude that physiological differences between the honey bee races cause part of the difference in reproductive success of the mites.

The total number of eggs produced by mites in drone brood is higher compared to worker brood (Table 3), as has been found before (Ifantidis, 1988; Martin, 1994, 1995a). The potential number of potentially adult offspring is still high compared to worker brood 9 to 10 days after cell capping, but shortly before emerging of drones of *A. m. carnica* this estimate is practically similar to that of worker brood, probably due to juvenile mortality. Generally, in other studies higher estimates of the reproductive success in drone brood are found. In this study, however, our estimates of the reproductive success from both opened cells shortly before emergence and emerged brood cells are low but in agreement with each other.

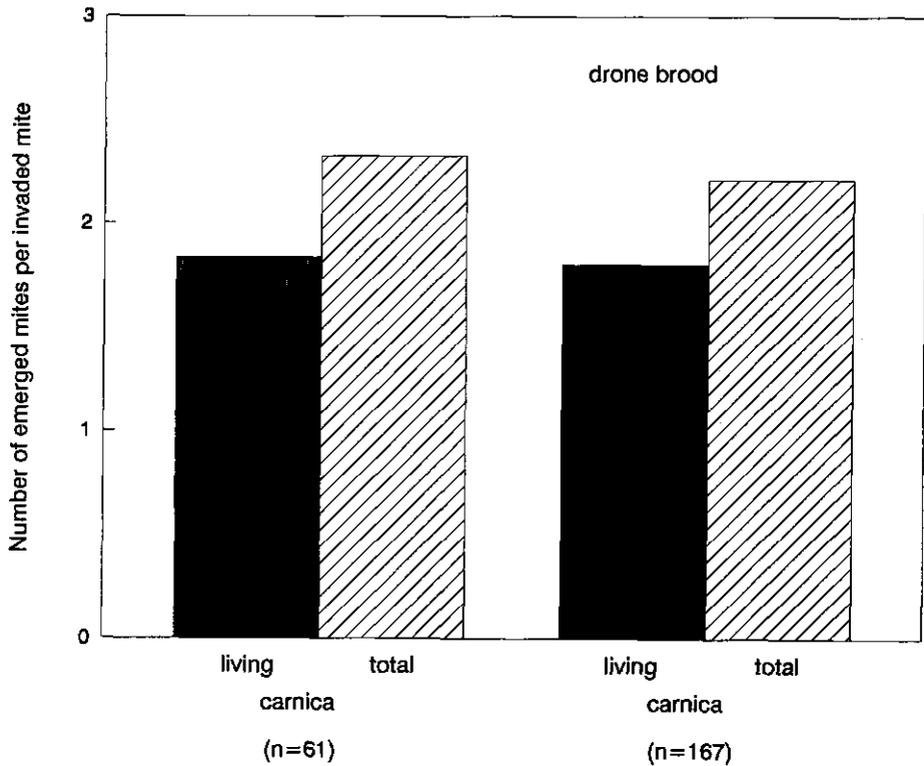

Figure 4. Average number of emerged mites per mite that invaded before in drone brood of *A. m. carnica*.

If only worker brood is available for the *Varroa* mite, the population model of Calis et al. (1999) predicts a break-even point for the mite population when the number of adult mites per invaded mite after one worker brood cycle is 1.75. This is surprisingly similar to the increment found in the direct estimate of the reproductive success from worker brood of *A. m. capensis* and the hybrid (Table 1). This helps to explain that these colonies in the vicinity of our laboratory never seemed to suffer damage from mite infestation. The direct estimates of reproductive success in worker brood of *A. m. capensis* and in the hybrid are low, sometimes even lower than 1. Actual reproductive success may still be lower because several factors are not accounted for in our estimates. Firstly, some mites that did invade, may have been overlooked which results in an over estimation of the reproductive success. Secondly, the content of part of the infested brood cells was removed, and the offspring and maybe the mother mites die when bees remove infested cells (Boecking et al., 1993). Brood cell removal reduces reproductive success. Finally, mites may die during the phoretic phase, which is also not accounted for in our estimates. A value for reproductive success in worker brood lower than 1 implies that the mite population declines, if only worker cells are available for the mites. It also shows why *Varroa* mites do not reproduce in worker cells of *A. cerana* and of several *A. mellifera* races. This avoidance of reproduction in worker cells may well evolve if mites that do not reproduce in a worker cell survive to reproduce in drone brood emerging in the next brood cycle (Boot et al., 1995a, 1999).

Acknowledgements We thank M Beekman, JC van Lenteren and MW Sabelis for their valuable comments on drafts of the manuscript. Niko Koeniger and Mike Allsopp are thanked for their help in obtaining colonies of *A. m. capensis*. This study was funded by the European Union: Eurobee AIR3-CT94-1064.

References

- Anderson, DL (1994) Non-reproduction of *Varroa jacobsoni* in *Apis mellifera* colonies in Papua New Guinea and Indonesia. *Apidologie* 25: 412-421.
- Anderson, DL & Trueman, JWH (2000). *Varroa jacobsoni* (Acari: Varroidea) is more than one species. *Experimental and Applied Acarology* 24: 165-189.
- Ball, BV (1994) Host-Parasite-Pathogen interactions. In: A. Matheson (ed.). *New perspectives on Varroa*. IBRA, Cardiff, UK: 5-11.
- Beetsma, J R, Vries, de B, Emami Yeganeh, M, Emami Tabrizi & Bandpay, V (1989) Effects of *Varroa jacobsoni* Oud. on colony development, workerbee weight and longevity and brood mortality. In R. Cavalloro (editor). *Present status of Varroa in Europe and progress in the Varroa mite control*, Commission of the European Communities, Luxembourg: pp 163-170.
- Beetsma, J, Boot, WJ & Calis, JNM (1993) Special techniques to make detailed observations of *Varroa* mites staying on bees and invading honey bee brood cells. In Connor et al. (editors), *Asian Apiculture*. Wicwas Press, Cheshire CT, USA, pp. 510-520.
- Boecking, O, Rath, W & Drescher, W (1993) Behavioral strategies of *Apis mellifera* and *Apis cerana* against *Varroa jacobsoni*. *International Journal of Acarology* 19: 173-177.
- Boecking, O & Spivak, M (1999) Behavioral defenses of honey bees against *Varroa jacobsoni* Oud. *Apidologie* 30: 141-158.
- Boot, WJ & Calis JNM (1991) A method to obtain dated brood in honeybee colonies. *Bee World* 72: 19-21.
- Boot, WJ, Beetsma J & Calis, JNM (1994) Behaviour of *Varroa* mites invading honey bee brood cells. *Experimental & Applied Acarology* 18: 371-379.
- Boot, WJ, Baalen, van M & Sabelis, MW (1995a) Why do *Varroa* mites invade worker brood cells of the honey bee despite lower reproductive success? *Behavioral Ecology and Sociobiology* 36: 283-289.
- Boot, WJ, Calis, JNM & Beetsma, J (1995b) Does time spent on adult bees affect reproductive success of *Varroa* mites? *Entomologia Experimentalis et Applicata* 75: 1-7.

- Boot, WJ, Schoenmaker, J, Calis, JNM & Beetsma, J (1995a) Invasion of *Varroa* mites into drone brood cells of the honey bee. *Apidologie* 26: 109-118.
- Boot, WJ, Tan, NQ, Dien, PC, Huan, LV, Dung, NV, Long, LT & Beetsma, J (1997) Reproductive success of *Varroa jacobsoni* in brood of its original host, *Apis cerana*, in comparison to that of its new host, *A. mellifera* (Hymenoptera: Apidae). *Bulletin of Entomological Research* 87: 1-126.
- Boot, WJ, Calis, JNM, Beetsma, J, Hai, DM, Lan, NK, Toan, TV, Trung LQ & Minh, NH (1999) Natural selection of *Varroa jacobsoni* explains the different reproductive strategies in colonies of *Apis cerana* and *Apis mellifera*. *Experimental and Applied Acarology* 23: 133-144.
- Büchler, R & Drescher, W (1990) Variance and heritability of the capped developmental stage in European *Apis mellifera* L. and its correlation with increased *Varroa jacobsoni* infestation. *Journal of Apicultural Research* 29: 172-176.
- Calis, JNM, Boot WJ & Beetsma, J (1996) Reproductive success of the *Varroa* mite in honeybee worker brood with differential development times. *Proceedings Experimental & Applied Entomology, N.E.V. Amsterdam* 7: 89-94.
- Calis, JNM, Schmidt-Bailey, J, Beetsma, J, Boot, WJ, Eijnde van den, JHPM, Fuchs, S, Ruijter de, A & Steen van der, JJM (1997) Successful trapping of *Varroa jacobsoni* with drone brood in broodless *Apis mellifera* colonies. *Apiacta* 32: 65-71.
- Camazine, S (1986) Differential reproduction of the mite, *Varroa jacobsoni* (Mesostigmata: Varroidae), on Africanized and European honey bees (Hymenoptera: Apidae). *Annals of the Entomological Society of America* 79: 801-803.
- De Jong, D, Morse, RA & Eickwort, GC (1982) Mite pests of honey bees. *Annual Review of Entomology* 27: 229-252.
- De Jong, D., 1999. Africanized honey bees, an example of natural selection or resistance to *Varroa jacobsoni*. *Proceedings of the 36th congress of Apimondia*, Vancouver, Canada: pp 101.
- Donzé, G & Guerin, PM (1994) Behavioral attributes and parental care of *Varroa* mites parasitizing honeybee brood. *Behavioral Ecology and Sociobiology* 34: 305-319.
- Fries, I (1991) Treatment of sealed honeybee brood with formic acid for control of *Varroa jacobsoni*. *American Bee Journal* 131: 313-314.
- Fries, I, Camazine, S & Sneyd, J (1994) Population dynamics of *Varroa jacobsoni*: a model and a review. *Bee World* 75: 5-28.
- Fuchs, S (1994) Non-reproducing *Varroa jacobsoni* Oud. in honey bee worker cells - status of mites or effect of brood cells? *Experimental & Applied Acarology* 18: 309-317.
- Fuchs, S, Long, LT & Anderson, DL (2000) A scientific note on the genetic distinctness of *Varroa* mites on *Apis mellifera* L. and on *Apis cerana* Fabr. In North Vietnam. *Apidologie* 31: 459-460.
- Gonçalves, LS (1999) Biological impact caused by the africanization of honey bees in Brazil and the future of beekeeping. *Proceedings of the 36th congress of Apimondia*, Vancouver, Canada: pp 204.
- Harbo, JR (1992) Breeding honey bees (Hymenoptera: Apidae) for more rapid development of larvae and pupae. *Journal of Economic Entomology* 85: 2125-2130.
- Ifantidis, MD (1983) Ontogenesis of the mite *Varroa jacobsoni* in worker and drone honeybee brood cells. *Journal of Apicultural Research* 22: 200-206.
- Ifantidis, MD (1988) Some aspects of the process of *Varroa jacobsoni* mite entrance in honeybee (*Apis mellifera*) brood cells. *Apidologie* 19: 387-396.
- Imdorf, A, Charriere, JD & Bachofen, B (1997) Efficiency checking of the *Varroa jacobsoni* control methods by means of oxalic acid. *Apiacta* 32: 89-91.
- Jay, SC (1963) The development of honeybees in their cells. *Journal of Apicultural Research* 2: 117-134.
- Kapil, RP (1959) Variation in the developmental period of the Indian bee. *The Indian Bee Journal* 21: 3-6, 26.
- Koeniger, N & Fuchs, S (1988) Control of *Varroa jacobsoni*: current status and developments. In G.R. Needham et al.(editors) *Africanized honeybees and bee mites*, Ellis Horwood Limited, Chichester, pp. 360-369.

- Koeniger, N, Koeniger, G & Wijayagunasekara, NHP (1981) Beobachtungen über die Anpassung von *Varroa jacobsoni* an ihren natürlichen Wirt *Apis cerana* in Sri Lanka. *Apidologie* 12: 37-40.
- Kovac, H & Crailsheim, K (1988) Lifespan of *Apis mellifera carnica* pollm. infested by *Varroa jacobsoni* Oud. in relation to season and extent of infestation. *Journal of Apicultural Research* 27(4): 230-238.
- Kraus, B & Berg, S (1994) Effect of a lactic acid treatment during winter in temperate climate upon *Varroa jacobsoni* Oud. and the bee (*Apis mellifera* L.) colony. *Experimental & Applied Acarology* 18: 459-468.
- Le Conte, Y & Comuet, JM (1989) Variability of the post-capping stage duration of the worker brood in three different races of *Apis mellifera*. In R. Cavalloro (editor) *Present status of varroaosis in Europe and progress in the Varroa mite control. Commission of the European Communities*, Luxembourg, pp. 171-174.
- Martin, SJ (1994) Ontogenesis of the mite *Varroa jacobsoni* Oud. in worker brood of the honeybee *Apis mellifera* L. under natural conditions. *Experimental & Applied Acarology* 18: 87-100.
- Martin, SJ (1995a) Ontogenesis of the mite *Varroa jacobsoni* Oud. in drone brood of the honeybee *Apis mellifera* L. under natural conditions. *Experimental & Applied Acarology* 19: 199-210.
- Martin, SJ (1995b) Reproduction of *Varroa jacobsoni* in cells of *Apis mellifera* containing one or more mother mites and the distribution of these cells. *Journal of Apicultural Research* 34: 187-196.
- Maul, V, Klepsch, A & Assmann-Werthmüller, U (1988) Das Bannwabenverfahren als Element Imkerlicher Betriebsweise bei starkem Befall mit *Varroa jacobsoni* Oud. *Apidologie* 19: 139-154.
- Moritz, RFA (1985) Heritability of the post-capping stage in *A. mellifera* and its relation to varroaosis resistance. *The journal of heredity* 76: 267-270
- Ritter, W & F. Ruttner, (1980). Diagnoseverfahren. *Allgemeine Deutsche Imkerzeitung* 14: 134-138.
- Ritter, W & De Jong, D (1984) Reproduction of *Varroa jacobsoni* O. in Europe, the Middle East and tropical South America. *Zeitschrift für angewandte Entomologie* 98: 55-57.
- Ritter, W (1993) New results of the development of tolerance to *Varroa jacobsoni* in bee colonies in Tunisia. In L.J. Connor et al. (editors) *Asian Apiculture*. Wicwas Press, Cheshire, CT, USA, pp. 463-467.
- Schneider, P & Drescher, W (1987) Einfluss der Parasitierung durch die Milbe *Varroa jacobsoni* Oud. auf das Schlupfgewicht, die Gewichtsentwicklung, die Entwicklung der Hypopharynxdrüsen und die Lebensdauer von *Apis mellifera* L. *Apidologie* 18: 101-110.
- Tan, NQ, Huan, LV & Dung, NV (1993) Development time of eggs, open brood and capped brood of *Apis cerana* and *Apis mellifera* in southern Vietnam. In L.J. Connor et al. (editors), *Asian Apiculture*. Wicwas Press, Cheshire, CT, USA, pp. 243-248.
- Tewarson, NC, Singh, A & Engels, W (1992) Reproduction of *Varroa jacobsoni* in colonies of *Apis cerana indica* under natural and experimental conditions. *Apidologie* 23: 161-171.
- Wieggers, FP (1988) Transmission of honey bee viruses by *Varroa jacobsoni* Oud. In R. Cavalloro (editor) *European research on varroaosis control. Proceedings of a meeting of the EC experts' group for the Commission of the European Communities*, Bad Homburg, 15-17 October 86. A.A. Balkema, Rotterdam, Netherlands; 99-104.

Attractiveness of brood cells from different honey bee races (*Apis mellifera*) to *Varroa* mites

Abstract

Reproduction of the *Varroa* mite only occurs inside capped brood cells of honey bees. Therefore, invasion into brood cells is crucial for the mite's reproduction and the rate of invasion will affect the growth of the mite population. We investigated the invasion response of the mites to drone or worker larvae of different honey bee races, because selection for less attractive brood may help *Varroa* mite control. The observed differences in invasion response of *Varroa* mites to worker brood were not statistically significant. The results suggest that not the racial origin of the worker brood, but the distance between the larva and the cell rim affect the invasion response of the *Varroa* mites to worker brood cells. Because measuring the distance between the larva and the cell rim in drone brood cells is inaccurate due to curved cell caps of neighbouring cells, the results for drone brood cells are difficult to interpret. Possibilities to obtain less attractive brood via selection or comb manipulation are discussed.

Introduction

The *Varroa* mite, *Varroa destructor*, parasitises both honey bee brood and adult bees of *Apis mellifera* L., the Western honey bee. Without mite control, bee colonies usually perish within a few years after mite infestation (Ritter, 1981). Mite reproduction only occurs inside capped brood cells (Ifantidis & Rosenkranz, 1988). Therefore, invasion into brood cells is crucial for reproduction of the mites (Boot et al., 1993; 1994). The rate of invasion will affect the growth of the mite population. Selection for less attractive brood, aiming at a lower rate of brood cell invasion, might decrease mite population growth in honey bee colonies. A prerequisite for selection of less attractive brood is that the mites show a differential invasion response to drone or worker larvae of genetically different honey bee origins. Vandamme (1996) showed that *Varroa* mites invaded worker brood of European honey bees at a higher rate than worker brood of africanised honey bees. In this study we asked whether differential invasion responses of mites to worker or drone brood of different European honey bee races occur. To design experiments for solving this question, factors that affect attractiveness of brood cells have to be considered. Mites show a differential invasion response to drone and worker brood (Boot et al., 1995b, Rosenkranz et al., 1984, Otten & Fuchs, 1988, Le Conte et al., 1989), with drone cells being invaded 12 times more frequent than worker cells (Boot et al., 1995a). Chemical information from brood cells may, either qualitatively or quantitatively, help the mites to discriminate between worker and drone brood. Because reproductive success is higher in drone cells, fitness will be increased when mites are able to discriminate between these cell types and preferentially invade drone cells. Considering the differential invasion response of mites to worker and drone brood, the invasion response of mites into brood of different honey bee races should be investigated for drone brood and worker brood, separately. Mites invade brood cells starting from c. two days before cell capping in the case of drone cells and c. one day in the case of worker cells (Ifantidis, 1988, Boot et al, 1992). Mites move directly from the bees into brood cells, probably using a chemical signal from these cells to decide whether to stay on the bees or to invade the cells (Boot et al., 1994). The distance from the larva to the cell rim decreases when the larva grows and it has been shown that there is a critical distance after which the cells become attractive to the mites (Boot et

al., 1995b). The strength of a signal that triggers brood cell invasion may be correlated to this distance. Mites may not only perceive a signal, but they may also invade cells with a stronger signal more readily, as suggested by Ifantidis (1988). Mites that are able to select cells with the oldest larvae will have a higher reproductive success because they can start oviposition earlier. We measured the attractiveness of brood cells from different European honey bee races to *Varroa* mites. We designed our experiments in such a way that the attractiveness of brood cells could be assessed in relation to the distance between the larvae and the cell rim.

Material and Methods

Honeybee colonies

We used the following honeybee races: *A. mellifera carnica* from Germany, *A. m. iberica* from Spain, *A. m. macedonica* from Greece and *Apis m. mellifera* from the island Texel, The Netherlands. Breeding of the brood of these different honeybee races, as well as mite infestation of the brood was carried out in colonies of bees that are commonly used in The Netherlands, but actually consist of a mixture of *A. mellifera* races.

For worker brood we compared the invasion response of mites to brood of one *A. m. macedonica* queen (macedonica 1) with brood of one *A. m. mellifera* queen (mellifera 1), one *A. m. iberica* queen (iberica) and one *A. m. carnica* queen (carnica) in three separate replicates. For drone brood we compared the invasion response of mites to brood of another *A. m. macedonica* queen (macedonica 2) to brood of two *A. m. mellifera* queens (mellifera 1 and mellifera 2) in three separate replicates.

Brood combs

New brood cells reach their maximal length by the time they are capped. To standardise the length of the brood cells we only used combs that had brood at least once. Cell length was determined using a probe to measure the distance between the bottom of 10 empty cells and the cell caps of surrounding brood cells (Goetz & Koeniger, 1992). The same probe was used for 50 larvae of each brood sample to measure the distance between the cell rim and the larva just before the comb was placed in a colony with mites. We then recorded the time to cell capping so that this distance could be related to the time between measuring and capping.

Measuring brood cell invasion

We assessed the number of mites that invaded brood cells of different larval age categories and of different honey bee races. Worker brood combs with eggs 0-1 day of age and drone brood combs with eggs 0-3 days of age (Boot & Calis, 1991) were placed in colonies with at least 10 frames of bees. When combs were exchanged among colonies the adhering bees were removed. When brood was maximally 7 days old, combs were placed into a honey bee colony free of mites due to the continued application of Apistan. This was done to avoid invasion of mites on the one hand and to limit contamination of the brood used for the experiment with Apistan on the other hand. After capping of the first cells, the combs were placed in the middle of a bee colony heavily infested with *Varroa* mites. Combs were removed after 3 hours. Newly capped cells were marked on a transparent sheet that was put temporarily on the comb surface

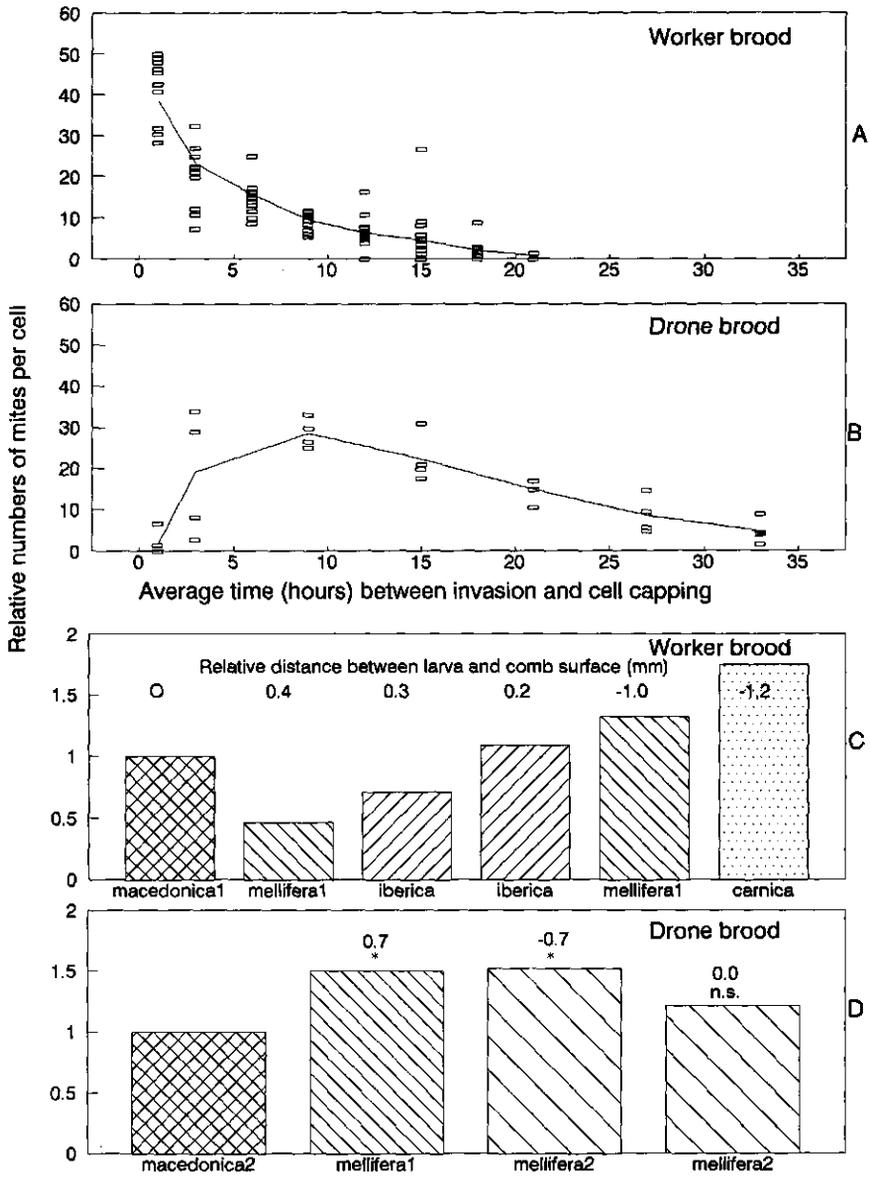

Figure 1. Relative numbers of mites per cell: (1A) versus the average period between mite invasion and cell capping in worker brood of all tested colonies; (1B) versus the average period between mite invasion and cell capping in drone brood of all tested colonies (for 1A and 1B the summed number of mites per cell and interval was set at 100 for each brood sample); (1C) summed for all intervals versus the worker brood origin, ranked according to the average difference in distance between the larvae and the cell rim; (1D) summed for all intervals versus the drone brood origin.

for this purpose and the combs were returned to the mite-free colony. Mite invasion into brood cells of different age was therefore restricted to the 3-hour residence time in the mite-infested colony. Newly capped worker brood cells were marked on the same transparent sheet in 3-hour intervals. For drone brood, the newly capped brood cells were marked in the same way as the worker brood; first, just after removal from the mite-infested colony, then after 3 hours and subsequently at 6-hour intervals. Thus, for cells capped during each subsequent interval the average period between mite invasion and cell capping increased. When most cells had been capped the combs were removed from the colony and the number of capped cells and the number of mites in each cell were counted for each time interval. For each interval the average time between mite invasion and cell capping was calculated. Cells that belong to the first invasion interval were capped during the stay in the mite-infested colony. Therefore, these cells were available for invasion on average half of the three hour period. To present the relation between attractiveness and the time before cell capping, the number of mites per cell in these first invasion intervals was corrected for the number of hours that the cells were available for invasion.

Comparing attractiveness

The number of mites invading brood cells may depend on the density of phoretic mites in the mite-infested bee colony. In each replicate of the experiment we were able to obtain simultaneous mite invasion in brood of only some of the colonies we intended to test. Therefore, brood of an *A. m. macedonica* colony served as a standard and was treated in the same way simultaneously with brood from other honey bee races in each replicate (three replicates for both worker and drone brood). The number of mites that invaded the brood cells capped during the successive intervals was compared using a Chi²-test for homogeneity. Predicted values were calculated from the mean numbers of mites per cell for each interval and the number of cells in each interval. In addition, for each time interval the number of mites per capped cell was calculated. Relative attractiveness was calculated as the summed numbers of mites per capped cell of all time intervals divided by that of the *A. m. macedonica* colony. Differences in distance from the larvae to the cell rim were calculated as the mean difference over all time intervals.

Results and Discussion

The observed differences in invasion response of *Varroa* mites to worker brood of the *A. m. macedonica* colony and the other colonies were not statistically significant. However, when we rank the data according to the distance between the larva and the cell rim relative to that of the *A. m. macedonica* worker brood, an association with the invasion response of mites to the brood becomes visible (Figure 1C). The brood cells were invaded by more mites when the distance from the cell rim to the larva was smaller, irrespective of the origin of the brood. This suggests that not the racial origin of the worker brood, but the dimensions of the brood cells and the larvae affect the invasion response of the *Varroa* mites to worker brood cells.

For drone brood, we observed statistically significant differences in invasion response of the mites to the brood cells (Figure 1D). In the first and second replicate *A. m. mellifera* drone brood cells were more attractive to *Varroa* mites compared to those of *A. m. macedonica*. In the third replicate, the invasion response of the mites was similar for both brood origins. In the first replicate, the distance between the larvae and the cell

rim for the *A. m. mellifera* drone brood was 0.7 mm less compared to the *A. m. macedonica* drone larvae. In the third replicate, we measured the same distance for both brood origins. These results suggest that similar to the case of worker brood, the invasion response of the mites to drone brood is higher when the distance between the larva and the cell rim is smaller, irrespective of the origin of the brood. The results of the second replicate, however, are not in agreement with the other data. The *A. m. mellifera* drone brood cells were more frequently invaded although their distance to the cell rim was 0.7 mm greater than that of the *A. m. macedonica* colony. Measuring the distance between the cell rim and the drone larva is often hampered due to extension by the bees of the neighbouring brood cells shortly before capping. The presence of brood cell extensions depends on the age of the brood and is, therefore, variable between combs. This causes inaccurate measurements of this distance, thus making comparisons of invasion response more difficult than in the case of worker brood.

The average number of capped cells per time interval was 89 for worker brood and 98 for drone brood. The average number of invaded mites per time interval was 7.4 for worker brood and 13.5 for drone brood. Considering invasion response of mites to both worker brood and drone brood of all tested brood batches, the results show that invasion response of the mites increases with the age of both worker and drone larvae (Figure 1A and 1B). For drone brood the invasion response of the mites decreases shortly before the cells were fully capped. Worker brood cells are provided with a flat cell cap whereas drone brood cells get a curved cap. During the last few hours before the actual closing of the drone cell, the rim is elevated by the bees and in this way they enlarge the distance between the larvae and the cell rim. The results show that the invasion response of mites to brood cells increases with decreasing distance between the larvae and the cell rim.

Attractiveness of worker brood cells to mites was affected by the dimensions of the brood cells and the larvae, irrespective of the origin of the brood. Therefore, selection for less attractive worker brood to decrease mite population growth is not an option. To reduce attractiveness of brood cells, it may be a better strategy to increase the diameter of the brood cells via manipulation of comb foundation, as this increases the distance between the larva and the cell rim (Ramon et al., 1993). However, when only the worker brood is less attractive, the mites may invade drone cells, thereby increasing their population size even more because their reproductive success in drone cells is higher. Reducing attractiveness of brood cells for *Varroa* mites as a strategy to reduce mite population growth will only be successful when mite invasion in both worker and drone brood cells is taken under consideration.

Acknowledgements We thank M Beekman and JC van Lenteren and MW Sabelis for their valuable comments on drafts of the manuscript. This study was carried out as part of the E.U. funded Eurobee-project AIR3-CT94-1064. We thank our colleagues in this project for their help with obtaining the different honey bee races.

References

- Boot, WJ & Calis, JNM (1991) A method to obtain dated brood in honeybee colonies. *Bee World* 72: 19-21.
- Boot, WJ, Calis, JNM & Beetsma, J (1992) Differential periods of *Varroa* mite invasion into worker and drone cells of honey bees. *Experimental & Applied Acarology* 16: 295-301.
- Boot, WJ, Calis, JNM & Beetsma, J (1993) Invasion of *Varroa jacobsoni* into honey bee brood cells: a matter of chance or choice? *Journal of Apicultural Research* 32: 167-174.
- Boot, WJ, Sisselaar, DJA, Calis, JNM & Beetsma, J (1994) Factors affecting invasion of *Varroa* mites into honey bee brood cells. *Bulletin of Entomological Research* 84: 3-10.

- Boot, WJ, Schoenmaker, J, Calis, JNM & Beetsma, J (1995a) Invasion of *Varroa* mites into drone brood cells of the honey bee. *Apidologie* 26: 109-118.
- Boot, WJ, Driessen, RG, Calis, JNM & Beetsma, J (1995b) Further observations on the correlation between attractiveness of honey bee brood cells to *Varroa jacobsoni* and the distance from larva to cell rim. *Entomologia Experimentalis et Applicata* 76: 223-232.
- Goetz, B & Koeniger, N (1993) The distance between larva and cell opening triggers broodcell invasion by *Varroa jacobsoni*. *Apidologie* 24: 67-72.
- Ifantidis, MD (1988) Some aspects of the process of *Varroa jacobsoni* mite entrance into honey bee (*Apis mellifera*) brood cells. *Apidologie* 19: 387-396.
- Ifantidis, MD & Rosenkranz, P (1988) Reproduktion der Bienenmilbe *Varroa jacobsoni* (Acarina: Varroidae). *Entomologia Generalis* 14: 111-122.
- Le Conte, Y, Arnold, G, Trouiller, J, Masson C, Chape, B. & Ourisson, G (1989) Attraction of the parasitic mite *Varroa* to the drone larvae of honey bees by simple aliphatic esters. *Science* 245: 638-639.
- Otten, C & Fuchs, S (1988) Individual differences in *Varroa jacobsoni* of preference for drone larvae to worker bee larvae. In R. Cavalloro (editor) *European research on varroaosis control*. A.A. Balkema, Rotterdam, pp. 69-71.
- Ramon, H, Van Laere, O & Ifantidis, M (1993) Size of comb cell and reproduction of *Varroa jacobsoni*. In L.J. Conner et al. (editors), *Asian Apiculture*, Wicwas Press, Chesshire CT, USA, pp 521-529.
- Ritter, W (1981) *Varroa* disease of the honeybee *Apis mellifera*. *Bee World* 62: 141-153.
- Rosenkranz, P, Tewarson, NC & Engels, W (1984) Optimal host selection by reproductive female *Varroa jacobsoni*. In W. Engels et al. (editors) *Advances in invertebrate reproduction*, 3. Elsevier Science Publishers B.V., Amsterdam, pp 628.
- Vandamme, R (1996) Importance de l'hybridation de l'hôte dans la tolérance à un parasite. Cas de l'acarien parasite *Varroa jacobsoni* chez les races d'abeilles *Apis mellifera* européenne et africanisée, en climat tropical humide du Mexique. Thèse de Doctorat, Université Claude Bernard, Lyon.

Inleiding, onderzoeksdoelen en samenvatting

Inleiding

Varroamijten als parasieten van honingbijen.

Varroa destructor (Anderson & Trueman, 2000), is de belangrijkste plaag van Europese rassen van de westerse honingbij, *Apis mellifera* L., die bijenvolken verzwakt en bijenziekten overbrengt (Matheson, 1993). Gedurende de laatste decennia heeft de varroamijt zich verspreid over de wereld en is bestrijding nodig om gezonde bijenvolken te behouden.

Van origine kwam de varroamijt alleen voor in volken van de oosterse honingbij, *Apis cerana* Fabr., waarvan het verspreidingsgebied zich beperkt tot Azië. *Varroa destructor* was voorheen bekend als *V. jacobsoni* Oud. (Anderson & Trueman, 2000). Deze varroamijt werd in 1904 beschreven door Oudemans als een parasiet van de oosterse honingbij in Indonesië. Hoewel de schade die de varroamijt bij de oosterse honingbij aanricht nooit is bepaald, wordt de varroamijt niet als een probleem ervaren in volken van hun oorspronkelijke gastheer. De varroamijt ontpopte zich pas tot een serieuze plaag van de westerse honingbij, nadat imkers hun westerse honingbijen in het verspreidingsgebied van de oosterse honingbij hadden gebracht. De varroamijt bleek een schadelijke parasiet van zijn nieuwe gastheer te zijn, maar voordat men zich dat realiseerde was de varroamijt al door transport van bijen over de wereld verspreid (De Jong et al., 1982, Matheson, 1993, 1995).

De varroamijt voedt zich op volwassen bijen en broed, maar de voortplanting vindt alleen plaats in de gesloten broedcel, die voor het sluiten door de mijten wordt binnengestapt gedurende de laatste larvale stadia van de honingbij. De nakomelingen worden geproduceerd gedurende de tijd dat de bij zich ontwikkelt in de gesloten broedcel. De moedermijt en haar kroost komen tegelijk met de jonge bij uit de broedcel. Naast directe schade aan bijen door het voeden van de mijten, brengen varroamijten bijenziekten over die dan ook vaker uitbreken (Ball, 1994). De varroamijt kan volken van de westerse honingbij te gronde richten omdat geparasiteerde bijen een kortere levensverwachting hebben en vaak misvormd zijn (Beetsma et al., 1989). De bedreiging van de bijenteelt heeft geleid tot de ontwikkeling van bestrijdingsmiddelen en momenteel zijn er verschillende effectieve bestrijdingsmiddelen tegen mijten beschikbaar, die wereldwijd worden toegepast (Koeniger & Fuchs, 1989; Ritter, 1990). Het gebruik van acariciden heeft echter belangrijke nadelen. Bijenproducten zoals honing en was worden gecontamineerd met residuen van deze bestrijdingsmiddelen (De Greef, 1994), hetgeen niet strookt met de status van honing en was als natuurlijke producten. Een ander nadeel is dat varroamijten resistent tegen acariciden zijn geworden. Deze resistentie verspreidt zich wereldwijd, hetgeen toepassing van bestrijdingsmiddelen onbetrouwbaar maakt. Alternatieve bestrijdingsmethoden zijn noodzakelijk.

Op weg naar duurzame varroamijtbestrijding

In dit proefschrift presenteer ik resultaten van studies naar biotechnische methoden voor de bestrijding van varroamijten. Daarnaast presenteer ik resultaten van studies naar mogelijke selectie van minder gevoelige bijen. Het principe van biotechnische bestrijdingsmethoden, waarbij mijten in broedcellen worden gevangen en vervolgens met het broed uit het bijenvolk worden verwijderd, zogenaamde vangraatmethoden, is eenvoudig. In de praktijk kunnen deze methoden echter

gecompliceerd zijn. Het moment van vangen moet geïntegreerd moet worden met andere activiteiten van de imker, zoals zwermverhindering, om een hoge efficiëntie te behalen. Hiernaast zijn deze methoden over het algemeen arbeidsintensief. Effectieve vangraatmethoden zijn inmiddels beschikbaar, maar minder bewerkelijke methoden zijn nog steeds gewenst. Veel onderzoek is gericht op het telen van bijen die minder gevoelig zijn voor varroamijten (Woyke, 1989; Büchler, 1994; Moritz, 1994). Op dit gebied heb ik onderzocht of een verkorte ontwikkelingsduur van het bijenbroed en de aantrekkelijkheid van bijenbroed voor varroamijten geschikte kenmerken zijn voor selectie van honingbijen die minder gevoelig zijn voor varroamijten. Wanneer minder gevoelige honingbijen beschikbaar zijn, kan de hoge effectiviteit van bestrijdingsmethoden, die nu nodig is voor succesvolle bestrijding, enigszins worden losgelaten. Hierdoor liggen vereenvoudigde biotechnische bestrijdingsmethoden mogelijk in het verschiet. Het doel van mijn proefschrift is het leveren van een bijdrage aan een toekomst waarin de bijenhouderij kan bestaan zonder het gebruik van bestrijdingsmiddelen voor effectieve bestrijding van varroamijten.

Onderzoeks-doelen en -vragen

Toepassing van kennis over het instappen van mijten in broedcellen voor de ontwikkeling van biotechnische bestrijdingsmethoden en het modelleren van de mijtenpopulatie

De parasiet-gastheer interacties tussen de varroamijt en de honingbij zijn intensief bestudeerd omdat dergelijke kennis kan leiden tot nieuwe wegen van bestrijding. In eerder onderzoek heb ik samengewerkt met Beetsma en Boot (1995) om het instappen van mijten in broedcellen te bestuderen. Varroamijten kunnen leven op volwassen bijen, maar de voortplanting is beperkt tot het verblijf in de gesloten broedcel (Ifantidis & Rosenkranz, 1988). De snelheid waarmee mijten in broedcellen stappen bepaalt de verdeling van mijten over bijen en broed en daarmee de populatiedynamica van de mijt. De instapsnelheid bleek vooral af te hangen van de ratio van broedcellen die gesloten worden per bij in het volk (een overzicht over het instapgedrag van mijten wordt gepresenteerd in hoofdstuk 1). In mijn proefschrift heb ik deze kennis toegepast om bestrijdingsmethoden te ontwerpen die gebaseerd zijn op het vangen van mijten in bijenbroed. Ik heb onderzocht of het mogelijk is om de effectiviteit van deze vangraatmethoden te voorspellen met een model dat is gebaseerd op de, uit de ratio van gesloten broedcellen per bij berekende, instapsnelheid van mijten in broedcellen (hoofdstukken 2&3). Met dit model zijn ook andere ontwerpen van vangraatmethoden geëvalueerd (hoofdstuk 4). Hiernaast heb ik ook kennis over het instapgedrag toegepast om meer inzicht te verkrijgen in the populatiedynamica van de varroamijt (hoofdstuk 5).

Op weg naar minder gevoelige honingbijen

Verskil in voortplantingsgedrag van de mijten bij de beide gastheersoorten, *A. cerana* and *A. mellifera*, lijkt belangrijk te zijn voor de gevoeligheid van honingbijen voor varroamijten (Büchler, 1994; Rosenkranz & Engels, 1994). In volken van Europese *A. mellifera* kunnen de mijten zich zowel in werksterbroed als in darrenbroed voortplanten en zich daardoor snel vermeerderen. In volken van de oorspronkelijk gastheer, *A. cerana*, stappen de mijten in beide typen broedcellen, maar vindt in werksterbroed geen voortplanting plaats (Boot et al., 1997). Hierdoor kunnen in volken van *A. cerana* de mijten alleen in aantal toenemen wanneer er darren worden opgekweekt. In volken van Afrikaanse en geafrikaniseerde *A. mellifera* rassen, vinden we ook dat een hoog

percentage van mijten die werksterbroedcellen instappen zich niet voortplanten (Camazine, 1986; Ritter, 1993). Hierdoor zijn, net als *A. cerana*, Afrikaanse en geafrikaniseerde honingbijen minder gevoelig voor varroamijten. Ik onderzocht of het niet voortplanten van de varroamijten in werksterbroed komt door een eigenschap van de honingbij, bijvoorbeeld door de afwezigheid van een stimulus in de bijenlarve voor de voortplanting van de mijt, of door een eigenschap van de varroamijt, bijvoorbeeld geëvolueerd doordat de de kosten van voortplanting in werksterbroed hoger zijn dan de baten (hoofdstuk 6). Door varroamijten uit *A. mellifera* volken te introduceren in werksterbroed van *A. cerana* en vice versa, bleken twee verschillende varroamijtenpopulaties te bestaan die een verschillende voortplantingsstrategie hebben. Varroamijten uit *A. mellifera* volken planten zich voort in het werksterbroed van beide soorten honingbijen, terwijl varroamijten uit *A. cerana* volken zich alleen in darrenbroed voortplanten. Later wezen genetische studies aan dat varroamijten uit de twee populaties feitelijk twee verschillende soorten zijn (Anderson & Trueman, 2000). De varroamijten die westerse honingbijen parasiteren vinden hun oorsprong in Korea en Japan en werden abusievelijk *V. jacobsoni* genoemd en kregen recentelijk *V. destructor* als nieuwe naam (Anderson & Trueman, 2000).

Selectie van eigenschappen die het voortplantingssucces in werksterbroed reduceren leiden naar de situatie die we kennen van de oorspronkelijk gastheer-parasiet relatie waar de varroamijten zich alleen voortplanten in het darrenbroed. Ik onderzocht twee eigenschappen die een rol spelen bij het voortplantingssucces van varroamijten in werksterbroed: de duur van het gesloten broedstadium en de aantrekkelijkheid van de broedcellen. Een korte ontwikkelingsduur van het gesloten broed beperkt de ontwikkeling van de nimfen (hoofdstuk 7). Verminderde aantrekkelijkheid beperkt de instapsnelheid van de mijten en daarmee de snelheid van de voortplanting (hoofdstuk 8).

Samenvatting

Opbouw van het proefschrift

De hoofdstukken in dit proefschrift zijn artikelen waarin afzonderlijke gedeelten van het werk worden geïntroduceerd, de resultaten worden gepresenteerd en bediscussieerd. De eerste zes hoofdstukken zijn gepubliceerd in tijdschriften en de laatste twee hoofdstukken zijn voor publicatie aan een tijdschrift aangeboden.

Instappedrag van varroamijten; van de bijen in de broedcellen (hoofdstuk 1)

Varroamijten kunnen werksterbroedcellen of darrenbroedcellen instappen, wanneer werksterbijen ze tenminste dicht in de buurt van deze cellen brengen. De aantrekkelijke periode van darrenbroedcellen is twee tot drie keer langer in vergelijking met werksterbroedcellen. De aantrekkelijkheid van broedcellen hangt samen met de afstand tussen de bijenlarve en de rand van de broedcel en de leeftijd van de bijenlarve. Het moment waarop een mijt een broedcel instapt, hangt niet samen met de duur van het verblijf van de mijt op de volwassen bijen. Het gedeelte van de phoretische mijten dat broedcellen instapt, wordt bepaald door de ratio van het aantal geschikte broedcellen en het aantal bijen in het volk. De verdeling van mijten over werksterbroedcellen en darrenbroedcellen wordt vervolgens bepaald door de specifieke snelheden waarmee de mijten de beide typen broedcellen instappen. De toepassing van kennis over het instappen van varroamijten in broedcellen heeft geleid tot effectieve

biotechnische bestrijdingsmethoden en een verhoogd inzicht in de populatiedynamica van de varroamijt.

Bestrijding van de varroamijt door het vangen van mijten in werksterbroed te combineren met een mierenzuur behandeling van het gesloten broed buiten het volk: Toepassing van kennis over het instappgedrag in broed in de praktijk (hoofdstuk 2)

Biotechnische bestrijdingsmethoden van de varroamijt zijn gebaseerd op het principe dat mijten in broedcellen gevangen worden en vervolgens uit de bijenvolken verwijderd worden. Allereerst werden er methoden bestudeerd waarin werksterbroed werd gebruikt voor het vangen van de varroamijten. De gevangen mijten werden gedood door een mierenzuurbehandeling die het werksterbroed niet beschadigde. De percentages mijten die gevangen en gedood werden, bedroegen 87% en 89% in twee experimenten en kwamen overeen met voorspellingen die gebaseerd waren op kennis over het instappen van varroamijten in broedcellen. Kennis over het instappen van varroamijten in broedcellen kan dus haar waarde in de praktijk bewijzen bij het ontwerpen en verbeteren van vangraatmethoden voor de bestrijding van varroamijten.

Effectieve biotechnische bestrijding van varroamijten: Toepassing van kennis over het instappen in broedcellen om mijten te vangen in darrenbroed (hoofdstuk 3)

Het vangen van mijten in broedcellen is het meest effectief wanneer darrenbroed wordt gebruikt in volken die verder geen broedcellen bevatten. In theorie is één raat met darrenbroed genoeg om een effectieve bestrijding te behalen. Ik ontwierp en testte twee methoden waarin darrenbroed werd gebruikt om varroamijten te vangen. Om de werkdruk voor bijenhouders te beperken, werd de toepassing van de vangraten geïntegreerd met handelingen die nodig zijn voor zwermverhinderings. In de eerste methode varieerde de effectiviteit aanzienlijk, van 67% tot 96%. De effectiviteit werd bepaald door het aantal darrenbroedcellen die beschikbaar waren geweest voor het vangen van de varroamijten. De waargenomen effectiviteit in elk volk kon worden voorspeld aan de hand van de aantallen broedcellen en bijen in het volk, hetgeen de validiteit van ons theoretisch model aantoonde. In de tweede methode werd de toepassing van vangraten met darrenbroed aangepast zodat de productie van darrenbroed op de vangraten werd verbeterd, omdat het aantal beschikbare darrencellen cruciaal bleek te zijn voor de efficiëntie van het vangen. De waargenomen effectiviteit van 93% laat zien dat vangraten met darrenbroed op een effectieve manier varroamijten kunnen vangen. Dit betekent dat een niet-chemische methode voor de bestrijding van varroamijten beschikbaar is.

Modevaluatie van methoden voor de bestrijding van varroamijten met vangraten (hoofdstuk 4)

Het vangraatmodel dat werd gebruikt om de efficiëntie van het vangen van varroamijten in onze experimenten te voorspellen, werd ook toegepast om de efficiëntie te schatten en te vergelijken van verschillende vangraatmethoden zoals die beschreven zijn door diverse auteurs. De voorspellingen van het model illustreerden dat voor het effectief vangen met werksterbroed veel handelingen noodzakelijk zijn, omdat een grote hoeveelheid broed nodig is voor het vangen van een voldoende groot aantal mijten. Een extra handeling is de behandeling om de mijten te doden terwijl het werksterbroed gespaard blijft. Imkers zullen het werksterbroed namelijk willen behouden. Het model laat zien dat er voor het vangen met darrenbroed veel minder broedcellen nodig zijn voor een effectieve bestrijding. De werkdruk is daardoor lager vergeleken met het vangen van mijten

met werksterbroed. Bovendien zal het darrenbroed met mijten normaliter vernietigd worden.

Modelleren van de varroamijtenpopulatie (hoofdstuk 5)

Om de populatiedynamica van varroamijten te begrijpen heeft Fries et al. (1994) kennis over de interacties tussen varroamijten en honingbijen in een populatiemodel van de varroamijt geïntegreerd. Ik heb dit model geactualiseerd en uitgebreid door recentere gegevens te gebruiken, in het bijzonder over het instappen van varroamijten in broedcellen. Hierdoor werd het mogelijk om het instappen evenals mijten in broedcellen en het uitkomen van mijten uit broedcellen te voorspellen en hiermee de verdeling van mijten over bijen en broedcellen. Aangezien bestrijdingsmethoden vaak alleen mijten die zich op bijen dan wel mijten in broedcellen bereiken, kan het model gebruikt worden om de effectiviteit van deze bestrijdingsmethoden te evalueren en het meest optimale moment van toepassing te kiezen. De groei van de mijtenpopulatie bleek met name te variëren met de lengte van de broedperiode van de bijen, het aantal darrenbroedcellen en het voortplantingssucces in de broedcellen.

*Natuurlijke selectie van varroamijten verklaart de verschillende voortplantingsstrategieën in volken van *Apis cerana* en *Apis mellifera* (hoofdstuk 6)*

In volken van Europese *A. mellifera* komt de varroamijt zowel in werksterbroed als in darrenbroed tot voortplanting. In volken van de oorspronkelijke Aziatische gastheer, *A. cerana*, stapt de varroamijt in zowel werksterbroed als darrenbroed, maar komen zij alleen in darrenbroed tot voortplanting. Het achterwege blijven van voortplanting in werksterbroed is waarschijnlijk cruciaal voor de tolerantie van *A. cerana* voor varroamijten, omdat dit betekent dat de varroamijtenpopulatie alleen kan groeien wanneer darren worden opgekweekt. Om te onderzoeken of het achterwege blijven van voortplanting in werksterbroed van *A. cerana* veroorzaakt wordt door een eigenschap van de varroamijt of door een eigenschap van deze honingbijensoort, werden mijten van *A. mellifera* bijen geïntroduceerd in werksterbroed van *A. cerana* en vice versa. Ongeveer 80% van de varroamijten afkomstig uit *A. mellifera* volken kregen nakomelingen in werksterbroedcellen van zowel *A. mellifera* en *A. cerana*. Slechts 10% van de varroamijten afkomstig uit volken van *A. cerana* kregen nakomelingen in werksterbroedcellen van *A. cerana* en *A. mellifera*. Hieruit blijkt dat het achterwege blijven van voortplanting in werksterbroedcellen een eigenschap van de varroamijt is. Andere experimenten toonden aan dat werksters van *A. cerana* 84% van de werksterbroedcellen die kunstmatig met varroamijten uit *A. mellifera* volken waren besmet verwijderden. Het verwijderen van het broed begon 2 dagen na de kunstmatige besmetting, hetgeen suggereert dat de bijen reageerden op het gedrag van de varroamijten in de gesloten broedcellen. Omdat het verwijderen van het geïnfecteerde broed door de bijen een groot effect op de fitness van de varroamijten heeft, speelt deze eigenschap waarschijnlijk een grote rol bij de selectie voor verschillende voortplantingsstrategieën. Deze resultaten hebben een grote betekenis voor selectieprogramma's die gericht zijn op het telen van minder gevoelige honingbijen. Wanneer verschillen in mijten (wel of niet voortplanten in werksterbroed) specifiek zijn voor populaties van varroamijten, moeten we niet alleen bekijken of varroamijten zich niet voortplanten, maar zoeken naar bijenvolken waarin mijten worden geselecteerd voor het achterwege blijven van voortplanting in werksterbroedcellen. In selectieprogramma's zou de fitness van varroamijten die zich voortplanten in zowel werksterbroed als

darrenbroed vergeleken moeten worden met de fitness van varroamijten die zich alleen in darrenbroed voortplanten.

Voortplantingssucces van varroamijten in bijenbroed met verschillende ontwikkelingsduur (hoofdstuk 7)

Voortplanting van varroamijten is intensief bestudeerd en diverse aspecten van de levensgeschiedenis zoals het aantal eieren dat wordt gelegd, de momenten waarop de eieren worden gelegd en de sterfte van onvolwassen mijten, zijn goed bekend. Schattingen van het werkelijke voortplantingssucces; hoeveel varroamijten worden er levend op de volwassen bijen gevonden na het uitkomen van een broedcel, zijn nog steeds vrij theoretisch. Omdat deze parameter cruciaal is voor inzicht in de populatie groei van de varroamijten, werden verschillende methoden gebruikt om het voortplantingssucces te meten. Om inzicht te krijgen hoe ontwikkelingsduur van het gesloten broedstadium de populatiegroei van de varroamijten beïnvloedt, werden deze metingen gedaan in honingbijen met verschillende ontwikkelingsduur van het werksterbroed. In broed met een relatief korte ontwikkelingsduur was het voortplantingssucces laag. Bij een korter ontwikkelingsduur werden minder eieren gelegd en was de sterfte van de uit de broedcel komende varroamijten hoger. De resultaten laten zien dat het aantal mijten dat levend uit een werksterbroedcel met een relatief korte ontwikkelingsduur komt lager kan zijn dan het aantal varroamijten dat daar instapte. Dit resulteert in een afnemende varroamijtenpopulatie wanneer alleen werksterbroedcellen aanwezig zijn. Hiermee kan ook verklaard worden dat het achterwege blijven van voortplanting in werksterbroedcellen, zoals gevonden wordt in *A. cerana* en enkele *A. mellifera* rassen, kan evolueren wanneer deze mijten overleven om zich voort te planten in darrenbroed gedurende de volgende broedcyclus.

Aantrekkelijkheid van broedcellen van verschillende bijenrassen voor varroamijten (hoofdstuk 8)

Zoals al eerder opgemerkt is het instappen in broedcellen cruciaal voor de voortplanting van de varroamijten en zal de snelheid waarmee varroamijten broedcellen instappen de groeisnelheid van de varroamijtenpopulatie beïnvloeden. Ik onderzocht of varroamijten verschillend werden aangetrokken door broed van verschillende bijenrassen. Minder aantrekkelijk broed zal de populatiegroei van varroamijten in bijenvolken reduceren. Op zoek naar verschillen in aantrekkelijkheid van broedcellen, heb ik de aantrekkelijkheid van broedcellen van verschillende Europese bijenrassen (*A. m. carnica*, *A. m. iberica*, *A. m. macedonica*, *A. m. mellifera*) gemeten. De aantrekkelijkheid van broedcellen was groter wanneer de afstand tussen de larve en de rand van de broedcel kleiner was, maar dit was onafhankelijk van de oorsprong van het broed.

Epiloog

Op weg naar een toekomst waarin de bijenhouderij niet afhankelijk is van het gebruik van acariciden voor een effectieve bestrijding van de varroamijt

Het gebruik van bestrijdingsmiddelen stuit enerzijds op de 'natuurlijke' status van bijenprodukten, anderzijds wordt het gebruik onbetrouwbaar vanwege de verbreiding van resistentie van varroamijten voor deze bestrijdingsmiddelen. Er is daarom behoefte aan alternatieve wegen van varroamijtbestrijding. Ons onderzoek naar biotechnische

bestrijdingsmethoden en gevoeligheid van honingbijen voor varroamijten draagt bij aan een duurzame bestrijding van de varroamijt. Kennis over het instappen van mijten in broedcellen helpt de mogelijkheden en beperkingen voor de verbetering van biotechnische bestrijdingsmethoden in kaart te brengen. Met het gebruik van vangraten met darrenbroed is een effectieve biotechnische bestrijdingsmethode beschikbaar gekomen, zodat een niet chemische manier voor het beheersen van de varroamijtenpopulatie voorhanden is. Het integreren van kennis over het instappen van varroamijten in broedcellen in een populatiemodel van de varroamijt, geeft ons de mogelijkheid om meer inzicht in de populatiedynamica van de varroamijt te verkrijgen en eigenschappen van honingbijen, die via selectie de gevoeligheid van honingbijen voor varroamijten kunnen verlagen, te evalueren. Selectie voor eigenschappen van honingbijen die het voortplantingssucces in werksterbroed van *A. mellifera* verlagen, kunnen leiden tot selectie van varroamijten naar de situatie die we kennen van de oorspronkelijke gastheer-parasiet relatie waar de varroamijten zich alleen voortplanten in darrenbroed. De duur van het gesloten broedstadium lijkt een goede kandidaat te zijn, omdat selectie voor een korte ontwikkelingsduur het voortplantingssucces van de varroamijten zal beperken. Aantrekkelijkheid van broedcellen is een minder geschikte eigenschap, omdat erfelijke verschillen in aantrekkelijkheid niet werden waargenomen. Hoewel minder gevoelige honingbijen nog niet voorhanden zijn, zijn selecteerbare eigenschappen van honingbijen, die het effect van varroamijten op bijenvolken kunnen beperken, geïdentificeerd. Momenteel is de bijenhouderij niet langer afhankelijk van het gebruik van synthetische bestrijdingsmiddelen voor de bestrijding van varroamijten. Naast de toepassing van vangaatmethoden is veel onderzoek naar varroamijtbestrijding met behulp van organische zuren en essentiële oliën succesvol afgerond (Imdorf, 1999). Het verminderen van de gevoeligheid van honingbijen voor varroamijten, samen met een effectieve bestrijding door biotechnische methoden of bestrijdingsmethoden met organische zuren biedt een duidelijk perspectief voor een toekomst van de bijenhouderij waarin het gebruik van synthetische bestrijdingsmiddelen voor de bestrijding van varroamijten uitgebannen is.

Met dank aan: Madeleine Beekman, Yvonne Beekman, Willem Jan Boot en Regine van den Doel.

Literatuur

- Anderson, DL & Trueman, JWH (2000) *Varroa jacobsoni* (Acari: Varroidea) is more than one species. *Experimental and Applied Acarology* 24: 165-189.
- Ball, BV (1994) Host-Parasite-Pathogen interactions. In Matheson, A (editor) *New perspectives on Varroa*. IBRA, Cardiff, UK, pp 5-11.
- Beetsma, J, de Vries, R, Emami Yeganeh, B, Emami Tabrizi, M & Bandpay, V (1989) Effects of *Varroa jacobsoni* Oud. on colony development, workerbee weight and longevity and brood mortality. In Cavalloro, R (editor) *Present status of Varroa in Europe and progress in the Varroa mite control: proceedings of a meeting of the EC expert's group*, Udine, Italy, 28-30 November 1988, Commission of the European Communities, Luxembourg, pp 163-170.
- Boot, WJ (1995) Invasion of *Varroa* mites into honey bee brood cells. Thesis Wageningen University.
- Boot, WJ, Tan, NQ, Dien, PC, Huan, LV, Dung, NV, Long, LT, & Beetsma, J (1997). Reproductive success of *Varroa jacobsoni* in brood of its original host, *Apis cerana*, in comparison to that of its new host, *A. mellifera* (Hymenoptera: Apidae). *Bulletin of Entomological Research* 87: 119-126.

- Büchler, R (1994) *Varroa* tolerance in honey bees -occurrence, characters and breeding. *Bee World* 75: 54-70.
- Camazine, S (1986) Differential reproduction of the mite, *Varroa jacobsoni* (Mesostigmata: Varroidae), on Africanized and European honey bees (Hymenoptera: Apidae). *Annals of the Entomological Society of America* 79: 801-803.
- De Greef, M, Wael, L de & Laere, O van (1994) The determination of the fluvalinate residues in the Belgian honey and beeswax. *Apiacta* 29: 83-87.
- De Jong, D, Morse, RA & Eickwort, GC (1982) Mite pests of honey bees, *Annual Review of Entomology* 27: 229-252.
- Fries, I, Camazine, S & Sneyd, J (1994) Population dynamics of *Varroa jacobsoni*: a model and a review. *Bee World* 75: 5-28.
- Ifantidis, MD & Rosenkranz, P (1988) Reproduktion der Bienemilbe *Varroa jacobsoni* (Acarina: Varroidae). *Entomologia Generalis* 14:111-112.
- Imdorf, A, Charrière, JD & Fluri, P (1999) Alternative strategies for the control of acaricide resistant *Varroa* mites. *Proceedings of the 36th Apimondia congress*, Vancouver, Canada. pp 143.
- Koeniger, N & Fuchs, S (1988) Control of *Varroa jacobsoni*: current status and developments. In Needham, G R, et al. (editors) *Africanized honeybees and bee mites*. Ellis Horwood Limited, Chichester, pp 360-369.
- Matheson, A (1993) World bee health report. *Bee World* 74: 176-212.
- Moritz, R (1994) Selection for Varroaosis resistance in honeybees. *Parasitology Today* 10: 236-238.
- Oudemans, AC (1904) On a new genus and species of parasitic acari. *Notes from the Leyden Museum* 24: 216-222.
- Ritter, W (1990) Drug therapy development of *Varroa jacobsoni* in the federal republic of Germany. *Apiacta* 25: 102-106.
- Ritter, W (1993) New results of the development of tolerance to *Varroa jacobsoni* in bee colonies in Tunisia. In Connor, LJ et al. (editors), *Asian Apiculture*. Wicwas Press, Cheshire, CT, USA, pp. 457-459.
- Rosenkranz, P & Engels, W (1994) Infertility of *Varroa jacobsoni* females after invasion into *Apis mellifera* worker brood as a tolerance factor against varroaosis. *Apidologie* 25:402-411.
- Woyke, J (1989) Breeding of honey bees resistant to *Varroa jacobsoni*. *American Bee Journal* 129: 21-23.

List of publications

- Beekman, M., J.N.M. Calis & W.J. Boot., 2000. Parasitic honeybees get royal treatment. *Nature* 404: 723.
- Beetsma, J., W.J. Boot & J.N.M. Calis, 1993. Special techniques to make detailed observations of *Varroa* mites staying on bees and invading honey bee brood cells. In: L.J. Connor, T. Rinderer, H.A. Sylvester & S. Wongsiri (Editors), *Asian apiculture*. Wicwas Press, Cheshire CT, USA, pp. 510-520.
- Beetsma, J., W.J. Boot & J.N.M. Calis, 1999. Invasion behaviour of *Varroa jacobsoni* Oud.: from bees into brood cells. *Apidologie* 30: 125-140.
- Boot, W.J., J.N.M. Calis & J. Beetsma, 1990. Invasion of *Varroa* mites into honeybee brood cells: observation of *Varroa* mite behaviour. In: W. Ritter, O. Van Laere, F. Jacobs & L. De Wael (Editors), *Proceedings of the international symposium on recent research on bee pathology*, September 5-7, 1990, Gent, Belgium. *Apimondia*, pp. 43-44.
- Boot, W.J. & J.N.M. Calis, 1991. A method to obtain dated brood in honeybee colonies. *Bee World* 72: 19-21.
- Boot, W.J., J.N.M. Calis & J. Beetsma, 1991. Invasion of *Varroa* mites into honeybee brood cells; When do brood cells attract *Varroa* mites? *Proceedings Experimental & Applied Entomology*, N.E.V. Amsterdam 2: 154-156.
- Boot, W.J., J.N.M. Calis & J. Beetsma, 1992. Differential periods of *Varroa* mite invasion into worker and drone cells of honey bees. *Experimental & Applied Acarology* 16: 295-301.
- Boot, W.J., J.N.M. Calis & J. Beetsma, 1993. Invasion behavior of *Varroa* mites into honey bee brood cells. In: L.J. Connor, T. Rinderer, H.A. Sylvester & S. Wongsiri (Editors), *Asian apiculture*. Wicwas Press, Cheshire CT, USA, pp. 491-498.
- Boot, W.J., J.N.M. Calis & J. Beetsma, 1993. Invasion of *Varroa jacobsoni* into honey bee brood cells: a matter of chance or choice? *Journal of Apicultural Research* 32: 167-174.
- Boot, W.J., 1994. Methyl palmitate does not elicit invasion of honeybee brood cells by *Varroa* mites. *Experimental & Applied Acarology* 18: 587-592.
- Boot, W.J. & P. Rosenkranz, 1994. Discussion group on honey bee susceptibility. In: A. Matheson (Editor), *New perspectives on varroa*. IBRA, Cardiff, UK, pp. 151-152.
- Boot, W.J., J. Beetsma & J.N.M. Calis, 1994. Behaviour of *Varroa* mites invading honey bee brood cells. *Experimental & Applied Acarology* 18: 371-379.
- Boot, W.J., J.N.M. Calis & J. Beetsma, 1994. Possibilities for breeding honey bees resistant to varroa. In: A. Matheson (Editor), *New perspectives on varroa*. IBRA, Cardiff, UK, pp. 53-55.
- Boot, W.J., D.J.A. Sisselaar, J.N.M. Calis & J. Beetsma, 1994. Factors affecting invasion of *Varroa jacobsoni* (Acari: Varroidae) into honeybee, *Apis mellifera* (Hymenoptera: Apidae), brood cells. *Bulletin of Entomological Research* 84: 3-10.
- Boot, W.J., J.N.M. Calis & J. Beetsma, 1995. Does time spent on adult bees affect reproductive success of *Varroa* mites? *Entomologia Experimentalis et Applicata* 75: 1-7.
- Boot, W.J., R.G. Driessen, J.N.M. Calis & J. Beetsma, 1995. Further observations on the correlation between attractiveness of honey bee brood cells to *Varroa jacobsoni* and the distance from larva to cell rim. *Entomologia Experimentalis et Applicata* 76: 223-232.
- Boot, W.J., J. Schoenmaker, J.N.M. Calis & J. Beetsma, 1995. Invasion of *Varroa jacobsoni* into drone brood cells of the honey bee, *Apis mellifera*. *Apidologie* 26: 109-118.

- Boot, W.J., J.N.M. Calis, J. Beetsma, D.M. Hai, N.K. Lan, T.V. Toan, L.Q. Trung, N.H. Minh, 1996. The phenomenon of non-reproduction in worker cells as a *Varroa*-tolerance factor involves natural selection of the mites. *Apidologie* 27: 282-284 (abstract).
- Boot, W.J., J.N.M. Calis, J. Beetsma, D.M. Hai, N.K. Lan, T.V. Toan, L.Q. Trung, N.H. Minh, 1996. Exchange of *Varroa jacobsoni* between colonies of *Apis mellifera* and *A. cerana* shows that non-reproduction in worker cells is a trait of the mite. Proceedings XX International Congress of Entomology, August 25-31, Firenze, Italy: 437 (abstract).
- Boot, W.J., J. van der Blom & J. Beetsma, 1997. Workers of *Apis cerana* reproduce during short periods of queenlessness. *Entomologische Berichten* 57: 149-153.
- Boot, W.J., J.N.M. Calis, J. Beetsma, D.M. Hai, N.K. Lan, T.V. Toan, L.Q. Trung & N.H. Minh, 1999. Natural selection of *Varroa jacobsoni* explains the different reproductive strategies in colonies of *Apis cerana* and *Apis mellifera*. *Experimental and Applied Acarology* 23: 133-144.
- Calis, J.N.M., W.J. Boot & J. Beetsma, 1990. Transfer from cell to cell. How long do *Varroa* mites stay on adult bees? In: W. Ritter, O. Van Laere, F. Jacobs & L. De Wael (Editors), Proceedings of the international symposium on recent research on bee pathology, September 5-7, 1990, Gent, Belgium. Apimondia, pp. 45-46.
- Calis, J.N.M., W.J. Boot & D.J.A. Sisselaar, 1991. How long do *Varroa* mites stay on adult bees before invading a new worker brood cell? *Mededelingen van de Faculteit voor Landbouwwetenschappen van de Rijksuniversiteit Gent* 56/2a: 313-317.
- Calis, J.N.M., W.J. Boot & J. Beetsma, 1993. Behavior of *Varroa* mites invading honey bee brood cells of different sizes. In: L.J. Connor, T. Rinderer, H.A. Sylvester & S. Wongsiri (Editors), *Asian apiculture*. Wicwas Press, Cheshire CT, USA, pp. 499-509.
- Calis, J.N.M., W.J. Boot & J. Beetsma, 1993. A standardized test method to evaluate effects of pesticides on honeybee larvae. In: E.G. Harrison (Editor), Proceedings of the fifth international symposium on the hazards of pesticides to bees, October 26-28, 1993. Plant Protection Service, Wageningen, The Netherlands, pp. 55-60.
- Calis, J.N.M., J. Beetsma, W.J. Boot, J. van den Eijnde & A. de Ruijter, 1993. Control of the *Varroa* mite by treatment of sealed honeybee brood with formic acid. *Proceedings Experimental & Applied Entomology, N.E.V. Amsterdam* 4: 217-222.
- Calis, J.N.M., W.J. Boot & J. Beetsma, 1994. Evaluation of varroa control methods on trapping mites in honey bee brood. In: A. Matheson (Editor), *New perspectives on varroa*. IBRA, Cardiff, UK, pp. 106-108.
- Calis, J.N.M., W.J. Boot & J. Beetsma, 1996. Reproductive success of the *Varroa* mite in honeybee worker brood with differential development times. *Proceedings Experimental & Applied Entomology, N.E.V. Amsterdam* 7: 89-94.
- Calis, J.N.M., W.J. Boot, J. Beetsma, J.H.P.M. van den Eijnde, A. de Ruijter & J.J.M. van der Steen, 1996. Trapping *Varroa jacobsoni* in drone brood combs of *Apis mellifera* as a biotechnical control method. Proceedings XX International Congress of Entomology, August 25-31, Firenze, Italy, 437 (abstract)
- Calis, J.N.M., W.J. Boot, J. Beetsma, J.H.P.M. van den Eijnde, A. de Ruijter & J.J.M. van der Steen, 1996. Trapping *Varroa jacobsoni* in drone brood combs of *Apis mellifera* in broodless colonies. *Apidologie* 27: 295-296 (abstract).
- Calis, J.N.M., W.J. Boot & J. Beetsma, 1997. Attractiveness of brood cells to *Varroa jacobsoni* in different honeybee races (*Apis mellifera*). *Apidologie* 28: 181-182 (Abstract).

- Calis, J.N.M., J. Schmidt-Bailey, J. Beetsma, W.J. Boot, J.H.P.M. van den Eijnde, S. Fuchs, A. de Ruijter & J.J.M. van der Steen, 1997. Successful trapping of *Varroa jacobsoni* with drone brood in broodless *Apis mellifera* colonies. *Apiacta* 32:65-71.
- Calis, J.N.M., W.J. Boot, J. Beetsma, J.H.P.M. van den Eijnde, A. de Ruijter & J.J. M. van der Steen, 1998. Control of varroa by combining trapping in honey bee worker brood with formic acid treatment of the capped brood outside the colony: putting knowledge on brood cell invasion into practice. *Journal of Apicultural Research* 37: 205-215.
- Calis, J.N.M., W.J. Boot, J. Beetsma, J.H.P.M. van den Eijnde, A. de Ruijter & J.J.M. van der Steen, 1999. Effective biotechnical control of *Varroa*: applying knowledge on brood cell invasion to trap honey bee parasites in drone brood. *Journal of Apicultural Research* 38: 49-61.
- Calis, J.N.M., W.J. Boot & J. Beetsma, 1999. Model evaluation of methods for *Varroa jacobsoni* mite control based on trapping mites in honey bee brood. *Apidologie* 30: 197-207.
- Calis, J.N.M., I. Fries & S.C. Ryrie, 1999. Population modelling of *Varroa jacobsoni* Oud. *Apidologie* 30: 111-124.
- Calis, J.N.M., W.J. Boot, J. Beetsma, 1999. From bees into brood cells: How knowledge on invasion behaviour of *Varroa* mites is used for trap-comb based control methods and facilitates population modelling. In *Social insects at the turn of the century*, *Proceeding sof the XIII International Congress of IUSSI*. pp 91 (abstract).
- Calis, J.N.M., W.J. Boot, J. Beetsma, 1999. Variation in reproductive success of *Varroa* mites in honey bee brood. *Proceedings of the 36th Apimondia congress*, Vancouver, Canada. pp 135 (abstract).
- Fries, I & J.N.M. Calis, 1999. *Varroa jacobsonii* population growth simulations and biological variations in honey bees. In *Social insects at the turn of the century*, *Proceeding sof the XIII International Congress of IUSSI*. pp 174 (abstract).
- Rodrigues, I., J. Beetsma, W.J. Boot & J.N.M. Calis, 1996. Testing hygienic behaviour in four different honeybee strains (*Apis mellifera* L.). *Proceedings Experimental & Applied Entomology*, N.E.V. Amsterdam 7, 83-88.
- Rodrigues, I., J. Beetsma, W.J. Boot & J.N.M. Calis, 1996. Testing hygienic behaviour in four *Apis mellifera* L. strains. *Apidologie* 27: 281-282 (abstract).
- Ruijter, A. de & J.N.M. Calis, 1988. Distribution of *Varroa jacobsoni* female mites in honey bee worker brood cells of normal and manipulated depth (Acarina: Varroidae). *Entomologia Generalis* 14: 107-109.

Nawoord

Dit proefschrift geeft een overzicht van het bijenonderzoek aan de Wageningen Universiteit van de laatste jaren. Een periode van, voor de universitaire wereld niet ongewone, tijdelijke aanstellingen en altijd de voelsprietten uit naar nieuwe mogelijkheden. Terugkijkend op de jaren waarin dit onderzoek is uitgevoerd, bedenk ik me vooral dat ik het als erg plezierig heb ervaren.

In de eerste plaats ben ik mijn directe collega's Joop Beetsma en Willem Jan Boot daar erg dankbaar voor. Nadat we eerst Willem tot doctor hebben gebracht, was het mijn beurt. Joop heeft me als begeleider de ruimte gegeven om het werk te ontwerpen en uit te voeren en heeft zelf altijd actief meegedacht en meegewerkt. Als ik iemand op de gang hoor lopen met een kraakje in de schoen, ervaar ik nog vaak dat hij met ons meekijkt en ik weet zeker dat hij trots op ons zou zijn. Vanwege zijn belangrijke rol bij het onderzoek en zijn warme belangstelling voor het werk van Willem Jan en mij heb ik dit proefschrift dan ook aan hem opgedragen. Willem, collega en vriend door dik en dun, een beter werkmaatje kan ik me niet wensen. Met z'n drieën waren we een goede eenheid en hebben we vele proeven uitgevoerd en nog veel meer bedacht. Ik ben blij dat Willem en ik, met ons imkersbedrijf, Inbuzz, en onze band met het Laboratorium voor Entomologie, het bijenwerk kunnen voortzetten.

Mijn eerste promotor, Joop van Lenteren, dank ik voor zijn enthousiasme, voor de hulp bij het schrijven van het onderzoeksvorstel en de kritische kanttekeningen bij de manuscripten. Mous Sabelis, mijn tweede promotor, heeft een belangrijke rol gespeeld bij het schrijven van de manuscripten, dankzij hem heb ik telkens weer kritisch naar mijn teksten gekeken en heb ik zo precies mogelijk opgeschreven wat ik bedoelde.

Het Laboratorium voor Entomologie was en is een erg aangename werkplek, niet in de laatste plaats door alle fijne (oud)collega's en vrienden; bedankt voor een mooie tijd. Met veel plezier denk ik terug aan de proeven die we samen met Jan van den Eijnde, Aad de Ruijter, Sjef van der Steen en andere medewerkers van de proefbijenstand de 'Ambrosiushoeve' hebben gedaan. Het was erg stimulerend om met de resultaten van het fundamentele onderzoek naar het binnendringen van mijten in broedcellen, praktische bestrijdingsmethoden te ontwikkelen. Jan van Eijnde, Aad de Ruijter en Sjef van der Steen bedank ik ook voor hun bijdrage als co-auteur. Ingemar Fries wil ik bedanken voor de uitnodiging om 'zijn' populatiemodel van de varroamijt verder te ontwikkelen, samen met Stephen Ryrie.

De reis naar Vietnam was een geweldige ervaring. Het werken met de varroamijt en de oorspronkelijke gastheer, de oosterse honingbij, is erg belangrijk geweest voor de ontwikkeling van mijn ideeën over de relatie tussen deze parasiet en gastheer. Ik ben onze Vietnamese collega's zeer dankbaar voor hun uitstekende organisatie van de onderzoeksfaciliteiten, de samenwerking bij het onderzoek en hun gastvrijheid.

Mijn ouders hebben mij altijd de ruimte gegeven om me te ontwikkelen, en daar ben ik hun erg dankbaar voor. Het is jammer dat ze dit niet mee kunnen maken. Mijn familie en vrienden bedank ik dat ik op hun kon terugvallen in tijden van voor en tegenspoed.

Madeleine heeft alle stukken voorzien van kritische kanttekeningen en, zelfs nadat ze verkozen had een andere weg te bewandelen, heeft ze een belangrijke bijdrage geleverd aan de vormgeving van mijn proefschrift, waarvoor ik haar bedank. Yvonne bedank ik voor de zorg die ze altijd aan de Janneke en Willemijn heeft willen besteden. Janneke en Willemijn bedank ik voor het verduren van de vele bijensteken en Regine voor je liefde.

Curriculum vitae

Op 11 april 1961 werd ik, Johannes Nicolaas Maria Calis, in Laren geboren. In 1979 behaalde ik het VWO-diploma aan de R.K. Scholengemeenschap Laar & Berg te Laren. Daarna begon ik aan de studie Biologie aan de Universiteit van Amsterdam. In de doctoraal-fase heb ik onderzoekstages gedaan aan triveenvegetaties bij Dr L de Lange en Dr J Wiegers, wulpen in het Noord-Hollands Duinreservaat bij Dr J Mulder en Dr J Wattel, fotoperiodische tijdmeting in de sluipwesp *Pteromalus puparum* bij Dr A Veerman en de varroamijt bij Drs A de Ruijter en Dr A Veerman. Tevens heb ik een 1e-graads onderwijsbevoegdheid behaald. Tijdens de doctoraal-fase ben ik werkzaam geweest als kandidaat-assistent bij het Hugo de Vries Laboratorium (UvA). Na mijn doctoraalexamen in 1987, ben ik in dienst geweest bij de sectie Populatie Biologie (UvA; toenmalige Vakgroep Experimentele Entomologie) en heb ik gewerkt aan boomgaard-roofmijten onder begeleiding van Dr W Overmeer. In deze periode heb ik samen met Dr F Bakker Mitox opgericht; een contract-laboratorium voor onderzoek aan neven-effecten van bestrijdingmiddelen op nuttige mijten en insecten. Vanaf 1989 werkte ik tevens mee aan het promotieonderzoek van Dr W Boot aan het binnendringen van varroamijten in broedcellen van honingbijen bij het Laboratorium voor Entomologie (WU). Vanaf november 1994 tot januari 1998 werkte ik daar als onderzoeker in EU-verband aan honingbijen die minder gevoelig zijn voor varroamijten. Het onderzoek dat in dit proefschrift is beschreven, werd in de beide perioden bij het Laboratorium voor Entomologie (WU) uitgevoerd. Op 1 mei 1997, zijn Dr W Boot en ik ons eigen imkersbedrijf, Inbuzz, gestart. Hiernaast ben ik gast-medewerker bij het Laboratorium voor Entomologie (WU). Recentelijk zijn we een onderzoek naar 'sociaal parasitisme bij de Kaapse honingbij' gestart.

Het onderzoek beschreven in dit proefschrift werd uitgevoerd bij het Laboratorium voor Entomologie van de Wageningen Universiteit en financieel ondersteund door de Stichting voor de Technische Wetenschappen (STW; WGB88.1512) en de Europese Unie (AIR3-CT94-1064)